



YAMAHA

O2R

DIGITAL RECORDING CONSOLE

Version 2

OWNER'S MANUAL

E

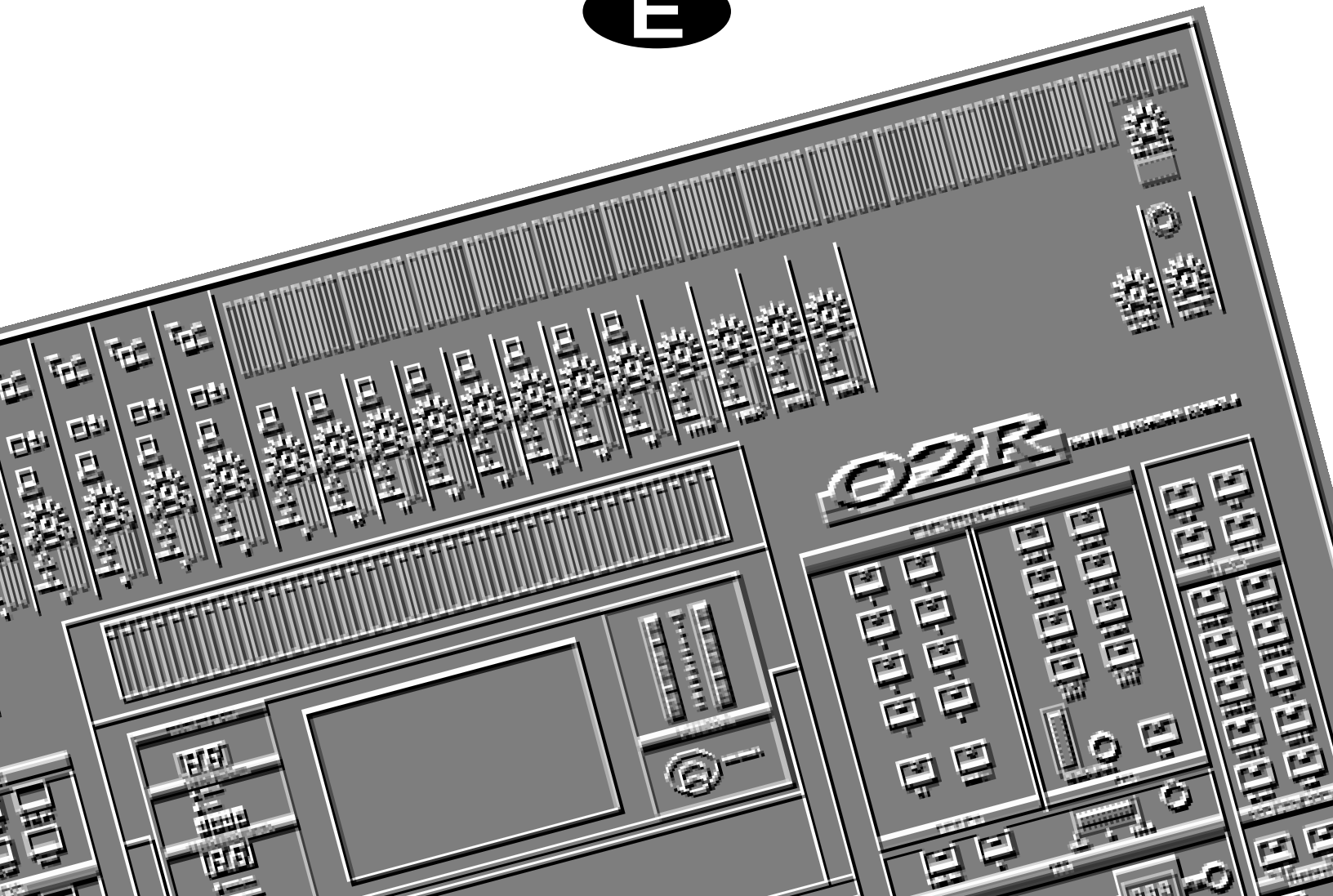

FCC INFORMATION (U.S.A.)

1. IMPORTANT NOTICE: DO NOT MODIFY THIS UNIT!

This product, when installed as indicated in the instructions contained in this manual, meets FCC requirements. Modifications not expressly approved by Yamaha may void your authority, granted by the FCC, to use the product.

2. IMPORTANT: When connecting this product to accessories and/or another product use only high quality shielded cables. Cable/s supplied with this product MUST be used. Follow all installation instructions. Failure to follow instructions could void your FCC authorization to use this product in the USA.

3. NOTE: This product has been tested and found to comply with the requirements listed in FCC Regulations, Part 15 for Class "B" digital devices. Compliance with these requirements provides a reasonable level of assurance that your use of this product in a residential environment will not result in harmful interference with other electronic devices. This equipment generates/uses radio frequencies and, if not installed and used according to the instructions found in the users manual, may cause interference harmful to the operation of other electronic devices. Compliance with FCC regulations does not guarantee that interference will not occur in all installations. If this product is found to be the source of interference, which can be determined by turning the unit "OFF" and "ON", please try to eliminate the problem by using one of the following measures:

Relocate either this product or the device that is being affected by the interference.

Utilize power outlets that are on different branch (circuit breaker or fuse) circuits or install AC line filter/s.

In the case of radio or TV interference, relocate/reorient the antenna. If the antenna lead-in is 300 ohm ribbon lead, change the lead-in to coaxial type cable.

If these corrective measures do not produce satisfactory results, please contact the local retailer authorized to distribute this type of product. If you can not locate the appropriate retailer, please contact Yamaha Corporation of America, Electronic Service Division, 6600 Orangethorpe Ave, Buena Park, CA 90620

* This applies only to products distributed by YAMAHA CORPORATION OF AMERICA.

IMPORTANT NOTICE FOR THE UNITED KINGDOM

Connecting the Plug and Cord

WARNING: THIS APPARATUS MUST BE EARTHED

IMPORTANT: The wires in this mains lead are coloured in accordance with the following code:

GREEN-AND-YELLOW : EARTH
BLUE : NEUTRAL
BROWN : LIVE

As the colours of the wires in the mains lead of this apparatus may not correspond with the coloured markings identifying the terminals in your plug, proceed as follows:

The wire which is coloured GREEN and YELLOW must be connected to the terminal in the plug which is marked by the letter E or by the safety earth symbol or coloured GREEN and YELLOW.

The wire which is coloured BLUE must be connected to the terminal which is marked with the letter N or coloured BLACK.

The wire which is coloured BROWN must be connected to the terminal which is marked with the letter L or coloured RED.

* This applies only to products distributed by YAMAHA KEMBLE MUSIC (U.K.) LTD.

ADVARSEL!

Lithiumbatteri—Eksplodingsfare ved fejlagtig håndtering. Udskiftning må kun ske med batteri af samme fabrikat og type. Levér det brugte batteri tilbage til leverandoren.

VARNING

Explosionsfara vid felaktigt batteribyte. Använd samma batterityp eller en ekvivalent typ som rekommenderas av apparattillverkaren. Kassera använt batteri enligt fabrikantens instruktion.

VAROITUS

Paristo voi räjähtää, jos se on virheellisesti asennettu. Vaihda paristo ainoastaan laitevalmistajan suosittelemaan tyyppiin. Hävitä käytetty paristo valmistajan ohjeiden mukaisesti.

NEDERLAND

- Dit apparaat bevat een lithium batterij voor geheugen back-up.
- Raadpleeg uw leverancier over de verwijdering van de batterij op het moment dat u het apparaat aan het einde van de levensduur afdankt of de volgende Yamaha Service Afdeling:
Yamaha Music Nederland Service Afdeling
Kanaalweg 18-G, 3526 KL UTRECHT
Tel. 030-2828425
- Gooi de batterij niet weg, maar lever hem in als KCA.

THE NETHERLANDS

- This apparatus contains a lithium battery for memory back-up.
- For the removal of the battery at the moment of the disposal at the end of the service life please consult your retailer or Yamaha Service Center as follows:
Yamaha Music Nederland Service Center
Address: Kanaalweg 18-G, 3526 KL
UTRECHT
Tel: 030-2828425
- Do not throw away the battery. Instead, hand it in as small chemical waste.

Important Information

Please read the following before operating your 02R Digital Recording Console.

Precautions

Installing the 02R

- The unit should be connected only to an AC receptacle of the type described in the owner's manual or as marked on the unit.
- Be careful to prevent the 02R from getting wet; do not allow water to enter the 02R, especially when raining or snowing, or near a body of a water. Otherwise, fire or electrical shock may result.
- Do not block the ventilation holes on the 02R. The 02R has ventilation holes on the top, rear, front and bottom panel to prevent the inside temperature from rising. If the ventilation holes are blocked, the heat will remain inside, resulting in fire. In particular, avoid the following situations:
 - Do not orient the 02R upside down, face down, or sideways.
 - Do not place the 02R in a narrow, non-ventilated space, such as in a bookcase or closet. Use a dedicated rack.
- Do not place a table cloth on top of the 02R; do not place the 02R on a carpet or mattress.
- Do not place heavy objects on the power cord. If the cord is damaged, fire or electrical shock may result. In particular, it is possible that one might accidentally place a heavy object on the carpet that covers the cord, or place the 02R on top of a power cord; avoid these situations.
- To allow for the efficient release of heat, maintain a gap of 10 cm or more between the rear of the 02R and the wall. Locate the 02R away from other equipment. If the release of heat is insufficient, the heat will remain inside the device, and result in a fire.
- Do not install the 02R in a place where it may be exposed to oil, smoke, or steam (for example, near a cooking table or humidifier). Otherwise, fire or electrical shock may result.
- Do not place the 02R on an unstable surface, such as an unstable bench or slanted surface. Otherwise, the equipment may fall or drop, resulting in injury.
- Do not place the power cord near a heating device. Otherwise, the cord sheath may melt, resulting in fire or electrical shock.
- Do not locate the 02R in a place subject to excessive heat, such as inside a car with all the windows closed, or in direct sunlight. Otherwise, fire may result.
- Do not place the 02R in a place subject to excessive humidity or dust. Otherwise, fire or electrical shock may result.
- Do not handle the power plug with wet hands. Otherwise, you may receive an electrical shock.

- When you remove the power plug, be sure to hold the plug. Never pull on the cord. Otherwise, the power cord will become damaged, resulting in fire or electrical shock.
- When relocating the 02R, since the 02R is heavy, make sure that two or more people carry it.
- When you are moving the 02R to another location, first turn off the power switch, remove the power plug from the AC outlet, and remove all cables connected to external devices. Otherwise, the cables may become damaged, resulting in fire or electrical shock.
- The 02R offers superb sonic quality. To ensure the best possible results, you should use the best quality connecting cables that you can afford. Regular maintenance involves keeping all connections clean using a quality contact cleaner.
- Do not place a container with liquid or small metal objects on top of this unit. Liquid or metal objects inside this unit are a fire and electrical shock hazard.

Using the 02R

Do not touch the 02R under the following circumstances:

- If you hear thunder, turn off the power switch and remove the power plug from the AC outlet as soon as possible.
If you fear a lightning hit, and the 02R has been connected to an AC outlet, do not touch the power plug. Otherwise, you may receive an electrical shock.
- Do not attempt to modify this equipment. Otherwise, fire or electrical shock may result.
- Do not remove the case of the 02R. Otherwise, electrical shock may result.
If you think the 02R needs to be checked for maintenance or repair, consult your dealer.
- Do not place a container of water, or any small metal object on top of the 02R. If water is spilled or if the metal object falls inside, fire or electrical shock may result. This applies to vases, potted plants, glasses, cosmetic bottles, medicine, etc.
- Do not damage, process, bend, twist, stretch, or heat the power cord. Otherwise, the cord may be damaged, resulting in fire or electrical shock.
- When you are connecting audio devices or speakers to the 02R, make sure that first you turn off the power to all devices to be connected. Refer to the user's guide for each device, and use the specified cable for connection.
- Set the volume level on all the devices to the minimum before turning on the power. Otherwise, an extremely loud noise could damage your hearing.
- If you plan not to use the 02R for a long period of time (such as when you are on vacation), remove the power plug from the AC outlet. Otherwise, a fire could possibly result.

If an abnormality occurs while operating the 02, remove the plug from the AC outlet

- If you notice any abnormality—such as smoke, odor, noise, etc—turn off the power to the 02R immediately, and remove the power plug from the AC outlet. Confirm that the abnormality is no longer present, then consult your dealer for repair. If you continue using the 02R under abnormal conditions, fire or electrical shock may result.
- If a foreign object or water enters inside the equipment, turn off the power to the 02R immediately, remove the power plug from the AC outlet, and consult your dealer for repair. If you continue using the 02R under this condition, fire or electrical shock may result.
- If the power cord is damaged (for example, the it is cut or if the core wire is exposed), ask your dealer for a replacement. If you continue using the 02R under this condition, fire or electrical shock may result.
- If the 02R is dropped, or the cabinet is damaged, turn off the power switch, remove the power plug from the AC outlet, and consult your dealer. If you continue using the 02R under this condition, fire or electrical shock may result.

Maintenance

- Before cleaning the 02R, remove the power plug from the AC outlet for safety. Otherwise, an electrical shock may result.
- An authorized dealer should clean the internal parts of the 02R on a regular basis. If you do not clean them for a long period of time, allowing dust to accumulate inside the equipment, fire or malfunction may result.

Consult your dealer about cleaning and its cost.

The optimum frequency for cleaning is once a year. It is especially effective to clean before a rainy or humid season starts.

- The performance of contact parts—such as switches, the volume encoder, and connectors—deteriorates with use. The degree of deterioration may differ depending on the environment, but the deterioration itself cannot be avoided. To replace the contact parts, consult your dealer.
- Do not apply oil, grease, or a contact repair agent to the faders. Otherwise, the conductivity of the electrical contact point may be affected.

If you think the faders' movement is awkward, refer to “User’s Guide” on page 215 for calibration information.

Data backup

Data stored inside the equipment may be destroyed by malfunction or incorrect operation of the equipment. Be sure to save important data to an external MIDI device for backup.

Influences on other electrical devices

This equipment uses many digital circuits, which may cause noise to occur on nearby radio or TV. In this case, relocate the 02R away from those devices.

02R Exclusion of Certain Responsibility

Manufacturer, importer, or dealer shall not be liable for any incidental damages including injury to the person, and/or any other damages caused by improper use or operation of the 02R. Please, read the instructions in this manual.

Copyright

© 1997 Yamaha Corporation. All rights reserved.

No part of the 02R software or its user manuals may be reproduced or distributed in any form or by any means without the prior written authorization of Yamaha Corporation.

Trademarks

ADAT MultiChannel Optical Digital Interface is a trademark and ADAT and Alesis are registered trademarks of Alesis Corporation. Dolby, AC-3, and Pro-Logic are trademarks of Dolby Laboratories Licensing Corporation. Copyright 1992 Dolby Laboratories, Inc. All rights reserved. Pro Tools is a registered trademark of Digidesign or Avid Technology, Inc. Tascam Digital Interface is a trademark and Tascam and TEAC are registered trademarks of TEAC Corporation. All other trademarks and registered trademarks are the property of their respective holders.

Package Contents

Your 02R package contains the following items. If you do not have them all, please contact your Yamaha dealer.

- 02R Console
- This Owner's Manual (contains Getting Started Guide and User's Guide)

Important Note About Project Manager

Version 1 of Project Manager is not compatible with the 02R Version 2 and may cause data loss. To obtain Version 2 of Project Manager, contact Zeep in Canada at <<http://www.zeep.com/>> or tel: 514-272-2224 or fax: 514-272-2888. Alternatively, contact your Yamaha dealer for additional information about archiving 02R Version 2 data.

O2R

DIGITAL RECORDING CONSOLE

Version 2

Getting Started Guide

Contents

1	Introduction to the 02R.	1
	02R.	2
	User Guides	3
	Installation	3
	Top and Rear Panels	4
	Features.	5
	Key Features.	7
2	Getting Started	13
	Basic Assumptions	14
	Making the Connections	14
	Basic Setup	15
	Power ON/OFF.	16
	Setting the Synchronization.	16
3	Introductory Recording Tutorial	19
	Setting the Input Level.	20
	Applying EQ	24
	Using the EQ Library	30
	Panning.	38
4	Secondary Recording Tutorial.	41
	Aux Sends.	42
	Setting the Aux Send Level	43
	Creating a Monitor Mix	45
	Applying Effects	46
	Recalling and Editing Effects.	49
	Patching in a Dynamics Processor	54
	Using the Dynamics Library	57
	Scene Memories.	62

5	Mixing and Automix	67
	What is 02R Automix?	68
	Real-time Automix	69
	Editing Automix Events	76
	Off-line Automix Editing	81
	Using the Automix Library	87
	Index	90

1

Introduction to the 02R

In this chapter...

02R.....	2
User Guides	3
Installation	3
Top and Rear Panels	4
Features.....	5
Key Features.....	7

02R

From the company that pioneered digital mixing consoles and leads the industry with its acclaimed DSP technology comes the 02R Digital mixing Console—the most advanced digital mixing console in the world. All of Yamaha’s experience and innovation has been applied to the 02R, to create a perfect mixer for use with the current generation of modular digital multitrack tape and disk recorders.

Inputs and Outputs – I/O Cards and Digital Cascade

With the 02R you can record and mix directly to your modular digital multitrack recorder without ever leaving the sonic purity of the digital domain. It is a 40 input channel mixer, each with full dynamic processing and 4-band parametric EQ, plus two stereo internal effects returns. It comes with 24 analog inputs, featuring 20-bit 64-times oversampling analog-to-digital conversion. By adding one of the optional digital I/O cards, you can also have 8 channels of direct digital input. Depending on configuration, up to four cards can be inserted into the 02R. The cards allow you to select from any of the currently used formats (ADAT®, TDIF™, Yamaha, or AES/EBU). The optional cards allow you to route up to 16 outputs directly to your modular digital multitrack recorder. In addition, you can insert a Digital Cascade card into one of the I/O slots, allowing you to connect multiple 02Rs together to create a larger digital mixing system.

Dynamic Automix with Total and Instant Recall

The 02R is a fully dynamic automated mixing console—all referenced to timecode. Its onboard automix system memorizes not just the faders, but a myriad of parameters. Switch individual channels on or off, adjust the EQ or the pan position, change the auxiliary send, and recall any scene memory—automatically. There are 96 internal scene memories which can store every digital mix parameter in a “snapshot” providing instant recall and reset.

Crystal Clarity and Unsurpassed Audio Quality

The 02R features Yamaha’s latest generation 32-bit proprietary audio DSP. All of your mix data is processed internally with 32-bit precision. Using the power of the latest generation effects processor chip, it also has a startling range of effects available: shimmering reverbs, clean, precise delays, flanging and chorus, and other effects are built into this mixer. It also features dynamics processors on all the inputs, allowing you to compress, limit, or gate the signals, giving you unparalleled sonic quality and flexibility. The 02R samples audio at 44.1 kHz or 48 kHz using its internal clock, and can sample at any frequency from 28 kHz to 53 kHz when an external word clock is applied.

RISC Technology

To provide powerful system control and full dynamic automix, the 02R is driven by a RISC technology CPU. With all this power and sonic quality, the 02R will become the heart of your digital recording studio.

User Guides

The 02R is supplied with an *Owner's Manual* that consists of two guides—a *Getting Started Guide* and a *User's Guide*. You should keep this manual handy for future reference.

Getting Started Guide

The *Getting Started Guide* contains a simple description and a couple of tutorials about digital recording with the 02R to get you started. It also has a tutorial on the automix system.

User's Guide

The *User's Guide* explains each 02R function in full detail. Use its table of contents to search for general topics and the index to search for specifics. A glossary of related terms is also provided.

Where to Start

If you are unfamiliar with the 02R, you should start with the *Getting Started Guide*. Read through the section and follow the steps outlined in the tutorials. Refer to the *User's Guide* when you are more familiar with the 02R and just need the details of how a particular function works. You may also want to refer to the *User's Guide* for more detailed information while using the *Getting Started Guide*.

Automix System

Regardless of your level of experience, you should read through the section "Mixing and Automix" on page 67 of the *Getting Started Guide*. The automix system built into the 02R is unique to this product. Even experienced recording engineers will want to refer to this section to discover how to record and playback entire mixing sessions. You should also refer to the section entitled "Automix" on page 137 of the *User's Guide*.

Installation

You should locate the 02R on a stable surface. It should be sited so that the display can be easily read from a comfortable position. Leave plenty of access space at the back of the 02R to make the required connections to the other equipment in your digital recording studio.

Top and Rear Panels

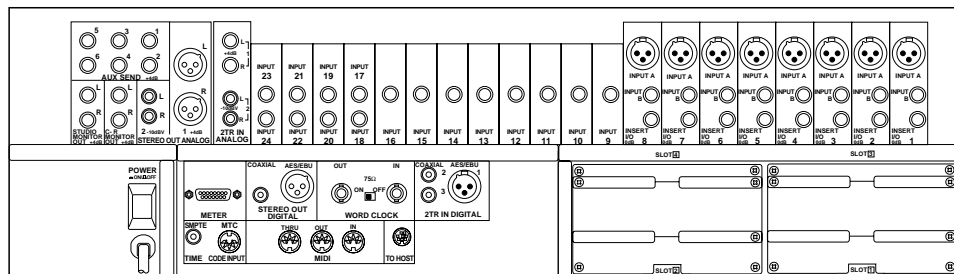
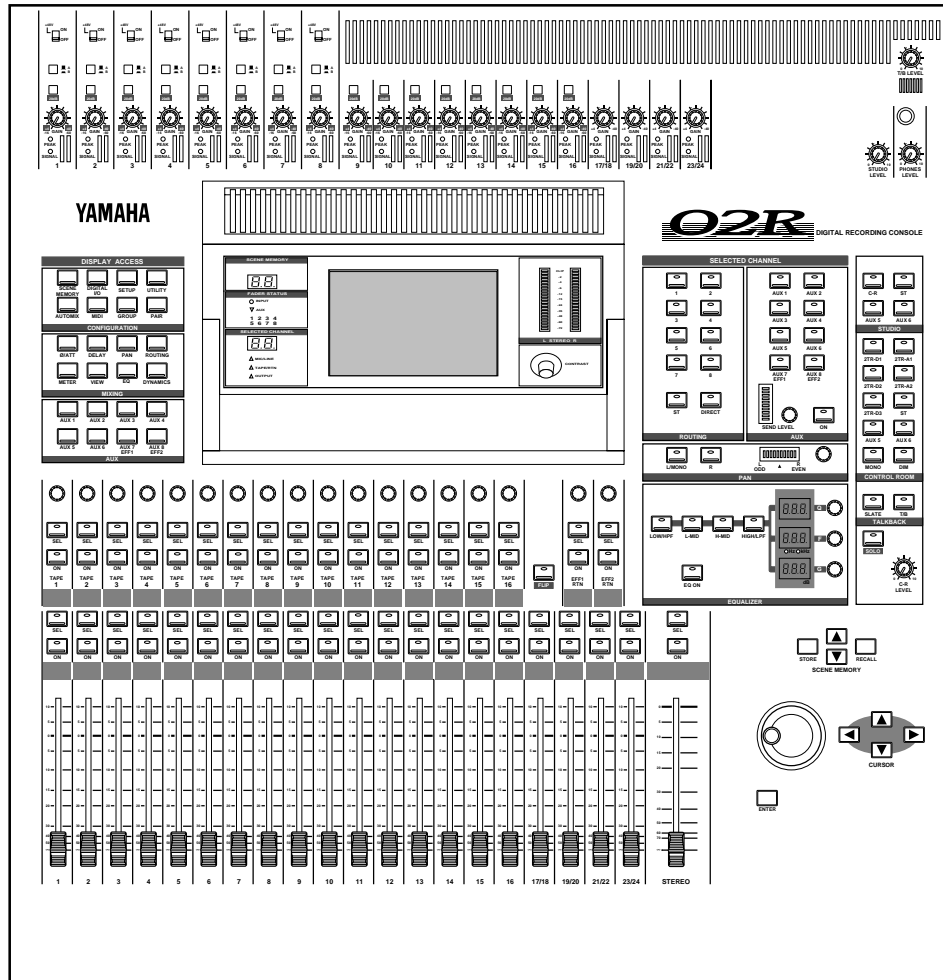

Features

Sonic Specifications

- Linear 20-bit 64-times oversampling A/D convertors
- Linear 20-bit 8-times oversampling D/A convertors
- 105 dB dynamic range (typical)
- 32-bit precision internal processing with a dynamic range of over 190 dB using Yamaha's 32-bit proprietary audio DSP

General Features

- 40 input channel mixer, with full dynamic processing and 4-band parametric equalization
- Dynamic automix—all referenced to timecode
- 96 internal scene memories for storing all digital mixer settings
- 4-band Parametric EQ with sweepable center-frequency from 20 Hz to 20kHz and adjustable bandwidth (Q)
- Extensive EQ library
- Comprehensive dynamics processors on each input channel, tape return, and buss and stereo output:
 - Compressor
 - Expander
 - Gate/Ducking
 - Soft and Hard Compander
- Dynamics library
- Fully programmable channel settings: phase and attenuation, delay, pan, routing, meters, EQ, and dynamics
- Channel library
- Two internal stereo effects using proprietary processor chip
- Effects library
- 8 output busses, 8 auxiliary send busses, and main stereo mix buss
- 24 balanced analog inputs (8 channels with either XLR-type or phone connectors)
- Continuously variable gain control
- 20 dB input pad
- 8 XLR-type inputs with 48V phantom power for condenser microphones
- 8 analog insert input/output connections
- 2 analog 2TR IN inputs

- 2 analog stereo outputs
- 6 analog auxiliary send outputs
- Stereo studio and control room outputs
- 3 digital 2TR IN inputs
- 2 digital stereo outputs
- Industry standard AES/EBU or IEC958 Part2 (Consumer) digital inputs and outputs
- 100 mm motorized faders
- Fader and mute groups for single fader or button control over several faders or channel ON buttons
- Adjacent channel pair function for stereo operation on inputs, tape returns, and auxiliary channels
- Dedicated buttons and controls of the Selected Channel module
- Large 320 × 240 pixel, FL-backlit, user-friendly graphical display
- RISC technology CPU
- SMPTE and MTC synchronization plus full MIDI implementation

Options

- Digital I/O cards:
 - ADAT (CD8-AT)
 - TASCAM (CD8-TDII)
 - Yamaha (CD8-Y)
 - AES/EBU double slot card (CD8-AE)
 - AES/EBU single slot card (CD8-AE-S)
 - Cascade Kit (CD8-CS)
- Analog I/O cards
 - Analog I/O double slot card (CD8-AD)
 - Analog input single slot card (CD8-AD-S)
- Automix 1 MB memory expansion (ME4M)
- Meter bridge (MB02)
- Wooden side panels (W02SP)

Key Features

This section looks at some of the key features of the 02R, what they mean to you, and some hints about how you can use them.

Dynamic Automix

One of the most demanding jobs of the recording engineer is taking all the raw material produced during a multitrack recording session and mixing it all together into an artistically satisfying master recording. The ability to setup portions of the mix and then have them playback automatically as you work on other portions is probably the most important feature of the 02R.

It has an on-board automix system that memorizes fader positions, switches individual channels on or off, adjusts the EQ or pan positions, and changes the auxiliary sends—all referenced to timecode. It can also record and execute scene memory changes, also referenced to timecode. This allows you to perform an entire mixing session, and then edit individual channel settings until you have achieved the perfect mix.

The 02R allows you to record a mixdown in real-time and then edit the results, either in real-time or by using one of the event editors. You can select single parameters of the mixer to edit—for example, just enable the faders for one pass as you create your mixdown.

Scene Memories

The 02R has 96 internal scene memories each of which is a snapshot of all the digital settings of the mixer (a mix scene). Each can be named for easy identification. They can be stored and later recalled instantly.

If you work on several projects at one time, you can store the current mixer settings in a scene memory so when you return to that project, you can start immediately from where you left off. When you are working on a mixdown, the ability to recall mixer scenes can speed the process and allows for accurate repetition of the various parts of the mix. When you use the 02R for sound reinforcement applications, the ability to recall mix scenes can make light work of night-after-night sound checks.

Storing the mixer settings to a scene memory is a simple matter of pressing the [STORE] button and confirming the request.

Note: *You can customize your 02R to perform the storage operation without confirmation. See “Preferences” on page 198 of the User’s Guide for more details.*

Recalling the scene is even easier—just press the [RECALL] button. You should be careful that your scene memories flow into each other smoothly. The instant recall means that you can have very abrupt level changes or the unexpected intrusion of a very loud channel.

Note: *The 02R allows you to have programmable fades between scene memories. The only thing you need to watch is the sudden sound of a channel being switched on. Even then, if the original channel level was set to $-\infty$ dB, you should have no problems. See “Fade Time” on page 136 of the User’s Guide.*

Large Graphical Display

The heart of the 02R user interface is the large graphical display located in the center of the console. Using the Display Access controls, you can gain immediate access to the features of the mixer—clearly displayed on the 320 × 240 pixel, FL-backlit, user-friendly graphical display. Virtual control modules are shown on the display, allowing you to adjust almost any digital parameter anywhere in the system.

As well as displaying parameter values numerically, faders, rotary controls, and push buttons are represented graphically, so you can actually see button status, pan positions, and fader levels.

In addition the EQ curves are displayed graphically as are the dynamics processor parameters.

User Interface

The 02R user interface is powerful but very intuitive. There are two main methods of working with the 02R:

- Use the DISPLAY ACCESS controls to modify one parameter at a time across the entire recording console.
- Use the SELECTED CHANNEL controls to modify all of the parameters of the currently selected channel.

The DISPLAY ACCESS controls consist of a block of 24 function buttons divided into three groups—CONFIGURATION, MIXING, and AUX—plus the large backlit graphical display, four cursor buttons, a detented encoder wheel, and the [ENTER] button. There is also a related block of four SCENE MEMORY buttons—to increment, decrement, store, and recall the scene memories.

The SELECTED CHANNEL controls consist of four main blocks of controls—each block was designed to be as familiar as the equivalent controls on a regular analog mixer, but with the power of digital precision and instant recall. The ROUTING block selects the bus onto which to route the current channel signal. The AUX block selects the auxiliary buss to send the channel signal to and sets the send level. The PAN block sets the pan position of the channel signal. The EQ block sets the EQ curve for the

current channel. You can customize your 02R to automatically select the corresponding display pages when you adjust a control in these blocks.

Motorized Faders

In addition to the DISPLAY ACCESS and SELECTED CHANNEL controls, each input channel and the stereo master channel utilizes a 100 mm motorized fader. When a scene memory is recalled, the faders position themselves automatically to the levels stored. Fader movements are replayed automatically in synchronization with timecode automix during playback.

The faders allow you to quickly and accurately set the levels for the selected channels. By pressing the [FLIP] button, you can transfer fader control over your tape returns as well. Faders can be grouped into one of four fader groups for control of multiple faders from a single control. (There are also four mute groups which allow you to toggle a group of channels on or off.) You can also control two adjacent channels in stereo with the pair operation using only one fader.

Internal Stereo Effects

The 02R features eight aux sends, two of which are routed to the internal multi-effects stereo processors: Effect 1 and Effect 2. Using the power of Yamaha's proprietary effects processor chip, the 02R has a startling range of special effects available to apply to your mix. Shimmering reverbs, clean and precise delays, flanging and chorus, and a myriad of other effects are available built right into this mixer. The effects are processed entirely within the digital domain, ensuring the signal quality is the finest that a digital system can provide.

External effects processors can be patched into the system using the 02R's analog AUX send outputs, which feature 18-bit linear, 8-times oversampling D/A converters.

Effects can be applied to input channels or the tape return channels, and the auxiliary sends can be configured pre-fader or post-fader. There are 40 preset effects programs and 88 user effects programs for you to store your own settings.

Dynamics Processors

Dynamics processors are generally used to correct or control signal levels. However, you can also use them creatively to shape the volume envelope of a sound. The 02R features comprehensive dynamics processors for all the input, return, bus, and stereo output channels—a total of 50 processors. These processors allow you to compress, expand, limit, gate, or duck the signals passing through the mixer, giving you unparalleled sonic quality and flexibility.

Similar to the internal stereo effects, the dynamics processors are patched directly into the signal path while the audio data remains in the digital

domain. The dynamics program settings are stored in the dynamics library. There are 40 preset programs for you to recall and 88 user programs for you to store your own dynamics programs

Parametric EQ with Library

The 02R contains a high-performance four-band, fully parametric EQ. Each input channel, tape and effect return, and the stereo output channel features an EQ. You can tailor the EQ curve with a high degree of precision, covering the entire dynamic spectrum from 21 Hz to 20.1 kHz. Select the center-frequency (F) and adjust the bandwidth (Q) and the gain (G) until you have achieved the perfect sound.

EQ settings can be stored and recalled using scene memories, and can be adjusted in real-time with the dynamic automix system. The 02R also has an extensive EQ library which allows you to store frequently used EQ settings for instant recall. An EQ program stored in the EQ library is a good starting point and reference when making adjustments to the EQ.

Digital Benefits

You're probably already familiar with the many benefits of digital audio, but what exactly are the benefits for digital audio mixing?

An audio mixer has the job of combining audio signals from various sources, at differing levels and impedances, usually into a stereo signal. It must do this without introducing any new distortions and noise. Most analog mixers do a pretty good job, but even with the best designs, nonlinear effects caused by circuit components are unavoidable.

In the digital realm, audio mixing consists of adding and multiplying the binary numbers that represent audio signals. The 02R uses a 32-bit DSP (Digital Signal Processor) chip for these calculations, ensuring a very high degree of precision. Once past the analog-to-digital conversion, audio signals are essentially immune from standard signal degradation. With the 02R, noise, distortion, and crosstalk are virtually eliminated. You'll hear a new clarity in your mixes.

Once in the digital realm, there's little point converting back to analog. The 02R features stereo digital outputs for direct mixdown to DAT and other digital recorders. It uses the industry standards AES/EBU or IEC958 Part 2 (Consumer) for its digital inputs and outputs. With one of the optional digital I/O cards installed in your 02R, you can record direct-to-digital to your modular digital multitrack recorder.

02R Sonic Performance

The 02R uses linear 20-bit 64-times oversampling analog-to-digital converters to provide a typical dynamic range of 105 dB. This means that an audio program's dynamic range, from low to high levels, is processed intact. The 02R samples audio at 44.1 kHz or 48 kHz. It provides a full spectrum frequency response from 20 Hz to 20 kHz, +1, -3 dB.

For digital-to-analog conversion, the 02R features 20-bit 8-times oversampling for its main stereo outputs, including the control room monitor outputs, and 18-bit 8-times oversampling for the studio and aux send outputs. Oversampling and bitstream techniques effectively increase the internal sampling rate, so side effects caused by steep low-pass filters, which are used to filter out undesirable sampling frequency components during conversion, are virtually eliminated. Consequently, audio signal integrity is maintained from input through to output.

2

Getting Started

In this chapter...

Basic Assumptions	14
Making the Connections	14
Basic Setup	15
Power ON/OFF	16
Setting the Synchronization	16
Recall Scene Memory 0	17

Basic Assumptions

The 02R was designed to be the perfect digital mixing console for a studio using the current generation of modular digital multitrack tape and disk recorders. Although the 02R can also be used as a sound-reinforcement mixer, the typical user will own a project recording or post-production studio with some form of multitrack recorder. Therefore, your 02R will probably be equipped with one or more of the optional input/output cards. For the purposes of these tutorials, it does not matter if you are working with an analog or digital multitrack.

What You Will Need

To perform the following tutorials, you will need:

- The 02R.
- A sound source: CD player, drum machine, synthesizer/sequencer with demo song.
- Amplifiers and speakers, or headphones.
- A multitrack recorder and a stereo master recorder.
- Audio connecting cables.

Making the Connections

WARNING! *Before making any connections, make sure that all your equipment is turned OFF.*

1. Connect your sound source to input channel 1.

If you are using a stereo sound source, connect it to input channel 2 as well. A stereo source is not essential, and for most of the tutorials it will probably be easier to work with just one channel. If your sound source has XLR-type connectors, connect it to the XLR-type connectors on the 02R. Otherwise, use the phone jacks and select INPUT B with the [A/B] switch.

2. Connect the C-R MONITOR OUT connectors to the inputs on your power amplifier.

If you are using headphones, connect them to the PHONES jack.

3. Connect your multitrack recorder to the appropriate optional input/output card.

You can also connect your stereo master recorder to either the digital or analog STEREO OUT connectors.

4. Plug the 02R into a suitable AC receptacle.

WARNING! *The 02R should be connected only to an AC receptacle of the voltage type marked on its rear panel.*

Basic Setup

The following illustration shows how to set up a minimal system that will allow you to perform the following tutorials.

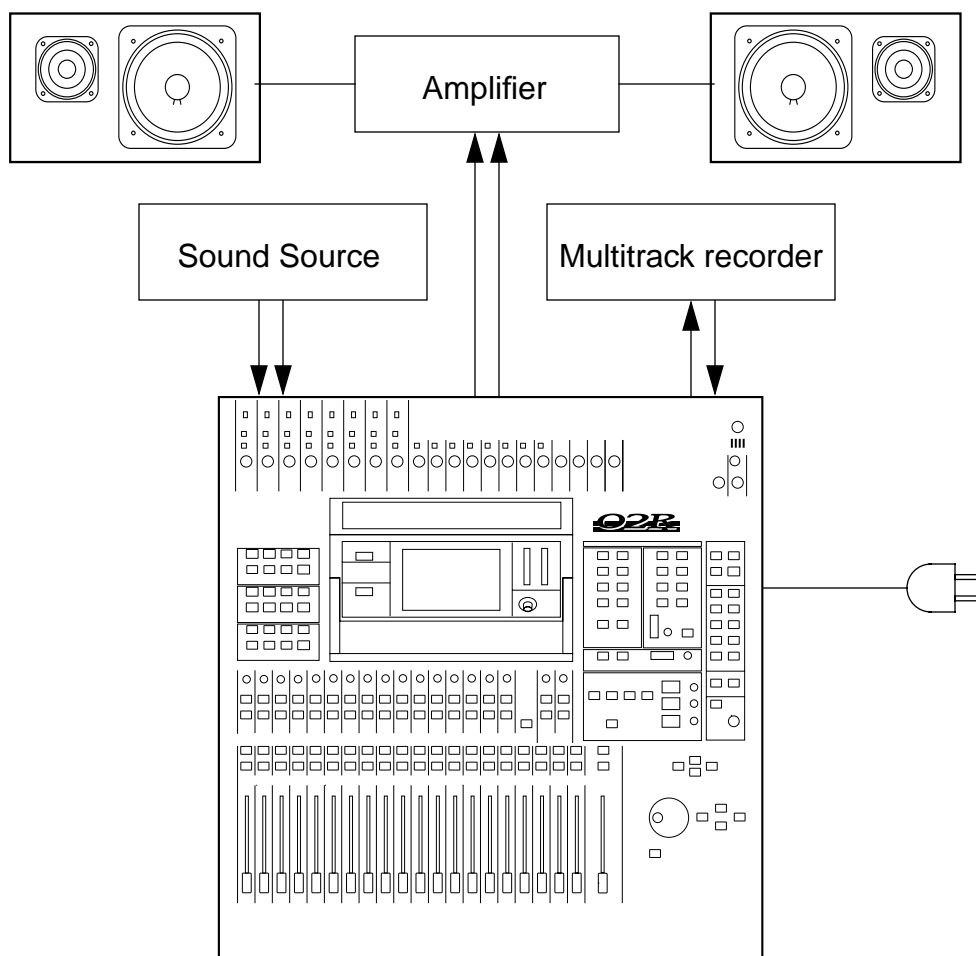

Power ON/OFF

This section explains how to power the 02R on and off.

Power ON

It is always important to observe the correct order for powering up equipment in a studio. Always start with the multitrack and mastering recorders and the signal processors, then the 02R, and finally the monitoring amplifiers and other downstream gear.

POWER
ON/OFF

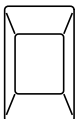

1. **Turn ON the power to the 02R by pressing the POWER switch on the rear panel.**

The 02R start-up screen appears for a few seconds, the faders return to their previous positions, then the page that was used when the 02R was last powered off appears.

Power OFF

It is always important to observe the correct order for powering off equipment in a studio. Always start with the monitoring amplifiers and other downstream gear, then the 02R, and finally the multitrack and mastering recorders and the signal processors.

1. **Turn OFF the power to the 02R by pressing the POWER switch on the rear panel.**

All mix settings, mix scenes, and other data are stored when the 02R is powered off.

Setting the Synchronization

Before you use the 02R with a modular digital multitrack recorder or DAT master recorder, be sure to correctly set the synchronization. The 02R must be slaved to an external wordclock in order to process the input digital signals without drop-out or distortion. Refer to the section “Word Clock Select” on page 188 of the *User’s Guide*.

Look in the chapter “Installing Options” on page 217 of the *User’s Guide*. There is a section for each of the optional digital I/O cards that the 02R supports. Refer to the appropriate section for the card installed in your 02R.

Recall Scene Memory 0

Before you start the tutorials, you should set the 02R to its initial mixer settings.

1. Use the SCENE MEMORY increment or decrement buttons to select scene memory 0 “0 Initial Data”.
2. Press the (RECALL) button.

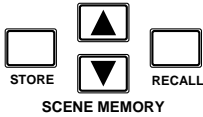

This is a read-only scene memory that contains the default settings for the system. The 02R will be reset to its initial settings.

Note: *It is best to start at the beginning of each tutorial and work your way through, taking breaks as required. If you deviate too far from the tutorial, or jump into a tutorial halfway through, you may find that subsequent tutorial steps do not work as expected. Also note that the tutorials do not explain all 02R functions, nor do they serve as a substitute for the User's Guide explanations. For full details on all 02R functions, refer to the User's Guide.*

3

Introductory Recording Tutorial

In this chapter...

Setting the Input Level	20
Applying EQ	24
Using the EQ Library	30
Routing	35
Panning	38

Setting the Input Level

Assuming that the 02R is powered ON and your music source is playing, the very first thing you need to do is set up a basic control room monitor mix. When you recall Scene Memory 0 “0 Initial Data”, all the channel faders are set to the 0 dB mark.

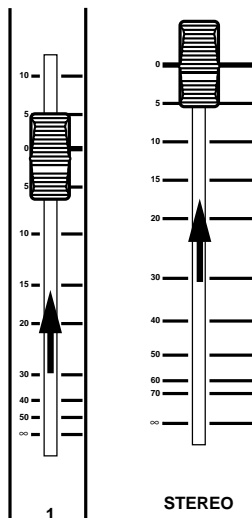

Setting Fader Levels

If the faders are not set to 0 dB, you should perform the following steps to optimize the input signal level for the best performance:

1. **Set the fader for MIC/LINE 1 to the 0 dB mark.**

The 0 dB fader position is a good place to start when setting fader levels. It is a good setting with regard to signal level and noise performance and it leaves room for you to raise the level later, if necessary.

2. **Set the STEREO fader to the 0 dB mark.**

The stereo output meters are indicating the stereo output level. The stereo mix signal is now being output to the digital and analog STEREO OUT connectors.

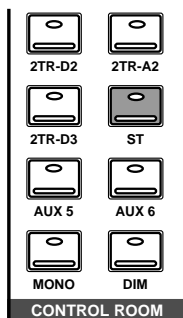

Selecting a Monitor Source

Before you can hear anything through your monitor amplifier and speakers, you have to select a Control Room source:

1. **Press the (ST) button of the CONTROL ROOM buttons group.**

This selects the stereo bus for monitoring in the control room.

2. **Adjust the volume with the C-R LEVEL control.**

You should be able to hear the sound source through your monitor speakers. If you are using stereo headphones, you will need to adjust the PHONES LEVEL control to set a comfortable listening level.



Note: *Be very careful with the level settings, especially if you are using stereo headphones. When you are adjusting a unit as complex as the 02R, it is possible for you to inadvertently switch on a very loud signal source. Damaged loudspeakers or amplifiers can be very expensive. Damage to your hearing can be much worse. Your ears are for life!*

Setting the GAIN



1. Use the (METER) button to locate the METER 1/3 page.

The MIC/LINE 1 signal is metered.

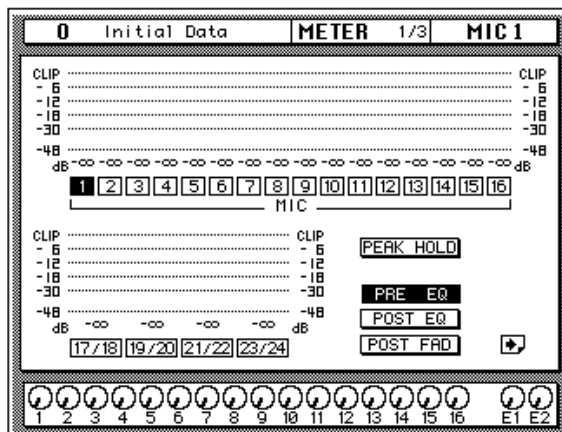

2. If the sound is distorted, the PEAK indicator is illuminated, or the level is going up to CLIP, press the 20 dB (pad) switch to attenuate the input signal for MIC/LINE 1.

You usually need to pad (attenuate) the input signal when you connect a line level device, such as a synthesizer or an effects unit to the channel. If you connect a microphone, you should not need to pad the signal.

If you want to use a high impedance device, such as a guitar or bass guitar, you should insert a direct box or effects processor between the guitar and the 02R—or you should mike the guitar amplifier.

Note: The stereo input channels (LINE 17 through 24) accept line level signals only.

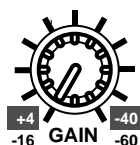

3. Use the GAIN control for MIC/LINE 1 to optimize the signal level.

Ideally the level should be set relatively high to obtain the best signal-to-noise performance. It is acceptable for the PEAK indicator to occasionally illuminate but the signal levels should not reach CLIP. If the PEAK indicator illuminates constantly, the signal is overloading the input preamplifier and you may be able to hear analog clipping distortion. When CLIP is reached, you will experience digital clipping distortion, which is usually very unpleasant sounding.

Back off the GAIN control a little until the PEAK indicator illuminates very occasionally. The GAIN control should be set with some care. If it is set too low, the signal-to-noise performance will suffer, and if it is set too high, signal clipping and distortion may occur.

∅/ATT Display Function

If a lot of EQ boost is applied, the signal level may reach CLIP on the METER page but the PEAK LED may not light up. Instead of lowering the GAIN control, which would reduce A/D converter efficiency, you can use the Attenuator function to attenuate the level.



1. Press the (∅/ATT) button.

The ∅/ATT 1/1 page shown below appears.

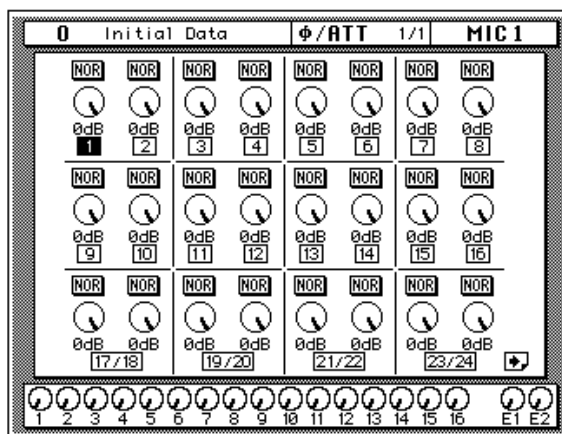

2. Press the (SEL) button for MIC/LINE 1.
3. Use the encoder wheel to attenuate the signal.

On the ∅/ATT page you can attenuate signals and reverse the phase, all in the digital domain.

Note: You should rarely find it necessary to use the ∅/ATT function on an input signal after the gain level has been correctly set, but you may need to attenuate after you apply EQ, effects, or dynamics to the signal.

Peak Hold



1. Use the (METER) button to locate the METER 1/3 page.
2. You may find the Peak Hold function useful at this point. To turn it on, use the CURSOR buttons to select the PEAK HOLD icon and press (ENTER). When the Peak Hold function is on, its icon is highlighted.

The peak level is indicated by an empty square box. Peak Hold is very useful for level checking before recording. You can leave a mix to play through unattended while Peak Hold watches out for signal peaks. If any levels reach CLIP, back off the relevant GAIN control or use the \emptyset /ATT display function to attenuate the signal and run through the mix again.

Note: *The Peak Hold function also works on the stereo output meters and controls the optional meter bridge (MB02).*

3. To clear the Peak Hold levels, select the PEAK HOLD icon with the CURSOR buttons and press (ENTER).

When you clear the Peak Hold levels, it also clears the peaks from the stereo output meters.

Typically, you will be using more than just one input channel, so you will need to set the input signal level for each channel individually. Since it is relatively easy to set them at this point, take time and care. If you have to adjust them later in the mixing process, you may need to adjust the faders, auxiliary sends, and other levels, as well.

Channel ON/OFF

The channel [ON] buttons are used to turn channels ON or OFF. This function is sometimes called MUTE. When you recall Scene Memory 0 “0 Initial Data”, all the channels are turned ON.



1. Press the channel (ON) button for MIC/LINE 1.

The sound is cut and the LED inset in the [ON] button switches off.

Note: *Even though you can no longer hear the sound source, the meter for MIC/LINE 1 continues to be displayed. This is because the meter signal is sourced before the [ON] button.*

2. Press the (ON) button again to turn the channel back ON.

The LED inset in the [ON] button illuminates again and you will be able to hear the sound source again.

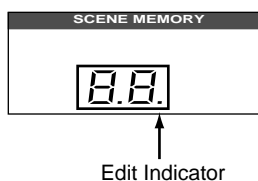

SCENE MEMORY LED

The 2-digit (7-segment) LED shows the currently selected scene memory. It also contains the Edit Indicator, which will start flashing when you adjust the first digital parameter of the current scene memory. See “Scene Memories” on page 62 of the *Getting Started Guide*.

Applying EQ

The next step is to apply EQ to MIC/LINE 1.

Each 02R channel features a four-band fully parametric EQ, with variable bandwidth (Q), frequency (F), and gain (G). The power of the 02R user interface means that there are two ways of adjusting the EQ for MIC/LINE 1.

One method is to use the EQ 1/2 page.

The more convenient method is to use the buttons and controls of the EQUALIZER block of the SELECTED CHANNEL controls.

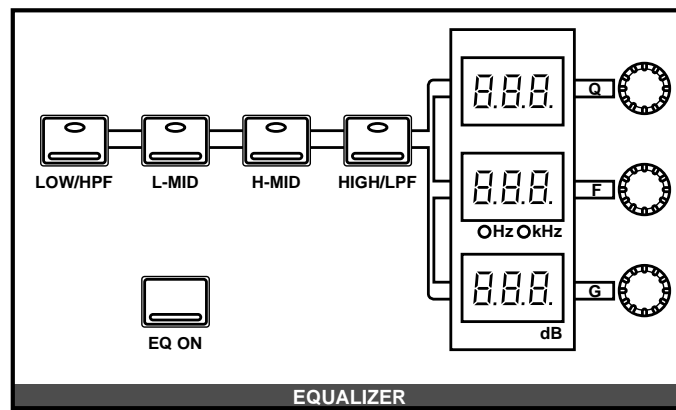

Note: You can customize your 02R so that when you adjust a control of the EQ block of the SELECTED CHANNEL controls, the EQ 1/2 page automatically appears. See “Preferences” on page 198 of the User’s Guide for more information. The default setting is to automatically display the EQ page.

The rest of this tutorial describes the operation of the EQ 1/2 page.

Turning the EQ ON/OFF



SEL

1. Press the (SEL) button for MIC/LINE 1.

When you press the [SEL] button for a channel, the LED and numeric indicators of the SELECTED CHANNEL controls change to reflect the status of the channel you selected.



EQ

2. Press the (EQ) button.

The EQ 1/2 page appears, showing the EQ curve and settings for MIC/LINE 1.

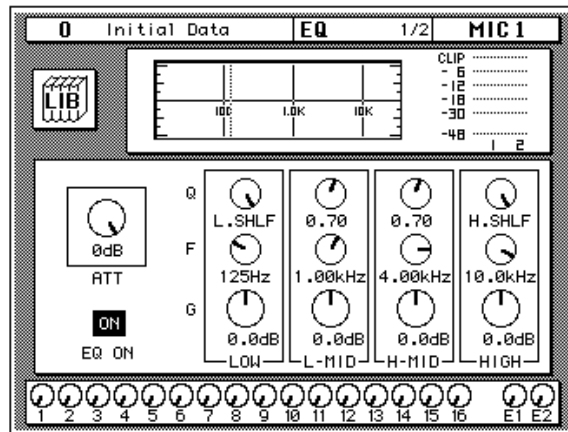

3. Use the CURSOR buttons to select the EQ ON icon.

If the EQ is ON, the icon will be highlighted. The LED inset in the [EQ ON] button of the SELECTED CHANNEL—EQUALIZER block controls will also be illuminated.

4. To turn the EQ either on or off, press the (ENTER) button or the (EQ ON) button.

The ON icon will change to OFF. The LED inset in the [EQ ON] button will no longer be illuminated.

Turn the EQ on for the remainder of this tutorial.

Setting the Gain

1. Select the gain (G) icon for the LOW band using the CURSOR buttons.

Alternatively, press the [LOW/HPF] button of the SELECTED CHANNEL—EQUALIZER controls.

2. Rotate the encoder wheel clockwise to boost the gain.

Alternatively, you could use the EQUALIZER G control.

The gain increases in 0.5 dB steps and the EQ curve on the EQ page changes to reflect this.

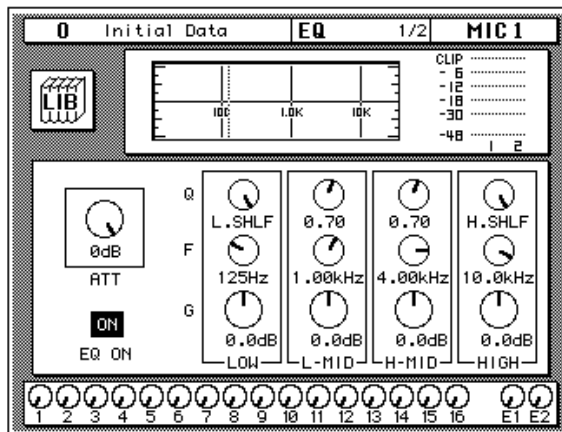

3. Rotate the encoder wheel counterclockwise to reduce the gain.

The gain decreases in 0.5 dB steps.

Alternatively, you could use the EQUALIZER G control.

4. Use the CURSOR buttons to select the gain (G) icon for the L-MID band and adjust its level with the encoder wheel. Select the other bands as well.

You can also select the EQ bands using the [LOW/HPF], [L-MID], [H-MID], and [HIGH/LPF] buttons of the SELECTED CHANNEL—EQUALIZER controls.

Note: *Applying a lot of EQ boost may increase the signal level sufficiently to cause distortion. If this does occur, reduce the amount of EQ boost or adjust the attenuation level to compensate (the ATT icon). You can switch back to the METER 1/3 page and select POST EQ to monitor the signal levels.*

Note: *You can reset the gain of each band to 0.0 dB by double-clicking the corresponding [LOW/HPF], [L-MID], [H-MID], or [HIGH/LPF] buttons of the SELECTED CHANNEL—EQUALIZER controls.*

Setting the Frequency

1. Select the frequency (F) icon for the LOW band using the CURSOR buttons.
2. Use the encoder wheel to sweep through the frequency range.

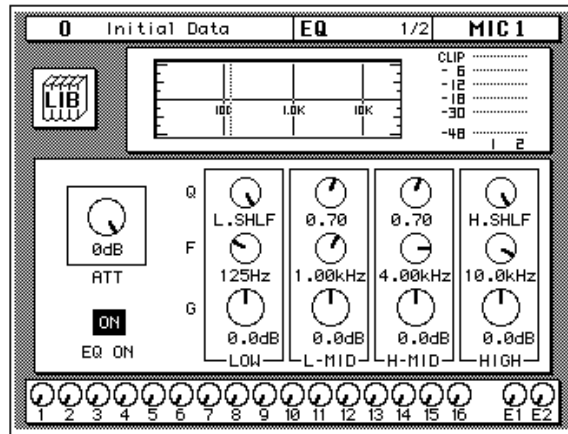

Alternatively, you could use the EQUALIZER F control.

All four bands of the 02R parametric EQ cover virtually the entire audio spectrum, from 21 Hz to 20.1 kHz. Although they are labelled LOW, L-MID, H-MID, and HIGH, the frequency of the bands can actually be in any order.

Note: *If your 02R is busy processing some complex data, it may take a little time to update the EQ curve. However, the internal EQ circuits reflect your adjustments immediately.*

Note: *As well as the frequency value in Hz displayed under the icon and on the numeric LED in the SELECTED CHANNEL—EQUALIZER controls, the dotted vertical line on the EQ graph indicates the current frequency position.*

3. Use the CURSOR buttons to select the frequency (F) icon for the L-MID band and adjust its position with the encoder wheel. Select the other bands and adjust their frequency.

You can also select the EQ bands using the [LOW/HPF], [L-MID], [H-MID], and [HIGH/LPF] buttons of the SELECTED CHANNEL—EQUALIZER controls. Adjust the EQUALIZER F control for each band.

Setting the Bandwidth

The L-MID and H-MID bands are peaking type EQs. The LOW and HIGH bands are initially configured as shelving type EQs, however, they can also be configured as peaking type EQs. The LOW band can also be configured as a HPF (high-pass filter) and the HIGH band as a LPF (low-pass filter).

1. **Select the bandwidth (Q) icon for the LOW band using the CURSOR buttons.**
2. **Use the encoder wheel to sweep through the bandwidth.**

Alternatively, you could use the EQUALIZER Q control.

The LOW band changes from low-shelving to peaking to high-pass filter as you continue to rotate the encoder wheel.

3. **As you rotate the encoder wheel counterclockwise, it effectively increases the Q—narrowing the bandwidth, as shown on the EQ graph.**

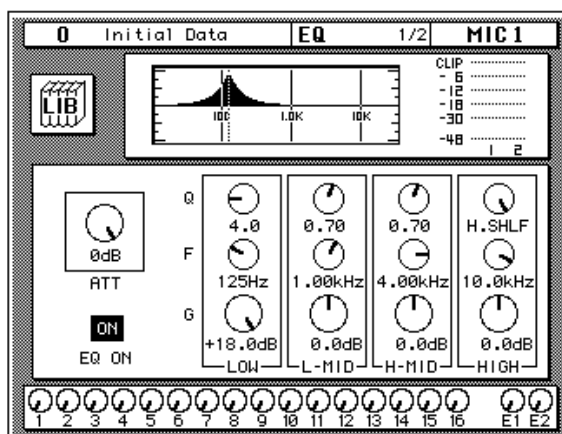

A narrow curve is useful for boosting or cutting specific frequencies.

4. **Use the CURSOR buttons to select the bandwidth (Q) icon for the L-MID band and adjust its position with the encoder wheel. Select and adjust the bandwidth of the other bands.**

You can also select the different bands using the [LOW/HPF], [L-MID], [H-MID], and [HIGH/LPF] buttons of the SELECTED CHANNEL—EQUALIZER controls. Adjust the EQUALIZER Q control for each band.

The HIGH band changes from high-shelving to peaking to low-pass filter as you adjust its value.

Resetting the EQ

1. Press and hold the (LOW/HPF) button and then press the (HIGH/LPF) button of the SELECTED CHANNEL—EQUALIZER controls.

All EQ values will be reset to their initial values.

	LOW/HPF	L-MID	H-MID	HIGH/LPF
Q	LOW SHELF	Peak – 0.7	Peak – 0.7	HIGH SHELF
F	125 Hz	1.00 kHz	4.00 kHz	10.0 kHz
G	0 dB	0 dB	0 dB	0 dB

Using the EQ Library

The EQ Library is used to access and store EQ settings—stored as programs. There are 32 preset programs (1 to 32) for you to recall and 96 user programs (33 to 128 plus UNDO) for you to store your own EQ settings. First you need to know how to recall EQ programs, then how to store your own.

Note: The programs 33 to 40 contain preset programs and are listed in the “EQ Programs” on page 54 of the User’s Guide. However, you can store your own settings to these programs.

Recalling an EQ Program



1. Use the (EQ) button to locate the EQ 2/2 page shown below.

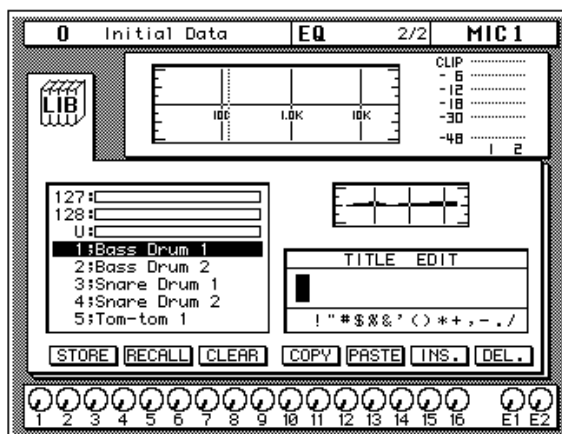

The top of the page shows the EQ curve for the selected channel and a level meter for the channel and its adjacent pair.

2. Press the (SEL) button for MIC/LINE 1.

This step is required only if you have selected another channel.

3. Select the RECALL icon with the CURSOR buttons.

In order to scroll through the list of EQ programs, the cursor must be on the STORE, RECALL, CLEAR, COPY, or PASTE icons.

4. Use the encoder wheel to select an EQ program.

As you scroll through the EQ programs, the EQ curve for each program is displayed to the left of the list.

5. Press the (ENTER) button.

The EQ program is recalled. The EQ curve for MIC/LINE 1 is set accordingly. The EQ curve at the top of the display is updated.

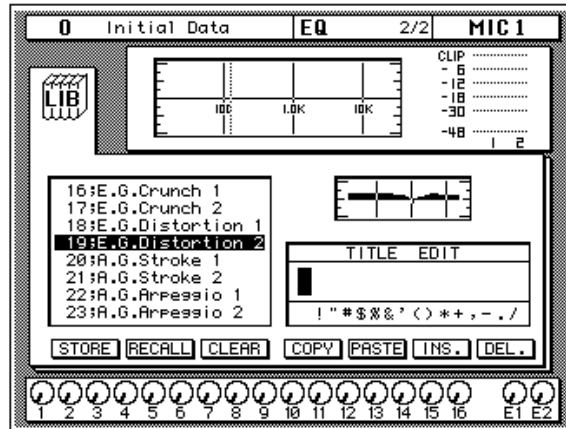

Your sound source is modified by the program you recalled. If the sound doesn't change, check if you have left the EQ ON switch turned OFF on the EQ 1/2 page. You can also quickly check if the LED inset in the EQ ON button of the SELECTED CHANNEL—EQUALIZER controls is illuminated or not.

6. Use the (EQ) button to locate the EQ 1/2 page.

The EQ 1/2 page shows the updated EQ curve and exact settings of the EQ program recalled.

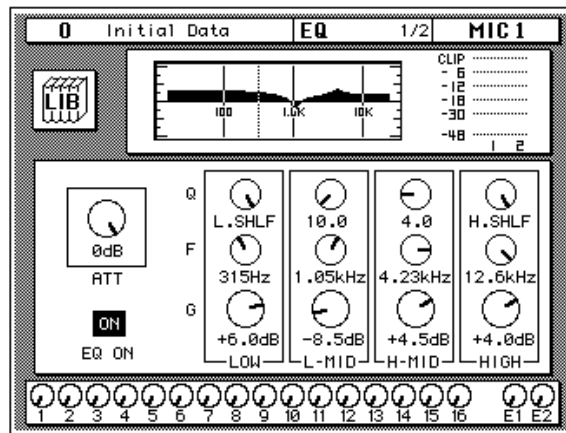

Undoing a Recall

You can undo EQ program recalls by recalling the "U" EQ program, which contains the previous EQ settings.

1. Use the CURSOR buttons to select the RECALL icon and rotate the encoder wheel until program "U" is highlighted.
2. Press the (ENTER) button.

The previous EQ settings are recalled.

Storing an EQ Program



1. Use the (EQ) button to locate the EQ 2/2 page shown below.

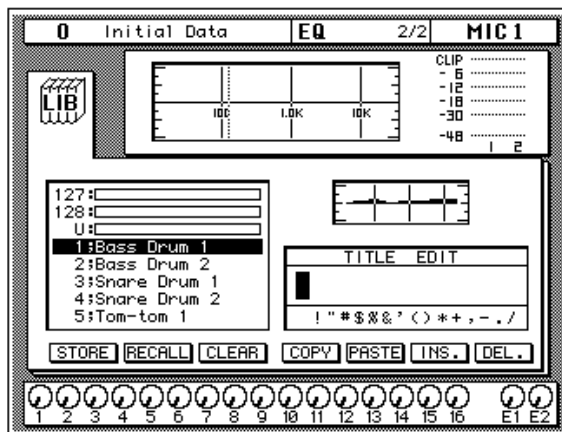

2. Select the STORE icon with the CURSOR buttons.

In order to scroll through the list of EQ programs, the cursor must be on the STORE, RECALL, CLEAR, COPY, or PASTE icons.

3. Use the encoder wheel to select an EQ program.

If you select one of the preset programs (1 to 32), an error message appears when you attempt to store your program. Select a program from the 96 user programs (33 to 128). You cannot store your settings to the "U" program either.

4. Use the CURSOR buttons to select the TITLE EDIT box.

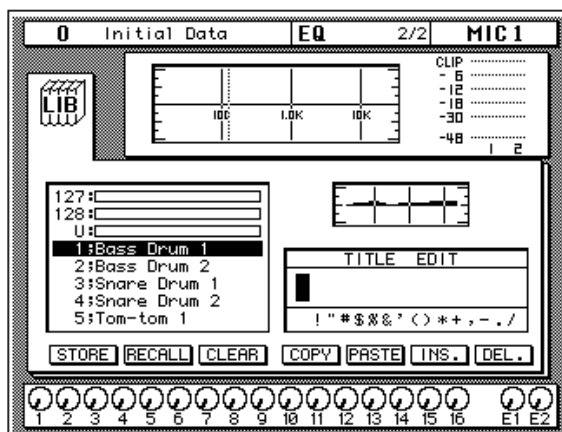

5. Select the individual character positions with the CURSOR buttons and rotate the encoder wheel to select the characters.

You can create a name of up to 16 characters long. It can contain any of the following characters:

	!	“	#	\$	%	&	'	()	*	+	,	-	.	/
0	1	2	3	4	5	6	7	8	9	:	;	<	=	>	?
@	A	B	C	D	E	F	G	H	I	J	K	L	M	N	O
P	Q	R	S	T	U	V	W	X	Y	Z	[\]	^	_
`	a	b	c	d	e	f	g	h	i	j	k	l	m	n	o
p	q	r	s	t	u	v	w	x	y	z	{		}	~	

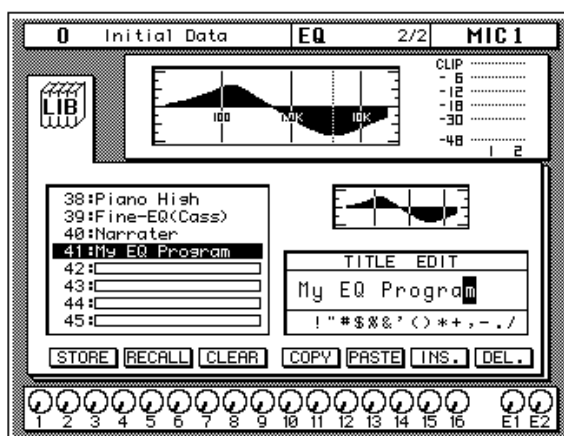

You can select the “INS.” icon to insert a space (blank) at the current cursor position. Select the icon with the CURSOR buttons and press the [ENTER] button. The “DEL.” icon is used to delete the character at the cursor position.

Note: The “COPY” and “PASTE” icons allow you to select the title from another EQ program and paste it into your program. These icons only copy the title, not the actual EQ settings. See “Icons” on page 55 of the User’s Guide.

6. Use the CURSOR buttons to select the STORE icon and press the (ENTER) button.

The 02R displays a confirmation dialog box asking if you want to store your settings in the selected EQ program. The dialog box has two icons: “CANCEL” and “EXECUTE”.

Note: You can customize your 02R to prevent the dialog box appearing during STORE operations. In this case, the program is stored without confirmation. See “Preferences” on page 198 of the User’s Guide for more information.

CANCEL is the default. To cancel the STORE operation, either press the [ENTER] button or wait about 10 seconds—the STORE operation will be automatically cancelled.

To store your settings, use the CURSOR buttons to select the “EXECUTE” icon and press the [ENTER] button. The EQ program is stored.

Note: *If you decide you don't like an EQ program after you have stored it, it is very easy to overwrite it by creating new settings and storing them to the same location. Conversely, it is also very easy to accidentally overwrite a valued EQ program.*

YOU SHOULD ALWAYS BE CAREFUL WHEN THE 02R DISPLAYS A CONFIRMATION DIALOG BOX!

Routing

This tutorial assumes you have a multitrack recorder and you have connected it to your 02R—after having one or more of the optional input/output cards installed:

- Alesis ADAT (CD8-AT)—This single slot card supports an 8-channel ADAT compatible modular digital multitrack recorder. It provides eight input channels and eight output channels. You can insert up to four of these cards in the 02R.
- TASCAM TDIF-1 (CD8-TDII)—This single slot card supports an 8-channel TASCAM modular digital multitrack recorder. It provides eight input channels and eight output channels. You can insert up to four of these cards in the 02R.
- YAMAHA (CD8-Y)—This single slot card supports an 8-channel YAMAHA modular digital multitrack recorder. It provides eight input channels and eight output channels. You can insert up to four of these cards in the 02R.
- AES/EBU (CD8-AE double slot card, CD8-AE-S single slot card)—These cards support an 8-channel AES/EBU compatible modular digital multitrack recorder (such as the Akai DD1500 series). They provide eight input channels and eight output channels.
- Analog AD/DA (CD8-AD)—This double slot card supports any 8-channel analog multitrack recorder. It provides eight input channels and eight output channels. You can insert only two of these cards in the 02R.

The 02R allows you to route the first 16 MIC/LINE channels directly to an output. If you have the correct configuration, this means you can send direct outputs to a 16-track recorder (for example, two paired ADAT compatible modular digital multitrack recorders).

You can route any channel to one of the eight output buses. The buses feed to each of the four 8-track I/O slots in the back of the 02R. You can also route any channel to the stereo bus.

When you recall Scene Memory 0 “0 Initial Data”, all the channels are routed to the stereo bus.

Using the ROUTING Display Function

There are two ways to operate the Routing function.

One method is to use the ROUTING 1/2 page.

The more convenient method is to use the buttons of the ROUTING block of the SELECTED CHANNEL controls.

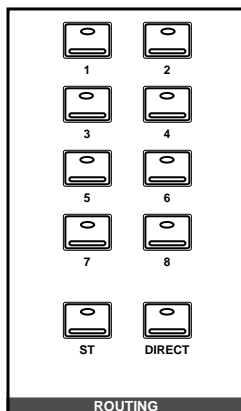

Note: You can customize the 02R so that when you press a button in the ROUTING block of the SELECTED CHANNEL controls, the ROUTING 1/2 page automatically appears. See "Preferences" on page 198 of the User's Guide for more information.

Selecting the Routing



1. Use the (ROUTING) button to locate the ROUTING 1/2 page shown below.

0	Initial Data																ROUTING 1/2								MIC 1																	
1	2	3	4	5	6	7	8	9	10	11	12	13	14	15	16	17	18	19	20	21	22	23	1	2	3	4	5	6	7	8	9	10	11	12	13	14	15	16	18	20	22	24
1	1	1	1	1	1	1	1	1	1	1	1	1	1	1	1	1	1	1	1	1	1	1	1	2	3	4	5	6	7	8	9	10	11	12	13	14	15	16	18	20	22	24
2	2	2	2	2	2	2	2	2	2	2	2	2	2	2	2	2	2	2	2	2	2	2	1	2	3	4	5	6	7	8	9	10	11	12	13	14	15	16	18	20	22	24
3	3	3	3	3	3	3	3	3	3	3	3	3	3	3	3	3	3	3	3	3	3	3	1	2	3	4	5	6	7	8	9	10	11	12	13	14	15	16	18	20	22	24
4	4	4	4	4	4	4	4	4	4	4	4	4	4	4	4	4	4	4	4	4	4	4	1	2	3	4	5	6	7	8	9	10	11	12	13	14	15	16	18	20	22	24
5	5	5	5	5	5	5	5	5	5	5	5	5	5	5	5	5	5	5	5	5	5	5	1	2	3	4	5	6	7	8	9	10	11	12	13	14	15	16	18	20	22	24
6	6	6	6	6	6	6	6	6	6	6	6	6	6	6	6	6	6	6	6	6	6	6	1	2	3	4	5	6	7	8	9	10	11	12	13	14	15	16	18	20	22	24
7	7	7	7	7	7	7	7	7	7	7	7	7	7	7	7	7	7	7	7	7	7	7	1	2	3	4	5	6	7	8	9	10	11	12	13	14	15	16	18	20	22	24
8	8	8	8	8	8	8	8	8	8	8	8	8	8	8	8	8	8	8	8	8	8	8	1	2	3	4	5	6	7	8	9	10	11	12	13	14	15	16	18	20	22	24
9	9	9	9	9	9	9	9	9	9	9	9	9	9	9	9	9	9	9	9	9	9	9	1	2	3	4	5	6	7	8	9	10	11	12	13	14	15	16	18	20	22	24
0	0	0	0	0	0	0	0	0	0	0	0	0	0	0	0	0	0	0	0	0	0	0	1	2	3	4	5	6	7	8	9	10	11	12	13	14	15	16	18	20	22	24
1	2	3	4	5	6	7	8	9	10	11	12	13	14	15	16	18	20	22	24					1	2	3	4	5	6	7	8	9	10	11	12	13	14	15	16	E1	E2	

2. Use the ROUTING buttons of the SELECTED CHANNEL controls to route the MIC/LINE 1 channel.

As you press the ROUTING buttons, the LED inset in the button illuminates and the corresponding icon on the ROUTING page appears highlighted.

You can also operate the routing using the CURSOR buttons to move to the desired routing icon and pressing the [ENTER] button.

Note: When you select a route, the signal from the channel will be routed to the selected bus. The output from that bus will appear at the corresponding outputs of all the I/O cards installed in the 02R. The only exception is when you are using I/O cards in slots 1 and 2 for direct output. See "Routing" on page 39 of the User's Guide for further details.

Panning

There are two ways to use the Pan function.

One method is to use the PAN 1/1 page.

The more convenient method is to use the buttons and controls of the PAN block of the SELECTED CHANNEL controls.

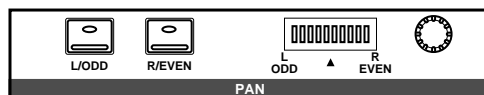

Note: You can customize your 02R so that when you adjust a control of the PAN block of the SELECTED CHANNEL controls, the PAN 1/1 page automatically appears. See “Preferences” on page 198 of the User’s Guide for more information.

Adjusting the Pan



1. Press the (PAN) button.

The PAN 1/1 page shown below appears.

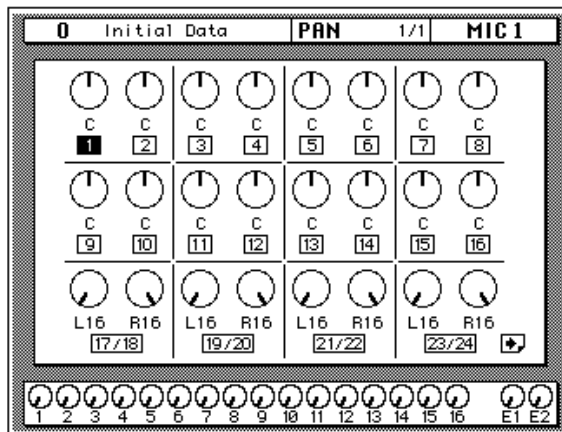

2. Press the (SEL) button for MIC/LINE 1 and rotate the PAN control.

The LED inset in the [L/ODD] button will be illuminated. The current pan position is indicated on the adjacent LED bargraph. As an alternative, you can use the CURSOR buttons to select the PAN icon for MIC/LINE 1 and rotate the encoder wheel.

You can adjust the pan position from extreme right/even (R16) through the center (C) to extreme left/odd (L16). There are 33 pan positions to choose from.

Ganging Pans

You can gang the pan controls of two adjacent channels for simultaneous pan adjustment

1. Press the (SEL) button for MIC/LINE 1.

You can also select the MIC/LINE 1 icon using the CURSOR buttons.

2. Press the (ENTER) button to connect the channels together.

You can also gang channels together by simultaneously pressing the [L/ODD] and [R/EVEN] buttons of the PAN block of the SELECTED CHANNEL group.

Ganged pan is indicated by a pair of dotted lines between the pan controls, as shown below.

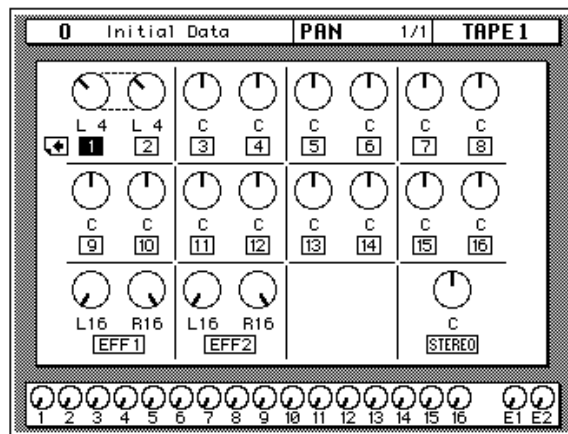

When you adjust one channel, the ganged channel also moves by a corresponding amount. For further details, see “Pan Gang” on page 37 of the *User’s Guide*.

4

Secondary Recording Tutorial

In this chapter...

Aux Sends	42
Setting the Aux Send Level	43
Creating a Monitor Mix	45
Applying Effects	46
Recalling and Editing Effects	49
Patching in a Dynamics Processor	54
Using the Dynamics Library	57
Scene Memories	62

Aux Sends

The 02R has eight aux sends.

AUX 7 and AUX 8 are used to feed the internal effects processors, with the signal remaining entirely in the digital domain.

The other auxiliary sends—AUX 1 through AUX 6—can be used to feed external signal processors and effects units, foldback amplifiers, or multitrack recording equipment. AUX 5 and AUX 6 can also be used to construct a monitor mix, and routed directly to either the studio or control room monitors. When a send is used to feed an external effects processor, the processed signal can be returned via one of the stereo input channels or an unused input channel.

There are two different ways to access the auxiliary send channels:

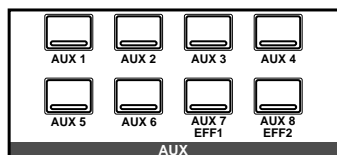

DISPLAY ACCESS—AUX buttons

- The [AUX 1] to [AUX 6] buttons access the AUX 1 to 6 pages, which display the aux send level controls and pre/post icons.
- The [AUX 7] and [AUX 8] buttons access the AUX 7 and 8 pages, which are used with the internal effects processors: Effect 1 and Effect 2.

When an AUX button is pressed, the faders and rotary encoders control aux send levels, not channel levels.

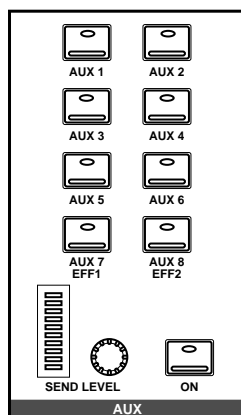

SELECTED CHANNEL—AUX controls

These buttons and controls set the aux send levels for the selected channel.

- The [AUX 1] to [AUX 8] buttons allow you to select the aux buses you want to send the selected channel signal to.
- The SEND LEVEL rotary encoder is used to set the level—indicated by the adjacent LED bargraph.
- The [ON] button is used to turn the send on or off.

Setting the Aux Send Level

In this tutorial, MIC/LINE 1 channel is sent to AUX 1.



1. Press the (AUX 1) button.

The AUX 1 1/1 page shown below appears.

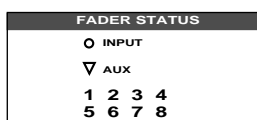
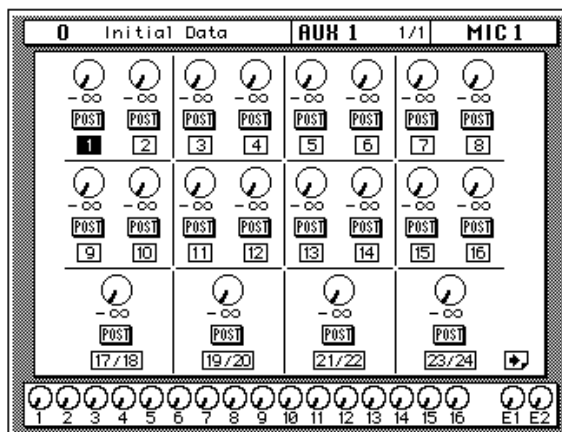

The faders change from channel level controls to aux send level controls. To indicate the change, the AUX LED of the FADER STATUS indicator illuminates. The number indicator corresponding to the current AUX button (in this case, AUX 1) is also illuminated. The faders automatically move from their channel level positions to the aux send level positions.

Note: Avoid blocking the fader movements when the faders move to their aux send positions by placing objects on the O2R. It is possible to damage the faders.

Although the faders have moved to the auxiliary send level positions, the O2R remembers the channel signal levels.

2. Select MIC/LINE 1 using the (SEL) buttons or the CURSOR buttons.

Turn the aux send on by pressing the [AUX 1] button and then the [ON] button in the AUX group of the SELECTED CHANNEL controls. The default is for the send to be ON, therefore this step is not usually required.

Note: In order to change the aux send status from on to off, you must first select the send channel with the corresponding button of the SELECTED CHANNEL—AUX controls

3. To change the aux send from post to pre fader, press the (ENTER) button.

The PRE icon becomes the POST icon and is highlighted when the signal is pre-fader.

4. To change the signal level, adjust the fader for MIC/LINE 1 until the desired value is obtained.

You can use the rotary encoders for the tape returns or press the [FLIP] button. Then the tape return channels can be operated by the faders. The effect returns can only be adjusted with the rotary encoders.

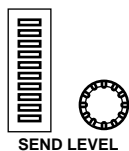

You can also use the SEND LEVEL encoder in the AUX group of the SELECTED CHANNEL controls. You must press the corresponding [AUX 1] button to make certain you are adjusting the signal level for the correct aux send.

Note: *In order to adjust the aux send level with the SEND LEVEL encoder, you must first select the send channel with the corresponding button of the SELECTED CHANNEL—AUX controls*

Creating a Monitor Mix

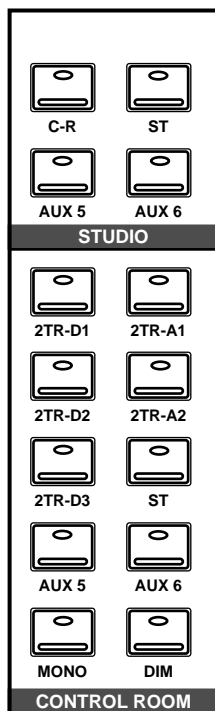

The 02R has two different monitoring outputs—the control room outputs and the studio outputs—plus, of course, the PHONES output (which is a duplicate of the control room output).

During a multitrack recording session, what you want to listen to in the control room is often very different from what the musicians need in the studio. For example, while recording a rhythm section, the bass player and the drummer may want to hear the kick drum at a much higher volume than you need in the control room.

To cater to this requirement, the 02R allows you to create a mono monitor mix using either AUX 5 or AUX 6 or a stereo mix using both AUX 5 and AUX 6.

Monitor Mix Process

The process for creating the monitor mix is similar to the steps detailed in “Setting the Aux Send Level” on page 43 of the *Getting Started Guide*

1. **Press the (AUX 5) button.**
2. **Select MIC/LINE 1 using the (SEL) buttons or the CURSOR buttons.**

Turn the aux send on by pressing the [AUX 5] button and then the [ON] button in the AUX group of the SELECTED CHANNEL controls.

You should leave the send pre-fader. This will allow the musicians to continue to hear each other independently of anything you may be doing in the control room.

3. **Press the (AUX 5) button of the STUDIO buttons group.**

You should also press the [AUX 5] button of the CONTROL ROOM buttons group so you can hear the results of adjusting the levels.

4. **Adjust the fader for MIC/LINE 1 until the desired signal level is obtained.**

Use the Talkback system to check with your musicians, to see if they are content with the signal levels you have set. When you finish setting the studio monitor levels, press the [ST] button of the CONTROL ROOM buttons group for monitoring in the control room.

Applying Effects

The 02R features two internal multi-effects stereo processors: Effect 1 and Effect 2. These are fed by AUX 7 and AUX 8, and the processed signals are returned via EFF 1 RTN and EFF 2 RTN, respectively. When you use the internal effects, the signal gets processed without ever leaving the digital domain.

Effects can be applied to input channels or the tape return channels. Effects are organized into programs. There are 40 preset effects programs (1 through 40) and 88 user effects programs (41 through 128 plus an UNDO buffer) for you to store your own settings.

Setting the Send Levels

The process for applying effects is similar to the steps as detailed in “Setting the Aux Send Level” on page 43 of the *Getting Started Guide*. The following example shows applying effects to MIC/LINE 1 using AUX 7.



1. Use the (AUX 7) button to locate the AUX 7 1/3 page shown below.

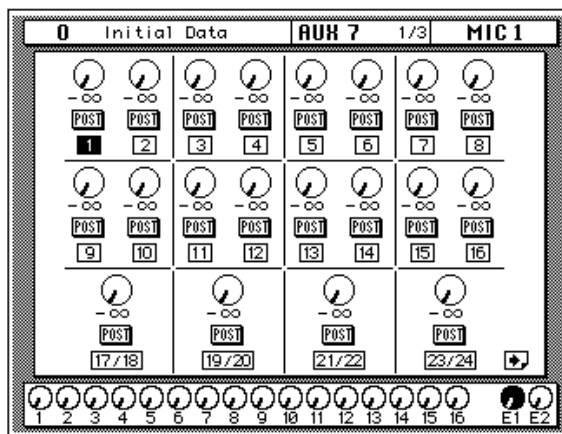

The faders automatically move from the channel level positions to the aux send level positions. Even though the fader has changed positions, the 02R remembers the channel signal levels.

Note: Avoid blocking the fader movements when the faders move to their aux send positions by placing objects on the 02R. It is possible to damage the faders.

2. Select MIC/LINE 1 using the (SEL) buttons or the CURSOR buttons.

Turn the aux send on by pressing the [AUX 7] button and then the [ON] button in the AUX group of the SELECTED CHANNEL controls.

3. Press the (ENTER) button to change the aux send from pre to post fader.

Sends to the effects are usually post fader. This means the signal level feed into the effects processor follows the “dry” channel level.

4. Adjust the fader for MIC/LINE 1 until the desired signal level is obtained.

Adjusting the Effect Return

The effect return channel is similar to one of the input channels except that it has no analog input, and therefore no gain or input pad need to be applied. Otherwise the steps are similar to those starting with “Setting the GAIN” on page 21 of the *Getting Started Guide*.

The easiest way of applying all the required adjustments is to select the View 1/2 page. This allows you to see all the parameters of the channel on one page, while you can still use the dedicated buttons and controls of the SELECTED CHANNEL group.



1. Use the (VIEW) button to locate the VIEW 1/2 page shown below, and press the (SEL) button for EFF 1 RTN.

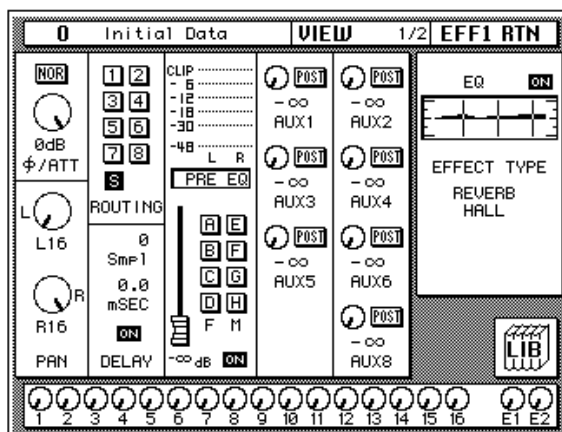

2. If the sound is distorted or the level is constantly going up to CLIP, use the CURSOR buttons to select the \emptyset /ATT icon. Adjust the level with the encoder wheel.

Note: In many cases, clipping in the effect return channel is caused by the send level being too high. You may need to adjust the send levels as well as the attenuation if you experience clipping.

3. Select the PAN icon with the CURSOR buttons and set the pan position using the encoder wheel.

Note: Setting the pan position, routing, and EQ can all be done quickly and easily with the dedicated controls of the SELECTED CHANNEL block.

4. Use the CURSOR buttons to select the ROUTING icons. Press the (ENTER) button to select routes for the effect return signal.

By default (assuming you are still working with Scene Memory 0 “0 Initial Data”) the effect return channel is routed to the stereo bus.

Note: *Although you cannot route the effect return channel to the direct outputs, you can route it to the same bus that the input channel is routed to, allowing you to record the effect together with the input signal.*

Many engineers prefer to add effects only during the final mix. It is very easy to apply effects, but difficult to remove it once it has been recorded. You may want to send the effect to the monitor mix, however, especially when recording a vocalist—many vocalists dislike hearing their voice “dry” in the monitors.

5. Select the EQ graph with the CURSOR buttons and press the (ENTER) button.

The 02R will automatically switch to the EQ 1/2 page. Follow the steps detailed in “Applying EQ” on page 24 of the *Getting Started Guide* to set the EQ for the effect return channel EFF 1 RTN.

Note: *Many engineers prefer to hold off applying EQ to a recording until they are ready to mixdown. Again, it is much easier to apply EQ than to subsequently remove it.*

Recalling and Editing Effects

Once you have applied effects to MIC/LINE 1, you need to know how to recall effects programs from the effects library and to adjust their parameters in order to create your own effect programs.

Recalling Effects Programs



1. Use the (AUX 7) button to locate the AUX 7 2/3 page shown below.

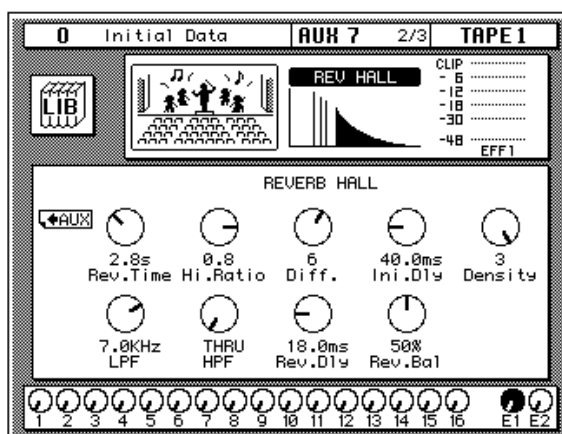

The parameters of the currently selected effects program are displayed on this page. You will see the library (LIB) icon, an effects curve or icon (depending on the selected effect), and a level meter for the effects return stereo pair, as well as icons for adjusting the parameters.

2. Use the (AUX 7) button to locate the AUX 7 3/3 page shown below.

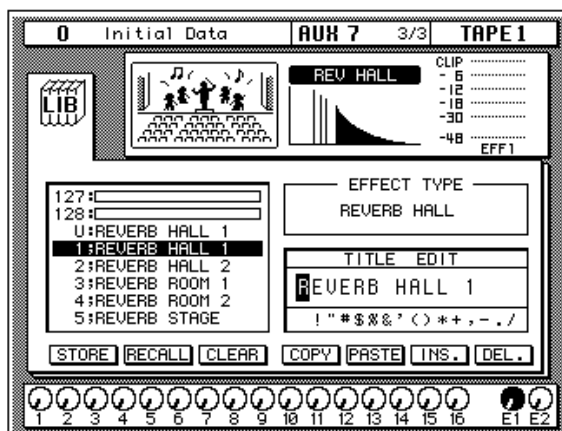

Alternatively, you could select the LIB icon and press the [ENTER] button to go to the AUX 7 3/3 page.

3. Use the CURSOR buttons to select the RECALL icon. Rotate the encoder wheel to select an effects program.

The 02R will scroll through the available effects programs. The program that is highlighted is the program that will be recalled when you press the [ENTER] button.

4. Press the (ENTER) button.

The effects program is recalled.

If you attempt to recall a user program that is empty, the 02R displays an error message, indicating that the selected memory location is not available for recall.

Editing Effects

You can edit the preset effects programs and then store them as user effects programs. The 02R has 40 preset programs (1 through 40). Some are simple variations of a basic effect, for example, different types of reverb and delay (echo) are available.

Select the preset effects program that is closest to the effect you are trying to achieve and edit its parameters.

1. Use the CURSOR buttons to select the LIB icon and press the (ENTER) button.

The AUX 7 2/3 page appears.

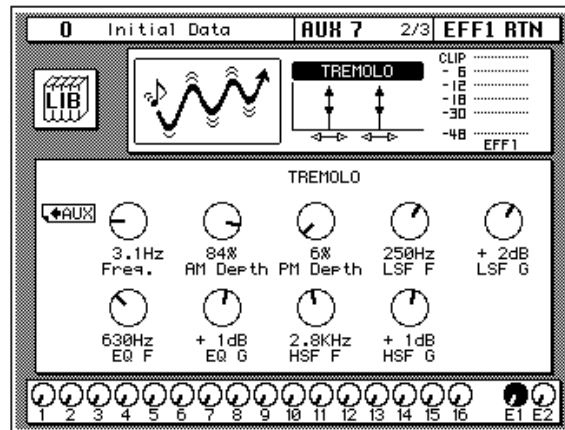

You can also press the [AUX 7] button to get to this page. This button allows you to access the aux send levels, the effects editing, and the effects library pages.

2. Select the various parameters with the CURSOR buttons, and adjust the value with the encoder wheel.

As you adjust the parameters, you should listen carefully to the results. Some of the parameters of some of the effects are very subtle in their effect, others are quite obvious.

After you have modified the effects program to your satisfaction, you are ready to store it.

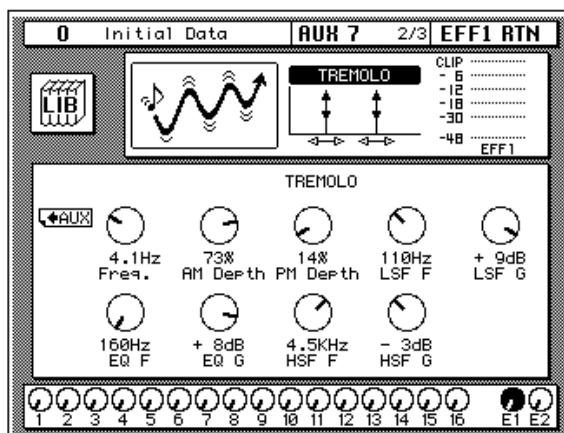

Storing a User Effect

The 02R has 88 user effects program locations (41 through 128) for you to store your own settings. You can store your effects program in the Effect Library, or you can just rely on the 02R scene memory to recall your settings. The following instructions show you how to store your program in the library.

1. Select the LIB icon with the CURSOR buttons and press the (ENTER) button.

The AUX 7 3/3 page appears.

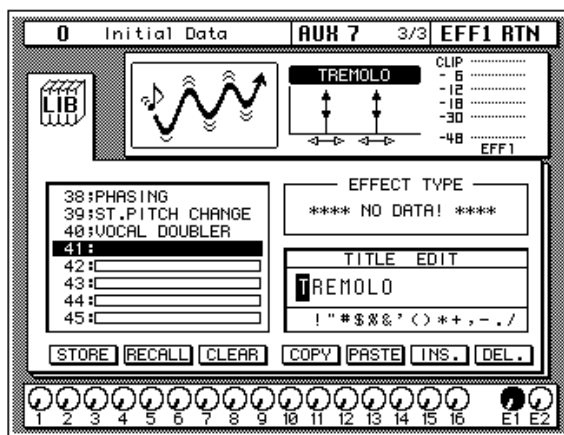

- Use the CURSOR buttons to select the TITLE EDIT box, as shown below.

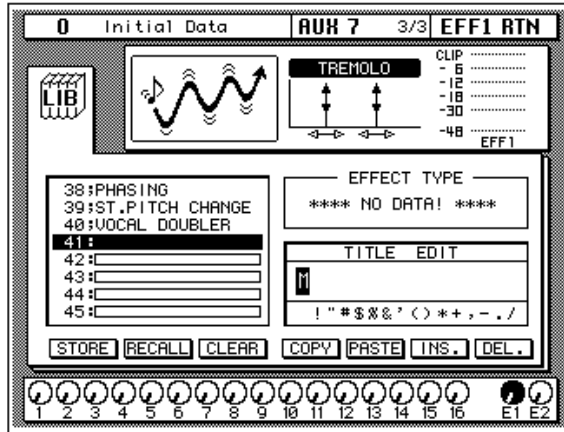

- Select the individual character positions with the CURSOR buttons. Use the encoder wheel to select the characters.

You can create a name of up to 16 characters long. It can contain any of the following characters:

	!	"	#	\$	%	&	'	()	*	+	,	-	.	/
0	1	2	3	4	5	6	7	8	9	:	;	<	=	>	?
@	A	B	C	D	E	F	G	H	I	J	K	L	M	N	O
P	Q	R	S	T	U	V	W	X	Y	Z	[\]	^	_
`	a	b	c	d	e	f	g	h	i	j	k	l	m	n	o
p	q	r	s	t	u	v	w	x	y	z	{		}	~	

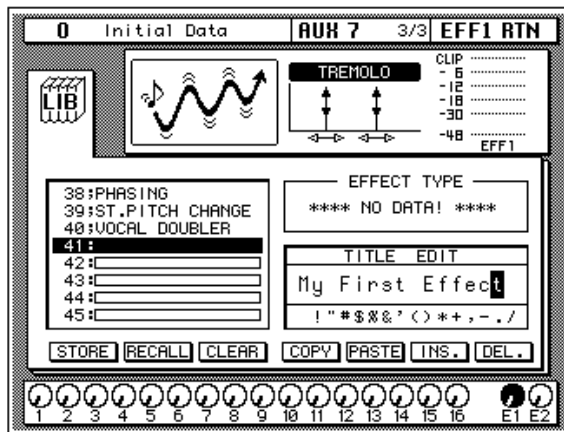

You can select the “INS.” icon to insert a space (blank) at the cursor position in the TITLE EDIT box. Select the icon with the CURSOR buttons and press the [ENTER] button. The “DEL.” icon is used to delete the character at the cursor position.

Note: The “COPY” and “PASTE” icons allow you to select the title from another effects program and paste it into your program for subsequent editing. These icons only copy the title, not the effects settings. See “Icons” on page 110 of the User’s Guide.

4. Use the CURSOR buttons to select the STORE icon. Rotate the encoder wheel to select an effects program.

If you select one of the preset programs (1 to 40), the message “Preset is read only!” appears when you attempt to store your program. Select a program from the 88 user programs (41 to 128).

You cannot store your settings to program “U” (the UNDO buffer) either.

5. Press the (ENTER) button.

The 02R displays a confirmation dialog box asking if you want to store your settings in the selected effects program. The dialog box has two icons: “CANCEL” and “EXECUTE”.

Note: You can customize your 02R to prevent the dialog box appearing during STORE operations. See “Preferences” on page 198 of the User’s Guide for more information.

CANCEL is the default. To cancel the STORE operation, either press the [ENTER] button or wait about 10 seconds—the STORE operation will be automatically cancelled.

To store your settings, use the CURSOR buttons to select the “EXECUTE” icon and press the [ENTER] button. The effects program is stored.

Note: If you decide you do not like an effects program after you have stored it, it is very easy to overwrite it by creating new settings and storing them to the same location. Conversely, it is also very easy to accidentally overwrite a valued effects program.

YOU SHOULD ALWAYS BE CAREFUL WHEN THE 02R DISPLAYS A CONFIRMATION DIALOG BOX!

Patching in a Dynamics Processor

The 02R features comprehensive dynamics processors for all the channel inputs, tape returns, and stereo and bus outputs. These processors allow you to compress, expand, compress/expand (comband), gate, or duck the signals passing through the mixer.

The dynamics processors are generally used to correct or control signal levels, giving you unparalleled sonic quality and flexibility. You can also use them creatively to shape the volume envelope of a sound.

Compressor

A compressor provides a form of automatic level control. It attenuates high levels, thus effectively reducing the dynamic range, making it much easier to control signals and set appropriate fader levels. Reducing the dynamic range also means that recording levels can be set higher, thereby improving the signal-to-noise performance.

Limiting is an extreme form of compression, where the output signal is sharply attenuated so that it cannot exceed a particular level.

Expander

An expander is another form of automatic level control. By attenuating the signal below the threshold, the expander reduces low-level noise or expands the dynamic range of the recorded material.

Combander

A combander is a compressor/expander—a combination of signal compression and expansion. The combander attenuates the input signal above the threshold as well as the level below the width. For very dynamic material, this program allows you to retain the dynamic range without having to be concerned with excessive output signal levels and clipping.

Gate and Ducking

A gate, or noise gate is an audio switch used to mute signals below a set threshold level. It can be used to suppress background noise and hiss from valve (tube) amps, effects pedals, and microphones.

Ducking is used to automatically reduce signal levels when the level of a source signal exceeds a specified threshold. It is used for voice-over applications where, for example, the level of background music is automatically reduced, allowing an announcer to be heard clearly.

Compressing the Stereo Output

You can apply dynamics to the input channels, for example, the channel you have used throughout these tutorials—MIC/LINE 1. The selection of dynamics program would depend on the input material: a gate for a noisy guitar amp, a compressor for an unpredictable vocalist, and so on.

In this case, apply a compressor to the stereo bus to add punch to the output signal. You can hear the effect by monitoring the stereo bus with the control room buttons.



1. Use the (DYNAMICS) button to locate the DYNAMICS 1/2 page shown below.

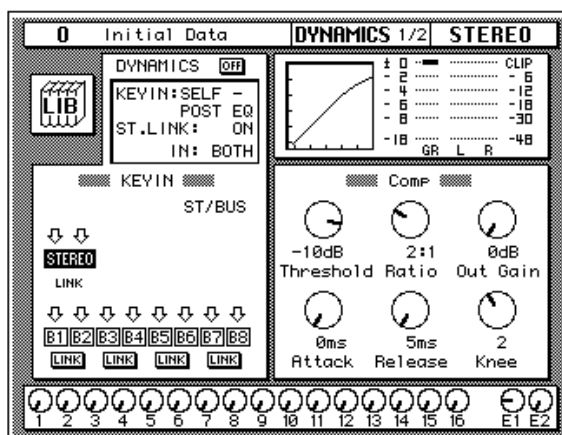

2. Press the (SEL) button for STEREO.

Note: If one of the icons B1 through B8 in the KEY IN section of the display is highlighted, it means the corresponding output bus is selected. To select the stereo bus, move the cursor to the STEREO icon using the CURSOR buttons and press the [ENTER] button.

By default (assuming you are still working with Scene Memory 0 “0 Initial Data”) the dynamics processor is set to a compression program with all parameters set to the default value as shown in the table below:

Threshold	0 dB	Knee	hard
Ratio	1:1	Attack	0 ms
Out Gain	0 dB	Release	5 ms *1

*1 This value is obtained when the sampling frequency is 48 kHz.

The processor is OFF.

3. Use the **CURSOR** buttons to select the **DYNAMICS OFF** icon and press the **(ENTER)** button to turn the processor on.

The icon is highlighted with the text changed to ON. Being able to easily turn the dynamics processor on and off allows you to perform quick A-B listening tests.

4. Select the **KEY IN** parameter with the **CURSOR** buttons. Rotate the encoder wheel or press the **(ENTER)** button to select the trigger source for the processor.

By default, the STEREO channel is triggered by itself, pre-EQ (SELF – PRE-EQ). You can select post-EQ or the signal on the aux buses, AUX 1 or AUX 2.

Note: As you change the **KEY IN** parameter, the icons in the **KEY IN** block on the display also change.

You should select either SELF – PRE-EQ or SELF – POST-EQ.

5. Use the **CURSOR** buttons to select the compressor parameters.
6. Adjust the value of each parameter by rotating the encoder wheel.

To compress the stereo output signal, try settings similar to those in the following table:

Threshold	–10 dB	Knee	2
Ratio	2:1	Attack	60 ms
Out Gain	0 dB	Release	1.02 sec *1

*1 This value is obtained when the sampling frequency is 44.1 kHz or 48 kHz.

The above settings provide a 2:1 compression above –10 dB. This means for every 1 dB change in input signal level above –10 dB there will be a 0.5 dB change in the output level. You can increase the output level without as much risk of clipping. The overall effect is the output signal sounds louder, essentially because you have limited—or compressed—the dynamic range.

Experiment with the settings until you get an effect that you like.

Using the Dynamics Library

Once you have applied a dynamics processor to the stereo bus, you need to know how to recall dynamics programs from the library and to adjust the parameters to create your own dynamics programs.

Recalling Dynamics Programs



1. Use the (DYNAMICS) button to locate the DYNAMICS 2/2 page shown below.

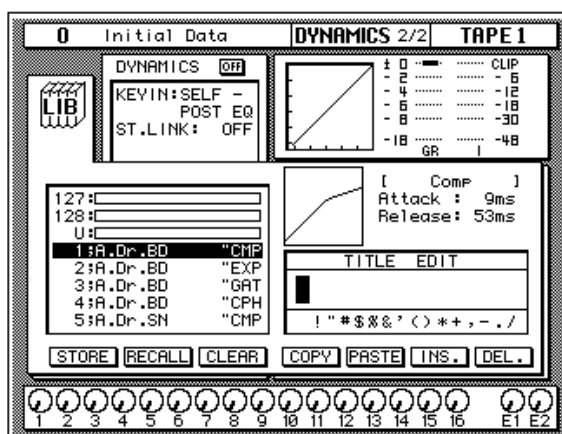

Alternatively, you could use the LIB icon on the DYNAMICS 1/2 page to go to the DYNAMICS 2/2 page.

2. Use the CURSOR buttons to select the RECALL icon. Rotate the encoder wheel to select a dynamics program.

The 02R will scroll through the available dynamics programs. The program that is highlighted is the program that will be recalled when you press the [ENTER] button.

3. Press the (ENTER) button.

The dynamics program is recalled.

If you attempt to recall a user program that is empty, the 02R displays an error message, indicating that the selected memory location is not available for recall.

Note: Unlike EQ and effects, it is sometimes necessary to apply a dynamics processor to an input signal as you are recording multitrack sources. Some signals are too unpredictable or noisy to record without some form of compression or gating. However, you should be very selective about the dynamics you apply, as the same rule holds: it is easy to add the effect, but very difficult to remove it afterwards.

Editing Dynamics Programs

You can edit the preset dynamics programs and then store them as user programs. The 02R has 40 preset programs (1 through 40). Each program is a variation on the six basic dynamics processors available:

- Compressor (CMP)
- Gate (GAT)
- Expander (EXP)
- Compander – Hard (CPH)
- Compander – Soft (CPS)
- Ducking (DUK)

Select the preset dynamics program that is closest to the effect you are trying to achieve and edit its parameters. For a list of the preset programs, see “Preset Dynamics Programs” on page 76 of the *User’s Guide*.

Note: *The program name of each preset dynamics program contains a three letter code indicating the type of dynamics processor it is.*

1. Use the (DYNAMICS) button to locate the DYNAMICS 1/2 page shown below.

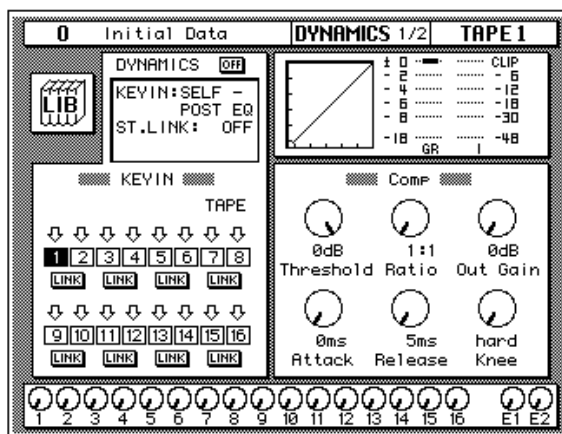

Alternatively, you could use the LIB icon on the DYNAMICS 2/2 page to go to the DYNAMICS 1/2 page.

2. Select the various parameters with the CURSOR buttons, and adjust the values with the encoder wheel.

After you have modified the dynamics program to your satisfaction, you are ready to store it.

Storing a User Dynamics Program

The 02R has 88 user dynamics program locations (41 through 128) for you to store your own settings. You can store your dynamics program in the Dynamics Library, or you can just rely on the 02R scene memory to recall your settings. The following instructions show you how to store your program in the library.

1. Use the (DYNAMICS) button to locate the DYNAMICS 2/2 page shown below.

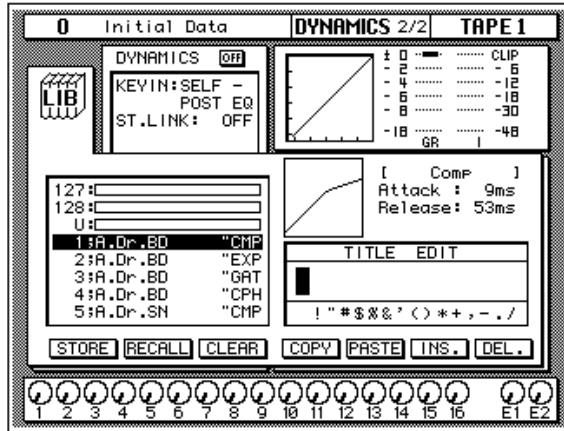

Alternatively, you could use the LIB icon on the DYNAMICS 1/2 page to go to the DYNAMICS 2/2 page.

2. Use the CURSOR buttons to select the TITLE EDIT box.
3. Select the individual character positions with the CURSOR buttons. Use the encoder wheel to select the characters.

You can create a name of up to 16 characters long. It can contain any of the following characters:

	!	“	#	\$	%	&	'	()	*	+	,	-	.	/
0	1	2	3	4	5	6	7	8	9	:	;	<	=	>	?
@	A	B	C	D	E	F	G	H	I	J	K	L	M	N	O
P	Q	R	S	T	U	V	W	X	Y	Z	[\]	^	_
`	a	b	c	d	e	f	g	h	i	j	k	l	m	n	o
p	q	r	s	t	u	v	w	x	y	z	{		}	~	

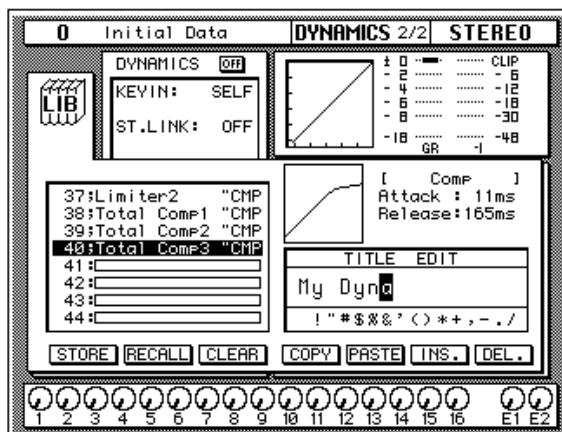

You can select the “INS.” icon to insert a space (blank) at the current cursor position in the TITLE EDIT box. Select the icon with the CURSOR buttons and press the [ENTER] button. The “DEL.” icon is used to delete the character at the cursor position.

Note: The “COPY” and “PASTE” icons allow you to select the title from another dynamics program and paste it into your program for subsequent editing. These icons only copy the title, not the dynamics settings. See “Icons” on page 88 of the User’s Guide.

4. Use the CURSOR buttons to select the STORE icon. Rotate the encoder wheel to select a dynamics program.

If you select one of the preset programs (1 to 40), the message “Preset is read only!”, appears when you attempt to store your program. Select a program from the 88 user programs (41 to 128). You cannot store your settings to program “U” (the UNDO buffer) either.

5. Press the (ENTER) button.

The O2R will display a confirmation dialog box asking if you want to store your settings in the selected dynamics program. The dialog box has two icons: “CANCEL” and “EXECUTE”.

Note: You can customize your O2R to prevent the confirmation dialog box appearing during STORE operations. See “Preferences” on page 198 of the User’s Guide for more information.

CANCEL is the default. To cancel the STORE operation, either press the [ENTER] button or wait about 10 seconds—the STORE operation will be automatically cancelled.

To store your settings, use the CURSOR buttons to select the “EXECUTE” icon and press the [ENTER] button. The dynamics program is stored.

Note: *If you decide you do not like a dynamics program after you have stored it, it is very easy to overwrite it by creating new settings and storing them to the same location. Conversely, it is also very easy to accidentally overwrite a valued dynamics program.*

YOU SHOULD ALWAYS BE CAREFUL WHEN THE 02R DISPLAYS A CONFIRMATION DIALOG BOX!

Scene Memories

The 02R scene memories are a snapshot of all the digital parameters of the mixer. The 02R has 96 mix scene memory locations. Each can be named for easy identification.

There are two special scene memories. “0 Initial Data” is a read-only scene memory that resets the 02R to its default settings. The other is an undo buffer entitled “U”. Recalling the undo buffer restores the last state of the 02R.

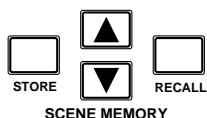

Scene memories can be stored and recalled using the [STORE] and [RECALL] buttons. Scene memories are selected using the SCENE MEMORY increment or decrement buttons.

They can also be recalled using automix or by using MIDI Program Changes from a computer, MIDI sequencer, or MIDI footswitch. You can save scene memories to a MIDI data filer.

Storing a Scene Memory

When you store a scene memory, you should check that all the mixer settings in the Edit Buffer are correct. Some settings may have been adjusted accidentally, or by someone else. If you are not sure about the exact contents of the mixer and do not want to laboriously check each setting, recall the initial mixer settings (Scene Memory 0 “0 Initial Data”), make the adjustments that you really want, and then store.

Note: *You may want to store the current mix settings to an unused scene memory, just in case.*

1. Use the SCENE MEMORY increment or decrement buttons to select a scene memory.

You cannot store your settings to either of the special scene memories: “U” (the UNDO buffer) or “0 Initial Data”. If you select these scene memories, an error message appears when you attempt to store your scene memory.



When you select a new scene memory, the number displayed in the SCENE MEMORY LED indicator flashes.

2. Press the (STORE) button.

The 02R displays a confirmation dialog box asking if you want to store your settings in the selected scene memory. The dialog box has two icons: “CANCEL” and “EXECUTE”.

Note: *You can customize your 02R to prevent the confirmation dialog box appearing during STORE operations. See “Preferences” on page 198 of the User’s Guide for more information.*

CANCEL is the default. To cancel the STORE operation, either press the [ENTER] button or wait about 10 seconds—the STORE operation will be automatically cancelled.

To store your settings, use the CURSOR buttons to select the “EXECUTE” icon and press the [ENTER] button.

The scene memory is stored.

Note: *If you decide you do not like a scene memory after you have stored it, it is very easy to overwrite it by adjusting the mixer settings and storing them to the same location. Conversely, it is also very easy to accidentally overwrite a valued scene memory. The 02R has a “Memory Protect” feature to help prevent this, but this feature can interfere with your work, plus it is very easy to turn off the protection. See “Protecting Scene Memories” on page 134 of the User’s Guide*

YOU SHOULD ALWAYS BE CAREFUL WHEN THE 02R DISPLAYS A CONFIRMATION DIALOG BOX!

Naming a Scene Memory

Scene memories can be named before being stored or after. In the latter case, you must first recall the scene memory, name it, and then store it. In this tutorial, a scene memory that has already been stored is named.



1. Use the (SCENE MEMORY) button to locate the SCENE 1/5 page shown below.

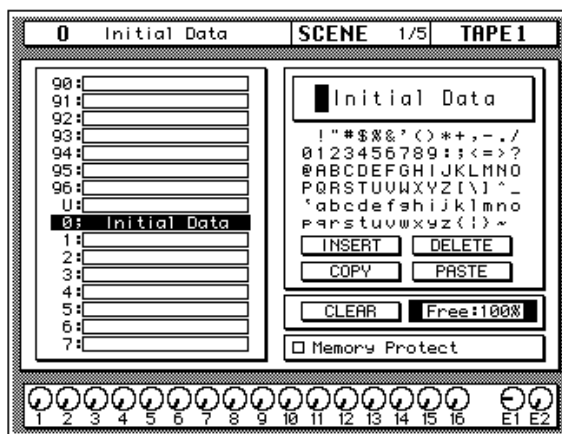

2. Use the SCENE MEMORY increment or decrement buttons, or encoder wheel, to select the scene memory.

When you select a different scene memory, the number displayed in the SCENE MEMORY LED indicator flashes.

3. Press the (RECALL) button to recall the scene memory.
4. Use the CURSOR buttons to select the TITLE EDIT box.

5. Select the individual character positions with the CURSOR buttons. Use the encoder wheel to select the characters.

You can create a name of up to 16 characters long. It can contain any of the following characters:

	!	“	#	\$	%	&	'	()	*	+	,	-	.	/
0	1	2	3	4	5	6	7	8	9	:	;	<	=	>	?
@	A	B	C	D	E	F	G	H	I	J	K	L	M	N	O
P	Q	R	S	T	U	V	W	X	Y	Z	[\]	^	_
`	a	b	c	d	e	f	g	h	i	j	k	l	m	n	o
p	q	r	s	t	u	v	w	x	y	z	{		}	~	

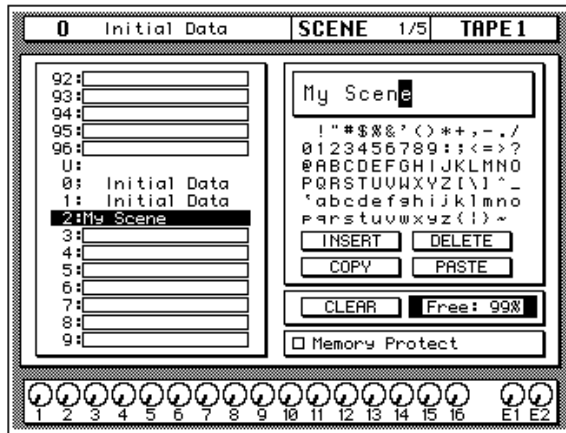

You can select the “INSERT” icon to insert a space (blank) at the cursor position in the title edit box. Select the icon with the CURSOR buttons and press the [ENTER] button. The “DELETE” icon is used to delete the character at the cursor position.

Note: The “COPY” and “PASTE” icons allow you to copy the title from another scene memory and paste it into the title edit box for subsequent editing. If you use the Copy function, be sure to select the scene memory whose name you are editing before storing. Otherwise, you’ll overwrite the scene whose name you copied.

6. Press the (STORE) button.

If you respond to the confirmation dialog box by selecting “EXECUTE” and pressing the [ENTER] button, the scene memory is stored with its new name.

Recalling a Scene Memory

Scene memories are recalled using the [RECALL] button. They can also be recalled using the automix or by using MIDI Program Change Messages.

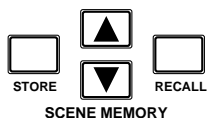

1. Use the SCENE MEMORY increment or decrement buttons to select the desired scene memory.

When you select a different scene memory, the number displayed in the SCENE MEMORY LED indicator flashes.

2. Press the (RECALL) button.

The selected scene memory is recalled.

Note: When recalling mix scenes, be aware that volume levels may change suddenly as channels are switched ON and faders moved. The 02R has a feature that allows you to fade the levels as a scene memory is loaded, but it cannot compensate for the sudden burst of a channel suddenly being switched on. See “Fade Time” on page 136 of the User’s Guide for further information.

When the scene memory is recalled, the number displayed in the SCENE MEMORY LED indicator stops flashing.

If you attempt to recall a scene memory that is empty, the 02R displays an error message, indicating that the selected memory location is not available for recall.

5

Mixing and Automix

In this chapter...

What is 02R Automix?..... 68

Real-time Automix 69

Editing Automix Events 76

Off-line Automix Editing 81

Using the Automix Library 87



What is 02R Automix?

There are three basic steps to making a multitrack recording:

- Setup and initial tracks
- Overdubbing
- Mixdown

Each step is vital in order to produce a satisfactory recording, but the most difficult one for most engineers is the mixdown. The musicians have finished their work. They have played their instruments and sung their vocals. All that raw material is stored on your multitrack recorder, waiting to be turned into a perfect final mix.

To assist you with this difficult task, the 02R has a fully-featured on-board automix system. It memorizes fader position changes, switches individual channels on or off, adjusts the EQ or pan positions, and changes the auxiliary sends—all based on timecode. It can also recall scene memories and programs from the EQ library, effects library, dynamics library, and channel library.

This allows you to record an entire mixing session, and then edit the individual channel settings in multiple passes until you have achieved perfection. You can punch-in to fine tune a specific parameter or you can use one of the event editors to adjust the timecode position of a channel setting or scene change. You can easily create a mix that would be virtually impossible to achieve on a standard analog mixer.

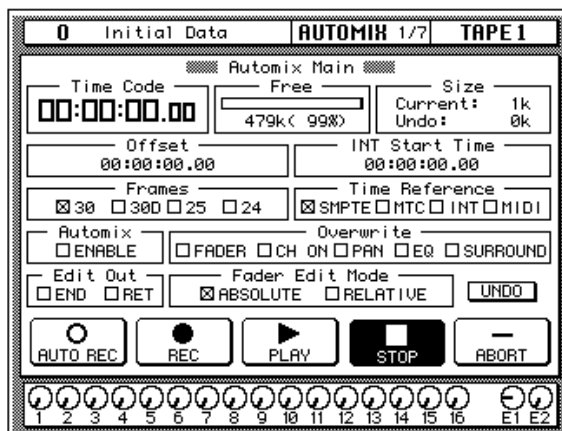

Automix Memory

The 02R has a current automix buffer and 16 automix memories. There is also an undo buffer. Only the current mix can be played back and recorded. You can store the current mix in any of the 16 automix memories.

Real-time Automix

These tutorials have assumed you are using your 02R with one or more of the optional I/O cards installed and a multitrack recorder connected. In this section, you will be synchronizing your multitrack recorder to the 02R. There are three basic ways of doing this:

- If your multitrack recorder is equipped with a SMPTE timecode output connector, you use an audio cable to connect it to the SMPTE TIME CODE INPUT jack on the rear panel of the 02R.
- Use an external SMPTE timecode generator if your multitrack recorder cannot output SMPTE time. You need to record timecode onto one of the tracks of your multitrack recorder and connect the output from that track directly to the SMPTE TIME CODE INPUT jack on the rear panel of the 02R.
- Use a MIDI sequencer to send MTC (MIDI timecode) or MIDI Clocks to the 02R as well as your multitrack recorder. Connect a MIDI cable to the MTC TIME CODE INPUT jack on the rear panel of the 02R.

There is an additional option—you can automate the 02R using its internal timecode generator. However, you cannot synchronize with an external device as the 02R has no timecode output connectors. This mode is effective for learning how to use the automix system.

Basic Connections and Setup

1. Connect your timecode source to the 02R.
2. Use the (AUTOMIX) button to locate the AUTOMIX 1/7 page.

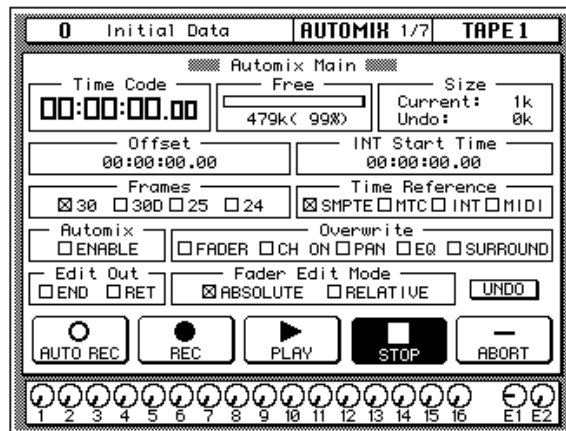

3. Use the CURSOR buttons to select the desired "Frames" rate and press the (ENTER) button.

The 02R supports the following frame rates:

- 30—30 frames per second.

- 30D—29.97 frames per second (30 drop frame).
- 25—25 frames per second.
- 24—24 frames per second.

These frame rates apply to the SMPTE, MTC, and INT time references.

4. Select the “Time Reference” with the CURSOR buttons and press the (ENTER) button.

Select the time reference from the four options:

- SMPTE timecode (the motion picture standard)
- MTC (MIDI timecode)
- INT (internal)
- MIDI (MIDI Clock)

5. Use the CURSOR buttons to select the “Automix” ENABLE and press the (ENTER) button to switch it on.

The automix system will not function unless this check box is enabled.

6. Select the desired “Overwrite” items with the CURSOR buttons and press the (ENTER) button.

This field allows you to select the types of events that will be recorded. Only the items selected will be recorded. Choose from the following:

- FADER—channel level operations (fader or encoder) including auxiliary send levels.
- CH ON—[ON] button selections for each channel.
- PAN—pan position for each channel.
- EQ—EQ selections for each channel.
- SURROUND—surround pan events

Note: *Scene memories and all library recall operations will be recorded regardless of the settings of the “Overwrite” options.*

The other options on this page are also important, but not for the purposes of this tutorial. See “Automix Main” on page 144 of the *User’s Guide* for more details.

Creating a New Automix

To record an entire mixing session with the 02R automix system, you must first create a new automix. When a new automix is created, the contents of the current automix (referred to as “events”) are deleted and the current automix is returned to its default settings.

If you want to keep the contents of the current automix, store them into an available memory location before proceeding.



1. Use the (AUTOMIX) button to locate the AUTOMIX 2/7 page.

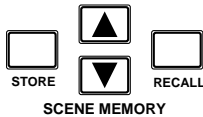
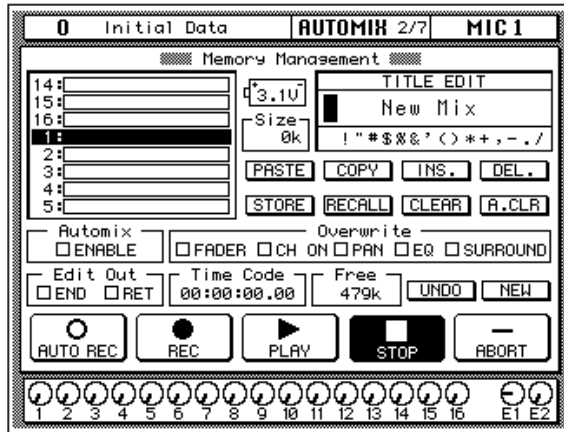

2. Use the SCENE MEMORY increment or decrement buttons to select your starting scene memory and press the (RECALL) button.

The selected scene memory is recalled.

Your mixdown scene memory should be stored with the [FLIP] button pressed so that the faders operate the tape returns rather than the input channels.

Note: You can customize your 02R so that the [FLIP] button status is ignored during scene memory recalls. In this case, you may need to press the [FLIP] button before you start recording your automix. See "Preferences" on page 198 of the User's Guide for more information.

3. Set your starting levels for the mixdown and press the (STORE) button to update the scene memory.

The 02R will display a popup confirmation request message. Select the "EXECUTE" icon and press the [ENTER] button.

4. Use the CURSOR buttons to select the "NEW" icon and press the (ENTER) button.

The 02R will display a popup confirmation request message asking if you want to make a new automix. The popup has two icons: "CANCEL" and "EXECUTE":



CANCEL is the default. To cancel the NEW operation, either press the [ENTER] button or wait about 10 seconds—the NEW operation will be automatically cancelled.

To create the new automix, use the CURSOR buttons to select the “EXECUTE” icon and press the [ENTER] button. The last scene memory that was stored or recalled will be inserted at timecode location 00:00:00.00.

Recording the First Session



1. Use the (AUTOMIX) button to locate the AUTOMIX 1/7 page.

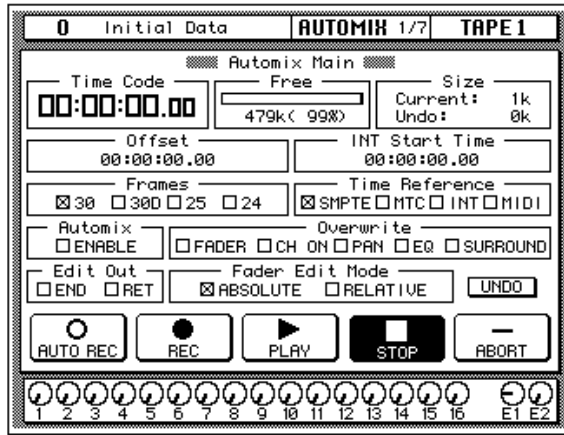

2. Select the “REC” (record) icon with the CURSOR buttons and press the (ENTER) button.

The “REC” icon will flash, indicating AUTOMIX RECORD READY status:

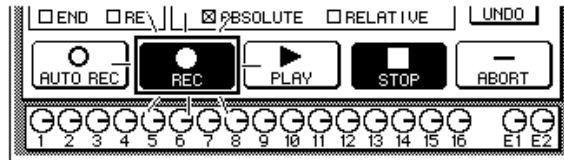

3. Press the (SEL) buttons for the tape return channels you want to record.

The LED inset in the selected channel [SEL] buttons flash indicating that they are armed for recording.

Note: Remember the scene memory you recalled has the [FLIP] function engaged. Therefore you should be selecting the [SEL] buttons in the row above the faders.

4. Start the device that is providing the timecode.

It should start from a location before the music starts.

Note: The 02R automix function will not respond correctly in cases where the source timecode starts at “23:59:30.00” and rolls over to “00:00:00.00”. The timecode must be continuous.

When timecode is received when the 02R is in AUTOMIX RECORD READY status, the “REC” icon is highlighted and automix recording will

begin. The timecode will be displayed in real-time in the “Time Code” field of the “Automix Main” page.

Note: *If the timecode is not being displayed correctly in the “Time Code” field, check the following:*

- *Are your cables connected between the timecode source device and the 02R correctly?*
 - *Is the timecode source device setup correctly to output timecode?*
-

5. While monitoring the recording, operate the faders and other controls for the selected channels.

When you are recording the automix events, you can only operate the controls, specifically the faders, of the selected channels.

Note: *The 02R tries to prevent accidental level changes by “freezing” the faders that have not been selected. To avoid damaging the unit, do not attempt to operate the faders of channels that have not been selected.*

Automix Recording Notes

- When you are recording pan or EQ changes you may find it more convenient to use the buttons and controls of the SELECTED CHANNEL block.
 - If you have selected more than one channel with the [SEL] buttons, the SELECTED CHANNEL controls can only adjust the channel that was selected last. The same applies for EQ and dynamics processor operations. Because of these restrictions, you may find it more convenient to work on your automix recording one channel at a time when editing EQ and pan data.
 - While you are recording automix events, you can select other 02R display functions, allowing you to adjust the parameters for multiple channels.
 - To record a recall operation from EQ, dynamics, or channel libraries, press the [SEL] button for the channel to be changed, then use the corresponding display function to perform the recall operation. To record a recall operation from the effect libraries, use the [AUX 7] or [AUX 8] button to access the effect libraries.
-

6. When you have completed recording the automix session, use the CURSOR buttons to select the “STOP” icon and press the (ENTER) button.

You may find it faster and more convenient to stop the automix recording session by stopping the device that is providing the timecode. In this case, the effect is the same as if you selected the STOP function on the 02R:

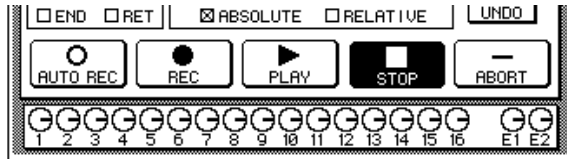

The “REC” icon will change to normal and the “STOP” icon is highlighted. The events recorded during the automix session will be written to the current automix memory.

You can also discard the events recorded during the automix session by selecting the “UNDO” icon with the CURSOR buttons and pressing the [ENTER] button.

You can stop the automix recording session by selecting the “ABORT” icon with the CURSOR buttons and pressing the [ENTER] button. However, the events recorded during the automix session will be discarded.

Note: *The ABORT function must be used before an automix recording has stopped. Once the recording has stopped, the automix data will be updated and a new current mix is created. At this point after stopping an automix recording, the UNDO function can be used to retrieve the previous automix data.*

In most cases, punch-in edits or using the event editors can correct minor errors.

7. Stop the device that is providing the timecode.

Editing Automix Events

Overwriting Events

You can overwrite the events that have been recorded into the current automix. You can alter events on an already recorded channel or you can record new events onto another channel. For example, you may first record the faders for the rhythm section to the automix and then overwrite the fader operations for the lead parts and vocals.



1. Use the (AUTOMIX) button to locate the AUTOMIX 1/7 page.

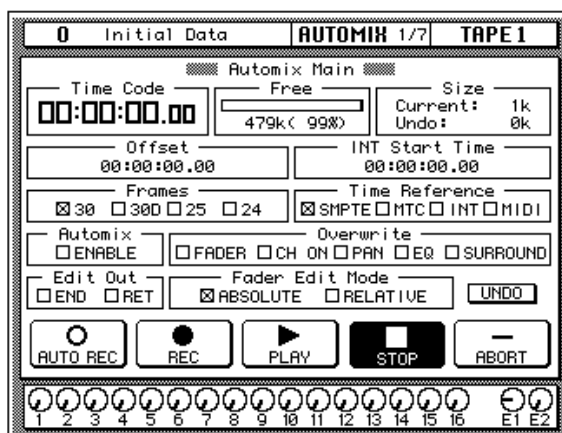

WARNING! Be careful that previously recorded events are not accidentally overwritten when you make these selections.

2. Use the CURSOR buttons to select the desired "Overwrite" items and press the (ENTER) button.

Note: If you double-click the [ENTER] button on a selected "Overwrite" item, only that item will be selected and the other items will be switched off.

3. Select the "REC" icon with the CURSOR buttons and press the (ENTER) button.

The "REC" icon will flash.

4. Press the (SEL) buttons for the tape return channels you want to overwrite.

It is very important that you be careful when you select the type of events and channels that will be overwritten. If you select the same channel and the same type of event as the last session, the previously recorded events will be deleted the moment the automix recording begins.

5. Start the device that is providing the timecode.

It should have been rewound and again start from a location before the music starts. The previously recorded automix will playback.

6. While monitoring the recording, adjust the parameters you want to overwrite.
7. When you have completed the automix overwriting session, use the CURSOR buttons to select the “STOP” icon and press the (ENTER) button.

You may find it faster and more convenient to stop the automix recording session by stopping the device that is providing the timecode. The effect is the same as if you selected the STOP function on the 02R.

The “REC” icon will change to normal and the “STOP” icon is highlighted. The events recorded during the overwriting session will be added to the current automix memory.

8. Stop the device that is providing the timecode.

Punch-in Automix Data

If you made a mistake in just one portion of the automix, you can replace the erroneous data with a punch-in.



1. Use the (AUTOMIX) button to locate the AUTOMIX 1/7 page.
2. Use the CURSOR buttons to select the desired “Overwrite” items and press the (ENTER) button.
3. Select the “REC” icon with the CURSOR buttons and press the (ENTER) button.

The “REC” icon will flash.

4. Start the device that is providing the timecode.

It should have been rewound and again start from a location before the music starts. The previously recorded automix will playback, however, because you have not selected any channels, the 02R will remain in AUTOMIX RECORD READY status.

-
5. **Monitor the recording. At the punch-in location, press the (SEL) buttons for the tape return channels you want to fix.**

Recording will begin from the location where you pressed the [SEL] button.

Note: *From this point, new events will be recorded and previously existing events will be deleted.*

6. **While monitoring the recording, adjust the parameters you want to fix.**
7. **When you have finished adjusting the parameters, press the (SEL) buttons again.**

The 02R will return to AUTOMIX RECORD READY status.

Note: *If you do not adjust any parameters between the punch-in and punch-out points, any events of the selected type that were previously recorded there will have been deleted.*

8. **Use the CURSOR buttons to select the “STOP” icon and press the (ENTER) button.**

You may find it faster and more convenient to stop the automix recording session by stopping the device that is providing the timecode. The effect is the same as if you selected the STOP function on the 02R.

The “REC” icon will change to normal and the “STOP” icon is highlighted.

9. **Stop the device that is providing the timecode.**

Editing Fader/Encoder Movements

If you are replacing erroneous fader/encoder data using a punch-in, the 02R allows you to monitor the differences on the Fader Edit page.



1. **Use the (AUTOMIX) button to locate the AUTOMIX 1/7 page.**
2. **Use the CURSOR buttons to select the “FADER—Overwrite” item and press the (ENTER) button.**

3. Use the (AUTOMIX) button to locate the AUTOMIX 3/7 page.

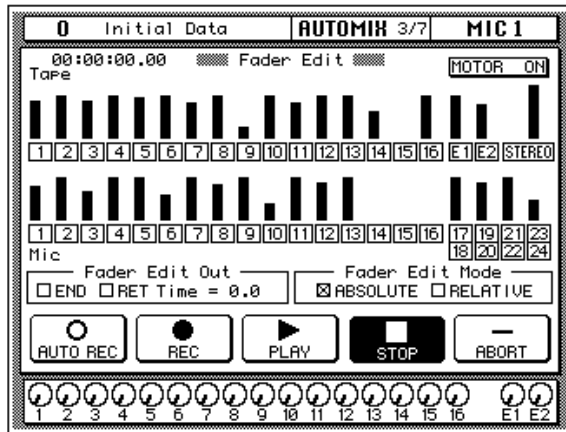

This display allows you to watch the fader movements as dynamic bargraphs. Several features make this display convenient to use while you perform detailed fader/encoder edits.

4. Use the CURSOR buttons to select “Fader Edit Out—RET” and press (ENTER) to change its value.

If the RET check box is not selected, you may want to move the fader back to its previously recorded level before you punch-out. If the RET check box is selected, the fader will automatically return to the previously recorded level when you punch out. The time it takes to return to the previous level is controlled by the “Time” field.

5. Select the “REC” icon with the CURSOR buttons and press the (ENTER) button.

The “REC” icon will flash.

6. Start the device that is providing the timecode.

The 02R will remain in AUTOMIX RECORD READY status.

7. Monitor the recording. At the punch-in location, press the (SEL) button for the tape return channel you want to edit.

Recording will begin from where you pressed the [SEL] button.

8. While monitoring the recording, adjust the fader you want to edit.

As you operate the fader, the display shows the previously recorded position as well as the new position. An arrow in the display indicates the

direction the fader has to be moved to return to the previously recorded position:

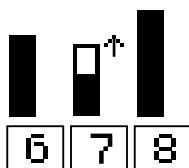

If the fader is moved to a position lower than the previously recorded position

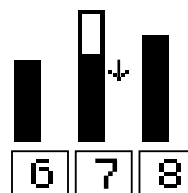

If the fader is moved to a position higher than the previously recorded position

9. When you have finished adjusting the fader, press the (SEL) button again.

The 02R will return to AUTOMIX RECORD READY status.

10. Use the CURSOR buttons to select the “STOP” icon and press the (ENTER) button.

You may find it faster and more convenient to stop the automix recording session by stopping the device that is providing the timecode. The effect is the same as if you selected the STOP function on the 02R.

11. Stop the device that is providing the timecode.

Off-line Automix Editing

Editing Scene and Library Recall Events

The Event Edit (Scene/Lib.) page, shown below, allows you to duplicate and delete mix scene and library recall events, and insert new events. Timecode addresses can be captured on-the-fly, and new events inserted at the captured points. The Locate function provides a speedy way to locate events in a complex automix.



1. Use the (AUTOMIX) button to locate the AUTOMIX 5/7 page.

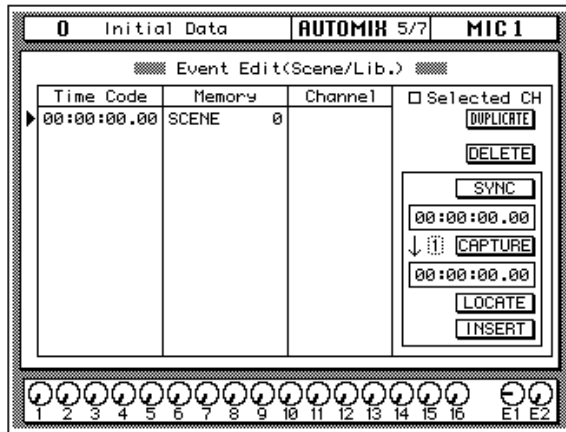

Mix scene recall events and library program recall events are listed in the Time Code, Memory, and Channel columns. Events can be moved by editing the timecode addresses, and events are resorted automatically. In the Memory column, event type and memory number can be edited. In the Channel column, the channel number for EQ, dynamics, effects, and channel library events can be edited. Mix scene events do not have a Channel value.

2. Use the CURSOR buttons to move up or down the event list, and the encoder wheel to edit values.

You can edit the following data:

- Time Code—the location of the event as a timecode value. The 02R sorts events by their timecode value.
- Memory—the type of the event. You can select from the following events:
 - SCENE—scene memory recall. The number indicates the scene number (from 0 to 96).
 - EQ.Lib.—EQ library recall. The number indicates the EQ library number (from 1 to 128).
 - DY.Lib.—dynamics library recall. The number indicates the dynamics library number (from 1 to 128).

- EF.Lib.—effect library recall. The number indicates the effect library number (from 1 to 128).
- CH.Lib.—channel library recall. The number indicates the channel library number (from 1 to 64).
- Channel—the channel that the recall applies to. For scene memory recall, this field is blank.

For timecode, you can independently adjust the hours, minutes, seconds, and frames values.

3. Use the CURSOR buttons to select the DUPLICATE icon and press the (ENTER) button to duplicate the selected event.

The selected event can be duplicated or deleted using the DUPLICATE and DELETE icons. When the Selected CH parameter is checked, only events corresponding to the selected channel are listed, useful for editing an automix consisting of many events.

4. Use the CURSOR buttons to select the DELETE icon and press (ENTER) to delete the selected event.

When the SYNC icon is pressed, events occurring around the current timecode address are displayed. The timecode counter below the SYNC icon displays the incoming timecode. When the CAPTURE icon below that is pressed, the current timecode address is captured and displayed in the window below. Up to eight timecode addresses can be captured, and they are stored when the 02R is turned off. The parameter next to the CAPTURE icon is used to select the addresses. When the LOCATE icon is pressed, events occurring about the captured timecode address are displayed. When the INSERT icon is pressed, a new scene recall event is inserted at the captured timecode address. The new event can be edited as required.

Editing Channel On, Pan, & Fader events

The Event Edit (CH ON, PAN, FADER) page, shown below, allows you edit channel on/off, pan, and fader events, and duplicate, delete, and insert new events. Timecode addresses can be captured on-the-fly, and new events inserted at the captured points. The Locate function provides a speedy way to locate events in a complex automix.



1. Use the (AUTOMIX) button to locate the AUTOMIX 6/7 page.

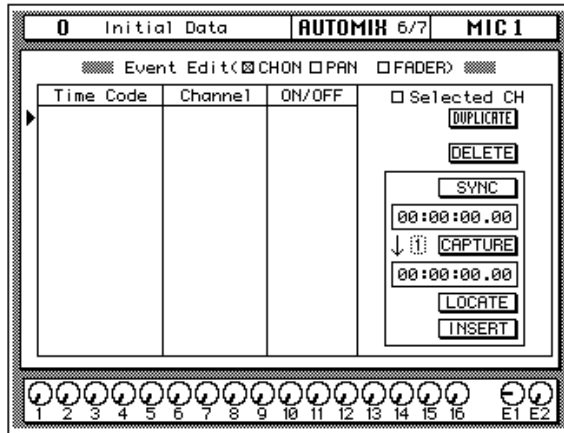

Channel on/off, pan, and fader events are listed in the Time Code, and Channel columns. Events can be moved by editing the timecode addresses, and events are resorted automatically. In the Channel column, the channel number can be edited. The value in the third column depends on the event type selected using the CH ON (ON/OFF), PAN (L-C-R), and FADER (dB/SEC) check boxes.

2. Use the CURSOR buttons to move up or down the event list, and the encoder wheel to edit values.
3. Use the CURSOR buttons to select the DUPLICATE icon and press the (ENTER) button to duplicate an event.

The selected event can be duplicated or deleted using the DUPLICATE and DELETE icons. When the Selected CH parameter is checked, only events corresponding to the selected channel are listed, useful for editing an automix consisting of many events.

4. Use the CURSOR buttons to select the DELETE icon and press (ENTER) to delete the current event.

When the SYNC icon is pressed, events occurring around the current timecode address are displayed. The timecode counter below the SYNC icon displays the incoming timecode. When the CAPTURE icon below that is pressed, the current timecode addresses is captured and displayed in the window below. Up to eight timecode addresses can be captured, and they are stored when the 02R is turned off. The parameter next to the CAPTURE icon is used to select the addresses. When the LOCATE icon is pressed, events occurring around the captured timecode address are displayed.

When the INSERT icon is pressed, a new event is inserted at the captured timecode address. The type of event depends on which of the CH ON, PAN, FADER check boxes is checked. The new event can be edited as required.

Erasing Events

The Event Copy page, shown below, allows you to copy, move, erase and trim the level of automix events. In this tutorial just the Erase function is used. See “Event Copy” on page 153 of the *User’s Guide* for information about the other functions.



1. Use the (AUTOMIX) button to locate the AUTOMIX 4/7 page.

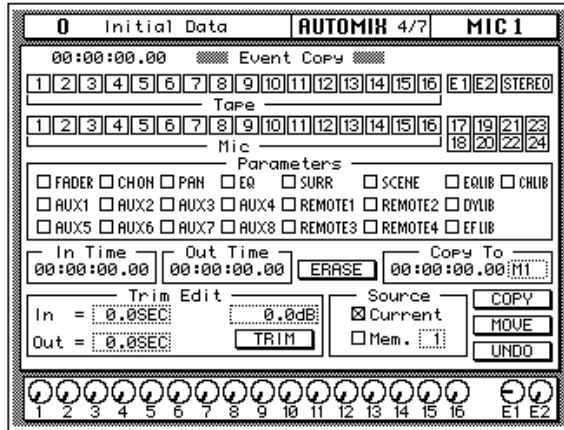

The channel icons are used to select the channels whose automix data is to be edited.

2. Use the CURSOR buttons to select the channel check boxes, and press the (ENTER) button to check them.

The Parameter check boxes are used to select parameters for editing, and multiple parameters can be selected. The parameters are:

- FADER—Channel input and output level events (faders/rotary encoders)
- CH ON—Channel on/off (mute) events
- PAN—pan events
- EQ—EQ events
- SCENE—Scene memory recall events
- AUX 1–8—Channel aux send events (faders/rotary encoders)
- REMOTE 1–4—MIDI Remote events
- SURR—Surround pan events
- EQLIB—EQ library program recall events
- CHLIB—Channel library program recall events
- DYLIB—Dynamics library program recall events
- EFLIB—Effects library program recall events

3. Use the CURSOR buttons to select the parameter check boxes, and press the (ENTER) button to check them.

4. Use the CURSOR buttons and encoder wheel to set the In Time.
5. Use the CURSOR buttons and encoder wheel to set the Out Time.

The Extract function allows you to delete the selected parameters from the selected channels between the In Time and Out Time points.

6. Use the CURSOR buttons to select the “ERASE” icon and press the (ENTER) button.

A confirmation dialog box appears.

7. Select EXECUTE and press the (ENTER) button.

The events are deleted. If you change your mind, you can restore the deleted events using the Undo function. You can undo only the last operation.

Using the Automix Library

Storing an Automix

An automix can be stored in one of the 16 automix memories available on the Memory Management page shown below.



1. Use the (AUTOMIX) button to locate the AUTOMIX 2/7 page.

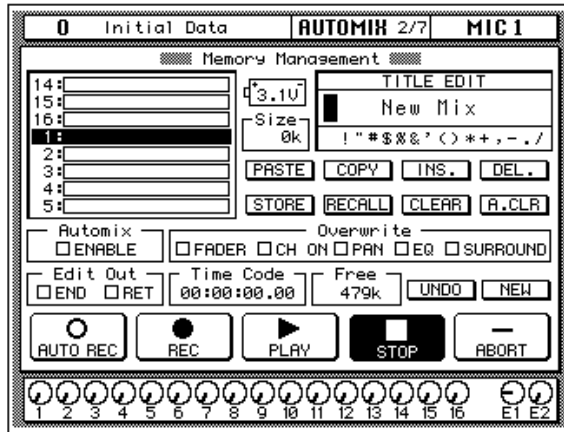

2. Use the CURSOR buttons to select the TITLE EDIT box.
3. Use the CURSOR buttons to move the cursor within the title, and the encoder wheel to select the characters.

Automix titles can be up to 16 characters long, and the following characters are available.

	!	“	#	\$	%	&	'	()	*	+	,	-	.	/
0	1	2	3	4	5	6	7	8	9	:	;	<	=	>	?
@	A	B	C	D	E	F	G	H	I	J	K	L	M	N	O
P	Q	R	S	T	U	V	W	X	Y	Z	[\]	^	_
`	a	b	c	d	e	f	g	h	i	j	k	l	m	n	o
p	q	r	s	t	u	v	w	x	y	z	{		}	~	

You can select the “INS.” icon to insert a space at the cursor position in the TITLE EDIT box. Select the icon with the CURSOR buttons and press the [ENTER] button. The “DEL.” icon is used to delete the character at the cursor position in the TITLE EDIT box.

Note: The “COPY” and “PASTE” icons allow you to select the title from another automix program and paste it into your program for subsequent editing. These icons only copy the title. See “AUTOMIX Name Edit Functions” on page 149 of the User’s Guide.

4. Use the CURSOR buttons to select the STORE icon. Use the encoder wheel to select an automix and press the (ENTER) button.

The 02R will display a popup confirmation request message asking if you want to store your settings in the selected automix program. The popup has two icons: "CANCEL" and "EXECUTE".

CANCEL is the default. To cancel the STORE operation, either press the [ENTER] button or wait about 10 seconds—the STORE operation will be automatically cancelled.

To store your settings, use the CURSOR buttons to select the "EXECUTE" icon and press the [ENTER] button. The automix is stored.

Automix Memory

Automix memory is shared between the current automix and the stored automixes. This means that a "Memory Full" error message could appear even though there are empty automix locations. A complex automix, containing many events, may exceed the memory capacity. If this occurs, backup and delete any unused automixes and attempt the STORE operation again.

The default capacity of the 02R automix memory is 480K. You can expand this to 1.5 MB or 2.5 MB by installing the optional ME4M memory expansion kits.

Recalling an Automix



1. Use the (AUTOMIX) button to locate the AUTOMIX 2/7 page.

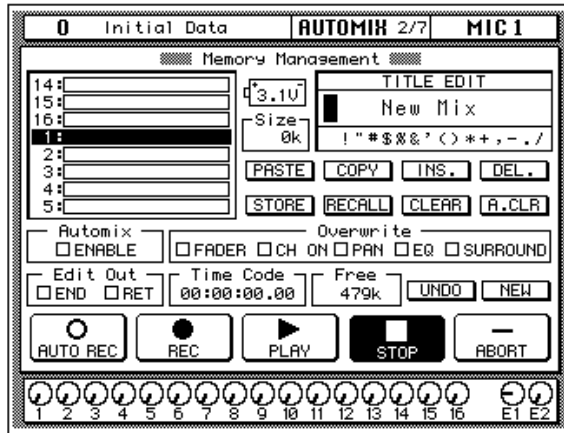

2. Use the CURSOR buttons to select the RECALL icon. Use the encoder wheel to select an automix.

The 02R will scroll through the available automixes. The program that is highlighted will be recalled when you press the [ENTER] button.

3. Press the (ENTER) button.

The 02R will display a popup confirmation request message asking if you want to recall selected automix program. The popup has two icons: “CANCEL” and “EXECUTE”.

CANCEL is the default. To cancel the RECALL operation, either press the [ENTER] button or wait about 10 seconds—the RECALL operation will be automatically cancelled.

To recall the automix, use the CURSOR buttons to select the “EXECUTE” icon and press the [ENTER] button. The automix program is recalled.

Note: When you recall an automix program, you are overwriting the current automix. Make sure that you have backed up or stored the current automix just in case.

YOU SHOULD ALWAYS BE CAREFUL WHEN THE 02R DISPLAYS ITS CONFIRMATION POPUP MESSAGE!

Index

A

Attenuation 22
 Audio quality 2
 Automix
 about 7
 editing 76
 editing faders and encoders 78
 editing scene and library recalls 81
 extracting events 85
 frame rate 69
 making new automixes 70
 memories 68
 memory expansion 88
 off-line editing 81
 overwriting 76
 punch-in 77
 real-time operation 69
 recalling automixes 89
 recording 73
 recording notes 74
 setup 69
 storing automixes 87
 time reference 69
 titling 87
 what is it? 68
 Aux sends
 about 42
 AUX buttons 42
 selected channel AUX controls 42
 setting send levels 43

B

Basic setup 15

C

Compander 54
 Compressor 54
 Converters 11
 Crystal clarity 2

D

Deleting events 85
 Digital audio, benefits 10
 Display 8
 DSP 2
 Ducking 54
 Dynamics
 about 9
 compander 54
 compressor 54
 ducking 54
 editing programs 58
 expander 54
 gate 54
 library 57
 recalling programs 57
 stereo output 55
 storing programs 59
 titling programs 59

E

Editing
 automix events 76
 dynamics programs 58
 effects 50
 faders and encoders 78
 on/off, pan, and fader events 83
 scene and library recalls 81

Effects

 about 9
 editing 50
 recalling programs 49
 returns 47
 send levels 46
 storing user programs 51
 titling 51
 using 46

EQ

 about 10
 applying 24
 bandwidth 28
 frequency 27
 gain 25
 library 30
 on/off 24
 Q 28
 recalling programs 30

 resetting 29
 storing programs 32
 titling programs 32
 undo 31

Erasing events 85
 Expander 54

F

Faders 9
 editing events 83
 level setting 20
 Features 5
 Frame rate, automix 69
 Frequency, EQ 27

G

Gain control, setting 21
 Ganging pans 39
 Gate 54

I

Initial data 62
 Input level, setting 20
 Installation 3
 Interface, about 8
 Internal effects, about 9
 I/O cards 2

L

LCD 8
 Library
 dynamics 57
 effects 49
 EQ 30

M

Memory expansion kit 88
 MIDI Clock 69
 Monitoring 45
 Monitor source, setting 20
 Motorized faders 9
 MTC 69
 Muting channels 23

N

Naming *See* Titling.
Noise gate 54

O

Off-line editing 81
ON buttons 23
On/off event editing 83
Options 6
Overwriting automix events 76

P

Pad 21
Pan
 about 38
 editing events 83
 ganging 39
 setting 38
Parametric EQ, about 10
Peak hold 22
Phase 22
Powering on/off 16
Programs
 dynamics 57
 effects 49
 EQ 30
Punch-in, automix 77

Q

Q, EQ 28

R

Rear panel 4
Recalling
 automixes 89
 dynamics programs 57
 effects programs 49
 EQ programs 30
 scene memories 65
Resetting the EQ 29
Returns, effects 47
RISC technology 3
Routing
 about 35

selecting 37
using 36

S

Scene memories
 about 7
 editing recall events 81
 indicator 23
 recalling 65
 recalling scene 0 17
 storing 62
 titling 63

Scene memory buttons 62

Scene 0 17

Setting

 aux send levels 43
 effects send levels 46
 EQ 24
 fader levels 20
 gain controls 21
 input levels 20
 monitor source 20
 pan 38

SMPTE 69

Snapshots 62

Sonic performance 2

Storing

 automixes 87
 dynamics programs 59
 effects programs 51
 EQ programs 32
 scene memories 62

Switching the 02R on/off 16

T

Time reference, automix 69

Titling

 automixes 87
 dynamics programs 59
 effects programs 51
 EQ programs 32
 scene memories 63

Top panel 4

turning channels on/off 23

Turning the 02R on/off 16

U

Undo

 EQ recall 31

User guides, about 3

User interface, about 8

W

Wordclock 16

Z

02R

 features 5

 installation 3

 options 6

 rear panel 4

 top panel 4

O2R

DIGITAL RECORDING CONSOLE

Version 2

User's Guide

Contents at a Glance

1	Controls and Connections.....	1
2	User Interface	17
3	Mixing and Monitoring.....	25
4	MIXING Display Functions.....	31
5	Surround Pan.....	63
6	Dynamics	75
7	Auxiliary Channels.....	97
8	Internal Effects	103
9	Scene Memories.....	127
10	Automix.....	137
11	MIDI	157
12	Groups and Pairs	181
13	Digital I/O, Setup, and Utilities.....	187
14	Installing Options	217
15	Specifications	239
16	Glossary.....	289
	Index	297

Contents

1	Controls and Connections.	1
	Front Panel	2
	Rear Panel.	11
	Block Diagram	15
2	User Interface	17
	About the User Interface	18
	DISPLAY ACCESS Buttons	18
	Display	20
	CURSOR Buttons	21
	Encoder Wheel.	21
	ENTER Button	21
	SCENE MEMORY Buttons	21
	Display Functions	22
	SELECTED CHANNEL Controls	23
3	Mixing and Monitoring.	25
	Analog Inputs	26
	Phantom Power.	26
	Pad.	27
	GAIN Controls.	27
	SEL Buttons	27
	ON Buttons.	28
	Faders	28
	Analog Outputs.	29
	Monitor Selector Switches	29
	Monitor Level Controls	30
4	MIXING Display Functions	31
	Phase and Attenuation.	32
	Delay	34
	Pan and Balance.	36
	Pan Gang	37
	Stereo Width	37
	PAN controls	38
	Routing	39
	ROUTING buttons	40

	Metering	41
	View	44
	Channel Library	48
	EQ	51
	EQ controls	53
	EQ Programs	54
	EQ Library	55
	Preset EQ Program Parameters	58
5	Surround Pan.	63
	About Surround Pan.	64
	Selecting a Surround Mode	65
	Panning Sounds Freely	67
	Panning Sounds Using the Trajectories	69
	Linking Channels for Surround Pan	72
	CSR (Center:Side Ratio)	73
6	Dynamics	75
	Dynamics Processors	76
	Preset Dynamics Programs	76
	Compressor	77
	Expander	79
	Compander	80
	Gate and Ducking	81
	DYNAMICS Display Function	83
	Patching in a Processor	84
	Dynamics Processor Meters	85
	KEY IN and LINK Indicators	86
	Dynamics Library	87
	Preset Dynamics Program Parameters	90
7	Auxiliary Channels	97
	About the 02R Auxiliaries	98
	The AUX Buttons	99
	Stereo Input Channels	101
	AUX [ON] Button	101
	AUX Pre or Post	101
	Monitor Mix	102

8	Internal Effects	103
	About Effects	104
	Preset Effects Programs	105
	AUX 7 and AUX 8	106
	Effects	108
	Effects Library	109
	Preset Effects Program Parameters	112
9	Scene Memories	127
	What are Scene Memories?	128
	What is Stored in a Scene Memory?	129
	What is the Edit Buffer?	129
	Initial Data and UNDO Memory	129
	Storing Mix Scenes	130
	Naming a Scene Memory	131
	Recalling Scene Memories	134
	Fader Recall Safe	135
	Fade Time	136
10	Automix	137
	What is the Automix Function?	138
	What is Timecode?	140
	Automix Function	143
	Automix Main	144
	Memory Management	148
	Fader Edit	151
	Event Copy	153
	Event Edit (Scene/Lib.)	155
	Event Edit (CH ON, PAN, FADER)	156
11	MIDI	157
	MIDI and the 02R	158
	Setup	159
	Program Change Assign	160
	Bulk Dump/Request	161
	Fader Start	163
	MIDI Control Change Assign	164
	MIDI Remote	165

12	Groups and Pairs	181
	Grouping Faders	182
	Grouping Mutes	183
	Pairing Channels	184
	MS Decoding	186
13	Digital I/O, Setup, and Utilities	187
	Word Clock Select	188
	Input Signal Select	190
	Cascade Configuration	191
	Dither	193
	Slot Output Select	194
	Solo	196
	Preferences	198
	Aux Output Select	203
	24-bit Recording	204
	Input Patching	206
	Oscillator	209
	Emphasis Monitor	210
	Channel Status Monitor	211
	Battery Check	213
	Communication Speed	214
	02R System Initialization	215
14	Installing Options	217
	02R Options	218
	Installing 02R Options	221
	Analog I/O Card—AD/DA (CD8-AD)	224
	Analog I/O Card—A/D (CD8-AD-S)	224
	Digital I/O Card—AES/EBU (CD8-AE/CD8-AE-S)	225
	Digital I/O Card—ADAT (CD8-AT)	227
	Digital Cascade Kit (CD8-CS)	229
	Digital I/O Card—TDIF-1 (CD8-TDII)	234
	Peak Meter Bridge (MB02)	236
15	Specifications	239
	General Specifications	240
	Input Specifications	246
	Output Specifications	247
	Digital Input and Output Specifications	247

Dimensions	248
Options	249
Troubleshooting	250
Error Messages	251
Appendix: MIDI	255
MIDI Data Format	262
Parameter Change and Request Format	265
Bulk Dump and Request Format	273
16 Glossary	289
References and Further Reading	295
Index	297

1

Controls and Connections

In this chapter...

Front Panel 2

Rear Panel..... 11

Block Diagram 15



Front Panel

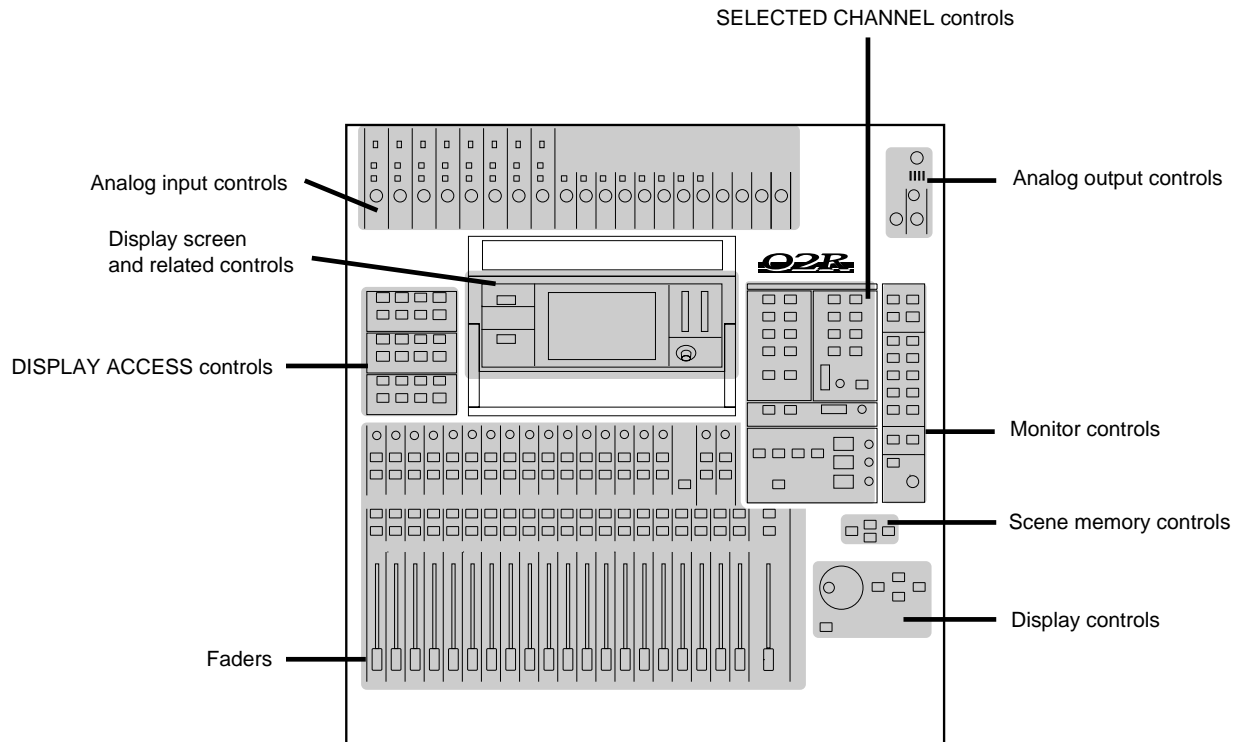

Analog input controls

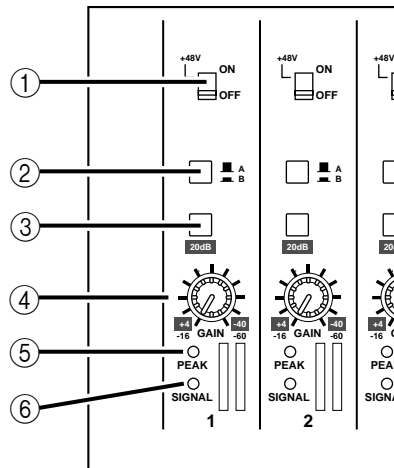

1. Phantom switches (channels 1 to 8)

These switches turn the +48 V DC phantom power ON and OFF for the XLR-3-31 connectors.

2. A/B switches (channels 1 to 8)

These switches select between the XLR-3-31 connectors and the phone connectors.

3. 20 dB (pad) switches (channels 1 to 16)

These switches attenuate the input signal by 20 dB.

4. GAIN controls

These controls adjust the gain of the input preamp.

The analog input controls are not controlled or stored by the 02R automix and scene memory functions. To allow easy recall of the gain setting, the controls are detented.

5. PEAK LED

This red LED illuminates when the input signal exceeds 3 dB below clipping.

It is acceptable if this LED illuminates occasionally. However, if it is continuously illuminated, the input preamp is being overloaded and clipping distortion will result.

6. SIGNAL LED

This green LED illuminates when the input signal exceeds 10 dB below nominal.

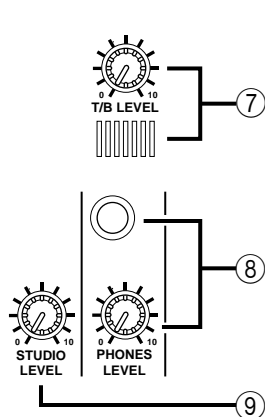

Analog output controls

7. **T/B LEVEL control and microphone**
This control sets the volume level of the built-in talkback microphone.
8. **STUDIO LEVEL control**
This control sets the level of the signal sent to the STUDIO MONITOR OUTPUT connectors.
9. **PHONES LEVEL control and connector**
This control sets the level of signal output to a pair of stereo headphones plugged into the connector.

DISPLAY ACCESS controls

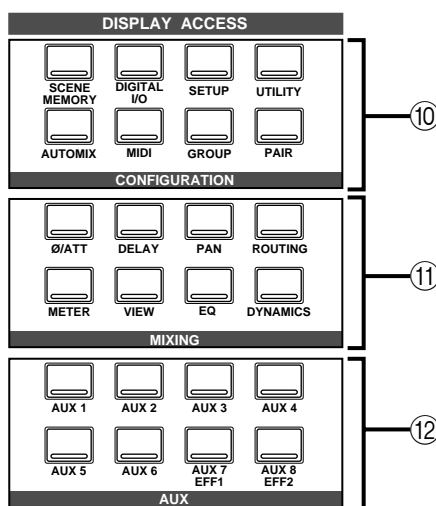

10. **CONFIGURATION buttons**
These buttons access the corresponding Display function.

Button	Description
SCENE MEMORY	Store and recall mix scenes.
DIGITAL I/O	Define the digital interconnections and word clock source, cascade parameters, and dither characteristics.
SETUP	Set SOLO status and preferences
UTILITY	Define oscillator, check battery status.
AUTOMIX	Store and recall automix programs.
MIDI	Set the MIDI channels and tables. Control bulk data transfers.
GROUP	Set up the fader groups.
PAIR	Set up channel pairs.

11. MIXING buttons

These buttons access the corresponding Display function.

Button	Description
Ø/ATT	Set phase and attenuation.
DELAY	Set the channel delay.
PAN	Set the pan position.
ROUTING	Set the channel routing.
METER	Meter the levels from the individual input channels, the tape and effect return channels, the 8 main busses, and the 8 auxiliary busses.
VIEW	View and set all the parameters for the selected channel and access the channel library.
EQ	Set the equalization and access the EQ library.
DYNAMICS	Set the dynamics and access the dynamics library.

12. AUX buttons

These buttons access the corresponding Display function.

Button	Description
AUX 1 to 6	Set the channel levels to the auxiliary busses.
AUX 7 and 8	Set the channel levels to the auxiliary busses and set the effect parameters.

Display and related controls

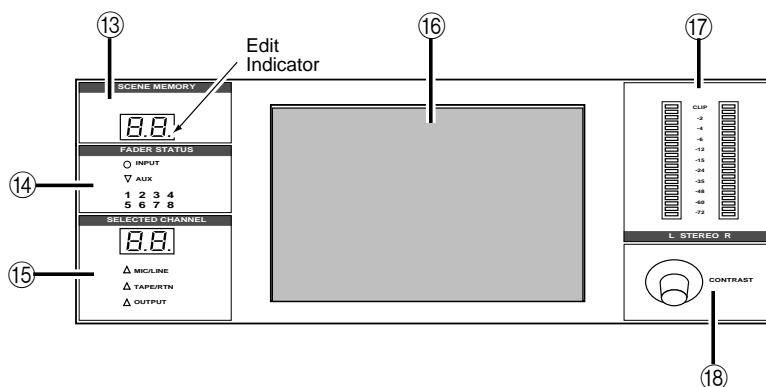

13. SCENE MEMORY indicator

This 2-digit (7-segment) LED shows the currently selected Scene Memory program. It also contains the Edit Indicator, which will start flashing when the current mix scene is first adjusted.

14. FADER STATUS indicators

These LED indicators show the status of the faders. When you select the AUX buttons ([AUX 1] through [AUX 8]), the AUX LED will illuminate to indicate the faders are used to set the auxiliary send levels. The currently selected AUX button is also indicated here.

Normally, the INPUT LED is illuminated.

15. SELECTED CHANNEL indicators

The 2-digit (7-segment) LED shows the currently selected channel number for the SELECTED CHANNEL controls. The three LEDs below indicate the status of the selected channel: MIC/LINE, TAPE/RTN, or OUTPUT.

16. Graphical display

This is the 320 × 240 pixel, CFL-backlight, graphical display. It displays the system functions and their parameter values both graphically and numerically.

17. Stereo output level meters

These stereo meters consist of 21-elements per channel.

18. Contrast control

This control adjusts the contrast of the graphical display.

SELECTED CHANNEL controls

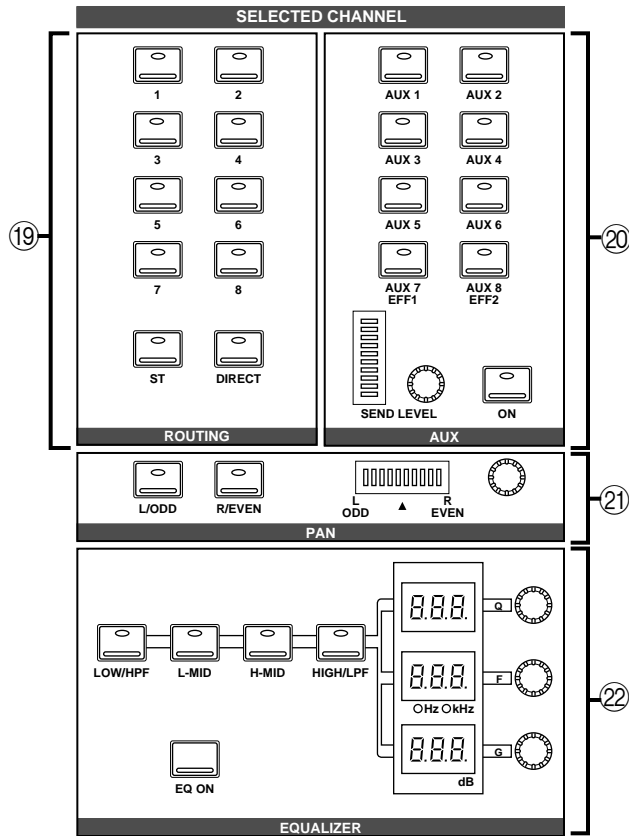

19. ROUTING buttons

These buttons set the routing for the currently selected channel.

20. AUX buttons and controls

These buttons and controls set the auxiliary send channel and level for the currently selected channel.

21. PAN buttons and controls

These buttons and controls set the pan position for the currently selected channel.

22. EQ buttons and controls

These buttons and controls set the equalization for the currently selected channel.

Monitor controls

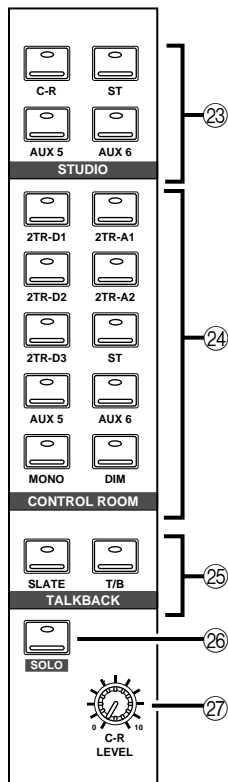

23. STUDIO buttons

These buttons select the monitor signal sent to the STUDIO MONITOR OUTPUT connectors.

24. CONTROL ROOM buttons

These buttons select the monitor signal sent to the C-R MONITOR OUT connectors.

25. TALKBACK buttons

These buttons allow the control room to talk to the studio and to SLATE control room information to the output buses.

26. SOLO button

This button activates the SOLO bus. Use the ON buttons to select a channel to monitor.

27. C-R LEVEL

This control sets the level of the C-R MONITOR OUT connectors.

Faders

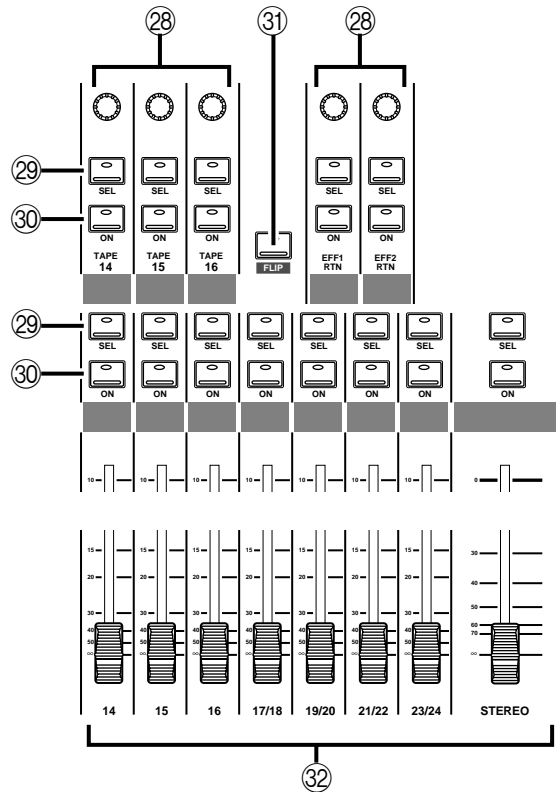

28. Tape and Effect return controls

These continuously rotary controls set the level of the tape and effect returns. The current level of a return channel is shown by the corresponding icon at the bottom of the display.

29. SEL buttons

These buttons select the individual channels. When you press one of the SEL buttons, the LED in the center of the button is illuminated.

30. ON buttons

These buttons switch the selected channel ON or OFF. When a channel is ON, the LED in the center of the button is illuminated.

When you press the SOLO button (engage the SOLO function), these buttons are used to select the monitor channels. The LEDs inset in the buttons are switched off. Press the ON buttons to select channels to send to the SOLO bus. When you press the SOLO button again (cancel the SOLO function), the prior channel status is restored and the appropriate LEDs are switched back on.

31. FLIP button

This button interchanges the functions of MIC/LINE channels 1 to 16 and TAPE RETURN channels 1 to 16. This allows you to set the tape return levels with the Faders rather than the Tape Return controls.

Holding down the FLIP button for one second activates the MIDI Remote function. See “MIDI Remote” on page 165 of the *User’s Guide*.

32. Faders

These 100mm motorized faders set the channel level for the corresponding channel.

The faders will position themselves automatically when a scene memory snapshot is recalled, a number of faders are grouped or paired, or an automix is played back.

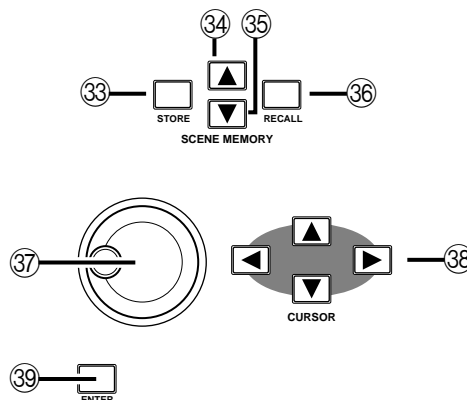
Scene memory controls**33. STORE button**

This button stores the current mixer settings into the current scene memory location.

34. Increment button

This button selects the next scene memory.

35. Decrement button

This button selects the previous scene memory.

36. RECALL button

This button recalls the current scene memory. All mixer settings are restored to the positions recorded in the scene memory snapshot.

Display controls

37. Encoder wheel

This control adjusts the value of the currently selected parameter. Rotate it clockwise to increase the value, and counterclockwise to decrease the value.

38. CURSOR buttons

These buttons select the parameters and options on the display pages.

39. ENTER button

This button either confirms a parameter setting made with the Encoder wheel or it sets a parameter that only has two possible values.

Rear Panel

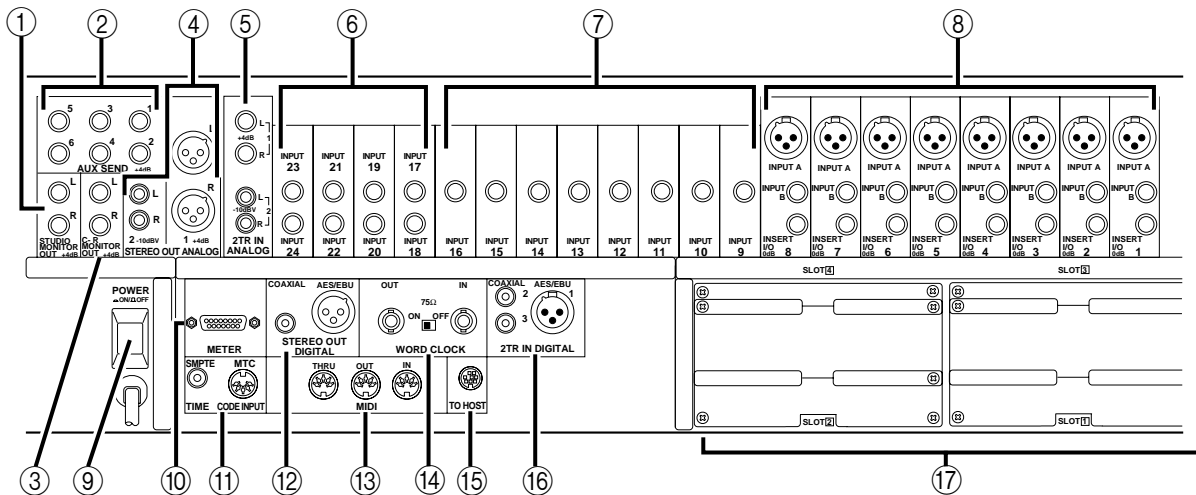

1. STUDIO MONITOR OUT connectors

These are balanced 1/4" phone jacks with a +4 dB nominal output level. They output the monitor signals for the studio, and can be connected to the inputs on a monitor or headphone amplifier.

The monitor signal source is determined by the STUDIO buttons. The output level is set using the STUDIO LEVEL control.

2. AUX SEND connectors

These are unbalanced 1/4" phone jacks with a +4 dB nominal output level. They output the signals from AUX buses 1 to 6, and can be used to feed external effects processors, foldback amplifiers, or multitrack recording equipment.

3. C-R MONITOR OUT connectors

These are balanced 1/4" phone connectors with a +4 dB nominal output level. They are wired TRS. They output the signal selected by the CONTROL ROOM buttons.

4. STEREO OUT ANALOG (1 and 2) connectors

STEREO OUT (1) are balanced XLR-3-32 type connectors with a +4 dB nominal output level. STEREO OUT (2) are unbalanced phono jacks with a -10 dBV nominal output level.

These connectors output the main stereo signals for recording, and can be connected to cassette and other analog recorders.

5. 2TR IN ANALOG (1 and 2) connectors

2TR IN (1) are balanced phone jacks with a +4 dB nominal input level. 2TR IN (2) are unbalanced phono jacks with a -10 dBV nominal input level.

Signals input here are fed through to the CONTROL ROOM buttons (24) and are monitored in the control room or the studio. The outputs of a 2-track master recorder can be connected here for confidence monitoring and playback.

6. Stereo input channels (17 to 24)

These are pairs of balanced 1/4" phone jacks with a -40 to +4 dB nominal input level. You can connect the return from a stereo effects unit to these input channels.

The signals from 2TR IN DIGITAL (1) can be routed to channels 17/18 and the signals from 2TR IN DIGITAL (2) can be routed to channels 19/20.

7. Input channels (9 to 16)

These are balanced phone jack connectors. The nominal input level is -60 dB to +4 dB. Wiring is sleeve-ground, tip-hot (+), and ring-cold (-). They can be used with balanced or unbalanced plugs.

8. Input channels (1 to 8)

INPUT A (1 to 8) are balanced XLR-3-31 type connectors. The nominal input level is -60 dB to +4 dB. They are wired according to the IEC 268 standard: Pin 1-ground, pin 2-hot (+), and pin 3-cold (-). Phantom powering is available for condenser type microphones.

Note: *Make sure that the balanced devices you plug into the input connectors also use pin 2-hot, pin 3-cold wiring. If they are wired differently, undesirable phase shifts may occur. However, you can invert the phase of an input signal with the 02R.*

INPUT B (1 to 8) are balanced phone jack connectors. The nominal input level is -60 dB to +4 dB. Wiring is sleeve-ground, tip-hot (+), and ring-cold (-). They can be used with balanced or unbalanced plugs. See the note above.

INSERT I/O (1 to 8) are unbalanced phone jack connectors. Both the nominal output and input levels are +0 dB. Wiring is sleeve-ground, tip-out, and ring-in. Connect external dynamic processors and other analog devices here.

9. POWER switch

This is a push-type power switch. It is recessed to prevent accidental operation. Press once to power ON; press again to power OFF.

10. METER connector

This 15-pin Dsub connector sends the meter information from each of the input channels, tape and effect return channels, auxiliary channels, etc., to the optional meter bridge (MB02).

**11. TIME CODE INPUT
SMPTE connector**

This phone jack is a nominal -10 dB/10k Ω connector. It accepts standard SMPTE timecode to synchronize the 02R to an external timecode source.

MTC connector

This is a standard 5-pin DIN-type MIDI connector. It is used to connect the 02R to a MIDI timecode source for external synchronization.

12. STEREO OUT DIGITAL connectors

The COAXIAL output is an RCA/phono jack. It outputs the main stereo signals for recording, and can be connected to DAT, MD, and DCC digital recorders via a 75 Ω coaxial cable. The output format is IEC958 Part 2 (S/PDIF - Consumer).

The AES/EBU output is an XLR-3-32 type connector. It also outputs the main stereo signals for recording. The output format is IEC958 Part 3 (AES/EBU - Professional).

13. MIDI connectors

These are standard 5-pin DIN-type MIDI THRU, OUT, and IN connections. They are used to connect the 02R to external MIDI devices for sequencer synchronization and control.

14. WORD CLOCK connectors

These are TTL/75 Ω BNC connectors for transmitting (OUT) and receiving (IN) word clock signals. A switch is provided to apply a 75 Ω terminator to the signal if the 02R is the last device in the chain.

15. TO HOST connector

This 8-pin Mini DIN connector is to plug a Macintosh or PC into the 02R for dedicated external system control.

16. 2TR IN DIGITAL (1 to 3) connectors

2TR IN DIGITAL (1) is an XLR-3-32 type connector. The input format is IEC958 Part 3 (AES/EBU - Professional).

2TR IN DIGITAL (2 and 3) are phono jacks. The input format is IEC958 Part 2 (S/PDIF - Consumer).

Signals input here are fed through to the CONTROL ROOM buttons (24) and are monitored in the control room or the studio. The outputs of a 2-track master recorder can be connected here for confidence monitoring and playback.

Note: *Digital signals routed through the control room selector switch do not have to be synchronized with the system word clock.*

The signals from 2TR IN DIGITAL (1) can also be routed to stereo input channels 17/18.

The signals from 2TR IN DIGITAL (2) can be routed to stereo input channels 19/20 or directly to the stereo buss.

Note: *Digital signals that are routed to the stereo input channels or directly to the stereo buss must be synchronized with the system word clock to prevent dropout and/or other noise.*

17. Option slots (1 to 4)

These slots accept one of the optional I/O cards.

List of Cards

Card	Format	Product	Size	Slot
Digital I/O	AES/EBU	CD8-AE	Double	1 or 2 (max 2 cards, 16 ch)
		CD8-AE-S	Single	1-4 (max 4 cards, 32 ch)
	ADAT	CD8-AT	Single	1-4 (max 4 cards, 32 ch)
	TDIF-1	CD8-TDII	Single	1-4 (max 4 cards, 32 ch)
	YAMAHA	CD8-Y	Single	1-4 (max 4 cards, 32 ch)
Analog I/O	AD/DA	CD8-AD	Double	1 or 2 (max 2 cards, 16 ch)
	A/D	CD8-AD-S	Single	1-4 (max 4 cards, 32 ch)
Cascade Kit		CD8-CS KIT	Single × 2	Any (normally 3 or 4)

Use slots 1 and 2 for direct output lines to your multitrack recorder. See Section 14, "Installing Options" on page 217 of the *User's Guide* for further details.

Block Diagram

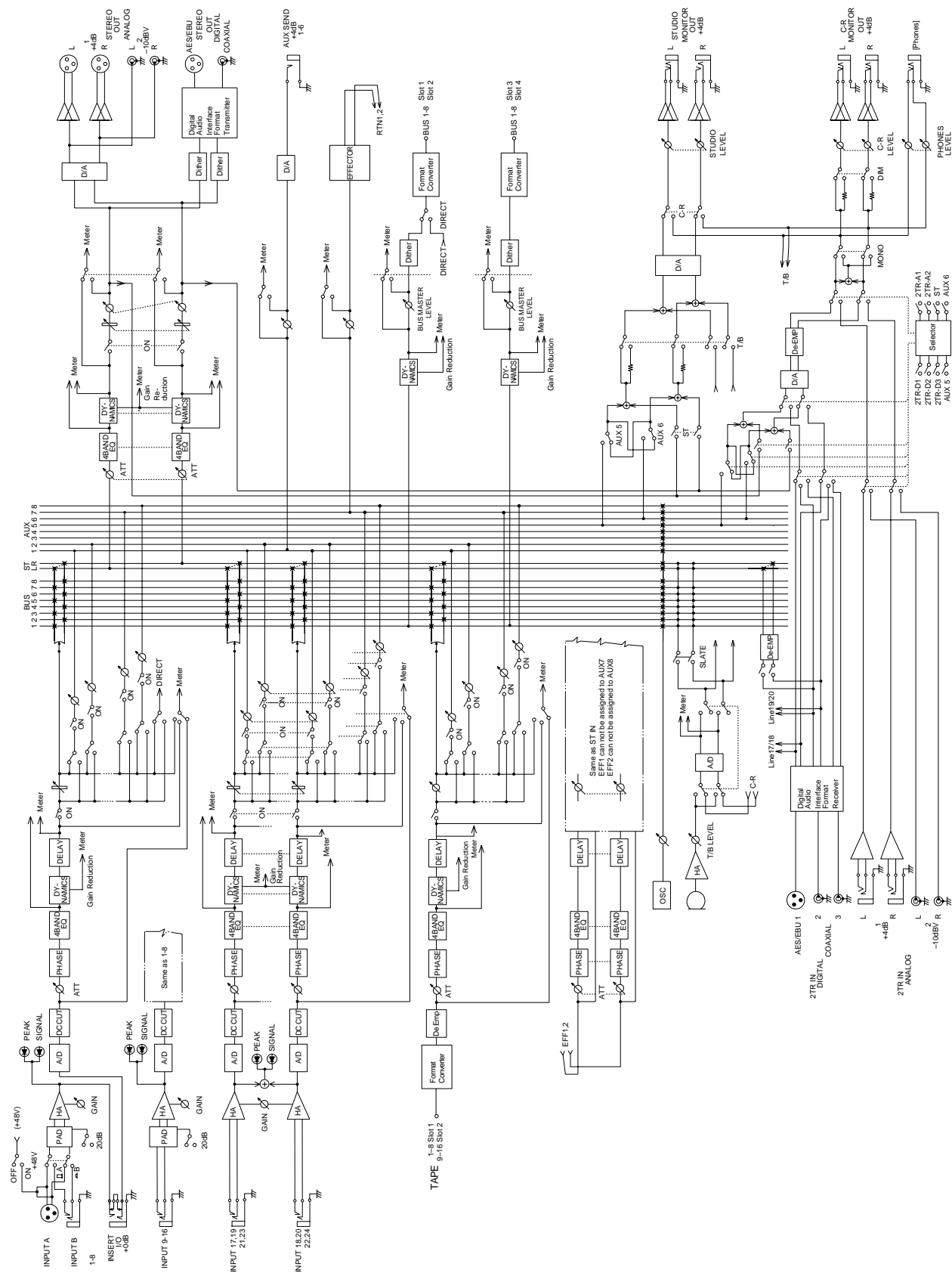

2

User Interface

In this chapter...

About the User Interface	18
DISPLAY ACCESS Buttons	18
Display	20
CURSOR Buttons	21
Encoder Wheel	21
ENTER Button	21
SCENE MEMORY Buttons	21
Display Functions	22
SELECTED CHANNEL Controls	23

About the User Interface

The 02R user interface is powerful but very intuitive. There are two main methods of working with the 02R:

- Use the DISPLAY ACCESS controls to modify one parameter at a time across the entire recording console.
- Use the SELECTED CHANNEL controls to modify all of the parameters of the currently selected channel. You will find these controls similar to the setup of an analog mixer.

Use whichever method is most convenient to you. You will probably find you use a combination of both methods, dependent on what you are trying to do with the 02R.

The DISPLAY ACCESS controls consist of a block of twelve function buttons divided into three groups: the CONFIGURATION group, the MIXING group, and the AUX group, plus the large backlit graphical display, four CURSOR buttons, a detented encoder wheel, and the [ENTER] button. There is also a related block of four SCENE MEMORY buttons.

The SELECTED CHANNEL controls consist of four main blocks of controls, each block corresponding to the equivalent controls on an analog mixer. The ROUTING block selects the buss onto which to route the current channel signal. The AUX block selects the auxiliary buss to send the channel signal to and sets the send level. The PAN block sets the pan position of the channel signal. The EQ block sets the equalization curve for the current channel.

The biggest difference between the two methods is that the DISPLAY ACCESS functions are directly associated with one or more pages on the display. The following section will briefly explain each of the controls of the two main blocks. Later sections will give more details about how to use these controls.

DISPLAY ACCESS Buttons

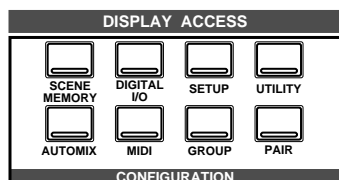

CONFIGURATION group

These buttons access the Display Functions that control the system configuration of the 02R.

- The [SCENE MEMORY] button is used to examine and edit the scene memories. You can also set channels to “recall safe”, which means they will not change levels when the scene is recalled, and you can set recall fade time.

- The [DIGITAL I/O] button is used to select the word clock source, define the digital input/output connectors, control the cascade configuration, and set the word dither.
- The [SETUP] button is used to control the solo function and defines system preferences.
- The [UTILITY] button is used to set the oscillator function and check the battery, emphasis, and channel status monitors.
- The [AUTOMIX] button is used to set and control the automix parameters.
- The [MIDI] button is used to select the MIDI channels and MIDI functions.
- The [GROUP] and [PAIR] buttons are used to create fader and mute groups and pair channels together.

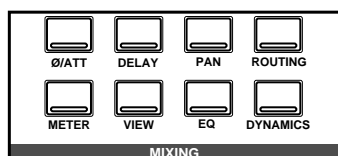

MIXING group

These buttons access the Display Functions that set mixer parameters for the entire recording console.

- The [Ø/ATT] button is used to reverse the phase and attenuate the signals after they have been converted to digital.
- The [DELAY] key is used to apply a small delay to the input signal, for example, to compensate for the gap between the record and playback heads of your multitrack recorder.
- The [PAN] button is used to adjust the pan position for a group of channels.
- The [ROUTING] button selects the routing page – a large visual patch bay.
- The [METER] button is used to meter the individual channels.
- The [VIEW] button is used to adjust all the parameters for the selected channel. It also accesses the Channel library.
- The [EQ] button is used to view the equalization curve and parameters of each individual channel. It also accesses the EQ library.
- The [DYNAMICS] button is used to adjust the dynamics of each individual channel. It also accesses the Dynamics library.

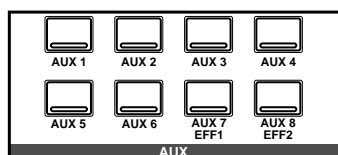

AUX group

These buttons access the Display Functions that set the auxiliary send levels for the recording console.

- The [AUX 1] to [AUX 6] buttons set the auxiliary send levels to the corresponding auxiliary buss. You can also select whether to send the signal pre or post fader.
- The [AUX 7] and [AUX 8] buttons also set the send levels to the corresponding auxiliary bus and can select pre or post fader. However,

these two sends are routed to the internal effects unit. Therefore, the buttons also allow you to select and set the effects parameters.

Display

The large backlit 320 × 240 pixel graphical display provides clear indication of mix settings and operating status. As well as showing parameter values numerically, faders and rotary controls are represented graphically, so you can actually see pan positions and fader positions. In addition, EQ curves are displayed graphically and signal levels are metered. The following illustration shows information that is always displayed and explains what it means:

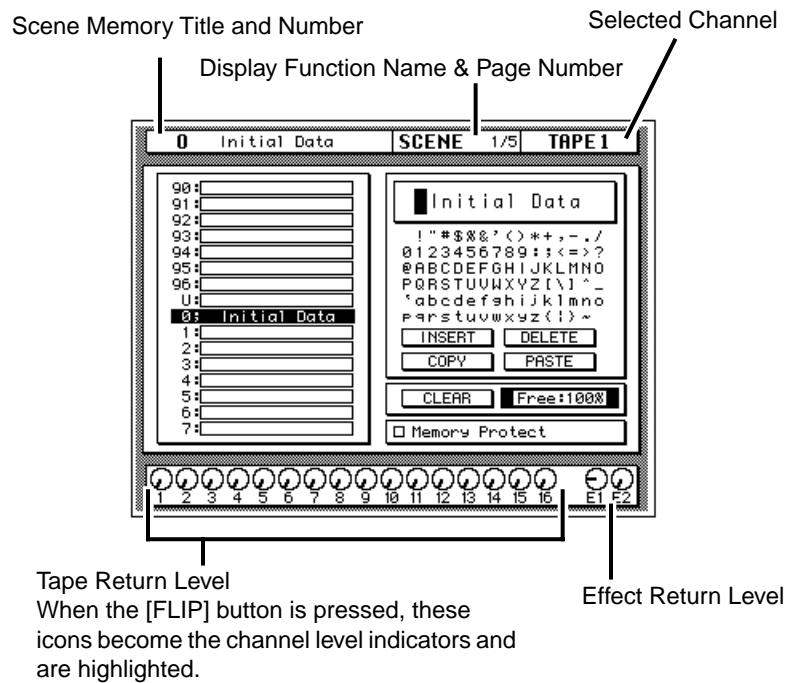

The page number shows how many pages are available within the selected function and which one of those pages is currently selected. For example, SCENE 1/3 indicates that the first page of the three SCENE pages is selected.

The CONTRAST control allows you to adjust the contrast of the display for different environments.

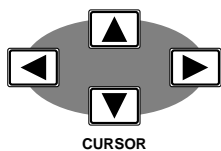

CURSOR Buttons

The CURSOR buttons are used to select parameters and options on the display. The selected parameter or option usually appears highlighted.

The CURSOR buttons are also used to position the cursor in a name when naming automix mixes, scene memories, EQ programs, effects programs, dynamics programs, and channel library programs.

When a display left or right icon appears at the left or right side of a page, indicating that another display page is available, the CURSOR buttons are used to select that display.

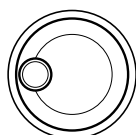

Encoder Wheel

The encoder wheel is used to adjust the parameter selected using the CURSOR buttons. Its detented action gives it a positive feel, allowing quick and accurate parameter adjustments. Turning it clockwise increases the selected parameter value. Turning it counterclockwise decreases the selected parameter value. The faster you turn it, the faster the parameter value changes.

The encoder wheel is also used to scroll through the automix programs, mix scenes, effects programs, EQ programs, and dynamics processor programs. When naming automixes, mix scenes, user effects programs, user EQ programs, and user dynamics programs, the encoder wheel is used to scroll through the available characters.



ENTER Button

The [ENTER] button is used to confirm settings made using the encoder wheel and to toggle two-option parameters such as EQ ON/OFF.

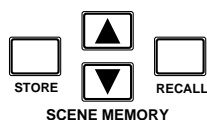

SCENE MEMORY Buttons

These buttons allow you to select, store and recall scene memories. The current scene memory is indicated on the SCENE MEMORY LED.

Display Functions

The following table lists all the 02R display functions and briefly explains what they do.

Display Function	Description
SCENE	Store and recall mix scenes.
DIGITAL I/O	Sets digital I/O parameters and selects word clock.
SETUP	Sets the solo parameters and system preferences.
UTILITY	Controls the oscillator parameters and accesses the emphasis monitor, the channel status monitor, and the battery level check.
MIDI	Set the MIDI channels, build the program change table, and control MIDI bulk data transfers.
AUTOMIX	Create, store, recall, and play automix programs.
GROUP	Set up the fader and mute groups.
PAIR	Set up channel pairs.
Ø/ATT	Set phase and attenuation.
DELAY	Set the channel delay.
PAN	Set the pan position.
ROUTING	Set the channel routing.
METER	Meter the levels from the individual input channels, the tape and effect return channels, the 8 main busses, and the 8 auxiliary busses.
VIEW	Set all parameters for the selected channel and access the channel library.
EQ	Set the equalization and access the EQ library.
DYNAMICS	Set the dynamics processor and access the dynamics library.
AUX 1 to 6	Set the channel levels to the auxiliary busses.
AUX 7 and 8	Set the channel levels to the auxiliary busses and set the internal effect parameters.

SELECTED CHANNEL Controls

These controls are very similar in setup to the controls of an analog mixer. You may find working with the buttons and controls of this section of the 02R is much faster and more intuitive than working through the pages of the DISPLAY ACCESS functions.

ROUTING buttons

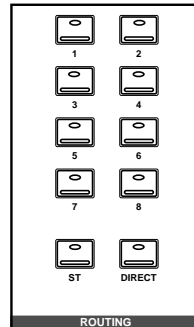

The routing buttons allow you to directly select the destination for the selected channel. The LEDs in the buttons illuminate to indicate the status of the channel.

Note: You can customize your 02R so that when you adjust any of the controls in this group, the display switches to the ROUTING page. See “Preferences” on page 198 of the User’s Guide.

AUX controls

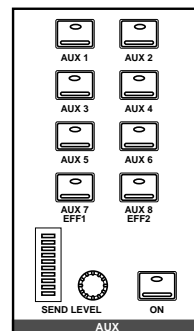

The AUX buttons allow you to select the auxiliary buses you want to send the selected channel signal to. The SEND LEVEL rotary encoder is used to set the level—indicated by the adjacent LED bargraph. The [ON] button is used to turn the send on or off. This allows you to make quick A-B comparisons.

PAN controls

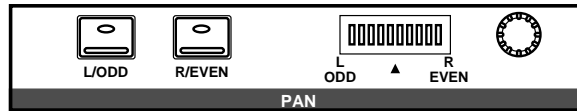

These controls allow you to set the pan position of the selected channel. The [L/ODD] and [R/EVEN] buttons select the left/odd and right/even channels. Use the rotary encoder to adjust the pan position. The current position is indicated on the adjacent LED bargraph.

Note: You can customize your 02R so that when you adjust any of the controls in this group, the display switches to the PAN page. See “Preferences” on page 198 of the User’s Guide.

EQUALIZER controls

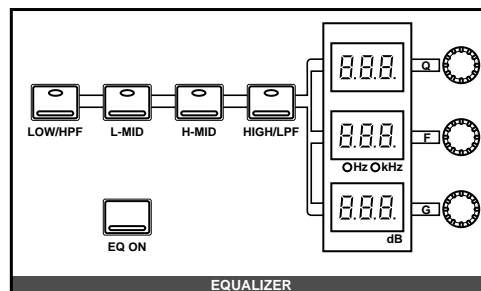

These controls allow you to adjust the EQ of the selected channel. Select the band you want to adjust with one of the buttons in the top row: [LOW/HPF], [L-MID], [H-MID], or [HIGH/LPF]. The three LED indicators will reflect the status of the selected band. Adjust the values (Q, F, and G) with the adjacent rotary encoders. Use the [EQ ON] button to turn the EQ on or off.

Note: You can customize your 02R so that when you adjust any of the controls in this group, the display switches to the EQ page. See “Preferences” on page 198 of the User’s Guide.

3

Mixing and Monitoring

In this chapter...

Analog Inputs.....	26
Phantom Power.....	26
Pad.....	27
GAIN Controls.....	27
SEL Buttons.....	27
ON Buttons.....	28
Faders.....	28
Analog Outputs.....	29
Monitor Selector Switches.....	29
Monitor Level Controls.....	30



Analog Inputs

The 02R is equipped with 24 analog input connectors. The first sixteen channels, 1 through 16, are mono input channels designed for microphone to line level signal inputs. The last eight channels, 17 through 24, are stereo channels designed for line level signals only.

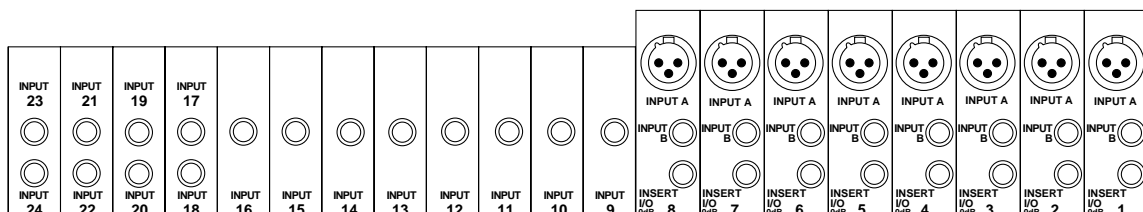

In addition, the first eight channels not only have selectable input connectors, XLR-type or phone, but they also have an insert connector, allowing you to patch external signal processors before the input signal is converted to digital.

For monitoring the output of a stereo tape recorder or another similar analog device, the 02R also has two pairs of 2TR IN phone connectors.

Phantom Power



Phantom power provides a +48 V DC power source for condenser type microphones. It is applied to the XLR-type connectors (INPUT A) for input channels 1 through 8. The phantom power switch for each channel is used to turn it ON and OFF. Phantom power is applied to each individual input.



Phantom power can only be applied to the XLR-type connectors (INPUT A) for input channels 1 through 8. Select those connectors with the A/B switch: up for A, down for B.

With phantom power set to ON, non-phantom powered microphones, dynamic microphones, and balanced line-level sources can still be connected to INPUT A connectors for input channels 1 through 8. However, be careful with unbalanced sources.

Pad



The Pad function attenuates input signals by 20 dB. This is useful when inputting high level signals that would otherwise overload the input preamplifier. By increasing the effective range of the GAIN control, high-level signals can be adjusted accurately. Pad can be set individually for the mono input channels 1 through 16. The [20 dB] (pad) switch at the top of each channel is used to turn it ON and OFF: up for OFF, down for ON.

GAIN Controls

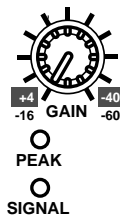

The GAIN controls are used to optimize the input channel signal levels. Use them with the PEAK indicators. This red LED illuminates when the input signal exceeds 3 dB below clipping. Ideally the level should be set relatively high. It is acceptable if this LED illuminates occasionally. If it is continuously illuminated, however, back off the GAIN control a little, otherwise the input preamplifier is being overloaded and clipping distortion will result.

The GAIN control should be set with some care. If it is set too low, the signal-to-noise performance will suffer, and if it is set too high, unpleasant signal clipping and distortion may occur.

The SIGNAL indicator is a green LED which illuminates when the input signal exceeds 10 dB below nominal.

The analog input controls are not controlled or stored by the 02R automix and scene memory functions. To assist in easy recall of the gain setting, the GAIN controls are detented. You should note the analog settings on a copy of the User Settings Sheet at the back of the manual.

SEL Buttons



The [SEL] buttons are used to select a channel in order to perform some action on it. When a channel is selected, the LED set in the corresponding button lights up and its name appears in the Selected Channel area of the display. Stereo-pair channels are selected together.

Note: You can use the [SEL] buttons to create stereo-pair channels. Refer to "Pairing Channels" on page 184 of the User's Guide.

The SELECTED CHANNEL controls are set to the current status of the selected channel. Depending on which display function is active, the selected channel may be highlighted, or the entire display may be dedicated to its parameters.

ON Buttons



The [ON] buttons are used to turn channels on and off. The input channel, tape return channel, effect return channel, and stereo output [ON] buttons turn their respective channels on and off. When a channel is turned on, the LED set in the corresponding button lights up. When it is turned off, the LED goes off. Stereo-pair channels are turned on and off together.

Faders

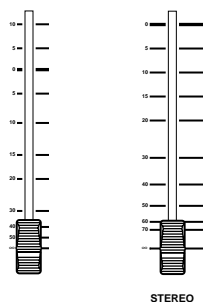

The 02R's faders are motorized. This means that they can be positioned automatically. You can group or pair faders together so all faders in a group or pair move automatically when you move any fader in that group or stereo pair.

Fader positions are stored in scene memories. When a scene memory is recalled the faders automatically move to their stored positions.

Fader positions are stored when the 02R is powered OFF. Even if faders are subsequently moved, they return automatically to their last positions when the 02R is powered ON again.

Note: You should avoid placing objects on the 02R that may block fader movements. There are several operations, such as recalling a scene memory, selecting the auxiliary buses, and automix playback, that automatically move the faders. If a fader is blocked, it could be damaged as it attempts to move.

Rotary Encoders



To adjust the levels of the tape and effect return channels, the 02R provides a continuously rotary encoder for each channel. The channel levels are indicated by the Tape Return Level and Effect Return Level icons at the bottom of the display.

FLIP Button



Although the rotary encoders are reasonably accurate, there will be times, for example during a mixdown, when you want the increased accuracy and feel of a fader to adjust the tape return levels.

The faders for input channels 1 through 16 are multifunction controls. When you press the [FLIP] button, the faders switch to adjusting the tape returns. The Tape Return icons are highlighted to indicate the input channels have moved up to the TAPE controls, and the LED in the [FLIP] button is illuminated.

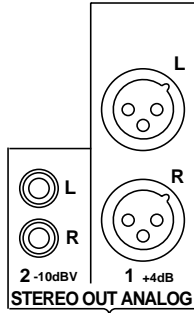

Analog Outputs

The 02R is equipped with a pair of analog stereo out connectors, one pair XLR-type for connecting to professional equipment, the other phono jacks. There are also two pairs of phone jacks to provide a stereo output to your control room and studio monitoring systems.

Monitor Selector Switches

STUDIO Buttons

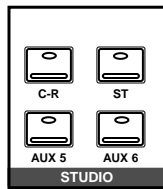

These buttons select the monitor signal sent to the studio monitor system. In many studios, this would be a headphone amplifier, typically one that could drive several sets of headphones. This system provides the monitoring that your musicians need in order to successfully work on a multitrack recording.

You can select the same signal that is being monitored in the control room with the [C-R] button. When you press this button, it cancels the current settings. When you press it again, it restores the previous settings.

You can send the signal from the stereo bus by pressing the [ST] button. The most flexible approach is to set up a separate mix using one of the auxiliary channels (press either the [AUX 5] or [AUX 6] button), and send that to the studio monitors. This allows you, for example, to apply reverb and equalization to the monitor signal you send to your vocalist, while you record the performance dry. You can select any combination of the [ST], [AUX 5], and [AUX 6] buttons—including none.

CONTROL ROOM Buttons

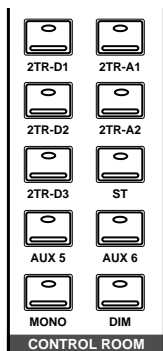

The buttons select the monitor signal sent to the control room monitor system. This is usually a large pair of near-field loudspeakers. Many studios also use a smaller speaker system, such as the YAMAHA NS-10M, to monitor a “typical” listening environment.

You can select one of five 2TR IN inputs, three of which are digital (the 2TR-D1 to 2TR-D3 buttons). These inputs are used for monitoring two track source signals, for example, the return of your master recorder. When you press any of these buttons, the current setting is cancelled. When you press the button again, the previous setting is restored.

You can also monitor the signal on the stereo bus with the [ST] button or select the auxiliary channels (AUX 5 or AUX 6). You can select any combination of the [ST], [AUX 5], and [AUX 6] buttons—including none.

Convert the monitor signal to monaural by pressing the [MONO] button or mute the output by 20 dB by pressing the [DIM] button.

SOLO Button



You can monitor input channels in isolation by pressing the [SOLO] button. The LEDs in the center of the selected channel [ON] buttons are extinguished. You select the channel(s) you want to solo by pressing the corresponding [ON] button. When you press the [SOLO] button again, the originally selected LEDs are illuminated again.

Note: *If the 02R is connected to other units with the digital cascade kit (CD8-CS), only the [SOLO] button on the cascade master unit is valid. See “Digital Cascade Kit (CD8-CS)” on page 229 of the User’s Guide*

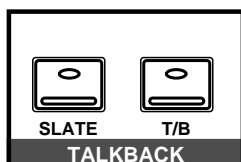

TALKBACK Buttons

The talkback system allows you to talk to musicians in the studio without leaving the 02R. Press the [T/B] button and start talking. The [SLATE] button sends the talkback signal to the main buses as well as the stereo bus, for example, allowing you to record a memo before recording a take.

You can also record 100 Hz, 1 kHz, and 10 kHz sine waves and white noise tones by using the oscillator function. See “Oscillator” on page 209 of the *User’s Guide* for details.

Monitor Level Controls



C-R LEVEL Control

This control is used to adjust the volume output through the control room monitor outputs.



T/B LEVEL Control

This control adjusts the volume of the talkback signal. The talkback signal is picked up by the built-in microphone right below the control.



STUDIO LEVEL Control

This control is used to adjust the overall volume output through the studio monitor outputs.

If you are using a headphone amplifier to provide studio monitoring, you may need a unit that allows individual adjustment of each set of headphones.

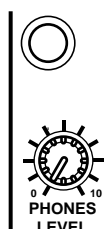

PHONES LEVEL Control

This control is used to adjust the volume of a set of stereo headphones plugged into the connector just above the control.

4

MIXING Display Functions

In this chapter...

- Phase and Attenuation 32
- Delay 34
- Pan and Balance..... 36
- Pan Gang..... 37
- Stereo Width 37
- PAN controls 38
- Routing 39
- ROUTING buttons..... 40
- Metering 41
- View 44
- Channel Library..... 48
- EQ..... 51
- EQ controls 53
- EQ Programs 54
- EQ Library 55
- Preset EQ Program Parameters..... 58



Phase and Attenuation

1. Press the (Ø/ATT) button.



The Ø/ATT page appears.

2. Select a channel using the (SEL) buttons or the CURSOR buttons.
3. To change the phase, press the (ENTER) button. The NOR icon changes to REV and is highlighted.
4. To change the attenuation, rotate the encoder wheel until the desired value is shown.
5. To set all channels (except the stereo output) to the same phase and attenuation, double-click the (ENTER) button.

Phase

The Phase function reverses the phase of an input signal by 180 degrees. The phase can be set for MIC/LINE inputs 1 to 24, TAPE inputs 1 to 16, and the effects returns. Phase reversal can be used to compensate for incorrectly wired balanced cables and microphones. When a snare drum is miked top and bottom, the channel connected to the bottom microphone can be phase reversed to prevent phase cancellation.

NOR—normal phase

REV—reversed phase

The Phase functions of adjacent channels are not linked when those channels are configured as a stereo pair. Likewise, the Phase functions of odd and even channels 17 to 24 always work independently. The effects returns have only one phase control each, so the left and right signals of these channels are always controlled together. The stereo output does not have a phase reverse function. Phase can also be set on the View 1/2 page.

Attenuation

After A/D conversion, input signals can be attenuated using the Attenuation function. Signals can be attenuated from 0 dB to -96 dB in 1 dB steps. The stereo output can be attenuated from +12 dB to -96 dB. For the TAPE inputs, the Attenuation function comes after de-emphasis.

Attenuation can be used to compensate for level increases caused by EQ boosting or dynamics processing. Instead of using a GAIN control to reduce a boosted signal, it's better to use the Attenuation function. Although levels can be reduced using the GAIN controls, this also reduces the level of the signal being fed to the A/D converter, which is not desired. The Attenuation function comes after the A/D converter, so conversion performance is not affected.

The Attenuation functions of adjacent channels are not linked when those channels are configured as a stereo pair. Likewise, the Attenuation functions of odd and even channels 17 to 24 always work independently. The effects returns and stereo output channels have only one Attenuation control each, so the left and right signals of these channels are always controlled together.

Attenuation can also be set on the View 1/2 and EQ 1/2 pages. However, operation for input channels 17 to 24, and MIC or TAPE channels configured as stereo pairs is as follows: since only one attenuation control is displayed on the View or EQ page, the attenuation functions of each channel are linked to preserve their relative settings. If the channel whose control cannot be seen reaches the minimum or maximum attenuation setting, a message appears.

Phase & Attenuation Pages

There are two pages to the Ø/ATT 1/1 function. The first page, shown below, contains the Phase and Attenuation controls for MIC/LINE channels 1 to 24, and appears when one of these channels is selected.

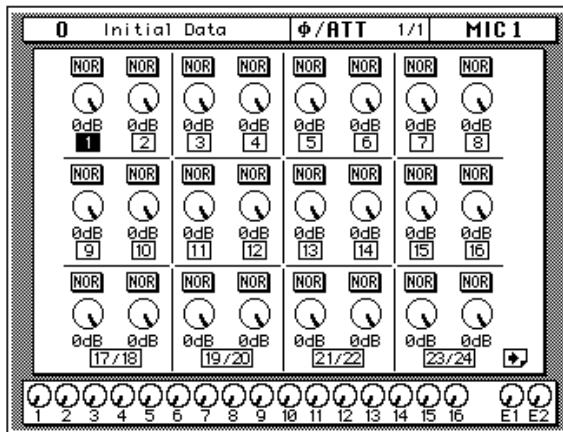

The second page, shown below, contains the Phase and Attenuation controls for TAPE channels 1 to 16, effects returns (EFF 1 and EFF 2), and the stereo output, and appears when one of these channels is selected.

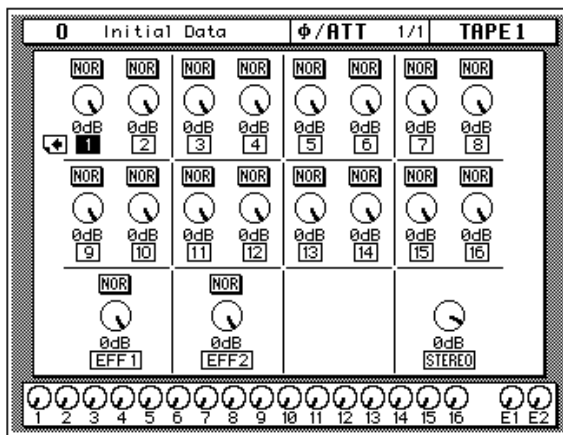

Note: When a stereo channel (17 to 24) is stored to the channel library, phase and attenuation parameters for both the left and right channels are stored. If such a channel program is recalled to a mono channel, the phase and attenuation settings of the left channel are used.

Delay

1. Press the (DELAY) button.



The DELAY display function appears.

2. Select a channel using the (SEL) buttons or the CURSOR buttons.
3. By default, the delay is off. Press the (ENTER) button to turn it on. The OFF icon, highlighted, changes to ON.
4. Use the CURSOR buttons to select either (Smpl) or (mSEC).
5. To change the delay, rotate the encoder wheel until the desired value is shown.
6. To set all channels to the same delay time, double-click the (ENTER) button.

The DELAY display function is used to apply a small amount of delay to input or return signals to compensate for situations such as line or cabling delays or the gap between the record and playback heads (or circuitry) of your multitrack recorder. You can delay a signal from 0 to 2,600 samples—at 44.1 kHz this is a delay of 0 to 59.0 ms and at 48 kHz it is a delay of 0 to 54.2 ms.

Delay can be applied to any of the input channels and the tape and effect return channels. The stereo input channels are always ganged together. The MIC/LINE and TAPE channels are set independently only when they are not linked together in GANG mode with the PAN function

Delay and Cascade

If you use a digital cascade kit (CD8-CS) to connect more than four 02Rs together, you will need to use the DELAY display function to apply delay to the machines closest to the output. Set a delay value of 10 to 20 samples for each unit.

The digital cascade kit will automatically apply the correct amount of delay when you connect four or less 02Rs together. See “Cascade Configuration” on page 191 of the *User’s Guide*.

Delay Pages

There are two pages to the DELAY 1/1 function. The first page, shown below, contains the Delay controls for MIC/LINE channels 1 to 24, and appears when one of these channels is selected.

0 Initial Data		DELAY 1/1	MIC 1
Smpl	mSEC	Smpl	mSEC
1	0 0.0 ON	9	0 0.0 ON
2	0 0.0 ON	10	0 0.0 ON
3	0 0.0 ON	11	0 0.0 ON
4	0 0.0 ON	12	0 0.0 ON
5	0 0.0 ON	13	0 0.0 ON
6	0 0.0 ON	14	0 0.0 ON
7	0 0.0 ON	15	0 0.0 ON
8	0 0.0 ON	16	0 0.0 ON
		17	0 0.0 ON
		18	0 0.0 ON
		19	0 0.0 ON
		20	0 0.0 ON
		21	0 0.0 ON
		22	0 0.0 ON
		23	0 0.0 ON
		24	0 0.0 ON

1 2 3 4 5 6 7 8 9 10 11 12 13 14 15 16 E1 E2

The second page, shown below, contains the Delay controls for TAPE channels 1 to 16 and effects returns (EFF 1 and EFF 2), and appears when one of these channels is selected.

0 Initial Data		DELAY	1/1	TAPE 1
Smp1	mSEC	Smp1	mSEC	Smp1 mSEC
1	0 0.0 ON	9	0 0.0 ON	E1 0 0.0 ON
2	0 0.0 ON	10	0 0.0 ON	
3	0 0.0 ON	11	0 0.0 ON	E2 0 0.0 ON
4	0 0.0 ON	12	0 0.0 ON	
5	0 0.0 ON	13	0 0.0 ON	
6	0 0.0 ON	14	0 0.0 ON	
7	0 0.0 ON	15	0 0.0 ON	
8	0 0.0 ON	16	0 0.0 ON	

Fine-Tuning the Delay

You can adjust the delay, either samples [Smp1] or milliseconds [mSEC] with coarse or fine precision just by the placement of the cursor on the selected channel.

For example, if the cursor is positioned over the thousands digit of the samples [Smp1] field, when you rotate the encoder wheel, the values increase or decrease by thousands of samples.

1	1000 20.8 ON	9	0 0.0 ON	E1	0 0.0 ON
2	0 0.0 ON	10	0 0.0 ON		

If the cursor is positioned over the hundreds or tens digit of the samples field, when you rotate the encoder wheel, the values increase or decrease by hundreds or tens of samples.

1	1047 21.8 ON	9	0 0.0 ON	E1	0 0.0 ON
2	0 0.0 ON	10	0 0.0 ON		

The same is true when the cursor is positioned over the ones digit of the samples field, or the tens, ones, or decimal digits of the milliseconds [mSEC] field.

Pan and Balance

1. Press the (PAN) button.



The PAN display function appears.

2. Select a channel using the (SEL) buttons or the CURSOR buttons.
3. To change the pan position, rotate the encoder wheel until the desired value is shown.

The PAN display function is used to pan and balance signals. The input channels, including the stereo input channels, and the tape and effect returns can be panned, and the stereo output can be balanced.

Pan Pages

There are two pages to the PAN 1/1 function. The first page, shown below, contains the Pan controls for MIC/LINE channels 1 to 24, and appears when one of these channels is selected.

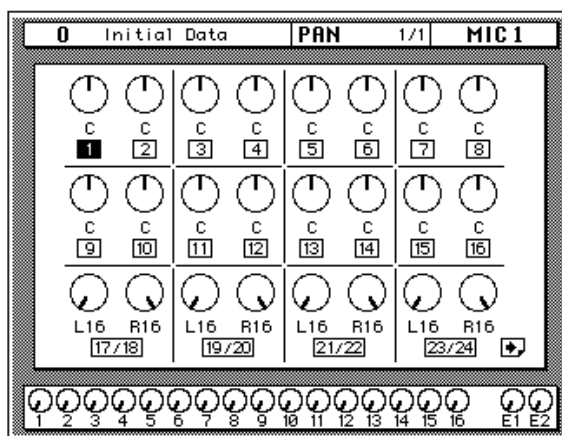

The second page, shown below, contains the Pan controls for TAPE channels 1 to 16, effects returns (EFF 1 and EFF 2), and the stereo output (balance), and appears when one of these channels is selected.

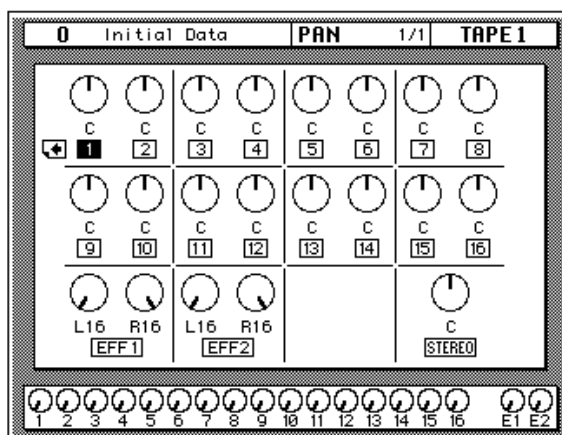

The number of the selected channel is highlighted. Channel pan positions are indicated by marker lines, just like the ones on real knobs. The current pan value is displayed under the panpot icon.

Note: When a stereo channel (17 to 24) is stored to the channel library, pan settings for both the left and right channels are stored. If such a channel program is recalled to a mono channel, the pan settings of the left channel are used.

Pan Positions

Including center, there are 33 pan positions:

L16 ← L15 ← ... ← L2 ← L1 ← C → R1 → R2 → ... → R15 → R16

Pan Gang

1. Press the (PAN) button.



2. Select a channel using the (SEL) buttons or the CURSOR buttons.
3. Press the (ENTER) button to connect the odd and even channels together.

Pans can also be linked by pressing the PAN L/ODD and R/EVEN buttons at the same time.

When channels are configured as a stereo pair, pan controls remain independent. Using the Gang function pan controls of adjacent channels can be ganged together, indicated by dotted lines between the two controls, as shown below.

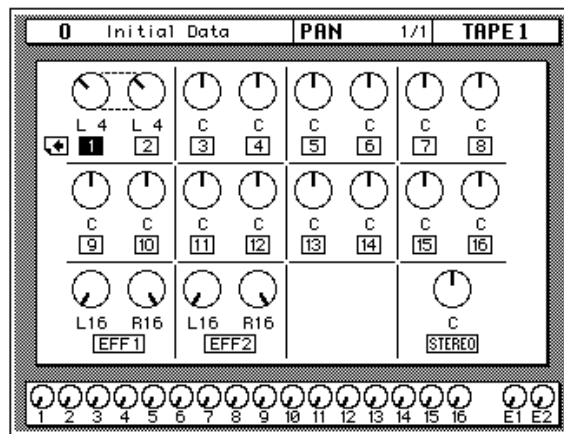

To cancel the Gang function, press the [ENTER] button again. The dotted lines between the pan controls disappear.

Stereo Width

When channels are configured as a stereo pair, the width of a stereo signal can be set using the pan controls. When the pan controls are set hard-left and hard-right, the stereo width is 100%. With both pans set to center the stereo width is 0%. Setting the controls to a position in between allows you to set the stereo width from 0% to 100%. To maintain a central balance, however, you must set both controls to a corresponding left and right values. For example, L5 and R5, or L10 and R10.

Switching to Gang mode allows you to reposition the stereo signal within the stereo field. For example, you could set L5 and R10 before you Gang the channels. After you press [ENTER], adjusting either channel moves the other a corresponding amount. If you set the left channel to L7, the right channel would adjust to R8.

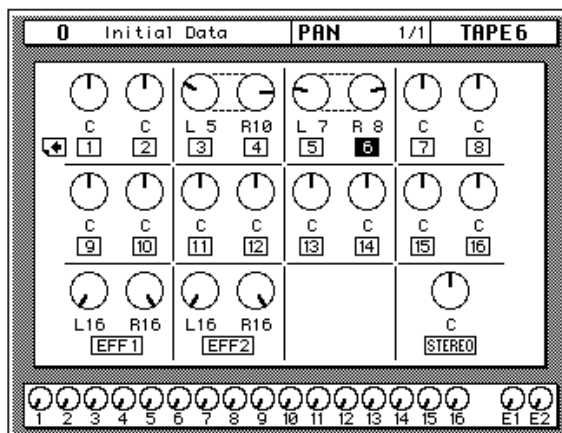

PAN controls

You can also adjust the pan position or balance of the selected channel with the controls in the SELECTED CHANNEL group.

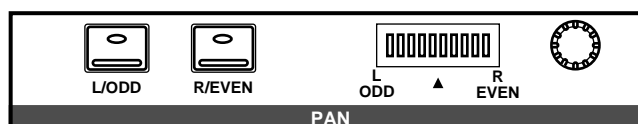

These controls allow you to select the pan position of the selected channel. The buttons select one of two channels (channels are always paired for the pan function). The LED is illuminated in the selected channel of the pair.

Use the rotary encoder to adjust the pan position. The current position is indicated on the adjacent LED bargraph.

You can link the odd and even channel pairs by pressing and holding the [L/ODD] button and then pressing the [R/EVEN] button. When a pair of channels are linked together in GANG mode, The LEDs in both buttons are illuminated and the LED of selected channel flashes. The indicator for the selected channel also flashes in the adjacent LED bargraph.

Note: You can customize your O2R so that when you adjust any of the controls in this group, the display switches to the PAN display function. See “Preferences” on page 198 of the User’s Guide.

Routing

1. Press the (ROUTING) button.



The ROUTING display function appears.

2. Select a channel using the (SEL) buttons or the CURSOR buttons.
3. Use the CURSOR buttons to select the routing destinations and press the (ENTER) button to switch a route ON or OFF.

The ROUTING display function is used to select the bus routing of the input channels and tape and effect return signals. The first 16 input channels, 1 through 16, can also be routed to the direct outputs. By default, all channels are routed to the stereo bus. Input channels configured as a stereo pair can be routed individually.

Note: Since routing a channel to its own input would create a feedback loop, the message "Would Cause Feedback!" appears if you attempt to route a channel to the bus selected as its input source on the SCENE 4/5 page. Also, if a channel library program containing routing settings that would cause such a feedback loop is recalled, the Input Patching settings on the SCENE 4/5 page are reset to their defaults.

Direct Outputs

All the input channels and tape and effect return signals can be routed to the output buses and the stereo bus. You can only route the first 16 input channels, MIC/LINE 1 through 16, to the direct outputs. The outputs for the optional boards are as follows:

Slot	Direct Out all OFF	Direct Out all ON
Slot 1	Bus 1 to 8	Direct 1 to 8
Slot 2	Bus 1 to 8	Direct 9 to 16
Slot 3	Bus 1 to 8	Bus 1 to 8
Slot 4	Bus 1 to 8	Bus 1 to 8

If you select both direct out and an output bus for a channel, the direct output will take priority.

Routing Pages

There are two pages to the ROUTING 1/2 function. The first page, shown below, contains the Routing controls for MIC/LINE channels 1 to 24, and appears when one of these channels is selected.

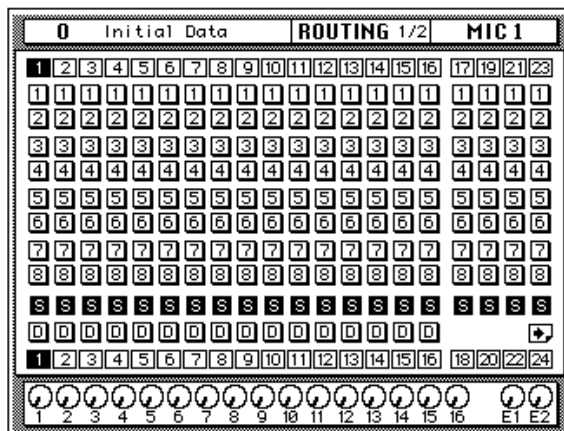

The second page, shown below, contains the Routing controls for TAPE channels 1 to 16 and effects returns (EFF 1 and EFF 2), and appears when one of these channels is selected.

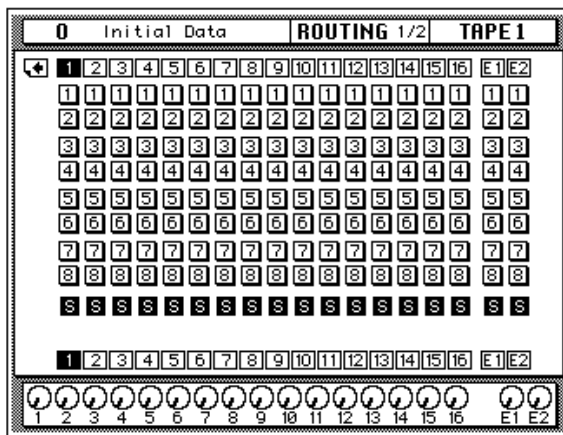

ROUTING buttons

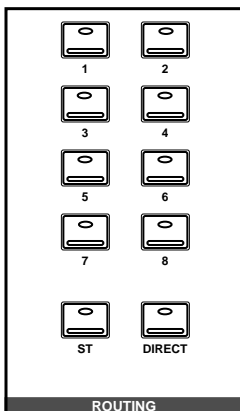

You can also set the routing for the selected channel with the ROUTING buttons in the SELECTED CHANNEL group. A route is selected ON when its icon is highlighted on the display.

The routing buttons allow you to directly select the destination for the selected channel. The LED in each the button illuminates to indicate the status of the channel.

Note: You can customize your 02R so that when you adjust any of the buttons in this group, the display switches to the ROUTING display function. See "Preferences" on page 198 of the User's Guide.

Metering

1. Use the (METER) button to select the METER pages.



The 02R features comprehensive signal level metering. The mono and stereo input channels, the tape and effect returns, and the auxiliary sends and buses are all metered using the METER display function. The control room output is metered using the dedicated 21-segment LED meters. Peak hold is available for all meters.

2. Select a channel using the (SEL) buttons or the CURSOR buttons.
3. Use the CURSOR buttons to select the PEAK HOLD icon and press the (ENTER) button to switch the function on or off.
4. Select one of the meter source point icons—PRE EQ, POST EQ, or POST FADER—with the CURSOR buttons. Make it the current meter point by pressing the (ENTER) button.

Meter Pages

There are three pages to the METER function. The first page, shown below, contains the meters for MIC/LINE channels 1 to 24, and appears when one of these channels is selected.

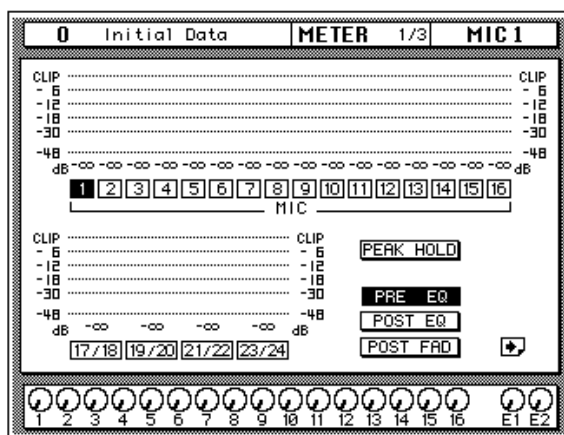

The second METER page, shown below, contains the meters for TAPE channels 1 to 16 and effects returns (EFF 1 and EFF 2), and appears when one of these channels is selected.

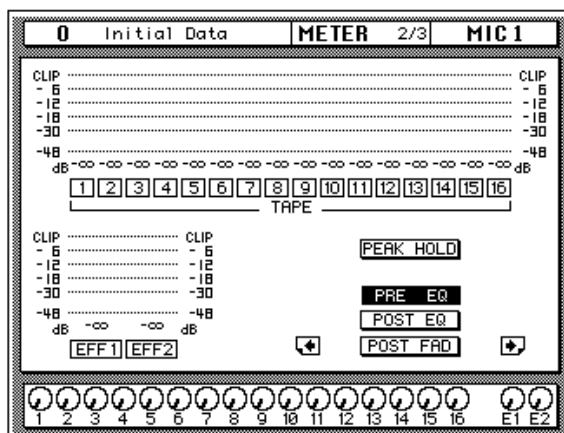

Setting the Bus Out and Aux Send Levels

1. Use the CURSOR buttons to select one of the fader icons.
2. Adjust the level by rotating the encoder wheel.

The third METER page contains the meters for the bus outs, aux sends, and the stereo output, plus the master faders for the bus outs and aux sends, and appears when one of these channels is selected.

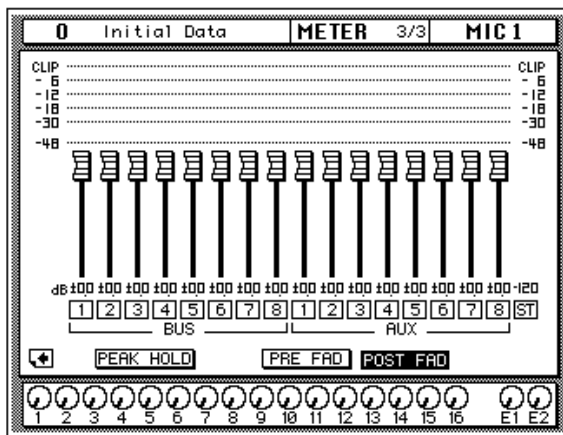

Peak Hold

The Peak Hold function can be turned on and off from any page of the METER display function. Clear the peak hold levels by turning the Peak Hold off (select the PEAK HOLD icon and press the [ENTER] button) or by selecting another display function. The dedicated control room output meter peak hold is not affected when other display functions are selected.

Note: When the 02R reaches CLIP, digital signal distortion occurs. You must ensure this does not happen. Digital distortion is very unpleasant sounding. There are a several things you can do. If CLIP is reached, but the corresponding PEAK indicator is not illuminated, you need to attenuate the channel slightly with the Ø/ATT display function (see "Phase and Attenuation" on page 32 of the User's Guide). Otherwise, back off the GAIN control a little (see "GAIN Controls" on page 27 of the User's Guide).

Meter Source Points

The following table lists the meter signal source points:

Signal	Source Points		
MIC/LINE 1-24	Post GAIN and A/D, Pre EQ	Post EQ	Post Fader
TAPE 1-16, EFF1, EFF2	Pre EQ	Post EQ	Post Fader
BUS 1-8, AUX 1-8, STEREO OUT	Pre Fader		Post Fader

By changing the meter source points, you can easily observe the effect of changing the EQ or channel fader levels on the signal.

Note: *Switching the meter source point for the input channels switches it for the tape and effect returns as well. Switching it for the tape and effect return changes the input channels.*

Optional Meter Bridge—MB02

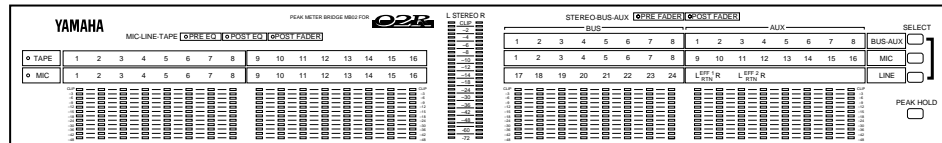

If your 02R is equipped with the optional Meter Bridge—MB02, the METER display function controls both the selection of the meter points for each channel as well as switching the Peak Hold function ON or OFF. The levels displayed on the optional meter bridge will be identical to the levels shown on the METER pages.

View

1. Use the (VIEW) button to locate the VIEW 1/2 page.



2. Select a channel by pressing one of the (SEL) buttons.
3. Use the CURSOR buttons to select an item.
4. Adjust the value of the item using the encoder wheel and/or the (ENTER) button.
5. To set the EQ, use the CURSOR buttons to select the EQ curve and press the (ENTER) button. The 02R will switch to the EQ display function.
6. To set the dynamics, select the dynamics curve with the CURSOR buttons and press the (ENTER) button. The 02R will switch to the DYNAMICS display function.

The VIEW display function allows you to see all the parameters of an individual channel at a glance and adjust any parameter that you feel requires a change. You can view the input channels (MIC/LINE 1 through 16, LINE 17/18 through 23/24) and the tape and effect return channels (TAPE 1 through 16, EFF1 and EFF2).

Shown below is the VIEW 1/2 page.

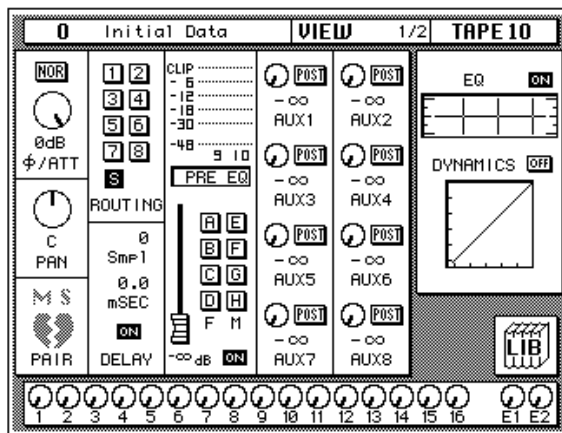

Unlike the previous display functions in this section, the VIEW display function shows the currently selected channel only.

Phase/Attenuation

Each time you press the [ENTER] button, the phase will alternate between NOR (normal) and REV (reversed). Rotate the encoder wheel to adjust the attenuation.

Operation for input channels 17 to 24, and MIC or TAPE channels configured as stereo pairs is as follows: since only one attenuation control is displayed on the View page, the attenuation functions of each channel are linked to preserve their relative settings. If the channel whose control cannot be seen reaches the minimum or maximum attenuation setting, a message appears. The indicators in the PAN [L/ODD] and [R/EVEN] buttons indicate whether the left or right channel of a pair is selected.

These controls duplicate the phase/attenuation function. See "Phase and Attenuation" on page 32 of the *User's Guide*.

Pan

Rotate the encoder wheel to set the pan position. You may find the PAN controls in the SELECTED CHANNEL group more convenient for setting the pan position.

When you press the [ENTER] button, the channel will be linked with its adjacent channel in GANG mode. Dotted lines will indicate the connection to the corresponding channel. Press the [ENTER] button again to switch back to INDIVIDUAL mode.

See “Pan and Balance” on page 36 and “Pan Gang” on page 37 of the *User’s Guide*.

MS

The MS icon is used to turn the MS Decoding function on or off. When the MS function is turned on, channels are configured as a stereo pair automatically, and when the stereo pair is cancelled, the MS function is turned off. See page 186 for more information.

Pair

Each time you press the [ENTER] button, PAIR will alternately be set or cancelled. Pair only applies to the individual input and tape return channels. See “Pairing Channels” on page 184 of the *User’s Guide*.

If the selected channel is one of the stereo input channels or the effect return channels, the PAIR function does not apply. Instead the pan icon for the opposite channel will be displayed here.

Routing

Use the CURSOR buttons to select the routing assignment. Each time you press the [ENTER] button, the selected route will alternately switch on or off. You may find using the ROUTING buttons in the SELECTED CHANNEL group a more convenient way to select the routes. See “Routing” on page 39 of the *User’s Guide*.

Delay

Rotate the encoder wheel clockwise to increase the delay, counterclockwise to decrease the delay. You can select “Smpl” (samples) or “mSEC” (milliseconds) with the CURSOR buttons. Press the [ENTER] button to turn the delay on or off. See “Delay” on page 34 of the *User’s Guide*.

Note: *The fine-tuning procedure is not available from this display function. See “Fine-Tuning the Delay” on page 35 of the User’s Guide.*

Meter Source Point

When the cursor is located at this part of the display, as you press the [ENTER] button, you can cycle through the meter source points—PRE EQ, POST EQ, or POST FADER. There are also level meters for the channel pair (selected and its corresponding even or odd mate). See “Metering” on page 41 of the *User’s Guide*.

Groups and Channel ON

Use the CURSOR buttons to select the fader and mute group icons. Each time you press the [ENTER] button, the selected group will alternately be set or cancelled. Remember that a channel can only belong to one fader group and one mute group. See “Grouping Faders” on page 182 and “Grouping Mutes” on page 183 of the *User’s Guide*.

Press the [ON] button to turn the channel on or off. See “ON Buttons” on page 28 of the *User’s Guide*.

Beside the fader and mute group icons is the fader position icon. You cannot adjust this from the display, but it accurately reflects the current position of the channel fader. Displayed below the icon is the fader position in dB. See “Faders” on page 28 of the *User’s Guide*.

Auxiliary Sends

Select an auxiliary channel with the CURSOR buttons. Each time you press the [ENTER] button, the setting alternates between pre and post-fader. To adjust the signal or to turn the send on or off, you need to use the AUX controls in the SELECTED CHANNEL group. The SEND LEVEL control adjusts the signal level and the [ON] button turns the send on or off. See “The AUX Buttons” on page 99 as well as “AUX 7 and AUX 8” on page 106 of the *User’s Guide*.

EQ

When the cursor is on the ON icon, pressing the [ENTER] button will turn the EQ on or off. When the EQ is on, the icon text is “ON” and is highlighted.

Use the CURSOR buttons to select the EQ curve icon and press the [ENTER] button. The 02R will switch to the EQ display function. See “EQ” on page 51 of the *User’s Guide*. To return to the VIEW display function, press the [VIEW] button again.

You may find using the EQUALIZER controls in the SELECTED CHANNEL group a more convenient way to set the equalization. See “EQ controls” on page 53 of the *User’s Guide*.

Dynamics

When the cursor is on the OFF icon, pressing the [ENTER] button will turn the dynamics processor on or off. When the dynamics processor is off, the icon text is “OFF” and is displayed in normal video.

Use the CURSOR buttons to select the dynamics curve and press the [ENTER] button. The 02R will switch to the DYNAMICS display function. See “DYNAMICS Display Function” on page 83 of the *User’s Guide*. To return to the VIEW display function, press the [VIEW] button again.

If the selected channel is one of the effect return channels, dynamics is replaced by the EFFECT TYPE display. It shows the name of the current effects program for the channel. Use the CURSOR buttons to select the effects program name and press the [ENTER] button. The 02R will switch to the EFFECT display function. See “Effects” on page 108 of the *User’s Guide*. To return to the VIEW display function, press the [VIEW] button again.

Library

When the cursor is located on the LIB icon, press the [ENTER] button to access the channel library. You can also press the [VIEW] button again to achieve the same thing.

Channel Library

1. Use the (VIEW) button to select the VIEW 2/2 page.



The Channel Library is used to access and store channel settings—stored as programs. There are 64 user programs (plus an UNDO buffer) for you to store your channel settings.

You can access the channel library from the VIEW 1/2 page by selecting the LIB icon with the CURSOR buttons and pressing the [ENTER] button.

Shown below is the VIEW 2/2 page.

Storing Channel Programs

1. Select the STORE icon with the CURSOR button and use the encoder wheel to select a program number.
2. Use the CURSOR buttons and encoder wheel to name the program.
3. Press the (ENTER) button. The 02R pops up a confirmation request.
4. Select EXECUTE and press the (ENTER) button. The channel program is stored.

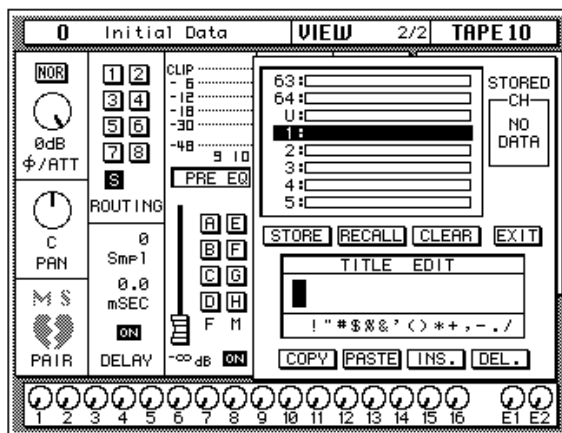

The Channel Library is overlaid on the VIEW 1/2 page.

The top of the display is a scrolling box containing the channel programs. The bottom of the display contains the icons and the TITLE EDIT box. Use the CURSOR buttons to select from the STORE, RECALL, CLEAR, COPY, PASTE, INS., DEL., and EXIT icons.

Selecting the EXIT icon and pressing the [ENTER] button switches back to the VIEW 1/2 page. You can also just press the [VIEW] button again.

Recalling Channel Programs

1. Select the RECALL icon with the CURSOR buttons.
2. Use the encoder wheel to select a channel program.
3. Press the (ENTER) button. The channel program is recalled.

Icons

- **STORE**—This icon is used to store the current program to the library. Select the icon with the CURSOR buttons. Use the encoder wheel to select a program and press the [ENTER] button. The 02R displays a confirmation dialog box asking if you want to store your settings in the selected program. The box has two icons: “CANCEL” and “EXECUTE”.

Note: You can customize your 02R to prevent the confirmation dialog box appearing during the STORE operation. See “Preferences” on page 198 of the User’s Guide for more information.

CANCEL is the default. To cancel the STORE operation, either press the [ENTER] button or wait about 10 seconds—the STORE operation will be automatically cancelled.

To store your settings, use the CURSOR buttons to select the “EXECUTE” icon and press the [ENTER] button. The program is stored.

When you confirm a STORE operation, any existing data in the selected program location will be overwritten.

YOU SHOULD ALWAYS BE CAREFUL WHEN THE 02R DISPLAYS A CONFIRMATION DIALOG BOX!

- **RECALL**—This icon is used to recall a program from the library. Select the icon with the CURSOR buttons. Use the encoder wheel to select a program and press the [ENTER] button. The recalled program is now the current program.
- **CLEAR**—This icon is used to clear the contents of a channel program. Use the CURSOR buttons to select the icon. Use the encoder wheel to select a channel program and press the [ENTER] button. The 02R displays a confirmation dialog box asking you want to clear the channel program. The box has two icons: “CANCEL” and “EXECUTE”.

Note: You can customize your 02R to prevent the confirmation dialog box appearing during the CLEAR operation. See “Preferences” on page 198 of the User’s Guide for more information.

CANCEL is the default. To cancel the CLEAR operation, either press the [ENTER] button or wait about 10 seconds—the CLEAR operation will be automatically cancelled.

To clear the channel program, use the CURSOR buttons to select the “EXECUTE” icon and press the [ENTER] button. The program is cleared.

If you change your mind, the cleared channel program can be retrieved by recalling the Undo channel program (U).

- **COPY**—This icon is used to copy the name of a library program. Select the icon with the CURSOR buttons. Use the encoder wheel to select a program and press the [ENTER] button. The program name is copied into an edit buffer.
- **PASTE**—This icon is used to paste a program name previously selected with the COPY operation into the TITLE EDIT box. Select the icon with the CURSOR buttons and press the [ENTER] button. The program name is pasted from the edit buffer into the TITLE EDIT box for subsequent editing.
- **INS.**—This icon is used to insert blank characters into the TITLE EDIT box at the current cursor location. Select the icon with the CURSOR buttons and press the [ENTER] button.
- **DEL.**—This icon is used to delete characters from the TITLE EDIT box at the current cursor location. Select the icon with the CURSOR buttons and press the [ENTER] button.

UNDO Operation

When the 02R stores or recalls a program, the previous settings are always preserved in the UNDO buffer. If you discover you have made a mistake, you can always recall the UNDO buffer (displayed as “U:” in the scrolling list of programs). Use the CURSOR buttons to select the RECALL icon, then

rotate the encoder wheel until the UNDO buffer is the current program, and press the [ENTER] button. The previous settings are restored.

Program Name

Channel program names can be up to 16 characters long and can contain any of the following characters:

	!	“	#	\$	%	&	'	()	*	+	,	-	.	/
0	1	2	3	4	5	6	7	8	9	:	;	<	=	>	?
@	A	B	C	D	E	F	G	H	I	J	K	L	M	N	O
P	Q	R	S	T	U	V	W	X	Y	Z	[\]	^	_
`	a	b	c	d	e	f	g	h	i	j	k	l	m	n	o
p	q	r	s	t	u	v	w	x	y	z	{		}	~	

EQ

1. Use the (EQ) button to select the EQ 1/2 page.



2. Select a channel using the (SEL) buttons.
3. Use the CURSOR buttons to select the EQ ON icon. Press the (ENTER) button to turn the EQ on or off.

The icon changes from ON to OFF. When the EQ is on, the icon is highlighted.

4. Select a icon using the CURSOR buttons, for example the “F” control for the H-MID band.
5. To change the value of the selected item, rotate the encoder wheel until the desired value is shown.

The 02R is equipped with a four-band, fully parametric EQ, with variable bandwidth, center frequency, gain, and ON/OFF parameters.

EQ can be applied to the input channels (MIC/LINE 1 through 16, LINE 17/18 through 23/24), the tape and effect return channels (TAPE 1 through 16, EFF1 and EFF2), and the stereo output. For stereo channels, the equalization curve is applied equally to both channels.

Shown below is the EQ 1/2 page.

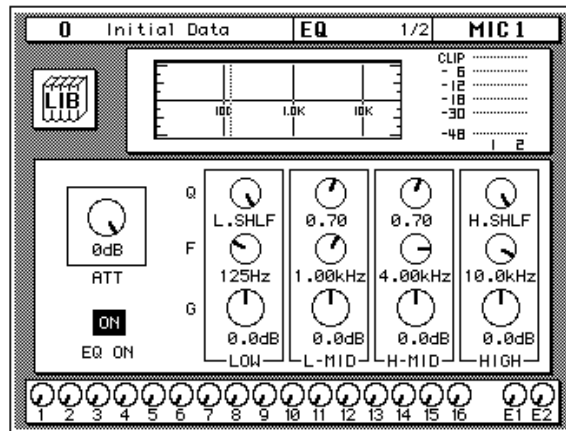

Similar to the VIEW display function, the EQ display function shows the equalization for the currently selected channel only.

The top of the display shows the EQ library icon, the equalization curve, and a level meter for the currently selected channel pair. The vertical dotted line in the equalization curve indicates the center frequency of the selected band.

The bottom of the display contains the icons for adjusting the parameters for the currently selected channel:

- **ATT**—The attenuator rotary icon is used to attenuate the channel level. Operation for input channels 17 to 24, and MIC or TAPE channels configured as stereo pairs is as follows: since only one attenuation control is displayed on the EQ page, the attenuation functions of each channel are linked to preserve their relative settings. If the channel whose control cannot be seen reaches the minimum or maximum attenuation setting, a message appears. The indicators in the PAN [L/ODD] and [R/EVEN] buttons indicate whether the left or right channel of a pair is selected.

This control duplicate Attenuation function. See “Phase and Attenuation” on page 32 of the *User’s Guide*.

Note: *The attenuator rotary icon is adjusting the same parameter as in the Ø/ATT display function. When you boost the gain of the equalization curve, you may cause the overall signal level to reach CLIP. Watch the level meters for the selected pair as you adjust the EQ values. If CLIP is reached, digital signal distortion will occur.*

- **EQ ON icon**—Indicates the status of the EQ, on or off. The text “ON” is highlighted when the EQ is on.
- **Rotary icons**—There is an icon for bandwidth (Q), center frequency (F), and gain (G) for each of the four bands, LOW, L-MID, H-MID, and HIGH.

Use the CURSOR buttons to select the desired icon and adjust its value with the rotary encoder. Switch the EQ on or off by pressing the [ENTER] button.

Equalization parameters:

	Q	F	G
LOW/HPF	Peak 10 to 0.1 in 41 steps / SHELF / HPF	21 Hz to 20.1 kHz in 1/12 octave steps ^{*1}	±18 dB in 0.5 dB steps HPF = ON/OFF
L-MID	Peak 10 to 0.1 in 41 steps	21 Hz to 20.1 kHz in 1/12 octave steps ^{*1}	±18 dB in 0.5 dB steps
H-MID	Peak 10 to 0.1 in 41 steps	21 Hz to 20.1 kHz in 1/12 octave steps ^{*1}	±18 dB in 0.5 dB steps
HIGH/LPF	Peak 10 to 0.1 in 41 steps / SHELF / LPF	21 Hz to 20.1 kHz in 1/12 octave steps ^{*1}	±18 dB in 0.5 dB steps LPF = ON/OFF

*1 When the sampling frequency is 32 kHz, the frequency range (F) is 21 Hz to 15.1 kHz

EQ controls

You can also adjust the equalization for the selected channel with the EQUALIZER controls in the SELECTED CHANNEL group.

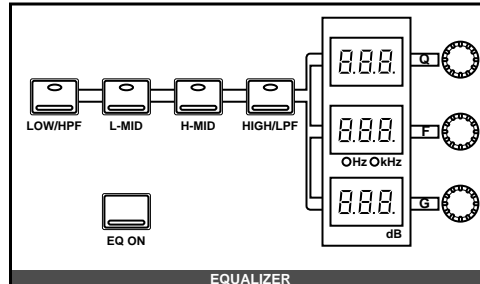

These controls allow you to adjust the equalization of the selected channel. Select the band you want to adjust with one of the buttons in the top row: [LOW/HPF], [L-MID], [H-MID], or [HIGH/LPF]. The three LED indicators will reflect the status of the selected band. Adjust the values, Q (bandwidth), F (frequency), and G (gain), with the corresponding rotary encoders. Use the [EQ ON] button to insert the equalization into the channel.

Note: You can customize your 02R so that when you adjust any of the controls in this group, the display switches to the EQ display function. See “Preferences” on page 198 of the User’s Guide.

Reset the Gain

You can reset the gain of each band to 0.0 dB by double-clicking the corresponding [LOW/HPF], [L-MID], [H-MID], or [HIGH/LPF] buttons.

Reset the EQ

You can reset all the values of the EQ for the selected channel. Press and hold the [LOW/HPF] button and then press the [HIGH/LPF] button.

All the EQ values will be reset to their default.

	LOW/HPF	L-MID	H-MID	HIGH/LPF
Q	LOW SHELF	Peak—0.7	Peak—0.7	HIGH SHELF
F	125 Hz	1.00 kHz	4.00 kHz	10.0 kHz
G	0dB	0dB	0dB	0dB

EQ Programs

These are the preset EQ programs.

No	Program Name	No	Program Name
1	Bass Drum 1	21	A.G.Stroke 2
2	Bass Drum 2	22	A.G.Arpeggio 1
3	Snare Drum 1	23	A.G.Arpeggio 2
4	Snare Drum 2	24	Brass Section
5	Tom-tom 1	25	Male Vocal 1
6	Cymbal	26	Male Vocal 2
7	High Hat	27	Female Vocal 1
8	Percussion	28	Female Vocal 2
9	E.Bass 1	29	Chorus & Harmony
10	E.Bass 2	30	Total EQ 1
11	Syn.Bass 1	31	Total EQ 2
12	Syn.Bass 2	32	Total EQ 3
13	Piano 1	33	Bass Drum 3
14	Piano 2	34	Snare Drum 3
15	E.G.Clean	35	Tom-tom 2
16	E.G.Crunch 1	36	Piano 3
17	E.G.Crunch 2	37	Piano Low
18	E.G.Distortion 1	38	Piano High
19	E.G.Distortion 2	39	Fine-EQ(Cass)
20	A.G.Stroke 1	40	Narrator

Note: *The programs 33 to 40 contain preset programs and are listed in the table above. However, you can store your own settings to these programs.*

EQ Library

1. Use the (EQ) button to select the EQ 2/2 page.



The EQ Library is used to access and store EQ settings—stored as programs. There are 40 preset programs (1 to 40) for you to recall and 88 user programs (41 to 128 plus UNDO) for you to store your own EQ settings.

You can access the EQ library from the EQ 1/2 page by selecting the LIB icon with the CURSOR buttons and pressing the [ENTER] button.

Recalling EQ Programs

Shown below is the EQ 2/2 page.

1. Select a channel using the (SEL) buttons.
2. Use the CURSOR buttons to select the RECALL icon and select an EQ program with the encoder wheel.
3. Press the (ENTER) button. The EQ program is recalled.

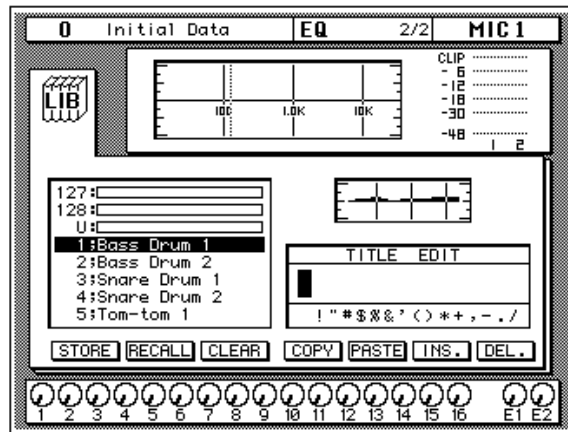

Storing EQ Programs

1. Use the CURSOR buttons to select the STORE icon and select an EQ program with the encoder wheel.
2. Use the CURSOR buttons and encoder wheel to name the program.
3. Press the (ENTER) button. The 02R pops up a confirmation request.
4. Select EXECUTE and press the (ENTER) button. The EQ program is stored.

The top of the display shows the EQ library icon, the equalization curve, and a level meter for the currently selected channel pair.

The middle of the display shows a scrolling list of EQ programs. The name of the EQ program under the cursor is highlighted. The encoder wheel is used to scroll through the program list. A small diagram of the response curve of the highlighted EQ program is shown to the right.

Beside the list of EQ programs is the TITLE EDIT field. The CURSOR buttons are used to select the character, and the encoder wheel is used to change its value.

The bottom of the display contains the control button icons. Use the CURSOR buttons to select from the STORE, RECALL, CLEAR, COPY, PASTE, INS., and DEL. icons.

Exiting the Library

Selecting the LIB icon and pressing the [ENTER] button switches back to the EQ 1/1 page. You can also press the [EQ] button again.

Icons

- **STORE**—This icon is used to store the current program to the library. Select the icon with the CURSOR buttons. Use the encoder wheel to

select a program and press the [ENTER] button. The 02R displays a confirmation dialog box asking if you want to store your settings in the selected program. The box has two icons: “CANCEL” and “EXECUTE”.

Note: You can customize your 02R to prevent the confirmation dialog box appearing during the STORE operation. See “Preferences” on page 198 of the User’s Guide for more information.

CANCEL is the default. To cancel the STORE operation, either press the [ENTER] button or wait about 10 seconds—the STORE operation will be automatically cancelled.

To store your settings, use the CURSOR buttons to select the “EXECUTE” icon and press the [ENTER] button. The program is stored.

When you confirm a STORE operation, any existing data in the selected program location will be overwritten.

YOU SHOULD ALWAYS BE CAREFUL WHEN THE 02R DISPLAYS A CONFIRMATION DIALOG BOX!

- **RECALL**—This icon is used to recall a program from the library. Select the icon with the CURSOR buttons. Use the encoder wheel to select a program and press the [ENTER] button. The recalled program is now the current program.
- **CLEAR**—This icon is used to clear the contents of an EQ program. Use the CURSOR buttons to select the icon. Use the encoder wheel to select an EQ program and press the [ENTER] button. The 02R displays a confirmation dialog box asking if you want to clear the EQ program. The box has two icons: “CANCEL” and “EXECUTE”.

Note: You can customize your 02R to prevent the confirmation dialog box appearing during the CLEAR operation. See “Preferences” on page 198 of the User’s Guide for more information.

CANCEL is the default. To cancel the CLEAR operation, either press the [ENTER] button or wait about 10 seconds—the CLEAR operation will be automatically cancelled.

To clear the EQ program, use the CURSOR buttons to select the “EXECUTE” icon and press the [ENTER] button. The program is cleared.

If you change your mind, the cleared EQ program can be retrieved by recalling the Undo EQ program (U).

- **COPY**—This icon is used to copy the name of a library program. Select the icon with the CURSOR buttons. Use the encoder wheel to select a program and press the [ENTER] button. The program name is copied into an edit buffer.
 - **PASTE**—This icon is used to paste a program name previously selected with the COPY operation into the TITLE EDIT box. Select the icon with the CURSOR buttons and press the [ENTER] button. The program name is pasted from the edit buffer into the TITLE EDIT box for subsequent editing.
-

- **INS.**—This icon is used to insert blank characters into the TITLE EDIT box at the current cursor location. Select the icon with the CURSOR buttons and press the [ENTER] button.
- **DEL.**—This icon is used to delete characters from the TITLE EDIT box at the current cursor location. Select the icon with the CURSOR buttons and press the [ENTER] button.

UNDO Operation

When the 02R stores or recalls a program, the previous settings are always preserved in the UNDO buffer. If you discover you have made a mistake, you can always recall the UNDO buffer (displayed as “U:” in the scrolling list of programs). Use the CURSOR buttons to select the RECALL icon, then rotate the encoder wheel until the UNDO buffer is the current program, and press the [ENTER] button. The previous settings are restored.

Program Name

EQ program names can be up to 16 characters long and can contain any of the following characters:

	!	“	#	\$	%	&	'	()	*	+	,	-	.	/
0	1	2	3	4	5	6	7	8	9	:	;	<	=	>	?
@	A	B	C	D	E	F	G	H	I	J	K	L	M	N	O
P	Q	R	S	T	U	V	W	X	Y	Z	[\]	^	_
`	a	b	c	d	e	f	g	h	i	j	k	l	m	n	o
p	q	r	s	t	u	v	w	x	y	z	{		}	~	

Preset EQ Program Parameters

No	Name	Parameter				Description	
		LOW	L-MID	H-MID	HIGH		
1	Bass Drum 1		PEAKING	PEAKING	PEAKING	H.SHELF	Emphasizes the low range of the bass drum and the attack created by the beater.
		Q	1.2	10	0.9		
		F	99Hz	265Hz	1.05kHz	5.33kHz	
		G	+3.5dB	-3.5dB	0.0dB	+4.0dB	
2	Bass Drum 2		PEAKING	PEAKING	PEAKING	LPF	Creates a peak around 80Hz, producing a tight, stiff sound.
		Q	1.4	4.5	2.2		
		F	79Hz	397Hz	2.52kHz	12.6kHz	
		G	+8.0dB	-7.0dB	+6.0dB	ON	
3	Snare Drum 1		PEAKING	PEAKING	PEAKING	H.SHELF	Emphasizes snapping and rimshot sounds.
		Q	1.2	4.5	0.11		
		F	132Hz	1.00kHz	3.17kHz	5.04kHz	
		G	-0.5dB	0.0dB	+3.0dB	+4.5dB	
4	Snare Drum 2		L.SHELF	PEAKING	PEAKING	PEAKING	Emphasizes the ranges of that classic rock snare drum sound.
		Q		10	0.7	0.1	
		F	177Hz	334Hz	2.37kHz	4.00kHz	
		G	+1.5dB	-8.5dB	+2.5dB	+4.0dB	
5	Tom-tom 1		PEAKING	PEAKING	PEAKING	PEAKING	Emphasizes the attack of tom-toms, and creates a long, "leathery" decay.
		Q	1.4	10	1.2	0.28	
		F	210Hz	667Hz	4.49kHz	6.35kHz	
		G	+2.0dB	-7.5dB	+2.0dB	+1.0dB	
6	Cymbal		L.SHELF	PEAKING	PEAKING	H.SHELF	Emphasizes the attack of crash cymbals, extending the "sparkling" decay.
		Q		8	0.9		
		F	105Hz	420Hz	1.05kHz	13.4kHz	
		G	-2.0dB	0.0dB	0.0dB	+3.0dB	
7	High Hat		L.SHELF	PEAKING	PEAKING	H.SHELF	Use on a tight high-hat, emphasizing the mid to high range.
		Q		0.5	1		
		F	94Hz	420Hz	2.82kHz	7.55kHz	
		G	-4.0dB	-2.5dB	+1.0dB	+0.5dB	
8	Percussion		L.SHELF	PEAKING	PEAKING	H.SHELF	Emphasizes the attack and clarifies the high-range of instruments, such as shakers, cabasas, and congas.
		Q		4.5	0.56		
		F	99Hz	397Hz	2.82kHz	16.9kHz	
		G	-4.5dB	0.0dB	+2.0dB	0.0dB	
9	E.Bass 1		L.SHELF	PEAKING	PEAKING	H.SHELF	Makes a tight electric bass sound by cutting very low frequencies.
		Q		5	4.5		
		F	35Hz	111Hz	2.00kHz	4.00kHz	
		G	-7.5dB	+4.5dB	+2.5dB	0.0dB	

No	Name	Parameter				Description	
		LOW	L-MID	H-MID	HIGH		
10	E.Bass 2		PEAKING	PEAKING	PEAKING	H.SHELF	Unlike program 9, this emphasizes the low range of the electric bass.
		Q	0.1	5	6.3		
		F	111Hz	111Hz	2.24kHz	4.00kHz	
		G	+3.0dB	0.0dB	+2.5dB	+0.5dB	
11	Syn.Bass 1		PEAKING	PEAKING	PEAKING	H.SHELF	Use on a synth bass with emphasized low range.
		Q	0.1	8	4.5		
		F	83Hz	944Hz	4.00kHz	12.6kHz	
		G	+3.5dB	+8.5dB	0.0dB	0.0dB	
12	Syn.Bass 2		PEAKING	PEAKING	PEAKING	H.SHELF	Emphasizes the attack that is peculiar to a synth bass.
		Q	1.6	8	2.2		
		F	125Hz	177Hz	1.12kHz	12.6kHz	
		G	+2.5dB	0.0dB	+1.5dB	0.0dB	
13	Piano 1		L.SHELF	PEAKING	PEAKING	H.SHELF	This is used to make a piano sound brighter.
		Q		8	0.9		
		F	94Hz	944Hz	3.17kHz	7.55kHz	
		G	-6.0dB	0.0dB	+2.0dB	+4.0dB	
14	Piano 2		PEAKING	PEAKING	PEAKING	H.SHELF	Emphasize the attack and low range of the piano sound by using a compressor.
		Q	5.6	10	0.7		
		F	223Hz	595Hz	3.17kHz	5.33kHz	
		G	+3.5dB	-8.5dB	+1.5dB	+3.0dB	
15	E.G.Clean		PEAKING	PEAKING	PEAKING	H.SHELF	Use for line-recording an electric guitar or semi-acoustic guitar to get a slightly hard sound.
		Q	0.18	10	6.3		
		F	265Hz	397Hz	1.33kHz	4.49kHz	
		G	+2.0dB	-5.5dB	+0.5dB	+2.5dB	
16	E.G.Crunch 1		PEAKING	PEAKING	PEAKING	PEAKING	Adjusts the tonal quality of a slightly distorted guitar sound.
		Q	8	4.5	0.63	9	
		F	140Hz	1.00kHz	1.88kHz	5.65kHz	
		G	+4.5dB	0.0dB	+4.0dB	+2.0dB	
17	E.G.Crunch 2		PEAKING	PEAKING	PEAKING	H.SHELF	This is a variation on program 16.
		Q	8	0.4	0.16		
		F	125Hz	445Hz	3.36kHz	19.0kHz	
		G	+2.5dB	+1.5dB	+2.5dB	0.0dB	
18	E.G.Distortion 1		L.SHELF	PEAKING	PEAKING	H.SHELF	Makes a heavily distorted guitar sound clearer.
		Q		9	10		
		F	354Hz	944Hz	3.36kHz	12.6kHz	
		G	+5.0dB	0.0dB	+3.5dB	0.0dB	
19	E.G.Distortion 2		L.SHELF	PEAKING	PEAKING	H.SHELF	This is a variation on program 18.
		Q		10	4		
		F	315Hz	1.05kHz	4.23kHz	12.6kHz	
		G	+6.0dB	-8.5dB	+4.5dB	+4.0dB	

No	Name	Parameter				Description	
		LOW	L-MID	H-MID	HIGH		
20	A.G.Stroke 1		PEAKING	PEAKING	PEAKING	H.SHELF	Emphasizes the bright tones of an acoustic guitar.
		Q	0.9	4.5	3.5		
		F	105Hz	1.00kHz	1.88kHz	5.33kHz	
		G	-2.0dB	0.0dB	+1.0dB	+4.0dB	
21	A.G.Stroke 2		L.SHELF	PEAKING	PEAKING	H.SHELF	This is a variation on program 20. You can also use it for the electric gut guitar.
		Q		9	4.5		
		F	297Hz	749Hz	2.00kHz	3.56kHz	
		G	-3.5dB	-2.0dB	0.0dB	+2.0dB	
22	A.G.Arpeggio 1		L.SHELF	PEAKING	PEAKING	PEAKING	Corrects arpeggio technique of an acoustic guitar.
		Q		4.5	4.5	0.12	
		F	223Hz	1.00kHz	4.00kHz	6.72kHz	
		G	-0.5dB	0.0dB	0.0dB	+2.0dB	
23	A.G.Arpeggio 2		L.SHELF	PEAKING	PEAKING	H.SHELF	This is a variation on program 22.
		Q		7	4.5		
		F	177Hz	354Hz	4.00kHz	4.23kHz	
		G	0.0dB	-5.5dB	0.0dB	+4.0dB	
24	Brass Section		PEAKING	PEAKING	PEAKING	PEAKING	Use with trumpets, trombones, or sax. With one instrument, adjust the HIGH or H-MID frequency.
		Q	2.8	2	0.7	7	
		F	88Hz	841Hz	2.11kHz	4.49kHz	
		G	-2.0dB	+1.0dB	+1.5dB	+3.0dB	
25	Male Vocal 1		PEAKING	PEAKING	PEAKING	PEAKING	Use as a template for male vocal. Adjust the HIGH or H-MID setting according to the voice quality.
		Q	0.11	4.5	0.56	0.11	
		F	187Hz	1.00kHz	2.00kHz	6.72kHz	
		G	-0.5dB	0.0dB	+2.0dB	+3.5dB	
26	Male Vocal 2		PEAKING	PEAKING	PEAKING	H.SHELF	This is a variation on program 25.
		Q	0.11	10	5.6		
		F	167Hz	236Hz	2.67kHz	6.72kHz	
		G	+2.0dB	-5.0dB	+2.5dB	+4.0dB	
27	Female Vocal 1		PEAKING	PEAKING	PEAKING	PEAKING	Use as a template for female vocal. Adjust the HIGH or H-MID setting according to the voice quality.
		Q	0.18	0.45	0.56	0.14	
		F	118Hz	397Hz	2.67kHz	5.99kHz	
		G	-1.0dB	+1.0dB	+1.5dB	+2.0dB	
28	Female Vocal 2		L.SHELF	PEAKING	PEAKING	H.SHELF	This is a variation on program 27
		Q		0.16	0.2		
		F	111Hz	334Hz	2.00kHz	6.72kHz	
		G	-7.0dB	+1.5dB	+1.5dB	+2.5dB	
29	Chorus & Harmony		PEAKING	PEAKING	PEAKING	PEAKING	Use as a template for a chorus. It makes the entire chorus much brighter.
		Q	2.8	2	0.7	7	
		F	88Hz	841Hz	2.11kHz	4.49kHz	
		G	-2.0dB	+1.0dB	+1.5dB	+3.0dB	

No	Name	Parameter				Description		
		LOW	L-MID	H-MID	HIGH			
30	Total EQ 1		PEAKING	PEAKING	PEAKING	H.SHELF	Use on the STEREO bus during mixdown. For more effect, try it with a compressor.	
		Q	7	2.2	5.6			
		F	94Hz	944Hz	2.11kHz	16.0kHz		
		G	-0.5dB	0.0dB	+3.0dB	+6.5dB		
31	Total EQ 2		PEAKING	PEAKING	PEAKING	H.SHELF	This is a variation on program 30.	
		Q	7	2.8	5.6			
		F	94Hz	749Hz	1.78kHz	17.9kHz		
		G	+4.0dB	+1.5dB	+2.0dB	+6.0dB		
32	Total EQ 3		L.SHELF	PEAKING	PEAKING	H.SHELF	This is a variation on program 30. Also use these programs for stereo inputs or external effect returns.	
		Q		0.28	0.7			
		F	66Hz	841Hz	1.88kHz	15.1kHz		
		G	+1.5dB	+0.5dB	+2.0dB	+4.0dB		
33	Bass Drum 3		PEAKING	PEAKING	PEAKING	PEAKING	This is a variation on program 1. The low and mid range is removed.	
		Q	2	10	0.4	0.4		
		F	118Hz	315Hz	4.23kHz	20.1kHz		
		G	+3.5dB	-10.0dB	+3.5dB	0.0dB		
34	Snare Drum 3		L.SHELF	PEAKING	PEAKING	PEAKING	This is a variation on program 3. It creates rather thick sound.	
		Q		4.5	2.8	0.1		
		F	223Hz	561Hz	4.23kHz	4.00kHz		
		G	0.0dB	+2.0dB	+3.5dB	0.0dB		
35	Tom-tom 2		L.SHELF	PEAKING	PEAKING	H.SHELF	This is a variation on program 5. Emphasizes the mid and high range.	
		Q		4.5	1.2			
		F	88Hz	210Hz	5.33kHz	16.9kHz		
		G	-9.0dB	+1.5dB	+2.0dB	0.0dB		
36	Piano 3		PEAKING	PEAKING	PEAKING	H.SHELF	This is a variation on program 13.	
		Q	8	10	9			
		F	99Hz	472Hz	2.37kHz	10.0kHz		
		G	+4.5dB	-13.0dB	+4.5dB	+2.5dB		
37	Piano Low		PEAKING	PEAKING	PEAKING	H.SHELF	Use for the low range of the piano sound when it is recorded in stereo. Use with program 38.	
		Q	10	6.3	2.2			
		F	187Hz	397Hz	6.72kHz	12.6kHz		
		G	-5.5dB	+1.5dB	+6.0dB	0.0dB		

No	Name	Parameter				Description	
		LOW	L-MID	H-MID	HIGH		
38	Piano High		PEAKING	PEAKING	PEAKING	PEAKING	Use for the high range of the piano sound when it is recorded in stereo. Use with program 37.
		Q	10	6.3	2.2	0.1	
		F	187Hz	397Hz	6.72kHz	5.65kHz	
		G	-5.5dB	+1.5dB	+5.0dB	+3.0dB	
39	Fine-EQ(Cass)		L.SHELF	PEAKING	PEAKING	H.SHELF	Use for recording to or from cassette tape to make the sound clearer.
		Q		4.5	1.8		
		F	74Hz	1.00kHz	4.00kHz	12.6kHz	
		G	-1.5dB	0.0dB	+1.0dB	+3.0dB	
40	Narrator		PEAKING	PEAKING	PEAKING	H.SHELF	Use for recording a voice reading a text.
		Q	4	7	0.63		
		F	105Hz	707Hz	2.52kHz	10.0kHz	
		G	-4.0dB	-1.0dB	+2.0dB	0.0dB	

Note: The EQ programs were programmed for recording acoustic musical instruments. If you are using them for a sampler, synthesizer, or rhythm machine, adjust the parameters accordingly.

Note: Programs 33 to 40 contain preset programs and are listed in the table above. However, you can store your own settings to these programs.

5

Surround Pan

In this chapter...

About Surround Pan	64
Selecting a Surround Mode	65
Panning Sounds Freely	67
Panning Sounds Using the Trajectories	69
Linking Channels for Surround Pan	72
CSR (Center:Side Ratio)	73

About Surround Pan

The 02R Surround Pan function supports 2+2, 3+1, and 3+2+1 surround modes, making it ideal for sophisticated surround sound production. Sounds can be moved freely around a two-dimensional sound space, or along preset circle, ellipse, semicircle, or diagonal trajectories. Surround channels can be transferred directly to a digital multitrack recorder via YGDAI (DIGITAL I/O 5/5). In addition, surround channels can be output via the analog aux sends (SETUP 2/4).

Output Assignments

The following table shows how the surround channels are assigned to the 02R bus outs in each mode. Connect the bus outs that correspond to the mode you are using to a surround sound monitoring system or recorder. Use the DIGITAL I/O 5/5 page to set the bus out to I/O card assignments. See “Slot Output Select” on page 194.

Mode	BUS 1	BUS 2	BUS 3	BUS 4	BUS 5	BUS 6
2+2	FL (front left)	FR (front right)	RL (rear left)	RR (rear right)	—	—
3+1	L (left)	R (right)	C (center)	S (surround)	—	—
3+2+1	FL (front left)	FR (front right)	RL (rear left)	RR (rear right)	FC (front center)	SW (subwoofer)

While a surround mode is active, buses 1 to 6 cannot be used for regular routing. Buses 5 and 6, however, can be used as normal with the 2+2 and 3+1 surround modes.

Selecting a Surround Mode

1. Use the (ROUTING) button to locate the ROUTING 2/4 page.



ROUTING

2. Use the CURSOR buttons to select the SURROUND icon, and press the (ENTER) button.

A confirmation dialog box appears.

3. Select EXECUTE and press the (ENTER) button.
4. Use the CURSOR buttons to select a surround mode, and press the (ENTER) button.
5. To turn off the Surround function, select the SURROUND icon and press the (ENTER) button.

Surround pan modes are selected on the ROUTING 2/2 page—Surround On/Off. When the Surround function is active, there are four ROUTING pages.

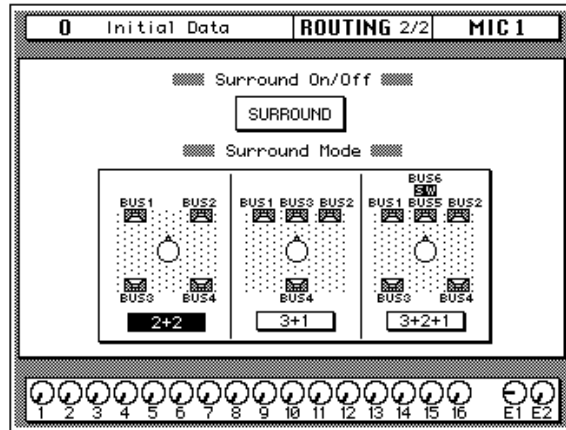

2+2 Surround Mode

Four-channel surround sound consisting of front left (FL), front right (FR), rear left (RL), and rear right (RR) channels.

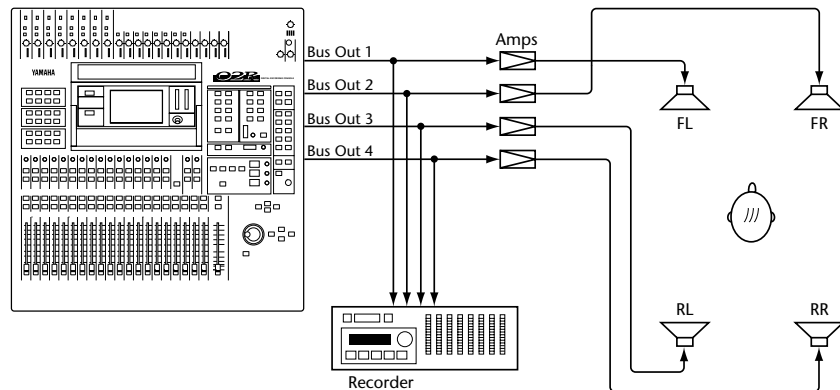

3+1 Surround Mode

Four-channel surround sound consisting of left (L), center (C), right (R), and surround (S) channels. Ideal for Dolby Surround authoring.

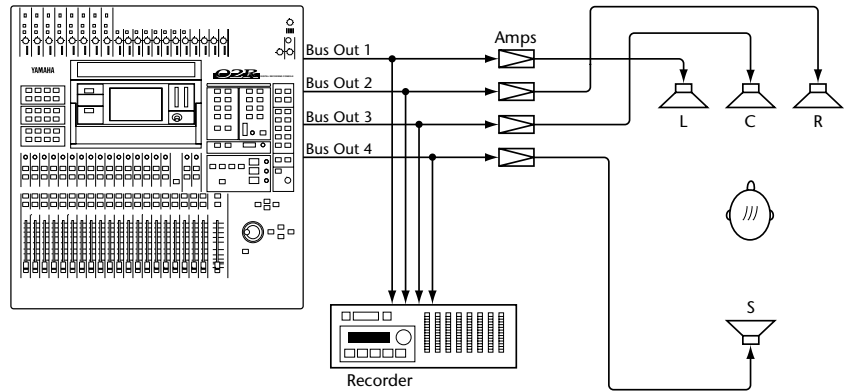

3+2+1 Surround Mode

Six-channel surround sound consisting of front left (FL), front center (FC), front right (FR), rear left (RL), rear right (RR), and subwoofer (SW) channels. Ideal for Dolby AC-3 Surround authoring.

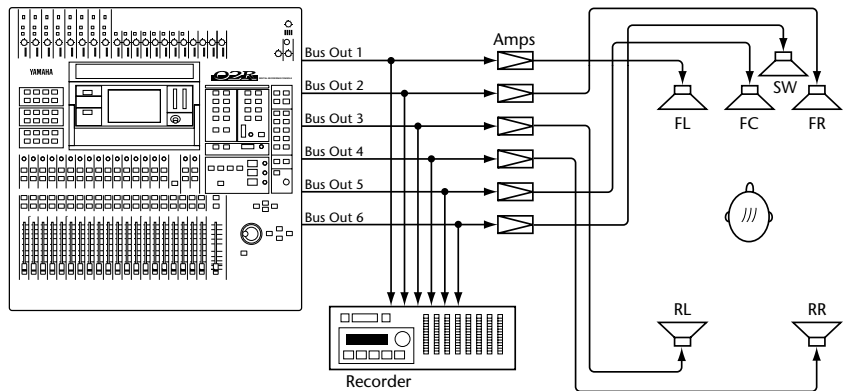

Panning Sounds Freely

1. Use the (ROUTING) button to locate the ROUTING 3/4 page.



2. Use the CURSOR buttons to select the MIC, LINE, or TAPE icon, and press the (ENTER) button.
3. Use the (SEL) buttons to select a channel.
4. Use the CURSOR buttons to select the left/right or front/rear parameter.
5. Use the encoder wheel to position the sound.

This section explains how to position sounds using the ROUTING 3/4 page. Sounds can also be moved along preset circle, ellipse, semicircle, or diagonal trajectories on the ROUTING 4/4 page.

The ROUTING 3/4 page consists of three parts: MIC, LINE, and TAPE, and the three icons at the top of the page are used to select them. These pages are selected automatically when the relevant [SEL] button is pressed. All pages feature the timecode counter. The MIC page, shown below, contains surround pan controls for MIC inputs 1 to 16.

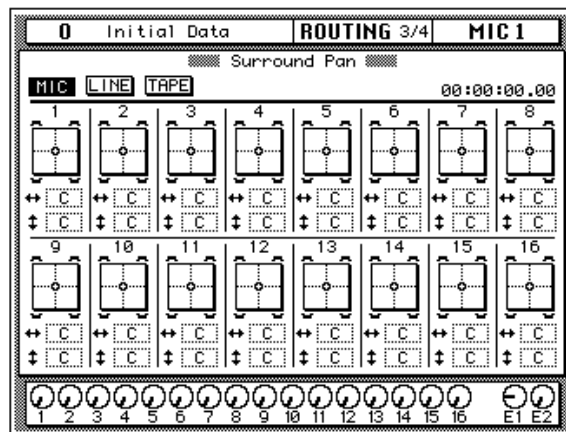

1 The surround pan position for each channel is displayed on a two-dimensional pan graph. The pan position is indicated by a small circle. Small speaker icons above and below the pan graph indicate the selected surround pan mode. In this example, two speakers at the front and two at the rear indicate that 2+2 surround mode is selected. Below the pan graph are two parameters. The \leftrightarrow (left/right) parameter moves the sound from left to right. The \ddagger (front/rear) parameter moves the sound from front to rear.

The LINE page, shown below, contains surround pan controls for LINE inputs 17 to 24 and the effects returns.

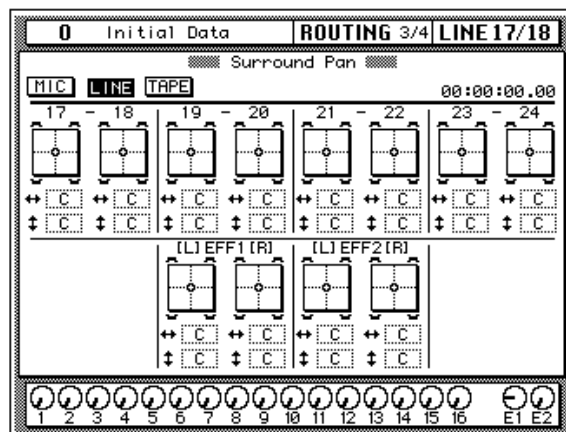

The TAPE page, shown below, contains surround pan controls for TAPE inputs 1 to 16.

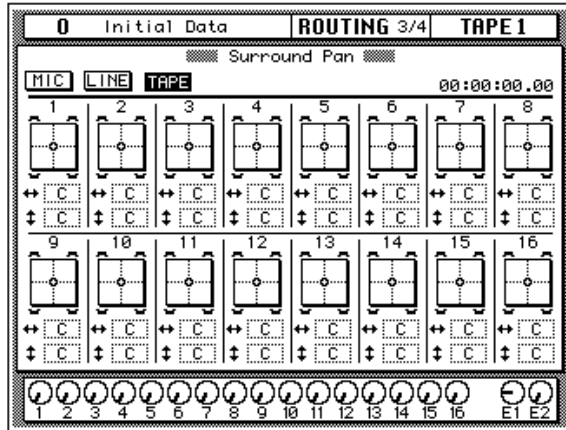

Panning Sounds Using the Trajectories

1. Use the **(ROUTING)** button to locate the **ROUTING 4/4** page.



This page can also be accessed from the **ROUTING 3/4** page by pressing the **(ENTER)** button while a surround pan graph is selected.

2. Use the **(SEL)** buttons to select a channel.
 3. Use the **CURSOR** buttons to select a trajectory, and press the **(ENTER)** button to activate it.
 4. Set the **Width**, **Depth**, and **Offset** parameters using the encoder wheel.
 5. Move the cursor to another parameter and use the encoder wheel to move the sound along the selected trajectory.
- When the **FAST** icon is highlighted, sounds can be moved at high speed.
6. To return to the **ROUTING 3/4** page, select the **EXIT** icon and press the **(ENTER)** button.

This section explains how to move sounds along preset circle, ellipse, semicircle, or diagonal trajectories using the **ROUTING 4/4** page. The preset trajectories can be fine-tuned using the **Width**, **Depth**, and **Offset** parameters.

The **ROUTING 4/4** page, shown below, can be located using either the **[ROUTING]** button or by pressing the **[ENTER]** button while a surround pan graph on the **ROUTING 3/4** page is selected. The **EXIT** icon on the **ROUTING 4/4** page can be used to return to the **ROUTING 3/4** page. Like the **ROUTING 3/4** pages, the **ROUTING 4/4** page features a timecode counter.

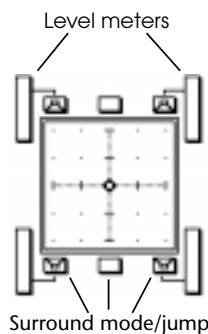
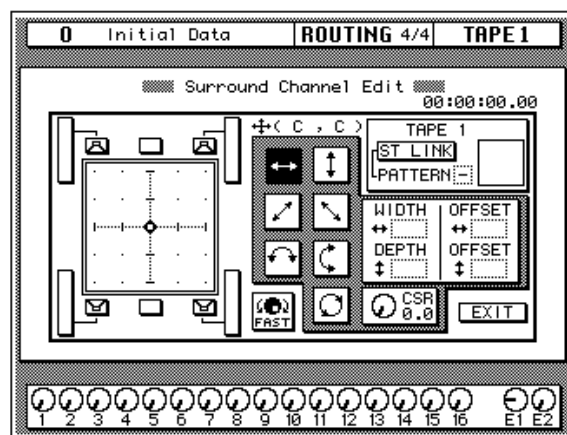

The surround pan position for each channel is displayed on a two-dimensional pan graph. The pan position is indicated by a small circle. Small speaker icons above and below the pan graph indicate the selected surround pan mode. In this example, two speakers at the front and two at the rear indicate that 2+2 surround mode is selected. Next to each speaker is a signal level meter indicating the master bus out level. Selecting a speaker icon and then pressing the **[ENTER]** button makes the sound jump to that speaker. In 3+2+1 mode, a subwoofer level control is available on this page.

To quickly move a sound to the default position, select the left/right trajectory icon and double-click the **[ENTER]** button.

Trajectories

The following surround pan trajectories are available.

 **Left to right**—The sound moves from left to right. The following illustrations show some typical left to right trajectories.

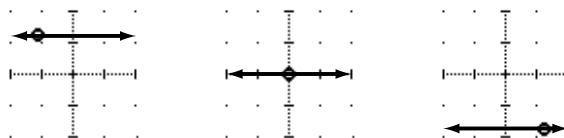

 **Front to rear**—The sound moves from front to back. The following illustrations show some typical front to rear trajectories.

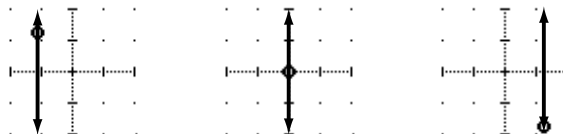

 **Rear left to front right diagonal**—The sound moves on a diagonal trajectory from the rear left to the front right. Width, depth and offset can be set for this trajectory. The following illustrations show some typical trajectories.

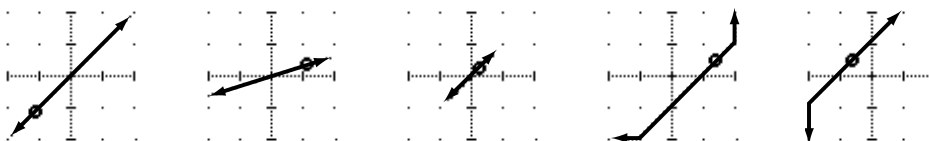

 **Front left to rear right diagonal**—The sound moves on a diagonal trajectory from the front left to the rear right. Width, depth and offset can be set for this trajectory. The following illustrations show some typical trajectories.

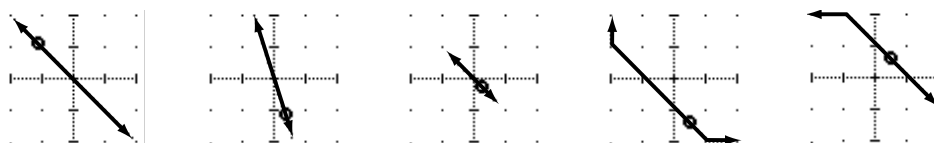



Left to right semicircle—The sound moves from left to right on a semicircular trajectory. Use the width and depth parameters to set the size and shape of the semicircle. The shape can be adjusted from a semicircle to a narrow oval. Use the offset parameters to offset the trajectory to the left, right, front, or rear. The following illustrations show some typical trajectories.

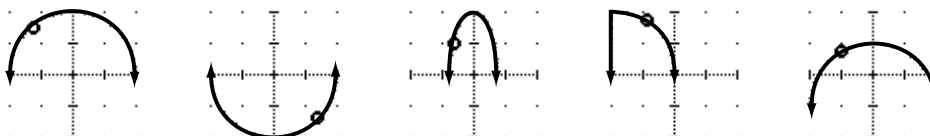

Front to rear semicircle—The sound moves from front to rear on a semicircular trajectory. Use the width and depth parameters to set the size and shape of the semicircle. The shape can be adjusted from a semicircle to a narrow oval. Use the offset parameters to offset the trajectory to the left, right, front, or rear. The following illustrations show some typical trajectories.

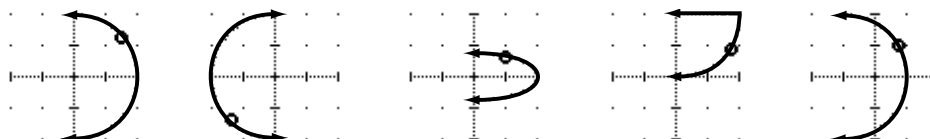

Circle—The sound moves on a circular trajectory. Use the width and depth parameters to set the size and shape. The shape can be adjusted from a perfect circle to a narrow oval. Use the offset parameters to offset the trajectory to the left, right, front, or rear. The following illustrations show some typical trajectories.

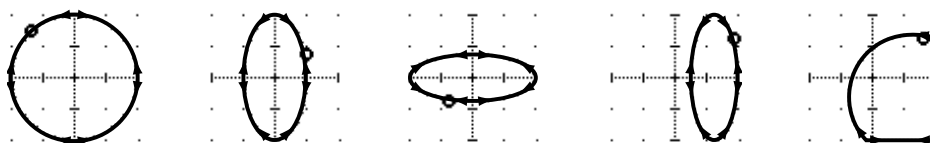

Linking Channels for Surround Pan

1. Use the **(ROUTING)** button to locate the **ROUTING 4/4** page.



ROUTING

2. Use the **(SEL)** buttons to select a channel.
3. Use the **CURSOR** buttons to select the **ST LINK** icon, and then press the **(ENTER)** button.
4. Use the **CURSOR** buttons to select the **PATTERN** parameter, and the encoder wheel to select a pattern.

For stereo input channels (17 to 24), or mono input channels configured as a stereo pair, you can select one of eight patterns and move both sounds together. The following illustration shows how the two channels are panned with the various patterns and trajectories.

Trajectory							
Pattern							

Note: *ST LINK settings are not stored in channel library programs. So when a channel program is recalled and the destination channel is using ST LINK, the surround settings of the other linked channel are changed to match. Also, when the surround settings of a stereo channel are stored, only the settings of the selected channel are stored.*

By default, ST LINK is turned on for stereo channels. Note that if just the ST LINK parameter is turned off, it is possible to overwrite the pan movements of the other channel during subsequent automix recording.

CSR (Center:Side Ratio)

1. Use the **(ROUTING)** button to locate the **ROUTING 4/4** page.



2. Use the **(CURSOR)** buttons to select the **CSR** control.
3. Use the **encoder wheel** to set the **CSR** ratio.

For the 3+1 and 3+2+1 surround modes that use a center speaker, the CSR (Center:Side Ratio) control can be used to set the amount of front-center sound heard through the center and left and right front speakers.

CSR	Description
0.0	The front-center sound appears only in the left and right speakers.
0.5	The front-center sound appears in the center and left and right speakers at the same level.
1.0	The front-center sound appears only in the center speaker.

Surround Pan Notes

Surround pan settings can be stored and recalled using scene memories. The FAST parameter setting on the **ROUTING 4/4** page, however, is not stored.

Real-time surround pan adjustments can be recorded in an automix, and on the **SETUP 4/4** page—Preferences 2—you can choose which surround parameters are recorded: X/Y (surround pan position), CSR (Center:Side ratio), and SWF (subwoofer).

Although it is possible to select other trajectories on the **ROUTING 4/4** page while automix recording is in progress, these actions are not recorded. Likewise, the **ST LINK** parameter cannot be turned on or off while recording. In both cases an “Automix Running” message appears. To automate these parameters, store the settings in a scene memory and use the automix to recall that.

When channels are linked using **ST LINK**, the X/Y pan movements of both channels are recorded regardless of which channel is selected. CSR and subwoofer adjustments, however, are recorded only for the selected channel. Of course, if the channels are configured as a stereo pair, CSR and subwoofer adjustments of both channels are recorded.

The X/Y pan movements of left and right channels in a stereo pair cannot be recorded individually. Note that if the **ST LINK** parameter is turned off after X/Y pan movements have been recorded, it is possible to overwrite the X/Y pan movements of the other channel during subsequent automix recording.

6

Dynamics

In this chapter...

Dynamics Processors.....	76
Preset Dynamics Programs	76
Compressor.....	77
Expander.....	79
Compander.....	80
Gate and Ducking	81
DYNAMICS Display Function	83
Patching in a Processor.....	84
Dynamics Processor Meters.....	85
KEY IN and LINK Indicators.....	86
Dynamics Library	87
Preset Dynamics Program Parameters.....	90

Dynamics Processors

Dynamics processors are generally used to correct or control signal levels. However, you can also use them creatively to shape the volume envelope of a sound. The 02R features comprehensive dynamics processors for all the input channels, tape returns, and the bus and stereo outputs. These processors allow you to compress, expand, compress-expand (compand), gate, or duck the signals passing through the mixer, giving you unparalleled sonic quality and flexibility.

Preset Dynamics Programs

These are the preset dynamics programs.

No	Program Name	No	Program Name
1	A.Dr.BD "CMP	21	BrassSection "CMP
2	A.Dr.BD "EXP	22	Syn.Pad "CMP
3	A.Dr.BD "GAT	23	SamplingPerc "CPS
4	A.Dr.BD "CPH	24	Sampling BD "CMP
5	A.Dr.SN "CMP	25	Sampling SN "CMP
6	A.Dr.SN "EXP	26	Hip Comp "CPS
7	A.Dr.SN "GAT	27	Solo Vocal1 "CMP
8	A.Dr.SN "CPS	28	Solo Vocal2 "CMP
9	A.Dr.Tom "EXP	29	Chorus "CMP
10	A.Dr.OverTop "CPS	30	Compander(H) "CPH
11	E.B.finger "CMP	31	Compander(S) "CPS
12	E.B.slapp "CMP	32	Click Erase "EXP
13	Syn.Bass "CMP	33	Announcer "CPH
14	Piano1 "CMP	34	Easy Gate "GAT
15	Piano2 "CMP	35	BGM Ducking "DUK
16	E.Guitar "CMP	36	Limiter1 "CPS
17	A.Guitar "CMP	37	Limiter2 "CMP
18	Strings1 "CMP	38	Total Comp1 "CMP
19	Strings2 "CMP	39	Total Comp2 "CMP
20	Strings3 "CMP	40	Total Comp3 "CMP

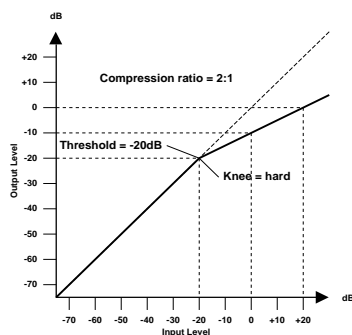

Compressor

A compressor provides a form of automatic level control. By attenuating high levels, thus effectively reducing the dynamic range, the compressor makes it much easier to control signals and set appropriate fader levels. Reducing the dynamic range also means that recording levels can be set higher, therefore improving the signal-to-noise performance.

Compressor (CMP) parameters:

Parameter	Value
Threshold (dB)	-54 to 0 (55 points)
Ratio	1.0, 1.1, 1.3, 1.5, 1.7, 2.0, 2.5, 3.0, 3.5, 4.0, 5.0, 6.0, 8.0, 10, 20, ∞ (16 points)
Attack (ms)	0 to 120 (121 points)
Outgain (dB)	0 to +18 (36 points)
Knee	hard, 1, 2, 3, 4, 5 (6 points)
Release (ms)	5 ms to 42.3 sec ^{*1} , 6 ms to 46.0 sec ^{*2} , 8 ms to 63.4 sec ^{*3} (160 points)

*1 These values are obtained when the sampling frequency is 48 kHz.

*2 These values are obtained when the sampling frequency is 44.1 kHz.

*3 These values are obtained when the sampling frequency is 32 kHz

Threshold determines the level of input signal required to trigger the compressor. Signals at a level below the threshold pass through unaffected. Signals at and above the threshold level are compressed by the amount specified using the Ratio parameter. The trigger signal is determined using the KEY IN parameter.

Note: See "KEY IN" on page 84 of the User's Guide for an explanation of the KEY IN parameter.

Ratio controls the amount of compression—the change in output signal level relative to change in input signal level. With a 2:1 ratio, for example, a 10 dB change in input level (above the threshold) results in a 5 dB change in output level. For a 5:1 ratio, a 10 dB change in input level (above the threshold) results in a 2 dB change in output level.

Attack controls how soon the signal is compressed once the compressor has been triggered. With a fast attack time, the signal is compressed almost immediately. With a slow attack time, the initial transient of a sound passes through unaffected.

Out Gain sets the compressor's output signal level. Compression tends to reduce the average signal level. Out Gain can be used to counter this level reduction and set an appropriate level for the next stage in the audio path.

Knee sets the transition of the signal at the threshold. With a hard knee, the transition between uncompressed and compressed signal is immediate. With the softest knee, *knee5*, the transition starts before the signal reaches the threshold and gradually ends above the threshold.

Release determines how soon the compressor returns to its normal gain once the trigger signal level drops below the threshold. If the release time is too short, the gain will recover too quickly causing level pumping—noticeable gain fluctuations. If it is set too long, the compressor may not have time to recover before the next high level signal appears, and it will be compressed incorrectly.

Expander

An expander is another form of automatic level control. By attenuating the signal below the threshold, the expander reduces low-level noise and effectively increases the dynamic range of the recorded material.

Expander (EXP) parameters:

Parameter	Value
Threshold (dB)	-54 to 0 (55 points)
Ratio	1.0, 1.1, 1.3, 1.5, 1.7, 2.0, 2.5, 3.0, 3.5, 4.0, 5.0, 6.0, 8.0, 10, 20, ∞ (16 points)
Attack (ms)	0 to 120 (121 points)
Outgain (dB)	0 to +18 (36 points)
Knee	hard,1,2,3,4,5 (6 points)
Release (ms)	5 ms to 42.3 sec ^{*1} , 6 ms to 46.0 sec ^{*2} , 8 ms to 63.4 sec ^{*3} (160 points)

*1 These values are obtained when the sampling frequency is 48kHz.

*2 These values are obtained when the sampling frequency is 44.1 kHz.

*3 These values are obtained when the sampling frequency is 32 kHz

Threshold determines the level of input signal required to trigger the expander. Signals above the threshold pass through unaffected. Signals at and below the threshold level are attenuated by the amount specified using the Ratio parameter. The trigger signal is determined using the KEY IN parameter.

Ratio controls the amount of expansion—the change in output signal level relative to change in input signal level. With a 1:2 ratio, for example, a 5 dB change in input level (below the threshold) results in a 10 dB change in output level. For a 1:5 ratio, a 2 dB change in input level (below the threshold) results in a 10 dB change in output level.

Attack controls how soon the signal is expanded once the expander has been triggered. With a fast attack time, the signal is expanded almost immediately. With a slow attack time, the initial transient of a sound passes through unaffected.

Out Gain sets the expander's output signal level.

Knee sets the transition of the signal at the threshold. With a hard knee, the transition between unexpanded and expanded signal is immediate. With the softest knee, knee5, the transition starts before the signal reaches the threshold and gradually ends above the threshold.

Release determines how soon the expander returns to its normal gain once the trigger signal level drops below the threshold.

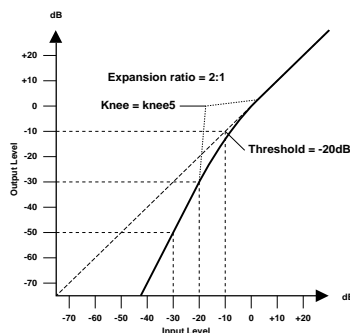
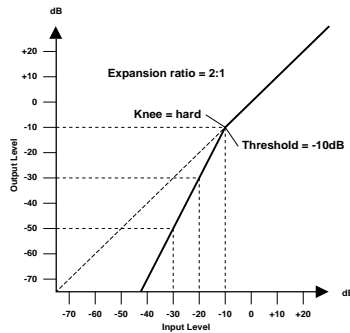

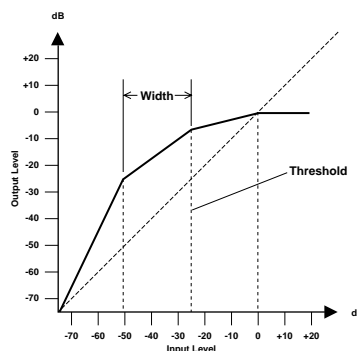

Compander

A compander is a compressor-expander—a combination of signal compression and expansion. The compander attenuates the input signal above the threshold as well as the level below the width. For very dynamic material, this program allows you to retain the dynamic range without having to be concerned with excessive output signal levels and clipping.

CompanderH (CPH) and CompanderS (CPS) parameters:

Parameter	Value
Threshold (dB)	-54 to 0 (55 points)
Ratio	1.0, 1.1, 1.3, 1.5, 1.7, 2.0, 2.5, 3.0, 3.5, 4.0, 5.0, 6.0, 8.0, 10, 20 (15 points)
Attack (ms)	0 to 120 (121 points)
Outgain (dB)	-18 to 0 (36 points)
Width (dB)	1 to 90 (90 points)
Release (ms)	5 ms to 42.3 sec ^{*1} , 6 ms to 46.0 sec ^{*2} , 8 ms to 63.4 sec ^{*3} (160 points)

*1 These values are obtained when the sampling frequency is 48kHz.

*2 These values are obtained when the sampling frequency is 44.1 kHz.

*3 These values are obtained when the sampling frequency is 32 kHz

Threshold determines the level of input signal required to trigger the compander. Signals above the threshold pass through unaffected. Signals at and below the threshold level are attenuated by the amount specified using the Ratio parameter. The trigger signal is determined using the KEY IN parameter.

Ratio controls the amount of companding—the change in output signal level relative to change in input signal level. With a 2:1 ratio, for example, a 10 dB change in input level (above the threshold) results in a 5 dB change in output level. The hard compander (CPH) has a fixed ratio of 5:1 for expansion and the soft compander (CPS) has a fixed ratio of 1.5:1 for expansion.

Attack controls how soon the signal is companded once the compander has been triggered. With a fast attack time, the signal is companded almost immediately. With a slow attack time, the initial transient of a sound passes through unaffected.

Out Gain sets the compander's output signal level.

Width is used to determine the distance, in decibels, between the expander and the compressor. With a width of 90 dB, the expander is effectively switched off and the compander is simply a compressor-limiter. With a smaller width (30dB) and a high threshold (0dB), the compander is an expander-compressor-limiter.

Release determines how soon the compander returns to its normal gain once the trigger signal level drops below the threshold.

Gate and Ducking

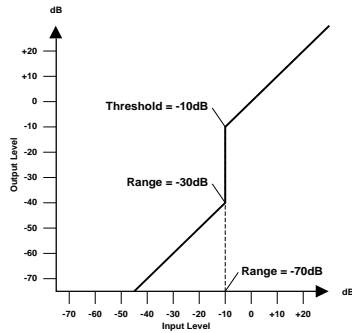

A gate, or noise gate is an audio switch used to mute signals below a set threshold level. It can be used to suppress background noise and hiss from valve (tube) amps, effects pedals, and microphones.

Ducking is used to automatically reduce the levels of one signal when the level of a source signal exceeds a specified threshold. It is used for voice-over applications where, for example, level of background music is automatically reduced, allowing an announcer to be heard clearly.

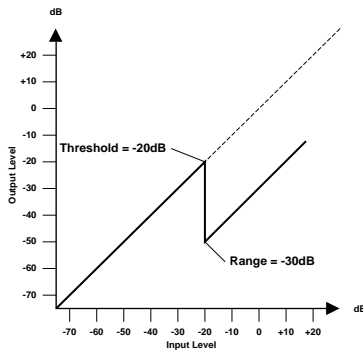

Gate (GAT) and Ducking (DUK) parameters:

Parameter	Value
Threshold (dB)	-54 to 0 (55 points)
Range (dB)	-70 to 0 (71 points)
Attack (ms)	0 to 120 (121 points)
Hold (ms)	0.02 ms to 1.96s ^{*1} , 0.02 ms to 2.13 sec ^{*2} , 0.03 ms to 2.94 sec ^{*3} (216 points)
Decay (ms)	5ms to 42.3s ^{*1} , 6 ms to 46.0 sec ^{*2} , 8 ms to 63.4 sec ^{*3} (160 points)

*1 These values are obtained when the sampling frequency is 48kHz.

*2 These values are obtained when the sampling frequency is 44.1 kHz.

*3 These values are obtained when the sampling frequency is 32 kHz

Threshold sets the level at which the gate closes, cutting off the signal. Signals above the threshold level pass through unaffected. Signals at or below the threshold cause the gate to close.

For ducking, trigger signal levels at and above the threshold level activate ducking, and the signal level is reduced to a level set by the Range parameter.

The trigger signal is determined using the KEY IN parameter.

Range controls the level to which the gate closes. It can be used to reduce the signal level rather than cut it completely. At a setting of -70 dB, the gate closes completely when the input signal falls below the threshold. At a setting of -30 dB, the gate only closes so far allowing an attenuated signal through. At a setting of 0 dB, the gate has no effect. When signals are gated abruptly, the sudden cutoff can sound odd.

For ducking, a setting of -70 dB causes the signal to be virtually cutoff. At a setting of -30 dB the signal is ducked by 30 dB. At a setting of 0 dB, the duck has no effect.

Attack determines how fast the gate opens when the signal exceeds the threshold level. Slow attack times can be used to remove the initial transient edge of percussive sounds. Too slow an attack time makes some signals sound backwards.

For ducking, this controls how soon the signal is ducked once the duck has been triggered. With a fast attack time, the signal is ducked almost immediately. With a slow attack time, ducking fades the signal. Too fast an attack time may sound abrupt.

Hold sets how long the gate stays open or the ducking remains active once the trigger signal has fallen below the threshold level.

Decay controls how fast the gate closes once the hold time has expired. A longer decay time produces a more natural gating effect, allowing the natural decay of an instrument to pass through.

For ducking, this determines how soon the ducker returns to its normal gain after the hold time has expired.

DYNAMICS Display Function

1. Use the (DYNAMICS) button to locate the DYNAMICS 1/2 page.



2. Select a channel using the (SEL) buttons.

Note: Press the [SEL] button for the STEREO channel to access the dynamics processors for the output buses.

Dynamics can be applied to the input channels (MIC/LINE 1 through 16, LINE 17/18 through 23/24), the tape return channels (TAPE 1 through 16), the internal bus outputs (BUS 1 through 8), and the stereo output. For stereo and paired channels, the dynamics processor is applied equally to both channels.

Shown below is the DYNAMICS 1/2 page.

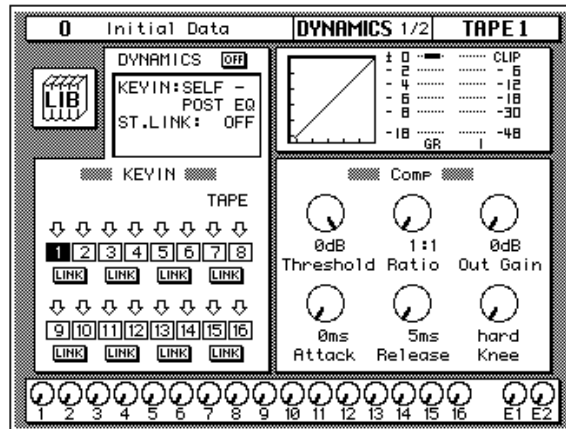

The DYNAMICS 1/2 page shows the dynamics settings of the currently selected channel.

The top of the page contains the dynamics LIB icon, the DYNAMICS icon, the main control prompts (KEY IN, ST.LINK, and optionally IN), the dynamics graph, and the gain reduction meter plus a level meter for the currently selected channel pair.

The bottom of the page is split into two main sections:

The first section shows the channel KEY IN settings and LINK icons. These settings can be changed using the CURSOR buttons, the encoder wheel, and [ENTER] button.

The second section contains the controls for adjusting the parameters for the currently selected channel. There are rotary icons for the threshold, ratio, output gain, attack, release, and so on, depending on which dynamics program you have selected. Use the CURSOR buttons to select the desired icon and adjust its value with the encoder wheel. Press the [ENTER] button to turn the dynamics processor on or off.

Patching in a Processor

1. To turn the dynamics processor on, use the **CURSOR** buttons to select the **DYNAMICS** icon and press the **(ENTER)** button.

The icon changes from **OFF** to **ON** and is highlighted.

2. Use the **CURSOR** buttons to select the **KEY IN** prompt and rotate the encoder wheel or press the **(ENTER)** button to select a trigger source.
3. Use the **CURSOR** buttons to select the **ST.LINK** prompt and rotate the encoder wheel or press the **(ENTER)** button to turn the stereo link on or off.
4. If the stereo link is on, use the **CURSOR** buttons to select the **IN** prompt and rotate the encoder wheel or press the **(ENTER)** button to select the channels to patch the dynamics processor into.

DYNAMICS Icon

The **DYNAMICS ON/OFF** icon is used to turn the dynamics processor on or off for the selected channel.

Control Prompts

The main control prompts are used to patch a dynamics processor into a channel or stereo pair:

Prompt	Value
KEY IN	SELF - POST EQ, SELF - PRE EQ, LEFT - POST EQ, LEFT - PRE EQ, AUX 1, AUX 2
ST.LINK	ON, OFF
IN	BOTH, L (left/odd), R (right/even)

KEY IN selects the processor trigger source—the signal that triggers, or activates the processor. You can select the current channel either before or after equalization, the left channel (again either before or after equalization), or either **AUX 1** or **AUX 2**.

You cannot select the left channel (before or after equalization) for the first input channel, **MIC/LINE 1**, the first tape return channel, **TAPE 1**, the first bus channel, or the stereo output channel.

ST.LINK determines if a channel pair is to be linked together. You cannot turn it off while channels are configured as a stereo pair.

IN appears only when **ST.LINK** is set to **ON**. It determines whether a dynamics processor is patched into just the left/odd channel (**L**), right/even channel (**R**), or both (**BOTH**).

Note: *The **DYNAMICS ON/OFF**, **KEY IN**, **ST.LINK**, and **IN** parameters are not stored in the dynamics programs. These are individual channel (or stereo pair) parameters and are stored in the scene memories. **DYNAMICS ON/OFF** can be stored in channel programs.*

Dynamics Processor Meters

The amount of processor gain reduction (GR) and the output signal levels are shown on the DYNAMICS 1/2 and 2/2 pages, as shown below.

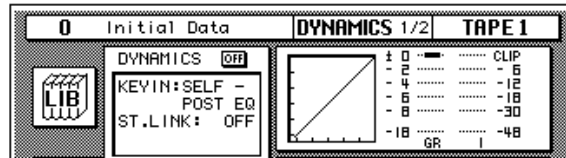

Gain reduction is the amount by which a signal's level is reduced. The output signal levels are conventional level meters which work from bottom-to-top. The GR level meter is inverted and works from top-to-bottom.

For compression, expansion, companding, and ducking, the GR meter operates when the processor is active, that is when it has been triggered by the KEY IN signal, and it shows the amount of signal level reduction.

For a gate, the processor is active when the input signal is below the threshold. So the GR meter operates when the input signal is below the threshold and also when there is no input signal.

Dynamics Graph

The dynamics graph gives you a visual indication of how the parameters of the dynamics processor will effect the signal as it passes through. The horizontal axis of the graph indicates the input signal. The vertical axis indicates the output signal:

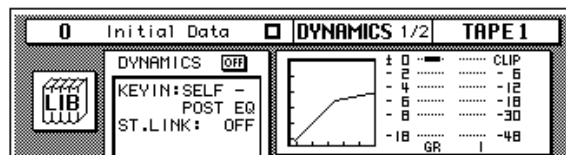

When the dynamics graph is a straight line at 45° from the bottom left corner of the graph, it indicates that the dynamics processor will have no effect on the input signal.

KEY IN and LINK Indicators

The channel KEY IN settings and LINK settings are shown below.

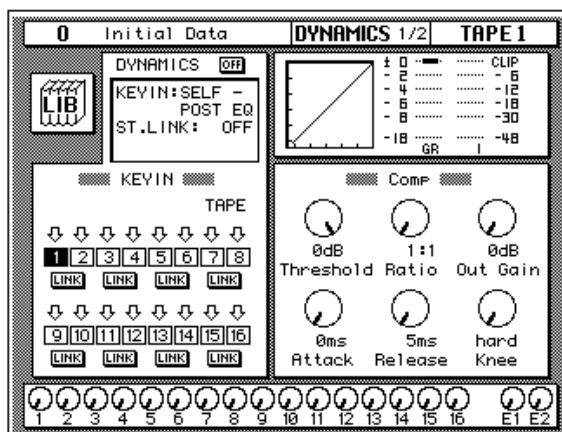

The settings can be changed with the CURSOR buttons, and the encoder wheel, or the [ENTER] button. The following table shows the meaning of the KEY IN icons:

Icon	Meaning
	SELF – POST EQ—the trigger is taken from the current channel after the equalization.
	SELF – PRE EQ—the trigger is taken from the current channel before equalization.
	LEFT – POST EQ—the trigger is taken from the left channel after the equalization.
	LEFT – PRE EQ—the trigger is taken from the left channel before equalization.
	AUX 1—the trigger is taken from the first auxiliary channel.
	AUX 2—the trigger is taken from the second auxiliary channel.

The KEY IN icons duplicate the KEY IN prompt, giving you a faster visual indication of the channel status. When the cursor is on a KEY IN icon, press the [ENTER] button to select that channel. The only way you can select the output buses 1 through 8 is with this method.

The LINK icons duplicate the ST.LINK prompt, giving you a faster visual indication of the channel status.

Dynamics Library

1. Use the (DYNAMICS) button to locate the DYNAMICS 2/2 page.



The DYNAMICS Library page appears.

Recalling Dynamics Programs

1. Select a channel using the (SEL) buttons.
2. Use the CURSOR buttons to select the RECALL icon and rotate the encoder wheel to select a dynamics program.
3. Press the (ENTER) button. The dynamics program is recalled.

Storing Dynamics Programs

1. Use the CURSOR buttons to select the STORE icon and select a dynamics program with the encoder wheel.
2. Use the CURSOR buttons and encoder wheel to name the program.
3. Press the (ENTER) button. A confirmation dialog box appears.
4. Select EXECUTE and press the (ENTER) button. The dynamics program is stored.

The Dynamics Library is used to access and store dynamics programs. There are 40 preset programs (1 to 40) for you to recall and 88 user programs (41 to 128 plus UNDO) for you to store your own dynamics programs.

You can access this page from the DYNAMICS 1/2 page by selecting the LIB icon with the CURSOR buttons and pressing the [ENTER] button.

Shown below is the DYNAMICS 2/2 page.

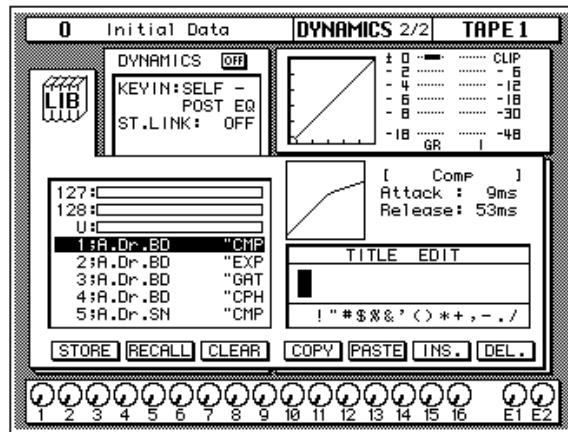

The top of the page shows the dynamics LIB icon, the main control prompts, the dynamics graph, and the gain reduction meter plus a level meter for the currently selected channel pair.

The middle of the page shows a scrolling list of dynamics programs. The name of the dynamics program under the cursor is highlighted. When the cursor is on the STORE, RECALL, CLEAR, COPY, or PASTE icons, the encoder wheel is used to scroll through the program list. A small diagram of the dynamics graph of the highlighted program is shown to the right along with its vital statistics, such as Attack, Hold, Decay, and so forth.

Beside the list of dynamics programs is the TITLE EDIT field. The CURSOR buttons are used to select the character, and the encoder wheel is used to change its value.

The bottom of the page contains several icons. Use the CURSOR buttons to select from the STORE, RECALL, CLEAR, COPY, PASTE, INS., and DEL. icons.

Exiting the Library

Selecting the LIB icon and pressing the [ENTER] button switches back to the DYNAMICS 1/2 page. You can also use the [DYNAMICS] button.

Icons

- **STORE**—This icon is used to store the current program to the library. Select the icon with the CURSOR buttons. Use the encoder wheel to select a program and press the [ENTER] button. The 02R displays a confirmation dialog box asking if you want to store your settings in the selected program. The dialog box has two icons: “CANCEL” and “EXECUTE”.

Note: You can customize your 02R to prevent the confirmation dialog box appearing during the STORE operation. See “Preferences” on page 198 of the User’s Guide for more information.

CANCEL is the default. To cancel the STORE operation, either press the [ENTER] button or wait about 10 seconds—the STORE operation will be automatically cancelled.

To store your settings, use the CURSOR buttons to select the “EXECUTE” icon and press the [ENTER] button. The program is stored.

When you confirm a STORE operation, any existing data in the selected program location is overwritten.

YOU SHOULD ALWAYS BE CAREFUL WHEN THE 02R DISPLAYS A CONFIRMATION DIALOG BOX!

- **RECALL**—This icon is used to recall a program from the library. Select the icon with the CURSOR buttons. Use the encoder wheel to select a program and press the [ENTER] button. The recalled program is now the current program.
- **CLEAR**—This icon is used to clear the contents of a dynamics program. Use the CURSOR buttons to select the icon. Use the encoder wheel to select a dynamics program and press the [ENTER] button. The 02R displays a confirmation dialog box asking if you want to clear the dynamics program. The dialog box has two icons: “CANCEL” and “EXECUTE”.

Note: You can customize your 02R to prevent the confirmation dialog box appearing during the CLEAR operation. See “Preferences” on page 198 of the User’s Guide for more information.

CANCEL is the default. To cancel the CLEAR operation, either press the [ENTER] button or wait about 10 seconds—the CLEAR operation will be automatically cancelled.

To clear the dynamics program, use the CURSOR buttons to select the “EXECUTE” icon and press the [ENTER] button. The program is cleared.

If you change your mind, the cleared dynamics program can be retrieved by recalling the Undo dynamics program (U).

- **COPY**—This icon is used to copy the name of a library program. Select the icon with the CURSOR buttons. Use the encoder wheel to select a program and press the [ENTER] button. The program name is copied into an edit buffer.

- **PASTE**—This icon is used to paste a program name previously selected with the COPY operation into the TITLE EDIT box. Select the icon with the CURSOR buttons and press the [ENTER] button. The program name is pasted from the edit buffer into the TITLE EDIT box for subsequent editing.
- **INS.**—This icon is used to insert blank characters into the TITLE EDIT box at the current cursor location. Select the icon with the CURSOR buttons and press the [ENTER] button.
- **DEL.**—This icon is used to delete characters from the TITLE EDIT box at the current cursor location. Select the icon with the CURSOR buttons and press the [ENTER] button.

UNDO Operation

When the 02R stores or recalls a program, the previous settings are always preserved in the UNDO buffer. If you discover you have made a mistake, you can always recall the UNDO buffer (displayed as “U:” in the scrolling list of programs). Use the CURSOR buttons to select the RECALL icon, then rotate the encoder wheel until the UNDO buffer is the current program, and press the [ENTER] button. The previous settings are restored.

Program Name

Dynamics program names can be up to 16 characters in length and can contain any of the following characters:

	!	“	#	\$	%	&	'	()	*	+	,	-	.	/
0	1	2	3	4	5	6	7	8	9	:	;	<	=	>	?
@	A	B	C	D	E	F	G	H	I	J	K	L	M	N	O
P	Q	R	S	T	U	V	W	X	Y	Z	[\]	^	_
`	a	b	c	d	e	f	g	h	i	j	k	l	m	n	o
p	q	r	s	t	u	v	w	x	y	z	{		}	~	

Preset Dynamics Program Parameters

The “Release”, “Hold”, and “Decay” values shown in the following table are valid when the 02R is set at a sampling frequency of 44.1 kHz.

No.	Name	Type	Parameter	Value	Description	
1	A.Dr.BD	"CMP	Compressor	Threshold (dB)	-24	Compressor that gives the best results with an acoustic bass drum.
				Ratio (:1)	3	
				Attack (ms)	9	
				Outgain (dB)	5.5	
				Release (ms)	58	
2	A.Dr.BD	"EXP	Expander	Threshold (dB)	-23	Expander for the same purpose as program 1.
				Ratio (:1)	1.7	
				Attack (ms)	1	
				Outgain (dB)	3.5	
				Release (ms)	70	
3	A.Dr.BD	"GAT	Gate	Threshold (dB)	-11	Gate for the same purpose as program 1.
				Range (dB)	-53	
				Attack (ms)	0	
				Decay (ms)	400	
4	A.Dr.BD	"CPH	CompanderH	Threshold (dB)	-11	Hard compander for the same purpose as program 1.
				Ratio (:1)	3.5	
				Attack (ms)	1	
				Outgain (dB)	-1.5	
				Release (ms)	192	
5	A.Dr.SN	"CMP	Compressor	Threshold (dB)	-17	Compressor that gives the best results with an acoustic snare drum.
				Ratio (:1)	2.5	
				Attack (ms)	8	
				Outgain (dB)	3.5	
				Release (ms)	12	
6	A.Dr.SN	"EXP	Expander	Threshold (dB)	-23	Expander for the same purpose as program 5.
				Ratio (:1)	2	
				Attack (ms)	0	
				Outgain (dB)	0.5	
				Release (ms)	151	

No.	Name	Type	Parameter	Value	Description	
7	A.Dr.SN	"GAT	Gate	Threshold (dB)	-8	Gate for the same purpose as program 5.
				Range (dB)	-23	
				Attack (ms)	1	
				Hold (ms)	0.63	
				Decay (ms)	238	
8	A.Dr.SN	"CPS	CompanderS	Threshold (dB)	-8	Soft compander for the same purpose as program 5.
				Ratio (:1)	1.7	
				Attack (ms)	11	
				Outgain (dB)	0.0	
				Release (ms)	128	
9	A.Dr.Tom	"EXP	Expander	Threshold (dB)	-20	Expander for acoustic toms automatically reduces the volume when the toms are not played, helping to differentiate the bass and snare drums clearly.
				Ratio (:1)	2	
				Attack (ms)	2	
				Outgain (dB)	5.0	
				Knee	2	
10	A.Dr.OverTop	"CPS	CompanderS	Threshold (dB)	-24	Soft compander to emphasize the attack and ambience of cymbals using overhead microphones. It automatically reduces the volume when the cymbals are not played, helping differentiate the bass and snare drums clearly.
				Ratio (:1)	2	
				Attack (ms)	38	
				Outgain (dB)	-3.5	
				Release (ms)	842	
11	E.B.finger	"CMP	Compressor	Threshold (dB)	-12	Compressor to equalize the attack and volume level of a finger-picked electric bass guitar.
				Ratio (:1)	2	
				Attack (ms)	15	
				Outgain (dB)	4.5	
				Release (ms)	470	
12	E.B.slapp	"CMP	Compressor	Threshold (dB)	-12	Compressor to equalize the attack and volume level of a slap electric bass guitar
				Ratio (:1)	1.7	
				Attack (ms)	6	
				Outgain (dB)	4.0	
				Release (ms)	133	
13	Syn.Bass	"CMP	Compressor	Threshold (dB)	-10	Compressor to adjust and/or emphasize the level of a synth bass.
				Ratio (:1)	3.5	
				Attack (ms)	9	
				Outgain (dB)	3.0	
				Release (ms)	250	

No.	Name	Type	Parameter	Value	Description	
14	Piano1	"CMP	Compressor	Threshold (dB)	-9	Compressor to brighten the tonal color of a piano.
				Ratio (:1)	2.5	
				Attack (ms)	17	
				Outgain (dB)	1.0	
				Knee	hard	
				Release (ms)	238	
15	Piano2	"CMP	Compressor	Threshold (dB)	-18	A variation on program 14, adjusting the attack and entire level using a deeper threshold.
				Ratio (:1)	3.5	
				Attack (ms)	7	
				Outgain (dB)	6.0	
				Knee	2	
				Release (ms)	174	
16	E.Guitar	"CMP	Compressor	Threshold (dB)	-8	Compressor for backing performances, such as electric rhythm guitar playing chords or arpeggios.
				Ratio (:1)	3.5	
				Attack (ms)	7	
				Outgain (dB)	2.5	
				Knee	4	
				Release (ms)	261	
17	A.Guitar	"CMP	Compressor	Threshold (dB)	-10	A variation on program 16, intended for acoustic guitar playing rhythm chords or arpeggios.
				Ratio (:1)	2.5	
				Attack (ms)	5	
				Outgain (dB)	1.5	
				Knee	2	
				Release (ms)	238	
18	Strings1	"CMP	Compressor	Threshold (dB)	-11	Compressor for string instruments. This program was intended for violins.
				Ratio (:1)	2	
				Attack (ms)	33	
				Outgain (dB)	1.5	
				Knee	2	
				Release (ms)	749	
19	Strings2	"CMP	Compressor	Threshold (dB)	-12	A variation on program 18, intended for violas or cellos.
				Ratio (:1)	1.5	
				Attack (ms)	93	
				Outgain (dB)	1.5	
				Knee	4	
				Release (ms)	1.35 S	
20	Strings3	"CMP	Compressor	Threshold (dB)	-17	A variation on program 18, intended for string instruments with a very low range, such as cellos or contrabass.
				Ratio (:1)	1.5	
				Attack (ms)	76	
				Outgain (dB)	2.5	
				Knee	2	
				Release (ms)	186	

No.	Name	Type	Parameter	Value	Description	
21	BrassSection	"CMP	Compressor	Threshold (dB)	-18	Compressor intended for brass sounds with fast and strong attack.
				Ratio (:1)	1.7	
				Attack (ms)	18	
				Outgain (dB)	4.0	
				Knee	1	
				Release (ms)	226	
22	Syn.Pad	"CMP	Compressor	Threshold (dB)	-13	Compressor for synth pad, intended to prevent diffusion of the sound.
				Ratio (:1)	2	
				Attack (ms)	58	
				Outgain (dB)	2.0	
				Knee	1	
				Release (ms)	238	
23	SamplingPerc	"CPS	CompanderS	Threshold (dB)	-18	Compressor for sampled sounds to boost them to be as powerful and clear as the acoustic sounds. This program is for percussion sounds.
				Ratio (:1)	1.7	
				Attack (ms)	8	
				Outgain (dB)	-2.5	
				Width (dB)	18	
				Release (ms)	238	
24	Sampling BD	"CMP	Compressor	Threshold (dB)	-14	A variation on program 23, intended for sampled bass drum sounds.
				Ratio (:1)	2	
				Attack (ms)	2	
				Outgain (dB)	3.5	
				Knee	4	
				Release (ms)	35	
25	Sampling SN	"CMP	Compressor	Threshold (dB)	-18	A variation on program 23, intended for sampled snare drum sounds.
				Ratio (:1)	4	
				Attack (ms)	8	
				Outgain (dB)	8.0	
				Knee	hard	
				Release (ms)	354	
26	Hip Comp	"CPS	CompanderS	Threshold (dB)	-23	A variation on program 23, intended for sampled sounds for loops.
				Ratio (:1)	20	
				Attack (ms)	15	
				Outgain (dB)	0.0	
				Width (dB)	15	
				Release (ms)	163	
27	Solo Vocal1	"CMP	Compressor	Threshold (dB)	-20	Compressor suited for a solo vocal source.
				Ratio (:1)	2.5	
				Attack (ms)	31	
				Outgain (dB)	2.0	
				Knee	1	
				Release (ms)	342	

No.	Name	Type	Parameter	Value	Description	
28	Solo Vocal2	"CMP	Compressor	Threshold (dB)	-8	A variation on program 27.
				Ratio (:1)	2.5	
				Attack (ms)	26	
				Outgain (dB)	1.5	
				Knee	3	
				Release (ms)	331	
29	Chorus	"CMP	Compressor	Threshold (dB)	-9	A variation on program 27, intended for chorus vocals.
				Ratio (:1)	1.7	
				Attack (ms)	39	
				Outgain (dB)	2.5	
				Knee	2	
				Release (ms)	226	
30	Compander(H)	"CPH	CompanderH	Threshold (dB)	-10	A template for the hard knee compander program.
				Ratio (:1)	3.5	
				Attack (ms)	1	
				Outgain (dB)	0.0	
				Width (dB)	6	
				Release (ms)	250	
31	Compander(S)	"CPS	CompanderS	Threshold (dB)	-8	A template for the soft knee compander program.
				Ratio (:1)	4	
				Attack (ms)	25	
				Outgain (dB)	0.0	
				Width (dB)	24	
				Release (ms)	180	
32	Click Erase	"EXP	Expander	Threshold (dB)	-33	Expander to remove click track sounds that may bleed out of the monitor headphones the musicians are using.
				Ratio (:1)	2	
				Attack (ms)	1	
				Outgain (dB)	2.0	
				Knee	2	
				Release (ms)	284	
33	Announcer	"CPH	CompanderH	Threshold (dB)	-14	Hard compander reduces the level during the interval between the words, making the voice sound even.
				Ratio (:1)	2.5	
				Attack (ms)	1	
				Outgain (dB)	-2.5	
				Width (dB)	18	
				Release (ms)	180	
34	Easy Gate	"GAT	Gate	Threshold (dB)	-26	A template for the gate program.
				Range (dB)	-56	
				Attack (ms)	0	
				Hold (ms)	2.56	
				Decay (ms)	331	

No.	Name	Type	Parameter	Value	Description
35	BGM Ducking "DUK	Ducking	Threshold (dB)	-19	Ducking background music for voiceovers, typically keyed from the announcer's channel.
			Range (dB)	-22	
			Attack (ms)	93	
			Hold (ms)	1.20 S	
			Decay (ms)	6.32 S	
36	Limiter1 "CMP	CompanderS	Threshold (dB)	-8	A template for a limiter using the soft compander program. This program has a slow release.
			Ratio (:1)	4	
			Attack (ms)	25	
			Outgain (dB)	0.0	
			Width (dB)	24	
			Release (ms)	180	
37	Limiter2 "CMP	Compressor	Threshold (dB)	0	A template for a limiter using the compressor program. This program is a PEAK STOP type.
			Ratio (:1)	∞	
			Attack (ms)	0	
			Outgain (dB)	0.0	
			Knee	hard	
			Release (ms)	319	
38	Total Comp1 "CMP	Compressor	Threshold (dB)	-8	Compressor intended to reduce the overall volume level. Use for the stereo out during mixdown. It is also interesting on stereo input signals.
			Ratio (:1)	2.5	
			Attack (ms)	60	
			Outgain (dB)	0.0	
			Knee	2	
			Release (ms)	1.12 S	
39	Total Comp2 "CMP	Compressor	Threshold (dB)	-18	A variation of program 38. It has a harder compression ratio.
			Ratio (:1)	3.5	
			Attack (ms)	94	
			Outgain (dB)	2.5	
			Knee	hard	
			Release (ms)	447	
40	Total Comp3 "CMP	Compressor	Threshold (dB)	-16	A variation of program 38. It has an extreme compression ratio, almost a limiter in effect.
			Ratio (:1)	6	
			Attack (ms)	11	
			Outgain (dB)	6.0	
			Knee	1	
			Release (ms)	180	

7

Auxiliary Channels

In this chapter...

About the 02R Auxiliaries	98
The AUX Buttons.....	99
Stereo Input Channels.....	101
AUX [ON] Button	101
AUX Pre or Post.....	101
Monitor Mix	102

About the 02R Auxiliaries

The 02R has eight auxiliary sends: AUX 1, AUX 2, AUX 3, AUX 4, AUX 5, AUX 6, AUX 7, and AUX 8. The auxiliary sends can be configured pre-fader or post-fader.

AUX 7 and AUX 8 are used to feed the internal effects processors: Effect 1 and Effect 2. EFF 1 RTN and EFF 2 RTN are used to return the processed signals. Refer to “Internal Effects” on page 103 of the *User’s Guide* for further details.

The other auxiliary sends can be used to feed external effects processors, foldback amplifiers, or multitrack recording equipment. When a send is used to feed an external effects processor, the processed signal can be returned via one of the stereo input channels or an unused monophonic input channel.

There are two different ways to access the auxiliary send channels:

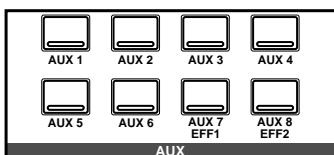

DISPLAY ACCESS—AUX buttons

These buttons access the AUX pages that set the auxiliary send levels for the recording console.

- The [AUX 1] to [AUX 6] buttons set the auxiliary send levels to the corresponding auxiliary bus. You can also select whether to send the signal pre or post fader.
- The [AUX 7] and [AUX 8] buttons also set the send levels to the corresponding auxiliary bus and can select pre or post fader. However, these two sends are routed to the internal effects unit. Therefore, the buttons also allow you to select and set the effects parameters.

The channel aux send level controls for each aux send are displayed on two pages. The first page shows MIC/LINE aux controls. The second, TAPE and effects returns aux controls.

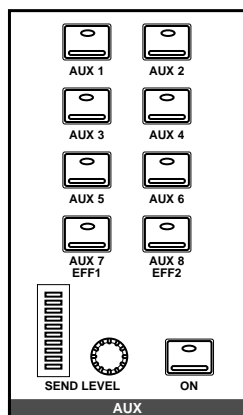

SELECTED CHANNEL—AUX controls

These buttons and controls set the auxiliary send levels for the currently selected channel.

- The [AUX 1] to [AUX 8] buttons allow you to select the auxiliary buses you want to send the selected channel signal to.
- The SEND LEVEL rotary encoder is used to set the level – indicated by the adjacent LED bargraph.
- The [ON] button is used to turn the send on or off. It allows you to make easy A-B comparisons.

The AUX Buttons

1. Press the (AUX 1) button.



The AUX 1 page appears.

2. Select a channel using the (SEL) buttons or the CURSOR buttons.
3. To turn the send on, press the (ON) button in the AUX group of the SELECTED CHANNEL controls. The LED inset in the button illuminates.

Note: The [ON] button is the only way to turn the send on or off.

4. To change the aux send from pre to post-fader, press the (ENTER) button. The icon is highlighted and the text changes to POST when the signal is post fader.

Note: Pre or post fader selection can only be made from the AUX pages.

5. To change the signal level, adjust the corresponding fader or rotary encoder until the desired value is obtained.

Note: This example only shows AUX 1. The other channels are identical in function.

The AUX functions for AUX 1 through AUX 6 set the channel send levels to each of the auxiliary buses. With this function, you can select an auxiliary bus and then set the levels of a group of input channels simultaneously. You can also select whether to send the signal pre or post fader.

Fader Status

When the AUX functions are selected, the faders change from channel level controls to auxiliary send level controls. The faders automatically move to the corresponding auxiliary send levels.

Note: Avoid blocking the fader movements when the faders move to their auxiliary send positions by placing objects on the 02R. It is possible to damage the faders.

The AUX LED of the FADER STATUS indicator will illuminate to indicate the fader status. The number indicator corresponding to current the AUX button is also illuminated:

FADER STATUS							
○	INPUT						
▽	AUX						
1	2	3	4				
5	6	7	8				

The send levels for the input channels are operated by their faders. Press the [FLIP] button, and the send levels for the tape return channels can be operated by the faders. You can also use the rotary encoders to set the tape return levels. The effect return levels can only be adjusted with the rotary encoders.

Note: When you press the [FLIP] button, the faders will automatically move to the levels of the opposite channels (from input levels to tape return levels). Avoid blocking the fader movements when the faders reposition by placing objects on the 02R. It is possible to damage the faders.

SELECTED CHANNEL Controls

You can use the SEND LEVEL encoder in the AUX group of the SELECTED CHANNEL controls to set the signal level to the auxiliary bus. The method of working with these controls is different than working with the DISPLAY ACCESS—AUX buttons.

Select a channel with the [SEL] buttons. Select the auxiliary bus with the [AUX 1] through [AUX 8/EFF 2] buttons. Turn the send on or off with the [ON] button. Adjust the send level with the SEND LEVEL encoder.

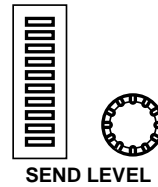

AUX Pages

The channel aux send level controls for each aux send are displayed on two pages. The first page, shown below, shows aux controls for MIC/LINE channels 1 to 24. Select this page using a MIC/LINE [SEL] button.

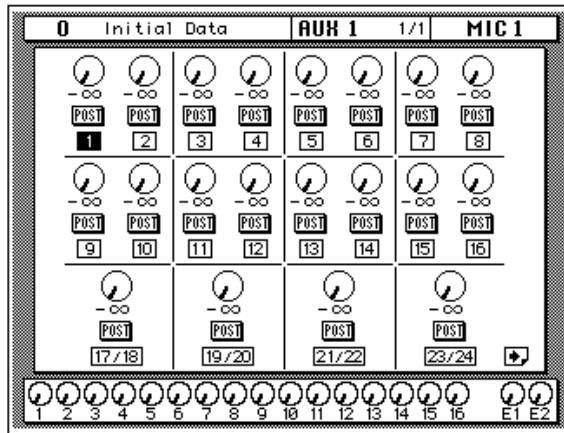

The second page shows aux controls for TAPE channels 1 to 16 and effects returns 1 and 2. Select this page using a TAPE or EFF RTN [SEL] button.

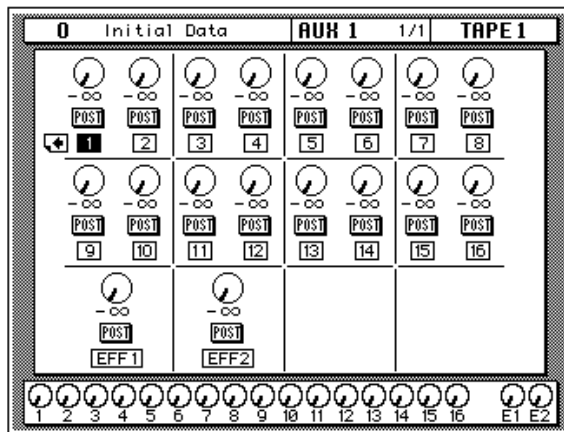

Stereo Input Channels

Input channels 1 through 16 are mono inputs. The stereo input channels 17 through 24 are paired together and handle two signals: left and right. Before feeding a stereo input signal to the auxiliary level controls, the left and right signals are summed to form a mono L+R mix.

AUX (ON) Button

The auxiliary sends can be turned on or off for quick A-B comparisons by using the [ON] button in the AUX group of the SELECTED CHANNEL controls. When the send for a channel is turned off, the send level icon for that channel continues to show the current level setting for the channel, but the text underneath the icon switches to "OFF" giving you a quick visual indicator of the channel send status:

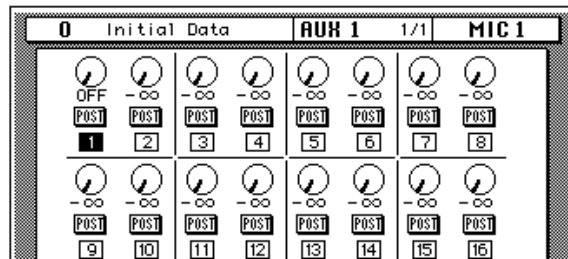

The LED inset in the [ON] button is illuminated when the send for a channel is turned on.

Note: The [ON] button of the SELECTED CHANNEL – AUX controls is the only way to turn the channel send on or off.

AUX Pre or Post

The auxiliary sends can be configured as pre-fader or post-fader. This setting can be changed by selecting a channel with a [SEL] button or the CURSOR buttons and pressing the [ENTER] button for that channel.

If you select a channel with a [SEL] button or the CURSOR buttons and double-click the [ENTER] button, all channels will be set to the same pre-fader or post-fader status as the selected channel.

POST—the auxiliary send signal is sourced after the channel fader. This means that the signal is controlled by the channel fader as well as the send level. In order to send a signal to the auxiliary bus, you must have that fader raised as well. This enables the channel-to-mix and channel-to-effects signal levels to be controlled together, with the former supplying the dry, unaffected signal and the latter supplying the wet, affected signal. This is useful when, for example, you fade-out a channel, since the channel-to-mix and channel-to-effects signals are reduced together.

PRE—the auxiliary send signal is sourced before the channel fader. The send signal is unaffected by the channel fader and its level can be set independently.

Note: *Pre or post-fader selection can only be made from the corresponding AUX page.*

Monitor Mix

1. Press the (AUX 5) button.



The AUX 5 page appears.

2. Select a channel using the (SEL) buttons or the CURSOR buttons.
3. Set the send on and set it to pre/post fader as detailed previously.
4. Press the (AUX 5) button of the STUDIO buttons group.
5. Adjust the STUDIO LEVEL control, then adjust the channel level using the appropriate faders or rotary encoders.

The 02R has two different monitoring outputs—the control room outputs (including the PHONES output) and the studio outputs.

Often during a multitrack recording session, what you want to listen to in the control room is very different from what the musicians need in the studio. For example, while recording a rhythm section, the bass player and the drummer may want to hear the kick drum at a much higher volume than you need in the control room.

To cater to this requirement, the 02R allows you to create a monitor mix using either AUX 5 or AUX 6.

Use the STUDIO buttons to select the monitor signal sent to the studio monitor system. You can monitor the signal on the stereo bus with the [ST] button or select the auxiliary channels (AUX 5 or AUX 6). You can select any combination of the [ST], [AUX 5], and [AUX 6] buttons:

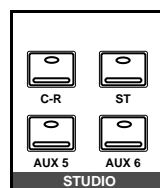

You can also use the [C-R] button to send the signal being monitored in the control room to the studio outputs.

Use the CONTROL ROOM buttons to select the monitor signal sent to the control room monitor system. See “Monitor Selector Switches” on page 29 and “Monitor Level Controls” on page 30 of the *User’s Guide* for more details.

8

Internal Effects

In this chapter...

About Effects	104
Preset Effects Programs	105
AUX 7 and AUX 8	106
Effects	108
Effects Library	109
Preset Effects Program Parameters	112

About Effects

The 02R features two internal multi-effects stereo processors: Effect 1 and Effect 2. These are fed by AUX 7 and AUX 8, and the processed signals are returned via EFF 1 RTN and EFF 2 RTN, respectively. The auxiliary sends can be configured pre-fader or post-fader. Effects can be applied to input channels, the tape return channels, or the stereo output channel. Effects are organized into programs. There are 40 preset effects programs (1 through 40) and 88 user effects programs (41 through 128 plus an UNDO buffer) for you to store your own settings.

There are two different ways to access the internal effects sends:

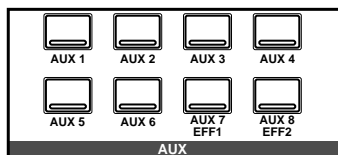

DISPLAY ACCESS—AUX buttons

These buttons access the AUX pages that set the auxiliary send levels for the recording console.

The [AUX 7] and [AUX 8] buttons are routed to the internal effects unit. Use them to set the send levels to the corresponding effects unit and select pre or post fader. These buttons also allow you to select and set the effects parameters.

The channel aux send level controls for each aux send are displayed on two pages. The first page shows MIC/LINE aux controls. The second, TAPE and effects returns aux controls.

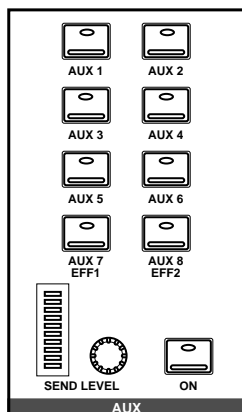

SELECTED CHANNEL—AUX controls

These buttons and controls set the auxiliary send levels for the currently selected channel.

- The [AUX 1] to [AUX 8] buttons allow you to select the auxiliary buses you want to send the selected channel signal to.
- The SEND LEVEL rotary encoder is used to set the level—indicated by the adjacent LED bargraph.
- The [ON] button is used to turn the send on or off. It allows you to make easy A-B comparisons.

Preset Effects Programs

These are the preset effects programs:

No	Program Name	No	Program Name
1	REVERB HALL1	21	REVERSE GATE
2	REVERB HALL2	22	DELAY->EARLY REF
3	REVERB ROOM1	23	DELAY L-C-R 1
4	REVERB ROOM2	24	DELAY L-C-R 2
5	REVERB STAGE	25	CHORUS->DLY LCR
6	REVERB PLATE	26	MONODLY->CHORUS
7	REV AMBIENCE1	27	STEREO INI.DLY ECHO
8	REV AMBIENCE2	28	ECHO
9	REV LIVE ROOM1	29	CROSS ECHO
10	REV LIVE ROOM2	30	CROSS DELAY
11	REVERB VOCAL1	31	CHORUS1
12	REVERB VOCAL2	32	CHORUS2
13	REV SN.ROOM	33	BROAD CHORUS
14	REV SN.PLATE	34	FLANGE
15	CHORUS->REVERB	35	SYMPHONIC
16	FLANGE->REVERB1	36	TREMOLO
17	FLANGE->REVERB2	37	AUTO PAN
18	EARLY REF.1	38	PHASING
19	EARLY REF.2	39	ST.PITCH CHANGE
20	GATE REVERB	40	VOCAL DOUBLER

AUX 7 and AUX 8

1. Press the (AUX 7) button.



The AUX 7 page appears.

2. Select a channel using the (SEL) buttons or the cursor buttons.
3. To turn the send on, press the (ON) button in the AUX group of the SELECTED CHANNEL controls. The LED inset in the button illuminates.

Note: The [ON] button is the only way to turn the send on or off.

4. To change the aux send from pre to post-fader, press the (ENTER) button. The icon is highlighted and the text changes to POST when the signal is post fader.

Note: Pre or post fader selection can only be made from the AUX pages.

5. To change the signal level, adjust the fader or rotary encoder until the desired value is obtained.

Note: AUX 7 and AUX 8 are identical.

The AUX functions for AUX 7 and AUX 8 set the channel send levels to either of these effects buses. Similar to the functions for AUX 1 through AUX 6, you select an effect bus and then set the levels of a group of input channels. You can also select whether to send the signals pre or post fader.

Fader Status

When the AUX functions are selected, the faders change from channel level controls to auxiliary send level controls. The faders automatically move to the corresponding auxiliary send levels.

Note: Avoid blocking the fader movements when the faders move to their auxiliary send positions by placing objects on the O2R. It is possible to damage the faders.

The AUX LED of the FADER STATUS indicator will illuminate to indicate the fader status. The number indicator corresponding to current the AUX button is also illuminated:

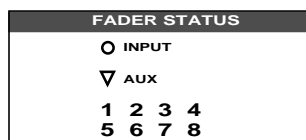

The send levels for the input channels are operated by their faders. Press the [FLIP] button, and the send levels for the tape return channels can be operated by the faders. You can also use the rotary encoders to set the tape return levels. The effect return levels can only be adjusted with the rotary encoders.

Note: When you press the [FLIP] button, the faders will automatically move to the levels of the opposite channels (from input levels to tape return levels). Avoid blocking the fader movements when the faders reposition by placing objects on the O2R. It is possible to damage the faders.

SELECTED CHANNEL Controls

You can use the SEND LEVEL encoder in the AUX group of the SELECTED CHANNEL controls to set the signal level to the auxiliary bus. The method of working with these controls is different than working with the DISPLAY ACCESS—AUX buttons.

Select a channel with the [SEL] buttons. Select the auxiliary bus with the [AUX 1] through [AUX 8/EFF 2] buttons. Turn the send on or off with the [ON] button. Adjust the send level with the SEND LEVEL encoder.

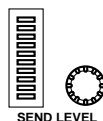

AUX Pages

The channel aux send level controls for each aux send are displayed on two pages. The first page, shown below, shows aux controls for MIC/LINE channels 1 to 24. Select this page using a MIC/LINE [SEL] button.

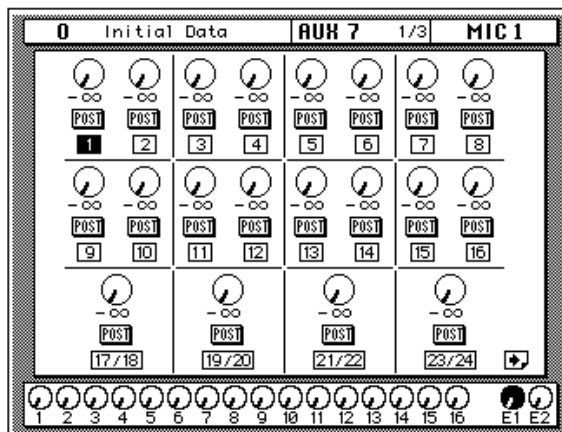

The second page shows aux controls for TAPE channels 1 to 16 and a single effects return. To prevent a feedback loop, AUX 7 cannot be sent to Effect 1, and AUX 8 cannot be sent to Effect 2. Select this page using a TAPE or EFF RTN [SEL] button.

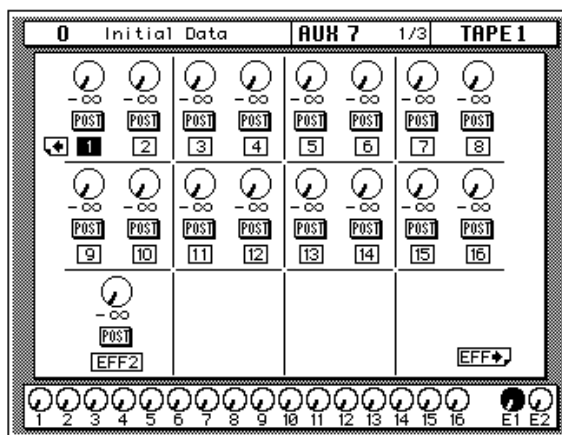

Effects

1. Use the (AUX 7) button to locate the AUX 7 2/3 page.



2. Select an icon using the cursor buttons.
3. To change the value of the selected item, rotate the encoder wheel until the desired value is shown.

The 02R is equipped with two internal multi-effects stereo processors. These processors have a startling range of special effects available to apply to your mix—shimmering reverbs, clean, precise delays, flanging and chorus, and a myriad of other effects are available.

Shown below is the AUX 7 2/3 page.

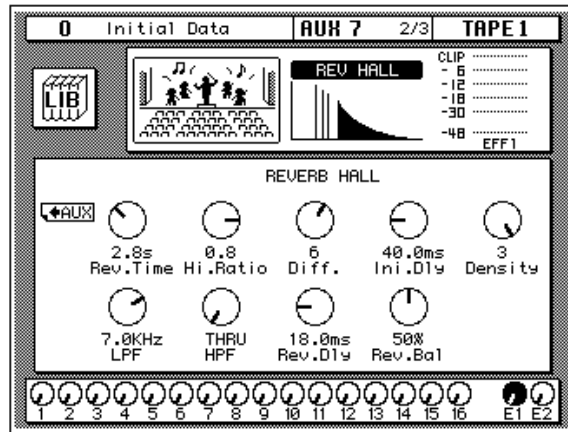

The top of the page shows the effects LIB icon, an effects curve or icon (which changes depending on the selected effect), and a level meter for the effects return channel.

The bottom of the page shows the controls for adjusting the parameters for the currently selected channel. These control parameters change depending on the selected effects. Use the cursor buttons to select the desired icon and adjust its value with the encoder wheel.

Note: Only one effects program can run on an effects processor. This means that all the channel auxiliary sends that are set to, for example, AUX 7 will be processed by the program that is currently running on Effect Processor 1. The current effect program can be stored in scene memory.

Effects Library

1. Use the (AUX 7) button to locate the AUX 7 3/3 page.



The Effects Library is used to access and store effects programs. There are 40 preset effects programs (1 through 40) and 88 user effects programs (41 through 128 plus an UNDO buffer) for you to store your own settings.

You can access this page from the EFFECT 2/3 page by selecting the LIB icon with the CURSOR buttons and pressing the [ENTER] button.

Shown below is the AUX 7 3/3 page.

Recalling Effects Programs

1. Use the CURSOR buttons to select the RECALL icon and select an effects program with the encoder wheel.
2. Press the (ENTER) button. The effects program is recalled.

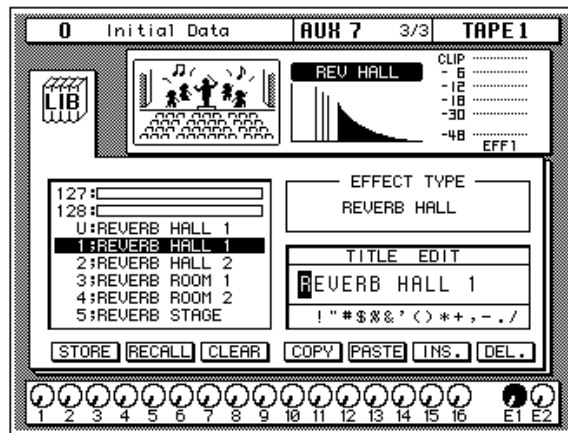

Storing Effects Programs

1. Use the CURSOR buttons to select the STORE icon and select an effects program with the encoder wheel.
2. Use the CURSOR buttons and encoder wheel to name the program.
3. Press the (ENTER) button. The 02R pops up a confirmation request.
4. Select EXECUTE and press the (ENTER) button. The effects program is stored.

The top of the page shows an effects curve or icon (which changes depending on the selected effect), and a level meter for the effects return channel.

The middle of the page shows a scrolling list of effects programs. The name of the effects program under the cursor is highlighted. When the cursor is on the STORE, RECALL, CLEAR, COPY, or PASTE icons, the encoder wheel is used to scroll through the program list.

Beside the list of effects programs is the EFFECT TYPE field and below that is the TITLE EDIT field. The cursor buttons are used to select the characters in the title, and the encoder wheel is used to change the value.

The bottom of the page contains several icons. Use the cursor buttons to select from the STORE, RECALL, CLEAR, COPY, PASTE, INS., and DEL. icons.

Exiting the Library

Selecting the LIB icon and pressing the [ENTER] button switches back to the EFFECT 2/3 page.

Icons

- **STORE**—This icon is used to store the current program to the library. Select the icon with the CURSOR buttons. Use the encoder wheel to select a program and press the [ENTER] button. The 02R displays a confirmation dialog box asking if you want to store your settings in the selected program. The dialog box has two icons: “CANCEL” and “EXECUTE”.

Note: You can customize your 02R to prevent the confirmation dialog box appearing during the STORE operation. See “Preferences” on page 198 of the User’s Guide for more information.

CANCEL is the default. To cancel the STORE operation, either press the [ENTER] button or wait about 10 seconds—the STORE operation will be automatically cancelled.

To store your settings, use the CURSOR buttons to select the “EXECUTE” icon and press the [ENTER] button. The program is stored.

When you confirm a STORE operation, any existing data in the selected program location will be overwritten.

YOU SHOULD ALWAYS BE CAREFUL WHEN THE 02R DISPLAYS A CONFIRMATION DIALOG BOX!

- **RECALL**—This icon is used to recall a program from the library. Select the icon with the CURSOR buttons. Use the encoder wheel to select a program and press the [ENTER] button. The recalled program is now the current program.
- **CLEAR**—This icon is used to clear the contents of an effects program. Use the CURSOR buttons to select the icon. Use the encoder wheel to select an effects program and press the [ENTER] button. The 02R displays a confirmation asking if you want to clear the effects program. The dialog box has two icons: “CANCEL” and “EXECUTE”.

Note: You can customize your 02R to prevent the confirmation dialog box appearing during the CLEAR operation. See “Preferences” on page 198 of the User’s Guide for more information.

CANCEL is the default. To cancel the CLEAR operation, either press the [ENTER] button or wait about 10 seconds—the CLEAR operation will be automatically cancelled.

To clear the effects program, use the CURSOR buttons to select the “EXECUTE” icon and press the [ENTER] button. The program is cleared.

If you change your mind, the cleared effects program can be retrieved by recalling the Undo effects program (U).

- **COPY**—This icon is used to copy the name of a library program. Select the icon with the CURSOR buttons. Use the encoder wheel to select a program and press the [ENTER] button. The program name is copied into an edit buffer.
- **PASTE**—This icon is used to paste a program name previously selected with the COPY operation into the TITLE EDIT box. Select the icon with the CURSOR buttons and press the [ENTER] button. The program name is pasted from the edit buffer into the TITLE EDIT box for subsequent editing.
- **INS.**—This icon is used to insert blank characters into the TITLE EDIT box at the current cursor location. Select the icon with the CURSOR buttons and press the [ENTER] button.
- **DEL.**—This icon is used to delete characters from the TITLE EDIT box at the current cursor location. Select the icon with the CURSOR buttons and press the [ENTER] button.

UNDO Operation

When the 02R stores or recalls a program, the previous settings are always preserved in the UNDO buffer. If you discover you have made a mistake, you can always recall the UNDO buffer (displayed as “U:” in the scrolling list of programs). Use the CURSOR buttons to select the RECALL icon, then rotate the encoder wheel until the UNDO buffer is the current program, and press the [ENTER] button. The previous settings are restored.

Program Name

Effects program names can be up to 16 characters long and can contain any of the following characters:

	!	“	#	\$	%	&	'	()	*	+	,	-	.	/
0	1	2	3	4	5	6	7	8	9	:	;	<	=	>	?
@	A	B	C	D	E	F	G	H	I	J	K	L	M	N	O
P	Q	R	S	T	U	V	W	X	Y	Z	[\]	^	_
`	a	b	c	d	e	f	g	h	i	j	k	l	m	n	o
p	q	r	s	t	u	v	w	x	y	z	{		}	~	

Preset Effects Program Parameters

Program 1 — REVERB HALL1

This simulates the reverberation in a larger concert hall, and adds spread to sounds such as strings and brass.

Parameter	Setting	Range	Description
Rev.Time	2.8s	0.3–30.0s	Reverb time.
Hi.Ratio	0.8	0.1–1.0	High frequency decay ratio.
Diff.	6	0–10	Reverb diffusion.
Ini.Dly	40.0ms	0.1–200.0ms	Initial delay between the direct sound and early reflections.
Density	3	0–3	Average time between reflections.
LPF	7.0kHz	1.0kHz–THRU	Low pass filter cutoff frequency.
HPF	THRU	THRU–8.0kHz	High pass filter cutoff frequency.
Rev.Dly	18.0ms	0.1–85.0ms	Delay between early reflections and reverb.
Rev.Bal	50%	0–100%	Reverb balance. The amount of reverb.

Program 2 — REVERB HALL2

This is a variation of program 1. It emphasizes longer reverberation and spaciousness.

Parameter	Setting	Range	Description
Rev.Time	3.2s	Same as program 1	Same as program 1
Hi.Ratio	0.7		
Diff.	8		
Ini.Dly	38.0ms		
Density	3		
LPF	6.3kHz		
HPF	THRU		
Rev.Dly	17.0ms		
Rev.Bal	50%		

Program 3 — REVERB ROOM1

This simulates reverberation of a room with many reflective wall aspects. It gives a live acoustic feel to drums.

Parameter	Setting	Range	Description
Rev.Time	1.4s	Same as program 1	Same as program 1
Hi.Ratio	0.8		
Diff.	7		
Ini.Dly	5.0ms		
Density	3		
LPF	THRU		
HPF	280Hz		
Rev.Dly	1.0ms		
Rev.Bal	50%		

Program 4 — REVERB ROOM2

This is a variation on program 3.

Parameter	Setting	Range	Description
Rev.Time	1.8s	Same as program 1	Same as program 1
Hi.Ratio	0.6		
Diff.	6		
Ini.Dly	17.0ms		
Density	3		
LPF	9.0kHz		
HPF	80Hz		
Rev.Dly	4.0ms		
Rev.Bal	50%		

Program 5 — REVERB STAGE

This has a slightly brighter effect than the REVERB HALL programs. Applying a small amount of this effect to an entire mix will create the feel of live acoustic environment.

Parameter	Setting	Range	Description
Rev.Time	3.4s	Same as program 1	Same as program 1
Hi.Ratio	0.9		
Diff.	8		
Ini.Dly	45.0ms		
Density	3		
LPF	THRU		
HPF	70Hz		
Rev.Dly	9.0ms		
Rev.Bal	50%		

Program 6 — REVERB PLATE

This simulates an old "steel plate reverb" and is effective on vocals or musical instruments, especially percussion.

Parameter	Setting	Range	Description
Rev.Time	2.4s	Same as program 1	Same as program 1
Hi.Ratio	0.7		
Diff.	8		
Ini.Dly	16.0ms		
Density	3		
LPF	8.0kHz		
HPF	THRU		
Rev.Dly	2.0ms		
Rev.Bal	50%		

Program 7 — REV AMBIENCE1

This creates space (a smaller space than created by the REVERB ROOM programs) around instruments. A small amount of these effects is effective on vocal and chorus, as well as percussion instruments.

Parameter	Setting	Range	Description
Rev.Time	1.2s	Same as program 1	Same as program 1
Hi.Ratio	1.0		
Diff.	8		
Ini.Dly	19.0ms		
Density	3		
LPF	9.0kHz		
HPF	45Hz		
Rev.Dly	4.0ms		
Rev.Bal	50%		

Program 8 — REV AMBIENCE2

This is a variation on program 7.

Parameter	Setting	Range	Description
Rev.Time	0.8s	Same as program 1	Same as program 1
Hi.Ratio	0.6		
Diff.	8		
Ini.Dly	0.1ms		
Density	3		
LPF	THRU		
HPF	56Hz		
Rev.Dly	0.1ms		
Rev.Bal	50%		

Program 9 — REV LIVE ROOM1

This simulates reverberation in much larger rooms.

Parameter	Setting	Range	Description
Rev.Time	2.4s	Same as program 1	Same as program 1
Hi.Ratio	0.8		
Diff.	7		
Ini.Dly	0.1ms		
Density	3		
LPF	7.0kHz		
HPF	THRU		
Rev.Dly	0.1ms		
Rev.Bal	50%		

Program 10 — REV LIVE ROOM2

This is a variation on program 9.

Parameter	Setting	Range	Description
Rev.Time	2.2s	Same as program 1	Same as program 1
Hi.Ratio	0.5		
Diff.	6		
Ini.Dly	12.0ms		
Density	3		
LPF	4.0kHz		
HPF	THRU		
Rev.Dly	3.0ms		
Rev.Bal	50%		

Program 11 — REVERB VOCAL1

This is useful for vocal and chorus.

Parameter	Setting	Range	Description
Rev.Time	1.8s	Same as program 1	Same as program 1
Hi.Ratio	0.4		
Diff.	3		
Ini.Dly	19.0ms		
Density	3		
LPF	6.3kHz		
HPF	110Hz		
Rev.Dly	10.0ms		
Rev.Bal	100%		

Program 12 — REVERB VOCAL2

This has longer reverberation than program 11. This could be suitable for ballads.

Parameter	Setting	Range	Description
Rev.Time	2.8s	Same as program 1	Same as program 1
Hi.Ratio	0.3		
Diff.	6		
Ini.Dly	35.0ms		
Density	2		
LPF	6.3KHz		
HPF	80Hz		
Rev.Dly	30.0ms		
Rev.Bal	100%		

Program 13 — REV SN.ROOM

This is a reverb variation to enhance the sound of a snare drum.

Parameter	Setting	Range	Description
Rev.Time	1.3s	Same as program 1	Same as program 1
Hi.Ratio	0.9		
Diff.	8		
Ini.Dly	26.0ms		
Density	1		
LPF	10.0KHz		
HPF	180Hz		
Rev.Dly	4.0ms		
Rev.Bal	90%		

Program 14 — REV SN.PLATE

This is also for snare drums, similar to program 13.

Parameter	Setting	Range	Description
Rev.Time	1.7s	Same as program 1	Same as program 1
Hi.Ratio	0.9		
Diff.	2		
Ini.Dly	20.0ms		
Density	1		
LPF	11.0KHz		
HPF	140Hz		
Rev.Dly	6.0ms		
Rev.Bal	90%		

Program 15 — CHORUS->REVERB

Stereo chorus followed by reverb. This program will change a dry sound into a warm sound with spread. Use the reverb Depth parameter to adjust the amount of reverberation.

Parameter	Setting	Range	Description
Freq.	4.5Hz	0.1–40.0Hz	Modulation frequency.
Depth	14%	0–100%	Modulation depth. The amount of modulation.
Mod.Dly	7.3ms	0.0–255.0ms	Modulation delay. The delay time before modulation begins.
Rev.Time	1.7s	0.3–30.0s	Reverb time.
Hi.Ratio	0.8	0.1–1.0	High frequency decay ratio.
Diff.	8	0–10	Reverb diffusion.
Ini.Dly	30.0ms	0.1–200.0ms	Initial delay between the direct sound and early reflections.
LPF	12.0KHz	1.0kHz–THRU	Low pass filter cutoff frequency.
HPF	40Hz	THRU–8.0kHz	High pass filter cutoff frequency.
Depth	60%	0–100%	Reverb depth. The amount of reverb.

Program 16 — FLANGE->REVERB1

Flange effect followed by reverb. This effect is more appropriate to emphasize modulation effects than the CHORUS->REVERB program. Use the reverb Depth parameter to adjust the amount of reverberation.

Parameter	Setting	Range	Description
Freq.	2.4Hz	0.1–40.0Hz	Flange modulation frequency.
Depth	68%	0–100%	Flange depth. The amount of modulation.
FB.Gain	+37%	–99 to +99%	Feedback gain. The amount of signal returned to the flanger.
Mod.Dly	254.4ms	0.0–255.0ms	Flange delay. The delay time before modulation begins.
Rev.Time	2.6s	0.3–30.0s	Reverb time.
Diff.	8	0–10	Reverb diffusion.
Ini.Dly	10.0ms	0.1–200.0ms	Initial delay between the direct sound and early reflections.
LPF	9.0KHz	1.0kHz–THRU	Low pass filter cutoff frequency.
HPF	45Hz	THRU–8.0kHz	High pass filter cutoff frequency.
Depth	61%	0–100%	Reverb depth. The amount of reverb.

Program 17 — FLANGE->REVERB2

This is a variation of program 16.

Parameter	Setting	Range	Description
Freq.	3.3Hz	Same as program 16	Same as program 16
Depth	9%		
FB.Gain	–63%		
Mod.Dly	0.4ms		
Rev.Time	1.4s		
Diff.	8		
Ini.Dly	9.1ms		
LPF	9.0KHz		
HPF	45Hz		
Depth	56%		

Program 18 — EARLY REF.1

Simulates early reflections only. It can create a wide range of effects , from gate-reverb to ambience effects.

Parameter	Setting	Range	Description
Type	L-Hall	ER type	Choose S-Hall, L-Hall, Random, Reverse, Plate, or Spring.
RoomSize	2.5	0.1–20.0	Time interval between the early reflections.
Liveness	2	0–10	Rate at which reflected sounds fade or decay.
Diff.	8	0–10	Reverb diffusion.
Ini.Dly	23.7ms	0.1–200.0ms	Initial delay between the direct sound and early reflections.
ER Num.	15	1–15	Number of early reflections.
Hi.Ratio	0.8	0.1–1.0	High frequency decay ratio.
FB.Gain	0%	–99 to +99%	Feedback gain. The amount of signal returned to the effect.
LPF	10.0kHz	1.0kHz–THRU	Low pass filter cutoff frequency.
HPF	THRU	THRU–8.0kHz	High pass filter cutoff frequency.

Program 19 — EARLY REF.2

This is a variation on program 18. It produces a thicker sound.

Parameter	Setting	Range	Description
Type	S-Hall	Same as program 18	Same as program 18
RoomSize	2.0		
Liveness	7		
Diff.	7		
Ini.Dly	4.8ms		
ER Num.	15		
Hi.Ratio	0.8		
FB.Gain	0%		
LPF	11.0kHz		
HPF	THRU		

Program 20 — GATE REVERB

Simulates a gate reverb effect by using the EARLY REFLECTION program.

Parameter	Setting	Range	Description
Type	Type-B	Type-A, Type-B	Type of reflections
RoomSize	1.9	0.1–20.0	Time interval between the early reflections.
Liveness	8	0–10	Rate at which reflected sounds fade or decay.
Diff.	7	0–10	Reverb diffusion.
Ini.Dly	0.1ms	0.1–200.0ms	Initial delay between the direct sound and early reflections.
ER Num.	15	1–15	Number of early reflections.
Hi.Ratio	0.8	0.1–1.0	High frequency decay ratio.
FB.Gain	0%	–99 to +99%	Feedback gain. The amount of signal returned to the effect.
LPF	12.0kHz	1.0kHz–THRU	Low pass filter cutoff frequency.
HPF	THRU	THRU–8.0kHz	High pass filter cutoff frequency.

Program 21 — REVERSE GATE

This is a variation on program 20. It creates somewhat strange, reversed gate reverb sound.

Parameter	Setting	Range	Description
Type	Type-A	Same as program 20	Same as program 20
RoomSize	2.8		
Liveness	8		
Diff.	5		
Ini.Dly	0.1ms		
ER Num.	15		
Hi.Ratio	0.8		
FB.Gain	0%		
LPF	12.0kHz		
HPF	THRU		

Program 22 — DELAY->EARLY REF

This effect creates early reflection sound after a delay.

Parameter	Setting	Range	Description
Delay	256.0ms	0.1–320.0ms	Delay time.
FB.Gain	+43%	–99 to +99%	Feedback gain. The amount of signal returned to the effect.
Hi.Ratio	0.3	0.1–1.0	High frequency decay ratio.
Type	Random	ER type	Choose S-Hall, L-Hall, Random, Reverse, Plate, or Spring.
RoomSize	6.8	0.1–20	Time interval between the early reflections.
Liveness	4	0–10	Rate at which reflected sounds fade or decay.
Diff.	3	0–10	Reverb diffusion.
Ini.Dly	8.0ms	0.1–200.0ms	Initial delay between the direct sound and early reflections.
ER Num.	12	1–15	Number of early reflections.
Depth	47%	0–100%	Reverb depth. The amount of reverb.

Program 23 — DELAY L-C-R 1

A three-part delay with independent delay time parameters for left, right, and center.

Parameter	Setting	Range	Description
Dly(L)	125.0ms	0.1–1000.0ms	Left channel delay time.
Dly(R)	250.0ms	0.1–1000.0ms	Right channel delay time.
Dly(C)	500.0ms	0.1–1000.0ms	Centre channel delay time.
Level(C)	+57	–100 to +100	Centre delay volume level.
FB.Dly	125.0ms	0.1–1000.0ms	Feedback delay. The delay time before feedback starts.
FB.Gain	+20%	–99 to +99%	Feedback gain. The amount of signal returned to the effect.
Hi.Ratio	0.8	0.1–1.0	High frequency decay ratio.
LPF	THRU	1.0kHz–THRU	Low pass filter cutoff frequency.
HPF	THRU	THRU–8.0kHz	High pass filter cutoff frequency.
Ini.Dly	0.1ms	0.1–320.0ms	Initial delay between the direct sound and early reflections.

Program 24 — DELAY L-C-R 2

This is a variation on program 23.

Parameter	Setting	Range	Description
Dly(L)	250.0ms	Same as program 23	Same as program 23
Dly(R)	500.0ms		
Dly(C)	1000.0ms		
Level(C)	+57		
FB.Dly	1000.0ms		
FB.Gain	+17%		
Hi.Ratio	0.8		
LPF	THRU		
HPF	THRU		
Ini.Dly	0.1ms		

Program 25 — CHORUS->DLY LCR

Chorus effect is followed by a three-part delay (L-C-R) with feedback.

Parameter	Setting	Range	Description
Freq.	0.8Hz	0.1–40.0Hz	Chorus modulation frequency.
Depth	24%	0–100%	Chorus depth. The amount of modulation.
Mod.Dly	5.9ms	0.0–255.0ms	Chorus delay. The delay time before modulation starts.
Dly(L)	26.4ms	0.1–1000.0ms	Left channel delay time.
Dly(R)	33.2ms	0.1–1000.0ms	Right channel delay time.
Dly(C)	13.1ms	0.1–1000.0ms	Centre channel delay time.
Level(C)	+60	–100 to +100	Centre delay volume level.
FB.Dly	40.5ms	0.1–1000.0ms	Feedback delay. The delay time before feedback starts.
FB.Gain	–48%	–99 to +99%	Feedback gain. The amount of signal returned to the effect.
Hi.Ratio	0.1	0.1–1.0	High frequency decay ratio.

Program 26 — MONODLY->CHORUS

Mono feedback delay followed by stereo chorus.

Parameter	Setting	Range	Description
Delay	400.0ms	0.1–1000.0ms	Delay time.
FB.Gain	+32%	–99 to +99%	Feedback gain. The amount of signal returned to the effect.
LPF	THRU	1.0kHz–THRU	Low pass filter cutoff frequency.
HPF	THRU	THRU–8.0kHz	High pass filter cutoff frequency.
Freq.	0.4Hz	0.1–40.0Hz	Chorus modulation frequency.
Mod.Dly	0.1ms	0.0–255.0ms	Chorus delay. The delay time before modulation starts.
EQ F	315Hz	160Hz–8.0kHz	Equalizer frequency.
EQ G	0dB	–12 to +12dB	Equalizer signal gain.
AM Depth	10%	0–100%	Amplitude modulation depth.
PM Depth	40%	0–100%	Pitch modulation depth.

Program 27 — STEREO INI.DLY ECHO

Stereo feedback delay followed by stereo echo.

Parameter	Setting	Range	Description
FB.D(L)	220.0ms	0.1–360.0ms	Left channel feedback delay time.
FB.G(L)	+40%	–99 to +99%	Left channel feedback gain.
FB.D(R)	220.0ms	0.1–360.0ms	Right channel feedback delay time.
FB.G(R)	+40%	–99 to +99%	Right channel feedback gain.
Hi.Ratio	0.4	0.1–1.0	High frequency decay ratio.
LPF	THRU	1.0kHz–THRU	Low pass filter cutoff frequency.
HPF	THRU	THRU–8.0kHz	High pass filter cutoff frequency.
Dly(L)	220.0ms	0.1–320.0ms	Left channel delay time.
Dly(R)	110.0ms	0.1–320.0ms	Right channel delay time.

Program 28 — ECHO

This is a common echo effect.

Parameter	Setting	Range	Description
Dly(L)	220.0ms	0.1–500.0ms	Left channel delay time.
FB.G(L)	+44%	–99 to +99%	Left channel feedback gain.
Dly(R)	180.0ms	0.1–500.0ms	Right channel delay time.
FB.G(R)	–55%	–99 to +99%	Right channel feedback gain.
Hi.Ratio	0.2	0.1–1.0	High frequency decay ratio.
LPF	THRU	1.0kHz–THRU	Low pass filter cutoff frequency.
HPF	THRU	THRU–8.0kHz	High pass filter cutoff frequency.
Ini.Dly	0.1ms	0.1–320.0ms	Initial delay between the direct sound and early reflections.
L->R Bal	0%	0–100%	Feeds left channel signal back to the right channel.
R->L Bal	0%	0–100%	Feeds right channel signal back to the left channel.

Program 29 — CROSS ECHO

The echo feedback signal crosses from left to right and from right to left.

Parameter	Setting	Range	Description
Dly(L)	200.0ms	Same as program 28	Same as program 28
FB.G(L)	+40%		
Dly(R)	350.0ms		
FB.G(R)	+40%		
Hi.Ratio	0.4		
LPF	THRU		
HPF	THRU		
Ini.Dly	0.1ms		
L->R Bal	34%		
R->L Bal	34%		

Program 30 — CROSS DELAY

The echo feedback signal crosses completely.

Parameter	Setting	Range	Description
Dly(L)	220.0ms	Same as program 28	Same as program 28
FB.G(L)	+44%		
Dly(R)	180.0ms		
FB.G(R)	–55%		
Hi.Ratio	0.2		
LPF	THRU		
HPF	THRU		
Ini.Dly	0.1ms		
L->R Bal	100%		
R->L Bal	100%		

Program 31 — CHORUS1

A stereo chorus. Creates a rich, thickening effect.

Parameter	Setting	Range	Description
Freq.	0.6Hz	0.1–40.0Hz	Modulation frequency.
AM Depth	49%	0–100%	Amplitude modulation depth.
PM Depth	35%	0–100%	Pitch modulation depth.
LSF F	220Hz	32Hz–1.0kHz	Low shelving filter frequency.
LSF G	+3dB	–12 to +12dB	Low shelving filter gain.
Mod.Dly	12.1ms	0.0–255.0ms	Chorus delay. The delay time before modulation starts.
EQ F	560Hz	160Hz–8.0kHz	Equalizer frequency.
EQ G	–1dB	–12 to +12dB	Equalizer signal gain.
HSF F	4.0kHz	1.0–10.0kHz	High shelving filter frequency.
HSF G	+1dB	–12 to +12dB	High shelving filter gain.

Program 32 — CHORUS2

This is a variation on program 31. The modulation is much thicker and shimmering.

Parameter	Setting	Range	Description
Freq.	0.6Hz	Same as program 31	Same as program 31
AM Depth	49%		
PM Depth	35%		
LSF F	220Hz		
LSF G	0dB		
Mod.Dly	12.1ms		
EQ F	560Hz		
EQ G	0dB		
HSF F	4.0kHz		
HSF G	0dB		

Program 33 — BROAD CHORUS

This is a variation on program 31, with more spread and spaciousness.

Parameter	Setting	Range	Description
Freq.	0.5Hz	Same as program 31	Same as program 31
AM Depth	64%		
PM Depth	90%		
LSF F	180Hz		
LSF G	+2dB		
Mod.Dly	38.0ms		
EQ F	560Hz		
EQ G	0dB		
HSF F	3.2kHz		
HSF G	+2dB		

Program 34 — FLANGE

Stereo flanger. Creates a rich, swirling effect, full of harmonics.

Parameter	Setting	Range	Description
Freq.	1.2Hz	0.1–40.0Hz	Modulation frequency.
Depth	25%	0–100%	Modulation depth.
FB.Gain	+45%	–99 to +99%	Feedback gain. The amount of signal returned to the effect.
LSF F	63Hz	32Hz–1.0kHz	Low shelving filter frequency.
LSF G	0dB	–12 to +12dB	Low shelving filter gain.
Mod.Dly	14.6ms	0.0–255.0ms	Flange delay. The delay time before modulation starts.
EQ F	630Hz	160Hz–8.0kHz	Equalizer frequency.
EQ G	+2dB	–12 to +12dB	Equalizer signal gain.
HSF F	3.2kHz	1.0–10.0kHz	High shelving filter frequency.
HSF G	0dB	–12 to +12dB	High shelving filter gain.

Program 35 — SYMPHONIC

This program creates a rich and grand chorus effect, bigger than chorus alone.

Parameter	Setting	Range	Description
Freq.	0.6Hz	0.1–40.0Hz	Modulation frequency.
Depth	8%	0–100%	Modulation depth.
Mod.Dly	2.4ms	0.0–255.0ms	Modulation delay. The delay time before modulation starts.
LSF F	63Hz	32Hz–1.0kHz	Low shelving filter frequency.
LSF G	0dB	–12 to +12dB	Low shelving filter gain.
EQ F	500Hz	160Hz–8.0kHz	Equalizer frequency.
EQ G	0dB	–12 to +12dB	Equalizer signal gain.
HSF F	6.3kHz	1.0–10.0kHz	High shelving filter frequency.
HSF G	–2dB	–12 to +12dB	High shelving filter gain.

Program 36 — TREMOLO

A stereo tremolo, just like on a classic guitar amplifier. It creates a fat sound that is great with guitars.

Parameter	Setting	Range	Description
Freq.	3.1Hz	0.1–40.0Hz	Modulation frequency.
AM Depth	84%	0–100%	Amplitude modulation depth.
PM Depth	6%	0–100%	Pitch modulation depth.
LSF F	250Hz	32Hz–1.0kHz	Low shelving filter frequency.
LSF G	+2dB	–12 to +12dB	Low shelving filter gain.
EQ F	630Hz	160Hz–8.0kHz	Equalizer frequency.
EQ G	+1dB	–12 to +12dB	Equalizer signal gain.
HSF F	2.8kHz	1.0–10.0kHz	High shelving filter frequency.
HSF G	+1dB	–12 to +12dB	High shelving filter gain.

Program 37 — AUTO PAN

This effect performs automatic panning across the stereo image.

Parameter	Setting	Range	Description
Freq.	0.5Hz	0.1–40.0Hz	Modulation frequency.
LR Depth	98%	0–100%	Left to right pan depth.
FR Depth	15%	0–100%	Front to rear pan depth.
LSF F	140Hz	32Hz–1.0kHz	Low shelving filter frequency.
LSF G	+4dB	–12 to +12dB	Low shelving filter gain.
Dir.	L<-->R	Pan direction	Choose from L<-->R, L-->R, L<--R, Turn L, or Turn R.
EQ F	630Hz	160Hz–8.0kHz	Equalizer frequency.
EQ G	+3dB	–12 to +12dB	Equalizer signal gain.
HSF F	3.2kHz	1.0–10.0kHz	High shelving filter frequency.
HSF G	0dB	–12 to +12dB	High shelving filter gain.

Program 38 — PHASING

Stereo phaser. This effect simulates old phase shifter effects.

Parameter	Setting	Range	Description
Freq.	1.3Hz	0.1–40.0Hz	Modulation frequency.
Depth	52%	0–100%	Modulation depth.
FB.Gain	+68%	–99 to +99%	Feedback gain. The amount of signal returned to the effect.
Offset	32	0–100	Phase offset. The amount that the signal phase is offset.
Stage	4	4, 6, 8	Stage of phase.
LSF F	250Hz	32Hz–1.0kHz	Low shelving filter frequency.
LSF G	+2dB	–12 to +12dB	Low shelving filter gain.
HSF F	3.6KHz	1.0–10.0kHz	High shelving filter frequency.
HSF G	+1dB	–12 to +12dB	High shelving filter gain.

Program 39 — ST.PITCH CHANGE

Two-part stereo pitch shifter. This stereo effect changes the pitch of the left and right channels independently of each other.

Parameter	Setting	Range	Description
Pitch	0	–12 to +12	Coarse pitch change for pitch changers 1 and 2.
Fine(1)	+20	–50 to +50	Fine pitch for pitch changer 1.
Fine(2)	–20	–50 to +50	Fine pitch for pitch changer 2.
Out(1)	+100	–100 to +100	Output volume level for pitch changer 1.
Out(2)	+100	–100 to +100	Output volume level for pitch changer 2.
Pan(1)	L100	L100–R100	Pan control for pitch changer 1.
Pan(2)	R100	L100–R100	Pan control for pitch changer 2.
FB.G(1)	+28%	–99 to +99%	Feedback gain for pitch changer 1.
FB.G(2)	–28%	–99 to +99%	Feedback gain for pitch changer 2.
Delay	25.0ms	0.1–255.0ms	Delay time before the feedback starts.

Program 40 — VOCAL DOUBLER

This is a thin harmonizing effect obtained by setting a longer delay.

Parameter	Setting	Range	Description
Pitch	0	Same as program 39	Same as program 39
Fine(1)	+5		
Fine(2)	-10		
Out(1)	+100		
Out(2)	+100		
Pan(1)	L6		
Pan(2)	R6		
FB.G(1)	+10%		
FB.G(2)	-10%		
Delay	60.0ms		

9

Scene Memories

In this chapter...

What are Scene Memories?	128
What is Stored in a Scene Memory?	129
What is the Edit Buffer?	129
Initial Data and UNDO Memory	129
Storing Mix Scenes	130
Naming a Scene Memory	131
Recalling Scene Memories	134
Fader Recall Safe	135
Fade Time	136

What are Scene Memories?

Scene memories are a snapshot of all the 02R mixer setting. There are 96 mix scene memory locations. Each can be titled for easy identification. They can be stored and recalled manually using the [STORE] and [RECALL] buttons. They can also be recalled by the automix (AUTOMIX) system or by using MIDI Program Changes from a computer, MIDI sequencer, or MIDI footswitch. You can also save scene memories to a MIDI data file.

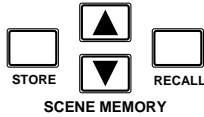

The title and number of the current scene memory are shown at the top left side of the display.

Scene Memory Number and Title

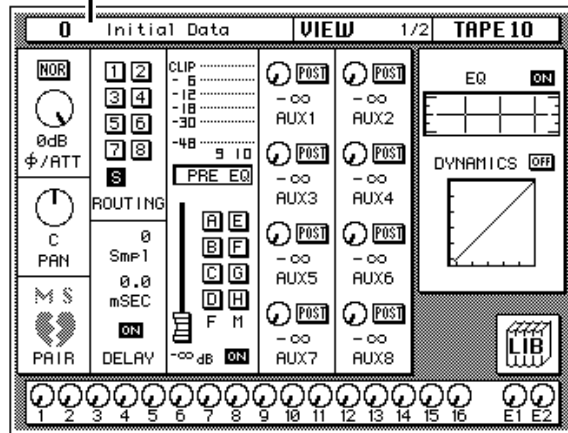

The number and status of the scene memory is shown in the SCENE MEMORY LED beside the display. When you select a new scene memory with the SCENE MEMORY increment or decrement buttons, the number in the scene memory indicator flashes.

Use the [RECALL] button to load the selected scene memory into the current edit buffer. When you first change a parameter in the recalled memory, the Edit Indicator starts to flash. To save your changes, select a scene memory with the increment or decrement buttons and press the [STORE] button. The 02R will request you confirm the action.

To display the number of the scene memory that was stored or recalled last, press the scene memory increment and decrement buttons together.

What is Stored in a Scene Memory?

Virtually all 02R mix settings are stored in a scene memory. Settings that are not stored consist mainly of analog controls and switches. They are: +48V phantom switches, A/B input switches, 20 dB (pad) switches, GAIN controls, T/B LEVEL control, STUDIO LEVEL control, PHONES LEVEL control, C-R LEVEL control, and the display CONTRAST control.

MIDI setup and assignment table data are also not stored in the scene memory.

What is the Edit Buffer?

The Edit Buffer is the current mix settings. When a scene memory is recalled, the mix settings of the selected scene memory are written to the Edit Buffer. When a scene memory is stored, the mix settings in the Edit Buffer are written to the selected scene memory.

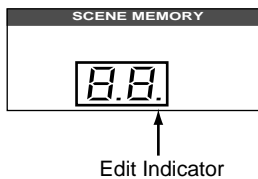

The first time you adjust a parameter in the current mix settings, the Edit Indicator of the SCENE MEMORY indicator on the display starts to flash. This indicates that the current mix settings—those in the Edit Buffer—do not match those of the scene memory previously recalled.

Initial Data and UNDO Memory

The 02R has two special scene memory locations. Scene number "0" (zero) and scene number "U" are read-only memory locations.

Scene number "0—Initial Data" contains the initial mix settings for the 02R. When you want to reset all the mixer settings to their initial values, recall this scene memory. Normally, all channel faders move to the minimum position. You can, however, set the Initial Data Nominal preference so that they move to the nominal position. Aux and bus master faders move to the nominal (0.0 dB) position regardless of this preference. See "Preferences" on page 198.

Scene number "U" is the UNDO memory. It always contains a copy of the last scene memory. Even if you have pressed the [STORE] button and confirmed the operation, you can still recall the contents of the overwritten scene memory by recalling scene number "U".

Storing Mix Scenes

1. Use the increment or decrement buttons to select a scene memory.

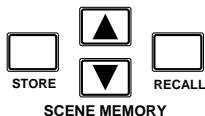

2. Press the (STORE) button.

A confirmation dialog box appears.

3. Use the CURSOR buttons to select “EXECUTE” and press the (ENTER) button.
The mix scene is stored.

The 02R has 96 scene memory locations. You can save additional scenes to a MIDI data file. Scene memories can be titled for easy identification.

When you are about to store a scene memory, make sure there are no settings in the Edit Buffer that you do not want to store. Maybe some settings have been adjusted accidentally, or by someone else. If you are not sure about the Edit Buffer’s exact contents, first recall the last scene memory, make the adjustments that you really want, and then store. You may want to store the current mix settings to an unused scene memory, just in case.

Storage Confirmation

When you save the mixer settings to a scene memory location, the 02R displays a confirmation dialog box, with two icons: “CANCEL” and “EXECUTE”, as shown below:



Note: You can customize your 02R to prevent the dialog box appearing during the STORE operation. See “Preferences” on page 198 of the User’s Guide for more information.

CANCEL is the default. To cancel the STORE operation, either press the [ENTER] button or wait about 10 seconds—the STORE operation will be automatically cancelled. A prompt indicating the operation has been cancelled will flash momentarily on the display.

To store your settings, use the CURSOR buttons to select the “EXECUTE” icon and press the [ENTER] button. The program is stored.

Note: When a scene memory is stored, all the previous data in the selected scene memory is overwritten. The 02R has an UNDO function, but you should still be careful not to overwrite an important scene memory.

YOU SHOULD ALWAYS BE CAREFUL WHEN THE 02R DISPLAYS A CONFIRMATION DIALOG BOX!

Reorganizing Scene Memories

By recalling a scene memory and then storing it to another location, you can copy and reorganize your scene memories.

Naming a Scene Memory

1. Use the (SCENE MEMORY) button to locate the SCENE 1/5 page.



2. Use the CURSOR buttons to select the title edit box.
3. Select the individual character positions with the CURSOR buttons. Rotate the encoder wheel to select characters for your title.
4. Press the (STORE) button. Respond to the confirmation dialog box by selecting "EXECUTE" and pressing the (ENTER) button. The scene memory is stored.

Scene memories can be titled on the SCENE 1/5 page shown below. Scene memories can be named before being stored or after. In the latter case, you must first recall the scene memory, name it, and then store it.

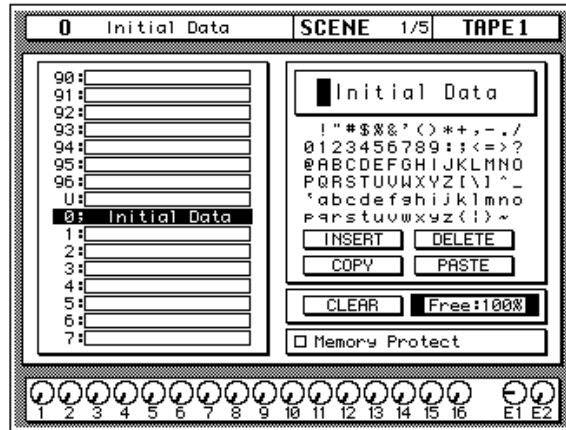

The left side of the page shows a list of the scene memories. The name of the scene memory under the cursor is highlighted. The SCENE MEMORY increment or decrement buttons are used to scroll through the list.

Beside the list of scene memories is the title edit field. The CURSOR buttons are used to select the character, and the encoder wheel is used to change its value. A table of the available characters is shown below the title edit field.

Below the character table are four icons. Use the CURSOR buttons to select from the INSERT, DELETE, COPY, or PASTE icons. Below these are the scene memory CLEAR icon and scene memory memory free indicator. Scene memory memory is displayed as a percentage. If there is not enough memory to store a scene memory, the message "Scene Memory Area Full" appears.

At the bottom of the right side of the display is the Memory Protect check box. When this box is checked, all scene memories are protected from the storage operations.

Character Set

A scene memory name can be up to 16 characters long and can contain any of the following characters:

	!	“	#	\$	%	&	'	()	*	+	,	-	.	/
0	1	2	3	4	5	6	7	8	9	:	;	<	=	>	?
@	A	B	C	D	E	F	G	H	I	J	K	L	M	N	O
P	Q	R	S	T	U	V	W	X	Y	Z	[\]	^	_
`	a	b	c	d	e	f	g	h	i	j	k	l	m	n	o
p	q	r	s	t	u	v	w	x	y	z	{		}	~	

Icons

- **INSERT**—This icon is used to insert blank characters into the title edit box at the current cursor location. Select the icon with the CURSOR buttons and press the [ENTER] button.
- **DELETE**—This icon is used to delete characters from the title edit box at the current cursor location. Select the icon with the CURSOR buttons and press the [ENTER] button.
- **COPY**—This icon is used to copy the name of another scene memory. Select the icon with the CURSOR buttons. Use the encoder wheel to select a scene memory and press the [ENTER] button. The scene memory name is copied into an edit buffer.
- **PASTE**—This icon is used to paste a scene memory name previously selected with the COPY operation into the title edit box. Select the icon with the CURSOR buttons and press the [ENTER] button. The scene memory name is pasted from the edit buffer into the title edit box, replacing any text that was there. You can then edit the text to create a unique scene memory name.
- **CLEAR**—This icon is used to clear the contents of a scene memory. Use the CURSOR buttons to select the icon. Use the encoder wheel to select a scene memory and press the [ENTER] button. The 02R displays a confirmation dialog box asking if you want to clear the scene memory. The box has two icons: “CANCEL” and “EXECUTE”.

Note: You can customize your 02R to prevent the confirmation dialog box appearing during the CLEAR operation. See “Preferences” on page 198 of the User’s Guide for more information.

CANCEL is the default. To cancel the CLEAR operation, either press the [ENTER] button or wait about 10 seconds—the CLEAR operation will be automatically cancelled.

To clear the scene memory, use the CURSOR buttons to select the “EXECUTE” icon and press the [ENTER] button. The scene memory is cleared.

If you change your mind, the cleared mix scene can be retrieved by recalling the Undo scene memory (U).

Protecting Scene Memories

You can protect stored mix scenes against accidental overwriting using this Memory Protect function. This is useful when you've set up many mix scenes for repeated use, or when inexperienced users operate 02R.

When the Memory Protect is checked, mix settings cannot be stored using the [STORE] button. Any scene memory data received as MIDI Bulk Dump is also ignored.

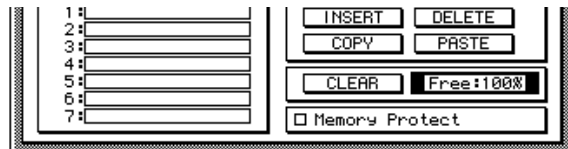

Recalling Scene Memories

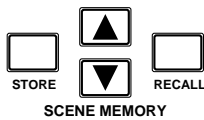

Scene memories are recalled using the [RECALL] button. They can also be recalled using MIDI Program Changes.

Note: When you recall a scene memory, all mix settings in the Edit Buffer (current mix scene) are overwritten. You may want to store the Edit Buffer to an unused scene memory before recalling, just in case.

Note: When recalling mix scenes, be aware that volume levels may change suddenly as channels are switched ON and faders moved. The 02R has a feature that allows you to fade the levels as a scene memory is loaded, but it cannot compensate for the sudden burst of a channel suddenly being switched on. See "Fade Time" on page 136 of the User's Guide

Fader Recall Safe

1. Use the (SCENE MEMORY) button to locate the SCENE 2/5 page.



2. Use the CURSOR buttons to select the “Enable/Disable” options and use the (ENTER) button to ENABLE the safe function.
3. Select the individual channels with the (SEL) buttons or the CURSOR buttons. Press the (ENTER) button to enable a channel. Its icon is highlighted.
4. Press the (STORE) button. Respond to the confirmation dialog box by selecting “EXECUTE” and pressing the (ENTER) button. The scene memory is stored.

The 02R has two methods of protecting the system from sudden volume level changes when a scene memory is recalled. You can select individual channels to safety. When the scene memory is recalled, the fader level will not change from the level it was set to in the previous mix.

Shown below is the SCENE 2/5 page—Fader Recall Safe.

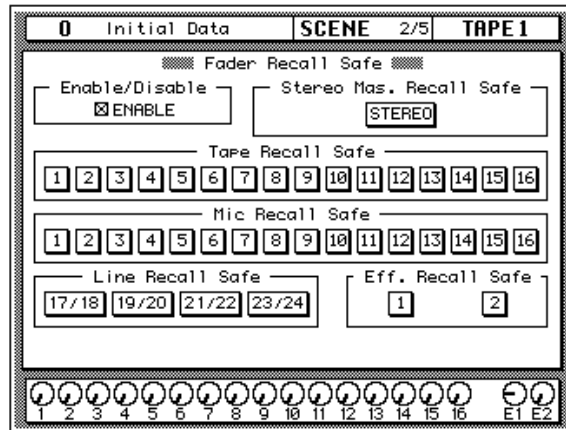

The “Enable/Disable” controls are in the top left corner of the page. Use the CURSOR buttons to select ENABLE check box and press the [ENTER] button.

The remainder of the screen contains icons for each of the input and return channels plus the stereo master fader. Select an icon and press the [ENTER] button to safety a channel.

In order for the “Fader Recall Safe” function to have any effect, you must store the scene memory (see “Storing Mix Scenes” on page 130 of the *User’s Guide*).

Restoring the Faders

To restore the fader movements, select the “DISABLE” option and press the [ENTER] button. Reset the fader levels. Then store the scene memory again (see “Storing Mix Scenes” on page 130 of the *User’s Guide*).

Note: If you DISABLE the fader recall safe or switch off the individual channels and then store the scene memory, be aware that the current fader levels will be stored in the memory, not the levels that were previously stored there.

Fade Time

1. Use the (SCENE MEMORY) button to locate the SCENE 3/5 page.



2. Select the individual channels with the (SEL) buttons or the CURSOR buttons. Rotate the encoder wheel to set the fade time value.
3. Press the (STORE) button. Respond to the confirmation dialog box by selecting “EXECUTE” and pressing the (ENTER) button.

The scene memory is stored.

The second method of protecting the system from sudden volume level changes is to set the fade time for each channel. When the scene memory is recalled, the fader level will change from its previous level to the new level of the recalled memory. You can control the duration of the change.

Shown below is the SCENE 3/5 page—Fade Time.

0 Initial Data		SCENE 3/5		TAPE 1	
	Mic	Fade Time		[SEC]	
		Tape		Line/Rtn/ST	
1	0.0 9 0.0	1	0.0 9 0.0	17	0.0 E1 0.0
2	0.0 10 0.0	2	0.0 10 0.0	18	E1
3	0.0 11 0.0	3	0.0 11 0.0	19	0.0 E2 0.0
4	0.0 12 0.0	4	0.0 12 0.0	20	E2
5	0.0 13 0.0	5	0.0 13 0.0	21	0.0
6	0.0 14 0.0	6	0.0 14 0.0	22	
7	0.0 15 0.0	7	0.0 15 0.0	23	0.0 ST 0.0
8	0.0 16 0.0	8	0.0 16 0.0	24	

The page consists of all the “Mic”, “Tape” and “Line/Rtn/ST” channels with a fade time value beside each. You can set the fade time from 0.0 sec to 10.0 sec.

Note: If you double-click the [ENTER] button on a selected channel, all the channels will be set to the same fade time as that channel.

In order for the fade time you set to have any effect, you must store the scene memory (see “Storing Mix Scenes” on page 130 of the *User’s Guide*).

10

Automix

10

In this chapter...

- What is the Automix Function?..... 138
- What is Timecode?..... 140
- Automix Function 143
- Automix Main 144
- Memory Management..... 148
- Fader Edit 151
- Event Copy 153
- Event Edit (Scene/Lib.)..... 155
- Event Edit (CH ON, PAN, FADER) 156
- Time Signature 156

What is the Automix Function?

One of the most demanding jobs of the recording engineer is taking all the raw material produced during a multitrack recording session and mixing it all together into an artistically satisfying master recording. The ability to setup portions of the mix and then have them playback automatically as you work on other portions is probably the most important feature of any digital recording studio.

The 02R has an on-board automix system that memorizes fader positions, switches individual channels on or off, adjusts the equalization or pan positions, and changes the auxiliary sends—all based on timecode. It can record and execute scene memory changes, also determined by timecode. This allows you to perform an entire mixing session, and then edit individual channel settings until you have achieved a perfect mix.

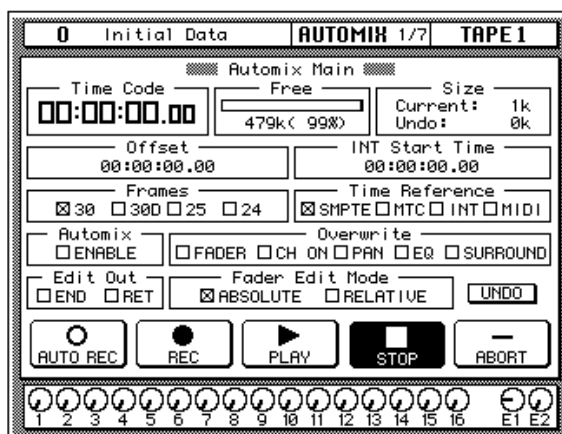

What is Stored in an AUTOMIX Memory?

An AUTOMIX memory starts with a scene memory and a start time. As each parameter is adjusted, the adjustment and the associated time is recorded in memory. The following parameters can be recorded in an automix. Some parameters can only be recorded when the corresponding overwrite check box is checked on the AUTOMIX 1/7 page. Other parameters can be recorded at any time.

- **FADER**—Input and output level events (faders/rotary encoders) (FADER overwrite check box)
- **CH ON**—Channel on/off (mute) events (CH ON overwrite check box)
- **PAN**—pan events (PAN overwrite check box)
- **EQ**—EQ events (EQ overwrite check box)
- **SCENE**—Scene memory recall events
- **AUX 1–8**—Channel aux send events (faders/rotary encoders) (FADER overwrite check box)

-
- **REMOTE 1–4**—MIDI Remote events
 - **SURR**—Surround pan events (SURROUND overwrite check box)
 - **EQLIB**—EQ library program recall events
 - **CHLIB**—Channel library program recall events
 - **DYLIB**—Dynamics library program recall events
 - **EFLIB**—Effects library program recall events

To record a mix scene or library program recall in real time, start automix recording and then recall the scene or program as normal. The recall action will be recorded by the automix as a recall event, and can then be edited on the AUTOMIX 5/7 page.

What is the 02R Memory Capacity?

The 02R has a current AUTOMIX buffer and 16 AUTOMIX memories. There is also an undo buffer. Only the current mix can be played back and recorded. You can store the current mix in any of the 16 automix memories.

The default memory capacity of the 02R is 480K. Total size of the current mix and the 16 AUTOMIX memories should be under 480K. If you find yourself running out of memory, you can download unused AUTOMIX memories to a storage device, such as a MIDI data filer, then clear the memories. You can also expand the available memory with 1 MB expansion kits (ME4M). You can install up to two of these kits in the 02R, resulting in a maximum memory size of approx. 2.5 MB.

What is the Current Buffer?

The only automix program that can be recorded or played back is the current AUTOMIX buffer. When you perform edits to the current buffer, its previous state is saved in an undo buffer. You can always undo the last edit operation.

Note: *You cannot undo a STORE operation. Once you have confirmed the operation, the previous AUTOMIX memory contents have been overwritten.*

What is Timecode?

Timecode is a signal that contains a chronological record of the absolute time in a recording. It is used for synchronizing different recorders. It can be used for electronic editing. Timecode was initially invented for the motion picture business, as a method of synchronizing the pictures recorded in the frames of a camera to the sound recorded on tape recorder.

The 02R supports four types of timecode:

- SMPTE timecode
- MTC (MIDI timecode)
- Internal timecode (for leaning Automix)
- MIDI (MIDI Clock)

When you synchronize the 02R to an external device such as a multitrack recorder or MIDI sequencer, the external device will provide SMPTE or MTC timecode to allow the automix to synchronize with the data on the recorder or sequencer.

Using SMPTE Timecode

SMPTE timecode is a synchronization signal developed for the film and television industries (Society of Motion Picture and Television Engineers). It is normally implemented as timing pulses converted into an audio signal and recorded onto tape or film. Some devices are able to transmit SMPTE timecode directly.

SMPTE indicates an absolute time in hours:minutes:seconds:frames. There are four basic formats, depending on the number of frames that a second is divided into:

- 24 frames per second
- 25 frames per second
- 29.97 frames per second (30 drop frame)
- 30 frames per second (29.97/30 non-drop frame)

Use SMPTE timecode when you want to synchronize an 02R automix with video recorders, a multitrack recorder, or other film and video post-production recorders.

Connections

If the connected device can directly output SMPTE timecode, use an audio cable to connect the output to the TIME CODE INPUT—SMPTE connector on the back of the 02R.

If the connected device does not have a dedicated SMPTE output connector, record the timecode onto a spare track (in the case of a multitrack recorder) or a special track (in the case of a video recorder or film post-production recorder) and connect the output from that track to the timecode input connector on the 02R.

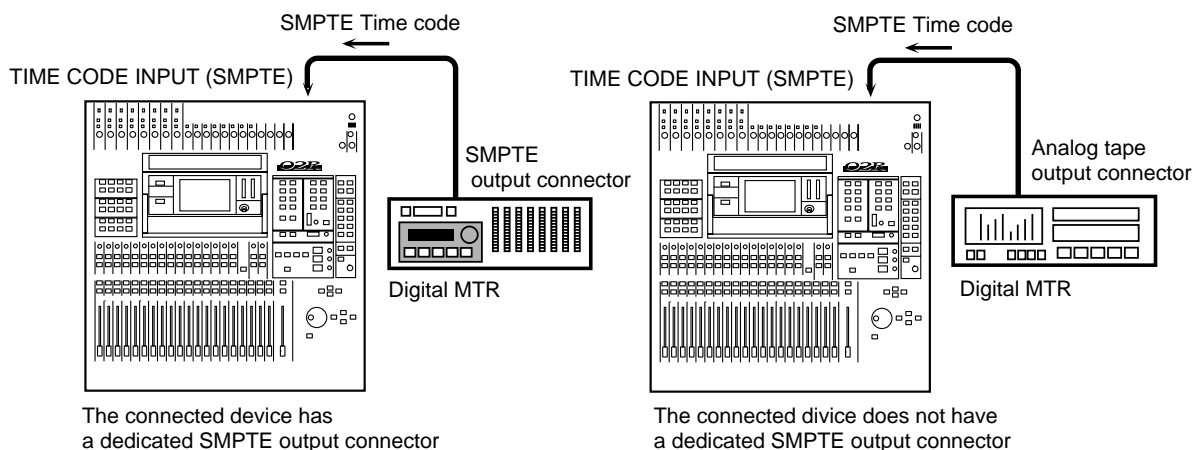

Using MIDI Timecode (MTC)

MTC is a MIDI System message that indicates absolute time in hours:minutes:seconds:frames, in the same fashion as SMPTE. MTC is an alternate method of transferring the timecode data from one device to another.

Use MTC when you want to synchronize an 02R automix with MIDI sequencers or a multitrack recorder that has MTC output jacks. Use a MIDI cable to plug the MTC output connector of the controlling device into the TIME CODE INPUT—MTC connector on the back of the 02R. The 02R can use the MTC or MIDI IN jack to receive MTC, and the first jack to receive MTC takes priority. While MTC is being read from the

MIDI IN jack, any MTC arriving at the MTC jack is ignored, and vice versa.

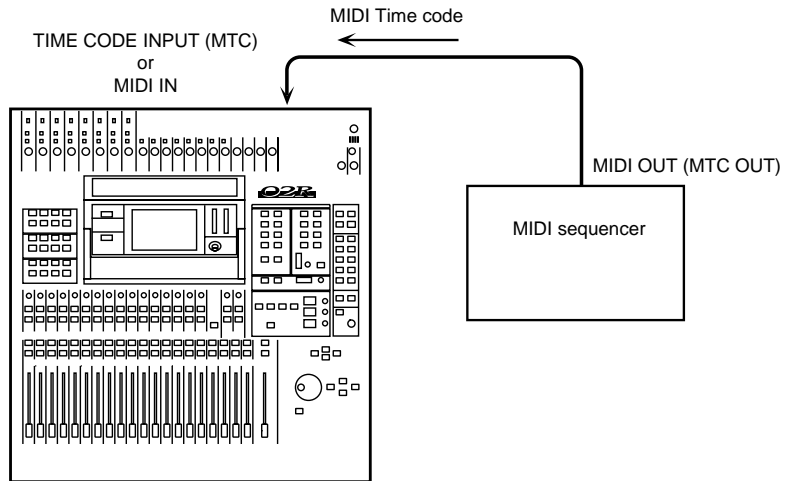

Note: When transmitting MTC to the O2R, you should use a dedicated output on the connected device. Otherwise the O2R has to discard MIDI playback data and other extraneous information, decreasing the accuracy of the timecode data.

Using MIDI Clock

Automix can be referenced to an external MIDI Clock, and supports Timing Clock (F8H), Start (FAH), Continue (FBH), Stop (FCH), and Song Position Pointers (F3H, **H, **H).

Use MIDI Clock when you want to synchronize an automix to a MIDI sequencer that does not support MTC. Use a MIDI cable to connect the MIDI OUT connector of the controlling device to the TIME CODE INPUT—MTC connector on the back of the O2R.

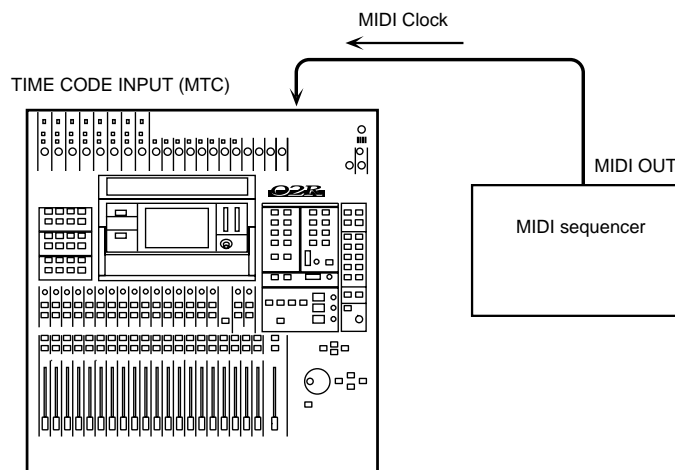

Automix Function

The Automix function consists of six pages.

1/7 Automix Main

The Automix Main page controls the record and playback operations. Select the timecode frame rate, and the timecode input. Set the initial start time and enable the editing operations.

2/7 Memory Management

The Memory Management page is used to name the AUTOMIX and perform store and recall operations. You can also control the record and playback operations from this page.

3/7 Fader Edit

The Fader Edit page is used to edit the fader positions and set motor parameters. You can also control the record and playback operations from this page.

4/7 Event Copy

The Event Copy page allows you to copy, move, extract and trim the level of automix events.

5/7 Event Edit (Scene/Lib.)

The Event Edit (Scene/Lib.) page allows you to duplicate and delete mix scene and library recall events, and insert new events. Timecode addresses can be captured on-the-fly, and new events inserted at the captured points.

6/7 Event Edit (CH ON, PAN, FADER)

The Event Edit (CH ON, PAN, FADER) page allows you edit channel on/off, pan, and fader events, and duplicate, delete, and insert new events. Timecode addresses can be captured on-the-fly, and new events inserted at the captured points.

7/7 Time Signature

The Time Signature page allows you to enter time signature information for use with MIDI Clock.

Automix functions can be customized using the preferences on the SETUP 4/4 page. See "Preferences 2" on page 201.

Automix Main

1. Use the (AUTOMIX) button to locate the AUTOMIX 1/7 page.



2. Select the “INT Start Time” with the CURSOR buttons and set the desired value by rotating the encoder wheel.
3. Use the CURSOR buttons to select the desired “Frame” rate check box and press the (ENTER) button.
4. Select a “TC Input” check box with the CURSOR buttons and press the (ENTER) button.
5. Use the CURSOR buttons to select the “Automix” ENABLE check box and press the (ENTER) button to change its value.
6. Select the “Overwrite” status check boxes with the CURSOR buttons and press the (ENTER) button.
7. Use the CURSOR buttons to select the “Edit Out” END or RET check box and press the (ENTER) button to change its value.
8. Select a “Fader Edit Mode” check box with the CURSOR buttons and press the (ENTER) button.

Basic automix functions are controlled using the Automix Main page shown below.

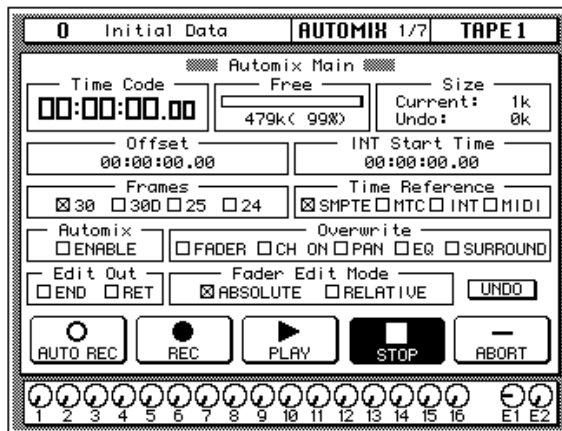

The top row of this page consists of the timecode counter, the current free memory size, shown in a bargraph, kilobytes, and percentage, and the size of the current memory buffer and the undo buffer.

The second row has automix offset and internal timecode generator start time parameters.

In the third row, you set the frame rate (30, 30D (drop frame), 25, or 24) and select the Time Reference (SMPTE, MTC, INT (internal SMPTE), or MIDI (MIDI Clock)).

The fourth row allows you to set the Automix ENABLE and select the real-time edit Overwrite status (FADER, CH ON, PAN, EQ, SURROUND).

In the fifth row, you set the Edit Out END/RET and select the Fader Edit Mode (ABSOLUTE or RELATIVE). At the end of the row is the UNDO icon, which allows you to undo the last edit operation.

The bottom row contains the automix transport icons. Select from the following:

- **AUTOREC**—recording starts when the 02R receives timecode.
- **REC**—places the 02R in record ready mode.
- **PLAY**—starts playback of the automix program when timecode is received.
- **STOP**—stops recording or playback.
- **ABORT**—stops recording and discards any data recorded.

Time Code Counter

The timecode counter displays the incoming timecode. For the SMPTE, MTC, and INT time references, timecode is displayed in hours, minutes, seconds, and frames. If you select INT (internal) timecode, the timecode counter starts straightaway.



For MIDI Clock, timecode is displayed in bars, beats, and MIDI clocks.

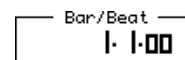

Offset

Using an offset, automix events can be moved backwards or forwards relative to the incoming timecode.

For the SMPTE, MTC, and INT time references, offset is specified in hours, minutes, seconds, and frames.

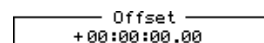

For MIDI, it's specified in bars, beats, MIDI clocks, and Time Signature.

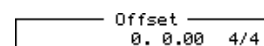

Timecode Type and Frame Rate

Select the timecode type from the following list:

- SMPTE timecode
- MTC (MIDI Timecode)
- INT (internal SMPTE)
- MIDI (MIDI Clock)

Select the timecode frame rate from the following list:

- 24 frames per second
- 25 frames per second
- 29.97 frames per second (30 drop frame)
- 30 frames per second (29.97/30 non-drop frame)

Automix ENABLE

When the 02R receives timecode during enable status (box checked), it will start playback of the AUTOMIX (or recording if it is in REC ready mode). If the 02R is in disable status, the AUTOMIX will not function.

Overwrite Mode

The Overwrite check boxes can be used to select certain parameters for automix recording. These are: FADER, CH ON, PAN, EQ or SURROUND. The FADER check box includes rotary encoders and AUX send levels. The following parameters are not affected by the Overwrite check boxes and can be recorded at any time: mix scene recalls, MIDI Remote actions, and EQ, channel, dynamics, and effects program recalls.

Use the [SEL] buttons to select a channel for recording. The parameter will be recorded during the first record operation, and overwritten during subsequent passes (recordings). During the overwrite operation, the [SEL] button will flash.

During automix recording, you cannot change a parameter settings unless the corresponding parameter has been selected and the channel [SEL] button (edit key) has been pressed. If the parameter has been selected and the channel [SEL] button has been pressed, automix playback for that parameter will be stopped, and you can record new data.

Note: *It is possible to change a parameter during automix playback, but automix playback has priority.*

Fader Edit & Edit Out Modes

Real-time fader edits can be performed in either Absolute or Relative mode. These modes determine how existing data interacts with real-time automix edits. These modes can also be combined with the END and RET Edit Out options, which determine what faders do when a real-time edit is stopped. See “Fader Edit & Fader Edit Out Modes” on page 151 for more information.

UNDO

This operation allows you to undo the following conditions: updating the automix (after recording has been stopped via the stop key or due to the interrupted timecode), recalling the data from the automix memory into the current mix, creating a new mix, storing Automix, clearing Automix, or aborting the automix. It returns the current automix to its previous state.

Using the Transport Controls

1. Use the **CURSOR** buttons to select a transport icon.
2. Press the **(ENTER)** button to operate the selected automix control.

Transport Controls

The following five operations have been made as icons: AUTOREC, REC, PLAY, STOP, ABORT. Use the CURSOR buttons to select the desired operation and press the [ENTER] button.

AUTOREC—Selecting this icon will start AUTOMIX recording when the 02R receives timecode, even if it is not in REC ready mode. You can use this key when you do not want to press the REC ready key many times.

Note: *A channel must be selected with its [SEL] button in order for any automix events to be recorded.*

REC—Selecting this icon will cause the unit to enter REC ready mode. The icon will flash. The 02R starts recording when it receives timecode during REC ready mode. The icon will be highlighted. Selecting this icon during AUTOMIX playback will cause the 02R to enter REC ready mode. Selecting the PLAY icon will start a punch-in recording.

Note: *A channel must be selected with its [SEL] button in order for any automix events to be recorded.*

PLAY—Selecting this icon when timecode is being received and the AUTOMIX is stopped will play back the automix. Selecting this icon while the 02R is in record ready mode will start a punch-in recording.

Note: *A channel must be selected with its [SEL] button in order for any automix events to be recorded.*

STOP—Selecting this icon will stop the playback and/or recording of the AUTOMIX. When recording is stopped, the data will be stored as the new current mix.

ABORT—Selecting this icon will stop the playback or recording of the AUTOMIX. When the recording is stopped, the data will be discarded. (Internally, the data is stored in memory for the undo operation.)

Memory Management

1. Use the (AUTOMIX) button to locate the AUTOMIX 2/7 page.



2. Use the encoder wheel to select an AUTOMIX memory from the scrolling list.
3. Select the RECALL icon with the CURSOR buttons and press the (ENTER) button.
4. Edit the title with the CURSOR buttons, encoder wheel, and (ENTER) button.
5. Use the CURSOR buttons to select the “Automix” ENABLE check box and press the (ENTER) button.
6. Select the “Overwrite” check boxes with the CURSOR buttons and press the (ENTER) button.
7. Use the CURSOR buttons to select “Edit Out” END or RET check box and press the (ENTER) button.
8. Use the CURSOR buttons and the (ENTER) button to operate the automix transport.

The Memory Management page, shown below, is used to store, recall, title, and clear automixes. Some of the functions from the Automix Main page also appear on this page.

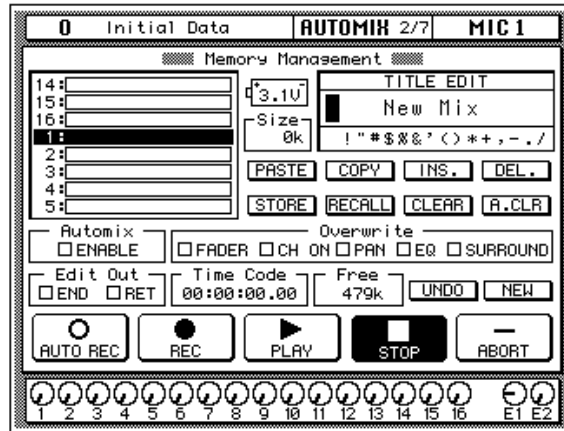

The top left of the display shows a scrolling list of the 16 AUTOMIX memories.

The top right of the display is the Title Edit field. The CURSOR buttons are used to select the character, and the encoder wheel is used to change its value. AUTOMIX memory names can be up to 16 characters long.

Below the Title Edit field are the edit control button icons. Use the CURSOR buttons to select from the PASTE, COPY, INS., DEL., STORE, RECALL, CLEAR, and A.CLR icons.

Between the list of AUTOMIX memories and the Title Edit field is the memory Size indicator.

The bottom of the display consists of three rows. The first row allows you to set the Automix ENABLE and select the real-time edit Overwrite status (FADER, CH ON, PAN, EQ, SURROUND).

The second row allows you set the Edit Out to END or RET. Beside that is the timecode counter and the Free memory indicator. At the end of the row are the UNDO (which allows you to undo the last edit operation) and NEW (which creates a new automix in the current buffer) icons.

The last row on the bottom contains the automix transport icons (AUTOREC, REC, PLAY, STOP, or ABORT).

AUTOMIX Name Edit Functions

AUTOMIX memory names can be up to 16 characters long and can contain any of the following characters:

	!	“	#	\$	%	&	'	()	*	+	,	-	.	/
0	1	2	3	4	5	6	7	8	9	:	;	<	=	>	?
@	A	B	C	D	E	F	G	H	I	J	K	L	M	N	O
P	Q	R	S	T	U	V	W	X	Y	Z	[\]	^	_
`	a	b	c	d	e	f	g	h	i	j	k	l	m	n	o
p	q	r	s	t	u	v	w	x	y	z	{		}	~	

- **COPY**—This icon is used to copy the name of an AUTOMIX program. Select the icon with the CURSOR buttons. Use the encoder wheel to select a program and press the [ENTER] button. The program name is copied into an edit buffer.
- **PASTE**—This icon is used to paste the AUTOMIX program name previously selected with the COPY operation into the TITLE EDIT box. Select the icon with the CURSOR buttons and press the [ENTER] button. The program name is pasted from the edit buffer into the TITLE EDIT box for subsequent editing.
- **INS.**—This icon is used to insert blank characters into the TITLE EDIT box at the current cursor location. Select the icon with the CURSOR buttons and press the [ENTER] button.
- **DEL.**—This icon is used to delete characters from the TITLE EDIT box at the current cursor location. Select the icon with the CURSOR buttons and press the [ENTER] button.

AUTOMIX Memory Edit Functions

- **STORE**—This icon is used to store the current AUTOMIX program to the library. Select the icon with the CURSOR buttons. Use the encoder wheel to select an AUTOMIX program and press the [ENTER] button. The 02R displays a confirmation dialog box asking if you want to store your settings in the selected program. The box has two icons: “CANCEL” and “EXECUTE”.

CANCEL is the default. To cancel the STORE operation, either press the [ENTER] button or wait about 10 seconds—the STORE operation will be automatically cancelled.

To store your settings, use the CURSOR buttons to select the “EXECUTE” icon and press the [ENTER] button. The program is stored.

When you confirm a STORE operation, any existing data in the selected automix memory location will be overwritten. You cannot undo the STORE operation.

YOU SHOULD ALWAYS BE CAREFUL WHEN THE 02R DISPLAYS A CONFIRMATION DIALOG BOX!

- **RECALL**—This icon is used to recall an AUTOMIX program from the library. Select the icon with the CURSOR buttons. Use the encoder wheel to select an AUTOMIX program and press the [ENTER] button. The 02R displays a confirmation dialog box asking if you want to recall the selected program. The box has two icons: “CANCEL” and “EXECUTE”.

CANCEL is the default. To cancel the RECALL operation, either press the [ENTER] button or wait about 10 seconds—the RECALL operation will be automatically cancelled.

To recall your settings, use the CURSOR buttons to select the “EXECUTE” icon and press the [ENTER] button. The recalled program is now the current program. You can undo or redo the recall operation.

- **CLEAR**—delete the data located in the currently selected AUTOMIX memory location. You cannot undo the CLEAR function.
- **A.CLR**—delete all the data from all AUTOMIX memory locations. You cannot undo the ALL CLEAR function.

UNDO

This operation allows you to undo the following conditions: updating the automix (after recording has been stopped via the STOP transport function or due to the interrupted timecode), recalling the data from the automix memory into the current mix, creating a new mix, or aborting the automix. It returns the current automix to its previous state.

NEW

Before you can record an automix session, you must create a new automix. This operation allows you to create a new mix. As a default new mix, the current scene memory (the last scene memory to be stored or recalled) will be inserted at timecode location 00:00:00.00. Later, you can edit the timecode location using the AUTOMIX event edit operations.

Fader Edit

1. Use the (AUTOMIX) button to locate the AUTOMIX 3/7 page.



2. Use the CURSOR buttons to select the MOTOR ON icon and press (ENTER) to change its value.
3. Select the “Fader Edit Out” RETURN check box with the CURSOR buttons and press the (ENTER) button. Rotate the encoder wheel to set a “Time” value.
4. Select the desired “Fader Edit Mode” check box with the CURSOR buttons and press the (ENTER) button.
5. Use the CURSOR buttons and the (ENTER) button to operate the automix transport.

The Fader Edit page displays fader positions relative to previously recorded data, and is convenient for real-time fader edits.

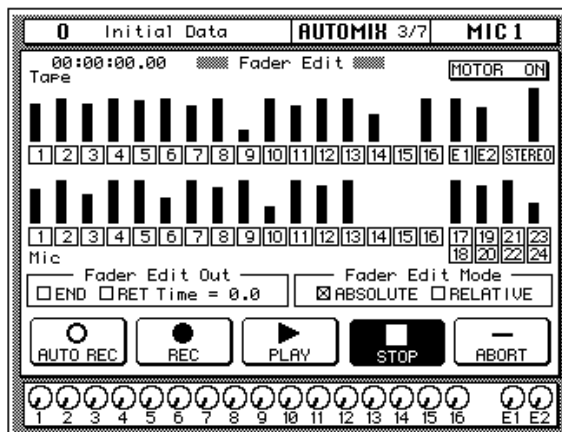

The top half of the display shows the current fader positions graphically for the input channels (MIC/LINE 1 through 16, LINE 17/18 through 23/24), the tape and effect return channels (TAPE 1 through 16, EFF1 and EFF2), and the stereo output. There is also the “MOTOR ON” icon.

The bottom of the display consists of two rows. The first row allows you set the Fader Edit Out to END or RET, set the Return time from 0.0 to 3.0 seconds, and select the Fader Edit Mode (ABSOLUTE or RELATIVE).

The last row contains the automix transport icons (AUTOREC, REC, PLAY, STOP, or ABORT).

MOTOR ON

When you select this icon (the icon is in highlighted and the text reads MOTOR OFF), the fader motors are switched off during playback of an automix. The fader levels will still change according to the recording, but the faders will not move.

Fader Edit & Fader Edit Out Modes

Real-time fader edits can be performed in either Absolute or Relative mode, and can also be combined with the END and RET Edit Out options. The END option works with the Overwrite parameters (FADER, CH ON, PAN, EQ, SURROUND, aux send level, or MIDI Remote). RET works only with fader events.

RELATIVE—In Relative mode, real-time fader edits are recorded relative to existing fader events (i.e., the new fader movements are added to or subtracted from existing events).

ABSOLUTE—In Absolute mode, real-time fader edits are recorded as is (i.e., the new fader movements overwrite the existing events).

RET (Return)—With the RET option on, the fader returns to the position previously recorded at the point recording stops. You can specify the return time from 0.0 to 3.0 seconds. The RET option works when automix recording is stopped using the STOP icon, the incoming timecode is stopped, or the channel is dropped out of recording using a [SEL] button.

END (Write to End)—With the END option on, the fader (CH ON, PAN, EQ, SURROUND, aux send level, or MIDI Remote) remains at the position where recording stops, and remains there all the way to the end of the automix (i.e., data up to the end of the automix is rewritten to accommodate the new fader position). The END option works only when automix recording is stopped using the STOP icon, or the incoming timecode is stopped. It has no effect if a channel is dropped out of recording using a [SEL] button.

With both the END and RET options on, the fader returns to the position previously recorded at the point recording stops and remains at that position all the way to the end of the automix data (i.e., data up to the end of the automix is rewritten to accommodate the fader position returned to when recording is stopped).

Using the END option in Relative mode allows you to apply a relative level change to all fader events for a channel through to the end of the automix. Instead of having to record a relative level change all the way through to the end of the automix, END allows you to stop recording soon after making the level change, and have the 02R automatically rewrite the data up to the end of the automix to accommodate the new fader position.

If the END, RET, and RELATIVE options are all on, when recording is stopped, fader data up to the end of the automix is not rewritten.

Fader Edit

When you record a fader overdub, this display shows the previously recorded level and the new fader setting, plus an arrow indicating which direction the fader will have to be moved to return to the previous level.

Refer to the following diagram:

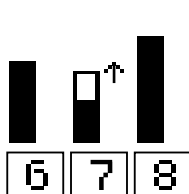

If the fader is moved to a position lower than the previously recorded position

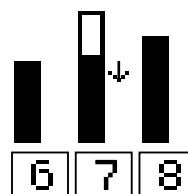

If the fader is moved to a position higher than the previously recorded position

Event Copy

1. Use the (AUTOMIX) button to locate the AUTOMIX 4/7 page.



2. Use the CURSOR buttons and (ENTER) button to select channels and parameters.

3. Use the CURSOR buttons to select “IN Time” and set using the encoder wheel.

4. Use the CURSOR buttons to select “Out Time” and change the value with the encoder wheel.

5. Select the EXTRACT icon with the CURSOR buttons and press the (ENTER) button to extract the specified data.

The Event Copy page, shown below, allows you to copy, move, extract and trim the level of automix events.

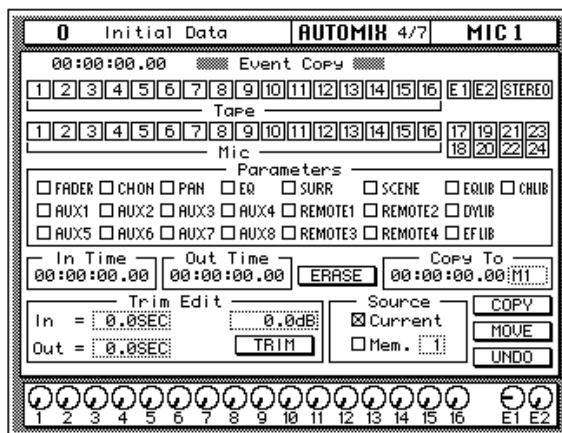

The channel icons are used to select the channels whose automix data is to be edited, and the following channels can be selected: MIC/LINE 1 to 24, TAPE 1 to 16, effects returns (E1, E2), and the stereo output. Multiple channels can be selected for editing. Input channels 17 to 24 are selected in pairs.

The Parameter check boxes are used to select parameters for editing, and multiple parameters can be selected. The parameters are:

- FADER—Input and output level events (faders/rotary encoders)
- CH ON—Channel on/off (mute) events
- PAN—pan events
- EQ—EQ events
- SCENE—Scene memory recall events
- AUX 1–8—Channel aux send events (faders/rotary encoders)
- REMOTE 1–4—MIDI Remote events
- SURR—Surround pan events
- EQ LIB—EQ library program recall events
- CH LIB—Channel library program recall events
- DYLIB—Dynamics library program recall events
- EFLIB—Effects library program recall events

With a channel icon or parameter icon selected, double-clicking the [ENTER] button display the following dialog box, which allows you to select all channels or parameter in one go.



The In Time and Out Time parameters are used to select the range of automix data for editing. The Copy To parameter is used with the Copy and Move/Merge function. When the Source parameter is set to Current, data from the current automix between the In Time and Out Time parameters can be copied or moved to a point specified using the Copy To parameter. When Source is set to an automix from 1 to 16, data from another automix between the In Time and Out Time parameters can be copied to or merged with the current automix. The following table shows how existing data at the source and destination are affected by these functions.

Function	Data at Source	Data at Destination
Copy	Remains	Overwritten
Move	Deleted	Overwritten
Merge	Remains	Merged

Erase

The Erase function allows you to delete the selected parameters from the selected channels between the In Time and Out Time points. When the ERASE icon is pressed, a confirmation dialog box appears.

Copy

The Copy function allows you to copy the selected parameters from the selected channels between the In Time and Out Time points. When the COPY icon is pressed, a confirmation dialog box appears.

When only one channel is selected as a source, you can specify the destination channel using the channel parameter next to Copy To. The destination channel can be selected from MIC 1 to 16, TAPE 1 to 16, LINE 17 to 23, or EFF 1 or 2.

Move/Merge

The Move function allows you to move the selected parameters from the selected channels between the In Time and Out Time points to the Copy To point. When the MOVE icon is pressed, a confirmation dialog box appears. When the Source is set to an automix memory instead of the current automix, the Move function becomes the Merge function.

Trim Edit

The Trim Edit function allows you to trim the fader and rotary encoder levels of the selected channels between the In Time and Out Time points. The In parameter determines how long it takes to reach the specified trim level after the In Time. The Out parameter determines how long it takes to return to the previous level before the Out Time. In and Out parameters can be set from 0.0 to 10.0 seconds in 0.1 second steps.

Undo

The Undo function can be used to undo Erase, Trim, Copy, or Move/Merge operations. When the UNDO icon is pressed, a confirmation dialog box appears.

Event Edit (Scene/Lib.)

1. Use the (AUTOMIX) button to locate the AUTOMIX 5/7 page.



2. Use the CURSOR buttons to select an event to edit.
3. Use the CURSOR buttons to select the DUPLICATE icon and press (ENTER) to duplicate an event.
4. Use the CURSOR buttons to select the DELETE icon and press (ENTER) to delete an event.

The Event Edit (Scene/Lib.) page, shown below, allows you to duplicate and delete mix scene and library recall events, and insert new events. Timecode addresses can be captured on-the-fly, and new events inserted at the captured points. The Locate function provides a speedy way to locate events in a complex automix.

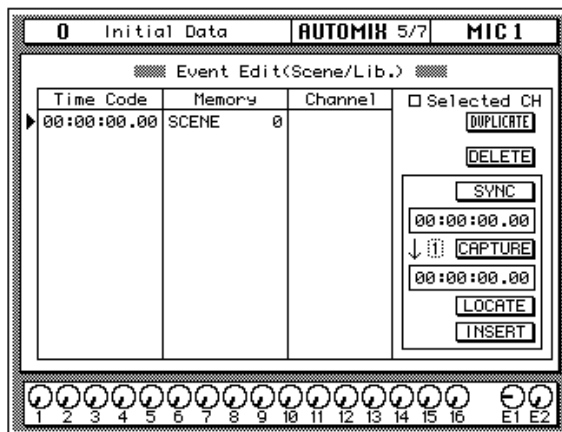

Address Capture

1. With timecode running, press the (CAPTURE) button.
2. To insert an event at the captured address, press the (INSERT) button.
3. Use the (LOCATE) button to locate events around the captured address.

Mix scene recall events and library program recall events are listed in the Time Code, Memory, and Channel columns. Events can be moved by editing the timecode addresses, and events are resorted automatically. In the Memory column, event type and memory number can be edited. In the Channel column, the channel number for EQ, dynamics, effects, and channel library events can be edited. Mix scene events do not have a Channel value. Use the CURSOR buttons to move up or down the event list, and the encoder wheel to edit values.

The selected event can be duplicated or deleted using the DUPLICATE and DELETE icons. When the Selected CH parameter is checked, only events corresponding to the selected channel are listed, useful for editing an automix consisting of many events.

When the SYNC icon is pressed, events occurring around the current timecode address are displayed. The timecode counter below the SYNC icon displays the incoming timecode. When the CAPTURE icon below that is pressed, the current timecode address is captured and displayed in the window below. Up to eight timecode addresses can be captured, and they are stored when the 02R is turned off. The parameter next to the CAPTURE icon is used to select the addresses. When the LOCATE icon is pressed, events occurring about the captured timecode address are displayed. When the INSERT icon is pressed, a new scene recall event is inserted at the captured timecode address. The new event can then be edited as required.

Event Edit (CH ON, PAN, FADER)

1. Use the **(AUTOMIX)** button to locate the **AUTOMIX 6/7** page.



2. Use the **CURSOR** buttons to select an event to edit.
3. Use the **CURSOR** buttons to select the **INSERT** icon and press **(ENTER)** to insert an event.
4. Use the **CURSOR** buttons to select the **DELETE** icon and press **(ENTER)** to delete the current event.

The Event Edit (CH ON, PAN, FADER) page, shown below, allows you edit channel on/off, pan, and fader events, and duplicate, delete, and insert new events. Timecode addresses can be captured on-the-fly, and new events inserted at the captured points. The Locate function provides a speedy way to locate events in a complex automix.

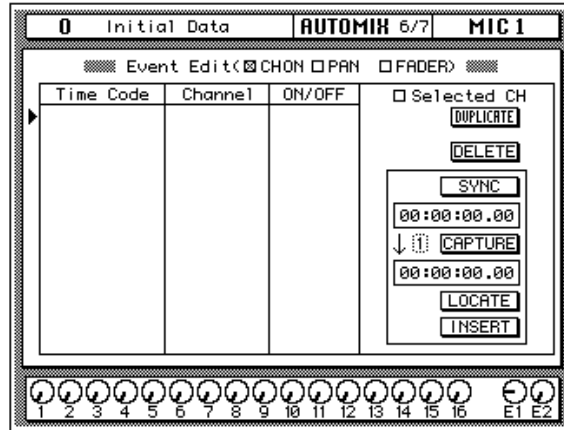

Address Capture

1. With timecode running, press the **(CAPTURE)** button.
2. To insert an event at the captured address, press the **(INSERT)** button.
3. Use the **(LOCATE)** button to locate events around the captured address.

Channel on/off, pan, and fader events are listed in the Time Code, and Channel columns. Events can be moved by editing the timecode addresses, and events are resorted automatically. In the Channel column, the channel number can be edited. The value in the third column depends on the event type selected using the CH ON (ON/OFF), PAN (L-C-R), and FADER (dB/SEC) check boxes. Use the CURSOR buttons to move up or down the event list, and the encoder wheel to edit values.

The selected event can be duplicated or deleted using the DUPLICATE and DELETE icons. When the Selected CH parameter is checked, only events corresponding to the selected channel are listed, useful for editing an automix consisting of many events.

When the SYNC icon is pressed, events occurring around the current timecode address are displayed. The timecode counter below the SYNC icon displays the incoming timecode. When the CAPTURE icon below that is pressed, the current timecode address is captured and displayed in the window below. Up to eight timecode addresses can be captured, and they are stored when the 02R is turned off. The parameter next to the CAPTURE icon is used to select the addresses. When the LOCATE icon is pressed, events occurring around the captured timecode address are displayed. When the INSERT icon is pressed, a new event is inserted at the captured timecode address. The type of event depends on which of the CH ON, PAN, FADER check boxes is checked. The new event can be edited as required.

Time Signature

See the addendum at the end of this manual.

11

MIDI

In this chapter...

MIDI and the 02R.	158
Setup	159
Program Change Assign.	160
Bulk Dump/Request.	161
Fader Start.	163
MIDI Control Change Assign	164
MIDI Remote	165

MIDI and the 02R

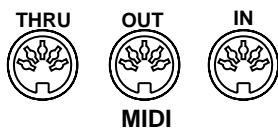

The 02R supports the following MIDI messages:

- Program Changes for mix scene recalls (page 160)
- Control Changes for remote control of 02R mix parameters (page 164)
- System Exclusive for mix parameter control (page 262)
- Bulk Dump for data backup and transfer between 02Rs (page 161)
- MTC (MIDI Timecode) for automix synchronization (page 144)
- Note On/Off for fader start (page 163)
- MIDI Remote for remote device control from the 02R (page 165)
- MIDI Machine Control (MMC) (page 168)

Bulk Dump

The 02R can send or receive the following types of bulk data:

- Scene Memories
- Automix Memories
- Effect Library Programs
- Dynamics Library Programs
- EQ Library Programs
- Channel Library Programs
- System Setup
- Program Change Assign Table

Setup

1. Use the (MIDI) button to locate the MIDI 1/5 page.



2. Use the CURSOR buttons to select the item you want to change and press the (ENTER) button.

The MIDI Setup page is used to configure basic 02R MIDI parameters, such as MIDI transmit and receive channels, OMNI on/off, and echo on/off.

Shown below is the MIDI 1/5 page—MIDI Setup.

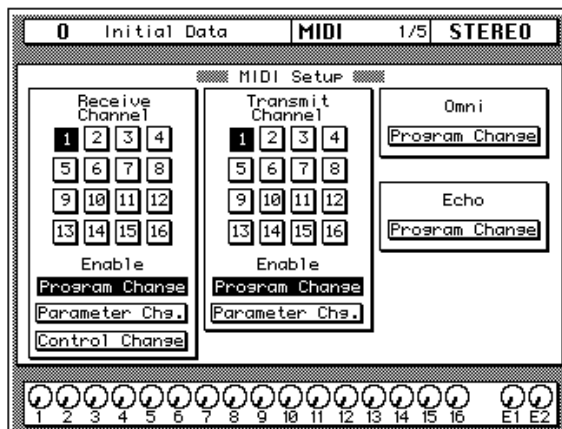

Receive Channel

Use these parameters to set the Receive Channel, and select whether the 02R will receive Program Change, Parameter Change, and Control Change messages. When you change the MIDI Receive Channel, the MIDI Transmit Channel is set automatically to the corresponding channel.

Transmit Channel

Use these functions to set the Transmit Channel, and select whether the 02R will transmit Program Change and Parameter Change messages.

OMNI

Use this function to select whether the 02R will receive Program Change messages regardless of the Receive Channel setting. This parameter is enabled when it is highlighted.

Echo

Use this function to select whether the received Program Change messages are echoed from the MIDI IN to the MIDI OUT. This parameter is enabled when it is highlighted.

Program Change Assign

1. Use the (MIDI) button to locate the MIDI 2/5 page.



MIDI

2. Select a Program Change number with the CURSOR buttons. Use the encoder wheel to change the value of the corresponding Scene Memory number.

Press the (ENTER) button to enable or disable the current Scene Memory number. When a memory is disabled, “---” appears beside the Program Change number.

3. Use the CURSOR buttons to select the “TABLE RESET” control icon and press the (ENTER) button.
4. Select the “UNDO” control icon using the CURSOR buttons and press the (ENTER) button.

MIDI Program Change messages are used to recall scene memories.

Shown below is the MIDI 2/5 page—MIDI Program Change Assign.

0		Initial Data		MIDI		2/5		STEREO	
MIDI Program Change Assign									
PGM=MEM TABLE RESET UNDO									
1= 1	2= 2	3= 3	4= 4	5= 5	6= 6	7= 7	8= 8	9= 9	10=10
17=17	18=18	19=19	20=20	21=21	22=22	23=23	24=24	25=25	26=26
33=33	34=34	35=35	36=36	37=37	38=38	39=39	40=40	41=41	42=42
49=49	50=50	51=51	52=52	53=53	54=54	55=55	56=56	57=57	58=58
65=---	66=---	67=---	68=---	69=---	70=---	71=---	72=---	73=---	74=---
81=---	82=---	83=---	84=---	85=---	86=---	87=---	88=---	89=---	90=---
97=---	98=---	99=---	100=---	101=---	102=---	103=---	104=---	105=---	106=---
113=---	114=---	115=---	116=---	117=---	118=---	119=---	120=---	121=---	122=---
127=---	128=---	129=---	130=---	131=---	132=---	133=---	134=---	135=---	136=---

The default Program Change Assign table consists of a mapping of Program Change numbers 1 through 96 to Scene Memories 1 through 96. Program Change numbers 98 through 127 are mapped to nothing. Messages containing those Program Change numbers are ignored. Program Change number 97 is mapped to Scene Memory 0 (initial data). A scene memory to Program Change assignment table is provided on page 255.

TABLE RESET

The TABLE RESET command sets the Program Change Assign table back to its default mapping.

UNDO

The UNDO command restores the Program Change Assign table to its previous state.

Backup

You can create a Program Change Assign table and save it to a data storage device such as a MIDI data filer by executing the Program Change Assign table Bulk Dump command.

Bulk Dump/Request

1. Use the (MIDI) button to locate the MIDI 3/5 page.



MIDI

2. Select the “TYPE” of data you want to dump or request with the CURSOR buttons and press the (ENTER) button.
3. Use the CURSOR buttons to select the “NUMBER” field and use the encoder wheel to select the desired program or memory.
4. Select the “EXECUTE” command with the CURSOR buttons and press the (ENTER) button to execute the MIDI bulk dump or request.

The 02R uses MIDI Bulk Dump and Request messages to store or recall scene memories, automix memories, system setup and program change tables, and effects, dynamics, EQ, and channel library programs.

Shown below is the MIDI 3/5 page—MIDI Bulk Dump & Request.

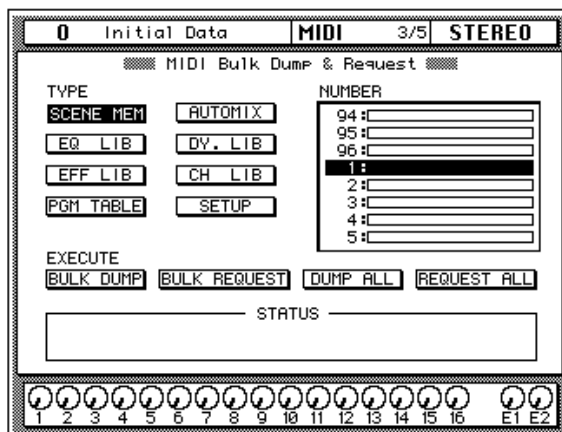

Type

This function allows you to select eight types of 02R data to Bulk Dump or Bulk Request:

- Scene Memories
- Automix Memories
- Channel Library Programs
- Dynamics Library Programs
- Effect Library Programs
- EQ Library Programs
- System Setup
- Program Change Assign Table

Number

For all of the data types except the System Setup and Program Change Assign Table data, you can select the number of the program or memory you want to dump or request. The list shows the program number and its corresponding name.

Execute

There are four commands you can execute:

- **BULK DUMP**—the data of the selected type and number will be output to the connected MIDI device.
- **BULK REQUEST**—the 02R will request the selected type and number from the connected MIDI device.
- **DUMP ALL**—all the programs or memories of the selected data type will be transmitted to the connected MIDI device.
- **REQUEST ALL**—the 02R will request all the programs or memories of the selected data type from the connected MIDI device.

When you execute one of the above commands, the 02R displays its current status in the STATUS field at the bottom of the display.

You can abort a bulk data transmission by moving the cursor with the CURSOR buttons.

Important: *Do not turn off the 02R while transmitting or receiving Bulk Dump data. Doing so may damage the data stored in the 02R.*

Fader Start

When the Fader Start preference is checked (“Preferences” on page 198), a MIDI Note On message (velocity 127) is transmitted when a fader is raised from infinity (∞). When the fader is moved back to infinity, a corresponding MIDI Note Off message (velocity 0) is transmitted. This can be used in conjunction with a “MIDI to trigger” interface box to automatically start CD players, tape decks, etc. This function is intended for use with stereo sound sources. That’s why only the odd-numbered channels 9, 11, 13, and 15 cause a MIDI Note on message to be transmitted. Paired mono input channels 9 to 16 and the stereo channels 17 to 24 provide up to eight stereo pairs for use with Fader Start. MIDI Note messages are transmitted on the Transmit Channel set on the MIDI 1/5 page. MIDI Note On Messages are of the format 9n, kk, vv. Where kk is the note number and vv is the velocity.

Channel	Note Number	
	Decimal	Hex
MIC9	37	25h
MIC11	38	26h
MIC13	39	27h
MIC15	40	28h
LINE17/18	41	29h
LINE19/20	42	2Ah
LINE21/22	43	2Bh
LINE23/24	44	2Ch

MIDI Control Change Assign

1. Use the (MIDI) button to locate the MIDI 4/5 page.



2. Use the CURSOR buttons to select the Control Change column, and the encoder wheel to select a Control Change.
3. Use the CURSOR buttons to select the parameter type, channel type, and channel number parameters, and the encoder wheel to set them.
4. To initialize the assignments, use the CURSOR buttons to select a mapping (P.MIX01, 02R, 03D) and press the (ENTER) button.

A confirmation dialog box appears. By default "CANCEL" is selected.

5. Use the CURSOR buttons to select "EXECUTE" and press the (ENTER) button.

The MIDI Control Assign page is used to assign 02R parameters to MIDI Control Changes, which can be used to control 02R mix settings in real time. 02R mix settings can be controlled by transmitting Control Changes from other MIDI devices. A synthesizer with assignable sliders, for example. Note that the 02R does not transmit Control Change messages.

Up to 114 02R mix parameters can be assigned to Control Changes 0 to 95 and 102 to 119 (Control Changes 96 to 101 cannot be used). See Parameter to Control Change Table (02R & User Maps) on page 256 for more information.

To use Control Change messages, make sure that the Receive Channel Control Change parameter is enabled on the MIDI Setup page. See *Setup* on page 159 for more information.

Shown below is the MIDI 4/5 page—MIDI Control Assign.

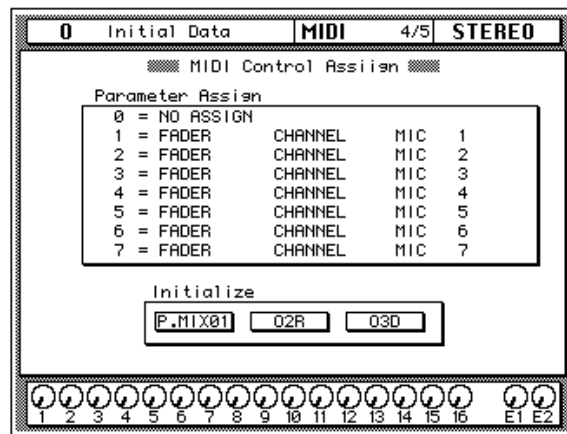

Parameters in the Parameter Assign window of this page consist of four columns. From left to right: Control Change number (0 to 95 and 102 to 119), parameter type (FADER, ON, PANPOT, BALANCE, SURROUND, and EQ), channel type (CHANNEL, AUX 1–8 SEND), and channel number (MIC 1–16, LINE 17–24, TAPE 1–16, EFF1, EFF 2, ST MASTER).

Parameters can be reset to the initial assignments using the 02R Initialize function. In addition, Control Change to parameter maps for Yamaha's Programmable Mixer 01 and 03D Digital Mixing Console are provided. Use these maps when controlling the 02R from one of these consoles. See Parameter to Control Change Table (03D & Programmable Mixer 01 Maps) on page 259 for more information.

MIDI Remote

The MIDI Remote function allows you to control other MIDI equipment from the 02R. Connection is made using the MIDI IN and OUT connections. Remote equipment can be controlled using the 02R faders, rotary encoders, [ON] buttons, CURSOR buttons, and encoder wheel. MIDI Remote operations are recorded by the automix, so real time adjustments on other MIDI equipment can be automated.

The following MIDI equipment can be controlled from the 02R.

- Bus/ Aux Master (controls bus and send levels on 02R)
- MIDI Machine Control
- Digital mixers—Yamaha Programmable Mixer 01, 02R, 03D
- GM tone generator
- XG tone generator
- Digital effects processors—Yamaha ProR3, REV500
- Pro Tools

MIDI Remote Connections

Remote equipment is connected to the 02R using the MIDI IN and OUT connections. Two typical setups are shown below.

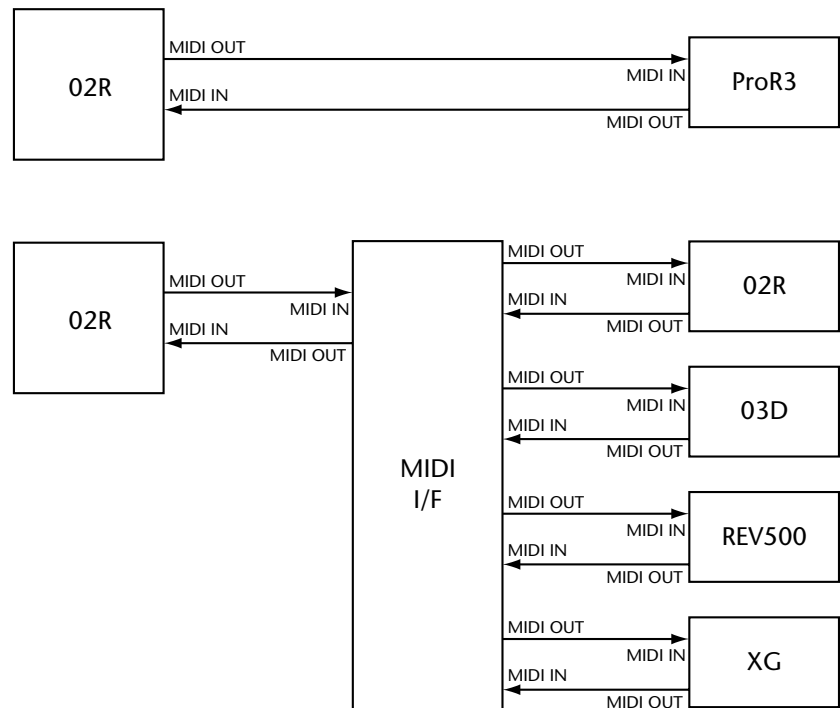

Configuring Remotes

1. Use the (MIDI) button to locate the MIDI 5/5 page.



The (FLIP) button flashes.

To get to the MIDI 5/5 quickly, hold down the (FLIP) button for about one second.

2. Use the CURSOR buttons to select a REMOTE icon, and press the (ENTER) button to activate it.
3. Use the CURSOR buttons to select the rotary icon, and the encoder wheel to select a remote configuration.
4. Use the CURSOR buttons to select the MIDI CH parameter, and the encoder wheel to select a MIDI Channel for the remote.

Only MIDI Channels other than the MIDI Channels selected on the MIDI 1/5 page can be selected.

MIDI Remote operations take place on the MIDI 5/5 page shown below. Up to four remotes can be active at the same time, each operating on a different MIDI Channel. The REMOTE 1 to 4 icons are used to select the remotes.

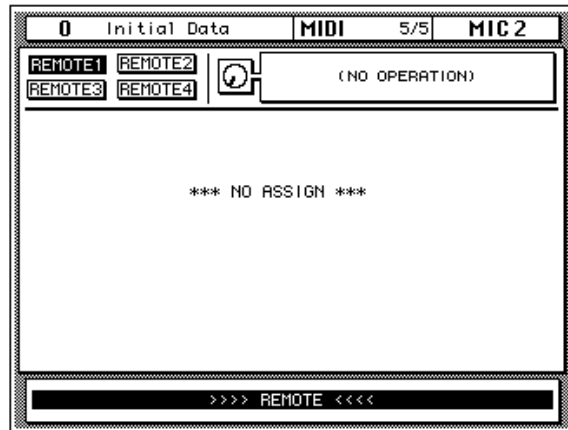

On the page shown below, the Programmable Mixer 01 configuration has been selected for use with REMOTE 1. The same configuration can be selected for use with several remotes. So you could, for example, control two or three 02Rs remotely.

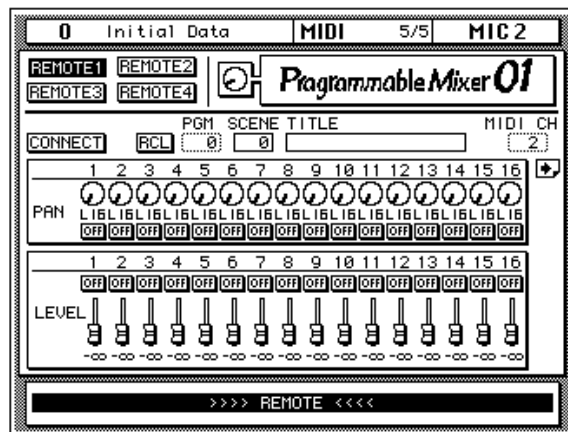

While the MIDI 5/5 page is selected, the following controls have no effect on the 02R (essentially these control are in a local off condition): 02R faders, rotary encoders, [ON] buttons, MIC/LINE [SEL] buttons 1 to 16, CURSOR buttons, and encoder wheel. To remind you of this the message ">>>> REMOTE <<<<" flashes at the bottom of the MIDI 5/5 page.

The various remote configurations are explained on the following pages.

BUS/AUX Master

The Bus/ Aux Master page is not really a MIDI Remote page because it controls the bus out, aux send, and stereo master levels of the 02R itself. Although similar to the METER 3/3 page, this page allows you to use the 02R faders instead of the encoder wheel to set the levels.

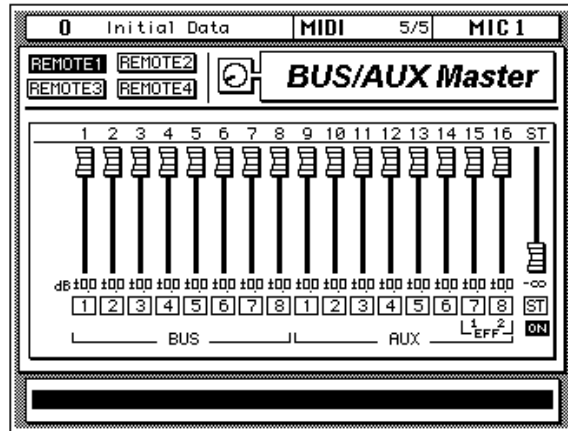

While the BUS/AUX Master page is selected, MIC channel [SEL] buttons 1 to 14 can be used to make and break bus and aux pairs. To make a pair, press and hold the [SEL] buttons of both channels. When the Make Pair dialog box appears, select EXECUTE to pair the channels. Which channel's settings are copied to the other channel depends on which [SEL] button you press first. For example, if you press the MIC 1 [SEL] button and then MIC 2 [SEL] button, the settings of the bus 1 channel are copied to the bus 2 channel, and vice versa. The Make Pair dialog box, shown below, indicates in which direction the channels settings will be copied.



To cancel a channel pair, press both [SEL] buttons, and choose EXECUTE on the Break Pair dialog box.

MIDI Machine Control

02R controls can be used to remotely control the following parameters of a device that supports MMC (MIDI Machine Control), such as a recorder.

02R Controls		Parameters on the MMC Device
[ON] buttons	MIC 1	Rewind
	MIC 2	Fast Forward
	MIC 3	Stop
	MIC 4	Play
	MIC 5	Pause
	MIC 6	Record
	TAPE 1–8	Locate points 1–8 recall

Transport functions on MMC supporting device can be controlled from the 02R using MIC [ON] buttons 1 to 6. Up to eight locate points can be set using the CURSOR buttons and encoder wheel, and TAPE [ON] buttons 1 to 8 are used to locate the specified points. These locate points are linked with the capture buffers in Automix mode, and when time code is inputted, press the [ENTER] button while the cursor is on the locate point number to capture the time code. Time reference and frame rate are also linked with the Automix mode. Set the Device Number (DEVICE NO) to match that assigned to the MMC device.

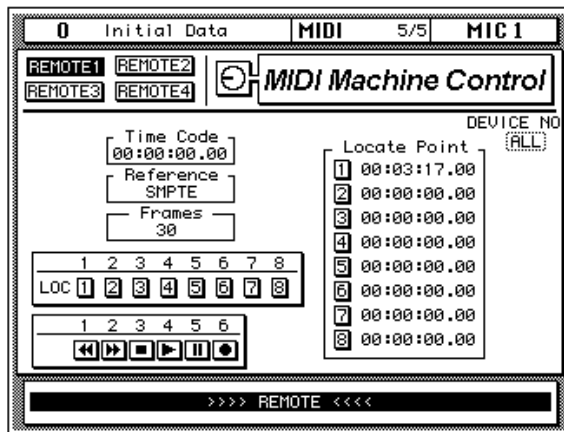

Yamaha Programmable Mixer 01

02R controls can be used to remotely control the following parameters of a Yamaha Programmable Mixer 01.

02R Controls		Parameters on the Programmable Mixer 01
Faders	MIC 1–16	Channel levels 1–16
	17/18	Stereo input level
	STEREO	Stereo output level
Rotary encoders	TAPE 1–16	Input channel pans 1–16
	EFF1 & EFF2	Effects returns levels 1 & 2
[ON] buttons	MIC 1–16	Channel on/off 1–16
	EFF1 & EFF2	Effects returns on/off 1 & 2
	17/18	Stereo input on/off
	STEREO	Stereo output on/off
Display functions		Mix scene recall

Programmable Mixer 01 Setup

On the Programmable Mixer 01's MIDI SETUP page, set the PROGRAM, CONTROL, and BULK parameters as shown below. Set the Tx Ch and Rx Ch parameters to match the MIDI Transmit Channel and Receive Channel settings on the 02R's MIDI 1/5 page.

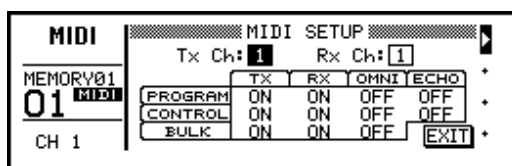

On the Programmable Mixer 01's CONTROL CHANGE ASSIGN page, set the Control Change mode to REGISTER, as shown below.

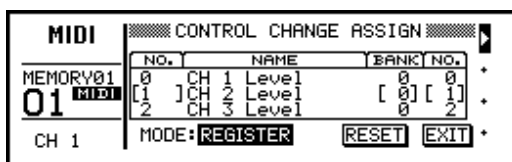

There are two pages for Programmable Mixer 01 remote control. Pages can be selected using the page icon at the right hand side of each page, or by operating a control on that page. For example, operating fader 16 displays the first page, while operating fader 17/18 displays the second page.

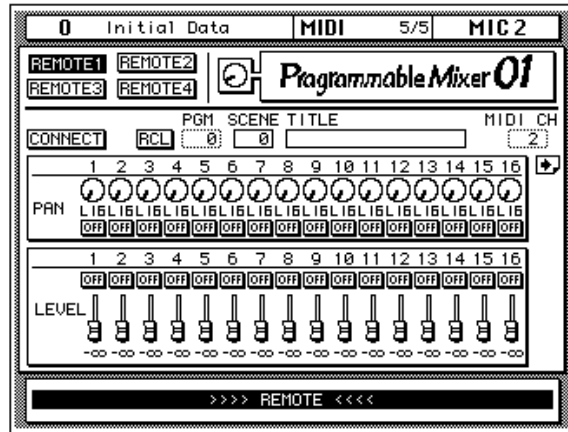

When the 02R or Programmable Mixer 01 is first connected, or turned on, use the CONNECT function to update the 02R controls so that they match those of the Programmable Mixer 01. When the CONNECT function is used, the settings from the Programmable Mixer 01 are copied to the 02R.

Scene memories on the Programmable Mixer 01 can be recalled from either page. To do this, use the PGM parameter to select a MIDI Program Change from 0 to 127. When the RCL icon is pressed, the corresponding scene memory is recalled on the Programmable Mixer 01, and the 02R controls move to their new positions. The SCENE number and TITLE parameters do not change until the scene is recalled. Then they display the scene memory number and title. The 02R fader positions correspond to fader positions on the Programmable Mixer 01. Likewise, the indicators in the 02R [ON] buttons show which channels on the Programmable Mixer 01 are turned on and which are turned off.

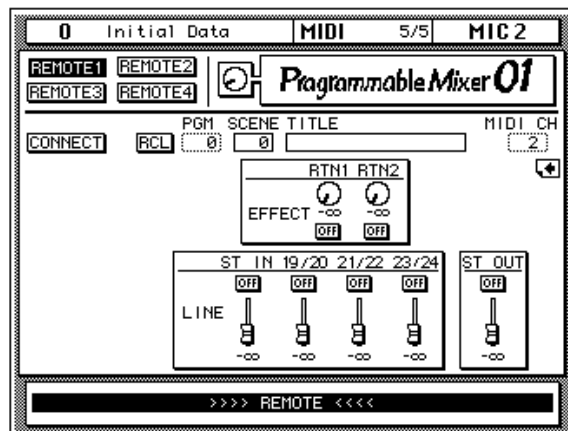

Yamaha 02R Digital Mixing Console

02R controls can be used to remotely control the following parameters of a Yamaha 02R Digital Mixing Console.

02R Controls		Parameters on the 02R Digital Mixing Console
Faders	MIC 1–16	MIC levels 1–16
	LINE 17–24	LINE levels 17–24
	STEREO	Stereo output level
Rotary encoders	TAPE 1–16	TAPE levels 1–16
	EFF1 & EFF2	Effects returns levels 1 & 2
[ON] buttons	MIC 1–16	MIC on/off 1–16
	LINE 17–24	LINE on/off 17–24
	EFF1 & EFF2	Effects returns on/off 1 & 2
	STEREO	Stereo output on/off
Display functions		Mix scene recall

Remote 02R Setup

On the MIDI 1/5 page of the remote 02R, set the Program Change and Parameter Change parameters as shown below. Set the MIDI Receive and Transmit Channels to match those of the controlling 02R

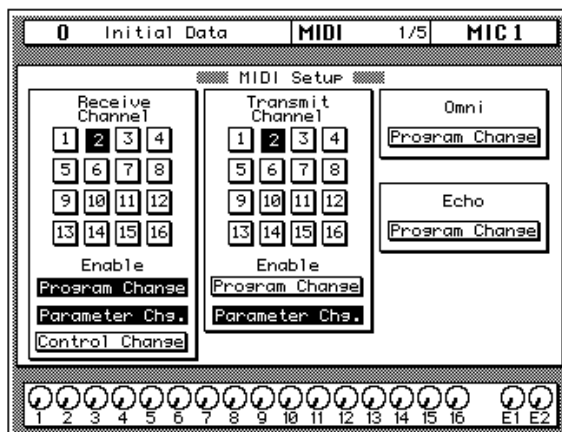

There are two pages for 02R remote control. Pages can be selected using the page icon at the right hand side of each page, or by operating a control on that page. For example, operating fader 16 displays the first page, while operating fader 17/18 displays the second page.

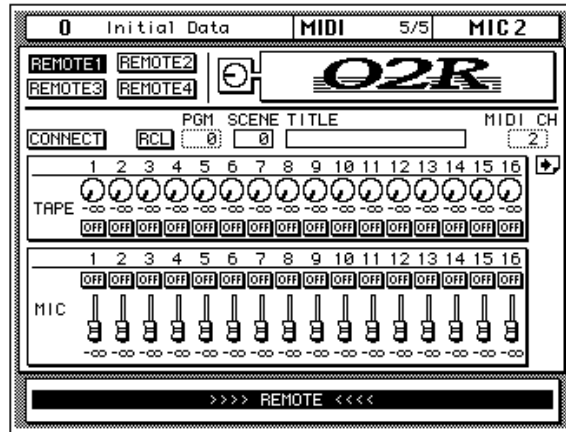

When the 02Rs are first connected, or turned on, use the CONNECT function to update the controlling 02R so that its controls match those of the remote 02R. When the CONNECT function is used, the settings from the remote 02R are copied to the controlling 02R.

Scene memories on the remote 02R can be recalled from either page. To do this, use the PGM parameter to select a MIDI Program Change from 0 to 127. When the RCL icon is pressed, the corresponding scene memory is recalled on the remote 02R, and the controlling 02R controls move to their new positions. The SCENE number and TITLE parameters do not change until the scene is recalled. Then they display the scene memory number and title. The controlling 02R fader positions correspond to fader positions on the remote 02R. Likewise, the indicators in the controlling 02R [ON] buttons show which channels on the remote 02R are turned on and which are turned off.

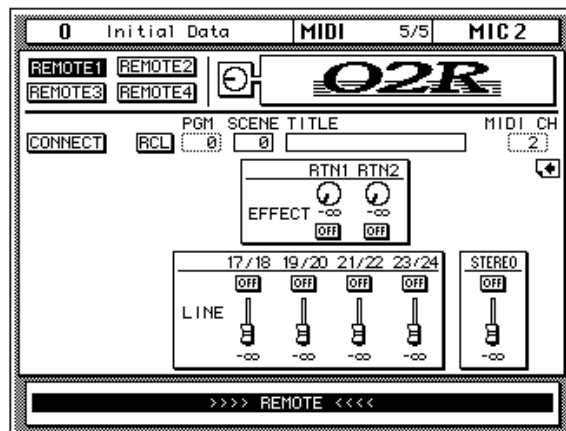

Yamaha 03D Digital Mixing Console

02R controls can be used to remotely control the following parameters of a Yamaha 03D Digital Mixing Console.

02R Controls		Parameters on the 03D Digital Mixing Console
Faders	MIC 1–16	Channel levels 1–16
	17/18	Stereo input level
	STEREO	Stereo output level
Rotary encoders	TAPE 1–16	Input channel pans 1–16
	EFF1 & EFF2	Effects returns levels 1 & 2
[ON] buttons	MIC 1–16	Channel on/off 1–16
	EFF1 & EFF2	Effects returns on/off 1 & 2
	17/18	Stereo input on/off
	STEREO	Stereo output on/off
Display functions		Mix scene recall

03D Setup

On the MIDI Setup page of the 03D, set the various MIDI parameters as shown below. Set the MIDI Receive and Transmit Channels to match those of the 02R

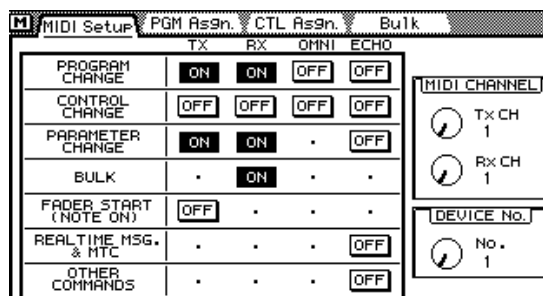

There are two pages for 03D remote control. Pages can be selected using the page icon at the right hand side of each page, or by operating a control on that page. For example, operating fader 16 displays the first page, while operating fader 17/18 displays the second page.

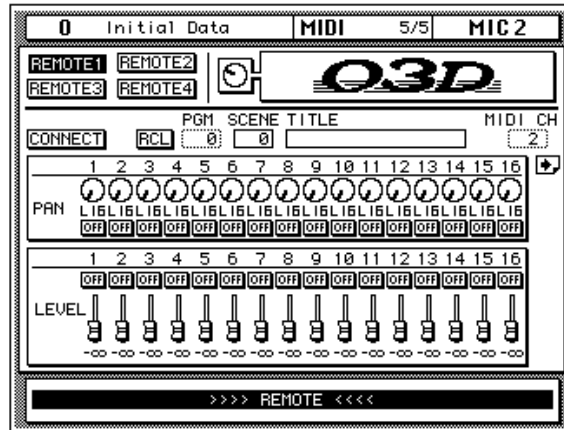

When the 02R or 03D is first connected, or turned on, use the CONNECT function to update the 02R controls so that they match those of the 03D. When the CONNECT function is used, the settings from the 03D are copied to the 02R.

Scene memories on the 03D can be recalled from either page. To do this, use the PGM parameter to select a MIDI Program Change from 0 to 127. When the RCL icon is pressed, the corresponding scene memory is recalled on the 03D, and the 02R controls move to their new positions. The SCENE number and TITLE parameters do not change until the scene is recalled. Then they display the scene memory number and title. The 02R fader positions correspond to fader positions on the 03D. Likewise, the indicators in the 02R [ON] buttons show which channels on the 03D are turned on and which are turned off.

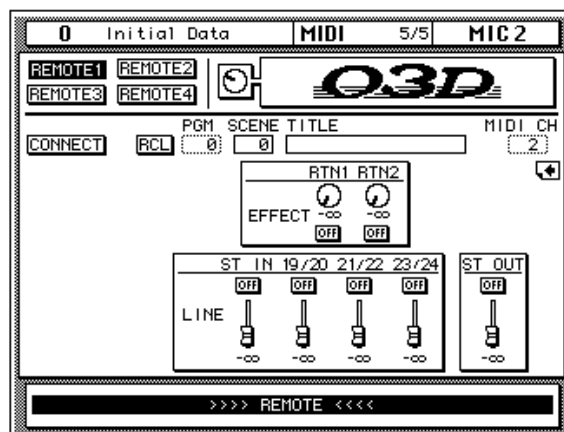

General MIDI Tone Generator

02R controls can be used to remotely control the following parameters of a General MIDI-compatible tone generator.

02R Controls		Parameters on the GM Tone Generator
Faders	MIC 1–16	Part levels 1–16
Rotary encoders	TAPE 1–16	Selectable Control Changes for 1–16
[ON] buttons	MIC 1–16	Part on/off 1–16

There is one page for General MIDI tone generator remote control. The TAPE 1–16 rotary encoders can be assigned to various MIDI Control Changes using the CONTROLLER ASSIGN parameter.

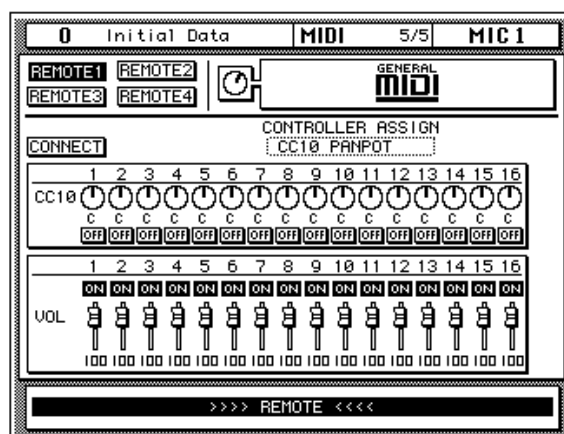

When the 02R or General MIDI tone generator is first connected, or turned on, use the CONNECT function to update the tone generator controls so that they match those of the 02R. When the CONNECT function is used, the settings displayed on the 02R are transmitted to the General MIDI tone generator.

The Part On/Off function controlled using the 02R [ON] buttons is not in the GM specification. To turn a tone generator part off, the 02R transmits a Volume message with a zero value. To turn a tone generator part on, the 02R transmits a Volume message with a value corresponding to the VOL fader displayed on the 02R.

If you use this page to control a MIDI sequencer, for example, the Yamaha QY700, on the MIDI 1/5 page of the 02R disable the Program Change and Control Change parameters.

XG Tone Generator

02R controls can be used to remotely control the following parameters of an XG-compatible tone generator.

02R Controls		Parameters on the XG Tone Generator
Faders	MIC 1–16	Part Volumes 1–16 (17–32)
	LINE 17/18	Part Volume AD 1
	LINE 19/20	Part Volume AD 2
	LINE 21/22	Part Volume Reverb return
	LINE 22/23	Part Volume Chorus return
	STEREO	Part Volume MASTER
Rotary encoders	TAPE 1–16	Part PAN, Reverb, or Chorus 1–16 (17–32)
	EFF 1 RTN	Part PAN, Reverb, or Chorus AD 1
	EFF 2 RTN	Part PAN, Reverb, or Chorus AD 2
[ON] buttons	MIC 1–16	Part on/off 1–16 (17–32)
	LINE 17/18	Part on/off AD 1
	LINE 19/20	Part on/off AD 2
	LINE 21/22	Part on/off Reverb return
	LINE 22/23	Part on/off Chorus return
	STEREO	Part on/off MASTER

There are two pages for XG tone generator remote control. Pages can be selected using the page icon at the right hand side of each page, or by operating a control on that page. For example, operating fader 16 displays the first page, while operating fader 17/18 displays the second page. The PART icon is used to select parts 1 to 16 and parts 17 to 32. The TAPE 1–16 rotary encoders can be assigned for use with Pan, Reverb, or Chorus. This setting is made using the PAN, REV, and CHO icons.

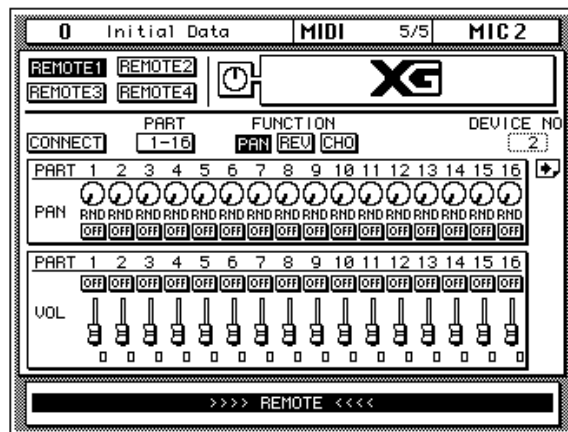

When the 02R or XG tone generator is first connected, or turned on, use the CONNECT function to update the 02R controls so that they match those of

the XG tone generator. When the CONNECT function is used, the settings from the XG tone generator are copied to the 02R.

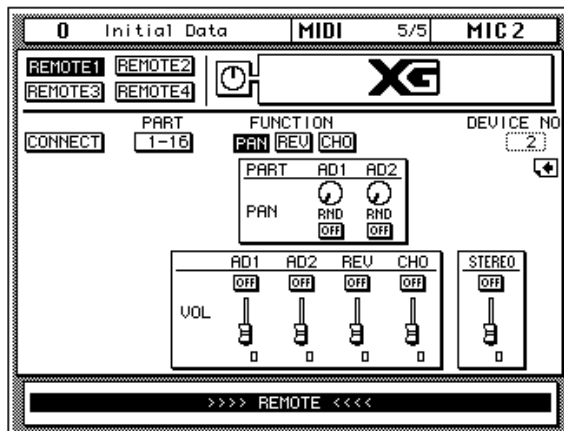

If you use this page to control an XG MIDI sequencer, for example, the Yamaha QY700, on the MIDI 1/5 page of the 02R disable the Program Change and Control Change parameters.

ProR3 & REV500

02R controls can be used to remotely control the following parameters of a Yamaha ProR3 & REV500.

02R Controls		Parameters on the ProR3 or REV500
Faders	MIC 1–16	Parameters 1–16 value
Rotary encoders	TAPE 1–16	Parameters 1–16 value
Display functions		Program recall

REV500 Setup

On the REV500, use the UTILITY button to locate the MIDI Channel page, and set to the same MIDI Channel as that of the REV500 MIDI Remote page (CH). Press the UTILITY button again to locate the MIDI OUT ECHO BACK page, and set to OFF. The REV500 does not receive MIDI messages in Utility mode, so press a PROGRAM button ([TYPE], [PRESET/USER], [-], or [+]) to return to Program mode.

ProR3 Setup

On the ProR3, use the UTILITY button to locate the MIDI Channel page, and set to the same MIDI Channel as that of the ProR3 MIDI Remote page (CH). The ProR3 does not receive MIDI messages in Utility mode, so press the PGM button to return to Program mode.

Apart from the number and type of parameters, the ProR3 and REV500 remote pages are essentially the same. As well as remote parameter control, the 02R can be used to recall reverb programs. To do this, use the PGM parameter to select a reverb program. When the RCL icon is pressed, the corresponding reverb program is recalled on the ProR3 or REV500, and the 02R controls move to their new positions. The TITLE and TYPE parameters do not change until the reverb program is recalled. Then they display the reverb program's title and the type of the effect used. The 02R fader positions correspond to parameter settings on the ProR3 or REV500.

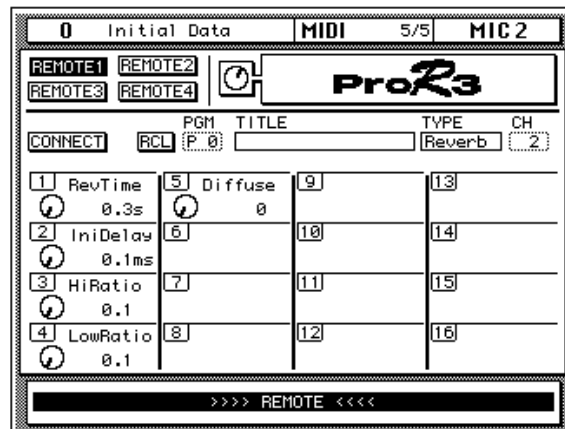

When the 02R or ProR3/REV500 is first connected, or turned on, use the CONNECT function to update the 02R controls so that they match those of the ProR3/REV500. When the CONNECT function is used, the settings from the ProR3/REV500 are copied to the 02R.

0 Initial Data		MIDI	5/5	MIC 2		
REMOTE1	REMOTE2	REV500				
REMOTE3	REMOTE4					
CONNECT		PGM	TITLE	TYPE	CH	
RCL		#1:U:1		Reverb	2	
1	PRE DLY	5	DIFFUS	9	EFF LVL	13
	0.0ms		0		0	
2	REV TIME	6	HPF	10	DENSITY	14
	0.3s		THRU		0%	
3	HI-RATIO	7	LPF	11	LIVENESS	15
	0.1		500Hz		0	
4	LO-RATIO	8	ER LEVEL	12	E/R DLY	16
	0.1		0		0.0ms	
>>>> REMOTE <<<<						

Pro Tools

02R controls can be used to remotely control the following parameters of a Pro Tools system.

02R Controls		Parameters on the Pro Tools System
Faders	MIC 1–16	Track levels 1–16
[ON] buttons	MIC 1–16	Mute 1–16
CURSOR buttons and [ENTER] button		Rewind, Fast Forward, Stop, Play, Record

Pro Tools Setup

Pro Tools 4.0x—In the MIDI Controller area of the Peripheral dialog box, set the MIDI Controller type to either MM16 or DC16. Select 16 as the number of channels. Set the “Receive From” and “Send To” parameters accordingly.

Older version (only 8 tracks are controllable)—In the MIDI Controller area of the Peripheral dialog box, select CS-10 as the Device. Set the “Port” parameter accordingly.

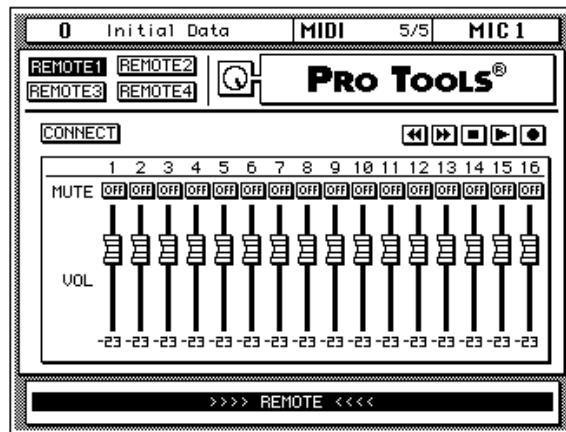

With Pro Tools version 4.0x or later up to 16 tracks can be controlled from the 02R. With earlier versions only eight tracks can be controlled.

Use the cursor buttons to select the Rewind, Fast Forward, Stop, Play, and Record transport icons, and the [ENTER] button execute each function.

Note that [ON] button presses are not recorded by the automix.

12

Groups and Pairs

In this chapter...

Grouping Faders	182
Grouping Mutes.....	183
Pairing Channels	184
MS Decoding	186

Grouping Faders

1. Use the (GROUP) button to locate the GROUP 1/2 page.



2. Use the CURSOR buttons to select from group A through D.
3. Use the (SEL) buttons to add or remove faders to and from the selected group.

Another method is to use the CURSOR buttons to select the faders and press the (ENTER) button.

Note: Stereo-pair channels are added or removed together.

4. Select a “Enable” group icon and turn it on or off by pressing the (ENTER) button.

When a group is off, the LEDs of the faders flash. The individual levels can be adjusted.

The 02R allows you to group the faders for multiple fader control using only one fader. This makes it easy to control several faders simultaneously. The input channel and the tape and effect returns can be grouped. There are four groups available: A, B, C, and D.

Shown below is the GROUP 1/2 page—Fader Group. You can group the input channels—MIC/LINE 1 through 16 and LINE 17/18 through 23/24—and the tape and effect returns—TAPE 1 through 16, EFF1 and EFF2:

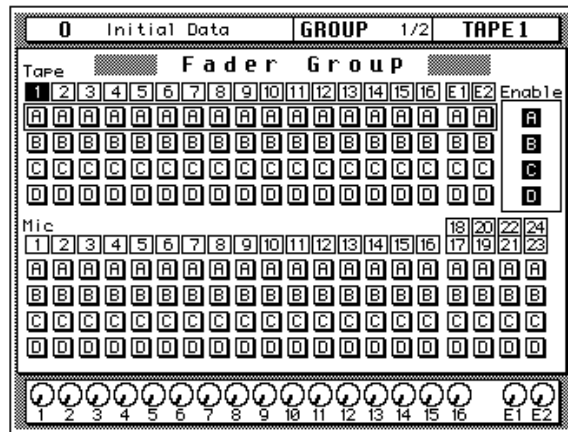

The faders are listed in two main rows with the four group icons below each channel number.

On the right side of the page are the “Enable” group select icons. You can adjust the level balance within a group by turning the group on or off by selecting the corresponding icon (a group is ON when its icon is highlighted) and pressing the [ENTER] button. The LEDs inset in the [SEL] buttons of the faders in the group will flash and they will be ungrouped temporarily, allowing you to adjust the individual fader levels.

If you try to operate multiple faders, the first fader you select will have priority. It is possible to upset the relative positions of the faders if you attempt to operate more than one at a time.

Note: A fader can only be assigned to one group. If you attempt to assign a fader to more than one group, the message “Duplicate Grouping!” appears

Grouping Mutes

1. Use the (GROUP) button to locate the GROUP 2/2 page.



2. Use the CURSOR buttons to select from group E through H.
3. Use the (SEL) buttons to add or remove channels to and from the selected group.

Another method is to use the CURSOR buttons to select the channels and press the (ENTER) button.

Note: Stereo-pair channels are added or removed together.

4. Select a “Enable” group icon and turn it on or off by pressing the (ENTER) button.

When a group is off, the LEDs of the channels flash. You can change the channel status of any channel in the group.

The 02R also allows you to group channel status controls for multiple channel control using only one channel ON button. The channels in a group can be on or off depending on their status when they were grouped. Pressing a channel ON button toggles the status of all the channels in the group. There are four groups available: E, F, G, and H.

Shown below is the GROUP 2/2 page—Mute Group. You can group the input channels—MIC/LINE 1 through 16 and LINE 17/18 through 23/24—and the tape and effect returns—TAPE 1 through 16, EFF1 and EFF2:

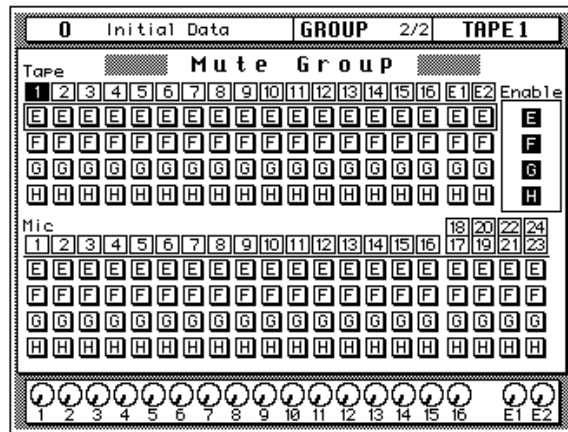

The channels are listed in two main rows with the four group icons below each channel number.

On the right side of the page are the “Enable” group select icons. You can change the status of the channels within a group by disabling the group by selecting the corresponding icon (a group is enabled when its icon is highlighted) and pressing the [ENTER] button. The LEDs inset in the [SEL] buttons of the channels in the group will flash and they will be ungrouped temporarily, allowing you to adjust the individual channel status of the group members.

Note: A channel can only be assigned to one group. If you attempt to assign a channel to more than one group, the message “Duplicate Grouping!” appears.

Pairing Channels

1. Use the (PAIR) button to locate the PAIR 1/2 page.



2. Use the CURSOR buttons to select a pair of channels, and press the (ENTER) button to activate the pair.

1. Press the (PAIR) button again to select the PAIR 2/2 page.
2. Select a pair of aux sends or bus outs, and press the (ENTER) button to activate the pair.

Adjacent channels can be paired for stereo operation. This makes it easy to work with stereo signals, because you only have to adjust one channel to control both left and right signals. The 02R allows you to pair MIC/LINE channels, TAPE channels, aux sends, or bus outs.

There are two pages to the PAIR function. The first page, shown below, contains pair hearts for TAPE channels 1 to 16 and MIC/LINE channels 1 to 16.

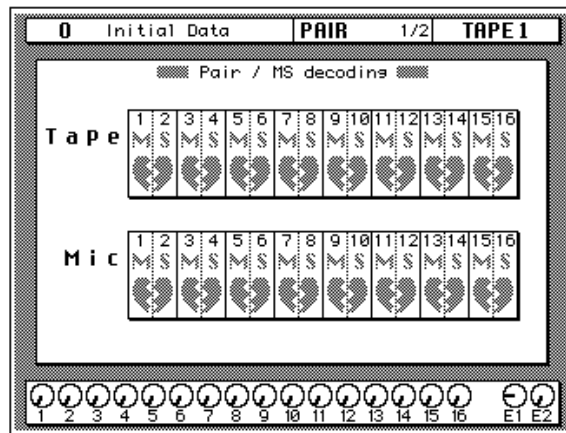

The following functions are linked when TAPE or MIC/LINE channels are paired:

- Faders and encoders
- Aux 1–8 send levels
- Aux 1–8 on/off
- Aux 1–8 pre/post
- Delay on/off
- Delay parameters
- EQ parameters
- Dynamics parameters
- Fader group and mute group
- Fade time
- Recall safe
- Solo on/off
- Surround CSR and subwoofer

The second PAIR page, shown below, contains pair hearts for the aux sends and bus outs.

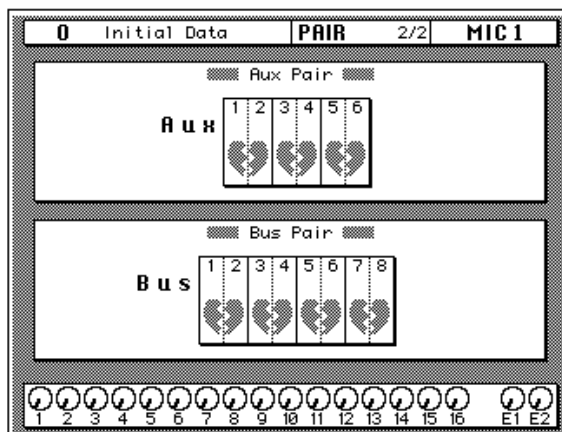

The following functions are linked when aux channels are paired:

- Input channel aux send level (depends on input channel pan)
- Aux master levels
- Aux master on/off and pre/post

The following functions are linked when bus channels are paired:

- Bus master levels
- Dynamics parameters

Use the CURSOR buttons to select a heart and press the [ENTER] button to make or break the pair.

Another method of pairing input channels is to press and hold the [SEL] buttons of both channels. When the Make Pair dialog box appears, select EXECUTE to pair the channels. Which channel's settings are copied to the other channel depends on which [SEL] button you press first. For example, if you press the MIC 1 [SEL] button and then MIC 2 [SEL] button, the settings of the MIC 1 channel are copied to the MIC 2 channel, and vice versa. The Make Pair dialog box, shown below, indicates in which direction the channels settings will be copied.



When a channel from a stereo pair is selected, its [SEL] button indicator lights up, and the [SEL] button indicator on the other channel flashes. To cancel a channel pair, press both [SEL] buttons, and choose EXECUTE on the Break Pair dialog box. The SELECTED CHANNEL AUX buttons can be used to pair aux channels in a similar way.

MS Decoding

1. Use the (PAIR) button to locate the PAIR 1/2 page.



2. Use the CURSOR buttons to select the MS icons, and the (ENTER) button to set them.

The MS function can also be set on the View 1/2 page. See "View" on page 44.

Adjacent MIC/LINE or TAPE channels configured as a stereo pair can be used to decode signals derived using MS microphone techniques. MS signals are controlled using the channel faders and pan controls. Other channel controls work as normal.

Shown below is the PAIR 1/2 page—Pair.

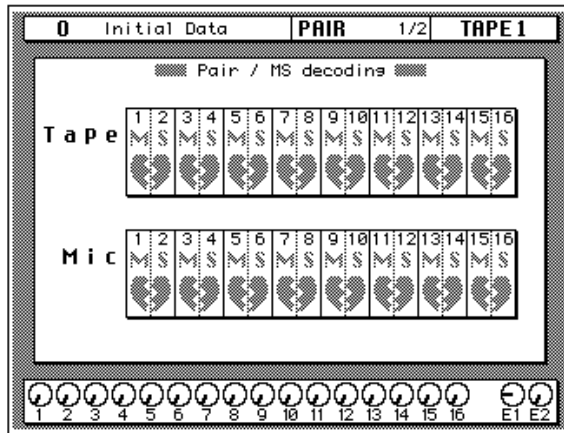

When the MS function is turned on, channels are configured as a stereo pair, although unlike regular pair mode the faders work independently. When the stereo pair is cancelled, the MS function is turned off.

Channels configured in MS mode have to be stored as two individual channel programs, with the odd/M channel as one program, and the even/S channel as another. When you recall these programs, make sure that the destination channels are not already configured as a stereo pair. If they are the channel faders will be set the same.

The width of sound can be controlled by adjusting the S level.

The following table shows how the MS signals work with the channel controls.

MS	Fader Function	Pan Function
M (odd-numbered channel)	M level	ML and MR balance (in the direction of M)
S (even-numbered channel)	S level	SL and SR balance

Bus send levels are as follows:

$$L = ML + SL$$

$$R = MR - SR \text{ (pan coefficient of the right side of S is inverted)}$$

13

Digital I/O, Setup, and Utilities

In this chapter...

Word Clock Select	188
Input Signal Select	190
Cascade Configuration	191
Dither	193
Slot Output Select	194
Solo	196
Preferences	198
Aux Output Select	203
24-bit Recording	204
Input Patching	206
Oscillator	209
Emphasis Monitor	210
Channel Status Monitor	211
Battery Check	213
Communication Speed	214
02R System Initialization	215

Word Clock Select

1. Use the (DIGITAL I/O) button to locate the DIGITAL I/O 1/5 page.



Note: *The 02R always recalls the last page visited even after you turn the power off and back on again.*

2. Use the CURSOR buttons to select a wordclock source and press the (ENTER) button.

The 02R processes audio data at 44.1 kHz or 48 kHz using its internal clock, and can run at any frequency from 32 kHz -6% to 48 kHz $+6\%$ when an external wordclock is applied.

Wordclock

When you connect a number of digital audio devices together, all the devices should synchronize to one device—the wordclock master. The wordclock master generates a sync pulse which allows the other devices connected to it to determine where the start of each digital word is. Although most digital interconnect protocols are self-clocking, it is more reliable to use a dedicated line for your wordclock signal. This is especially important in a multitrack environment where up to eight channels of digital data may be multiplexed on one cable.

When you are using a digital device—such as a DAT mastering recorder or a modular digital multitrack recorder—connected to the 02R, all the digital devices in the system, including the 02R, should synchronize the wordclock being supplied by one master device. If any device does not synchronize to the system wordclock, dropout and/or other noise may occur.

In Section 14, “Installing Options” on page 217 of the *User’s Guide*, there are examples of connecting external digital devices to the 02R and setting the appropriate wordclock selection. Refer to this section for details for each of the optional digital I/O cards.

Note: *Wordclock is not required if you use the analog I/O card (CD8-AD) to connect to an analog multitrack recorder.*

Shown below is the DIGITAL I/O 1/5 page—Word Clock Select.

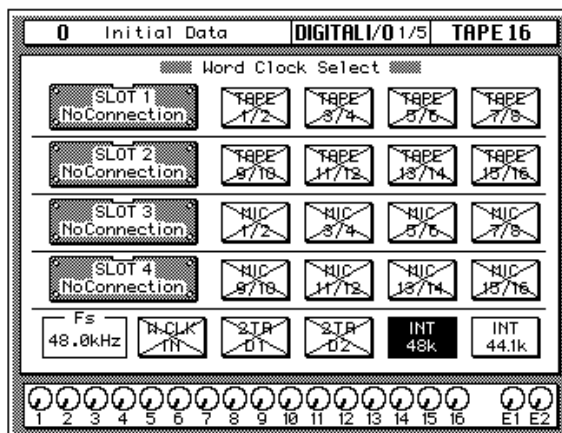

The left side of the display is a list of the cards in the four option slots of the 02R. The indication varies depending on the type of optional card being used:

- Cascade (CD8-CS)
- ADAT (CD8-AT)
- TDIF-1 (CD8-TDII)
- AES/EBU (CD8-AE/CD8-AE-S)
- YAMAHA (CD8-Y)
- Analog AD/DA (CD8-AD)
- Analog A/D (CD8-AD-S)
- No Connection

Beside each optional slot indicator is a row of four boxes defining the connections to the card inserted in the corresponding slot.

Note: *When a cascade card is inserted in any slot, the boxes defining the connections are still displayed. However, you cannot select any of these items.*

Across the bottom of the display are boxes for the external wordclock (W.CLK IN), the digital inputs (2TR D1 and 2TR D2), and the internal wordclock (INT 48k and INT 44.1k). To the left of the boxes are the wordclock indicators.

There is also an indicator—inside the “Fs” box—that shows the current wordclock frequency or status.

Wordclock indicators



No wordclock input.



Wordclock input. However, the input wordclock frequency is different from that of the selected wordclock.



Wordclock input. No discrepancy between the input and selected wordclock frequencies.



Wordclock input is selected. The 02R is synchronized to the input wordclock frequency.



The wordclock input is selected, but the wordclock signal is inappropriate.



Input Signal Select

1. Use the (DIGITAL I/O) button to locate the DIGITAL I/O 2/5 page.



2. Use the CURSOR buttons to select the desired icons. Change the setting by pressing the (ENTER) button.

Note: *If there is no digital I/O card or signal present when you select a digital input, the default analog selection will not be changed.*

The 02R has 24 built-in analog input connectors; the individual input channels (MIC/LINE 1 through 16) and the stereo input channels (LINE 17/18 through 23/24). You can route two of the 2-track digital inputs to the stereo input channels (2TR IN D1 to LINE 17/18 and 2TR IN D2 to LINE 19/20). You can also convert the individual input channels (MIC/LINE 1 through 16) to tape return channels, allowing you to perform 32-track mixdowns with the 02R.

Shown below is the DIGITAL I/O 2/5 page—Input Signal Select.

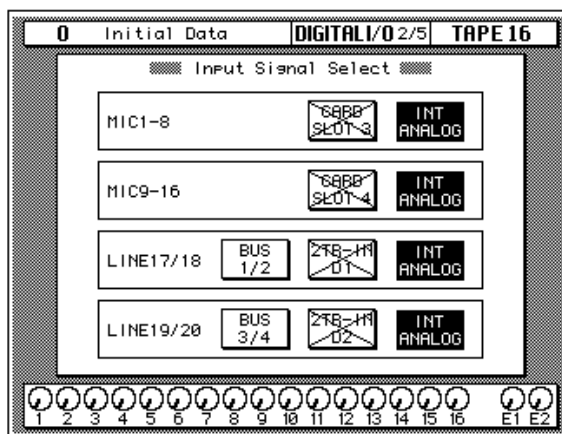

There are four boxes on this page.

The first box is for MIC 1-8 (MIC/LINE 1 through 8). You can select “CARD SLOT 3” or “INT ANALOG” (the default). If there is no digital I/O card in slot 3, the selection will fail.

The second box is for MIC 9-16 (MIC/LINE 9 through 16). You can select “CARD SLOT 4” or “INT ANALOG” (the default). If there is no digital I/O card in slot 4, the selection will fail.

The third box is for LINE 17/18. You can select “BUS 1/2”, “2TR-IN D1”, or “INT ANALOG” (the default). If there is no digital signal (no wordclock present) at the 2TR IN DIGITAL connector #1, the selection will fail.

The fourth box is for LINE 19/20. You can select “BUS 3/4”, “2TR-IN D2”, or “INT ANALOG” (the default). If there is no digital signal (no wordclock present) at the 2TR IN DIGITAL connector #2, the selection will fail.

Note: *You cannot select 2TR-IN D1 or 2TR-IN D2 for digital input/output if the corresponding switch (2TR-D1 or 2TR-D2) for either connector has been selected with the CONTROL ROOM monitor switches.*

Cascade Configuration

1. Use the (DIGITAL I/O) button to locate the DIGITAL I/O 5/5 page.



2. Use the CURSOR buttons to specify which of the internal auxiliary buses the cascade AUX A and AUX B buses will be assigned to.

Press the (ENTER) button to make the selection.

3. Select the “ID” option with the CURSOR buttons and rotate the encoder wheel to specify the cascade ID number.

4. Use the CURSOR buttons to select the cascade input attenuator icons.

Rotate the encoder wheel to change the attenuation level.

5. Select the “2TR-D2 to Stereo Bus” option with the CURSOR buttons and press the (ENTER) button to ENABLE.

Rotate the encoder wheel to change the attenuation level.

Just like the modular digital multitrack recorders it is intended to work with, the 02R was designed to be easily expandable from a basic 16-track (40 input) system up to a 64-track (160 input) system. It uses Cascade Digital I/O card kits (CD8-CS) to accomplish this.

For installation details, see Section 14, “Installing Options” on page 217 of the *User’s Guide*, specifically “Digital Cascade Kit (CD8-CS)” on page 229.

Shown below is the DIGITAL I/O 5/5 page—Cascade Configuration.

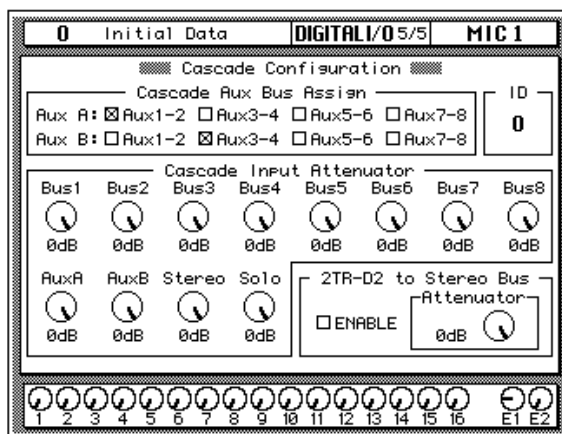

Cascade Aux Bus Assign

The Cascade Digital I/O card kit (CD8-CS) has two paired auxiliary buses: AUX A and AUX B. You can assign these buses to any pair of the 02R's internal auxiliary buses—but not to the same pairs.

If a cascade card is not inserted in the 02R, this display is grayed-out.

ID

The ID value specifies the order in the cascade of this 02R. The first slave unit is assigned 0 (zero). The cascade master is assigned the highest ID value (maximum 3). You can select from 0 to 3 as the unit ID.

You can only set this item when a cascade card is inserted in the 02R and set to IN. When the page is grayed-out, the ID is automatically set to 0.

Cascade Input Attenuator

These icons allow you to set the input level of each bus line that is being input into the 02R. You can set the levels for the internal buses 1 through 8, the cascade auxiliary buses (AUX A and AUX B), the stereo bus, and the solo bus.

You can only set this item when a cascade card is inserted in the 02R and set to IN.

2TR-D2 to Stereo Bus

This option allows you to route the 2TR-D2 digital input connector to the stereo bus. You also can set the attenuation level.

Note: *The device plugged into the 2TR-D2 digital input connector must be synchronized to the system wordclock to prevent dropout and/or other noise. You cannot assign the 2TR-D2 to the stereo bus if the corresponding switch (2TR-D2) has been selected with the CONTROL ROOM monitor switches. Select another monitor source before you try to assign this signal to the stereo bus.*

Custom Cascade

The cascade system was designed to be able to connect four 02R's together, but in fact you can actually add even more units if you want. The cascade digital I/O cards were designed to compensate for the signal delay of connecting up to four units together. If you add more units, you will have to compensate for the signal delay with the DELAY display function. See "Delay and Cascade" on page 34 of the *User's Guide* for more details.

Dither

1. Use the (DIGITAL I/O) button to locate the DIGITAL I/O 4/5 page.



2. Use the CURSOR buttons to select the ON/OFF icon for the desired bus and press the (ENTER) button to change the value.
3. Select the Word Length with the CURSOR buttons and press the (ENTER) button.

When you connect a number of digital audio devices together, you may find their digital word size is different. For example, the 02R uses a 20-bit word size for input and output and a 32-bit word size for internal processing. Professional digital equipment uses a 24-bit wordsize, while consumer digital equipment uses a 20-bit wordsize. In order to obtain the best possible signal quality, the 02R has a dither function for its internal bus and stereo bus outputs.

Dithering is a mathematical process where a random noise is added to the least significant bit of a digital word. With very low level signals, the quantization error becomes correlated to the signal level. This creates a small but measurable amount of distortion. By adding dither, the correlation between the signal level and the quantization error is cancelled, allowing the digital system to encode amplitudes smaller than the least significant bit. If you change the word size as a signal passes from one digital system to another, being able to add dither allows you to maintain a high quality signal.

Shown below is the DIGITAL I/O 4/5 page—Dither.

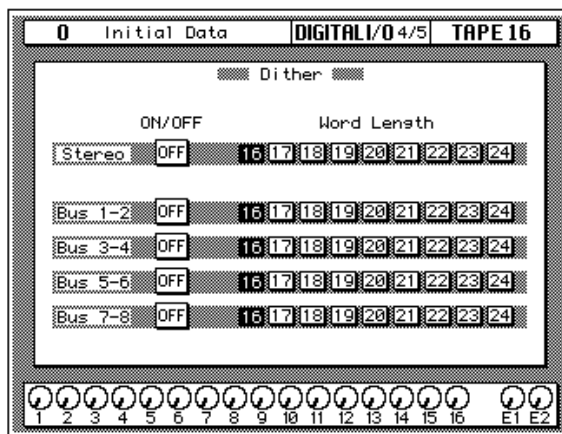

Dither ON/OFF

You can turn the dither function on or off for the stereo bus and for the internal buses 1 through 8. The internal buses are paired for the dither function.

Word Length

You can add dither to compensate for any word size from 16-bit to 24-bit.

Slot Output Select

1. Use the (DIGITAL I/O) button to locate the DIGITAL I/O 3/5 page.



2. Use the CURSOR buttons to chose one of the four SLOT icons, and the (ENTER) button to select it.

Slots can also be selected by pressing the left or right cursor button repeatedly.

3. Use the CURSOR buttons to select a source for each output.

The Slot Output Select function allows you to individually select bus outs, aux sends, channel direct outs, and the left and right channels of the stereo output for I/O card outputs.

Shown below is the DIGITAL I/O 3/5 page—Slot Output Select.

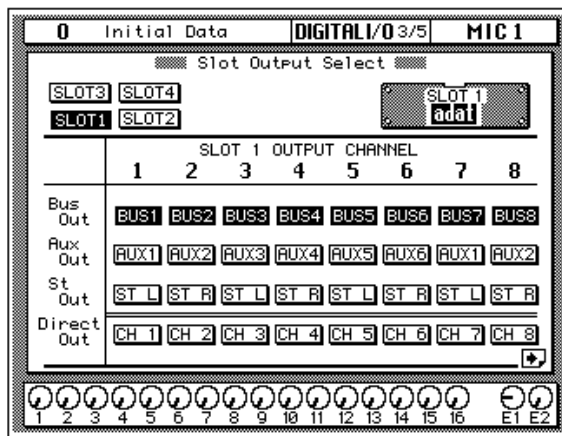

For each output you can select one source: bus, aux, stereo, or direct. By default all outputs are set to bus. Direct outputs 1 to 8 appear on the SLOT 1 page, while direct outputs 9 to 16 appear on the SLOT 2 page.

When no I/O cards are inserted, or a cascade card is inserted, these pages are grayed out.

In 24-bit Recording mode, where each slot is reduced to four outputs, the Slot Output Assign pages appear as follows:

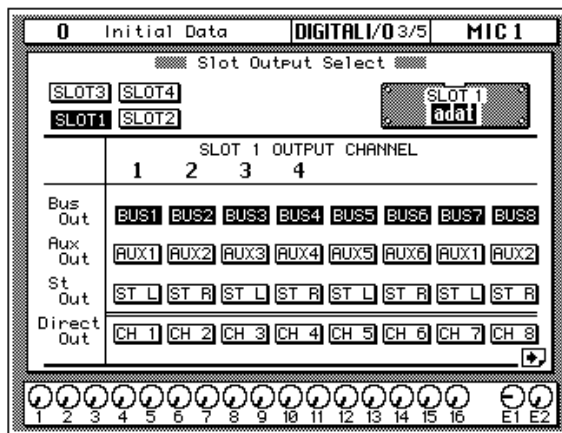

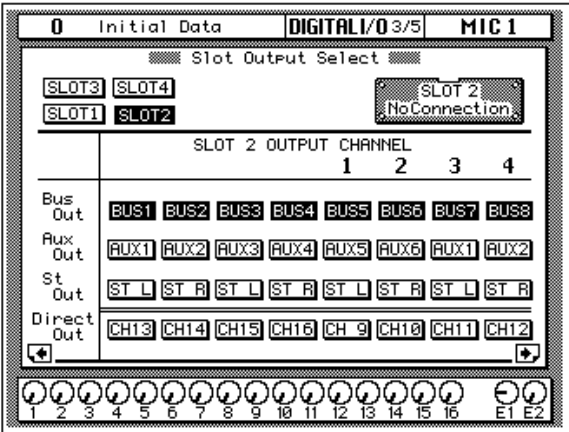

Solo

1. Use the (SETUP) button to locate the SETUP 1/4 page.



SETUP

2. Use the CURSOR buttons to select the desired “Mode” and press the (ENTER) button.

3. Use the CURSOR buttons to select a “Status” and press the (ENTER) button.

Shown below is the SETUP 1/4 page—Solo.

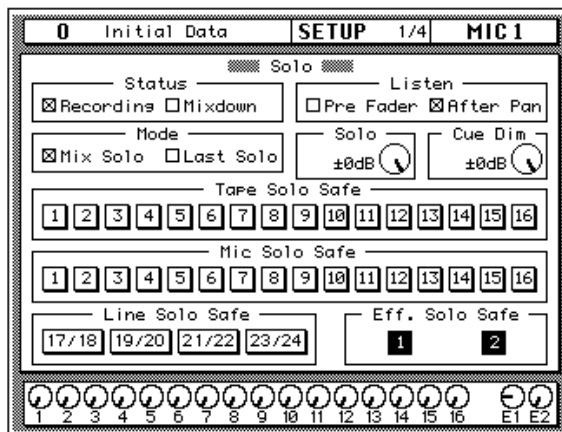

Recording mode:

4. Select a “Listen” point with the CURSOR buttons and press the (ENTER) button.
5. Select the “Solo Level” icon and adjust the level with the encoder wheel.

Mixdown mode:

6. Use the CURSOR buttons to select the “Solo Safe” channels and press the (ENTER) button to enable/disable the selected channel.

Solo Functions

- **Status**—This command determines which bus will be used when you press the [SOLO] button. If you select “Recording”, the Solo bus will be used. If you select “Mixdown”, the signals selected by the combination of the [SOLO] button and the [ON] buttons will be sent to the Stereo bus, and all other channels will be off.
- **Listen**—This command is only functional in “Recording Mode”. It selects the point the Solo monitoring signal will be taken from. You can select “Pre Fader” or “After Pan” as the monitoring points.

In “Mixdown Mode” the signal is always taken from after the pan and this function is grayed-out.

- **Mode**—This command controls which channels are added to the Solo. If you select “Mix Solo”, all channels that are selected ON will be added to output. If you select “Last Solo”, the channel that was last selected ON will be output.

If you only want to listen to one channel at a time in solo mode, select “Last Solo”.

- **Solo Level**—This rotary icon controls the output level sent to the Solo bus in “Recording Mode”.

In “Mixdown Mode” the signal is sent to the stereo bus and this icon is grayed-out.

- **Cue Dim**—This rotary icon sets the level to which the cue outputs are dimmed when talkback is engaged.

- **Solo Safe—Tape, Mic, Line, and Effects**—These functions disable solo On/Off selection. If you set a channel to Solo Safe while it was set to Solo ON, the channel remains unconditionally ON in “Mixdown Mode” when you select Solo.

This function has no effect in “Recording Mode”.

How to use Solo

1. Press the (SOLO) button.

The LEDs inset in all the [ON] buttons start flashing.

2. Press the (ON) buttons for the channels you want to solo.

The LED inset in the [ON] button you select is illuminated steadily. If you selected “Last Solo” in the Status command, only the last channel you select will be soloed.

3. Press the (SOLO) button again to cancel the solo function.

Preferences

1. Use the (SETUP) button to locate the SETUP 3/4 or SETUP 4/4 page.



SETUP

2. Use the CURSOR buttons to select a preference.
3. Enable or disable the preference by pressing the (ENTER) button.

The 02R is a very flexible mixer. You can customize its behavior to suit your needs using the preferences, which are divided into two pages: SETUP 3/4 and SETUP 4/4.

Shown below is the SETUP 3/4 page—Preferences 1.

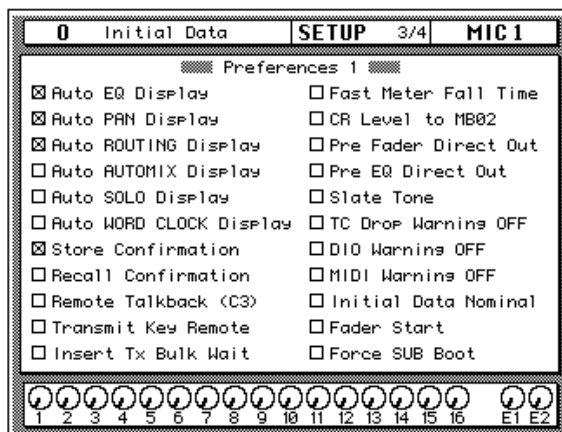

Preferences 1 Options

- **Auto EQ Display**—With this option checked, when you operate the buttons or controls in the SELECTED CHANNEL—EQUALIZER group, the EQ page appears automatically.
- **Auto PAN Display**—With this option checked, when you operate the buttons or controls in the SELECTED CHANNEL—PAN group, the PAN page appears automatically.
- **Auto ROUTING Display**—With this option checked, when you operate the buttons in the SELECTED CHANNEL—ROUTING group, the ROUTING 1/4 page appears automatically.
- **Auto AUTOMIX Display**—With this option checked, the AUTOMIX 1/7 page appears automatically when automix recording is stopped.
- **Auto SOLO Display**—With this option checked, the SETUP 1/4 page appears automatically when you press the [SOLO] button.
- **Auto WORD CLOCK Display**—With this option checked, the DIGITAL I/O 1/5 page appears automatically if a DIGITAL I/O error occurs.
- **Store Confirmation**—With this option checked, the 02R will request you confirm any scene memory or library store or clear operations. The initial setting is checked.

You should leave this option in its default state when your 02R is going to be operated by an inexperienced person. Forcing them to respond to a confirmation message may prevent the accidental loss of your valuable data.

When you confirm a STORE or CLEAR operation, any existing data in the selected program location will be overwritten or cleared.

YOU SHOULD ALWAYS BE CAREFUL WHEN THE 02R DISPLAYS A CONFIRMATION DIALOG BOX!

- **Recall Confirmation**—With this option checked, the 02R will request you confirm any scene memory or library recall operation.
- **Remote Talkback (C3)**—With this option checked, you can enable the Talkback system by sending a MIDI Note On message for C3. You disable the Talkback system by sending a MIDI Note Off message for C3.
- **Transmit Key Remote**—With this option checked, when you operate any buttons, controls, or faders, the 02R will transmit system exclusive parameter change messages from its MIDI OUT connector. This is intended to be used to remotely control another 02R.
- **Insert Tx Bulk Wait**—With this option checked, Bulk Dump data is transmitted at intervals. When another device cannot receive 02R Bulk Dump data correctly, turning this option on may help.
- **Fast Meter Fall Time**—With this option checked, the level meters will respond more quickly to level changes. When the option is not checked, the level meters delay their fall in order to allow you to see the level changes more clearly.
- **CR Level to MB02**—With this option checked, the level of the C-R MONITOR OUT signal is displayed on the optional MB02's stereo meters.
- **Pre Fader Direct Out**—With this option checked, the direct output signal is sourced pre fader. Normally, the direct output signal is sourced post fader.
- **Pre EQ Direct Out**—With this option checked, the direct output signal is sourced pre EQ. You cannot turn on both Pre EQ Direct Out and Pre Fader Direct Out at the same time.
- **Slate Tone**—With this option checked, when you press the [SLATE] button, a 50 Hz tone at -34 dB is recorded along with the talkback input.
- **TC Drop Warning OFF**—With this option checked, the 02R will not report a warning when the timecode reader detects a frame dropout.

If you have a noisy connection to your timecode source, or it was poorly recorded on an analog recorder, this message may appear so often that it becomes distracting. However, if you know your timecode source is reliable, you may want to leave this option off so that the 02R can warn you of any undesirable timecode events.

- **DIO Warning OFF**—With this option checked, the 02R will not report a warning when an error is detected in the digital signals being input from one of the digital I/O cards. When the 02R detects an error, the message "DIGITAL I/O Error!" is flashed on the display.

If you have a poor connection to your modular digital multitrack recorder or any other digital audio devices, this message may appear so often that it becomes distracting. You should be aware that if the 02R

detects an error in the digital input or output, your recorded data may be compromised. However, some modular digital multitrack recorders will cause this error while performing synchronization during start-up.

- **MIDI Warning OFF**—With this option checked, the 02R will not report a warning when it receives a MIDI error.

The following error conditions will not be reported: “Byte Count Error!”, “Check Sum Error!”, “Code Mismatch!”, “ID Mismatch”, and “MIDI Ch Mismatch”.

- **Initial Data Nominal**—When scene memory 0 is recalled, all channel faders move to the minimum position. With this preference checked, however, they move to the nominal position. Aux and bus master faders move to the nominal (0.0 dB) position regardless of this preference.
- **Fader Start**—When the Fader Start preference is checked, a MIDI Note On message is transmitted when an odd-numbered channel fader is raised from infinity (oo). See “Fader Start” on page 163.
- **Force SUB Boot**—With this option checked, the 02R forces the SUB CPU to boot each time the 02R is turned on. Check this option to prevent the 02R from booting the SUB CPU when you select MIDI Clock as the automix Time Reference, or assign a MIDI Remote page. Since MIDI Remote page assignments are stored in scene memories, the SUB CPU may boot when a scene memory containing MIDI Remote parameters is recalled. Turning on the Force SUB Boot check box will prevent this.

Preferences 1—Factory Settings

Option / Setting		Option / Setting	
Auto EQ Display	ON	Fast Meter Fall Time	OFF
Auto PAN Display	ON	CR Level to MB02	OFF
Auto ROUTING Display	ON	Pre Fader Direct Out	OFF
Auto AUTOMIX Display	OFF	Pre EQ Direct Out	OFF
Auto SOLO Display	OFF	Slate Tone	OFF
Auto WORD CLOCK Display	OFF	TC Drop Warning OFF	OFF
Store Confirmation	ON	DIO Warning OFF	OFF
Recall Confirmation	OFF	MIDI Warning OFF	OFF
Remote Talk Back (C3)	OFF	Initial Data Nominal	OFF
Transmit Key Remote	OFF	Fader Start	OFF
Insert Tx Bulk Wait	OFF	Force SUB Boot	OFF

Preferences 2

Shown below is the SETUP 4/4 page—Preferences 2.

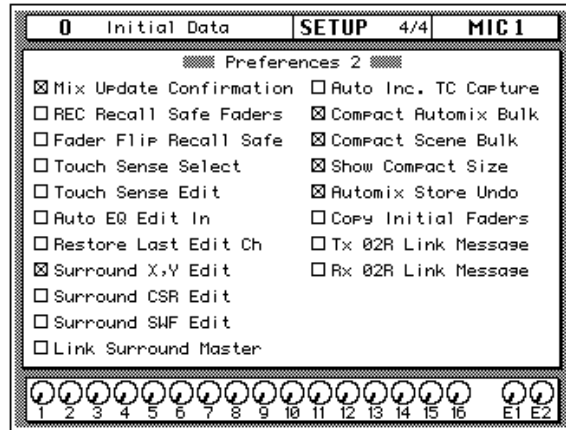

- **MIX Update Confirmation**—With this option checked, a confirmation dialog box appears after performing an automix edit asking whether or not you want to keep the new edit, thereby updating the automix.
- **REC Recall Safe Faders**—With this option checked, you can record fader movements even though the faders are set to Recall Safe.
- **Fader Flip Recall Safe**—With this option checked, the [FLIP] button is not affected when a mix scene is recalled.
- **Touch Sense Select**—With this option checked, adjusting a fader or rotary encoder displays the corresponding page, or selects the channel, allowing for quick operation.
- **Touch Sense Edit**—With this option checked and the FADER Overwrite option on the AUTOMIX 1/7 page checked, simply moving a fader during automix recording automatically selects that fader for recording. You may find this more convenient than using the [SEL] buttons to select faders. Be careful, however, because if an Overwrite parameter other than FADER is selected, because data recorded before the edit start point will be deleted.
- **Auto EQ Edit In**—With this option checked, adjusting the EQ affects only the selected band. For example, adjusting the HIGH EQ does not affect the LOW EQ.
- **Restore Last Edit Ch**—With this option checked, the channel edited last is automatically selected for subsequent edits. In Rec Ready mode, the last channel edited is selected for subsequent edits. In Auto Rec mode, selecting one of the last channels edited automatically selects all the channels that were edited last for subsequent edits.
- **Surround X, Y Edit**—With this option checked, surround pan X and Y movements can be recorded in an automix. The Extract, Copy, and Move functions on the AUTOMIX 4/7 page only affect the X and Y data when this box is checked.
- **Surround CSR Edit**—With this option checked, surround pan CSR movements can be recorded in an automix. The Extract, Copy, and Move functions on the AUTOMIX 4/7 page only affect the CSR data when this box is checked.

- **Surround SWF Edit**—With this option checked, surround pan SWF (subwoofer level) movements can be recorded in an automix. The Extract, Copy, and Move functions on the AUTOMIX 4/7 page only affect the SWF data when this box is checked.
- **Link Surround Master**—With this option checked, the surround master level can be controlled using the STEREO fader.
- **Auto Inc. TC Capture**—With this option checked, the timecode capture memory is incremented automatically as timecode addresses are captured.
- **Compact Automix Bulk**—With this option checked, automix data is compressed before Bulk Dump transmission, so it uses less memory on the storage device. Data is automatically uncompressed when it's dumped back to the 02R. Do not use this function when transmitting automix data to a Version 1 02R.
- **Compact Scene Bulk**—With this option checked, mix scene data is compressed before Bulk Dump transmission, so it uses less memory on the storage device. Data is automatically uncompressed when it's dumped back to the 02R. Do not use this function when transmitting mix scene data to a Version 1 02R.
- **Show Compact Size**—With this option checked, when a compressed automix is in memory, the amount of free memory is displayed on the AUTOMIX 1/7 page.
- **Automix Store Undo**—With this option checked, automix store and recall operations carried out on the Automix 2/7 page can be undone using the UNDO icon.
- **Copy Initial Faders**—With this option checked, a new fader event is inserted when a fader event is copied or moved. This new fader event is inserted at the specified Copy To time, and takes the fader position at the specified In Time. This option prevents fader position matching problems that occur when there is no fader event at the In Time. You can specify the time between the Copy To and the new event using the RET parameter.
- **Tx 02R Link Message**—With this option checked, the 02R can control several other 02Rs via MIDI. This would typically be set on the 02R master in a cascade system. See "MIDI Link" on page 232.
- **Rx 02R Link Message**—With this option checked, the 02R receives Link Messages from the master 02R. This would typically be set on the 02R slave in a cascade system. See "MIDI Link" on page 232.

Preferences 2—Factory Settings

Option / Setting		Option / Setting	
MIX Update Confirmation	OFF	Surround SWF Edit	OFF
REC Recall Safe Faders	OFF	Link Surround Master	OFF
Fader Flip Recall Safe	OFF	Auto Inc. TC Capture	OFF
Touch Sense Select	OFF	Compact Automix Bulk	OFF
Touch Sense Edit	OFF	Compact Scene Bulk	OFF
Auto EQ Edit In	OFF	Show Compact Size	OFF
Restore Last Edit Ch	OFF	Copy Initial Faders	OFF
Surround X, Y Edit	ON	Tx 02R Link Message	OFF
Surround CSR Edit	OFF	Rx 02R Link Message	OFF

Aux Output Select

1. Use the **(SETUP)** button to locate the **SETUP 2/4** page.



2. Use the **CURSOR** buttons to select the **AUX** and **BUS** icons, and the **(ENTER)** button to set them.

Using the Aux Output Select function, bus outputs can be assigned to the analog aux send outputs, providing analog bus outputs. Bus signals 1 to 6 can be assigned individually to aux send outputs 1 to 6.

Shown below is the SETUP 2/4 page—Aux Output Select.

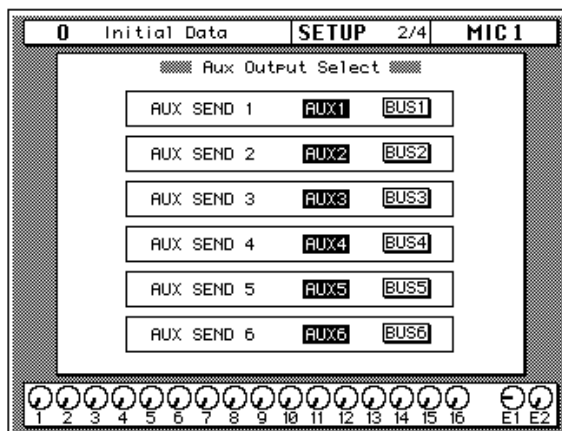

Initially, the aux buses are assigned to the analog aux outputs. A highlighted AUX or BUS icon indicates which bus is assigned to an output.

24-bit Recording

1. Use the **(SCENE MEMORY) button to locate the SCENE 5/5 page.**



2. Use the **CURSOR buttons to select the NORMAL MODE and 24bit MODE icons, and press the (ENTER) button to set them.**

Using two recorder tracks per channel, high-resolution digital audio can be recorded at the maximum wordlength of 24 bits. Recorder tracks 1 to 4 are used for the upper 16 bits, while tracks 5 to 8 are used for the lower 8 bits. In 24-bit Recording mode, a single slot can output up to four channels, which are selected on the DIGITAL I/O 5/5 page. See “Slot Output Select” on page 194. Slots 1 and 3 output bus signals 1 to 4, while slots 2 and 4 output bus signals 5 to 8. Aux, stereo, and direct out signals can also be recorded in 24-bit mode. Output signals are split in two and fed to two recorder tracks. For example, bus out 1 is split and fed to recorder track 1 (upper 16 bits) and track 5 (lower 8 bits). Bus out 2 feeds tracks 2 and 6. Bus out 3, tracks 3 and 7. And bus out 4, tracks 4 and 8.

For playback, track signals are automatically recombined and fed to the 02R channels as shown in the following table.

Slot	02R Channel	Notes
1	TAPE IN 1–4	TAPE INs 5–8 disabled
2	TAPE IN 9–12	TAPE INs 13–16 disabled
3	MIC IN 1–4	MIC INs 5–8 disabled
4	MIC IN 9–12	MIC INs 13–16 disabled

As the table shows, in 24-bit Recording mode four MIC or TAPE channels for each slot cannot be used. So if all four slots are used for 24-bit recording the maximum number of slot inputs is reduced from 32 to 16. The recording mode can be set individually for each slot, however, and settings are stored in scene memories.

The following I/O cards can be used with 24-bit Recording mode: ADAT (CD8-AT), Tascam (CD8-TDII), Yamaha (CD8-Y), AES Single (CD8-AE-S), and AES Double (CD8-AE). The following I/O cards can be used with 24-bit Recording mode: ADAT (CD8-AT), Tascam (CD8-TDII), Yamaha (CD8-Y), AES Single (CD8-AE-S), and AES Double (CD8-AE). The input and output configurations for analog I/O cards are not affected by the 24-bit Recording mode settings.

Shown below is the SCENE 5/5 page—24bit Recording Mode.

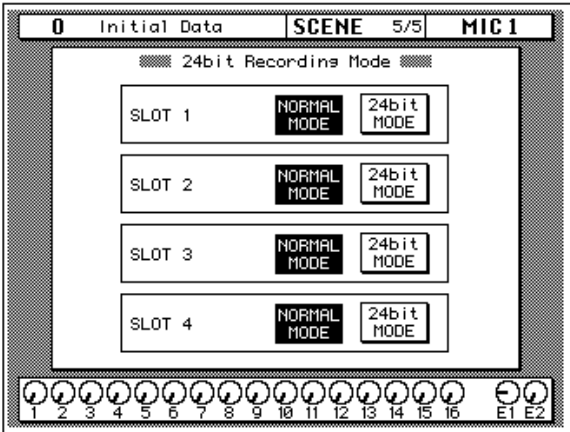

If you attempt to set 24bit MODE when the Input Patch for a slot is assigned one or more buses, the confirmation dialog box shown here appears. Choose EXECUTE to cancel the Input Patching and activate 24bit MODE.



Input Patching

1. Use the (SCENE MEMORY) button to locate the SCENE 4/5 page.



2. Use the CURSOR buttons to select an input icon, and the (ENTER) button to select that input channel group.

You can also use the (SEL) buttons to select input channel groups.

3. Use the CURSOR buttons to select a signal source, and the (ENTER) button to set it.

The Input Patching function allows you to select the signal sources for MIC/LINE channels 1 to 24 and TAPE channels 1 to 16. The same source can be selected for several channels. Bus outs can be patched through to the TAPE channels for bus out monitoring and subgrouping. To prevent a feedback loop, you cannot select bus outs to which a channel is routed, or route a channel to the bus selected as its signal source. In either case a warning message appears.

Shown below is the TAPE 1–8 page of SCENE 4/5. On this page you can select a card input from 1 to 8 or the corresponding bus out for TAPE channels 1 to 8.

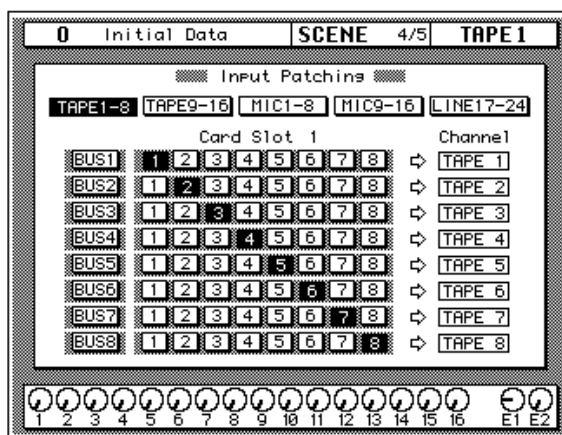

Shown below is the TAPE 9–16 page of SCENE 4/5. On this page you can select a card input from 9 to 16 or the corresponding bus out for TAPE channels 9 to 16.

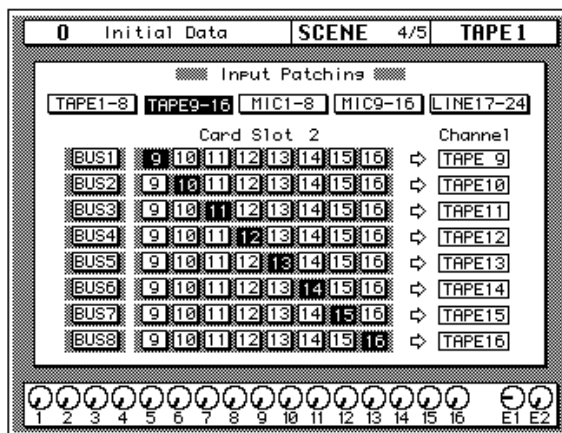

In 24bit MODE you cannot select individual buses. If you attempt to select a bus, the confirmation dialog box shown here appears. Choose EXECUTE to assign all buses to the card inputs.



Likewise, if a slot is configured for 24bit MODE, all buses are assigned to the card inputs, and you attempt to select a card input, the confirmation dialog box shown here appears. Choose EXECUTE to cancel all the bus assignments.



Shown below is the MIC 1-8 page of SCENE 4/5. On this page you can select internal or slot 3 inputs from 1 to 8. The Input Select parameters INT ANALOG and CARD SLOT 3 also appear on the DIGITAL I/O 2/5 (Input Signal Select) page.

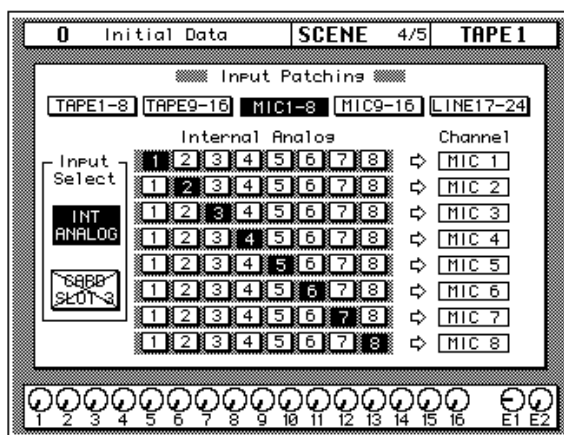

Shown below is the MIC 9-16 page of SCENE 4/5. On this page you can select internal or slot 4 inputs from 9 to 16. The Input Select parameters INT ANALOG and CARD SLOT 4 also appear on the DIGITAL I/O 2/5 (Input Signal Select) page.

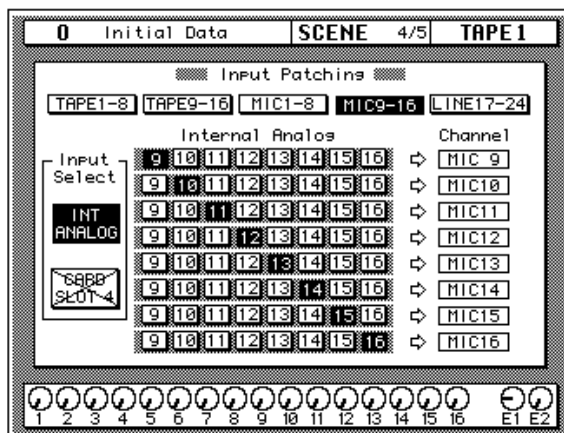

Input Patching settings are stored in scene memories.

Shown below is the LINE 17–24 page of SCENE 4/5. On this page you can select internal input (LINE), bus, or 2TR IN (17/18, 19/20 only). These parameters also appear on the DIGITAL I/O 2/5 (Input Signal Select) page.

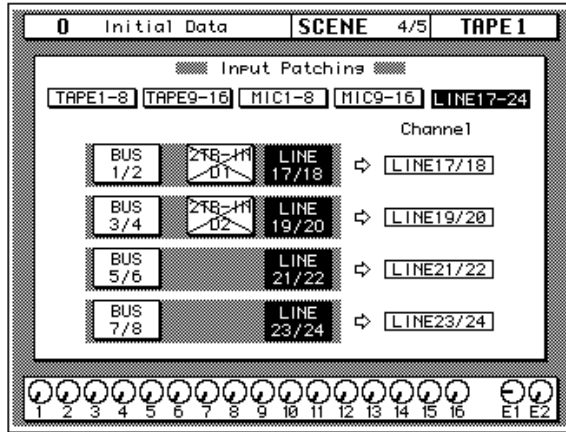

Oscillator

1. Use the (UTILITY) button to select the UTILITY 1/4 page.



2. Use the CURSOR buttons to select the ON or OFF icon and press the (ENTER) button.
3. Select the “Level” icon with the CURSOR buttons. Rotate the encoder wheel to set the oscillator output level.
4. Use the CURSOR buttons to select the “Wave Form” and press the (ENTER) button.
5. Select the output assignment icons with the CURSOR buttons and press the (ENTER) button for each output.

Before starting a recording session, many engineers like to record a few seconds of sine wave tones. These tones are used to compare the performance of multitrack recorders when you take the master tapes from one studio to another. This is especially important when the multitrack recorder is analog. The 02R has an oscillator function that allows you to send 100 Hz, 1 kHz, and 10 kHz sine waves and white noise to the auxiliary and output buses and the stereo bus.

Shown below is the UTILITY 1/4 page—Oscillator.

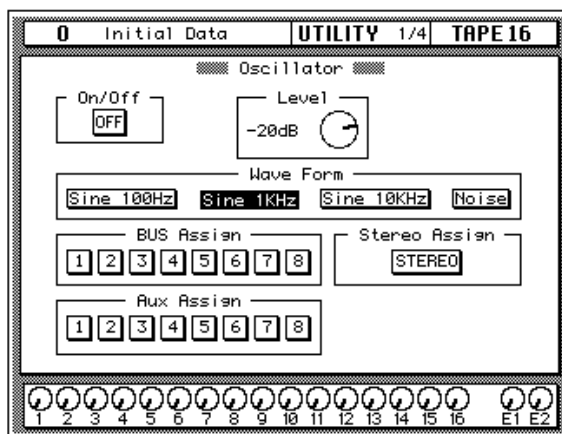

Oscillator Functions

- **ON/OFF**—This icon is used to turn the oscillator on or off. When the oscillator is on, the Control Room DIM (mute) function is automatically turned on.
- **Level**—This rotary icon allows you to set the oscillator output level. Set the level from -96 dB to 0 dB. Watch the level meters to ensure you are not driving the 02R into digital clipping.
- **Wave Form**—These icons allow you to select the wave form you want output. The 02R can generate four different wave forms: “Sine 100Hz”, “Sine 1kHz”, “Sine 10kHz”, and “Noise”.
- **BUS Assign**—Select the output buses 1 through 8.
- **Stereo Assign**—Select the stereo bus.
- **Aux Assign**—Select the auxiliary buses 1 through 8.

Emphasis Monitor

1. Use the (UTILITY) button to locate the UTILITY 2/4 page.



This function allows you to monitor the emphasis information of the digital inputs. If an input digital signal was recorded with emphasis—a technique used in early digital recordings to compensate for the deficiencies of the hardware of the period, similar to Dolby® or dbx® noise reduction for analog—the 02R can compensate by applying de-emphasis to the signal before further processing.

Note: When the 02R receives data that has been processed with emphasis ON, it will automatically process the data by applying de-emphasis. It will continue processing the signal internally and will subsequently output the data with emphasis OFF. Regardless of whether a signal has been received with emphasis ON, the 02R will always output the signal with emphasis OFF.

Shown below is the UTILITY 2/4 page—Emphasis Monitor.

0	Initial Data	UTILITY 2/4	EFF1	RTN
Emphasis Monitor				
SLOT 1 NoConnection	TAPE 1/2	3/4	5/6	7/8
SLOT 2 NoConnection	TAPE 9/10	11/12	13/14	15/16
SLOT 3 NoConnection	MIC 1/2	3/4	5/6	7/8
SLOT 4 NoConnection	MIC 9/10	11/12	13/14	15/16
2TR IN DIGITAL	2TR D1	2TR D2	2TR D3	
1	2	3	4	5
6	7	8	9	10
11	12	13	14	15
16	E1	E2		

This page allows you to monitor the emphasis information of the signal input from each digital input jack of optional slots 1-4 and 2TR DIGITAL IN 1-3 connectors. One of the following three icons will appear depending on the status of the input signal:



No signal or an invalid signal is being input.

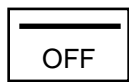

Valid digital audio signal is being input. De-emphasis is not required and is off for the signal.



Valid digital audio signal is being input. De-emphasis is required and is set to on for the signal.

Channel Status Monitor

1. Use the (UTILITY) button to locate the UTILITY 3/4 page.



2. Use the CURSOR buttons to select an input signal—"SLOT1", "SLOT2", "SLOT3", "SLOT4", or "2TR"—and press the (ENTER) button.

If applicable, the 02R will show the channel status information for the selected input.

This function shows the channel status information of digital audio signal. Channel status information is only present in IEC958 digital audio signals.

Shown below is the UTILITY 3/4 page—Channel Status Monitor.

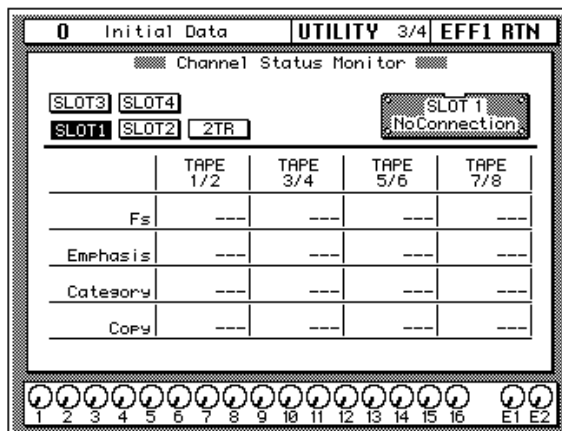

This page allows you to monitor the channel status information from a digital audio signal using the IEC958 Part3 (AES/EBU Professional) format or IEC958 Part2 (Consumer) format.

Select one of the [SLOT1], [SLOT2], [SLOT3], [SLOT4], and [2TR] icons in the upper part of the page to select the information you wish to monitor. If you select one of SLOTS 1–4 and any card other than the CD8-AE (AES/EBU card) is installed in the corresponding slot (or no card is installed), the page is grayed out and you cannot monitor the information.

The table in the center of the page shows the contents of the channel status of the selected signal.

Each indication has the following meaning:

- **Fs**—This is the sampling frequency information. One of "32k", "44.1k", "48k", "None" (unknown), and "(UNLOCK)" will appear.
"(UNLOCK)" means that no signal is being input or the input signal is invalid. In this case, the Emphasis, Category, and Copy columns will show "---".
- **Emphasis**—This shows the status of emphasis of the control bit. "ON", "OFF" or "???" (unknown) will be shown.
- **Category**—This shows the status of the "category bit" which is implemented only for the IEC958 Part2 (Consumer) format. The following items are included:
 - General**—Used temporarily.
 - Laser Optical**—Laser optical device
 - D/D Conv**—Digital-to-digital converter and signal processor

Magnetic—Magnetic tape device and magnetic disk device

D. Broadcast—Digital broadcast reception

Instruments—Musical instruments, microphones and the sources that generate the original signal

A/D Conv—A/D Converter (Without copyright information)

A/D Conv with (C)—A/D Converter (With copyright information)

Solid Memory—Solid memory device

Experimental—Experimental device

Unknown—Unknown

Note: *If you monitor a signal in the IEC958 Part3 (AES/EBU Professional) format (which does not have a category code bit), the Category column will show "AES/EBU".*

- **Copy**—This shows the status of "C bit" (Copyright information) that has been implemented in only the IEC958 Part 2 (Consumer) format. The following items will be shown:

Ok—Copy allowed.

Prohibit—Copy prohibited.

Note: *If you monitor a signal in the IEC958 Part3 (AES/EBU Professional) format (which does not have a "C" bit), the Copy column will show "---".*

Battery Check

1. Use the (UTILITY) button to locate the UTILITY 4/4 page.



This function allows you to check the status of the 02R's backup battery.

Shown below is the UTILITY 4/4 page—Battery Check.

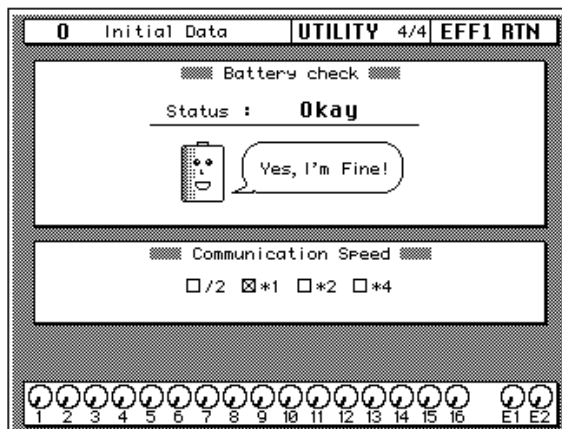

If there is enough battery capacity, the battery says "Yes, I'm fine!"

If the battery needs to be changed, it says, "I'm exhausted... Replace me immediately.", as shown below.

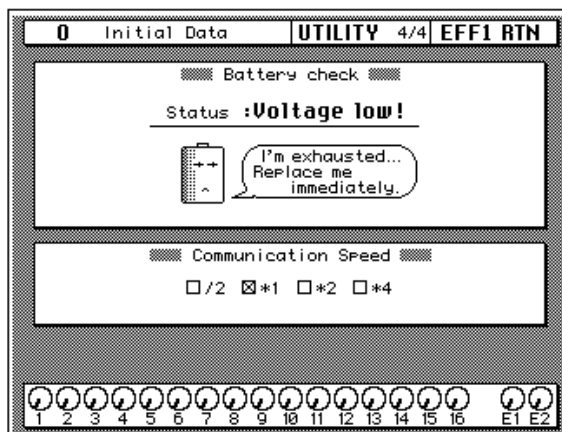

Note: If this message appears, your important data in memory, such as scene memories, automix memories, and libraries, may be lost. Ask your nearest Yamaha dealer or Yamaha Service Center to replace the battery as soon as possible.

Communication Speed

1. Use the (UTILITY) button to locate the UTILITY 4/4 page.



The Communications Speed section of the UTILITY 4/4 page allows you to monitor the TO HOST port speed, and is for use with computer software such as Project Manager or Visualizer. The controlling host computer automatically configures the communication speed, so you don't have to worry about these settings. Once communications between the 02R and host computer have been established, you can change the communication speed on the computer only, and the check boxes on the UTILITY 4/4 page are grayed out.

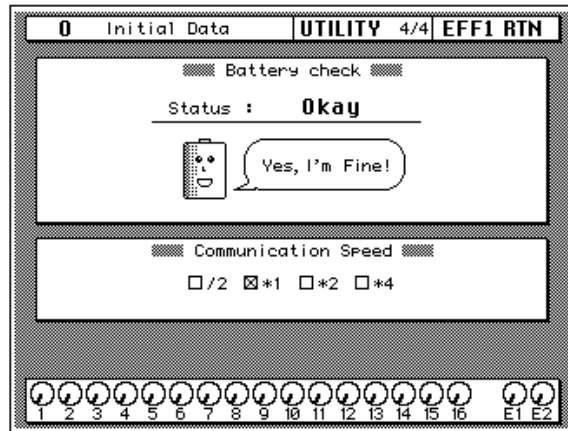

The *1 speed is the default at 38.4 kbps.

02R System Initialization

1. Turn off the 02R.
2. Press and hold the left CURSOR button.

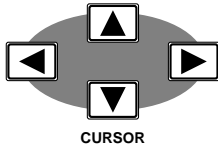

3. Turn the 02R back on.
A confirmation dialog box appears.
4. Select the EXECUTE icon by with the CURSOR buttons and press the (ENTER) button.

The 02R initializes itself. When it has completed the initialization operation, the SCENE 1/1 page appears.

This operation allows you to reset the 02R to its initial settings. This operation deletes all scene memories, automix programs, and clears all user library programs from the channel, dynamics, effect, and EQ libraries.

Note: If you just want to reset the current mix settings, recall Scene Memory 0. See “Initial Data and UNDO Memory” on page 129 of the User’s Guide.

Initialization consists of:

- Clearing all user RAM settings: all scene memories (except Scene Memory 0), automix programs, and user library programs from the channel, dynamics, effect, and EQ libraries.
- Initializing the Edit Buffer. See “What is the Edit Buffer?” on page 129 of the User’s Guide.
- Initializing the Program Change table (list of scene memories to MIDI Program Change numbers). See “Program Change Assign” on page 160 of the User’s Guide.
- Coping Scene Memory 0 to the Edit Buffer.
- Initializing the input and output ports.
- Calibrating the faders.

Note: Avoid blocking the fader movements by placing objects on the 02R while the faders are calibrating themselves. It is possible to damage the faders.

- Refreshing the display.

The SCENE 1/1 page appears.

Fader Calibration

This operation allows you to calibrate the faders.

1. Turn off the 02R.
2. Press and hold the (ENTER) button, then turn the 02R back on.

The faders are calibrated.

Note: Avoid blocking the fader movements by placing objects on the 02R while the faders are being calibrated. It is possible to damage the faders.

14

Installing Options

In this chapter...

02R Options	218
Installing 02R Options	221
Analog I/O Card—AD/DA (CD8-AD)	224
Analog I/O Card—A/D (CD8-AD-S)	224
Digital I/O Card—AES/EBU (CD8-AE/CD8-AE-S).....	225
Digital I/O Card—ADAT (CD8-AT).....	227
Digital Cascade Kit (CD8-CS)	229
Digital I/O Card—TDIF-1 (CD8-TDII).....	234
Peak Meter Bridge (MB02)	236

02R Options

There are a number of options you can add to your 02R. Some of these options add to the convenience and appearance of the 02R, such as the peak meter bridge (MB02) or the wooden side panels (W02SP). There is also a memory expansion kit (ME4M) which allows you to add up to 2 MB of additional memory for the automix system.

The most important options are the I/O cards.

These cards support direct digital interconnection to the latest generation of modular digital multitrack recorders. Alesis ADAT, TASCAM TDIF-1, YAMAHA, and AES/EBU cards are available.

In addition, you can insert a Digital Cascade card into one of the I/O slots, allowing you to cascade multiple 02Rs together to create a larger digital mixing system.

Analog cards are also available for connecting analog multitrack recorders and providing more analog inputs.

02R Options

Type	Product	Format
Analog I/O Card	CD8-AD	AD/DA
	CD8-AD-S	A/D
Digital I/O Card	CD8-AE	AES/EBU
	CD8-AE-S	AES/EBU
	CD8-AT	ADAT
	CD8-TDII	TDIF-1
	CD8-Y	YAMAHA
Digital Cascade Kit	CD8-CS	
Peak Meter Bridge	MB02	
Memory Expansion Kit	ME4M	
Wooden Side Panels	W02SP	

I/O Cards

The I/O cards transmit and receive signals between your 02R and external devices, such as modular digital multitrack recorders, hard disk recorders, analog multitrack recorders, or other 02Rs. The cards come in two sizes: single slot and double slot:

- Single slot I/O cards can be installed in any slot from 1 to 4.
- Double slot I/O cards can only be installed in slots 1 or 2.

The I/O cards fall into three groups:

- **Digital I/O Cards**—These cards provide 8 tracks of digital input and output. They are used to connect the 02R to a digital multitrack recorder—either tape or disk based. Cards supporting ADAT, TDIF-1, YAMAHA, and AES/EBU formats are available. Except for the CD8-AE card, these cards are single slot, allowing you to insert up to four cards giving you a maximum 32 tracks of digital mixdown.
- **Analog I/O Cards**—These cards provide 8 tracks of analog input and output. The CD8-AD can be used to connect the 02R to an analog multitrack recorder or to increase the number of analog inputs and outputs. The CD8-AD-S offers 8 analog phone jack inputs on a single slot card. Conversion is performed in 20-bit linear. The sampling frequency is the same as the current wordclock master on the 02R.
- **Cascade I/O Card**—This card allows you to connect the bus lines 1 through 8, two pairs of the auxiliary buses 1 through 8 to the cascade card's AUX A and AUX B buses, the STEREO bus, and the SOLO bus of two or more 02R's. One 02R is the cascade master, the others are slaves.

The following table lists the I/O cards available:

Card	Format	Product	Size & Location
Digital I/O	AES/EBU	CD8-AE	double slots 1 or 2 (max 2 cards, 16 ch)
		CD8-AE-S	single, slots 1–4 (max 4 cards, 32 ch)
	ADAT	CD8-AT	single slots 1–4 (max 4 cards, 32 ch)
	TDIF-1	CD8-TDII	single slots 1–4 (max 4 cards, 32 ch)
	YAMAHA	CD8-Y	single slots 1–4 (max 4 cards, 32 ch)
Analog I/O	AD/DA	CD8-AD	double slots 1 or 2 (max 2 cards, 16 ch)
	A/D	CD8-AD-S	single slots 1–4 (max 4 cards, 32 ch)
Cascade Kit		CD8-CS	single slots 1–4 (normally 3 or 4) kit incl. 2 cards & cable.

Peak Meter Bridge

The Peak Meter Bridge (MB02) displays the levels for all the input, output, and bus channels of the 02R, plus it duplicates the stereo output signal meters. The meter bridge displays the information shown on the METER pages in a much more convenient form.

Memory Expansion Kit

The memory expansion kit (ME4M) expands the 02R automix system memory from the standard 512K to either 1.5 MB or 2.5 MB.

Note: *Take the 02R to your YAMAHA dealer or authorized service center for installation of the ME4M kit. Doing the installation yourself invalidates the warranty.*

Wooden Side Panels

These Wooden Side Panels (W02SP) attach to either side of the 02R to give it an attractive appearance.

Installing 02R Options

Single Slot Cards

1. Turn off the 02R.

TO PREVENT ELECTRICAL SHOCK, ENSURE THE 02R IS TURNED OFF BEFORE YOU OPEN ANY OF THE SLOT COVERS!

Note: Before you install a card in the 02R, be certain to turn the power off. Not only do you risk electrical shock, you can also damage either the 02R or the optional card. You will also invalidate any warranties for the 02R or the optional cards.

2. Remove the cover plate from the slot in which you intend to insert the optional card.

Note: You should save the cover plates for possible later use. You should also never operate the 02R with one of the slots uncovered. This disrupts the flow of air through the power supply and other components and can cause premature failure of internal components.

3. Insert the optional card as shown below.

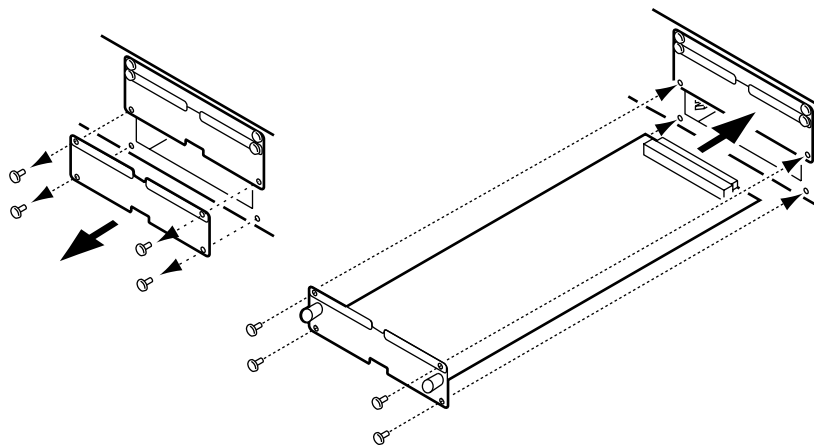

When you insert the card, press it firmly into the slot to make certain the connector on the card edge seats firmly on the bus slot inside the 02R. Make sure the card is properly secured with the screws that held the cover plate in place.

4. Turn on the 02R.

Verify that the card has been recognized by the system software on the DIGITAL I/O 1/5 page (see “Word Clock Select” on page 188 of the *User’s Guide*). If the card was installed properly, the 02R should correctly identify it in the appropriate slot.

Double Slot Cards

1. Turn off the 02R.

TO PREVENT ELECTRICAL SHOCK, ENSURE THE 02R IS TURNED OFF BEFORE YOU OPEN ANY OF THE SLOT COVERS!

Note: Before you install a card in the 02R, be certain to turn the power off. Not only do you risk electrical shock, you can also damage either the 02R or the optional card. You will also invalidate any warranties for the 02R or the optional cards.

2. Remove the cover plate from the slot in which you intend to insert the optional card as well as the slot over top

The double slot cards can only be installed in SLOT1 and/or SLOT2.

Note: You should save the cover plates for possible later use. You should also never operate the 02R with one of the slots uncovered. This disrupts the flow of air through the power supply and other components and can cause premature failure of internal components.

3. Insert the optional card as shown below.

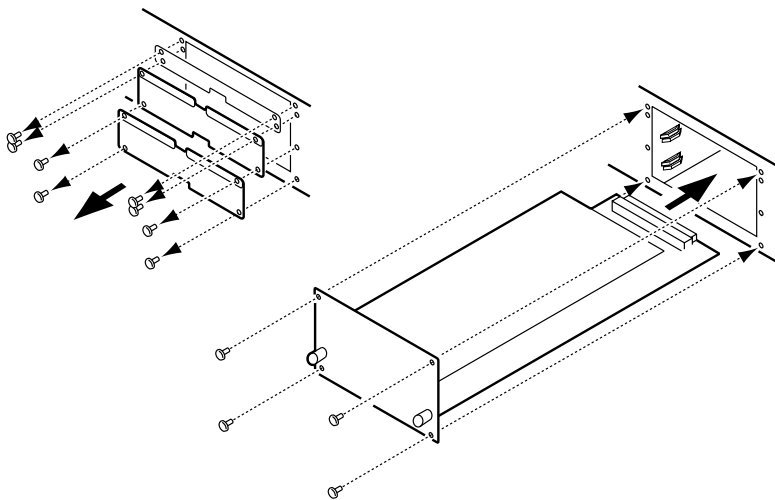

When you insert the card, press it firmly into the slot to make certain the connector on the card edge seats firmly on the bus slot inside the 02R. Make sure the card is properly secured with the screws that held the cover plate in place.

4. Turn on the 02R.

Verify that the card has been recognized by the 02R on the DIGITAL I/O 1/5 page (see "Word Clock Select" on page 188 of the *User's Guide*). If the card was installed properly, the 02R should correctly identify it in the appropriate slot.

Peak Meter Bridge and Wooden Side Panels

1. Turn off the 02R.

TO PREVENT ELECTRICAL SHOCK, ENSURE THE 02R IS TURNED OFF BEFORE YOU FASTEN ANY CONNECTORS OR UNDO ANY SCREWS!

Note: Before you install the MB02 on the 02R, be certain to turn the power off. Not only do you risk electrical shock, you can also damage either the 02R or the MB02. You may also invalidate any warranties for the 02R or the Peak Meter Bridge (MB02).

2. Install the Peak Meter Bridge and/or Wooden Side Panels as shown in the following diagram:

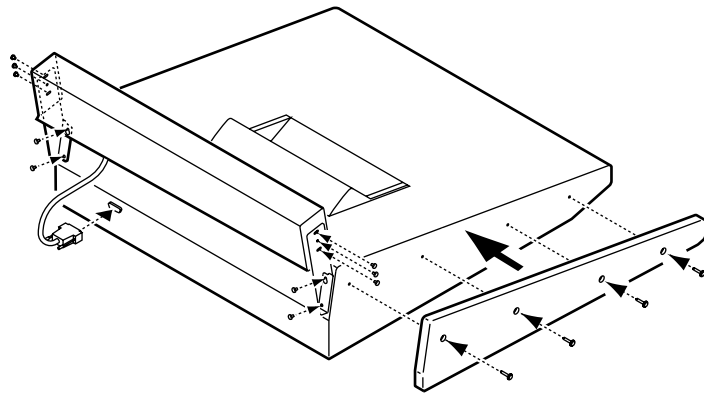

3. Turn on the 02R.

Verify that the MB02 is functioning correctly.

Memory Expansion Kit

The Memory Expansion Kit (ME4M) is a dealer/service center installed option only. Any attempt by a customer to install this option will invalidate any warranties for the 02R or the ME4M.

Please take your 02R to your YAMAHA dealer or a YAMAHA service center to have the Memory Expansion Kit (ME4M) installed in the 02R.

Analog I/O Card—AD/DA (CD8-AD)

The CD8-AD is used to connect an analog multitrack recorder or other analog devices to the 02R.

Installing the CD8-AD

The CD8-AD is a double slot card. For installation instructions, see “Double Slot Cards” on page 222 of the *User’s Guide*. Before you install the CD8-AD, you need to set the individual input and output level switches. Set the switches to -10 dBv or $+4$ dB as appropriate. Refer to the instructions included with the CD8-AD for more information.

Setup of the CD8-AD

1. **Use the (DIGITAL I/O) button to locate the DIGITAL I/O 1/5 page.**

If the card was installed properly, the 02R will identify it in the appropriate slot.

2. **Make the required connections between the 02R and your analog devices.**

You should use the highest quality connecting cables you can afford to maintain the best possible signal quality.

Analog I/O Card—A/D (CD8-AD-S)

The CD8-AD-S card offers eight analog phone jack inputs.

Installing the CD8-AD-S

The CD8-AD-S is a single slot card. For installation instructions, see “Single Slot Cards” on page 221 of the *User’s Guide*. Before you install the CD8-AD-S, you need to set the input and output level switches. Set the switches to -10 dBv or $+4$ dB as appropriate. Refer to the instructions included with the CD8-AD-S for more information.

Setup of the CD8-AD-S

1. **Use the (DIGITAL I/O) button to locate the DIGITAL I/O 1/5 page.**

If the card was installed properly, the 02R will identify it in the appropriate slot.

2. **Make the required connections between the 02R and your analog devices.**

You should use the highest quality connecting cables you can afford to maintain the best possible signal quality.

Digital I/O Card—AES/EBU (CD8-AE/CD8-AE-S)

The AES/EBU digital I/O cards (CD8-AE/CD8-AE-S) are used to connect AES/EBU compatible multitrack digital recorders or other similar digital devices to the 02R.

Installing the CD8-AE/CD8-AE-S

The CD8-AE card is a double slot card (see “Double Slot Cards” on page 222). The CD8-AE-S card is a single slot card (see “Single Slot Cards” on page 221).

1. **Connect the AES/EBU compatible multitrack digital recorder to the 02R using the appropriate connectors.**

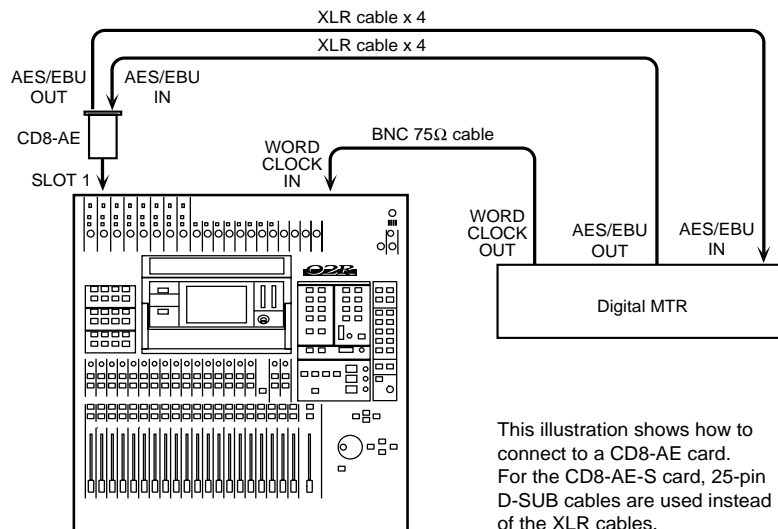

Use high quality 110Ω digital connecting cables to connect to the CD8-AE card. Use 25-pin D-SUB cables that are suitable for digital audio use to connect to the CD8-AE-S card.

2. **If your AES/EBU compatible multitrack digital recorder has a dedicated wordclock output connector, connect it to the WORD CLOCK—IN connector on the back of the 02R and turn the 75Ω terminator switch on.**

If there is no dedicated wordclock output, you can obtain the wordclock signal required from one of the digital interconnect lines.

Note: *A dedicated wordclock connection will give you the best wordclock synchronization results.*

Wordclock Selection

1. Turn on your AES/EBU compatible multitrack digital recorder and then the 02R.

It is always important to observe the correct order for turning on equipment in a studio. Start with the AES/EBU compatible multitrack and mastering recorders and the signal processors, then the 02R, and finally the monitoring amplifiers and other downstream gear.

2. Use the (DIGITAL I/O) button to locate the DIGITAL I/O 1/5 page.

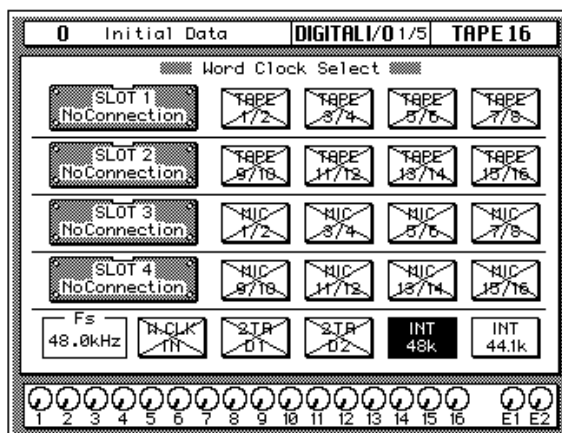

If the card was installed properly, the 02R will identify it in the appropriate slot.

3. Use the CURSOR buttons to select the wordclock source.

If your AES/EBU compatible multitrack digital recorder has a dedicated wordclock output connector, use the CURSOR buttons to select the W.CLK IN box and press the [ENTER] button. If the multitrack digital recorder does not have a dedicated wordclock output, select the TAPE 1/2 box—the first box in the SLOT1 row—and press the [ENTER] button.

The current wordclock source is indicated by a highlighted icon. See “Word Clock Select” on page 188 of the *User’s Guide* for further details.

Digital I/O Card—ADAT (CD8-AT)

The ADAT digital I/O card (CD8-AT) is used to connect Alesis ADAT compatible modular digital multitrack recorders to the 02R.

Installing the CD8-AT

The ADAT digital I/O card (CD8-AT) is a single slot card. For installation instructions, see “Single Slot Cards” on page 221 of the *User’s Guide*.

1. Connect the ADAT modular digital multitrack recorder to the 02R using the appropriate connectors.

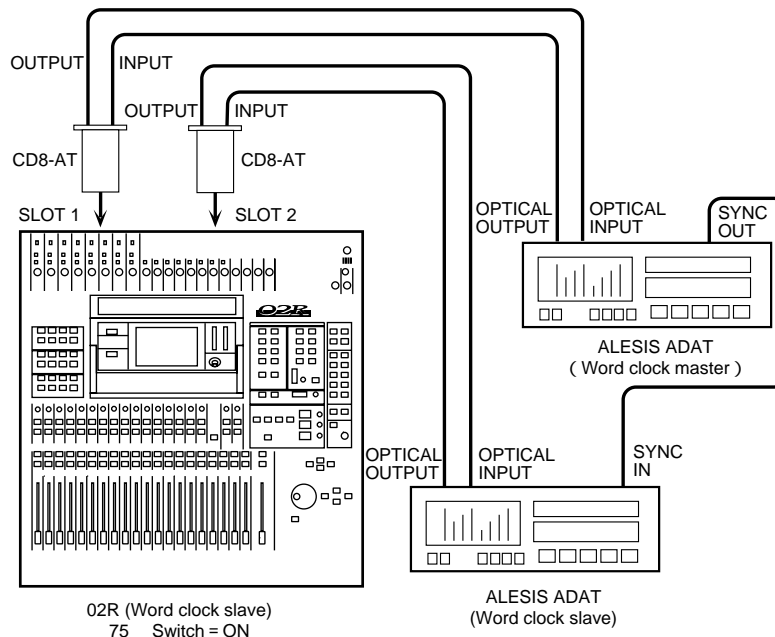

Use the special ADAT optical cables to plug the IN connector of the CD8-AT to the OPTICAL OUT connector of the ADAT modular digital multitrack recorder. Plug the OUT connector of the CD8-AT to the OPTICAL IN connector of the ADAT recorder.

If you have installed more than one CD8-AT in the 02R and have more than one ADAT recorder, connect it in the same manner as the first unit.

The Alesis ADAT modular digital multitrack recorder does not have a dedicated wordclock output connector. If you are using the BRC ADAT remote controller, you can use the 48kHz OUT connector and an appropriate cable to plug it into the WORD CLOCK—IN connector on the back of the 02R and turn the 75Ω terminator switch on.

If there is no dedicated wordclock output, you can obtain the wordclock signal required from the digital interconnect line.

Note: A dedicated wordclock line will give you the best wordclock synchronization results.

Wordclock Selection

1. **Power on your ADAT modular digital multitrack recorder and then the 02R.**

It is always important to observe the correct order for powering up equipment in a studio. Start with the ADAT and mastering recorders and the signal processors, then the 02R, and finally the monitoring amplifiers and other downstream gear.

2. **Use the (DIGITAL I/O) button to locate the DIGITAL I/O 1/5 page.**

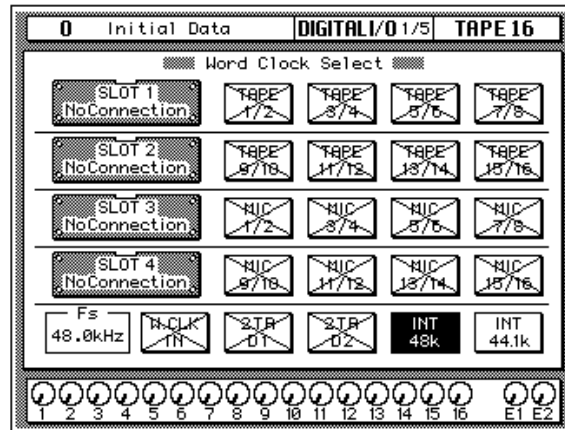

If the card was installed properly, the 02R will identify it in the appropriate slot. The ADAT digital I/O card (CD8-AT) can be installed in any slot. You should install the first two cards in SLOT1 and SLOT2 in order to access the direct out lines.

Note: *If the W.CLK IN box or the TAPE1/2 box is not showing a proper wordclock input (no discrepancy between the input and selected wordclock frequencies), check the connections between the ADAT modular digital multitrack recorder and the 02R. Check that the ADAT recorder is powered on.*

3. **Use the CURSOR buttons to select the wordclock source.**

If you are using the 48kHz OUT connector from the BRC ADAT remote controller plugged into the WORD CLOCK—IN connector, use the CURSOR buttons to select the W.CLK IN box and press the [ENTER] button. If you are just using an ADAT modular digital multitrack recorder, select the TAPE 1/2 box—the first box in the SLOT1 row—and press the [ENTER] button.

The current wordclock source is indicated by a highlighted icon. See “Word Clock Select” on page 188 of the *User’s Guide* for further details.

Digital Cascade Kit (CD8-CS)

The digital cascade kit (CD8-CS) is used to connect two or more 02Rs together. The kit consists of two cascade I/O cards and a special cable. When two or more 02Rs are connected together, they share the output buses 1 through 8, four auxiliary buses (two paired buses, AUX A and AUX B), the stereo bus, and the solo bus.

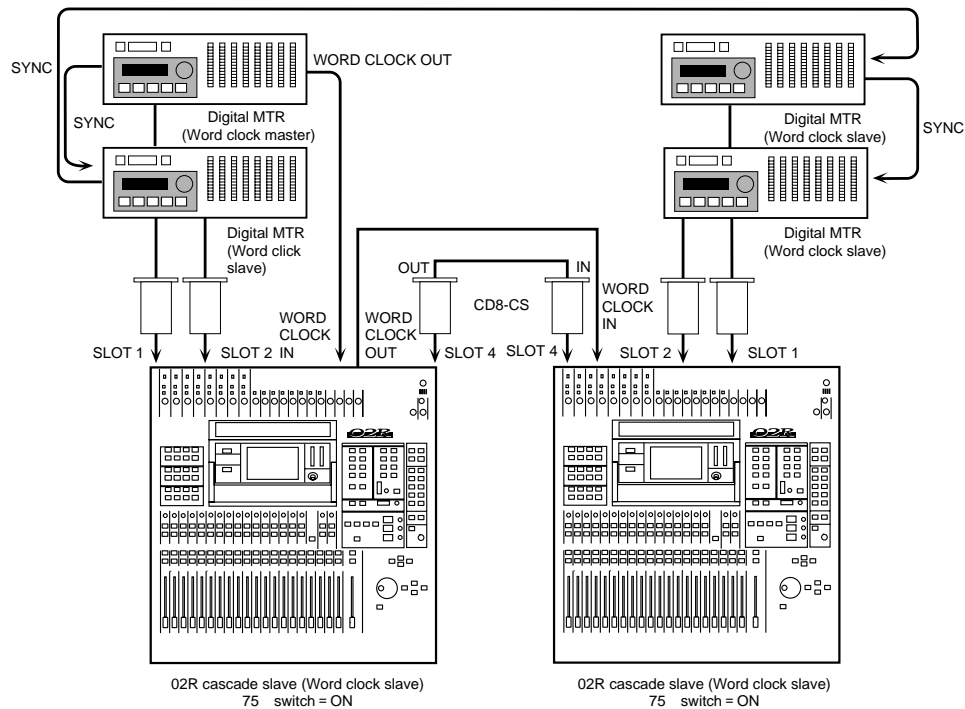

Installing the CD8-CS

The cascade I/O card (CD8-CS) is a single slot card. At least one cascade I/O card should be installed in each 02R. If you are connecting more than two 02Rs, the middle units should have two cards. The cascade I/O cards should be installed in SLOT3 or SLOT4. You should reserve SLOT1 and SLOT2 for digital I/O cards.

For installation instructions, see "Single Slot Cards" on page 221 of the *User's Guide*.

1. Set the IN/OUT switch of the cascade I/O card installed in the first 02R to the IN position.

This 02R will be the cascade master.

2. Set the IN/OUT switch of the cascade I/O card installed in the second 02R to the OUT position.

This 02R will be the cascade slave.

3. Use a BNC cable to plug the WORD CLOCK—OUT connector on the back of the first 02R into the WORD CLOCK—IN connector on the second 02R.

The 02R that is the cascade master should be receiving a wordclock signal from a wordclock master device, such as a modular digital multitrack recorder or other appropriate device.

Wordclock Selection

1. Power on your modular digital multitrack recorder and then the 02R units in order, starting with the cascade master.

It is always important to observe the correct order for powering up equipment in a studio. Start with the multitrack and mastering recorders and the signal processors, then the 02R, and finally the monitoring amplifiers and other downstream gear.

2. Use the (DIGITAL I/O) button to locate the DIGITAL I/O 1/5 page.

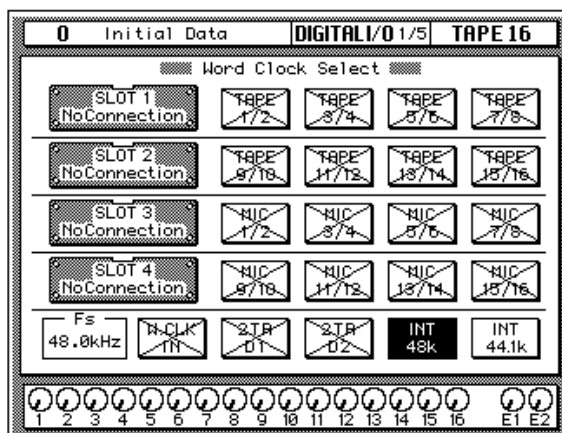

If the cascade I/O card was installed properly, the 02R will identify it in the appropriate slot.

3. Use the CURSOR buttons to select the wordclock source.

Select the W.CLK IN box and press the [ENTER] button.

Note: If the W.CLK IN box is not showing a proper wordclock input (no discrepancy between the input and selected wordclock frequencies), check the connections between the 02R units.

4. On the 02R cascade master, use the (DIGITAL I/O) button to locate the DIGITAL I/O 1/5 page.

If the cascade I/O card was installed properly, the 02R will identify it in the appropriate slot. A digital I/O card should be installed in SLOT1 or SLOT2 in order to access the direct out lines.

5. Use the CURSOR buttons to select the wordclock source.

If your multitrack digital recorder has a dedicated wordclock output connector, use the CURSOR buttons to select the W.CLK IN box and press the [ENTER] button. Otherwise, select a box from the appropriate I/O slot row and press the [ENTER] button.

The current wordclock source is indicated by a highlighted icon. See “Word Clock Select” on page 188 of the *User’s Guide* for further details.

Cascade Settings

1. **On the 02R cascade master, use the (DIGITAL I/O) button to locate the DIGITAL I/O 3/5 page.**
2. **Select the “ID” parameter with the CURSOR buttons and rotate the encoder wheel until the appropriate value is set.**

The cascade master should have the highest ID number in the system. If you have four 02Rs cascaded together, the cascade master should be set to ID=3.

Note: *If you connect more than four 02R units together, you will have to adjust the delay to compensate for signal processing time. See “Delay and Cascade” on page 34 of the User’s Guide.*

3. **On the 02R cascade slave, use the (DIGITAL I/O) button to locate the DIGITAL I/O 3/5 page.**

If the cascade slave and cascade master units are powered on and connected correctly, the ID number for the cascade slave is set to the appropriate value automatically.

4. **Use the CURSOR buttons to select the “Cascade Aux Bus Assign” parameter.**

Use the CURSOR buttons to select two pairs of auxiliary buses from the cascade slave to send to the cascade master AUX A and AUX B buses.

Note: *It is not possible to send the same pair of auxiliary buses from the cascade slave to both AUX A and AUX B on the cascade master.*

See “Cascade Configuration” on page 191 of the *User’s Guide* for further details.

MIDI Link

When several 02Rs are cascaded together, the master 02R can control a number of functions, listed below, of the slave 02Rs via MIDI. Master and slave 02Rs should be connected as shown below.

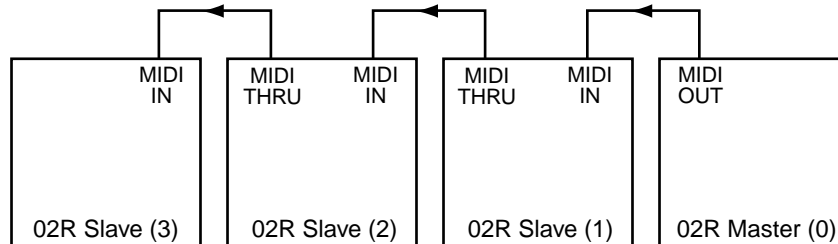

On the master 02R, the Tx 02R Link Message preference should be turned on. On the slave 02Rs, the Rx 02R Link Message preference should be turned on. See “Preferences” on page 198. MIDI messages are processed regardless of the MIDI Channel settings.

Linked Commands

- Scene memory recall and store (including title)
- Automix memory recall and store (including title)
- Automix New and Undo
- Automix transport functions (Auto Rec, Record, Play, Stop, Abort)

Linked Parameters

- Meter input module patch point
- Meter output module patch point
- Meter Peak Hold
- Automix Enable
- Automix fader Return (Edit Out)
- Automix fader Return Time (Edit Out)
- Automix Overwrite
- Automix Relative
- Automix Motor
- Automix Frame
- Automix MTC
- Automix generator start time Hour, minute, second, frame
- Automix timecode offset

Solo function

When two or more 02R units are cascaded together, only the [SOLO] button on the cascade master continues to function. When you press the [SOLO] button on the cascade master, however, you can solo individual channels on the cascade slaves.

1. **On the 02R cascade master, use the (SETUP) button to locate the SETUP 1/4 page.**
2. **Select the “Mode” field with the CURSOR buttons to set the solo function status.**

You can only set this status on the cascade master.

See “Solo” on page 196 of the *User’s Guide* for further details.

3. **On the 02R cascade master, press the (SOLO) button.**

The LEDs inset in the [ON] buttons of all the cascaded 02R units will flash.

4. **Press the (ON) button of the channel (or channels) that you want to solo.**

In Recording mode, the channel signal is sent to the Solo bus on the cascade master, and you can monitor the signal using the monitor system connected to the cascade master. In Mixdown mode, the channel signal is sent to the Stereo bus.

Digital I/O Card—TDIF-1 (CD8-TDII)

The TDIF-1 digital I/O card (CD8-TDII) is used to connect TASCAM TDIF-1 modular digital multitrack recorders such as the DA-88 to the 02R.

Installing the CD8-TDII

The TDIF-1 digital I/O card (CD8-TDII) is a single slot card. For installation instructions, see “Single Slot Cards” on page 221 of the *User’s Guide*.

1. Connect the TASCAM DA-88 modular digital multitrack recorder to the 02R using the appropriate connectors.

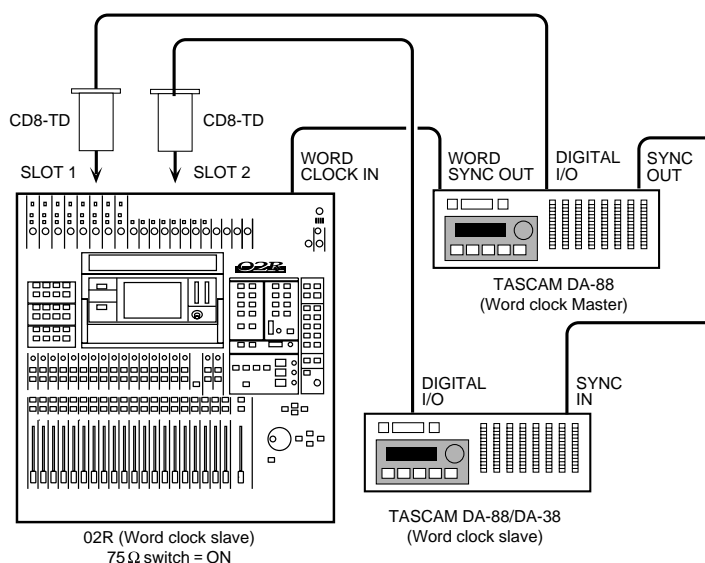

Use the special cable to plug the connector of the CD8-AT to the DIGITAL I/O connector of the TASCAM DA-88 recorder.

If you have installed more than one CD8-TDII in the 02R and have more than one TASCAM DA-88 recorder, connect it in the same manner as the first unit.

The TASCAM DA-88 recorder is equipped with a WORD SYNC OUT connector. Use a BNC cable to plug it into the WORD CLOCK—IN connector on the back of the 02R.

If you are using more than one TASCAM DA-88 recorder, make the first unit the wordclock master. There are SYNC IN/SYNC OUT connectors on the DA-88 recorders that allow them to run together. DA-38s can not be used as wordclock master, because they do not have a SYNC OUT connector.

Wordclock Selection

1. Power on your DA-88 modular digital multitrack recorder and then the 02R.

It is always important to observe the correct order for powering up equipment in a studio. Start with the DA-88 and mastering recorders and the signal processors, then the 02R, and finally the monitoring amplifiers and other downstream gear.

2. Use the (DIGITAL I/O) button to locate the DIGITAL I/O 1/5 page.

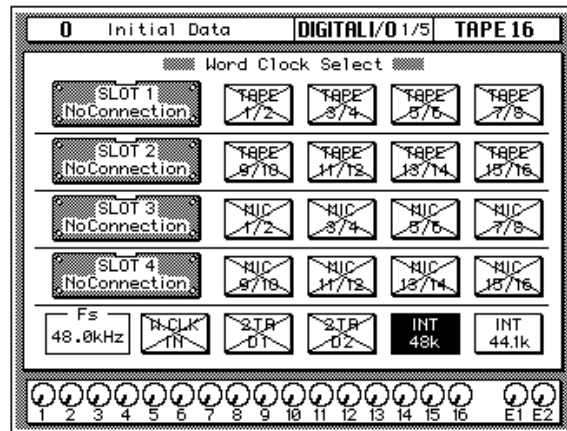

If the card was installed properly, the 02R should will identify it in the appropriate slot. The TDIF-1 digital I/O card (CD8-TDII) can be installed in any slot. You should install the first two cards in SLOT1 and SLOT2 in order to access the direct out lines.

Note: *If the W.CLK IN box is not showing a proper wordclock input (no discrepancy between the input and selected wordclock frequencies), check the BNC cable between the WORD SYNC OUT connector on the DA-88 and the WORD CLOCK IN connector on the 02R. Check that the DA-88 is powered on.*

3. Use the CURSOR buttons to select the wordclock source.

Use the CURSOR buttons to select the W.CLK IN box and press the [ENTER] button.

The current wordclock source is indicated by a highlighted icon. See “Word Clock Select” on page 188 of the *User’s Guide* for further details.

Peak Meter Bridge (MB02)

The Peak Meter Bridge (MB02) allows you to quickly and easily check the levels of the input channels, the tape and effect returns, the output buses 1 through 8, the auxiliary buses 1 through 8, and the stereo bus.

Using the MB02

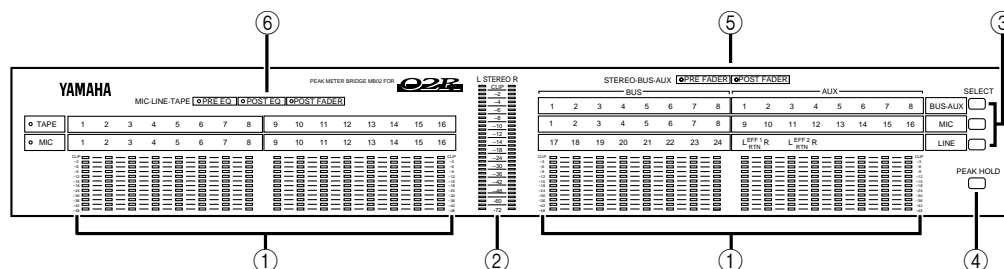

1. Level meters

These peak level meters show the signal level of each input channel (MIC/LINE 1 through 16, LINE 17/18 through 23/24), the tape returns (TAPE 1 through 16), the effect returns (EFF1 and EFF2), the output buses (BUS1 through BUS8), and the auxiliary buses (AUX1 through AUX8).

2. STEREO level meter

This peak level meter shows the level of the stereo bus.

3. SELECT buttons

These buttons are used to select the signal being monitored.

- **BUS/AUX**—When this button is on, the level meters on the right side of the panel will indicate the output levels of the output buses (BUS 1 through BUS 8), and the auxiliary buses (AUX 1 through AUX 8).
- **MIC**—When this button is on, the level meters on the left side of the panel will indicate the tape return levels and the meters on the right side of the panel indicate the individual input channel levels (MIC/LINE 1 through 16). If a digital I/O card is installed in SLOT3 and/or SLOT4, the MIC channels can monitor the output from the connected multitrack digital recorder, allowing you to see the levels of tape return channels 17 through 32.
- **LINE**—When this button is on, the level meters on the left side of the panel indicate the individual input channel levels (MIC/LINE 1 through 16). The meters on the right side of the panel indicate the stereo input channels (LINE 17/18 through 23/24) and the effect returns (EFF1 and EFF2).

4. PEAK HOLD button

This button is used to enable or cancel the Peak Hold function.

Note: *The operation of this button duplicates the function of the PEAK HOLD icon in the METER display function. See “Metering” on page 41 and “Peak Hold” on page 42 of the User’s Guide.*

5. STEREO-BUS-AUX Indicators

These indicators show the meter source points for the channels being monitored.

- **PRE FADER**—When this LED is illuminated, the bus signal before the fader is being displayed.
- **POST FADER**—When this LED is illuminated, the bus signal after the fader is being displayed.

The meter source points are set with the METER display function. See “Meter Source Points” on page 42 of the *User’s Guide*.

6. MIC-LINE-TAPE Indicators

These indicators show the meter source points for the channels being monitored.

- **PRE EQ**—When this LED is illuminated, the signal before the EQ signal is being displayed.
- **POST EQ**—When this LED is illuminated, the signal after the EQ is being displayed.
- **POST FADER**—When this LED is illuminated, the signal after the fader is being displayed.

The meter source points are set with the METER display function. See “Meter Source Points” on page 42 of the *User’s Guide*.

15

Specifications

In this chapter...

General Specifications	240
Input Specifications	246
Output Specifications	247
Digital Input and Output Specifications	247
Dimensions	248
Options	249
Troubleshooting	250
Error Messages	251
MIDI Data Format	262
Parameter Change and Request Format	265
Bulk Dump and Request Format	273

General Specifications

Number of scene memories	96	
Sampling frequency	Internal	44.1 kHz, 48 kHz
	External	(32 kHz -6%) to (48 kHz +6%)
Signal delay	Less than 2.5 ms. MIC/LINE input to STEREO output	
Fader resolution	+10 to -90, -∞ dB (128 steps/100 mm) input faders.	
	0 to -120, -∞ dB (128 steps/100 mm) stereo fader	
Total harmonic distortion (THD)	Less than 0.2%, 20 Hz to 20 kHz (analog output) @+14 dB into 600Ω	
Frequency response	+1, -3 dB, 20 Hz to 20 kHz @+4 dB into 600Ω	
Dynamic range	110 dB typical D/A Converter (STEREO OUT) *	
	105 dB typical A/D to D/A (MIC/LINE IN to STEREO OUT) *	
Hum & Noise (20 Hz to 20 kHz) *, Rs = 150Ω, Input gain max. Input pad = 0 dB Input sensitivity = -60 dBV	-128 dB Equivalent input noise	
	-88 dB residual output noise. STEREO OUTPUT. STEREO OUTPUT off	
	-88 dB (92 dB S/N) STEREO OUTPUT. Master fader at nominal level and all channel faders at minimum level	
	-64 dB (68 dB S/N) STEREO OUTPUT. Master fader at nominal level and one input fader at nominal level	
Maximum Voltage Gain	74 dB MIC/LINE (1 through 16) IN to STEREO OUT	
	74 dB MIC/LINE (1 through 16) IN to AUX SEND 1, 2, 3, 4, 5, 6 (via PRE INPUT FADER)	
	74 dB MIC/LINE (1 through 16) IN to MONITOR OUT (via STEREO bus)	
	54 dB LINE (17 through 24) IN to STEREO OUT	
Crosstalk(@1kHz)	70 dB adjacent input channels	
	70 dB input to output	

* Hum & Noise are measured with a 6 dB/octave filter @12.7 kHz; equivalent to a 20 kHz filter with an infinite dB/octave attenuation.

* Sampling Frequency: Internal 48 kHz

Inputs

Input channel (MIC/LINE 1 through 24)				
Phantom switch	MIC/LINE 1 to 8			
Select switch	A (XLR) / B (phone)	MIC/LINE 1 through 8		
Gain trim	44 dB (−60 to −16)	MIC/LINE 1 through 16		
	44 dB (−40 to +4)	LINE 17/18 through 23/24		
Peak indicator	LED (red) illuminates when post HA level reaches 3 dB below clipping			
Signal indicator	LED (green) illuminates when post HA level reaches 10 dB below nominal			
Insert	MIC/LINE 1 through 8 (pre A/D)			
Pad switch	0/20 dB attenuation	MIC/LINE 1 through 16		
AD converter	20 bit linear / 64 times oversampling			
I/O option	ADAT / TASCAM / YAMAHA	MIC/LINE 1 through 16		
Attenuator	0 to 96 dB (1 dB step)			
Filter	DC cut filter / de-emphasis			
4 band parametric equalizer	ON/OFF			
		LOW/HPF	L-MID	H-MID
		10 to 0.1 (Peaking) (41 steps)		
	Q	Low shelving		High shelving
		HPF (slope = 12 dB/oct)		LPF (slope = 12 dB/oct)
	F	21 Hz to 20.1 kHz (@ 48 kHz and 44.1 kHz) 21 Hz to 15.1 kHz (@ 32 kHz) (1/12 octave steps)		
	G	±18 dB (0.5 dB steps)		
		HPF = ON/OFF		LPF = ON/OFF

Input channel (MIC/LINE 1 through 24)		
Dynamics	Compressor / Expander	
	Threshold	-54 dB to 0 dB (1 dB steps)
	Ratio	1, 1.1, 1.3, 1.5, 1.7, 2, 2.5, 3, 3.5, 4, 5, 6, 8, 10, 20, ∞ (16 points)
	Out gain	0 dB to +18 dB (0.5 dB steps)
	Knee	hard, 1, 2, 3, 4, 5 (6 steps)
	Attack	0 ms to 120 ms (1 ms steps)
	Release	5 ms to 42.3 sec (@48 kHz), 6 ms to 46.0 sec (@44.1 kHz), 8 ms to 63.4 sec (@32 kHz) (160 points)
	Gate / Ducking	
	Threshold	-54 dB to 0 dB (1 dB steps)
	Range	-70 dB to 0 dB (1 dB steps)
	Attack	0 ms to 120 ms (1 ms steps)
	Hold	0.02 ms to 1.96 sec (@ 48 kHz), 0.02 ms to 2.13 sec (@ 44.1 kHz), 0.03 ms to 2.94 sec (@ 32 kHz) (216 points)
	Decay	5 ms to 42.3 sec (@ 48 kHz), 6 ms to 46.0 sec (@ 44.1 kHz), 8 ms to 63.4 sec (@32 kHz) (160 points)
	CompannderH / CompannderS	
	Threshold	-54 dB to 0 dB (1 dB steps)
	Ratio	1, 1.1, 1.3, 1.5, 1.7, 2, 2.5, 3, 3.5, 4, 5, 6, 8, 10, 20 (15 points)
	Out gain	-18 dB to 0 dB (0.5 dB steps)
	Width	1 dB to 90 dB (1 dB steps)
	Attack	0 ms to 120 ms (1 ms steps)
	Release	5 ms to 42.3 sec (@48 kHz), 6 ms to 46.0 sec (@44.1 kHz), 8 ms to 63.4 sec (@32 kHz) (160 points)
	Delay	0 to 2600 samples
Phase	NORMAL / REVERSE	
Channel ON/OFF (1 to 20)		
Channel SEL (1 to 20)		
Fader (1 to 20)	100 mm motorized	
	INPUT FADER / AUX1 / AUX2 / AUX3 / AUX4 / AUX5 / AUX6 / AUX7 / AUX8	
Aux send	ON/OFF	
	AUX 1	PRE / POST FADER (external effects)
	AUX 2	PRE / POST FADER (external effects)
	AUX 3	PRE / POST FADER (external effects)
	AUX 4	PRE / POST FADER (external effects)
	AUX 5	PRE / POST FADER (external effects)
	AUX 6	PRE / POST FADER (external effects)
	AUX 7	PRE / POST FADER (internal effects)
	AUX 8	PRE / POST FADER (internal effects)

Input channel (MIC/LINE 1 through 24)	
Pan	33 positions (L = 16 to 1, C, R = 16 to 1)
Routing	BUS 1 through 8. ST. DIRECT
Solo	ON/OFF
	Pre fader / After pan
Meter	Peakhold: ON/OFF
	12 points displays of the pre-EQ / post-EQ / post-fader levels of all channel input are displayed on the screen.

Tape Input channel (TAPE 1 through 16)	
I/O option	ANALOG, ADAT, TASCAM, AES/EBU, YAMAHA
Filter	DC cut filter / de-emphasis
Attenuator	0 to 96 dB (1 dB step)
4 band parametric equalizer	(Parameters are the same as MIC/LINE input equalizer.)
Dynamics	(Parameters are the same as MIC/LINE input dynamics.)
Delay	0 to 2600 sample
Phase	NORMAL / REVERSE
ON/OFF	
Fader	Rotary encoder
	INPUT / AUX1 / AUX2 / AUX3 / AUX4 / AUX5 / AUX6 / AUX7 / AUX8
Aux send	(Parameters are the same as MIC/LINE input aux send.)
Pan	33 positions (L = 16 to 1, C, R = 16 to 1)
Routing	BUS 1 through 8. ST
Solo	ON/OFF
	Pre fader / After pan
Meter	Peakhold: ON/OFF
	12 points displays of the pre-EQ / post-EQ / post-fader levels of all channel input are displayed on the screen.

Effect Return (EFF 1 through 2)	
Attenuator	0 to 96 dB (1 dB step)
4 band parametric equalizer	(Parameters are the same as MIC/LINE input equalizer.)
Delay	0 to 2600 sample
Phase	NORMAL / REVERSE
ON/OFF	
Fader	Rotary encoder
	INPUT / AUX1 / AUX2 / AUX3 / AUX4 / AUX5 / AUX6 / AUX7 / AUX8
Aux send	(Parameters are the same as MIC/LINE input aux send. EFF1 can only send to AUX8. EFF2 can only send to AUX7.)
Pan	33 positions (L = 16 to 1, C, R = 16 to 1)

Effect Return (EFF 1 through 2)	
Routing	BUS 1 through 8. ST
Solo	ON/OFF
	Pre fader / After pan
Meter	Peakhold: ON/OFF
	12 points displays of the pre-EQ / post-EQ / post-fader levels of all channel input are displayed on the screen.

Outputs

STEREO OUT	
Dynamics	(parameters are the same as MIC/LINE input dynamics.)
4 band parametric equalizer	(parameters are the same as MIC/LINE input equalizer.)
Fader	100 mm motorized
ON/OFF	
Meter	21-elements x 2 LED meter. (pre fader / post fader)
D/A converter	20bit linear / 8 times oversampling

BUS OUT (BUS1 through BUS8)	
Dynamics	(parameters are the same as MIC/LINE input dynamics.)
Level	rotary encoder
Meter	12 points displays of the pre/post fader levels of all channel input are displayed on the screen.
I/O option	ANALOG, ADAT, TASCAM, AES/EBU, YAMAHA

AUX OUT (AUX1 through AUX8)	
Level	rotary encoder
Meter	12 points displays of the pre/post fader levels of all channel input are displayed on the screen.
D/A converter	18bit linear / 8 times oversampling (AUX1 through AUX6)

CONTROL ROOM MONITOR OUT	
Select switch	2TR-A1 / 2TR-A2 / 2TR-D1 / 2TR-D2 / 2TR-D3 / AUX5 /AUX6 / ST
Mono	ON/OFF
DIM	ON/OFF
D/A converter	20bit linear / 8 times oversampling
Emphasis	Auto ON/OFF
Level control	
Phone level	

STUDIO MONITOR OUT

Select switch	AUX5 / AUX6 / C-R / ST_
D/A converter	18bit linear / 8 times oversampling
Level control	

TALKBACK

Talkback	ON/OFF
Slate	ON/OFF
Level control	
A/D converter	16 bit linear / 64 times oversampling

Libraries

Internal Digital Effector (EFFECT 1, 2)

	Number of factory presets	40
	Number of user library	88

Dynamics

	Number of factory presets	40
	Number of user library	88

Equalizer Library

	Number of factory presets	32
	Number of user library	96

Channel Library

	Number of user library	64
--	------------------------	----

Power Requirement	USA/Canada	120V	60 Hz
	UK	240V	50 Hz
	General	230V	50 Hz

Power Consumption	180W
--------------------------	------

Dimensions (H × D × W)	221.5 mm × 685 mm × 672 mm
-------------------------------	----------------------------

Net Weight	31kg
-------------------	------

Free-air operating temperature range	10 to 35°C
---	------------

Options	DIGITAL I/O CARD (ADAT)	CD8-AT	DIGITAL I/O CARD (AES/EBU)	CD8-AE CD8-AE -S
	A/D CARD	CD8-AD-S	DIGITAL CASCADE KIT	CD8-CS
	AD/DA CARD	CD8-AD	PEAK METER BRIDGE	MB02
	DIGITAL I/O CARD (TDIF-1)	CD8-TDII	MEMORY EXPANSION KIT	ME4M
	DIGITAL I/O CARD (YAMAHA)	CD8-Y	WOODEN SIDE PANEL	W02SP

Input Specifications

Input connection	PAD	GAIN	Actual load impedance	For use with nominal	Input level			Mixer connector
					Sensitivity* ¹	Nominal	Max. before clip	
CH INPUT MIC/LINE 1 through 16	0	-60	3k Ω (XLR) 4k Ω (Phone jack)	50 to 600 Ω mics and 600 Ω lines	-70 dB (245 μ V)	-60 dB (775 μ V)	-40 dB (7.75mV)	XLR-3-31 type* ² or Phone Jack (TRS)* ³
		-16			-26 dB (38.8mV)	-16 dB (123mV)	+ 4 dB (1.23V)	
	20	- 6 dB (388mV)			+ 4 dB (1.23V)	+24 dB (12.3V)		
CH INPUT LINE 17 through 24		-40	4k Ω	600 Ω lines	-50 dB (2.45mV)	-40 dB (7.75mV)	-20 dB (77.5mV)	Phone Jack (TRS)* ³
		+4			- 6 dB (388mV)	+ 4 dB (1.23V)	+24 dB (12.3V)	
INSERT IN MIC/LINE 1 through 8			10k Ω	600 Ω lines	-10 dB (245mV)	+ 0 dB (775mV)	+20 dB (7.75V)	Phone Jack* ⁴
2 TRACK INPUT [L,R]			10k Ω	600 Ω lines	+ 4 dB (1.23V)	+ 4 dB (1.23V)	+24 dB (12.3V)	Phone Jack* ⁵
			10k Ω	600 Ω lines	-10 dBV (316mV)	-10 dBV (316mV)	+10 dBV (3.16V)	RCA/phono* ⁶

*1 Sensitivity is the lowest level that will produce an output of +4 dB (1.23V) or the nominal output level when the unit is set to maximum gain. (All faders and level controls are maximum position.)

*2 XLR type connectors are balanced. (1=GND, 2=HOT, 3=COLD)

*3 MIC/LINE INPUT and LINE INPUT phone jacks are balanced. (Tip=HOT, Ring=COLD, Sleeve=GND)

*4 INSERT INPUT phone jacks are unbalanced. (Tip=OUT, Ring=IN, Sleeve=GND)

*5 2 TRACK INPUT phone jacks are balanced.

*6 2 TRACK INPUT RCA/phone jacks are unbalanced.

* In these specifications, when dB represents are specific voltage, 0 dB is referenced to 0.775 volts RMS.

* In these specifications, when dBV represents are specific voltage, 0 dBV is referenced to 1 volts RMS.

Output Specifications

Output connection	Actual source impedance	For use with nominal	Output level		Mixer connector
			Nominal	Max before clip	
STEREO OUT (L, R)	150Ω	600Ω lines	+ 4 dB (1.23V)	+24 dB (12.3V)	XLR-3-32 type
	600Ω	10kΩ lines	-10 dBV (316mV)	+10 dBV (3.16V)	RCA/phono (Unbalanced)
STUDIO MONITOR OUT (L, R)	150Ω	10kΩ lines	+ 4 dB (1.23V)	+24 dB (12.3V)	Phone Jack (Balanced)
CONTROL ROOM MONITOR OUT (L, R)	150Ω	10kΩ lines	+ 4 dB (1.23V)	+24 dB (12.3V)	Phone Jack (Balanced)
AUX (1, 2, 3, 4, 5, 6)	600Ω	10kΩ lines	+ 4 dB (1.23V)	+20 dB (7.75V)	Phone Jack (Unbalanced)
INSERT OUT MIC/LINE 1 through 8	600Ω	10kΩ lines	+ 0 dB (0.775V)	+20 dB (7.75V)	Phone Jack (Unbalanced)*1
PHONES	100Ω	8Ω phones	1 mW	25 mW	Stereo Phone Jack (Unbalanced)
		40Ω phones	3 mW	110 mW	

*1 INSERT OUTPUT phone jacks are balanced. (Tip=OUT, Ring=IN, Sleeve=GND)

* In these specifications, when dB represents are specific voltage, 0 dB is referenced to 0.775 volts RMS.

* In these specifications, when dBV represents are specific voltage, 0 dBV is referenced to 1 volts RMS.

Digital Input and Output Specifications

Input/Output	Format	Level	Mixer connector
DIGITAL IN (COAXIAL) (2TRK IN 2, 3)	IEC958 Consumer (S/PDIF)	0.5Vpp/75Ω	RCA/phono jack
DIGITAL OUT (COAXIAL) (STEREO OUT)	IEC958 Consumer (S/PDIF)	0.5Vpp/75Ω	RCA/phono jack
DIGITAL IN (AES/EBU) (2TRK IN 1)	IEC958 Professional (AES/EBU)	RS422	XLR-3-32 type
DIGITAL OUT (AES/EBU) (STEREO OUT)	IEC958 Professional (AES/EBU)	RS422	XLR-3-31 type
WORD CLOCK IN	–	TTL / 75Ω	BNC
WORD CLOCK OUT	–	TTL / 75Ω	BNC
MIDI IN	MIDI	–	DIN Connector 5P
MIDI OUT	MIDI	–	DIN Connector 5P
MIDI THRU	MIDI	–	DIN Connector 5P
TO HOST	–	–	MiniDIN Connector 8P
METER	–	RS422	Dsub Connector 15p
MTC IN	MIDI	–	DIN Connector 5P
TC IN	SMPTE	Nominal -10 dBV/10kΩ	RCA/phono jack

Dimensions

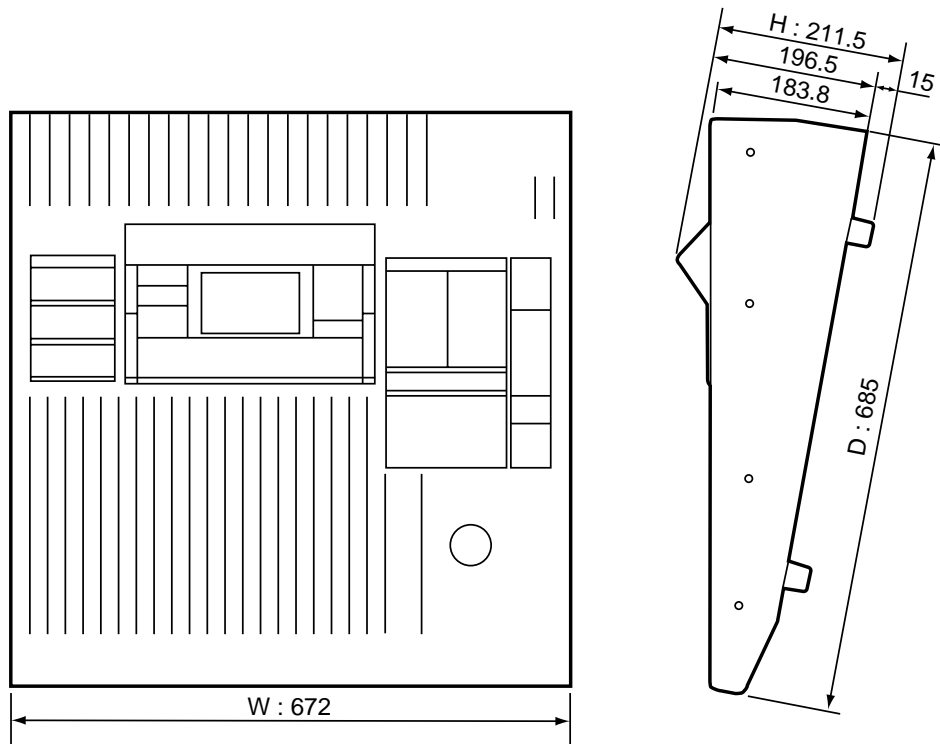

Specifications and external appearance are subject to change without notice.

For European Model

Purchaser/User Information specified in EN55103-1 and EN55103-2.

Inrush Current: 9A

Conformed Environment: E1, E2, E3 and E4

Options

AD/DA I/O Card Specifications

Analog Input

Input connections	GAIN	Actual load impedance	For use with nominal	Input level			Mixer connector
				Sensitivity* ¹	Nominal	Max. before clip	
INPUT 1 through 8	+4	10k Ω	600 Ω lines	-6 dB (388mV)	+4 dB (1.23mV)	+24 dB (12.3mV)	Phone Jack (TRS) ^{*2}
	-10			-20 dBV (100mV)	-10 dBV (316mV)	+10 dBV (3.16V)	

*1 Sensitivity is the lowest level that will produce an output of +4 dB (1.23V) or the nominal output level when the unit is set to maximum gain. (All faders and level controls are maximum position.)

*2 CH INPUT phone jacks are balanced. (Tip=HOT, Ring=COLD, Sleeve=GND)

* In these specifications, when dB represents are specific voltage, 0 dB is referenced to 0.775 volts RMS.

* In these specifications, when dBV represents are specific voltage, 0 dBV is referenced to 1 volts RMS.

Analog Output

Output connections	GAIN	Actual source impedance	For use with nominal	Output level		Mixer connector
				Nominal	Max before clip	
OUTPUT 1 through 8	+4	150 Ω	10k Ω lines	+4 dB (1.23mV)	+24 dB (12.3mV)	Phone Jack (TRS) ^{*1}
	-10			-10 dBV (316mV)	+10 dBV (3.16V)	

*1 CH OUTPUT phone jacks are balanced. (Tip=HOT, Ring=COLD, Sleeve=GND)

* In these specifications, when dB represents are specific voltage, 0 dB is referenced to 0.775 volts RMS.

* In these specifications, when dBV represents are specific voltage, 0 dBV is referenced to 1 volts RMS.

Digital I/O Card Specifications

Digital Input/Output

Input/Output	Format	Level	Mixer connector
DA88/DA38 (BUS/DIRECT OUT, TAPE IN)	TDIF-1	C-MOS	D-SUB 25PIN
ADAT (BUS/DIRECT OUT, TAPE IN)	ADAT	OPTICAL	
AES/EBU (BUS/DIRECT OUT, TAPE IN)	AES/EBU	RS422	XLR-3-31 type (INPUT)
			XLR-3-32 type (OUTPUT)
			D-SUB 25PIN
YAMAHA (BUS/DIRECT OUT, TAPE IN)	YAMAHA	RS422	D-SUB 25PIN
CASCADE (BUS/DIRECT OUT, TAPE IN)	YAMAHA	RS422	D-SUB 25PIN

Troubleshooting

If there is any trouble, check the situation and follow the corrective actions described below.

The power is not turned on.

- Did you plug the power cord to a correct AC outlet?
- Is the POWER switch ON?

No sound is produced.

- Is the signal coming in from the external device?
- Is the input "ON" indicator lit?
- Is the input fader raised?
- Is the stereo output "ON" indicator lit?
- Is the stereo output fader raised?
- Is the option board securely inserted?
- Is the output bus assigned correctly?
- Is the word clock set correctly?
- Is the output in the C-R monitor section selected?

The volume level is very low.

- Are the PAD switch and GAIN volume control set correctly?
- Is the input fader raised?
- Is the gain set too low in the equalizer section?
- Are the threshold and ratio settings for the dynamics processor set correctly?
- Is the [DIM] key in the C-R monitor section OFF?

Sound is distorted.

- Are the PAD switch and GAIN volume control set correctly?
- Is the input fader raised too high?
- Is the stereo output fader raised too high?
- Is the gain set too high in the equalizer section?

A pair of stereo channels does not sound in stereo.

- Is the pan setting correct?

Abnormal phase

- Is the phase on the input device set correctly?

The volume level of certain channels goes up and down.

- Is the dynamics processor ducking set for those channels?

Scene data cannot be stored.

- Is memory protect ON?
- You cannot store scene data to Scene "0."

MIDI data cannot be transmitted or received.

- Does the MIDI transmit channel match the receive channel?
- Is the switch for the item to be transmitted/received (Program Change, Parameter Change) turned on?

The fader movement is not consistent.

- Calibrate the faders. See "Fader Calibration" on page 215 of the *User's Guide*.

Error Messages

Follow the corrective actions described below when the error messages are shown on the display:

Error Message	Corrective Action
2TR-D1 No Input!	Correct digital signal is not input to 2TR-D1. (C-R monitoring is not available.)
2TR-D2 Cascade Disabled	2TR-D2 cannot be routed to STEREO BUS. (Incorrect word clock setting)
2TR-D2 No Input!	Correct digital signal is not input to 2TR-D2. (C-R monitoring is not available.)
2TR-D3 No Input!	Correct digital signal is not input to 2TR-D3. (C-R monitoring is not available.)
Automix Aborted!	Automix data was aborted. (You can undo the operation.)
Automix Disabled!	Time code was input, but automix is disabled.
Automix REC Ready!	Ready for recording automix.
Automix Recording!	Recording automix now.
Automix Running!	Automix is now running.
Automix Updated!	Automix has been updated. (You can undo the operation.)
Byte Count Error!	Byte count for the received bulk data is not correct.
Can't assign 2TR-D1!	2TR-D1 cannot be routed to line 17/18. (The signal at 2TR-D1 is not syncing with the 02R, or 2TR-D1 has been selected in the C-R monitor section.)
Can't assign 2TR-D2!	2TR-D2 cannot be routed to line 19/20. (The signal at 2TR-D2 is not syncing with the 02R, or 2TR-D2 has been selected in the C-R monitor section.)
Can't select SLOT3!	SLOT3 cannot be selected for digital input. (The I/O card is not in SLOT3.)
Can't select SLOT4!	SLOT4 cannot be selected for digital input. (The I/O card is not in SLOT4.)
Can't select WORD CLOCK!	Not available as a word clock source.
Cannot Copy Title!	You cannot copy the title from the memory that has no data.
Cannot Paste Title!	You cannot paste the title to the memory that has no data.
Check Sum Error!	Check sum of the received bulk data is not correct.
Code Mismatch!	Product code for the received bulk data is not correct.
DIGITAL I/O Error!	Incoming signal from SLOT DIO is not syncing with the 02R. The synchronization system has not been configured successfully. Or, if the sync system has been configured, this message may still appear if the clock sent from the MTR is unstable until the digital MTR enters CHASE status. You can select whether this message will be shown or not. (see "Preferences" on page 198 of the <i>User's Guide</i>)
Duplicate Grouping!	You cannot duplicate the group.

Error Message	Corrective Action
Fixed Fragmentation!	The automix memory has been corrected. Abnormal data may be generated in the memory if you turn off the power during recording or if incomplete bulk data is received.
Frame Drop Out!(#)	Time code frame is dropping out. (The count in the parenthesis shows the number of dropping frames.)
Frame Jump!	Time code frame is dropping out.
ID Mismatch!	Model ID for parameter change is not correct.
Illegal Time Range!	In/out time setting is incorrect.
Low Battery!	The internal battery voltage is getting very low. Back up the setup data stored in the 02R (see "Bulk Dump/Request" on page 161 of the <i>User's Guide</i>), and ask your dealer to replace the battery.
MAIN SCI0 Framing Err.	Consult the nearest YAMAHA service center.
MAIN SCI0 OverRun Err.	Consult the nearest YAMAHA service center.
MAIN SCI0 Party Err.	Consult the nearest YAMAHA service center.
MAIN SCI0 RxBuf. Full	MIDI data being transmitted is too large.
MAIN SCI0 TxBuf. Full	MIDI data being received is too large.
MAIN SCI1 Framing Err.	Check the connection at the TO HOST connector.
MAIN SCI1 OverRun Err.	Check the connection at the TO HOST connector.
MAIN SCI1 Party Err.	Check the connection at the TO HOST connector.
MAIN SCI1 RxBuf. Full	Check the connection at the TO HOST connector.
MAIN SCI1 TxBuf. Full	Check the connection at the TO HOST connector.
MAIN->SUB Disconnected!	Consult the nearest YAMAHA service center.
Make New Mix!	First make a New Mix.
Memory Full!	Automix memory is full.
MIDI Ch Mismatch (#)	The device number of the received bulk data is not correct.
No Aux Send!	There is no AUX send from EFF1 to AUX7 or EFF2 to AUX8.
No Time Code!	Time code is not being input.
Preset is read only!	You cannot store data to the preset memory.
Redone.	The previous operation was redone.
Scene 0 is read only!	You cannot store data to Scene "0."
Scene Memory Protected!	Scene memory is write-protected.
Select Channel!	A channel for extract has not been assigned.
Select Parameter!	The parameter for extract has not been assigned.
Set Overwrite!	Set the overwrite parameter.
SOLO Ready!	The track is ready for solo.
SOLO Slave!	You cannot change the solo status and the Solo key is disabled if the unit is a cascade slave.
SUB->MAIN Disconnected!	Consult the nearest YAMAHA service center.
SUB SCI0 Framing Err.	Consult the nearest YAMAHA service center.
SUB SCI0 OverRun Err.	Consult the nearest YAMAHA service center.

Error Message	Corrective Action
SUB SCI0 Party Err.	Consult the nearest YAMAHA service center.
SUB SCI0 RxBuf. Full	MIDI data being transmitted is too large.
SUB SCI0 TxBuf. Full	MIDI data being received is too large.
SUB SCI1 Framing Err.	Check the MIDI connection.
SUB SCI1 OverRun Err.	Check the MIDI connection.
SUB SCI1 Party Err.	Check the MIDI connection.
SUB SCI1 RxBuf. Full	MIDI data being transmitted is too large.
SUB SCI1 TxBuf. Full	MIDI data being received is too large.
TC RxBuf. Full	Buffer for time code reception is full.
TC TxBuf. Full	Buffer for time code transmission is full.
Too Large Bulk!	MIDI bulk data size is too large.
Undo Buf. is Empty!	The previous operation cannot be undone because no data exists in the undo buffer.
Undo Buf. is Full!	The store operation cannot be done because the data exists in the undo buffer.
Undone Recall.	The recall operation was undone.
Undone Store.	The store operation was undone.
Wrong WORD CLOCK!	The device for synchronization (selected from the 02R) is sending incorrect word clock. Reconfigure the synchronization system.
Too many cascade in/out cards. Shut off the power and check slot, please.	There are more than two cascade cards or too many cards with the "in" or "out" setting. Check the slot condition, and turn the power on to the 02R again.

Appendix: MIDI

Scene Memory to Program Change Table

Program Change #	Initial Scene #	User Scene #
1	1	
2	2	
3	3	
4	4	
5	5	
6	6	
7	7	
8	8	
9	9	
10	10	
11	11	
12	12	
13	13	
14	14	
15	15	
16	16	
17	17	
18	18	
19	19	
20	20	
21	21	
22	22	
23	23	
24	24	
25	25	
26	26	
27	27	
28	28	
29	29	
30	30	
31	31	
32	32	
33	33	
34	34	
35	35	
36	36	
37	37	
38	38	
39	39	
40	40	
41	41	
42	42	
43	43	

Program Change #	Initial Scene #	User Scene #
44	44	
45	45	
46	46	
47	47	
48	48	
49	49	
50	50	
51	51	
52	52	
53	53	
54	54	
55	55	
56	56	
57	57	
58	58	
59	59	
60	60	
61	61	
62	62	
63	63	
64	64	
65	65	
66	66	
67	67	
68	68	
69	69	
70	70	
71	71	
72	72	
73	73	
74	74	
75	75	
76	76	
77	77	
78	78	
79	79	
80	80	
81	81	
82	82	
83	83	
84	84	
85	85	
86	86	

Program Change#	Initial Scene #	User Scene #
87	87	
88	88	
89	89	
90	90	
91	91	
92	92	
93	93	
94	94	
95	95	
96	96	
97	0	
98	—	
99	—	
100	—	
101	—	
102	—	
103	—	
104	—	
105	—	
106	—	
107	—	
108	—	
109	—	
110	—	
111	—	
112	—	
113	—	
114	—	
115	—	
116	—	
117	—	
118	—	
119	—	
120	—	
121	—	
122	—	
123	—	
124	—	
125	—	
126	—	
127	—	
128	—	

Parameter to Control Change Table (02R & User Maps)

Control Change #	Parameter			
	02R Map			User Map
0	NO ASSIGN			
1	FADER	CHANNEL	MIC 1	
2	FADER	CHANNEL	MIC 2	
3	FADER	CHANNEL	MIC 3	
4	FADER	CHANNEL	MIC 4	
5	FADER	CHANNEL	MIC 5	
6	FADER	CHANNEL	MIC 6	
7	FADER	CHANNEL	MIC 7	
8	FADER	CHANNEL	MIC 8	
9	FADER	CHANNEL	MIC 9	
10	FADER	CHANNEL	MIC 10	
11	FADER	CHANNEL	MIC 11	
12	FADER	CHANNEL	MIC 12	
13	FADER	CHANNEL	MIC 13	
14	FADER	CHANNEL	MIC 14	
15	FADER	CHANNEL	MIC 15	
16	FADER	CHANNEL	MIC 16	
17	FADER	CHANNEL	LINE 17/18	
18	FADER	CHANNEL	LINE 19/20	
19	FADER	CHANNEL	LINE 21/22	
20	FADER	CHANNEL	LINE 23/24	
21	FADER	CHANNEL	EFF 1	
22	FADER	CHANNEL	EFF 2	
23	FADER	CHANNEL	ST MASTER	
24	FADER	CHANNEL	AUX 1	
25	FADER	CHANNEL	AUX 2	
26	FADER	CHANNEL	AUX 3	
27	FADER	CHANNEL	AUX 4	
28	FADER	CHANNEL	AUX 5	
29	FADER	CHANNEL	AUX 6	
30	FADER	CHANNEL	AUX 7	
31	FADER	CHANNEL	AUX 8	
32	NO ASSIGN			
33	FADER	CHANNEL	BUS 1	
34	FADER	CHANNEL	BUS 2	
35	FADER	CHANNEL	BUS 3	
36	FADER	CHANNEL	BUS 4	
37	FADER	CHANNEL	BUS 5	

Control Change #	Parameter					
	02R Map			User Map		
38	FADER	CHANNEL	BUS 6			
39	FADER	CHANNEL	BUS 7			
40	FADER	CHANNEL	BUS 8			
41	ON	CHANNEL	MIC 1			
42	ON	CHANNEL	MIC 2			
43	ON	CHANNEL	MIC 3			
44	ON	CHANNEL	MIC 4			
45	ON	CHANNEL	MIC 5			
46	ON	CHANNEL	MIC 6			
47	ON	CHANNEL	MIC 7			
48	ON	CHANNEL	MIC 8			
49	ON	CHANNEL	MIC 9			
50	ON	CHANNEL	MIC 10			
51	ON	CHANNEL	MIC 11			
52	ON	CHANNEL	MIC 12			
53	ON	CHANNEL	MIC 13			
54	ON	CHANNEL	MIC 14			
55	ON	CHANNEL	MIC 15			
56	ON	CHANNEL	MIC 16			
57	ON	CHANNEL	LINE 17/18			
58	ON	CHANNEL	LINE 19/20			
59	ON	CHANNEL	LINE 21/22			
60	ON	CHANNEL	LINE 23/24			
61	ON	CHANNEL	EFF 1			
62	ON	CHANNEL	EFF 2			
63	ON	CHANNEL	ST MASTER			
64	PANPOT	CHANNEL	MIC 1			
65	PANPOT	CHANNEL	MIC 2			
66	PANPOT	CHANNEL	MIC 3			
67	PANPOT	CHANNEL	MIC 4			
68	PANPOT	CHANNEL	MIC 5			
69	PANPOT	CHANNEL	MIC 6			
70	PANPOT	CHANNEL	MIC 7			
71	PANPOT	CHANNEL	MIC 8			
72	PANPOT	CHANNEL	MIC 9			
73	PANPOT	CHANNEL	MIC 10			
74	PANPOT	CHANNEL	MIC 11			
75	PANPOT	CHANNEL	MIC 12			
76	PANPOT	CHANNEL	MIC 13			
77	PANPOT	CHANNEL	MIC 14			
78	PANPOT	CHANNEL	MIC 15			
79	PANPOT	CHANNEL	MIC 16			

Control Change #	Parameter					
	02R Map			User Map		
80	PANPOT	CHANNEL	LINE 17			
81	PANPOT	CHANNEL	LINE 18			
82	PANPOT	CHANNEL	LINE 19			
83	PANPOT	CHANNEL	LINE 20			
84	PANPOT	CHANNEL	LINE 21			
85	PANPOT	CHANNEL	LINE 22			
86	PANPOT	CHANNEL	LINE 23			
87	PANPOT	CHANNEL	LINE 24			
88	PANPOT	CHANNEL	EFF 1 Lch			
89	PANPOT	CHANNEL	EFF 1 Rch			
90	PANPOT	CHANNEL	EFF 2 Lch			
91	PANPOT	CHANNEL	EFF 2 Rch			
92	BALANCE		ST MASTER			
93	NO ASSIGN					
94	NO ASSIGN					
95	NO ASSIGN					
102	FADER	AUX 7 SEND	MIC 1			
103	FADER	AUX 7 SEND	MIC 2			
104	FADER	AUX 7 SEND	MIC 3			
105	FADER	AUX 7 SEND	MIC 4			
106	FADER	AUX 7 SEND	MIC 5			
107	FADER	AUX 7 SEND	MIC 6			
108	FADER	AUX 7 SEND	MIC 7			
109	FADER	AUX 7 SEND	MIC 8			
110	FADER	AUX 7 SEND	MIC 9			
111	FADER	AUX 7 SEND	MIC 10			
112	FADER	AUX 7 SEND	MIC 11			
113	FADER	AUX 7 SEND	MIC 12			
114	FADER	AUX 7 SEND	MIC 13			
115	FADER	AUX 7 SEND	MIC 14			
116	FADER	AUX 7 SEND	MIC 15			
117	FADER	AUX 7 SEND	MIC 16			
118	NO ASSIGN					
119	NO ASSIGN					

Parameter to Control Change Table (03D & Programmable Mixer 01 Maps)

Control Change #	Parameter					
	03D Map			Programmable Mixer 01 Map		
0	NO ASSIGN			FADER	CHANNEL	MIC 1
1	FADER	CHANNEL	MIC 1	FADER	CHANNEL	MIC 2
2	FADER	CHANNEL	MIC 2	FADER	CHANNEL	MIC 3
3	FADER	CHANNEL	MIC 3	FADER	CHANNEL	MIC 4
4	FADER	CHANNEL	MIC 4	FADER	CHANNEL	MIC 5
5	FADER	CHANNEL	MIC 5	FADER	CHANNEL	MIC 6
6	FADER	CHANNEL	MIC 6	FADER	CHANNEL	MIC 7
7	FADER	CHANNEL	MIC 7	FADER	CHANNEL	MIC 8
8	FADER	CHANNEL	MIC 8	FADER	CHANNEL	MIC 9
9	FADER	CHANNEL	MIC 9	FADER	CHANNEL	MIC 10
10	FADER	CHANNEL	MIC 10	FADER	CHANNEL	MIC 11
11	FADER	CHANNEL	MIC 11	FADER	CHANNEL	MIC 12
12	FADER	CHANNEL	MIC 12	FADER	CHANNEL	MIC 13
13	FADER	CHANNEL	MIC 13	FADER	CHANNEL	MIC 14
14	FADER	CHANNEL	MIC 14	FADER	CHANNEL	MIC 15
15	FADER	CHANNEL	MIC 15	FADER	CHANNEL	MIC 16
16	FADER	CHANNEL	MIC 16	FADER	CHANNEL	LINE 17/18
17	FADER	CHANNEL	LINE 17/18	FADER	CHANNEL	EFF 1
18	NO ASSIGN			FADER	CHANNEL	EFF 2
19	FADER	CHANNEL	LINE 19/20	FADER	CHANNEL	AUX 7
20	NO ASSIGN			FADER	CHANNEL	AUX 8
21	FADER	CHANNEL	LINE 21/22	FADER	CHANNEL	ST MASTER
22	NO ASSIGN			ON	CHANNEL	MIC 1
23	FADER	CHANNEL	LINE 23/24	ON	CHANNEL	MIC 2
24	NO ASSIGN			ON	CHANNEL	MIC 3
25	NO ASSIGN			ON	CHANNEL	MIC 4
26	FADER	CHANNEL	EFF 1	ON	CHANNEL	MIC 5
27	FADER	CHANNEL	EFF 2	ON	CHANNEL	MIC 6
28	FADER	CHANNEL	AUX 1	ON	CHANNEL	MIC 7
29	FADER	CHANNEL	AUX 2	ON	CHANNEL	MIC 8
30	FADER	CHANNEL	AUX 3	ON	CHANNEL	MIC 9
31	FADER	CHANNEL	AUX 4	ON	CHANNEL	MIC 10
32	NO ASSIGN			ON	CHANNEL	MIC 11
33	FADER	CHANNEL	BUS 1	ON	CHANNEL	MIC 12
34	FADER	CHANNEL	BUS 2	ON	CHANNEL	MIC 13
35	FADER	CHANNEL	BUS 3	ON	CHANNEL	MIC 14
36	FADER	CHANNEL	BUS 4	ON	CHANNEL	MIC 15
37	FADER	CHANNEL	ST MASTER	ON	CHANNEL	MIC 16

Control Change #	Parameter					
	03D Map			Programmable Mixer 01 Map		
38	PANPOT	CHANNEL	MIC 1	ON	CHANNEL	LINE 17/18
39	PANPOT	CHANNEL	MIC 2	ON	CHANNEL	EFF 1
40	PANPOT	CHANNEL	MIC 3	ON	CHANNEL	EFF 2
41	PANPOT	CHANNEL	MIC 4	NO ASSIGN		
42	PANPOT	CHANNEL	MIC 5	NO ASSIGN		
43	PANPOT	CHANNEL	MIC 6	ON	CHANNEL	ST MASTER
44	PANPOT	CHANNEL	MIC 7	PANPOT	CHANNEL	MIC 1
45	PANPOT	CHANNEL	MIC 8	PANPOT	CHANNEL	MIC 2
46	PANPOT	CHANNEL	MIC 9	PANPOT	CHANNEL	MIC 3
47	PANPOT	CHANNEL	MIC 10	PANPOT	CHANNEL	MIC 4
48	PANPOT	CHANNEL	MIC 11	PANPOT	CHANNEL	MIC 5
49	PANPOT	CHANNEL	MIC 12	PANPOT	CHANNEL	MIC 6
50	PANPOT	CHANNEL	MIC 13	PANPOT	CHANNEL	MIC 7
51	PANPOT	CHANNEL	MIC 14	PANPOT	CHANNEL	MIC 8
52	PANPOT	CHANNEL	MIC 15	PANPOT	CHANNEL	MIC 9
53	PANPOT	CHANNEL	MIC 16	PANPOT	CHANNEL	MIC 10
54	PANPOT	CHANNEL	LINE 17	PANPOT	CHANNEL	MIC 11
55	PANPOT	CHANNEL	LINE 18	PANPOT	CHANNEL	MIC 12
56	PANPOT	CHANNEL	LINE 19	PANPOT	CHANNEL	MIC 13
57	PANPOT	CHANNEL	LINE 20	PANPOT	CHANNEL	MIC 14
58	PANPOT	CHANNEL	LINE 21	PANPOT	CHANNEL	MIC 15
59	PANPOT	CHANNEL	LINE 22	PANPOT	CHANNEL	MIC 16
60	PANPOT	CHANNEL	LINE 23	PANPOT	CHANNEL	LINE 17
61	PANPOT	CHANNEL	LINE 24	PANPOT	CHANNEL	LINE 18
62	NO ASSIGN			PANPOT	CHANNEL	EFF 1 Lch
63	NO ASSIGN			PANPOT	CHANNEL	EFF 1 Rch
64	ON	CHANNEL	MIC 1	PANPOT	CHANNEL	EFF 2 Lch
65	ON	CHANNEL	MIC 2	PANPOT	CHANNEL	EFF 2 Rch
66	ON	CHANNEL	MIC 3	NO ASSIGN		
67	ON	CHANNEL	MIC 4	BALANCE		ST MASTER
68	ON	CHANNEL	MIC 5	FADER	AUX 7 SEND	MIC 1
69	ON	CHANNEL	MIC 6	FADER	AUX 7 SEND	MIC 2
70	ON	CHANNEL	MIC 7	FADER	AUX 7 SEND	MIC 3
71	ON	CHANNEL	MIC 8	FADER	AUX 7 SEND	MIC 4
72	ON	CHANNEL	MIC 9	FADER	AUX 7 SEND	MIC 5
73	ON	CHANNEL	MIC 10	FADER	AUX 7 SEND	MIC 6
74	ON	CHANNEL	MIC 11	FADER	AUX 7 SEND	MIC 7
75	ON	CHANNEL	MIC 12	FADER	AUX 7 SEND	MIC 8
76	ON	CHANNEL	MIC 13	FADER	AUX 7 SEND	MIC 9
77	ON	CHANNEL	MIC 14	FADER	AUX 7 SEND	MIC 10
78	ON	CHANNEL	MIC 15	FADER	AUX 7 SEND	MIC 11
79	ON	CHANNEL	MIC 16	FADER	AUX 7 SEND	MIC 12

Control Change #	Parameter					
	03D Map			Programmable Mixer 01 Map		
80	FADER	CHANNEL	LINE 17/18	FADER	AUX 7 SEND	MIC 13
81	NO ASSIGN			FADER	AUX 7 SEND	MIC 14
82	FADER	CHANNEL	LINE 19/20	FADER	AUX 7 SEND	MIC 15
83	NO ASSIGN			FADER	AUX 7 SEND	MIC 16
84	FADER	CHANNEL	LINE 21/22	FADER	AUX 7 SEND	LINE 17/18
85	NO ASSIGN			FADER	AUX 8 SEND	MIC 1
86	FADER	CHANNEL	LINE 23/24	FADER	AUX 8 SEND	MIC 2
87	NO ASSIGN			FADER	AUX 8 SEND	MIC 3
88	NO ASSIGN			FADER	AUX 8 SEND	MIC 4
89	ON	CHANNEL	EFF 1	FADER	AUX 8 SEND	MIC 5
90	ON	CHANNEL	EFF 2	FADER	AUX 8 SEND	MIC 6
91	NO ASSIGN			FADER	AUX 8 SEND	MIC 7
92	NO ASSIGN			FADER	AUX 8 SEND	MIC 8
93	NO ASSIGN			FADER	AUX 8 SEND	MIC 9
94	NO ASSIGN			FADER	AUX 8 SEND	MIC 10
95	ON	CHANNEL	ST MASTER	FADER	AUX 8 SEND	MIC 11
102	FADER	AUX 7 SEND	MIC 1	NO ASSIGN		
103	FADER	AUX 7 SEND	MIC 2	NO ASSIGN		
104	FADER	AUX 7 SEND	MIC 3	NO ASSIGN		
105	FADER	AUX 7 SEND	MIC 4	NO ASSIGN		
106	FADER	AUX 7 SEND	MIC 5	NO ASSIGN		
107	FADER	AUX 7 SEND	MIC 6	NO ASSIGN		
108	FADER	AUX 7 SEND	MIC 7	NO ASSIGN		
109	FADER	AUX 7 SEND	MIC 8	NO ASSIGN		
110	FADER	AUX 7 SEND	MIC 9	NO ASSIGN		
111	FADER	AUX 7 SEND	MIC 10	NO ASSIGN		
112	FADER	AUX 7 SEND	MIC 11	NO ASSIGN		
113	FADER	AUX 7 SEND	MIC 12	NO ASSIGN		
114	FADER	AUX 7 SEND	MIC 13	NO ASSIGN		
115	FADER	AUX 7 SEND	MIC 14	NO ASSIGN		
116	FADER	AUX 7 SEND	MIC 15	NO ASSIGN		
117	FADER	AUX 7 SEND	MIC 16	NO ASSIGN		
118	NO ASSIGN			NO ASSIGN		
119	BALANCE		ST MASTER	NO ASSIGN		

MIDI Data Format

1. General remarks

1-1 This section describes the MIDI functionality of the 02R.

1-2 Electrical characteristics and message formats are in compliance with MIDI standard 1.0.

2. Messages transmitted and received

2-1. Program change

Transmission/reception can be turned ON or OFF using the “MIDI Setup” display function (see “Setup” on page 159 of the *User’s Guide*).

When a memory recall occurs, the program change corresponding to that memory number will be transmitted on the specified MIDI channel.

When a program change is received on the specified MIDI channel or in OMNI mode, the memory corresponding to that program number will be recalled.

The user can create a customized program change assign table (see “Program Change Assign” on page 160 of the *User’s Guide*).

2-2. System exclusive messages

System exclusive messages include Bulk Dump/Request and Parameter Change/Request. For these messages, the device number will be the same as the MIDI channel.

Bulk Dump/Request

Transmission and reception is always ON.

Bulk Request is transmitted using the “MIDI Bulk Dump & Request” display function (see “Bulk Dump/Request” on page 161 of the *User’s Guide*) on the specified MIDI channel.

Bulk Dump transmits the contents of the corresponding memory on the specified MIDI channel, and is transmitted either by operations in the “MIDI Bulk Dump & Request” display function, or when a Bulk Request is received on the specified MIDI channel.

When a Bulk Dump is received, the contents of the corresponding memory will change.

Parameter Change/Request

Transmission/reception can be turned ON or OFF using the “MIDI Setup” display function (see “Setup” on page 159 of the *User’s Guide*).

If parameter change transmission is ON, a message will be transmitted on the specified MIDI channel when the parameters of the 02R are modified.

If parameter change reception is ON and a parameter request is received on the specified MIDI channel, the contents of the corresponding parameter will be transmitted on the specified MIDI channel regardless of whether transmission is ON or OFF.

If parameter change reception is ON and a parameter change is received on the specified MIDI channel, the contents of the corresponding parameter will be modified.

Transmission of KEY REMOTE parameter changes can be turned ON or OFF using the “Preferences” display function (see “Preferences” on page 198 of the *User’s Guide*) independently of other parameters. This is used only in special circumstances such as when externally monitoring key operations. Normally, it should be left OFF.

2-3. Active sensing, MIDI reset

If, after receiving Active Sensing, no messages are received for an interval longer than 300 ms, or when MIDI Reset is received, only the running status will be cleared.

Active Sensing is transmitted.

2-4. Quarter-frame messages

MIDI Time Code Quarter-frame messages are received at the MTC connector.

3. Echo Back

If ECHO is turned ON, the Program Change messages will be transmitted immediately after being received.

4. Transmission Condition

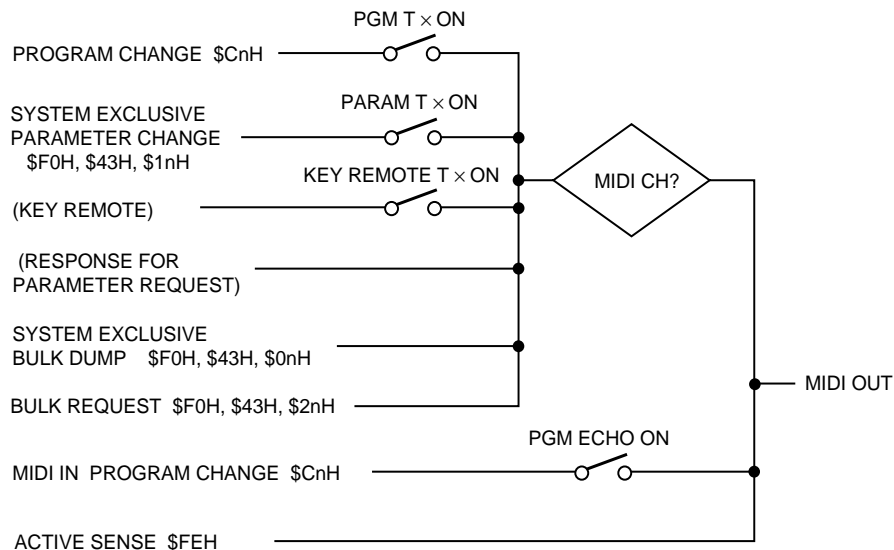

5. Receive Condition

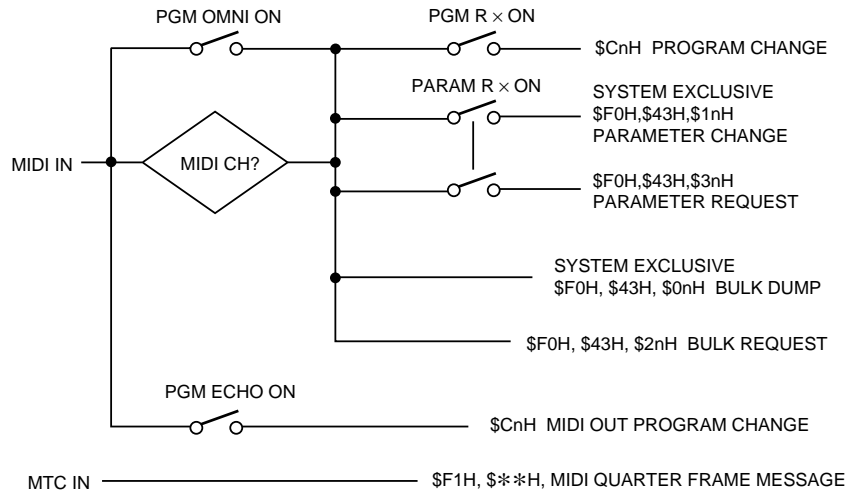

Parameter Change and Request Format

PARAMETER CHANGE (basic format)		
STATUS	11110000 F0	System Exclusive Message
ID No.	01000011 43	Manufacturer's ID No.(YAMAHA)
SUB STATUS	0001nnnn 1n	n=0-15(Tx/Rx Channel No.1-16)
MODEL ID	00111101 3d	MODEL ID (02R)
PARAM TYPE	0tttttttt tt	(type number, bit6:0=byte 1=bit operation)
DATA	0ddddddd dd0	data 0-n
	:	:
	0ddddddd ddn	
EOX	11110111 F7	End Of Exclusive

PARAMETER CHANGE REQUEST		
STATUS	11110000 F0	System Exclusive Message
ID No.	01000011 43	Manufacturer's ID No.(YAMAHA)
SUB STATUS	0011nnnn 3n	n=0-15(Tx/Rx Channel No.1-16)
MODEL ID	00111101 3d	MODEL ID (02R)
PARAM TYPE	0tttttttt tt	(type number, bit6:0=byte)
DATA	0ddddddd dd0	address(H) high 7 bits of 14 bits address
	0ddddddd dd1	address(L) low 7 bits of 14 bits address
	0ddddddd dd2	count
EOX	11110111 F7	End Of Exclusive

type number:

- 0 edit buffer(used byte or bit operation format)
- 1 setup(used byte operation format, request and response for request only)
- 2 backup(used byte operation format, request and response for request only)
- 24 recall/store(parameter change only)
- 25 key remote(parameter change only)
- 26 fader/encoder Remote(parameter change only)

PARAMETER CHANGE (byte operation for type number 0:edit buffer, 1:setup, 2:backup)		
STATUS	11110000 F0	System Exclusive Message
ID No.	01000011 43	Manufacturer's ID No.(YAMAHA)
SUB STATUS	0001nnnn 1n	n=0-15(Tx/Rx Channel No.1-16)
MODEL ID	00111101 3d	MODEL ID (02R)
PARAM TYPE	00tttttt tt	(type number, bit6 = 0(byte operation))
DATA	0ddddddd dd0	address(H) high 7 bits of 14 bits address
	0ddddddd dd1	address(L) low 7 bits of 14 bits address
	0ddddddd dd2	data(H) high 4 bits of 8 bits data(0000dddd)
	0ddddddd dd3	data(L) low 4 bits of 8 bits data(0000dddd)
	:	:
EOX	11110111 F7	End Of Exclusive

You can modify two or more continuous bytes by increasing pairs of "data(H)" and "data(L)".

PARAMETER CHANGE (bit operation for type number 0:edit buffer)		
STATUS	11110000 F0	System Exclusive Message
ID No.	01000011 43	Manufacturer's ID No.(YAMAHA)
SUB STATUS	0001nnnn 1n	n=0-15(Tx/Rx Channel No.1-16)
MODEL ID	00111101 3d	MODEL ID (02R)
PARAM TYPE	01tttttt tt	(type number, bit6 = 1(bit operation))
DATA	0ddddddd dd0	address(H) high 7 bits of 14 bits address
	0ddddddd dd1	address(L) low 7 bits of 14 bits address
	0ddddddd dd2	data(bit0-3:change bit0-7 bit4:0=reset 1=set)
	:	:
	EOX	11110111 F7

You can modify two or more bits in same address data.

PARAMETER CHANGE (recall/store)		
STATUS	11110000 F0	System Exclusive Message
ID No.	01000011 43	Manufacturer's ID No.(YAMAHA)
SUB STATUS	0001nnnn 1n	n=0-15(Tx/Rx Channel No.1-16)
MODEL ID	00111101 3d	MODEL ID (02R)
PARAM TYPE	00011000 18	recall/store (type number)
DATA	0ddddddd dd0	instruction
	0ddddddd dd1	number
	0ddddddd dd2	channel
EOX	11110111 F7	End Of Exclusive

instruction	number	channel		
0x00 scene recall	0-96 (memory 0-96)	0	Tx only	
	0x7e (undo)	0	Tx only	
0x01 eq lib recall	0-127 (library 1-128)	0-15(mic1-16)		
		16-31(tape1-16)		
		32-35(line)		
		36,37(eff1,eff2)		
		38(st mas)		
		0	64-79(undo mic)	Tx only
			80-95(undo tape)	Tx only
			96-99(undo line)	Tx only
			100,101(undo eff)	Tx only
			102(undo st mas)	Tx only
0x02 dynamics lib rcl	0-127 (library 1-128)	0-35,38,39-46(bus,aux)		
		0	64-95,102	Tx only
			103-110(undo bus,aux)	Tx only
0x03 eff lib recall	0-127 (library 1-128)	36,37		
		0	100,101	Tx only
0x04 channel lib rcl	0-63 (library 1-64)	0-37		
		0	64-101	Tx only
0x10 scene store	1-96 (memory 1-96)	0, 62(from host)	Tx only	
		0x7e (undo)	0	Tx only
0x11 eq lib store	32-127 (library 33-128)	0-38,62	Tx only	
		0	64-102	Tx only
0x12 dynamics lib str	40-127 (library 41-128)	0-35,38,39-46,62	Tx only	
		0	64-95,102,103-110	Tx only
0x13 eff lib store	40-127 (library 41-128)	36,37,62	Tx only	
		0	100,101	Tx only
0x14 channel lib str	0-63 (library 1-64)	0-37,62	Tx only	
		0	64-101	Tx only

PARAMETER CHANGE (key remote)		
STATUS	11110000 F0	System Exclusive Message
ID No.	01000011 43	Manufacturer's ID No.(YAMAHA)
SUB STATUS	0001nnnn 1n	n=0-15(Tx/Rx Channel No.1-16)
MODEL ID	00111101 3d	MODEL ID (02R)
PARAM TYPE	00011001 19	key remote (type number)
DATA	0ddddddd dd0	key No.(H) high 7 bits
	0ddddddd dd1	key No.(L) low 7 bits
	0ddddddd dd2	key on(1)/off(0)
EOX	11110111 F7	End Of Exclusive

PARAMETER CHANGE (fader remote)		
STATUS	11110000 F0	System Exclusive Message
ID No.	01000011 43	Manufacturer's ID No.(YAMAHA)
SUB STATUS	0001nnnn 1n	n=0-15(Tx/Rx Channel No.1-16)
MODEL ID	00111101 3d	MODEL ID (02R)
PARAM TYPE	00011001 1A	fader remote (type number)
DATA	0ddddddd dd0	No. (0-20:fader 1-21(st mas) 64-87:encoder tape1-16,rtn1-2,aux,pan,q,f,g,entry)
	0ddddddd dd1	data(fader 0~127/ encoder -64~+63)
EOX	11110111 F7	End Of Exclusive

bus send level control (receive only)		
STATUS	11110000 F0	System Exclusive Message
ID No.	01000011 43	Manufacturer's ID No.(YAMAHA)
SUB STATUS	0001nnnn 1n	n=0-15(Tx/Rx Channel No.1-16)
MODEL ID	00111101 3d	MODEL ID (02R)
PARAM TYPE	00011001 1A	fader remote (type number)
DATA	0ddddddd dd0	33 (bus send level)
	0ccccccc CH	0-15(mic),16-31(tape),32-35(line),36-37(ef)
	00hhhhhh L1	bus1 24bit coefficient
	00hhmmmm L2	bus1
	00mmmmll L3	bus1
	00111111 L4	bus1
	00hhhhhh L1	bus2 24bit coefficient
	00hhmmmm L2	bus2
	00mmmmll L3	
	00111111 L4	bus2
	00hhhhhh L1	bus3 24bit coefficient
	00hhmmmm L2	bus3
	00mmmmll L3	bus3
	00111111 L4	bus3
	00hhhhhh L1	bus4 24bit coefficient
	00hhmmmm L2	bus4
	00mmmmll L3	bus4
	00111111 L4	bus4
	00hhhhhh L1	bus5 24bit coefficient
	00hhmmmm L2	bus5
	00mmmmll L3	bus5
	00111111 L4	bus5
	00hhhhhh L1	bus6 24bit coefficient
	00hhmmmm L2	bus6
	00mmmmll L3	bus6
	00111111 L4	bus6
	00hhhhhh L1	bus7 24bit coefficient
	00hhmmmm L2	bus7
	00mmmmll L3	bus7
	00111111 L4	bus7
	00hhhhhh L1	bus8 24bit coefficient
	00hhmmmm L2	bus8
	00mmmmll L3	bus8

bus send level control (receive only)		
	00111111 L4	bus8
EOX	11110111 F7	End Of Exclusive

surround x,y (receive only)		
STATUS	11110000 F0	System Exclusive Message
ID No.	01000011 43	Manufacturer's ID No.(YAMAHA)
SUB STATUS	0001nnnn 1n	n=0-15(Tx/Rx Channel No.1-16)
MODEL ID	00111101 3d	MODEL ID (02R)
PARAM TYPE	00011001 1A	fader remote (type number)
DATA	0ddddddd dd	32 (surround x, y)
	0xxxxxxx XX	0-127
	0yyyyyyy YY	0-127
	0eeeeeee EE	edit(grab, ch)
EOX	11110111 F7	End Of Exclusive

multiple O2Rs link		
STATUS	11110000 F0	System Exclusive Message
ID No.	01000011 43	Manufacturer's ID No.(YAMAHA)
SUB STATUS	0001nnnn 1n	n=0-15(Tx/Rx Channel No.1-16)
MODEL ID	00111101 3d	MODEL ID (02R)
PARAM TYPE	00011011 1B	multiple link (type number)
DATA	0mmfffff mf	data format
		mm(status)
		= 0 : event command
		4 : setup memory change
		ffff(contents)
		if(mm==0) {
		switch(ffff) {
		case 0x00: scene memory recall
		case 0x01: scene memory store(with title)
		case 0x10: automix memory recall
		case 0x11: automix memory store(with title)
		case 0x14: automix new
		case 0x15: automix undo
		case 0x18: automix transport - AUTO-RECORD
		case 0x19: automix transport - RECORD
		case 0x1A: automix transport - PLAY
		case 0x1B: automix transport - STOP

multiple O2Rs link		
		case 0x1C: automix transport - ABORT
		}
		} else if(mm==4) {
		switch(ffff) {
		case 0x00: setup memory change(byte)
		case 0x08: setup memory change(bit)
		}
		}
	0ddddddd dd0	data #0
	0ddddddd dd1	data #1
	:	:
EOX	11110111 F7	End Of Exclusive

** Scene Memory recall **

DATA 00000000 00 scene memory recall
 0mmmmmmm mm mm=0-96(Scene Memory No.0-96,0x7e)

** Scene Memory store **

DATA 00000001 01 scene memory store
 0mmmmmmm mm mm=0-96(Scene Memory No.0-96,0x7e)
 0ttttttt tt0 memory title #0
 0ttttttt tt1 : #1
 :
 0ttttttt tt16 : #16

** Automix Memory recall **

DATA 00010000 10 automix memory recall
 0mmmmmmm mm mm=0-15(automix Memory No.1-16)

** Automix Memory store **

DATA 00010001 11 automix memory store
 0mmmmmmm mm mm=0-15(automix Memory No.1-16)
 0ttttttt tt0 memory title #0(H)
 0ttttttt tt1 : #0(L)
 0ttttttt tt1 : #1(H)
 :
 0ttttttt tt16 : #16(L)

** Automix new **		
DATA	00010100 14	automix new
** Automix undo **		
DATA	00010101 15	automix undo
** automix transport - AUTO-RECORD **		
DATA	00011000 18	automix transport(AUTO-RECORD)
** automix transport - RECORD **		
DATA	00011001 19	automix transport(RECORD)
** automix transport - PLAY **		
DATA	00011010 1A	automix transport(PLAY)
** automix transport - STOP **		
DATA	00011011 1B	automix transport(STOP)
** automix transport - ABORT **		
DATA	00011100 1C	automix transport(ABORT)
** setup data format **		
DATA	01000000 40	data format
	0ddddddd dd0	address (H) high 7 bits of 14 bits address
	0ddddddd dd1	address (L) low 7 bits of 14 bits address
	0ddddddd dd2	data (H) high 4 bits of 8 bits data (
0000dddd)		
	0ddddddd dd3	data (L) low 4 bits of 8 bits data (0000dddd)
	:	
TX FORMAT	40 1B aa aa	

Bulk Dump and Request Format

The data format is as following. For example, Internal data: ds,d1,d2,...dx,...de(dx is 1byte data).

$$dxH = (dx / 16) \text{ AND } 0Fh, dxL = dx \text{ AND } 0Fh$$

To calculate the check sum: add the data from BYTE COUNT(LOW) to just before the CHECK SUM, multiplying -1 (2's complement), resetting MSB(bit7).

$$\text{check sum} = (-\text{sum}) \& 0x7F$$

Scene Memory Bulk Dump Format		
STATUS	11110000 F0	System Exclusive Message
ID No.	01000011 43	Manufacturer's ID No.(YAMAHA)
SUB STATUS	0000nnnn 0n	n=0-15(Tx/Rx Channel No.1-16)
FORMAT No.	01111110 7E	Universal Bulk Dump
BYTE COUNT (HIGH/LOW)	00011111 1F	4074(2016x2+32+10)bytes
	01101010 6A	
	01001100 4C	'L'
	01001101 4D	'M'
	00100000 20	''
	00100000 20	''
	00111000 38	'8'
	01000001 41	'A'
	00110110 36	'6'
	00110111 37	'7'
DATA NAME	01001101 4D	'M'
	0mmmmmmmm mm	m=0-96,127(Scene Memory No.0-96,current)
DATA	0iiiiiii ii	id 1
	: :	:
	0iiiiiii ii	id 16
	0ttttttt tt	title1
	: :	:
	0ttttttt tt	title16
	0ddddddd dsH	Scene Memory(2016x2bytes)
	0ddddddd dsL	
	: :	
	0ddddddd deH	
0ddddddd deL		
CHECK SUM	0eeeeeee ee	ee=(INVERT('L'+ 'M'+...+dsH+...+deL)+1) AND 7Fh
EOX	11110111 F7	End Of Exclusive

Scene memory receive is effective for programs 1-96 only.

Scene Memory(Extended Data)		
STATUS	11110000 F0	System Exclusive Message
ID No.	01000011 43	Manufacturer's ID No.(YAMAHA)
SUB STATUS	0000nnnn 1n	n=0-15(Tx/Rx Channel No.1-16)
FORMAT NO.	01111110 7E	Universal Bulk Dump
BYTE COUNT(H)	00001100 0C	Total 1546(768*2+10)
BYTE COUNT(L)	00001010 0A	
	01001100 4C	'L'
	01001101 4D	'M'
	00100000 20	''
	00100000 20	''
	00111000 38	'8'
	01000001 41	'A'
	00110110 36	'6'
	00110111 37	'7'
DATA NAME	01001110 4E	'N'
	0mmmmmmm mm	mm=0-96,127(Scene Memory No.0-96,Current)
DATA	0ddddddd dsH	Scene Extended Memory(768*2 byte)
	0ddddddd dsL	
	:	
	0ddddddd deH	
	0ddddddd deL	
CHECK SUM	0eeeeeee ee	ee=(INVERT('L'+ 'M'+...+deL)+1) AND 7Fh
EOX	11110111 F7	End Of Exclusive

Control Change Assign Table		
STATUS	11110000 F0	System Exclusive Message
ID No.	01000011 43	Manufacturer's ID No.(YAMAHA)
SUB STATUS	0000nnnn 1n	n=0-15(Tx/Rx Channel No.1-16)
FORMAT NO.	01111110 7E	Universal Bulk Dump
BYTE COUNT(H)	00000100 03	Total 466(228*2+10)
BYTE COUNT(L)	01001010 52	
	01001100 4C	'L'
	01001101 4D	'M'
	00100000 20	''
	00100000 20	''
	00111000 38	'8'
	01000001 41	'A'

Control Change Assign Table		
	00110110 36	'6'
	00110111 37	'7'
DATA NAME	01000011 43	'C'
		00100000 20
DATA	0ddddddd dsH	Control Change Assign Table(228*2 byte)
	0ddddddd dsL	
	:	
	0ddddddd deH	
	0ddddddd deL	
CHECK SUM	0eeeeeee ee	ee=(INVERT('L'+ 'M'+...+deL)+1) AND 7Fh
EOX	11110111 F7	End Of Exclusive

Scene Memory (compact)		
STATUS	11110000 F0	System Exclusive Message
ID No.	01000011 43	Manufacturer's ID No.(YAMAHA)
SUB STATUS	0000nnnn 1n	n=0-15(Tx/Rx Channel No.1-16)
FORMAT NO.	01111110 7E	Universal Bulk Dump
BYTE COUNT(H)	0hhhhhhh hh	Total size is variable(SIZE+10)
BYTE COUNT(L)	01111111 11	
	01001100 4C	'L'
	01001101 4D	'M'
	00100000 20	''
	00100000 20	''
	00111000 38	'8'
	01000001 41	'A'
	00110110 36	'6'
	00110111 37	'7'
DATA NAME	01101101 6D	'm'
	0mmmmmmm mm	mm=0-96,127(Scene Memory No.0-96,Current)
DATA	0ddddddd dsH	Scene Memory-compact(SIZE byte)
	0ddddddd dsL	(contain Extend Memory)
	:	
	0ddddddd deH	
	0ddddddd deL	
CHECK SUM	0eeeeeee ee	ee=(INVERT('L'+ 'M'+...+deL)+1) AND 7Fh
EOX	11110111 F7	End Of Exclusive

Scene Memory Bulk Dump Request Format		
STATUS	11110000 F0	System Exclusive Message
ID No.	01000011 43	Manufacturer's ID (YAMAHA)
SUB STATUS	0010nnnn 2n	n=0–15(Tx/Rx Channel No.1–16)
FORMAT No.	01111110 7E	Universal Bulk Dump
	01001100 4C	'L'
	01001101 4D	'M'
	00100000 20	''
	00100000 20	''
	00111000 38	'8'
	01000001 41	'A'
	00110110 36	'6'
	00110111 37	'7'
DATA NAME	01001101 4D	'M'
	0mmmmmmmm mm	m=0–96,127(Scene Memory No.0–96,current)
EOX	11110111 F7	End Of Exclusive

Scene memory transmission from the 02R is possible for programs 1–96 only.

Program Change Assignment Table Bulk Dump Format		
STATUS	11110000 F0	System Exclusive Message
ID No.	01000011 43	Manufacturer's ID No.(YAMAHA)
SUB STATUS	0000nnnn 0n	n=0–15(Tx/Rx Channel No.1–16)
FORMAT No.	01111110 7E	Universal Bulk Dump
BYTE COUNT (HIGH/LOW)	00000010 02	266(128x2+10)bytes
	00001010 0A	
	01001100 4C	'L'
	01001101 4D	'M'
	00100000 20	''
	00100000 20	''
	00111000 38	'8'
	01000001 41	'A'
	00110110 36	'6'
	00110111 37	'7'
DATA NAME	01010000 50	'P'
	00100000 20	''

Program Change Assignment Table Bulk Dump Format		
DATA	0ddddddd dsH	Program Change Table(128x2bytes)
	0ddddddd dsL	
	: :	
	0ddddddd deH	
	0ddddddd deL	
CHECK SUM	0eeeeeee ee	ee=(INVERT('L'+ 'M'+...+dsH+...+deL)+1) AND 7Fh
EOX	11110111 F7	End Of Exclusive

Program Change Assignment Table Bulk Dump Request Format		
STATUS	11110000 F0	System Exclusive Message
ID No.	01000011 43	Manufacturer's ID (YAMAHA)
SUB STATUS	0010nnnn 2n	n=0-15(Tx/Rx Channel No.1-16)
FORMAT No.	01111110 7E	Universal Bulk Dump
	01001100 4C	'L'
	01001101 4D	'M'
	00100000 20	''
	00100000 20	''
	00111000 38	'8'
	01000001 41	'A'
	00110110 36	'6'
	00110111 37	'7'
DATA NAME	01010000 50	'P'
	00100000 20	''
EOX	11110111 F7	End Of Exclusive

Setup Memory Bulk Dump Format		
STATUS	11110000 F0	System Exclusive Message
ID No.	01000011 43	Manufacturer's ID No.(YAMAHA)
SUB STATUS	0000nnnn 0n	n=0-15(Tx/Rx Channel No.1-16)
FORMAT No.	01111110 7E	Universal Bulk Dump
BYTE COUNT (HIGH/LOW)	00000000 00	266(128x2+10)bytes
	01101010 6A	

Setup Memory Bulk Dump Format		
	01001100 4C	'L'
	01001101 4D	'M'
	00100000 20	''
	00100000 20	''
	00111000 38	'8'
	01000001 41	'A'
	00110110 36	'6'
	00110111 37	'7'
DATA NAME	01010011 53	'S'
	00100000 20	''
DATA	0ddddddd dsH	Setup Memory(128x2bytes)
	0ddddddd dsL	
	: :	
	0ddddddd deH	
	0ddddddd deL	
CHECK SUM	0eeeeeee ee	ee=(INVERT('L'+ 'M'+...+dsH+...+deL)+1) AND 7Fh
EOX	11110111 F7	End Of Exclusive

Setup Memory (Extended Data)		
STATUS	11110000 F0	System Exclusive Message
ID No.	01000011 43	Manufacturer's ID No.(YAMAHA)
SUB STATUS	0000nnnn 1n	n=0-15(Tx/Rx Channel No.1-16)
FORMAT NO.	01111110 7E	Universal Bulk Dump
BYTE COUNT(H)	00000001 01	Total 138(64*2+10)
BYTE COUNT(L)	00001010 0A	
	01001100 4C	'L'
	01001101 4D	'M'
	00100000 20	''
	00100000 20	''
	00111000 38	'8'
	01000001 41	'A'
	00110110 36	'6'
	00110111 37	'7'
DATA NAME	01010100 54	'T'
	00100000 20	''
DATA	0ddddddd dsH	Setup Extended Memory(64*2 byte)
	0ddddddd dsL	
	:	

Setup Memory (Extended Data)		
	0ddddddd deH	
	0ddddddd deL	
CHECK SUM	0eeeeeee ee	ee=(INVERT('L'+ 'M'+...+deL)+1) AND 7Fh
EOX	11110111 F7	End Of Exclusive

Setup Memory Bulk Dump Request Format		
STATUS	11110000 F0	System Exclusive Message
ID No.	01000011 43	Manufacturer's ID (YAMAHA)
SUB STATUS	0010nnnn 2n	n=0–15(Tx/Rx Channel No.1–16)
FORMAT No.	01111110 7E	Universal Bulk Dump
	01001100 4C	'L'
	01001101 4D	'M'
	00100000 20	''
	00100000 20	''
	00111000 38	'8'
	01000001 41	'A'
	00110110 36	'6'
	00110111 37	'7'
DATA NAME	01010011 53	'S'
	00100000 20	''
EOX	11110111 F7	End Of Exclusive

Effect Library Bulk Dump Format		
STATUS	11110000 F0	System Exclusive Message
ID No.	01000011 43	Manufacturer's ID No.(YAMAHA)
SUB STATUS	0000nnnn 0n	n=0–15(Tx/Rx Channel No.1–16)
FORMAT No.	01111110 7E	Universal Bulk Dump
BYTE COUNT (HIGH/LOW)	00000000 00	72(23x2+16+10)bytes
	01001000 48	
	01001100 4C	'L'
	01001101 4D	'M'
	00100000 20	''
	00100000 20	''
	00111000 38	'8'
	01000001 41	'A'
	00110110 36	'6'
	00110111 37	'7'
DATA NAME	01000101 45	'E'
	0mmmmmmm mm	m=0–127(Effect Library No.1–128)
DATA	0tttttttt tt	title1
	: :	
	0tttttttt tt	title16
	0ddddddd dsH	Effect Library Memory(23x2bytes)
	0ddddddd dsL	
	: :	
	0ddddddd deH	
	0ddddddd deL	
0ddddddd deL		
CHECK SUM	0eeeeeee ee	ee=(INVERT('L'+ 'M'+...+dsH+...+deL)+1) AND 7Fh
EOX	11110111 F7	End Of Exclusive

Effect library receive is effective for programs 41–128 only.

Effect Library Bulk Dump Request Format		
STATUS	11110000 F0	System Exclusive Message
ID No.	01000011 43	Manufacturer's ID (YAMAHA)
SUB STATUS	0010nnnn 2n	n=0–15(Tx/Rx Channel No.1–16)
FORMAT No.	01111110 7E	Universal Bulk Dump

Effect Library Bulk Dump Request Format		
	01001100 4C	'L'
	01001101 4D	'M'
	00100000 20	''
	00100000 20	''
	00111000 38	'8'
	01000001 41	'A'
	00110110 36	'6'
	00110111 37	'7'
DATA NAME	01000101 45	'E'
	0mmmmmmmm mm	m=0-127(Effect Library No.1-128)
EOX	11110111 F7	End Of Exclusive

Effect library transmission from the 02R is possible for programs 41-128 only.

Equalizer Library Bulk Dump Format		
STATUS	11110000 F0	System Exclusive Message
ID No.	01000011 43	Manufacturer's ID No.(YAMAHA)
SUB STATUS	0000nnnn 0n	n=0-15(Tx/Rx Channel No.1-16)
FORMAT No.	01111110 7E	Universal Bulk Dump
BYTE COUNT (HIGH/LOW)	00000000 00	62(18x2+16+10)bytes
	00111110 3e	
	01001100 4C	'L'
	01001101 4D	'M'
	00100000 20	''
	00100000 20	''
	00111000 38	'8'
	01000001 41	'A'
	00110110 36	'6'
	00110111 37	'7'
DATA NAME	01010001 51	'Q'
	0mmmmmmmm mm	m=0-127(Equalizer Library No.1-128)
DATA	0tttttttt tt	title1
	: :	
	0tttttttt tt	title16
	0ddddddd dsH	Equalizer Library Memory(18x2bytes)
	0ddddddd dsL	
	: :	
	0ddddddd deH	
	0ddddddd deL	

Equalizer Library Bulk Dump Format

CHECK SUM	0eeeeeee ee	ee=(INVERT('L'+ 'M'+...+dsH+...+deL)+1) AND 7Fh
EOX	11110111 F7	End Of Exclusive

Equalizer library receive is effective for programs 33–128 only.

Equalizer Library Bulk Dump Request Format

STATUS	11110000 F0	System Exclusive Message
ID No.	01000011 43	Manufacturer's ID (YAMAHA)
SUB STATUS	0010nnnn 2n	n=0–15(Tx/Rx Channel No.1–16)
FORMAT No.	01111110 7E	Universal Bulk Dump
	01001100 4C	'L'
	01001101 4D	'M'
	00100000 20	''
	00100000 20	''
	00111000 38	'8'
	01000001 41	'A'
	00110110 36	'6'
	00110111 37	'7'
DATA NAME	01010001 51	'Q'
	0mmmmmmmm mm	m=0–127(Equalizer Library No.1–128)
EOX	11110111 F7	End Of Exclusive

Equalizer library transmission from the 02R is possible for programs 33–128 only.

Dynamics Library Bulk Dump Format

STATUS	11110000 F0	System Exclusive Message
ID No.	01000011 43	Manufacturer's ID No.(YAMAHA)
SUB STATUS	0000nnnn 0n	n=0–15(Tx/Rx Channel No.1–16)
FORMAT No.	01111110 7E	Universal Bulk Dump
BYTE COUNT (HIGH/LOW)	00000000 00	44(9x2+16+10)bytes
	00101100 2c	
	01001100 4C	'L'
	01001101 4D	'M'
	00100000 20	''
	00100000 20	''
	00111000 38	'8'
	01000001 41	'A'
	00110110 36	'6'
	00110111 37	'7'

Dynamics Library Bulk Dump Format		
DATA NAME	01011001 59	'Y'
	0mmmmmmm mm	m=0-127(Dynamics Library No.1-128)
DATA	0tttttttt tt	title1
	: :	
	0tttttttt tt	title16
	0ddddddd dsH	Dynamics Library Memory(9x2bytes)
	0ddddddd dsL	
	: :	
	0ddddddd deH	
	0ddddddd deL	
CHECK SUM	0eeeeeee ee	ee=(INVERT('L'+ 'M'+...+dsH+...+deL)+1) AND 7Fh
EOX	11110111 F7	End Of Exclusive

Dynamics library receive is effective for programs 41-128 only.

Dynamics Library Bulk Dump Request Format		
STATUS	11110000 F0	System Exclusive Message
ID No.	01000011 43	Manufacturer's ID (YAMAHA)
SUB STATUS	0010nnnn 2n	n=0-15(Tx/Rx Channel No.1-16)
FORMAT No.	01111110 7E	Universal Bulk Dump
	01001100 4C	'L'
	01001101 4D	'M'
	00100000 20	''
	00100000 20	''
	00111000 38	'8'
	01000001 41	'A'
	00110110 36	'6'
	00110111 37	'7'
DATA NAME	01011001 59	'Y'
	0mmmmmmm mm	m=0-127(Dynamics Library No.1-128)
EOX	11110111 F7	End Of Exclusive

Dynamics library transmission from the 02R is possible for programs 41-128 only.

Channel Library Bulk Dump Format		
STATUS	11110000 F0	System Exclusive Message
ID No.	01000011 43	Manufacturer's ID No.(YAMAHA)
SUB STATUS	0000nnnn 0n	n=0-15(Tx/Rx Channel No.1-16)
FORMAT No.	01111110 7E	Universal Bulk Dump

Channel Library Bulk Dump Format		
BYTE COUNT (HIGH/LOW)	00000000 00	122(48x2+16+10)bytes
	01111010 7A	
	01001100 4C	'L'
	01001101 4D	'M'
	00100000 20	''
	00100000 20	''
	00111000 38	'8'
	01000001 41	'A'
	00110110 36	'6'
	00110111 37	'7'
DATA NAME	01001000 48	'H'
	0mmmmmmm mm	m=0-63(Channel Library No.1-64)
DATA	0tttttttt tt	title1
	: :	:
	0tttttttt tt	title16
	0ddddddd dsH	Channel Library Memory(48x2bytes)
	0ddddddd dsL	
	: :	
	0ddddddd deH	
0ddddddd deL		
CHECK SUM	0eeeeeee ee	ee=(INVERT('L'+ 'M'+...+dsH+...+deL)+1) AND 7Fh
EOX	11110111 F7	End Of Exclusive

Channel Library(Extended Data)		
STATUS	11110000 F0	System Exclusive Message
ID No.	01000011 43	Manufacturer's ID No.(YAMAHA)
SUB STATUS	0000nnnn 1n	n=0-15(Tx/Rx Channel No.1-16)
FORMAT NO.	01111110 7E	Universal Bulk Dump
BYTE COUNT(H)	00000000 00	Total 38(14*2+10)
BYTE COUNT(L)	00100110 26	
	01001100 4C	'L'
	01001101 4D	'M'
	00100000 20	''
	00100000 20	''
	00111000 38	'8'
	01000001 41	'A'
	00110110 36	'6'
	00110111 37	'7'

Channel Library(Extended Data)		
DATA NAME	01001001 49	'I'
	0mmmmmmm mm	mm=0-63(Channel Library No.1-64)
DATA	0ddddddd dsH	Channel Library Extended Memory(14*2 byte)
	0ddddddd dsL	
	:	
	0ddddddd deH	
	0ddddddd deL	
CHECK SUM	0eeeeeee ee	ee=(INVERT('L'+ 'M'+...+deL)+1) AND 7Fh
EOX	11110111 F7	End Of Exclusive

Channel Library Bulk Dump Request Format		
STATUS	11110000 F0	System Exclusive Message
ID No.	01000011 43	Manufacturer's ID (YAMAHA)
SUB STATUS	0010nnnn 2n	n=0-15(Tx/Rx Channel No.1-16)
FORMAT No.	01111110 7E	Universal Bulk Dump
	01001100 4C	'L'
	01001101 4D	'M'
	00100000 20	''
	00100000 20	''
	00111000 38	'8'
	01000001 41	'A'
	00110110 36	'6'
	00110111 37	'7'
DATA NAME	01001000 48	'H'
	0mmmmmmm mm	m=0-63(Channel Library No.1-64)
EOX	11110111 F7	End Of Exclusive

Automix Bulk Dump Format		
STATUS	11110000 F0	System Exclusive Message
ID No.	01000011 43	Manufacturer's ID No.(YAMAHA)
SUB STATUS	0000nnnn 0n	n=0-15(Tx/Rx Channel No.1-16)
FORMAT No.	01111110 7E	Universal Bulk Dump
BYTE COUNT (HIGH/LOW)	00010000 10	2078(1024x2+20+10)bytes
	00011110 1e	

Automix Bulk Dump Format		
	01001100 4C	'L'
	01001101 4D	'M'
	00100000 20	''
	00100000 20	''
	00111000 38	'8'
	01000001 41	'A'
	00110110 36	'6'
	00110111 37	'7'
DATA NAME	01000001 41	'A'
	0000mmmm 0m	m=0-15(Automix No.1-16)
DATA	0xxxxxxx xx	block count(High)
	0xxxxxxx xx	block count(Low) [0~size]
	0yyyyyyy yy	total size(High)
	0yyyyyyy yy	total size(Low)[size-1]
	0tttttttt tt	title1
	: :	:
	0tttttttt tt	title16
	0ddddddd dsH	Automix Memory(1024x2bytes)
	0ddddddd dsL	
	: :	
	0ddddddd deH	
0ddddddd deL		
CHECK SUM	0eeeeeee ee	ee=(INVERT('L'+ 'M'+...+dsH+...+deL)+1) AND 7Fh
EOX	11110111 F7	End Of Exclusive

Automix (compact)		
STATUS	11110000 F0	System Exclusive Message
ID No.	01000011 43	Manufacturer's ID No.(YAMAHA)
SUB STATUS	0000nnnn 1n	n=0-15(Tx/Rx Channel No.1-16)
FORMAT NO.	01111110 7E	Universal Bulk Dump
BYTE COUNT(H)	00010000 10	Total 2078(1024*2+20+10)
BYTE COUNT(L)	00011110 1E	
	01001100 4C	'L'
	01001101 4D	'M'
	00100000 20	''
	00100000 20	''
	00111000 38	'8'
	01000001 41	'A'

Automix (compact)		
	00110110 36	'6'
	00110111 37	'7'
DATA NAME	01100001 61	'a'
	0mmmmmmm mm	mm=0-15(Automix No.1-16)
DATA	0ddddddd dsH	Automix Memory-compact(1024*2 byte)
	0ddddddd dsL	
	:	
	0ddddddd deH	
	0ddddddd deL	
CHECK SUM	0eeeeeee ee	ee=(INVERT('L'+M'+...+deL)+1) AND 7Fh
EOX	11110111 F7	End Of Exclusive

Automix Bulk Dump Request Format		
STATUS	11110000 F0	System Exclusive Message
ID No.	01000011 43	Manufacturer's ID (YAMAHA)
SUB STATUS	0010nnnn 2n	n=0-15(Tx/Rx Channel No.1-16)
FORMAT No.	01111110 7E	Universal Bulk Dump
	01001100 4C	'L'
	01001101 4D	'M'
	00100000 20	''
	00100000 20	''
	00111000 38	'8'
	01000001 41	'A'
	00110110 36	'6'
	00110111 37	'7'
DATA NAME	01000001 41	'A'
	0000mmmm 0m	m=0-15(Automix No.1-16)
EOX	11110111 F7	End Of Exclusive

16

Glossary

A/D converter—The conversion of analog signals into digital signals. The analog signal is sampled every few milliseconds and its level is quantized into a digital word. The larger the digital word, the more accurate the representation of the analog value. See *Quantization* and *Sampling frequency*.

The 02R uses 20-bit linear analog-to-digital converters for most of its analog inputs.

Aliasing—A form of distortion which can occur during the conversion of analog signals into digital. If the input signal is more than one half the sampling rate, only portions of the signal will be present when the system samples the waveform. A false image of the waveform, based on the components that were actually sampled, is created.

A system which samples at 48 kHz can correctly process signals of up to 24 kHz. To remove signals above the Nyquist frequency (see *Nyquist Sampling Theorem*), all A/D converters employ anti-aliasing filters. The 02R employs over-sampling A/D converters to allow the anti-aliasing filter to be performed in the digital domain. See *over-sampling*.

Attenuation—After the signal has been converted to digital, the 02R can apply numerous forms of signal processing, such as equalization or effects. Some of these processes may boost the signal to digital clipping. The 02R allows you to attenuate the digital signal to reduce the chances of clipping.

Automix system—The 02R has an on-board Automix system that memorizes fader positions, switches individual channels on or off, adjusts the equalization or pan positions, and changes the auxiliary sends—all based on timecode. It can recall scene memories and programs from the EQ, effects, dynamics, and channel libraries, also determined by the recorded timecode. You can record an entire mixing session, and then edit the individual channel settings in multiple passes. You can punch-in to fine tune a specific parameter or you can use one of the event editors to adjust the timecode position of channel settings or scene and library changes.

Automix Memory—The Automix system records each parameter change and the associated time as an event. The parameters that are recorded include fader movements, channel status and EQ changes, and library recalls. The more complicated the mix, the more memory it consumes. The 02R has a default of 480 kbytes of Automix memory.

Auxiliary send—The auxiliary sends are used to feed signals from the input or tape return channels to external effects processors, amplifiers, or multitrack recording equipment. The 02R has eight auxiliary sends. Two of the sends feed the internal effects processors. See *Internal Effects*.

Bit—A single unit of digital data. It can have a value of 1 or 0.

Bulk Dump—A MIDI function that allow the transfer of system specific data, such as sample files or mixer settings, between MIDI capable devices. The data are transmitted as MIDI System Exclusive messages.

Bus—A circuit that connects the input or tape and effect return signals with the output connectors. The 02R has eight output buses plus the stereo output.

Channel Library—An area in 02R memory used to access and store channel settings—stored as programs. There are 96 user programs for you to store your channel settings.

Compander—A compander is a compressor/expander—a combination of signal compression and expansion. The compander attenuates the input signal above the threshold as well as the level below the width. For very dynamic material, this program allows you to retain the dynamic range without having to be concerned with excessive output signal levels and clipping. See *Dynamics Processor*.

Compressor—A compressor provides a form of automatic level control. It attenuates high levels, thus effectively reducing the dynamic range, making it much easier to control signals and set appropriate fader levels. Reducing the dynamic range also means that recording levels can be set higher, therefore improving the signal-to-noise performance. Limiting is an extreme form of compression, where the output signal is sharply attenuated so that it cannot exceed a particular level. See *Dynamics Processor*.

Confidence monitoring—Listening directly from a recording medium to ensure the program material is being recorded correctly. Most analog recorders have a playback head trailing the record head, allowing you to hear the material directly after it has been recorded. Professional DAT recorders usually have four heads for confidence monitoring, as do a number of the modular digital multitrack recorders. Hard disk recorders offer their own form of confidence monitoring.

D/A converter—The conversion of a digital data stream into analog signals. The digital word is buffered and then converted into an analog signal. After conversion, the analog signal is usually processed through a smoothing filter which removes the step transitions between the digital words. The 02R uses 20-bit linear digital-to-analog converters for most of its analog outputs

DAT cassette—Metal chrome cassette tape (thickness 13µm, width 8.8mm).

Delay—A delay applied to the input signals processed by the 02R to compensate for signal processing delays, for example caused by the gap between the record and playback heads of a multitrack recorder.

Dither—Dithering is a mathematical process where a random noise is added to the least significant bit of a digital word. With very low level signals, the quantization error becomes correlated to the signal level. This creates a measurable amount of distortion. By adding dither, the correlation between the signal level and the quantization error is cancelled, allowing the digital system to encode amplitudes smaller than the least significant bit. If you change the word size as a signal passes from one digital system to another, being able to add dither allows you to maintain a high quality signal.

Digital Signal Processor (DSP)—A specialized circuit, usually a chip, that is designed to manipulate large quantities of data in real-time. YAMAHA has developed world renowned expertise in proprietary musical application specific digital signal processing.

Ducking—Ducking is used to automatically reduce signal levels when the level of a source signal exceeds a specified threshold. It is used for voice-over applications where, for example, level of background music is automatically reduced, allowing an announcer to be heard clearly. See *Dynamics Processor*.

Dynamic range—The difference between the loudest (maximum output level) and quietest (residual noise floor) sounds produced in an audio system. The dynamic range in a digital system is determined by the data resolution, about 6dB per digital bit. A 20-bit system has a theoretical dynamic range of 120 dB. The 02R has a specified dynamic range of 105 dB.

Dynamics Library—An area in 02R memory used to access and store dynamics settings—stored as programs. There are 40 preset programs (1 to 40) for you to recall and 88 user programs (41 to 128) for you to store your own dynamics settings.

Dynamics Processor—Dynamics processors are used to correct or control signal levels. The 02R features comprehensive dynamics processors for all the input channels, tape returns, and the bus and stereo outputs. These processors allow you to compress, expand, compress-expand (compand), gate, or duck the signals passing through the mixer. See *Compander*, *Compressor*, *Ducking*, *Expander*, and *Gate*.

Edit Buffer—The Edit Buffer is the current mix settings. When a scene memory is recalled, the mix settings of the selected scene memory are written to the Edit Buffer. When a scene memory is stored, the mix settings in the Edit Buffer are written to the selected scene memory.

EQ—The 02R is equipped with a four-band, fully parametric EQ, with variable bandwidth (Q), center frequency (F), gain (G), and ON/OFF parameters. equalization can be applied to the input channels, the tape and effect return channels, and the stereo output. For stereo channels, the equalization curve is applied equally to both channels.

EQ Library—An area in 02R memory used to access and store EQ settings—stored as programs. There are 40 preset programs (1 to 40) for you to recall and 88 user programs (41 to 128) for you to store your own EQ settings.

Expander—An expander is another form of automatic level control. By attenuating the signal below the threshold, the expander reduces low-level noise or expands the dynamic range of the recorded material. See *Dynamics Processor*

F (frequency)—The center frequency of an EQ band. See *EQ*.

Fader calibration—The motorized faders occasionally require re-calibration in order to maintain the highest performance possible.

G (gain)—The signal gain of an EQ band. See *EQ*.

Gain and 20dB (pad)—The analog input pre-amplifier controls. These controls are used to optimize the signal from the input connectors. The pad switch is used to reduce the channel gain for line level signals.

Gate—A gate, or noise gate is an audio switch used to mute signals below a set threshold level. It can be used to suppress background noise and hiss from valve (tube) amps, effects pedals, and microphones. See *Dynamics Processor*.

IEC958 Part-2 (Consumer)—A digital interface protocol that is used to transfer digital audio data between consumer-type digital audio equipment such as CD players and DAT, DCC, and Mini Disc recorders. Two channels of digital audio (left/right) are carried on a single line. A coaxial phono/RCA jack connection is typical, but some systems use optical interconnects.

IEC958 Part-3 (AES/EBU—Professional)—A digital interface protocol that is used to transfer digital audio data between professional digital audio equipment such as PCM and DAT mastering recorders, modular multitrack recorders and other equipment. Two channels of digital audio are carried on a single line. An XLR-type connector and a shielded cable is typically used.

Internal Effects—The 02R is equipped with two internal multi-effects stereo processors. These processors have a startling range of special effects available to apply to your mix—shimmering reverbs, clean, precise delays, flanging and chorus, and a myriad of other effects are available.

Metering—The 02R features comprehensive signal level metering. The mono and stereo input channels, the tape and effect returns, and the auxiliary sends and buses are all metered using the METER display function. The control room output is metered using the dedicated 21-segment LED meters. Peak hold is available for all meters.

MIDI implementation—MIDI is an acronym for Musical Instrument Digital Interface. It is an international standard that allows electronic musical instruments to communicate with each other. Because of the complexity of the 02R, it only recognizes MIDI Program Change, Parameter Change, and System Exclusive messages. It uses System Exclusive messages to provide bulk data transfers as well as controller changes. It also reads MTC (MIDI timecode). See *Timecode*.

Modulation—Using a low frequency oscillator (LFO) to control a signal's frequency (pitch) or amplitude (level). The internal effects programs use modulation for a number of their programs. See *Internal Effects*.

Nyquist Sampling Theorem—This theorem defines the process of sampling audio with a digital system. Amongst other things, it states that the sampling frequency of a digital audio system must be at least twice that of the highest audio frequency, otherwise aliasing will occur. The Nyquist theorem was developed at Bell Labs by C. Shannon and H. Nyquist. See *Aliasing*.

over-sampling—The input analog signal is sampled at a much higher rate than the normal sampling rate. Using the high sample rate, the digital data may be processed with a very steep slope digital filter. As the filter is in the digital domain, unpleasant side-effects, such as phase effects are eliminated. The 02R uses 64-times over-sampling for most of its analog inputs and 8-times over-sampling for most of its analog outputs.

PCM—Pulse Code Modulation. A scheme for encoding audio data as a series of pulses. Each pulse defines a transition from binary one to binary zero.

Peaking—An EQ circuit that is used to cut and boost a signal, centered about a specific frequency. Using the bandwidth (Q) parameter, you can widen or narrow the effect of the circuit.

Phase—Phase is the frequency coherence of a signal. If two signals are out of phase, the trough of the first waveform corresponds with the peak of the second, resulting in cancellation. The 02R can reverse the phase of the input signals, which allows you to compensate for incorrectly wired conductors and so forth.

Program Change—A MIDI message that is used to recall programs. On the 02R they recall scene memories.

Q (bandwidth)—The bandwidth of an EQ band. For high values the bandwidth is narrow. For low values, it is wide. See *EQ*.

Quantization—The encoding process when the analog input is approximated (quantized) to the nearest binary value available. In the 20-bit system of the 02R, pulses are approximated to one of 1,048,576 binary values. These approximations are not an exact duplication of the analog waveform and are therefore contain quantization errors (noise). However, this noise is reduced by over-sampling.

RAM (Random Access Memory)—A memory chip that stores data that can be edited and changed. It requires a continuous electrical charge. The 02R scenes memories and other libraries are stored in RAM. An internal backup battery provides the continuous charge. Contrast with *ROM*.

ROM (Read Only Memory)—A memory chip that stores data that cannot be edited. The 02R operating system is stored in ROM. Contrast with *RAM*.

Routing—The process of assigning input or tape and effect returns to the output buses or the stereo bus.

Sampling frequency—The rate at which measurements of an audio signal are taken during A/D and D/A conversion. Once in the digital domain, the data usually remains at the same sampling frequency. The measure is samples per second.

Scene Memory—The 02R scene memories are a memory location used to store a snapshot of virtually all the digital parameters of the mixer. Settings that are not stored consist mainly of monitor controls, analog controls, and switches. The 02R has 96 mix scene memory locations. Each can be named for easy identification.

Shelving—An EQ circuit that is used to cut and boost a signal above or below a specified frequency. High and low band EQs are usually shelving type. The 02R EQ can be configured as shelving or peaking.

Signal to Noise ratio (S/N)—The difference between the nominal signal level and the residual noise floor, usually expressed in decibels.

System Exclusive—A MIDI message that is used to transmit data between MIDI devices that is exclusive to those devices. Bulk dump data can be sent from any device to a MIDI data filer. Controller events are transmitted between 02Rs using System Exclusive messages. See also *Bulk Dump*.

Talkback System—A system that allows the engineer in the control room to talk to the musicians in the studio.

Timecode—Timecode is a signal that contains a chronological record of the absolute time in a recording. It is used for synchronizing different recorders. It can be used for electronic editing. Timecode was initially invented for the motion picture business, as a method of synchronizing the pictures recorded in the frames of a camera to the sound recorded on tape recorder.

The 02R supports three types of timecode, SMPTE timecode, MTC (MIDI timecode), and Internal timecode

White noise—A random noise that contains an equal amount of energy per frequency band. That is, 100–200, 800–900, and 3000–3100. Pink noise has an equal amount of energy per octave. The bands 100–200, 800–1600, and 3000–6000 all contain the same amount of energy.

Word—One sample of audio data. In the 02R, a word is 20-bits.

Wordclock—Wordclock is a sync pulse which allows devices to determine where the start of each digital word is. When multiple digital devices are connected together, it is vital that each device knows where a digital word starts and stops. Otherwise dropout or distortion may result. Although most digital interconnect protocols are self-clocking, it is more reliable to use a dedicated line for your wordclock signal. This is especially important in a multitrack environment where up to eight channels of digital data may be multiplexed on one cable.

References and Further Reading

- *Introducing Digital Audio*, Ian R Sinclair, second edition, PC Publishing, 1992.
- *Practical Recording Techniques*, Bruce and Jenny Bartlett, Sams, 1992.
- *Principles of Digital Audio*, Ken C. Pohlmann, Howard W.Sams & Co, 1989.
- *The Art of Digital Audio*, John Watkinson, Focal Press (Butterworth Group), 1990.
- *The MIDI Ins, Outs & Thrus*, Jeff Rona, Hal Leonard Publishing, 1992.
- *Yamaha Sound Reinforcement Handbook*, Gary Davis and Ralph Jones, second edition, Hal Leonard Publishing Corporation, 1990.

Index

+48V switches 26

02R

block diagram 15

dimensions 248

front panel 2

initializing 215

MIDI remote 171

options 218

rear panel 11

03D

MIDI remote 173

parameter to control change
assign 164

2+2 surround pan 65

20dB pad switches 27

24-bit recording 204

2TR IN ANALOG connectors 12

2TR IN DIGITAL connectors 14

3+1 surround pan 66

3+2+1 surround pan 66

A

ABORT icon, automix 147

AC-3 Dolby 66

ADAT I/O card installation 227

Adding I/O cards 221

AES/EBU

2TR IN DIGITAL connectors 14

channel status monitor 211

emphasis monitor 210

I/O card installation 225

STEREO OUT DIGITAL
connectors 13

Analog I/O card installation 224

Analog input controls 3

Analog inputs 26

Analog outputs 29

ATT 1/1 page 33

Attenuation 32

Auto AUTOMIX Display 198

Auto EQ Display 198

Auto EQ Edit In 201

Auto Inc. TC Capture 202

Automix

about 138

absolute fader edits 152

bulk dump 161

enable 145

END mode 152

event copy 153

making new 150

memory capacity 139

MOTOR ON 151

offset 145

overwrite 146

recalling 148

relative fader edits 151

RET mode 152

storing 148

titling 148

transport controls 147

undo 146

what's stored 138

AUTOMIX 1/7 page 144

AUTOMIX 2/7 page 148

AUTOMIX 3/7 page 151

AUTOMIX 4/7 page 153

AUTOMIX 5/7 page 155

AUTOMIX 6/7 page 156

Automix Store Undo 202

Auto PAN Display 198

AUTO REC icon, automix 147

Auto ROUTING Display 198

Auto SOLO Display 198

Auto WORD CLOCK Display 198

AUX 1/1 page 100

Aux 7/8 pages 106

AUX 7 1/3 page 107

AUX 7 2/3 page 108

AUX 7 3/3 page 109

AUX buttons 19

AUX controls 23

AUX SEND connectors 11

Aux sends

about 98

cascade assign 192

DISPLAY ACCESS buttons 98

on/off 101

output select 203

pairing 184

pre/post fader 101

SELECTED CHANNEL controls
98

stereo input channels 101

using 99

B

Backlight 20

Balance 36

Battery check 213

Block diagram 15

BNC connectors 13

Bulk dump

data format 262

using 161

Bus

analog aux outputs 203

pairing 184

C

Calibrating the faders 215

Capture 155, 156

Cascade

aux bus assign 192

CD8-CS kit 229

configuration 191

ID setting 192

input attenuator 192

MIDI link 232

settings 231

solo 233

CD8-AD analog card 224

CD8-AE AES/EBU card 225

CD8-AE-S AES/EBU card 225

CD8-AT ADAT card 227

CD8-CS cascade kit installation 229

CD8-TDII ADAT card 234

Channel pairs 184

Channel programs

recalling 48

storing 48

titling 48

Channel status monitor 211

CMP, compressor 77

COAXIAL

2TR IN DIGITAL connectors 14

channel status monitor 211

emphasis monitor 210

STEREO OUT DIGITAL
connectors 13

Communication speed 214

Compact Automix Bulk 202

Compact Scene Bulk 202

Compander 80

-
- Compressor 77
 - Condenser mics 26
 - CONFIGURATION buttons 18
 - Connectors
 - 2TR IN ANALOG 12
 - 2TR IN DIGITAL 14
 - AUX SEND 11
 - C-R MONITOR OUT 12
 - input specifications 246
 - INSERT 12
 - METER 13
 - output specifications 247
 - STEREO OUT ANALOG 12
 - STEREO OUT DIGITAL 13
 - STUDIO MONITOR OUT 11
 - TIME CODE INPUT 13
 - TO HOST 13
 - WORD CLOCK 13
 - Consumer format *See* COAXIAL.
 - CONTRAST control 6
 - Control change
 - parameter assign 164
 - receive enable 159
 - CONTROL ROOM buttons 29
 - Copying events 153
 - CPH, compander 80
 - CPS, compander 80
 - C-R LEVEL control 30
 - CR Level to MB02 199
 - C-R MONITOR OUT connectors 12
 - CSR, surround pan 73
 - CURSORS buttons 21
- D**
- DELAY 1/1 page 34
 - DIGITAL I/O 1/5 page 188
 - DIGITAL I/O 2/5 page 190
 - DIGITAL I/O 3/5 page 194
 - DIGITAL I/O 4/5 page 193
 - DIGITAL I/O 5/5 page 191
 - Dimensions 248
 - DIO Warning OFF 199
 - Direct outputs 39
 - Display 20
 - DISPLAY ACCESS buttons 18
 - Display functions 22
 - Dither 193
 - Dolby AC-3 66
 - Dolby Surround 66
 - Double slot cards 218
 - Ducking 81
 - DUK, ducking 81
 - Dynamics
 - about 76
 - curve 85
 - KEY IN 86
 - library 87
 - LINK 86
 - meters 85
 - patching 84
 - programs 76, 90
 - recalling 87
 - storing 87
 - titling 87
 - DYNAMICS 1/2 page 83
 - DYNAMICS 2/2 page 87
- E**
- Echo, MIDI 159
 - Edit buffer 129
 - Editing
 - automix events 153
 - dynamics 83
 - effects 108
 - library recalls 155
 - on/off, pan, faders 156
 - scene recalls 155
 - Effects
 - about 104
 - editing 108
 - library 109
 - programs 105, 112
 - recalling 109
 - sends 106
 - storing 109
 - titling 109
 - Emphasis monitor 210
 - Enable automix 145
 - Encoder wheel 21
 - END mode 152
 - ENTER button 21
 - EQ
 - library 55
 - parameters 52
 - programs 54, 58
 - recalling 55
 - resetting 53
 - resetting the gain 53
 - storing 55
 - titling 55
 - using 51
 - EQ 1/2 page 51
 - EQ 2/2 page 55
 - EQUALIZER controls 24
 - Error messages 251
 - EXP, expander 79
 - Expander 79
 - Extracting events 153
- F**
- Fader Flip Recall Safe 201
 - Faders
 - about 28
 - absolute edits 152
 - automix edit 151
 - calibrating 215
 - fader start 163
 - fade time 136
 - grouping 182
 - MOTOR ON 151
 - off-line event edit 156
 - relative edits 151
 - scene recall safe 135
 - status indicators 99
 - Fader Start 200
 - Fade time 136
 - Fast Meter Fall Time 199
 - Fitting I/O cards 221
 - FLIP button 28
 - Force SUB Boot 200
 - Front panel 2
- G**
- GAIN controls 27
 - GAT, gate 81
 - Gate 81
 - GM tone generator 175
 - GROUP 1/2 page 182
 - GROUP 2/2 page 183
 - Grouping
 - faders 182
 - muters 183
- H**
- High-resolution recording 204
-

I

I/O cards 218
 ADAT 227
 AES/EBU cards 225
 analog card 224
 Tascam 234
 ID setting, cascade 192
 Initial data 129
 Initial Data Nominal 200
 Initializing the 02R 215
 Input channel delay 34
 Input patching 206
 Input signal select 190
 INSERT connectors 12
 Insert Tx Bulk Wait 199
 Installing I/O cards 221
 Internal wordclock 188

K

KEY IN, dynamics 86

L

LCD 20
 Library
 bulk dump 161
 channel 48
 dynamics 87
 editing recall events 155
 effects 109
 EQ 55
 LINK, dynamics 86
 Link Surround Master 202

M

MB02 meter bridge installation 236
 Memory expansion kit, installing 223
 Merging events 153
 METER 1/2 page 41
 METER 2/2 page 41
 METER 3/3 page 42
 Meter bridge
 installing 223
 using 236
 METER connector 13
 Metering 41
 MIDI
 bulk dump 161

cascade link 232
 connectors 13
 control change assign 164
 data format 262
 echo 159
 fader start 163
 MIDI Clock 142
 MIDI remote 165
 MMC 168
 MTC 141
 omni 159
 program change assign 160
 receive channel 159
 supported messages 158
 transmit channel 159
 MIDI 1/5 page 159
 MIDI 2/5 page 160
 MIDI 3/5 page 161
 MIDI 4/5 page 164
 MIDI 5/5 page 166
 MIDI Clock
 counter 145
 using 142
 MIDI remote
 02R 171
 03D 173
 about 165
 configuring 166
 connections 165
 GM tone generator 175
 MMC 168
 Programmable Mixer 01 169
 ProR3 178
 Pro Tools 180
 REV500 178
 XG tone generator 176
 MIDI Warning OFF 200
 MIXING buttons 19
 MIX Update Confirmation 201
 Mono channel inputs 12
 MOTOR ON 151
 Moving events 153
 MS decoding 186
 MTC
 counter 145
 frame rate 145
 input connector 13
 offset 145
 using 141
 Mute buttons 28

Mute grouping 183

N

Naming *See* Titling.
 Noise gate 81
 Note on/off, fader start 163

O

Omni, MIDI 159
 ON buttons 28
 Options 224, 225
 about 218
 ADAT card 227
 cascade kit 229
 I/O cards 218
 meter bridge 236
 specifications 249
 Tascam card 234
 Oscillator 209
 Overwrite mode, automix 146

P

Pad switches 27
 Pages
 ATT 1/1 33
 AUTOMIX 1/7 144
 AUTOMIX 2/7 148
 AUTOMIX 3/7 151
 AUTOMIX 4/7 153
 AUTOMIX 5/7 155
 AUTOMIX 6/7 156
 AUX 1/1 100
 AUX 7 1/3 107
 AUX 7 2/3 108
 AUX 7 3/3 109
 DELAY 1/1 34
 DIGITAL I/O 1/5 188
 DIGITAL I/O 2/5 190
 DIGITAL I/O 3/5 194
 DIGITAL I/O 4/5 193
 DIGITAL I/O 5/5 191
 DYNAMICS 1/2 83
 DYNAMICS 2/2 87
 EQ 1/2 51
 EQ 2/2 55
 GROUP 1/2 182
 GROUP 2/2 183

-
- METER 1/2 41
 - METER 2/2 41
 - METER 3/3 42
 - MIDI 1/5 159
 - MIDI 2/5 160
 - MIDI 3/5 161
 - MIDI 4/5 164
 - MIDI 5/5 166
 - PAIR 1/2 184
 - PAIR 2/2 185
 - PAN 1/1 36
 - PHASE 1/1 33
 - ROUTING 1/2 39
 - ROUTING 2/2 65
 - ROUTING 3/4 67
 - ROUTING 4/4 69
 - SCENE 1/5 131
 - SCENE 2/5 135
 - SCENE 3/5 136
 - SCENE 4/5 206
 - SCENE 5/5 204
 - SETUP 1/4 196
 - SETUP 2/4 203
 - SETUP 3/4 198
 - SETUP 4/4 201
 - UTILITY 1/4 209
 - UTILITY 2/4 210
 - UTILITY 3/4 211
 - UTILITY 4/4 213, 214
 - VIEW 1/2 44
 - VIEW 2/2 48
 - PAIR 1/2 page 184
 - PAIR 2/2 page 185
 - Pairing channels 184
 - Pan
 - controls 24, 38
 - gang 37
 - using 36
 - PAN 1/1 page 36
 - Parameter change
 - data format 262
 - receive enable 159
 - transmit enable 159
 - Peak hold 42
 - PEAK indicators 27
 - Phantom power 26
 - Phase 32
 - PHASE 1/1 page 33
 - PHONES LEVEL control 30
 - PLAY icon, automix 147
 - POWER switch 13
 - Pre EQ Direct Out 199
 - Pre Fader Direct Out 199
 - Preferences 198
 - Presets
 - dynamics programs 90
 - effects programs 105, 112
 - EQ programs 58
 - Program change
 - assign to scene memories 160
 - data format 262
 - receive enable 159
 - transmit enable 159
 - Programmable Mixer 01
 - MIDI remote 169
 - parameter to control change
 - assign 164
 - Programs
 - bulk dump 161
 - channel 48
 - dynamics 76, 90
 - effects 105, 112
 - EQ 54, 58
 - ProR3, MIDI remote 178
 - Protecting scene memories 134
 - Pro Tools, MIDI remote 180
- R**
- Read-only scene memories 129
 - Rear panel 11
 - Recall Confirmation 199
 - Recalling
 - automixes 148
 - channel programs 48
 - dynamics programs 87
 - effects programs 109
 - EQ programs 55
 - scene memories 134
 - Receive channel, MIDI 159
 - REC icon, automix 147
 - REC Recall Safe Faders 201
 - Remote Talkback (C3) 199
 - Restore Last Edit Ch 201
 - RET mode 152
 - REV500, MIDI remote 178
 - Reversing signal phase 32
 - Rotary encoders 28
 - Routing 39
 - ROUTING 1/2 page 39
 - ROUTING 2/2 page 65
 - ROUTING 3/4 page 67
 - ROUTING 4/4 page 69
 - ROUTING buttons 23
 - Rx 02R Link Message 202
- S**
- S/PDIF *See* COAXIAL.
 - Safe, scene recalls 135
 - SCENE 1/5 page 131
 - SCENE 2/5 page 135
 - SCENE 3/5 page 136
 - SCENE 4/5 page 206
 - SCENE 5/5 page 204
 - Scene memories
 - bulk dump 161
 - edit buffer 129
 - editing recall events 155
 - fader recall safe 135
 - fade time 136
 - initial data 129
 - program change assignments
 - 160
 - protecting 134
 - recalling 134
 - storing 130
 - titling 131
 - what's stored 129
 - SCENE MEMORY buttons 21
 - SEL buttons 27
 - SETUP 1/4 page 196
 - SETUP 2/4 page 203
 - SETUP 3/4 page 198
 - SETUP 4/4 page 201
 - Show Compact Size 202
 - SIGNAL indicators 27
 - Single slot cards 218
 - Slate Tone 199
 - Slot output select 194
 - SMPTE
 - counter 145
 - frame rate 145
 - input connector 13
 - offset 145
 - using 140
 - Solo 196
 - SOLO button 30
 - Specifications
 - digital inputs and outputs 247
-

-
- general 240
 - input connections 246
 - inputs 241
 - libraries 245
 - options 249
 - output channels 244
 - output connections 247
 - Stereo channel inputs 12
 - STEREO OUT ANALOG connectors 12
 - STEREO OUT DIGITAL connectors 13
 - Stereo width 37
 - ST LINK 72
 - STOP icon, automix 147
 - Store Confirmation 198
 - Storing
 - automixes 148
 - channel programs 48
 - dynamics programs 87
 - effects programs 109
 - EQ programs 55
 - scene memories 130
 - STUDIO buttons 29
 - STUDIO LEVEL control 30
 - STUDIO MONITOR OUT connectors 11
 - Subwoofer 66
 - Surround CSR Edit 201
 - Surround pan
 - 2+2 mode 65
 - 3+1 mode 66
 - 3+2+1 mode 66
 - about 64
 - CSR 73
 - linking channels 72
 - notes 73
 - output assignments 64
 - panning sounds freely 67
 - selecting modes 65
 - trajectory panning 69
 - Surround SWF Edit 202
 - Surround X, Y Edit 201
- T**
- T/B LEVEL control 30
 - TALKBACK buttons 30
 - Tascam I/O card installation 234
 - TC Drop Warning OFF 199
- Timecode
 - about 140
 - counter 145
 - offset 145
 - TIME CODE INPUT connectors 13
 - Titling
 - automixes 148
 - channel programs 48
 - dynamics programs 87
 - effects programs 109
 - EQ programs 55
 - scene memories 131
 - TO HOST connector 13
 - Touch Sense Edit 201
 - Touch Sense Select 201
 - Trajectories, surround pan 70
 - Transmit channel, MIDI 159
 - Transmit Key Remote 199
 - Transport controls, automix 147
 - Trimming events 153
 - Troubleshooting 250
 - Tx 02R Link Message 202
- U**
- Undo
 - automix 146
 - automix recalls 150
 - channel program recalls 49
 - dynamics program recalls 89
 - effects program recalls 111
 - EQ program recalls 57
 - program change assign 160
 - scene memory 129
 - User interface 18
 - UTILITY 1/4 page 209
 - UTILITY 2/4 page 210
 - UTILITY 3/4 page 211
 - UTILITY 4/4 page 213, 214
- V**
- View 44
 - VIEW 1/2 page 44
 - VIEW 2/2 page 48
- W**
- Wooden side panels, installing 223
 - Wordclock 188
 - WORD CLOCK connectors 13
 - Wordlength 193
- X**
- XG tone generator 176
 - XLR inputs 12
-

Function...		Transmitted	Recognized	Remarks
Basic Channel	Default Changed	1-16 1-16	1-16 1-16	Memorized
Mode	Default Messages Altered	x x *****	OMNI off/OMNI on x x	Memorized
Note Number	: True voice	0 37-44	x x	Fader Start
Velocity	Note ON Note OFF	x x	x x	
After Touch	Key's Ch's	x x	x x	
Pitch Bend		x	x	
Control Change		x	0-95 102-119	
Prog Change	: True #	o 0-127 *****	o 0-127 0-96	*1
System Exclusive		o	o	*2
Common	: Song Pos : Song Sel : Tune	x x x	x x x	
System Real Time	: Clock : Commands	x x	x x	
Aux Messages	: Local ON/OFF : All Notes OFF : Active Sense : Reset	x x o x	x x x x	
Notes	MTC quarter frame message is recognized (MTC IN & MIDI IN) *1 : For program 1-128, memory #0 -#96 is selected. *2 : Bulk Dump/Request and Parameter Change/Request			

Mode 1:OMNI ON,POLY
 Mode 3:OMNI OFF,POLY

Mode 2:OMNI ON,MONO
 Mode 4:OMNI OFF,MONO

o:Yes
 x:No

