



home just add your TV theater

SURROUND SOUND SYSTEM



YHT-900

QUICK-CONNECT GUIDE

INTRODUCTION

Yamaha developed the YHT-900 A/V Home Theater package to turn your home into a theater. In addition to enhancing the sound of a video source, like your TV, DVD, or VCR, the YHT-900 also superbly reproduces audio sources, such as a CD player or a cassette deck.

This Quick-Connect Guide will help you get started. Study the speaker system plan (below), and then use the interconnect diagrams (on the following pages) to connect the receiver, DVD player and speakers to your system.

For the video portion, you will need a television or monitor. Refer to the *Yamaha HTR-5560 Owner's Manual*, as well as those that came with your other components, for complete instructions and cautions. Be sure to turn off all power while making connections.

Save this Quick-Connect Guide for future reference.

NOTE: Label the end of each speaker wire (i.e., left rear, right front, etc.) before connecting them to the A/V receiver. For wire runs over 30 feet, use larger 18- or 16-gauge speaker wire.

TOOLS AND PARTS

The YHT-900 Home Theater package consists of (1) HTR-5560 A/V receiver with (1) universal remote control, (1) DV-C6480 DVD Player, (5) 2-way NS-A580 front/rear speakers, (1) NS-AC580 2-way center-channel speaker, 100' of speaker wire, (1) 0.5 m optical cable, (1) 10' RCA audio cable, (1) YST-SW205 Powered Subwoofer, and related owner's manuals. You will also need:

- Σ Wire strippers (optional)
- Σ Velcro (for secure fastening of NS-AC580 on a TV)
- Σ Brackets, toggle bolts, molly anchor screws, or sheet metal screws (for securing NS-A580 speakers to walls)

NOTE: If you are unsure of how to securely and safely fasten speakers to a wall, please contact a reliable source about the best type of hardware for your particular wall's construction. Secure installation is the purchaser's responsibility.

SPEAKER SYSTEM PLAN

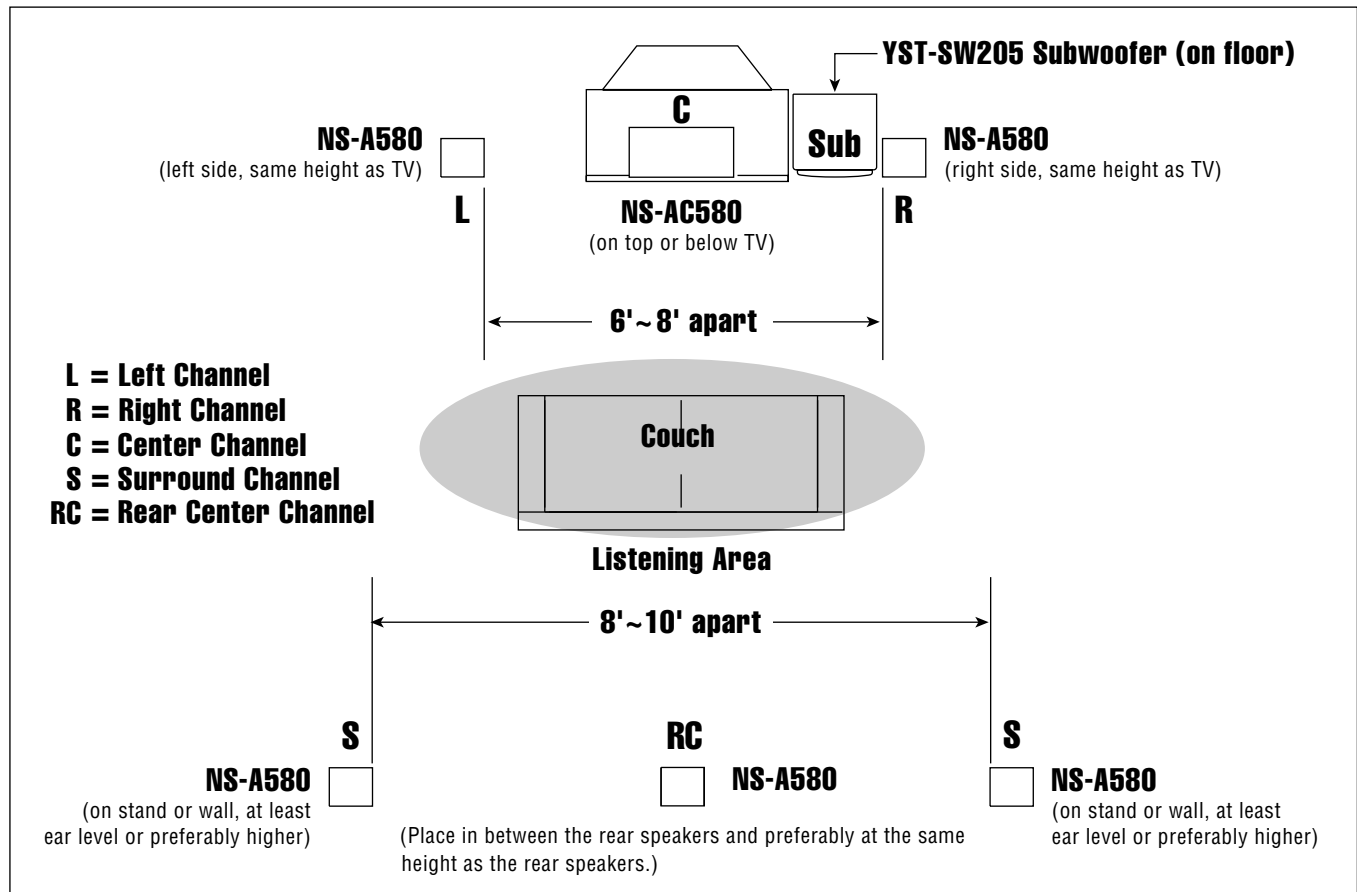

CONNECTING AUDIO COMPONENTS

Yamaha HTR-5560 Receiver (Rear Panel)

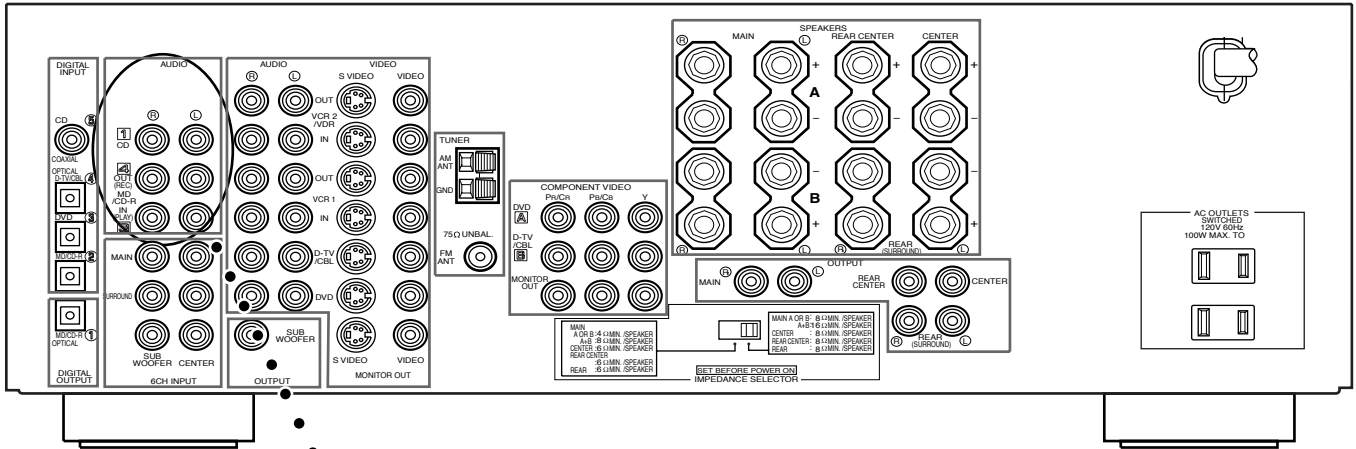

NOTE: For your convenience, the Yamaha HTR-5560 receiver is equipped with two switched AC outlets(100 W max.). If desired, use them to power on connected components (e.g., CD player) each time the receiver is turned on. However, do not use them for components equipped with clocks (e.g., VCR).

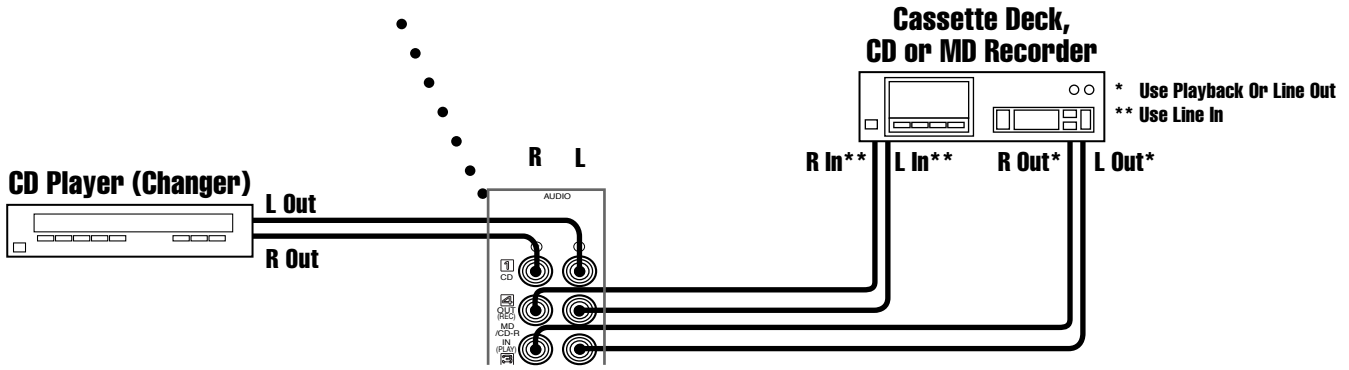

Use RCA Audio Cables For Audio Interconnections

RCA Cable Color Codes
 Yellow = Video
 White = Left Audio
 Red = Right Audio

YAMAHA YHT-900 QUICK-CONNECT GUIDE

CONNECTING THE YHT-900 SPEAKERS

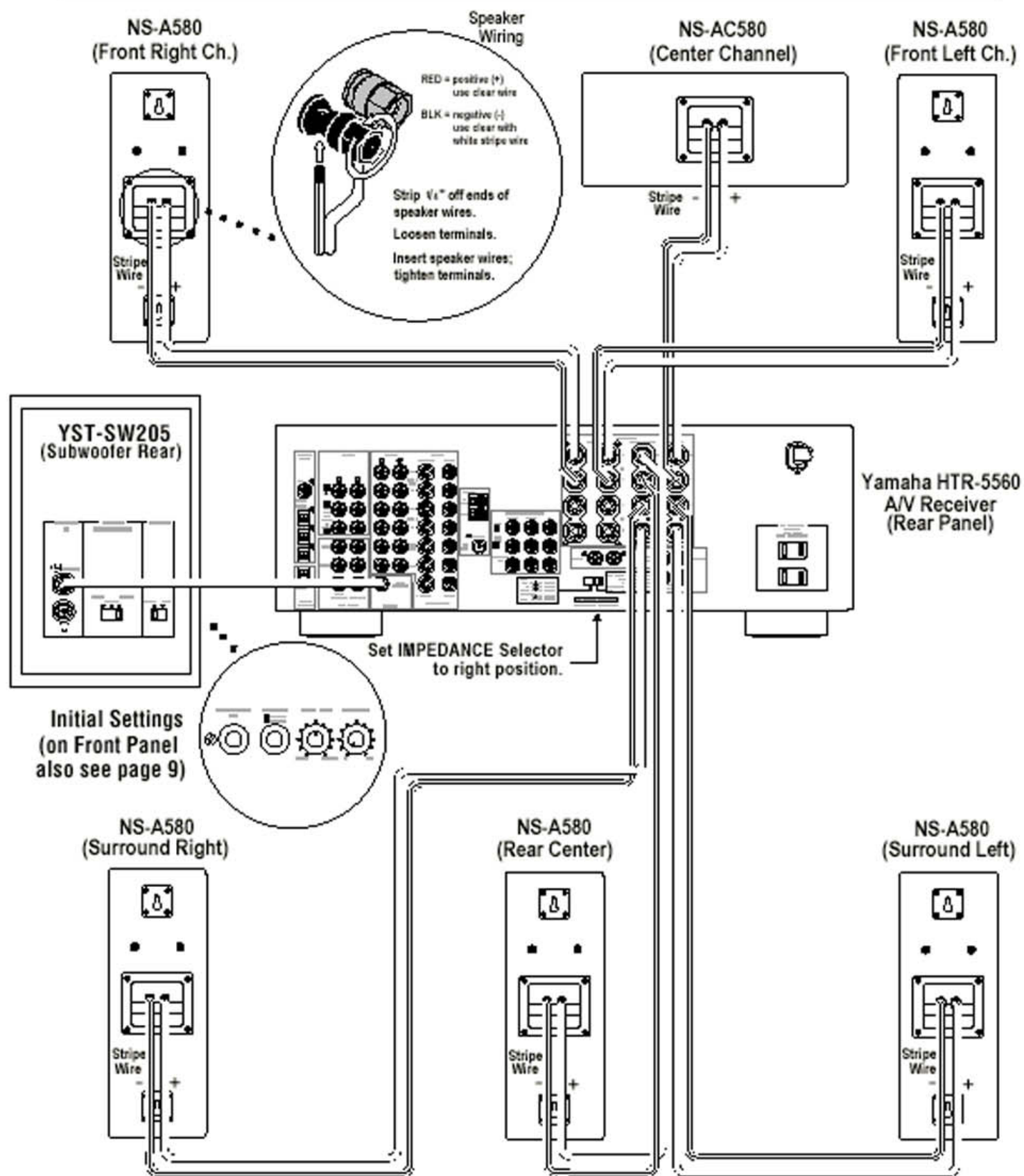

CONNECTING VIDEO CABLES FOR VIDEO COMPONENTS

Yamaha HTR-5560 Receiver (Rear Panel)

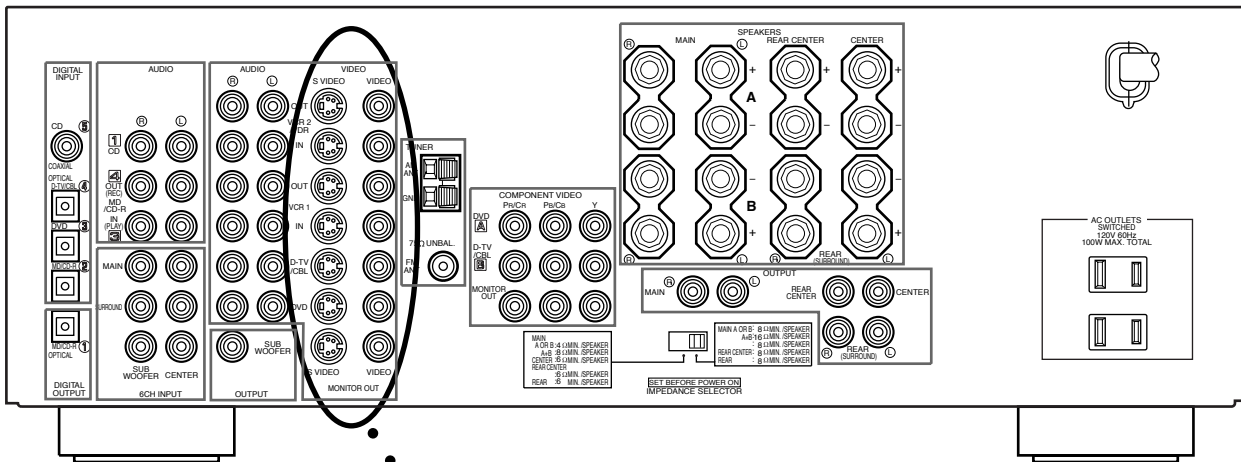

NOTE: When using a hi-fi stereo VCR, set the Tuner/Line switch (on the VCR) to Line position to record from another source connected to the Yamaha HTR-5560 receiver.

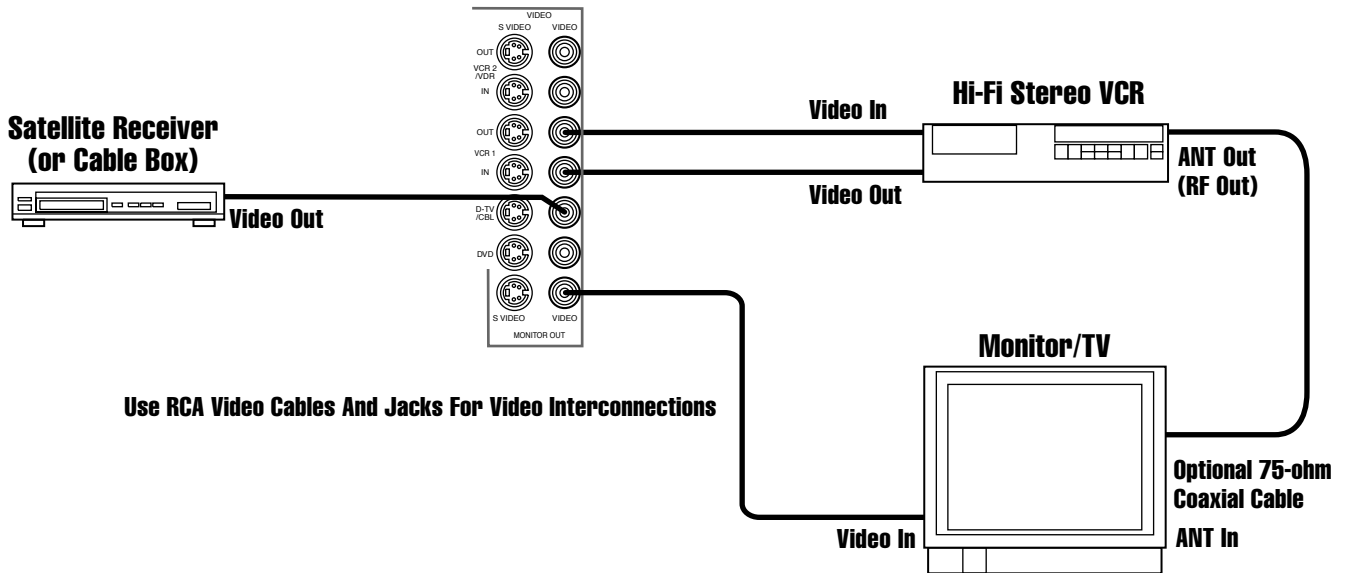

Use RCA Video Cables And Jacks For Video Interconnections

RCA Cable Color Codes
 Yellow = Video
 White = Left Audio
 Red = Right Audio

For S Video Connections, Please Refer To The HTR-5560 Owner's Manual

CONNECTING THE YAMAHA DV-C6480 DVD PLAYER

Yamaha HTR-5560 Receiver (Rear Panel)

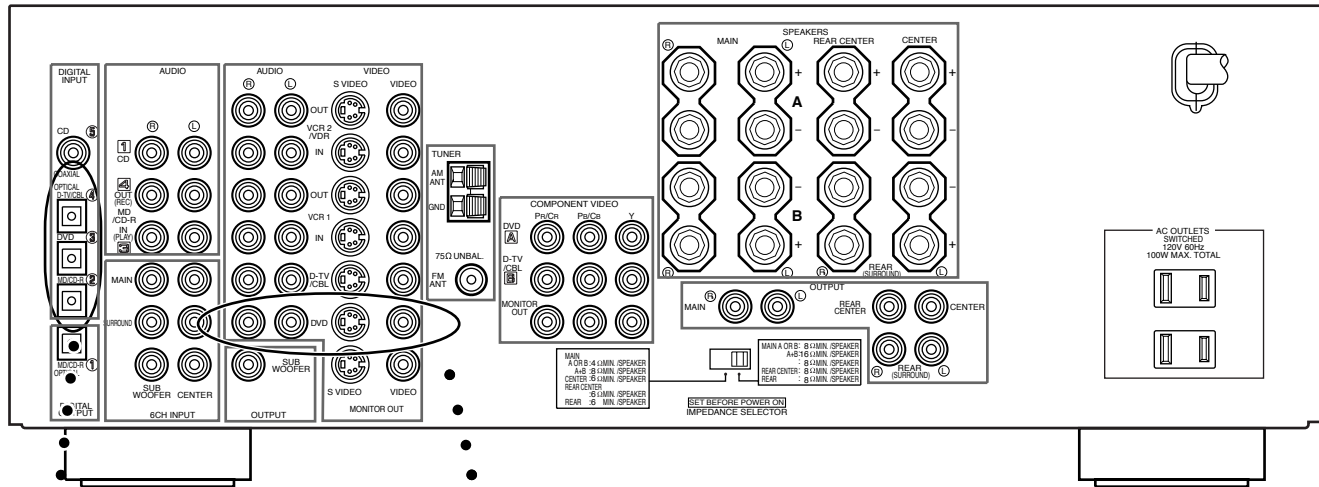

Use the included RCA Cables for Analog and Video Connections Between the DVD Player and Receiver.

Analog Out*



Optical Cable (Included)

Connecting Optical Cable



- Remove dust cap. Align plug with terminal and insert cable.

NOTES:

- On both ends of the optical cable, align and firmly insert each plug into its mating terminal.
- During connection, do not bend the optical cable.
- Keep dust caps and reattach them if terminals are not used.

RCA Cable Color Codes

- Yellow = Video
- White = Left Audio
- Red = Right Audio

NOTE: Use the optical connection to enjoy 5.1 - channel surround sound found on DVDs recorded in the Dolby Digital or DTS Digital Surround format.

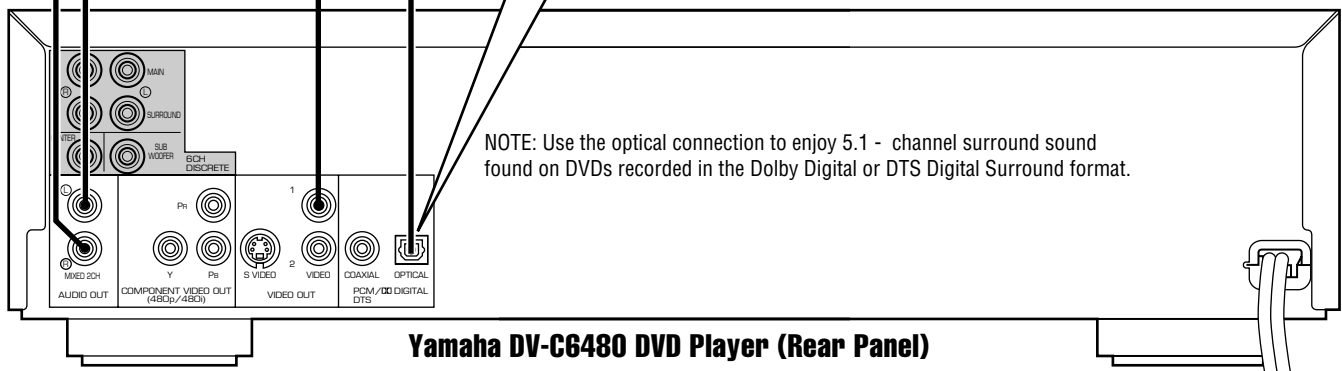

Yamaha DV-C6480 DVD Player (Rear Panel)

*Analog Audio Out connections are required for playback of CD-Rs and recording from DVD to VCR.

Dolby Digital is a trademark of Dolby Laboratories Licensing Corporation.
DTS is a trademark of DTS Technology LLC.

CONNECTING AUDIO CABLES FOR VIDEO COMPONENTS

Yamaha HTR-5560 Receiver (Rear Panel)

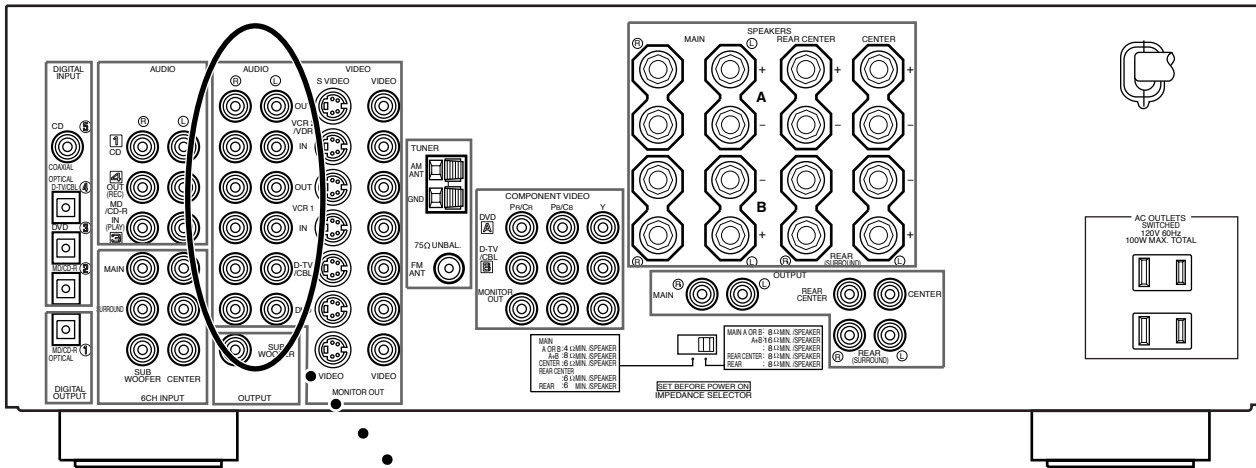

NOTE: When using a hi-fi stereo VCR, set the Tuner/Line switch (on the VCR) to Line position to record from another source connected to the Yamaha HTR-5560 receiver.

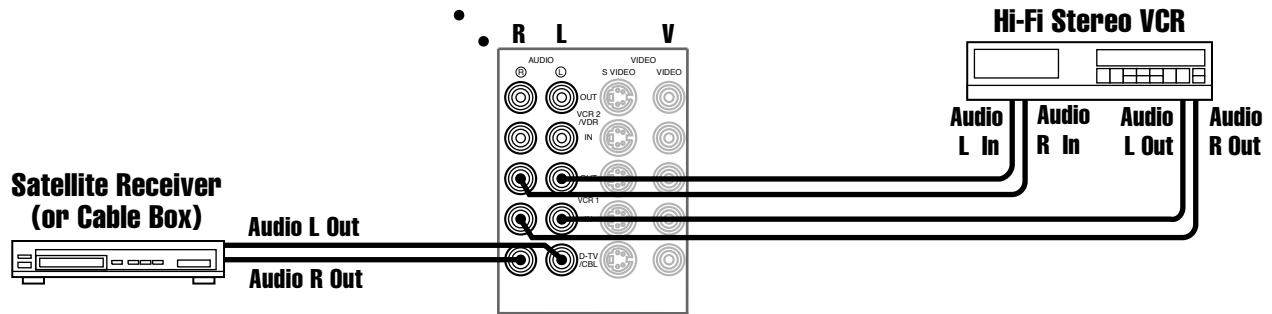

RCA Cable Color Codes
 Yellow = Video
 White = Left Audio
 Red = Right Audio

Use RCA Audio Cables And Jacks For Audio Interconnections

CABLE HOOK-UP (BASIC AND PREMIUM CHANNELS)

Yamaha HTR-5560 Receiver (Rear Panel)

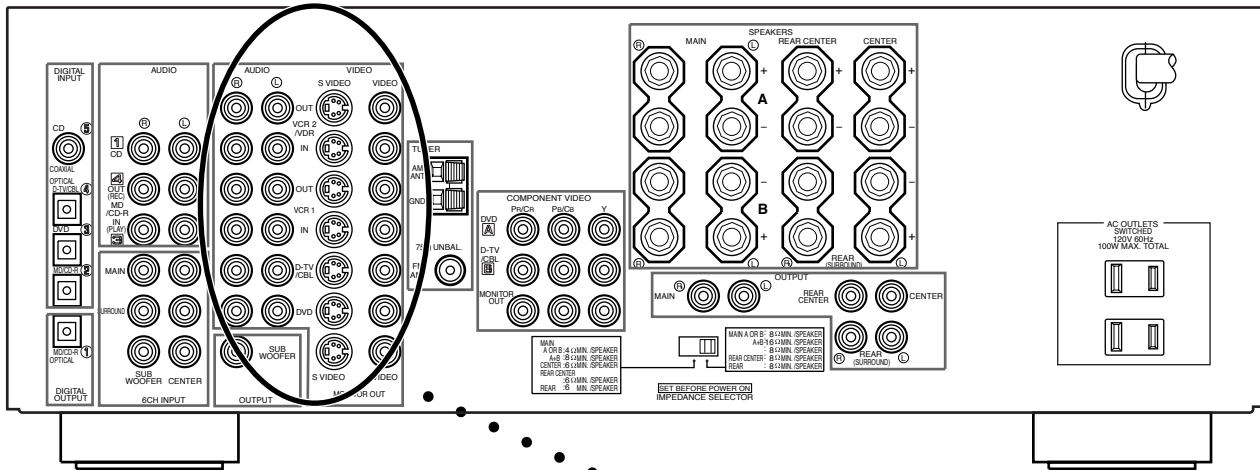

NOTE: When using a hi-fi stereo VCR, set the Tuner/Line switch (on the VCR) to Line position to record from another source connected to the Yamaha HTR-5560 receiver.

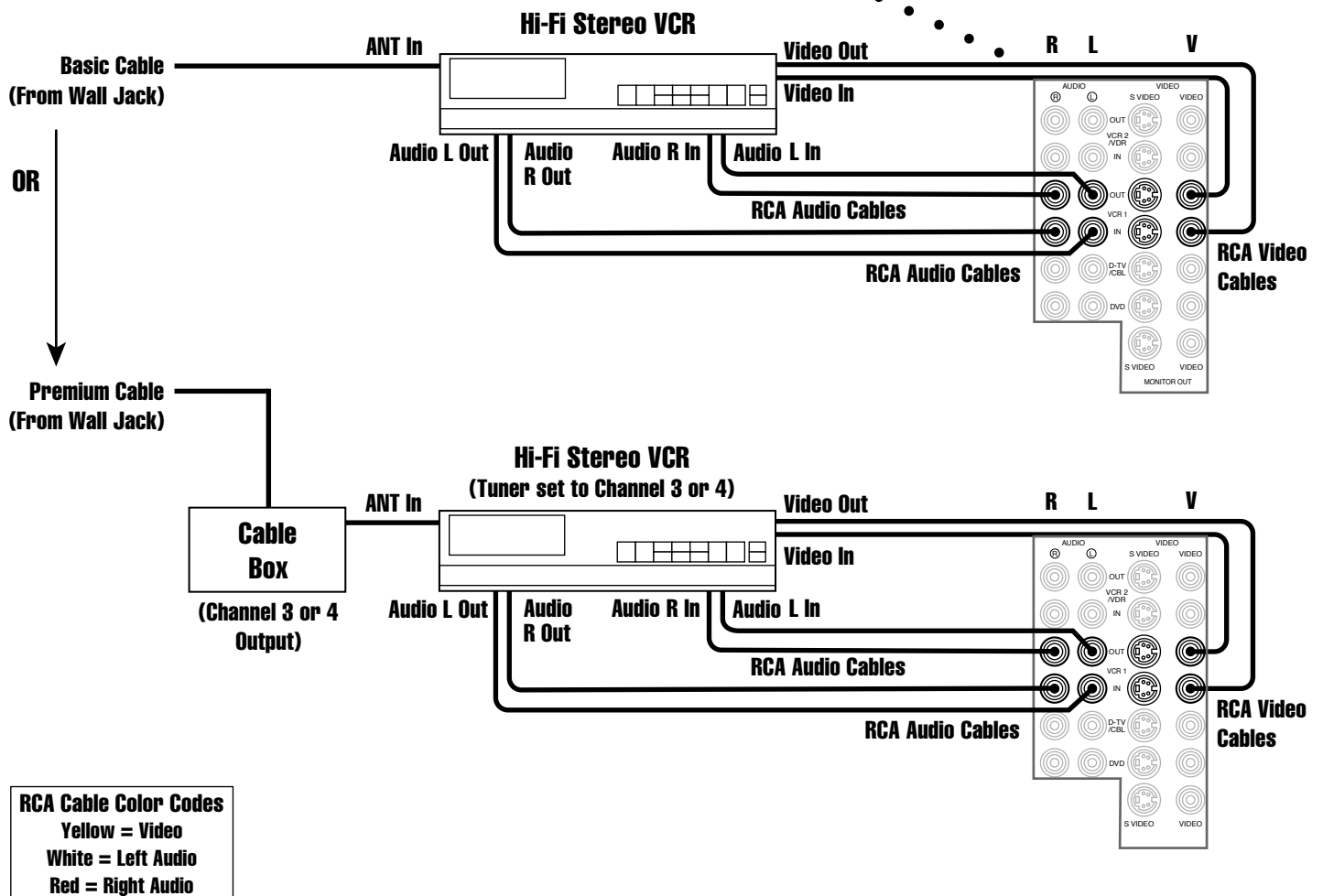

INITIAL ADJUSTMENT OF THE YST-SW205 SUBWOOFER

To achieve optimum volume balance between the YST-SW205 Subwoofer and the NS-A580 Main Speakers, perform the following procedure:

1. Insert the YST-SW205's power plug into an AC outlet.
2. On the YST-SW205's rear panel, set the POWER switch to the ON position and the AUTO STANDBY to HIGH.
3. Set the PHASE switch to the NORM position.
4. On the YST-SW205's front panel, set the VOLUME control to 0 (minimum setting), the HIGH CUT control to its midpoint position, and the B.A.S.S. button to the MUSIC position, for audio software (CD's) bass sound, or MOVIE position for best video bass sound.



Press the STANDBY/ON button to the on position. The indicator light will light up green. Then power on all other components.

5. Play an audio source and adjust the HTR-5560's VOLUME control to a desired listening level.
6. On the YST-SW205's front panel, increase the VOLUME control gradually to adjust the balance the volume between the YST-SW205 Subwoofer and the NS-A580 Main Speakers.

NOTE: Once the volume is balanced between the subwoofer and the main speakers, you can adjust the volume of your whole sound system by using the HTR-5560's VOLUME control.

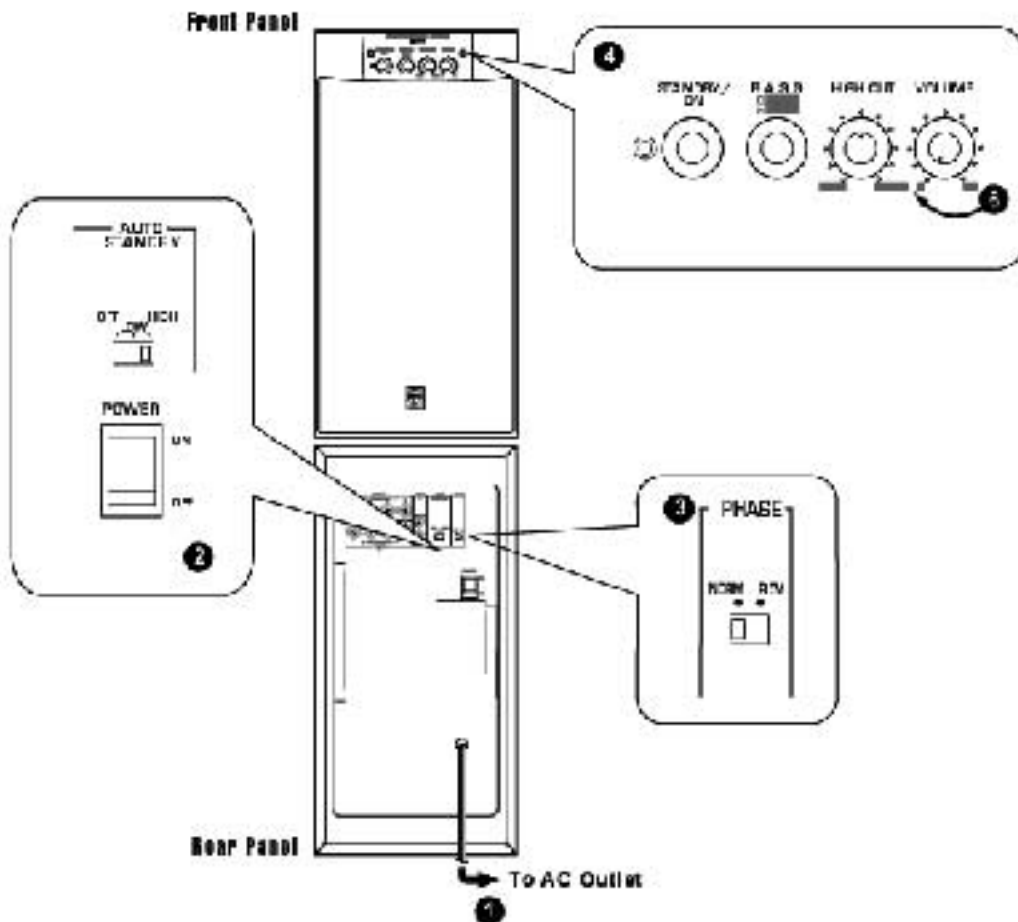

PROGRAMMING THE UNIVERSAL REMOTE CONTROL

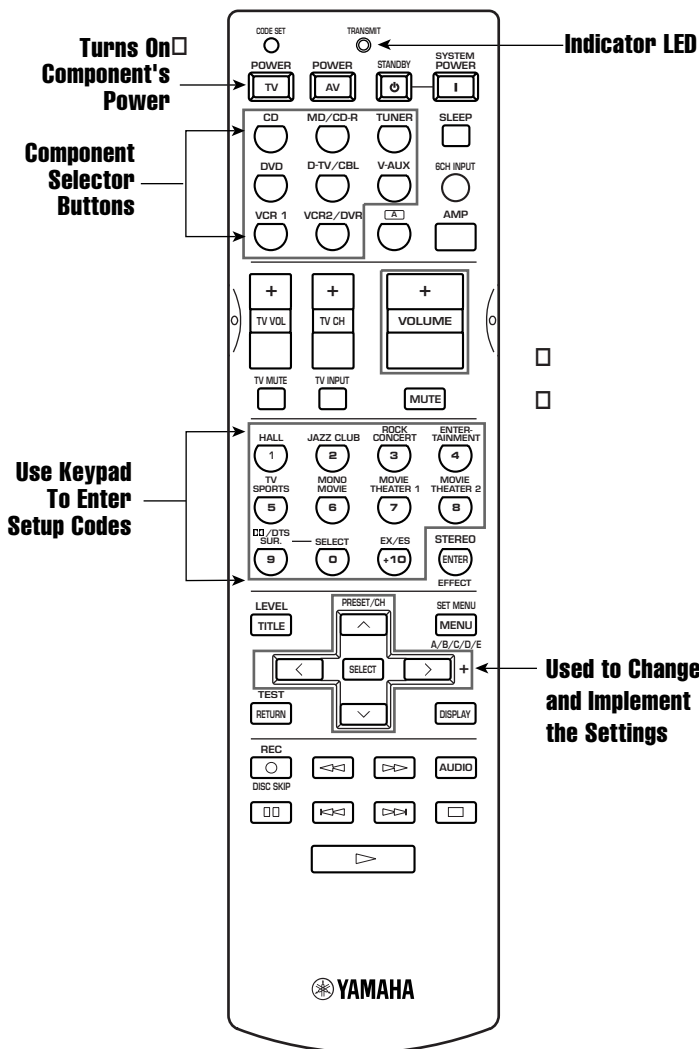

SETTING UP COMPONENTS

Perform the procedure for each component you own. At the end of each step 5, the remote control's processor will automatically assign the selected component's control functions to its own buttons, ready for your use.

SETTING UP YOUR TV

1. Turn on the television set and look up a setup code for your brand of television (codes are located at the back of the *HTR-5560 Owner's Manual*).
2. On the remote control, press button A.

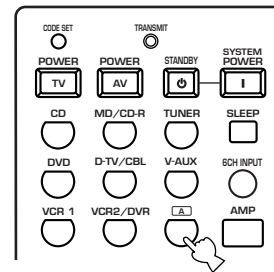

3. Press CODE SET using a ballpoint pen or similar object. The TRANSMIT indicator LED will flash twice.

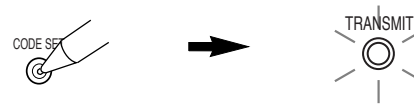

4. Using the keypad, enter the four-digit setup code. The indicator LED will flash twice after your entry. If the LED did not flash twice, repeat steps 3 and 4.

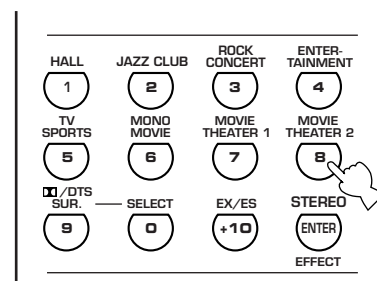

NOTE: If you wait more than 30 seconds during step 4, the process will be canceled. If this happens, start from Step 2.

The YHT-900 Home Theater package includes a universal remote control. It comes pre-programmed with factory codes to control your HTR-5560 receiver and most Yamaha audio components. To program other brands of components (i.e., TV, VCR, etc.) or if your Yamaha unit does not respond, you will need to program the remote control with the manufacturer's codes (listed on the back pages of the *HTR-5560 Owner's Manual*).

NOTE: The universal remote control is designed to control most major brands of audio and video components. For other units, use the original remote control supplied with the product.

POWER ON

1. Load the supplied batteries into the remote control.
2. Aim the remote control at the receiver, press the SYSTEM POWER button.
3. The receiver should turn on.

5. To verify the code works, aim the remote control at the television set, press the TV POWER button. The television set should turn off. If it doesn't respond, use another code for the same manufacturer and repeat steps 3 through 5.

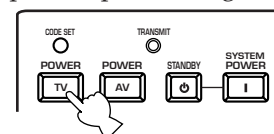

PROGRAMMING THE UNIVERSAL REMOTE CONTROL (CONTINUED)

SETTING UP YOUR CABLE BOX (OR DSS)

1. Turn on the cable box (or DSS) and look up a setup code for your brand of cable box (or DSS) (codes are located at the back of the HTR-5560 Owner's Manual).
2. On the remote control, press D-TV/CBL.

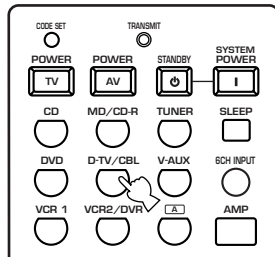

3. Press CODE SET using a ballpoint pen or similar object. The TRANSMIT indicator LED will flash twice.
4. Using the keypad, enter the four-digit setup code. The indicator LED will flash twice after your entry. If the LED did not flash twice, repeat steps 3 and 4.
5. To verify the code works, aim the remote control at the cable box (or DSS), press D-TV/CBL, and then press AV POWER. The unit should turn off. If it doesn't respond, use another code for the same manufacturer and repeat steps 3 through 5.

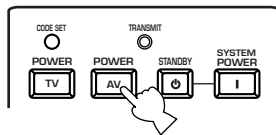

SETTING UP YOUR VCR

1. Turn on the VCR and look up a setup code for your brand of VCR.
2. On the remote control, press VCR 1.

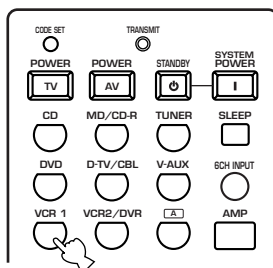

3. Press CODE SET using a ballpoint pen or similar object. The TRANSMIT indicator LED will flash twice.
4. Using the keypad, enter the four-digit setup code. The indicator LED will flash twice after your entry. If the LED did not flash twice, repeat steps 3 and 4.

SETTING UP OTHER COMPONENTS

1. Turn on the component (e.g. CD player, tape deck, or MD player) and look up a setup code for your brand of component.
2. On the remote control, press the desired component button (e.g., CD or MD/CD-R).
3. Press CODE SET using a ballpoint pen or similar object. The TRANSMIT indicator LED will flash twice.
4. Using the keypad, enter the four-digit setup code. The indicator LED will flash twice after your entry. If the LED did not flash twice, repeat steps 3 and 4.
5. To verify the code works, aim the remote control at the component, press the appropriate component button, and then press AV POWER. The unit should turn off. If it doesn't respond, use another code for the same manufacturer and repeat steps 3 through 5.

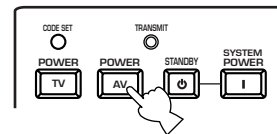

NOTE: Your component's original remote control must have a power On/Off function in order for this remote to control your component's power function.

OPERATING THE UNIVERSAL REMOTE CONTROL

OVERVIEW

The universal remote control will control up to nine different types of components each of which becomes active when you press a selection (except TV which has priority and TV function buttons are always active). We can only briefly describe some functions here, and we encourage you use the *HTR-5560 Owner's Manual* to gain additional experience with this powerful unit.

PLAYING A VIDEOCASSETTE

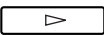
1. Aim the remote control at the HTR-5560, press SYSTEM POWER to turn the receiver on. Press VCR 1 as the input for the receiver.
2. Aim the remote control at the TV, press the TV POWER to turn the television on.
3. Aim the remote control at the VCR, press VCR 1 to select the component, and then press AV POWER to turn the VCR on. Put a tape in the VCR, press  (forward button) to start play.

NOTE: At this point, the VCR controls are assigned to the remote control, since VCR was the last selected component.

PLAYING A DVD

1. Aim the remote control at the the HTR-5560, press SYSTEM POWER to turn the receiver on. Press DVD as the input for the receiver.
2. Then press AV POWER to turn the DVD player on.

NOTE: If the DVD player is plugged into the switched outlet (on the back of the receiver) and its power AC was already engaged, the unit will come on each time the receiver is powered on.

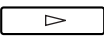
3. Load a DVD into the DVD player.
4. Aim the remote control at the DVD player, and press  (forward button) to start play.

NOTE: The DVD player's controls are now assigned to the remote control buttons, since DVD was the last selected component.

RESETTING THE REMOTE CONTROL TO FACTORY CODES

You can reset the remote control to factory codes for all components or a desired component, as follows:

RESETTING CODES FOR ALL COMPONENTS

1. Press any component selector.
2. Press CODE SET using a ballpoint pen or similar object. The TRANSMIT indicator LED will flash twice.
3. Using the keypad, enter the code "9990".
4. The indicator LED will flash twice to confirm all codes have been reset to factory values. If the LED does not flash twice, repeat steps 1 through 3.

RESETTING CODES FOR A DESIRED COMPONENT

1. Press a component selector button that matches the component you wish to reset to factory codes.
2. Press CODE SET. The TRANSMIT indicator LED will flash twice.
3. Using the keypad, enter the code "0000".
4. The indicator LED will flash twice to confirm all codes have been reset to factory values. If the LED does not flash twice, repeat steps 1 through 3.
5. For your convenience, the following reference chart lists the factory codes:

Component Selector Button	Component	Code
CD	CD	0005 Yamaha
MD/CD-R	MD	0024 Yamaha
TUNER	TUNER	0003 Yamaha
DVD	DVD	0098 Yamaha