



P-90

ENGLISH

DEUTSCH

FRANÇAIS

ESPAÑOL

**Owner's Manual
Bedienungsanleitung
Mode d'emploi
Manual de instrucciones**

ELECTRONIC PIANO

SPECIAL MESSAGE SECTION

This product utilizes batteries or an external power supply (adapter). DO NOT connect this product to any power supply or adapter other than one described in the manual, on the name plate, or specifically recommended by Yamaha.

WARNING: Do not place this product in a position where anyone could walk on, trip over, or roll anything over power or connecting cords of any kind. The use of an extension cord is not recommended! IF you must use an extension cord, the minimum wire size for a 25' cord (or less) is 18 AWG. NOTE: The smaller the AWG number, the larger the current handling capacity. For longer extension cords, consult a local electrician.

This product should be used only with the components supplied or; a cart, rack, or stand that is recommended by Yamaha. If a cart, etc., is used, please observe all safety markings and instructions that accompany the accessory product.

SPECIFICATIONS SUBJECT TO CHANGE:

The information contained in this manual is believed to be correct at the time of printing. However, Yamaha reserves the right to change or modify any of the specifications without notice or obligation to update existing units.

This product, either alone or in combination with an amplifier and headphones or speaker/s, may be capable of producing sound levels that could cause permanent hearing loss. DO NOT operate for long periods of time at a high volume level or at a level that is uncomfortable. If you experience any hearing loss or ringing in the ears, you should consult an audiologist.

IMPORTANT: The louder the sound, the shorter the time period before damage occurs.

Some Yamaha products may have benches and / or accessory mounting fixtures that are either supplied with the product or as optional accessories. Some of these items are designed to be dealer assembled or installed. Please make sure that benches are stable and any optional fixtures (where applicable) are well secured BEFORE using.

Benches supplied by Yamaha are designed for seating only. No other uses are recommended.

NOTICE:

Service charges incurred due to a lack of knowledge relating to how a function or effect works (when the unit is operating as designed) are not covered by the manufacturer's warranty, and are therefore the owners responsibility. Please study this manual carefully and consult your dealer before requesting service.

ENVIRONMENTAL ISSUES:

Yamaha strives to produce products that are both user safe and environmentally friendly. We sincerely believe that our products and the production methods used to produce them, meet these goals. In keeping with both the letter and the spirit of the law, we want you to be aware of the following:

Battery Notice:

This product MAY contain a small non-rechargeable battery which (if applicable) is soldered in place. The average life span of this type of battery is approximately five years. When replacement becomes necessary, contact a qualified service representative to perform the replacement.

This product may also use "household" type batteries. Some of these may be rechargeable. Make sure that the battery being charged is a rechargeable type and that the charger is intended for the battery being charged.

When installing batteries, do not mix batteries with new, or with batteries of a different type. Batteries MUST be installed correctly. Mismatches or incorrect installation may result in overheating and battery case rupture.

Warning:

Do not attempt to disassemble, or incinerate any battery. Keep all batteries away from children. Dispose of used batteries promptly and as regulated by the laws in your area. Note: Check with any retailer of household type batteries in your area for battery disposal information.

Disposal Notice:

Should this product become damaged beyond repair, or for some reason its useful life is considered to be at an end, please observe all local, state, and federal regulations that relate to the disposal of products that contain lead, batteries, plastics, etc. If your dealer is unable to assist you, please contact Yamaha directly.

NAME PLATE LOCATION:

The name plate is located on the bottom of the product. The model number, serial number, power requirements, etc., are located on this plate. You should record the model number, serial number, and the date of purchase in the spaces provided below and retain this manual as a permanent record of your purchase.

Model

Serial No.

Purchase Date

PLEASE KEEP THIS MANUAL

PRECAUTIONS

PLEASE READ CAREFULLY BEFORE PROCEEDING

* Please keep this manual in a safe place for future reference.

WARNING

Always follow the basic precautions listed below to avoid the possibility of serious injury or even death from electrical shock, short-circuiting, damages, fire or other hazards. These precautions include, but are not limited to, the following:

Power supply/AC power adaptor

- Only use the voltage specified as correct for the instrument. The required voltage is printed on the name plate of the instrument.
- Use the specified adaptor (PA-3C or an equivalent recommended by Yamaha) only. Using the wrong adaptor can result in damage to the instrument or overheating.
- Check the electric plug periodically and remove any dirt or dust which may have accumulated on it.
- Do not place the AC adaptor cord near heat sources such as heaters or radiators, and do not excessively bend or otherwise damage the cord, place heavy objects on it, or place it in a position where anyone could walk on, trip over, or roll anything over it.

Do not open

- Do not open the instrument or attempt to disassemble the internal parts or modify them in any way. The instrument contains no user-serviceable parts. If it should appear to be malfunctioning, discontinue use immediately and have it inspected by qualified Yamaha service personnel.

Water warning

- Do not expose the instrument to rain, use it near water or in damp or wet conditions, or place containers on it containing liquids which might spill into any openings.
- Never insert or remove an electric plug with wet hands.

Fire warning

- Do not put burning items, such as candles, on the unit. A burning item may fall over and cause a fire.

If you notice any abnormality

- If the AC adaptor cord or plug becomes frayed or damaged, or if there is a sudden loss of sound during use of the instrument, or if any unusual smells or smoke should appear to be caused by it, immediately turn off the power switch, disconnect the adaptor plug from the outlet, and have the instrument inspected by qualified Yamaha service personnel.

CAUTION

Always follow the basic precautions listed below to avoid the possibility of physical injury to you or others, or damage to the instrument or other property. These precautions include, but are not limited to, the following:

Power supply/AC power adaptor

- When removing the electric plug from the instrument or an outlet, always hold the plug itself and not the cord.
- Unplug the AC power adaptor when not using the instrument, or during electrical storms.
- Do not connect the instrument to an electrical outlet using a multiple-connector. Doing so can result in lower sound quality, or possibly cause overheating in the outlet.

Location

- Do not expose the instrument to excessive dust or vibrations, or extreme cold or heat (such as in direct sunlight, near a heater, or in a car during the day) to prevent the possibility of panel disfiguration or damage to the internal components.
- Do not use the instrument in the vicinity of a TV, radio, stereo equipment, mobile phone, or other electric devices. Otherwise, the instrument, TV, or radio may generate noise.
- Do not place the instrument in an unstable position where it might accidentally fall over.
- Before moving the instrument, remove all connected adaptor and other cables.
- Use only the stand specified for the instrument. When attaching the stand or rack, use the provided screws only. Failure to do so could cause damage to the internal components or result in the instrument falling over.
- Do not place objects in front of the instrument's air vent, since this may prevent adequate ventilation of the internal components, and possibly result in the instrument overheating.

(3)-7 1/2

Connections

- Before connecting the instrument to other electronic components, turn off the power for all components. Before turning the power on or off for all components, set all volume levels to minimum. Also, be sure to set the volumes of all components at their minimum levels and gradually raise the volume controls while playing the instrument to set the desired listening level.

Maintenance

- When cleaning the instrument, use a soft, dry cloth. Do not use paint thinners, solvents, cleaning fluids, or chemical-impregnated wiping cloths.

Handling caution

- Never insert or drop paper, metallic, or other objects into the gaps on the panel or keyboard. If this happens, turn off the power immediately and unplug the power cord from the AC outlet. Then have the instrument inspected by qualified Yamaha service personnel.
- Do not place vinyl, plastic or rubber objects on the instrument, since this might discolor the panel or keyboard.
- Do not rest your weight on, or place heavy objects on the instrument, and do not use excessive force on the buttons, switches or connectors.
- Do not operate the instrument for a long period of time at a high or uncomfortable volume level, since this can cause permanent hearing loss. If you experience any hearing loss or ringing in the ears, consult a physician.

Saving data

Saving and backing up your data

- Depending upon the Backup Functions (page 42) settings, internal data is retained for about 1 week after the power is turned off. If the period is exceeded, the data will be lost. Be sure to turn the power switch on for a few minutes at least once a week. The data could be lost due to malfunction or incorrect operation. Save important data to external media such as the Yamaha MDF3 MIDI data filer.

Backing up the external media

- To protect against data loss through media damage, we recommend that you save your important data onto two external media.

Yamaha cannot be held responsible for damage caused by improper use or modifications to the instrument, or data that is lost or destroyed.

Always turn the power off when the instrument is not in use.

Even when the power switch ([STANDBY/ON] switch) is in the "STANDBY" position, electricity is still flowing to the instrument at the minimum level. When you are not using the instrument for a long time, make sure you unplug the AC power adaptor from the wall AC outlet.

Make sure to discard used batteries according to local regulations.

Table of Contents

Accessories	6	Detailed Settings – [FUNCTION]	32
Application Index	7	Basic Procedure in Function Mode	33
Features	8	About Each Function.....	35
Before using the P-90	9	F1. Fine Tuning of the Pitch.....	35
Music Rest	9	F2. Selecting a Scale.....	36
Connecting the AC Power Adaptor and external equipment	9	F3. Dual Mode Functions	37
Turning the power on.....	11	F4. Split Mode Functions.....	38
Adjusting the volume.....	11	F5. Other Functions	39
Control Panel	12	F6. Metronome Volume	39
Listening to the Demonstration		F7. Preset Song Part Cancel Volume.....	39
Tunes	14	F8. MIDI Functions.....	40
Listening to 50 Piano Preset Songs	15	F9. Backup Functions.....	42
Practicing a One-Hand Part Using 50 Preset Songs (Part Cancel Function)	16	About MIDI	44
A-B Repeat for 50 Preset Songs	18	Connecting a Personal Computer	45
Selecting & Playing Voices	19	Troubleshooting	49
Selecting Voices	19	Preset Voice List	50
Adding Variations to the Sound – [VARIATION]/[BRILLIANCE]/[REVERB]/ [EFFECT]	19	Demo Song List	52
Touch Sensitivity – [TOUCH]	21	Preset Song List	52
Transposition – [TRANSCOPE].....	22	Index	53
Combining Two Voices (Dual mode).....	23	Factory Setting List	55
Splitting the Keyboard Range and Playing Two Different Voices (Split mode)	24	MIDI Data Format	56
Using the Metronome.....	25	MIDI Implementation Chart	60
Recording Your Performance	26	Specifications	61
Recording to the First Track.....	26		
Re-recording to the First Track.....	27		
Recording to the Second Track	28		
Changing the Initial Settings (Data recorded at the beginning of a song)	29		
Playing Back Recorded Songs	30		
Playing Back a Song	30		
Useful Playback Functions.....	31		

Thank you for purchasing the Yamaha P-90 Electronic Piano!

We recommend that you read this manual carefully so that you can fully take advantage of the advanced and convenient functions of the P-90.

We also recommend that you keep this manual in a safe and handy place for future reference.

- * The illustrations and LED displays shown in this owner's manual are for instructional purposes only and may appear somewhat different from those on your instrument.

COPYRIGHT NOTICE

This product incorporates and bundles computer programs and contents in which Yamaha owns copyrights or with respect to which it has license to use others' copyrights. Such copyrighted materials include, without limitation, all computer software, MIDI files, WAVE data. Any unauthorized use of such programs and contents outside of personal use is not permitted under relevant laws. Any violation of copyright has legal consequences. **DON'T MAKE, DIS-TRIBUTE OR USE ILLEGAL COPIES.**

Trademarks:

- Apple and Macintosh are trademarks of Apple Computer, Inc.
- Windows is a registered trademark of Microsoft® Corporation.
- All other trademarks are the property of their respective holders.

Accessories

- Owner's Manual
- Music Rest
- Sustain Pedal
- PA-3C AC Power Adaptor (Included or optional depending on locale)

Application Index

Use this index to find reference pages that may be helpful for your particular application and situation.

Listening

- Listening to demo songs with different voices..... “Listening to the Demonstration Tunes” on page 14
- Listening to songs from “50 Greats for the Piano” “Listening to 50 Piano Preset Songs” on page 15
- Listening to my recorded performance “Playing Back Recorded Songs” on page 30

Playing

- Using a included pedal “Connecting the AC Power Adaptor and external equipment” on page 9
- Playing an accompaniment that matches pitch “Transposition – [TRANSPOSE]” on page 22
- Selecting a touch sensitivity type..... “Touch Sensitivity – [TOUCH]” on page 21
- Fine tuning the pitch of the entire instrument when you play the P-90 along with other instruments or CD music “Fine tuning of the pitch” on page 35

Changing voices

- Viewing the list of voices..... “Preset Voice List” on page 50
- Simulating a concert hall “[REVERB]” on page 19
- Combining two voices..... “Combining Two Voices (Dual mode)” on page 23
- Playing different sounds with left and right hands “Splitting the Keyboard Range and Playing Two Different Voices (Split mode)” on page 24
- Making the sound more brilliant or mellower “[BRILLIANCE]” on page 20
- Adding spread or swell to the sound “[EFFECT]” on page 20
- Enhancing the sound with effects..... “[VARIATION]” on page 19

Practicing

- Muting the right- or left-hand part “Practicing a One-Hand Part Using 50 Preset Songs (Part Cancel Function)” on page 16
- Practicing a specified phrase repeatedly..... “A-B Repeat for 50 Preset Songs” on page 18
- Practicing with an accurate and steady tempo “Using the Metronome” on page 25
- Practicing using your recorded song..... “Recording Your Performance” on page 26

Recording

- Recording your performance..... “Recording Your Performance” on page 26

Settings

- Adjusting the P-90 settings “Detailed Settings – [FUNCTION]” on page 32

Connecting the P-90 to other devices

- What is MIDI? “About MIDI” on page 44
- Connecting a computer “Connecting a Personal Computer” on page 45

Features

The Yamaha P-90 Electronic Piano offers unmatched sonic realism and natural grand-piano type playability as well as Yamaha's original "AWM Dynamic Stereo Sampling" tone-generation technology for rich, musical voices, and a special "Graded Hammer" keyboard that provides graded key weight and response throughout the keyboard range.

The GrandPiano1 and 2 voices feature samples recorded from a full concert grand piano. The GrandPiano1 voice features three velocity-switched samples (Dynamic Sampling), special "Sustain Sampling" that samples the unique resonance of an acoustic grand piano's soundboard and strings when the sustain pedal is pressed, and "Keyoff Samples" that add the subtle sound produced when the keys are released. The P-90 comes much closer to the sound of a true acoustic piano.

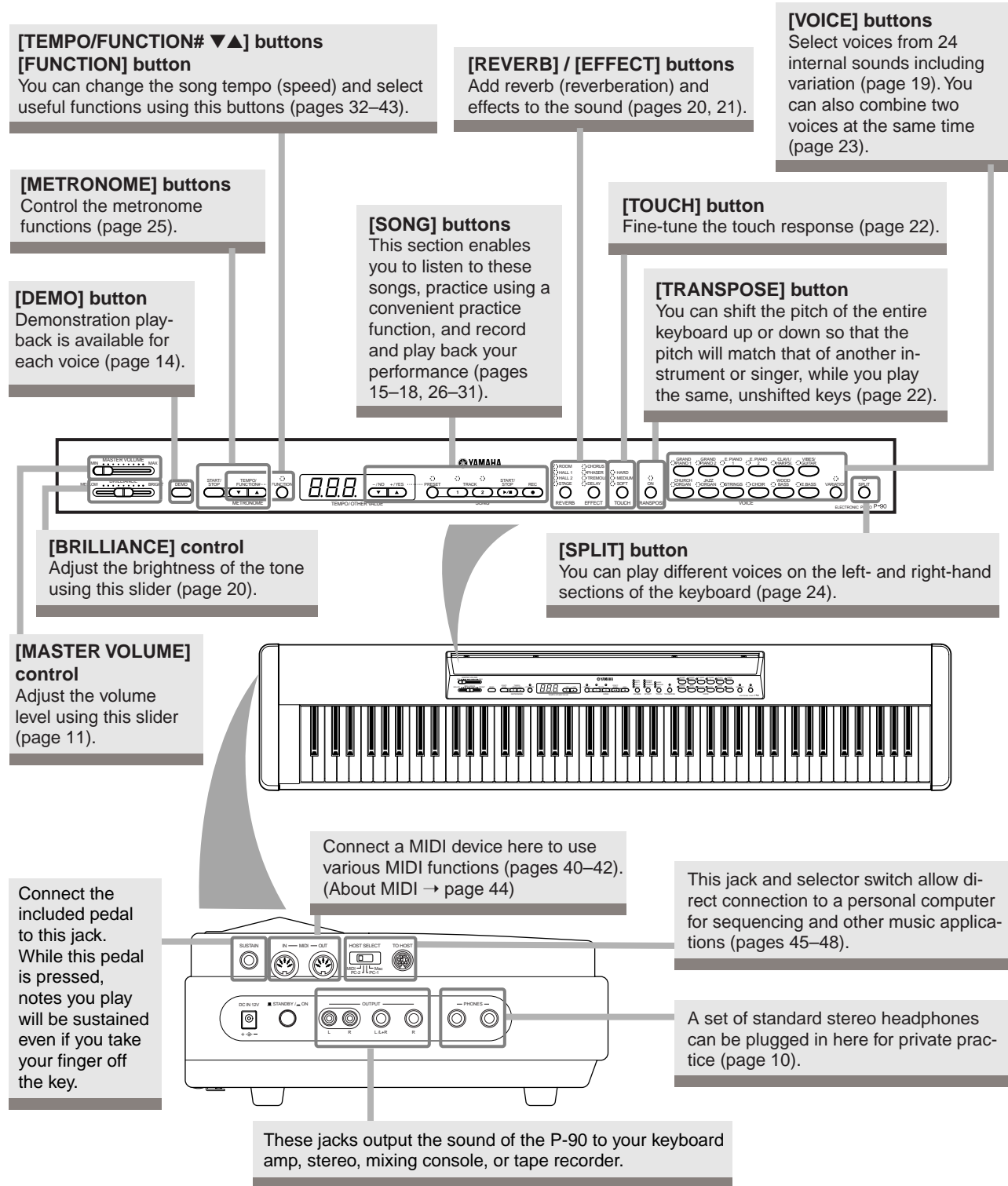

Before using the P-90

Music Rest

Attach the music rest to the instrument by inserting it into the slot at the rear of the control panel.

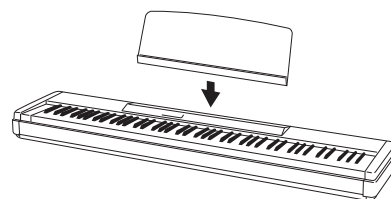

Connecting the AC Power Adaptor and external equipment

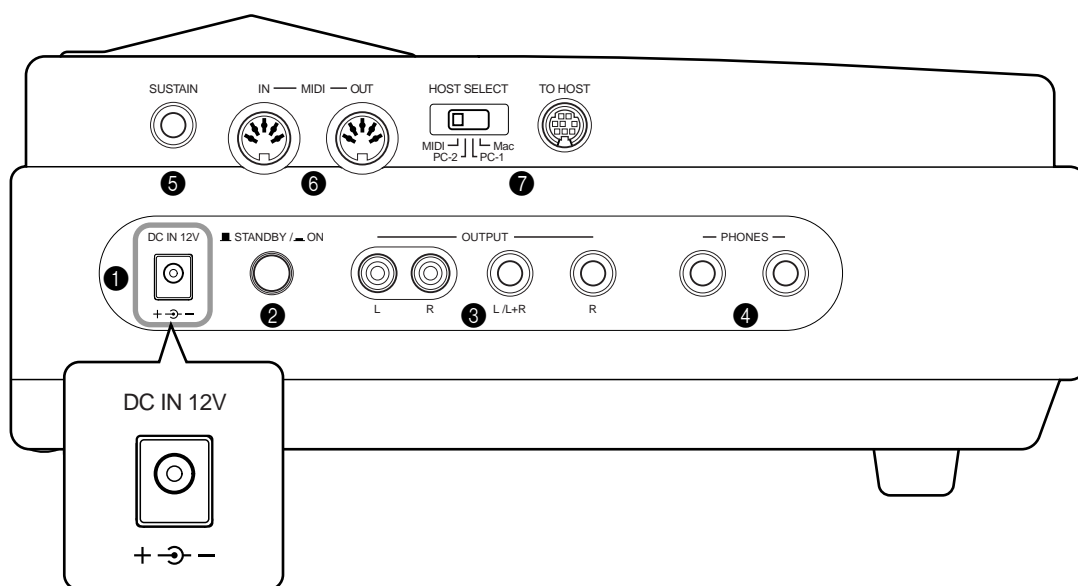

1 [DC IN 12 V] connector

Connect the included PA-3C AC Power Adaptor here.

1. Make sure that the [STANDBY/ON] switch is off (in the “STANDBY” position).
2. Insert the plug of the PA-3C cable into the [DC IN 12V] connector.
3. Plug the PA-3C into an AC outlet of the correct voltage.

When disconnecting the PA-3C, you must reverse this procedure.

⚠ WARNING

Use ONLY a Yamaha PA-3C AC Power Adaptor (or other adaptor specifically recommended by Yamaha) to power your instrument from the AC mains. The use of other adaptors may result in irreparable damage to both the adaptor and the P-90.

⚠ WARNING

Unplug the AC Power Adaptor when not using the P-90, or during electrical storms.

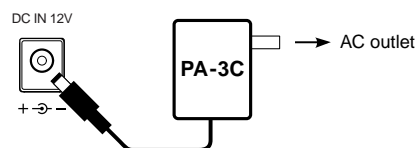

② [STANDBY/ON] switch

This is the power switch. Refer to “Turning the power on” (page 11).

③ OUTPUT [L][R] jacks (RCA phono jacks), [L/L+R] [R] jacks (phone jacks)

You can use audio cables to connect an external audio device to these jacks. The audio output of the P-90 is sent from the OUTPUT jacks, allowing you to play it from an external audio device.

For monaural output, use [L/L+R] (phone jack).

⚠ CAUTION

Before connecting the P-90 to other electronic components, turn off the power for all components. Before turning the power on or off for all components, set all-volume levels to minimum.

⚠ CAUTION

When turning the power on, first turn the P-90's power on and then turn the power on of the external amplifier/speaker system. When turning the power off, simply reverse the order.

NOTE

Since the P-90 does not contain speakers, you will need to connect external audio equipment or use headphones in order to hear its sounds.

④ [PHONES] jacks (1/4-inch stereo phone jacks)

You can connect headphones to these jacks.

Since there are two [PHONES] jacks, you can connect two pairs of headphones so that two people can listen. (If connecting only one pair of headphones, you may use either jack.)

⚠ CAUTION

Do not use the P-90 at a high volume level for a long period of time, or your hearing may be damaged.

⑤ [SUSTAIN] jack

You can connect the included pedal to this jack. While this pedal is pressed, notes you play will be sustained even if you take your finger off the key. Since half-pedaling is supported, pressing the pedal more deeply will produce longer sustain. On the [GRAND PIANO 1] voices (including its variation), pressing this pedal will also add sympathetic resonances of the sound board and strings (sustain sampling).

NOTE

Turn off the power before connecting or disconnecting the pedal.

NOTE

You can adjust the depth of the sound board and string resonance effect (page 39).

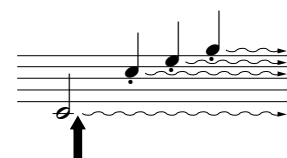
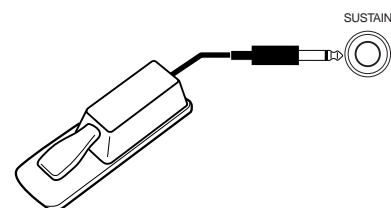
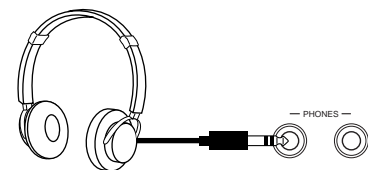
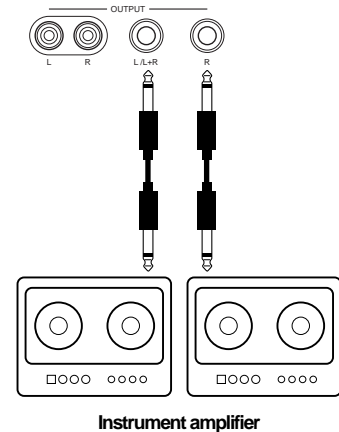
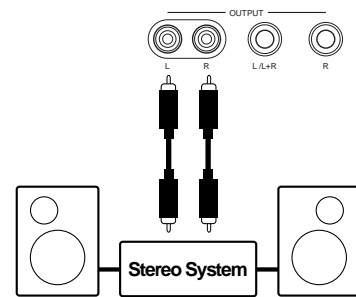

When you press the pedal here, the notes you play before you release the pedal have a longer sustain.

6 MIDI [IN] [OUT] connectors

You can use MIDI cables to connect external MIDI devices.

If using these MIDI connectors, set the **[HOST SELECT]** switch to “MIDI.” Refer to page 44 “About MIDI.”

7 [TO HOST] connector and [HOST SELECT] switch

You can connect your personal computer to the **[TO HOST]** connector.

If you are using the MIDI connectors, set the **[HOST SELECT]** switch to “MIDI.” If you have connected your personal computer to the **[TO HOST]** connector, set this switch to the setting (other than “MIDI”) appropriate for your model of computer.

For details on connecting a personal computer, refer to page 45 “Connecting a Personal Computer.”

Turning the power on

NOTE

For details on connecting the AC power adaptor and external equipment, refer to page 9–11.

CAUTION

You must turn the volume of connected devices to the minimum setting (zero) before turning the power on or off. When turning the power on, first turn on the P-90 and then any external audio devices. When turning the power off, first turn off any external audio devices and then the P-90. Failing to observe the correct order may cause malfunctions or electrical shock.

Make sure that the AC Power adaptor is connected correctly, and press the **[STANDBY/ON]** switch located on the left side panel.

- The display will become active.

To turn off the power, press the **[STANDBY/ON]** switch again.

CAUTION

Even when the switch is in the “STANDBY” position, electricity is still flowing to the instrument at the minimum level.

CAUTION

When you are not using the P-90 for a long time, make sure you unplug the AC power adaptor from the wall AC outlet.

Adjusting the volume

If an external audio device is connected, use the P-90’s **[MASTER VOLUME]** control and the volume control of your external audio device to adjust the volume while you play the keyboard to produce sound.

If you are using headphones, gradually raise the P-90’s **[MASTER VOLUME]** control while playing the keyboard.

NOTE

If the sound is distorted at high volume, lower the **[MASTER VOLUME]** control and/or external audio device volume control until the sound is no longer distorted.

■ STANDBY / ▬ ON

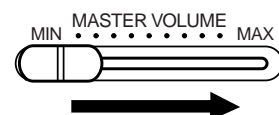

Control Panel

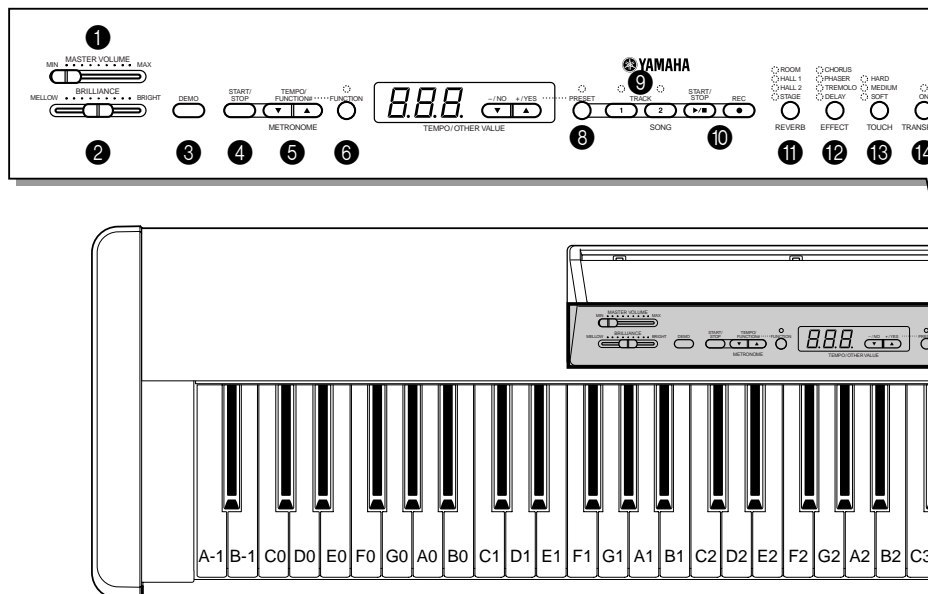

1 [MASTER VOLUME] Control

The [MASTER VOLUME] control adjusts the P-90's output volume (level). The [MASTER VOLUME] control also adjusts headphone volume when a pair of headphones is plugged into the [PHONES] jack (page 10).

2 [BRILLIANCE] Control

The [BRILLIANCE] Control adjusts the tonality or “timbre” of the output sound from a mellow tone to a bright tone.

3 [DEMO] Button

Activates the demo playback mode in which you can select playback of different demonstration sequences for each of the P-90's voices. See page 14 for details.

4 METRONOME [START/STOP] Button

Turns the metronome sound on and off. The [TEMPO/FUNCTION#▲,▼] buttons, are used to set the tempo of the metronome sound. The [–/NO▼] and [+ /YES▲] buttons are used to change the time signature (beat) of the metronome, if used while the METRONOME [START/STOP] button is held — page 25.

5 [TEMPO/FUNCTION#▲,▼] Buttons

These buttons adjust the tempo of the metronome function as well as the playback tempo of the song-function. The tempo range is from 32 to 280 beats per minute — page 25. These same buttons are also used to select functions — page 33.

6 [FUNCTION] Button

This button accesses a range of utility functions—including the MIDI functions — that significantly enhance versatility and playability. See page 33 for details.

7 [–/NO▼], [+ /YES▲] Buttons

These buttons select a preset song number for playback, and are also used to adjust a range of other parameters (i.e. their “–/NO” and “+ /YES” functions).

8 SONG [PRESET] Button

This button enters the preset song mode. While in this mode you can use the [–/NO▼], [+ /YES▲] buttons to select from 50 songs.

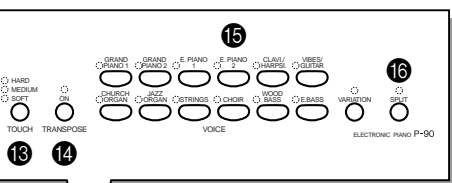

Display

- Check the operation on the display in the center of the top panel as you proceed.
- The display indicates different values, as shown below, depending on the operation.

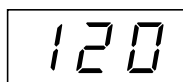

Tempo
(Normal indication)



A song number of
"50 Greats for the Piano"

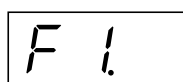

Function number

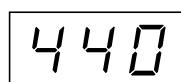

Parameter value

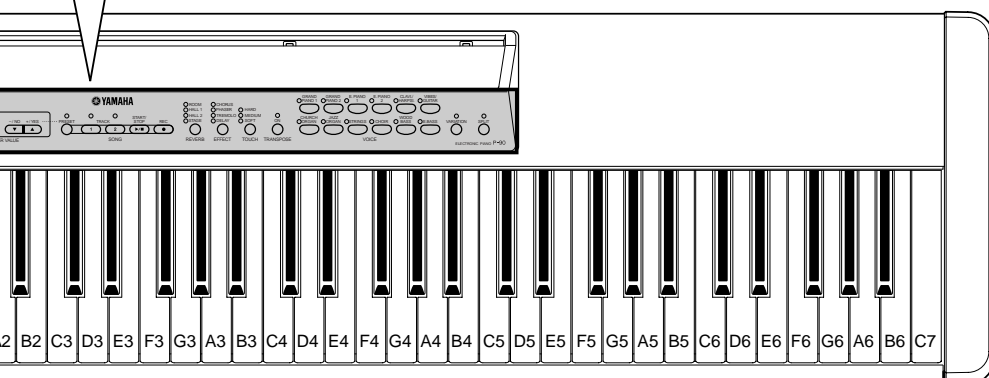

9 TRACK [1] and [2] Buttons

The P-90 has a 2-track recorder, and these buttons are used to select the track(s) to be recorded or played back. See page 27 for details.

10 SONG [START/STOP] and [REC] Buttons

These buttons control the P-90's user song recorder, letting you record and play back just about anything you play on the keyboard.

11 [REVERB] Button

The [REVERB] button selects a number of digital reverb effects that you can use for extra depth and expressive power. See page 20 for details.

12 [EFFECT] Button

This button selects a number of effects which can give your sound greater depth and animation.

13 [TOUCH] Button

The [TOUCH] button makes it easy to adjust the touch response of the P-90 to match your playing-style. See page 21 for details.

14 [TRANSCOPE] Button

The [TRANSCOPE] button allows access to the P-90's TRANSCOPE function (to shift the pitch of the entire keyboard up or down in semitone intervals).

15 VOICE Buttons & [VARIATION] Button

Simply press any of the voice selectors to select the corresponding voice. The voice selector LED will light to indicate which voice is currently selected. Press the [VARIATION] button so that its indicator lights to select a variation of the currently selected voice.

There is also a dual mode in which two voices can be played simultaneously across the full range of the keyboard (see page 23 for details), and a split mode which allows different voices to be played by the left and right hands (see page 24 for details).

16 [SPLIT] Button

Engages the split mode, in which different voices can be played on the left- and right-hand sections of the keyboard. See page 24 for details.

Listening to the Demonstration Tunes

Demonstration tunes are provided that effectively demonstrate each of the P-90's voices.

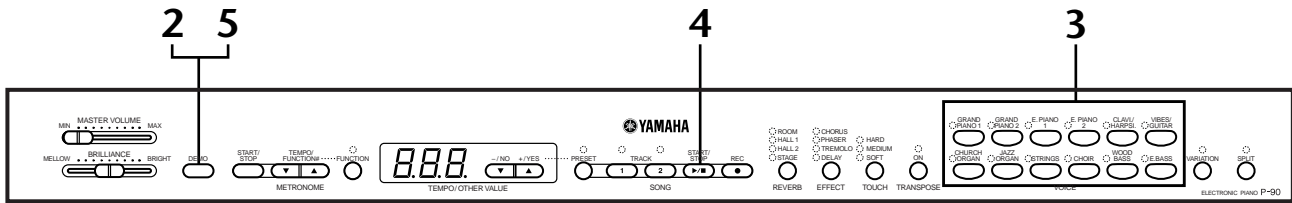

Procedure

1. Turn the power on.

(In case the power is not turned ON) Press the [STANDBY/ON] switch. When the power is turned ON, one of the voice button LEDs will light. Initially set the [MASTER VOLUME] control about half way between the “MIN” and “MAX” settings. Then, when you start playing, re-adjust the [MASTER VOLUME] control to the most comfortable listening level.

2. Engage Demo mode.

Press the [DEMO] button to engage Demo mode. The voice button indicators will flash in sequence.

3. Play a Voice demo.

Press one of the voice buttons to start playback of all songs starting from the corresponding voice demo tune — featuring the voice normally selected by that voice button. (If you press the SONG [START/STOP] button instead of a voice button, the [GRAND PIANO 1] demo tune will begin playback.)

Adjust the volume/brilliance

Use the [MASTER VOLUME] control to adjust the volume and the [BRILLIANCE] control to adjust the brilliance (page 20).

4. Stop the Voice demo.

Press the SONG [START/STOP] button or the voice button of the currently-playing demo to stop playback.

5. Exit from Demo mode.

Press the [DEMO] button to exit from Demo mode and return to normal play mode.

The voice button indicators will stop flashing in sequence.

(NOTE)

MIDI reception is not possible in Demo Song mode. Demo song data is not transmitted via the MIDI connectors.

(NOTE)

Demo mode cannot be engaged while a user song recorder (page 26) or user song playback (page 30) is in use.

(TERMINOLOGY)

Mode:

A mode is a status under which you can execute a certain function. In Demo mode, you can play back demonstration tunes.

(NOTE)

You cannot adjust the tempo of demo songs. You cannot use the part cancel function (page 39) or the song A–B repeat function (page 18) in Demo mode.

(NOTE)

You can demo the piano voices with various effects by pressing the [VARIATION] button, then pressing the desired voice button. Refer to the “Piano Voice Demo Description” on page 52 for the complete list of demo sounds for the piano voices with various effects.

Listening to 50 Piano Preset Songs

The P-90 provides performance data of 50 piano songs. You can simply listen to these songs (page 15) or use them for practice (page 16). Voice demo songs consist entirely of Yamaha original songs (© 2001-2002 Yamaha Corporation). See page 52 for a complete listing of the preset songs.

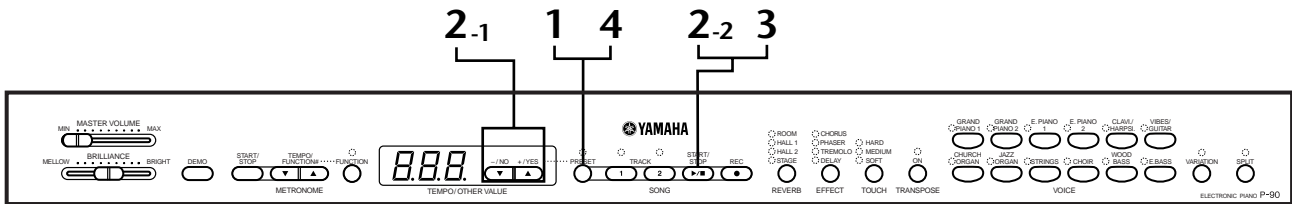

Procedure

1. Engage Preset Song mode.

Press the [PRESET] button to engage Preset Song mode. The [PRESET], [TRACK1] and [TRACK2] indicators will light.

2. Play any of the 50 preset songs.

2-1 Press the [-/NO], [+ /YES] buttons to select the number of the tune you want to play (the number will appear on the LED display).

1 – 50: Select a preset song number and play only the song.

ALL: Play all preset songs in sequence.

rnd: Play all preset songs continuously in random order.

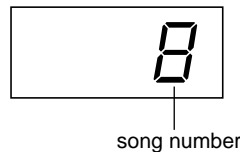

2-2 Press the SONG [START/STOP] button to start playback.

Adjust the Volume

Use the [MASTER VOLUME] control to adjust the volume.

Adjust the tempo

You can use the [TEMPO/FUNCTION# ▼ ▲] buttons to adjust the playback tempo as required. The default tempo can be recalled by simultaneously pressing the [▼] and [▲] buttons.

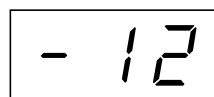

This produces a relative tempo variation, with a range from “-50” through “-” to “50” at maximum; the range will differ depending on the selected song.

3. Stop playback.

Playback will stop automatically when the selected preset song has finished. To stop the song during playback (or continuous playback), press the SONG [START/STOP] button.

- To play back another song continuously, see procedure 2 above.

NOTE

Preset Song mode cannot be engaged while the unit is in Demo Song mode (page 14), while a song is playing back (page 30), or when the user song recorder (page 26) is in use.

TERMINOLOGY

Song:

On the P-90, performance data is called a “Song.” This includes demonstration tunes and piano preset tunes.

TIP

You can play the keyboard along with the preset song. You can change the voice playing on the keyboard.

TIP

You can adjust the Brilliance control (page 20) and Reverb type (page 20) that is applied to the voice you play on the keyboard and for the preset song playback. You can change the Effect type (page 20) and Touch sensitivity (page 21) for the keyboard voice.

NOTE

The default tempo “-” is automatically selected whenever a new preset song is selected, or when playback of a new preset song begins during “ALL” or “rnd” playback.

NOTE

When you select a different song (or a different song is selected during chained playback), an appropriate reverb type will be selected accordingly.

4. Exit from Preset Song mode.

Press the [PRESET] button to exit Preset Song mode. The indicator turns off, and the unit returns to normal play mode.

How to use the practice functions

You can turn the left- and right-hand parts on or off as required so you can practice the corresponding part (part cancel function) and continuously repeat a specified phrase within a song (song A-B repeat function). For more information, see pages 16–18.

NOTE

MIDI reception is not possible in Piano Song mode.
Piano song data is not transmitted via the MIDI connectors.

Practicing a One-Hand Part Using 50 Preset Songs (Part Cancel Function)

The 50 preset songs have separate left- and right-hand parts on individual tracks. You can turn the left- and right-hand parts on or off as required so you can practice the corresponding part (the part that is turned off) on the keyboard. The right-hand part is played by [TRACK1] and the left-hand part is played by [TRACK2].

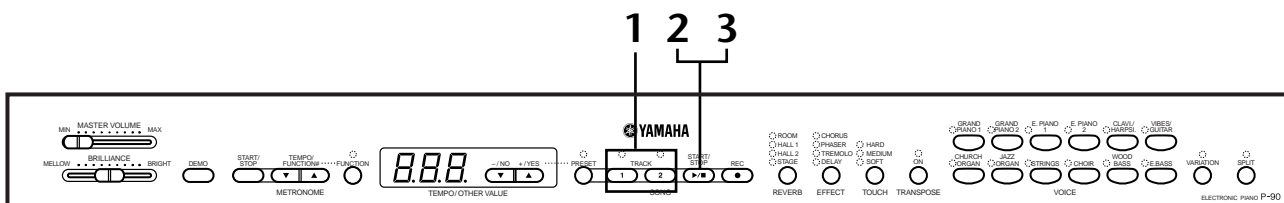

Procedure

1. Turn off the playback part you wish to practice.

After you select a song to practice, press the [TRACK1] or [TRACK2] button to turn off the corresponding part.

When you first select a song, both [TRACK1] and [TRACK2] indicators light up, indicating that you can play back both parts. When you press one of the buttons to turn off playback, the corresponding button indicator turns off and the corresponding part playback is muted.

- Pressing the buttons repeatedly toggles playback between on and off.

2. Start playback and playing.

Press the SONG [START/STOP] button to start playback. Play the part you just turned off.

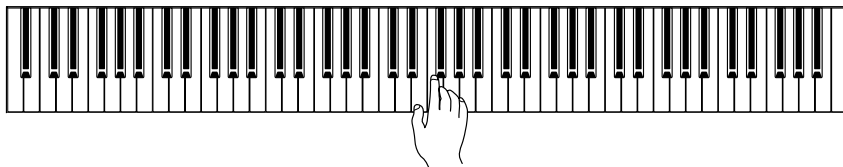

NOTE

The Preset Song Part Cancel function cannot be used during "ALL" or "rnd" (page 15) playback.

TIP

The parts can be turned on or off even during playback.

TIP

The "Preset Song Part Cancel Volume" function described on page 39 can be used to set the canceled part so that it plays at a volume from "0" (no sound) to "20". The normal setting is "5".

Starting playback automatically as you start playing the keyboard (Synchro Start)

When the Synchro Start function is engaged, playback of the selected preset song will begin automatically as soon as you start playing on the keyboard.

To engage the Synchro Start function press the **SONG [START/STOP]** button while holding the part button for the ON part. A dot will appear in the lower right corner of the display.

(Repeat the previous operation to disengage the Synchro Start function.)

Playback will then start as soon as you begin playing on the keyboard.



song number
synchro start mark

(NOTE)

If you hold a track button that is OFF while pressing the **SONG [START/STOP]** button, that track will be turned ON and the unit will engage Synchro Start mode.

(NOTE)

Both parts are automatically turned ON whenever a new song is selected.

3. Stop playback.

When playback is complete, it automatically stops and the P-90 locates the top of the song. If you wish to stop playback in the middle of a song, press the **SONG[START/STOP]** button.

A-B Repeat for 50 Preset Songs

The A-B Repeat function can be used to continuously repeat a specified phrase within a preset song. Combined with the Part Cancel function described below, this provides an excellent way to practice difficult phrases.

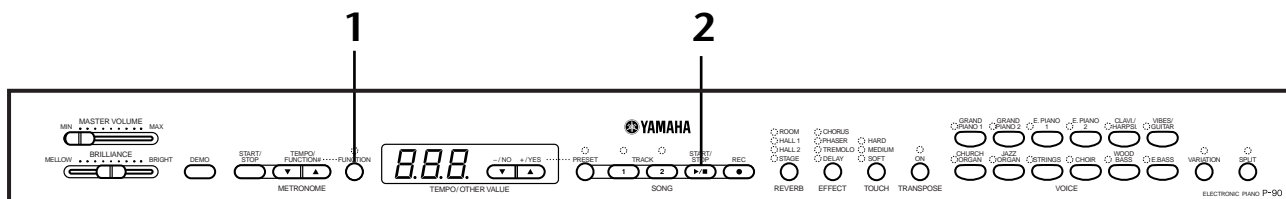

Procedure

1. Specify the beginning (A) and the end (B) of the phrase, and start practicing.

Select and play a preset song, then press the [FUNCTION] button at the beginning of the phrase you want to repeat.

This sets the “A” point (A -) will appear on the display).

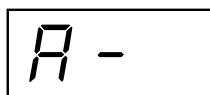

To specify the end (B) of the phrase, press the [FUNCTION] button a second time at the end of the phrase.

This sets the “B” point (A - b) will appear on the display).

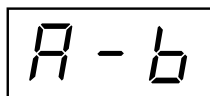

At this point, repeat playback will begin between the specified A and B points.

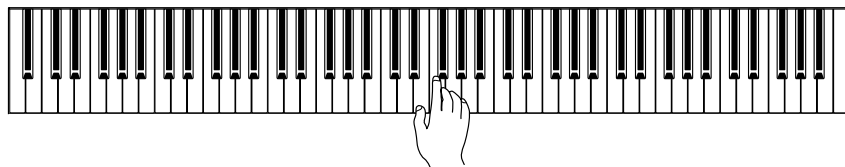

2. Stop playback.

Press the SONG [START/STOP] button to stop playback while retaining the specified A and B points. A-B repeat playback will resume if you press the SONG [START/STOP] button again.

To cancel the A and B points, press the [FUNCTION] button once.

NOTE

The A-B Repeat function cannot be used during “ALL” or “rnd” (page 15) playback.

NOTE

- To set the “A” point at the very beginning of the song, press the [FUNCTION] button before starting playback.
- To set the B point at the song’s end, press the [FUNCTION] button after song playback is complete and before A - disappears from the display.

TIP

An automatic lead-in (to help guide you into the phrase) starts at the A point of the song. However, when the A point is set at the beginning of the song, the automatic lead-in is not played.

NOTE

The A and B points are automatically canceled when a new song is selected.

Selecting & Playing Voices

Selecting Voices

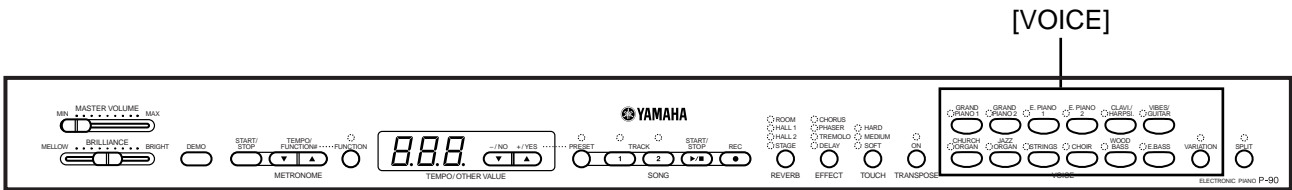

Procedure

Select the desired voice by pressing one of the [VOICE] buttons.

Then, when you start playing, re-adjust the [MASTER VOLUME] control for the most comfortable listening level.

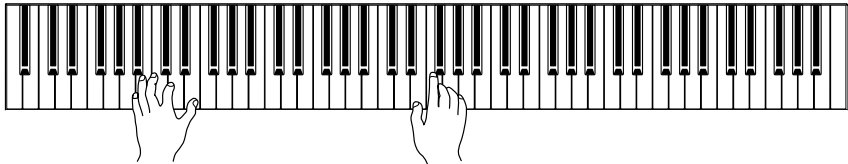

TIP

To learn characteristics of the voices, listen to demo songs for each voice (page 14). Refer to “Preset Voice List” on page 50 for more information on the characteristics of each preset voice.

TERMINOLOGY

Voice:
On the P-90, a voice means a “tone” or “tonal color.”

TIP

You can control the loudness of a voice by adjusting the force with which you strike the keys, although different playing styles (touch sensitivities) have little or no effect with certain musical instruments.

Refer to “Preset Voice List” on page 50.

ENGLISH

Adding Variations to the Sound – [VARIATION]/[BRILLIANCE]/[REVERB]/[EFFECT]

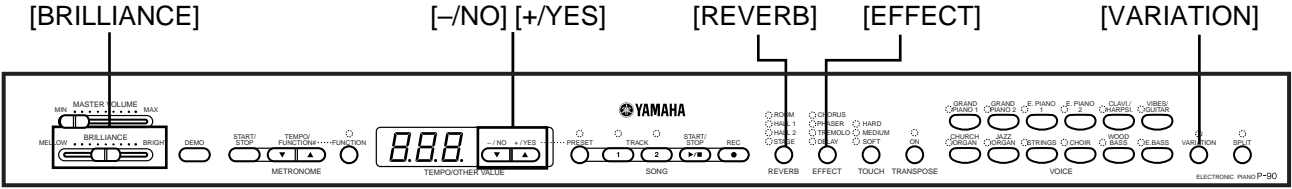

[VARIATION]
Lets you alter another aspect of the effect, depending on the selected type. Refer to “Preset Voice List” on page 50 for more information on the characteristics of each variation.

Procedure

Pressing the [VARIATION] or selected voice button toggles the variation on and off. The indicator lights (ON) each time the [VARIATION] button is pressed.

TIP

Normal setting = OFF

TERMINOLOGY

Normal setting:
The “Normal setting” refers to the default setting (factory setting) obtained when you first turn on the power to the P-90.

[BRILLIANCE]

This control can be used to change the tonality or “timbre” of the sound output. The control range is from MELLOW to BRIGHT.

[REVERB]

This control enables you to select various digital reverb effects that would add extra depth and expression to the sound to create a realistic acoustic ambience.

OFF: When no reverb effect is selected, no REVERB indicator is lit.

ROOM: This setting adds a continuous reverb effect to the sound, similar to the acoustic reverberation you would hear in a room.

HALL 1: For a “bigger” reverb sound, use the HALL 1 setting. This effect simulates the natural reverberation of a small-size concert hall.

HALL 2: For a truly spacious reverb sound, use the HALL 2 setting. This effect simulates the natural reverberation of a large concert hall.

STAGE: Simulates the reverb of a stage environment.

Procedure

Pressing the **[REVERB]** button repeatedly toggles the reverb on and off.

The indicators light in sequence each time the **[REVERB]** button is pressed. No effect is produced when all indicators are off.

Even if the REVERB effect is OFF, a “Soundboard Reverb” effect will be applied when the **[GRAND PIANO 1]** voices are selected.

Adjusting Reverb Depth

Adjust the reverb depth for the selected voice by using the **[-/NO] [+/YES]** buttons while holding the **[REVERB]** button. The depth range is from 0 through 20. The current depth setting appears on the LED display while the **[REVERB]** button is held.

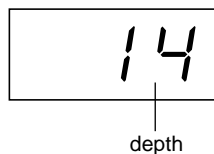
**[EFFECT]**

The **[EFFECT]** button allows you to select an effect to give your sound greater depth and animation.

OFF: When no effect is selected, no EFFECT indicator is lit.

CHORUS: A shimmering, broadening effect

PHASER: Adds a sweeping effect to the sound.

TREMOLO: Tremolo effect

DELAY: Echo effect

(NOTE)

When the BRILLIANCE is set to BRIGHT, the overall sound will be slightly louder. If the MASTER VOLUME is set at a high level the sound may become distorted. If so, lower the MASTER VOLUME level.

(TIP)

The default reverb type (including OFF) and depth settings are different for each voice.

(TIP)

Releasing the **[REVERB]** button changes the reverb type. If you are changing the reverb depth by holding the **[REVERB]** button, pressing the **[REVERB]** button will not change the reverb type.

(TIP)

depth 0: no effect
depth 20: maximum reverb depth

(TIP)

Default depth settings are different for each voice.

(TIP)

The default effect type (including OFF) and depth settings are different for each voice.

Procedure

To select an effect type press the [EFFECT] button a few times until the indicator corresponding to the desired type lights (the indicators light in sequence each time you press the [EFFECT] button). No effect is produced when all indicators are off.

Adjusting Effect Depth

You can adjust the effect depth for the selected voice by using the [-/NO] and [+ /YES] buttons while holding the [EFFECT] button.

The depth range is from 0 through 20. The current depth setting appears on the LED display while the [EFFECT] button is held.

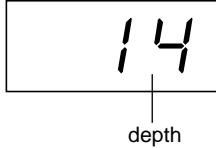

TIP
Releasing the [EFFECT] button changes the effect type. If you are changing the depth settings by holding the [EFFECT] button, pressing the [EFFECT] button will not change the effect type.

TIP
depth 0: no effect
depth 20: maximum effect depth

TIP
Default depth settings are different for each voice.

Touch Sensitivity – [TOUCH]

You can select four different types of keyboard touch sensitivity — HARD, MEDIUM, SOFT or FIXED — to match different playing styles and preferences.

- HARD:** Requires that the keys be played quite hard to produce maximum loudness.
- MEDIUM:** Produces a fairly “standard” keyboard response.
- SOFT:** Allows maximum loudness to be produced with relatively light key pressure.
- FIXED:** All notes are produced at the same volume no matter how hard the keyboard is played.
You can adjust the volume.

TIP
This setting does not change the weight of the keyboard.

TIP
Normal setting = MEDIUM

TIP
The touch sensitivity type will become the common setting for all voices. However, the touch sensitivity settings may have little or no effect with certain voices that are not normally responsive to keyboard dynamics. (Refer to the “Preset Voice List” on page 50.)

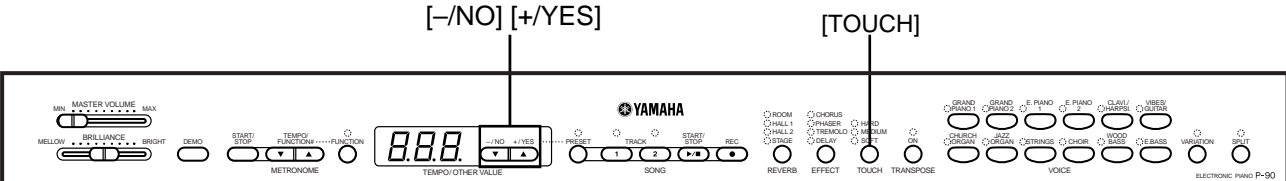

Procedure

To select a touch sensitivity type press the [TOUCH] button a few times until the indicator corresponding to the desired type lights (the indicators light in sequence each time the [TOUCH] button is pressed). No indicator is lit when “FIXED” is selected.

Changing the volume when FIXED is selected

When you select FIXED, you can set the volume for notes played in FIXED mode by using the [-/NO] and [+ /YES] buttons while you hold the [TOUCH] button. The current volume level appears on the display. The volume range is from 1 through 127. The default setting is 64.

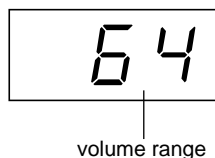

TIP

1: minimum volume
127: maximum volume

TIP

The touch volume set in FIXED mode will become the common setting for all voices.

TIP

Releasing the [TOUCH] button changes the touch type. If you are changing the volume by holding the [TOUCH] button, pressing the [TOUCH] button will not change the touch sensitivity type. (FIXED mode will remain selected.)

Transposition – [TRANSPOSE]

The P-90's Transpose function makes it possible to shift the pitch of the entire keyboard up or down in semitone intervals to facilitate playing in difficult key signatures, and to let you easily match the pitch of the keyboard to the range of a singer or other instruments. For example, if you set the transposition amount to "5," playing key C produces pitch F. In this way, you can play a song as though it were in C major, and the P-90 will transpose it to the key of F.

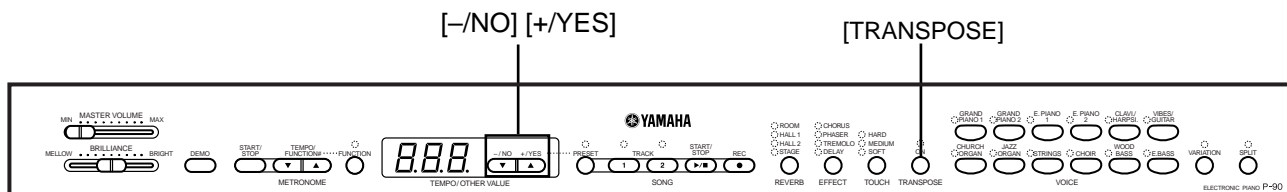

Procedure

Use the [-/NO] and [+ /YES] button while holding the [TRANSPOSE] button to transpose down or up as required. The amount of transposition appears on the LED display while the [TRANSPOSE] button is held. The default transposition setting is "0".

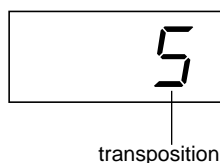

The [TRANSPOSE] button indicator remains lit when a transposition setting other than "0" is selected. Every time the [TRANSPOSE] button is pressed after that switches the transposition function ON or OFF.

TERMINOLOGY

Transpose: Changing the key signature of a song. On the P-90, transposing shifts the pitch of the entire keyboard.

TIP

The transposition range:
-12: -12 semitones (down one octave)
0: normal pitch
12: 12 semitones (up one octave)

TIP

Notes below and above the A-1 ... C7 range of the P-90 sound one octave higher and lower, respectively.

Combining Two Voices (Dual mode)

You can play two voices simultaneously across the entire range of the keyboard. In this way, you can simulate a melody duet or combine two similar voices to create a thicker sound.

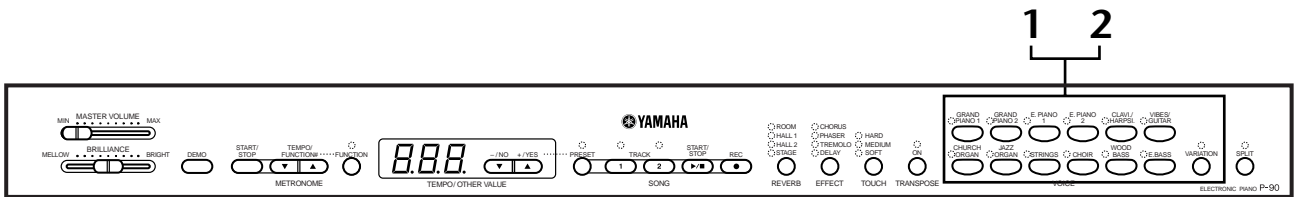

Procedure

1. Engage Dual mode.

Press two voice buttons at the same time (or press one voice button while holding another). The voice indicators of both selected voices will light when Dual mode is active.

- According to the voice numbering priority shown in the diagram on the right, the lower value voice number will be designated as Voice 1 (the other voice will be designated as Voice 2).

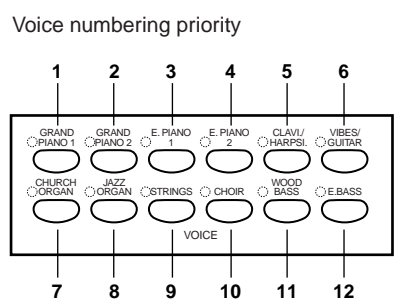

The P-90 Function mode provides access to a number of other Dual mode functions, such as volume balance setting or octave setting (page 37). (If you do not set Dual mode functions, the appropriate setting will be set in each voice by default.)

2. Exit Dual mode and return to normal play mode.

To return to the normal single-voice play mode, press any single voice button.

NOTE
Dual and Split (page 24) modes cannot be engaged at the same time.

TIP
[VARIATION] in Dual Mode
The **[VARIATION]** button's indicator will light if the variation is engaged for either or both of the Dual mode voices. While Dual mode is engaged, the **[VARIATION]** button can be used to turn the variation for both voices on or off.
To turn the variation on or off for only one of the voices, hold the voice button for the other voice and press the button of the voice for which you want to change the variation.

TIP
[REVERB] in Dual Mode
The reverb type assigned to Voice 1 will take priority over the other. (If the reverb is set to OFF, Voice 2 reverb type will be in effect.) Reverb depth setting via the panel controls (i.e., pressing the **[-/NO]** or **[+/YES]** buttons while holding the **[REVERB]** button — see page 20) will be applied only to Voice 1.

TIP
[EFFECT] in Dual Mode
Depending on the conditions, one effect type may take priority over the other. Depth will be decided according to the depth default value of the voice combination. However, using function F3 (page 37) you can adjust the depth value for each voice to your liking.
Effect depth setting via the panel controls (i.e., pressing the **[-/NO]** or **[+/YES]** buttons while holding the **[EFFECT]** button — see page 20) will be applied only to Voice 1.

Splitting the Keyboard Range and Playing Two Different Voices (Split mode)

Split mode enables you to play two different voices on the keyboard — one with the left hand and another with the right hand. For example, you can play a bass part using the Wood Bass or Electric Bass voice with the left hand, and a melody with the right hand.

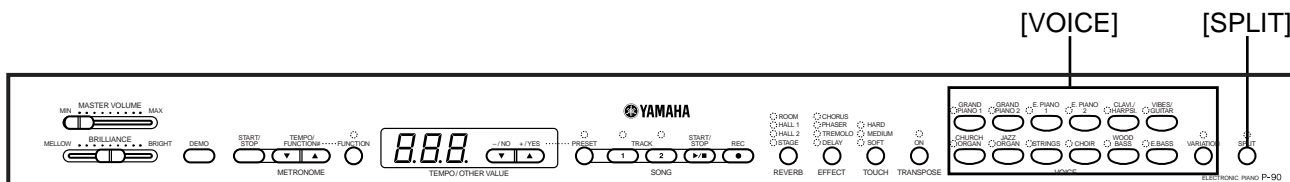

Procedure

1. Engage Split mode.

Press the **[SPLIT]** button so that its indicator lights. The default setting (**WOOD BASE**) will be selected for the left-hand voice at first.

The Function mode provides access to a number of other Split mode functions (page 38). (If you make no settings for Split mode functions, the appropriate setting will be set in each voice by default.)

2. Specify the split point (the border between the right- and left-hand range).

You can change the split point to any other key by pressing the key while holding the **[SPLIT]** button (the name of the current split-point key appears on the LED display while the **[SPLIT]** button is held).

An example of split-point key display

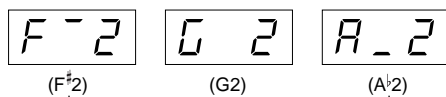

followed by a high bar if sharp

followed by a low bar if flat

The split point is initially set at the **F#2** key by default.

If you do not need to change the split point, skip this procedure.

3. Select a voice for the right hand.

Press a voice button.

4. Select a voice for the left hand.

Press the corresponding voice button while holding the **[SPLIT]** button. (The indicator of the Left Voice button will light while the **[SPLIT]** button is pressed.)

To turn the variation on or off for the split voice, hold the **[SPLIT]** button and press the **[VARIATION]** button or the currently-selected voice button.

NOTE

Dual (page 23) and Split (page 23) modes cannot be engaged simultaneously.

TIP

A specified "split point" key is included in the left-hand range.

TIP

The split point can also be set via Function 4 (page 38).

TIP

[VARIATION] in Split Mode

You can turn the variation on or off for Split mode voices. Normally, the voice indicator of the right voice lights in Split mode. The **[VARIATION]** can be used to turn the variation for the right voice on or off as required. While the **[SPLIT]** button is held, however, the voice indicator of the left voice lights. In this state the **[VARIATION]** button turns the variation for the left voice on or off.

TIP

[REVERB] in Split Mode

The reverb type assigned to the right voice will take priority over the other. (If the reverb is set to OFF, the left voice's reverb type will be in effect.) Reverb depth setting via the panel controls (i.e. pressing the **[-/NO]** or **[+/YES]** buttons while holding the **[REVERB]** button — see page 20) will be applied to the right voice only.

5. Exit Split mode and return to normal play mode.

Press the [SPLIT] button again so that its indicator goes out.

TIP

[EFFECT] in Split Mode

Depending on the conditions, one effect type will take priority over the other. The depth will be decided according to the depth default value of the voice combination. However, using function F4 (page 38) you can change the depth value for each voice as you like. Effect depth setting via the panel controls (i.e. pressing the [-/NO] or [+/YES] buttons while holding the [EFFECT] button — see page 20) will be applied to the right voice only.

Using the Metronome

The P-90 features a built-in metronome (a device that keeps an accurate tempo) that is convenient for practicing.

1 2 [TEMPO/FUNCTION# ▲▼] [-/NO] [+/YES]

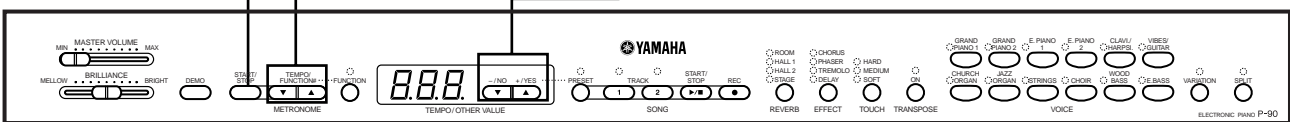

Procedure

1. Start the metronome.

The metronome sound is turned on by pressing the **METRONOME [START/STOP]** button.

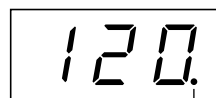

The beat indicator flashes at the current tempo.

Adjusting the tempo

The tempo of the metronome and user song recorder playback (the recorder is described in the next section) can be set from 32 to 280 beats per minute by using the [TEMPO/FUNCTION# ▼, ▲] buttons (when the [FUNCTION] button indicator is dark).

Adjusting the time signature

The time signature (beat) of the metronome can be set by using the [-/NO] and [+/YES] buttons while holding the **METRONOME [START/STOP]** button. You can set the beat to 0, 2, 3, 4, 5 or 6. The current setting appears on the LED display while you are holding the **METRONOME [START/STOP]** button.



beat

2. Stop the metronome.

Turn off the metronome by pressing the **METRONOME [START/STOP]** button.

TIP

If the [FUNCTION] button indicator is lit, press the [FUNCTION] button to dark it.

TIP

The volume of the metronome can be adjusted via the Metronome Volume function in Function mode (page 39).

Recording Your Performance

The ability to record and play back what you've played on the P-90 keyboard can be an effective practice aid. You can, for example, record just the left-hand part, and then practice the right-hand part while playing back the recorded left-hand part. Or, since you can record up to two tracks separately, you could record the left- and right-hand parts separately, or record both parts of a duet and hear how they sound when played back. The P-90's two-track Song Recorder allows the recording of one User Song.

TIP

You can record your performance (audio data) to a cassette tape recorder or other recording device via the OUT-PUT connector (page 10).

TERMINOLOGY

Recording vs. Saving:

The format of performance data recorded on a cassette tape differs from that of data recorded on the P-90. A cassette tape records audio signals. The P-90 "saves" information regarding note timing, voices, and a tempo value, but not audio signals. When you play back recorded songs, the P-90 produces sound based on the saved information. Therefore, recording on the P-90 may be more accurately called "saving information." However, this book often uses the word "recording" because it seems to make more sense.

Recording to the First Track

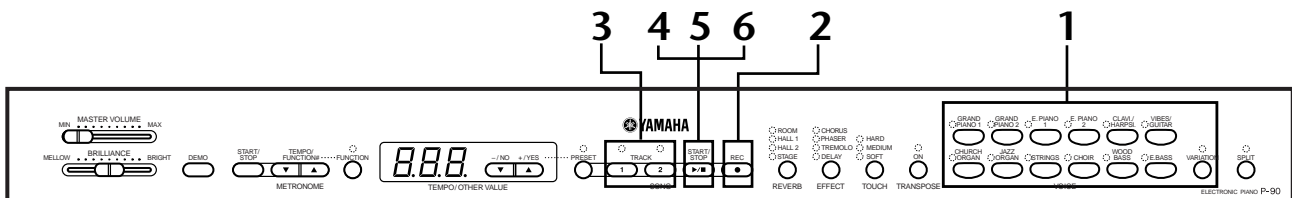

Procedure

CAUTION

Notes on recording

All user song recorder data will be retained in memory for about one week after the power is turned off. If you want to keep your recorded data for longer periods of time, turn the power on for a few minutes at least once a week.

It is also possible to store the data to an external MIDI storage device such as the Yamaha MIDI Data Filer MDF3 by using the Bulk Data Dump function described on page 42.

1. Make all the initial settings.

Before you begin to record, select the voice you want to record (or voices if you will be using Dual or Split mode). Make any other desired settings (tempo, reverb, etc.) as well. You might also want to set the volume.

You can also adjust the playback volume using [MASTER VOLUME].

NOTE

When the unit is in Demo Song or Preset Song mode, Record mode cannot be engaged.

NOTE

To avoid erasing data from the track:

Press the [TRACK 1/2] button. If the indicator lights up green, the track already contains data.

Note that the existing data will be erased if you record new data on the track.

2. Engage Record Ready mode.

Press the [REC] button to engage Record Ready mode. Recording does not actually start yet. The [TRACK1] or the [TRACK2] indicator flashes in red.

The amount of memory available for recording will be shown on the LED display in approximate kilobytes, and the right-most dot on the LED display will flash at the current METRONOME tempo setting.

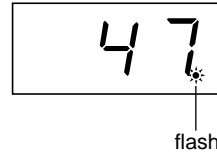

Record Ready mode can be disengaged before recording by pressing the [REC] button a second time.

3. Select the record track.

When Record mode is engaged in the previous step, the last-recorded track will automatically be selected for recording and its indicator — i.e. the [TRACK1] or [TRACK2] button indicator — will glow red. If you want to record on a different track, press the appropriate track button so that its indicator glows red.

4. Start recording.

Recording will begin automatically as soon as you play a note on the keyboard or press the SONG [START/STOP] button. The current measure number will appear on the display while recording.



5. Stop recording.

Press either the [REC] or SONG [START/STOP] button to stop recording. The indicator of the recorded track will glow green to indicate that it now contains data. (Record mode is disengaged automatically.)

6. Play back the recorded performance.

Press the SONG [START/STOP] button to play back the recorded performance. To stop playback in the middle of a song, press the SONG [START/STOP] button.

(NOTE)

The amount of memory available for recording:

This value in kilobytes (a unit used of measurement for data) indicates how much space remains available for recording on the P-90. You can record up to a maximum of about 9,400 notes on the P-90 depending on pedal usage and other factors.

(TIP)

If the metronome was on when you started recording, you'll be able to keep time with the metronome while recording, but the metronome sound will not be recorded.

(TIP)

For more recording information, see page 28.

(NOTE)

The record track indicator will begin to flash when the recorder memory is almost full. If the memory becomes full during recording, "FUL" will appear on the display and recording will stop automatically. (All recorded data up to that point will be retained.)

(NOTE)

Pressing the SONG [START/STOP] button to start recording, then pressing it again to stop recording will erase all previously-recorded data on the selected track.

Re-recording to the First Track

This section explains how to record again in case your performance was not satisfactory.

1. Select a voice or voices (and other settings) for recording, if necessary.

Repeat Step 1 on page 26 if you wish to change the previous settings.

2. Re-engage Record Ready mode.

Press the [REC] button, again.

The selected track's indicator flashes in red.

Follow the procedure from Step 4 above to re-record.

(TIP)

If you want to change the tempo, time signature, reverb type, or effect type when re-recording a track or when recording to another track, do so after you engage Record Ready mode (step 2).

(NOTE)

You cannot re-record in the middle of a song.

Recording to the Second Track

This section explains how to record another part on the second track.

1. Select a voice or voices (and other settings) for the recording.

Select a voice (or voices) for recording. Select other settings, if necessary.

2. Re-engage Record Ready mode.

Press the [REC] button again.

The selected track's indicator flashes in red.

3. Select a recording track.

Select a track that you have not already used for recording. The selected track's indicator lights up red. (The indicator of a track that contains previously-recorded data will glow green.)

You can record new sounds and notes on each pass while listening to the recorded track.

Follow the procedure from Step 5 on page 27 to record.

The user song recorder records the following data:

Data in addition to the notes and voices you play is recorded.

This data includes "Individual Tracks" and "Entire Song." See below.

Individual Tracks

- Notes played
- Voice selection
- [VARIATION] ON/OFF
- Pedal (Sustain)
- [REVERB] depth
- [EFFECT] depth
- Dual mode voices
- Dual balance (F3)
- Dual detune (F3)
- Dual octave shift (F3)
- Split mode voices
- Split balance (F4)
- Split octave shift (F4)

Entire Song

- Tempo
- Time signature (beat)
- [REVERB] type (including OFF)
- [EFFECT] type (including OFF)

TIP

If you want to change the tempo, time signature, reverb type, or effect type when re-recording a track or when recording to another track, do so after entering Record Ready mode (step 2).

NOTE

If you don't want to hear the previously-recorded track while you record (for example, when you want to record a song different from what you recorded on the previous track), press the playback track button before pressing the [REC] button (step 2, on page 27, 28) so that its indicator is turned off.

Changing the Initial Settings (Data recorded at the beginning of a song)

The initial settings (data recorded at the beginning of a song) can be changed after the recording. For example, after recording, you can change the voice to create a different ambience or adjust the song tempo to your taste.

You can change the following initial settings.

Individual Tracks

- Voice selection
- [VARIATION] ON/OFF
- [REVERB] depth
- [EFFECT] depth
- Dual mode voices
- Split mode voices

Entire Song

- Tempo
- Time signature (beat)
- [REVERB] type (including OFF)
- [EFFECT] type (including OFF)

1. Engage Record mode and select a track to change the initial settings.

The indicator glows red. (Data shared by two tracks can be changed via either track.)

2. Change the settings via the panel controls.

For example, if you wish to change the recorded voice from [E. PIANO 1] to [E. PIANO 2], press the [E. PIANO 2] button.

Be careful not to press the SONG [START/STOP] button or a key on the keyboard, either of which will start recording and erase all previously-recorded data on the selected track.

3. Press the [REC] button to exit Record mode.

Be careful not to press the SONG [START/STOP] button or a key on the keyboard, either of which will start recording and erase all previously-recorded data on the selected track.

NOTE

You can cancel changes made to the initial settings by selecting a different track after Step 2, then exiting Record mode during Step 3 without pressing the [REC] button. (Changes made to the data shared by two tracks are also canceled.)

Playing Back Recorded Songs

You can play back songs recorded using the Record function (pages 26–29). You can also play the keyboard along with the playback.

NOTE

Song data is not transmitted via the MIDI connectors.

Playing Back a Song

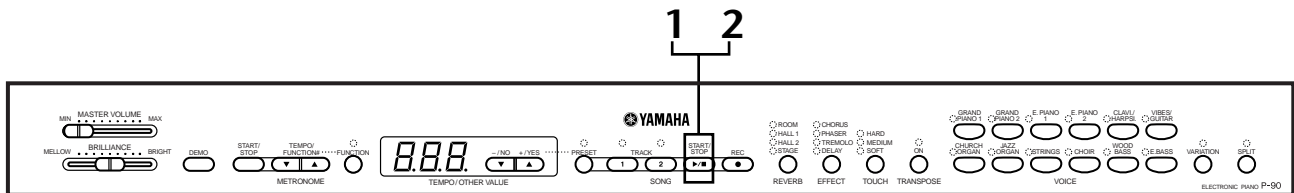

Procedure

1. Start playback.

Press the **SONG [START/STOP]** button.

The current measure number appears on the display during playback.



- You can play the keyboard while the P-90 is playing back a song. You can also play the notes in a voice different from the playback voice by selecting a voice from the panel.

Adjust the volume

Use the **[MASTER VOLUME]** control to adjust the volume.

Adjust the tempo

You can use the **[TEMPO/FUNCTION# ▼, ▲]** buttons to adjust the playback tempo as required before or during playback. The default tempo (the song's original tempo) is set when you press the **[▼]** and **[▲]** buttons simultaneously.

2. Stop playback.

When playback is complete, the P-90 automatically stops and locates the top of the song. To stop playback in the middle of a song, press the **SONG [START/STOP]** button.

NOTE

When the unit is in Demo Song or Preset Song mode, you cannot play back recorded songs.

NOTE

The track indicators will not light up green automatically when the power is turned on to the P-90, even if the user song recorder contains data. Make sure that you press the track buttons before you start playback.

NOTE

Playback cannot be started when the recorder contains no data.

TIP

You can also enjoy playing duets with yourself by recording one part of a duet or a song for two pianos, then playing the other part while the recorded part plays back.

TIP

If the metronome is being used during playback, the metronome will automatically stop when playback is stopped.

TIP

If the REVERB type is changed via the panel controls during playback, both the playback and keyboard reverb effects will be changed.

TIP

If the EFFECT type is changed via the panel controls during playback, the playback effect may be switched off in some cases.

Useful Playback Functions

Turning track playback on and off

When you select a song on the P-90, the indicators for tracks that contain data (one of [TRACK1] [TRACK2] or both) are lit in green. While the P-90 is playing or stopped, pressing these track buttons turns off the indicators, and the data on those tracks is not played. Pressing the track buttons toggles track playback on and off.

Starting playback automatically when you start playing the keyboard (Synchro Start)

You can start playback as soon as you start playing the keyboard. This is called the “Synchro Start” function.

To engage the Synchro Start function, press the **SONG [START/STOP]** button while holding a track button that is ON.

The right-most dot on the display will flash at the current tempo.

(Repeat the previous operation to disengage the Synchro Start function.)

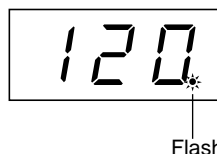

Playback will then start as soon as you begin playing on the keyboard.

This function is useful when you wish to match the timing of the beginning of the playback sound and the start of your own performance.

TIP

Tracks can be turned on or off before or during playback. If both tracks are turned off on the P-90, playback will not start (or the playback will stop).

TIP

You can adjust the volume of a part of a song from “50 Greats for the Piano” for which playback is turned off (pages 16, 39).

During recorder playback, the volume of a track that is turned off will always be “0.”

NOTE

If you press the **SONG [START/STOP]** button while holding down a track button that is OFF, track playback is turned on and the Synchro Start function is placed on stand-by.

TERMINOLOGY

Synchro:

Synchronous; occurring at the same time

Detailed Settings – [FUNCTION]

You can set various parameters to make the best use of P-90 functions, such as fine tuning the pitch, selecting a voice for the metronome, repeating playback, etc.

The following parameters are available.

The P-90 has nine main functions.

Some of these main functions consist of a set of sub-modes.

Parameter List

Function	Sub-Mode	P-90	Reference page
Fine Tuning of the Pitch	—	F1	35
Selecting a Scale	Scale	F2.1	36
	Base Note	F2.2	36
Dual Mode Functions	Dual Balance	F3.1	37
	Dual Detune	F3.2	37
	Voice 1 Octave Shift	F3.3	37
	Voice 2 Octave Shift	F3.4	37
	Voice 1 Effect Depth	F3.5	37
	Voice 2 Effect Depth	F3.6	37
	Reset	F3.7	37
Split Mode Functions	Split Point	F4.1	38
	Split Balance	F4.2	38
	Right Voice Octave Shift	F4.3	38
	Left Voice Octave Shift	F4.4	38
	Right Voice Effect Depth	F4.5	38
	Left Voice Effect Depth	F4.6	38
	Sustain Pedal Range	F4.7	38
	Reset	F4.8	38
Other Functions	Sustain Sample Depth	F5.1	39
	Keyoff Sample Volume	F5.2	39
Metronome Volume	—	F6	39
Preset Song Part Cancel Volume	—	F7	39
MIDI Functions	MIDI Transmit Channel Selection	F8.1	40
	MIDI Receive Channel Selection	F8.2	40
	Local Control ON/OFF	F8.3	40
	Program Change ON/OFF	F8.4	41
	Control Change ON/OFF	F8.5	41
	MIDI Transmit Transpose	F8.6	41
	Panel/Status Transmit	F8.7	41
	Bulk Data Dump	F8.8	42
Backup Functions	Voice	F9.1	42
	MIDI	F9.2	42
	Tuning	F9.3	42
	Others	F9.4	42

Basic Procedure in Function Mode

Follow the steps below to use the functions.

(If you become lost while using a function, return to this page and read the basic procedure.)

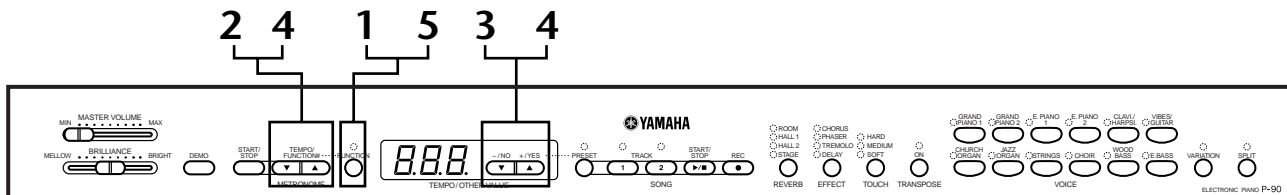

Procedure

1. Engage Function mode.

Press the [FUNCTION] button so that its [FUNCTION] indicator lights.

[F * . *] will appear on the display. (The indication of “* . *” varies depending on the status of the unit and usage.)

2. Select a function.

Use the [TEMPO/FUNCTION# ▼, ▲] buttons to select the desired function from F1–F9.

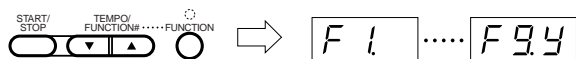

3. Use the [-/NO] [+ /YES] buttons.

If the function does not include sub-modes, start setting the parameters.

If the function includes sub-modes, press the [+ /YES] button once to enter the respective sub-mode.

4. Operate the desired function using the following two buttons.

- ① [TEMPO/FUNCTION# ▼, ▲]
Selects the desired function/sub-mode.
- ② [-/NO] or [+ /YES]
After you select the desired function or sub-mode, set the ON/OFF, select the type, or change the value, accordingly.
Depending on the setting, the default setting (which is used when you first turn on the power to the P-90) is recalled by pressing the [-/NO] and [+ /YES] buttons simultaneously.

NOTE

Functions cannot be selected during Demo/Preset Song mode or when the user song recorder is in operation.

NOTE

To cancel the function in Step 2, 3, or 4, press the [TEMPO/FUNCTION# ▼, ▲] button any time to exit Function mode.

TIP

After you select the function, the current setting will be displayed when the [-/NO] or [+ /YES] button is pressed for the first time.

Operation Example 1 (F1. Fine tuning of the pitch)

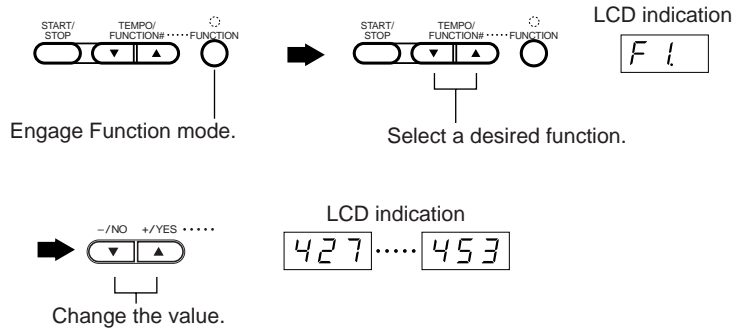

Operation Example 2 (F3.1 "Dual Balance")

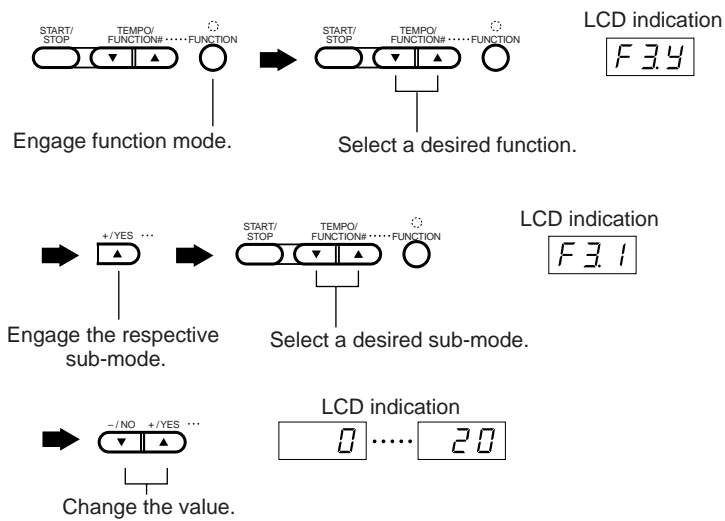

5. Do the following when you finish using the function.

Press the [FUNCTION] button to exit function mode. The [FUNCTION] button indicator will go dark.

About Each Function

F1. Fine Tuning of the Pitch

You can fine tune the pitch of the entire instrument. This function is useful when you play the P-90 along with other instruments or CD music.

1. Engage Function mode and select **[F1]**.
2. Use the **[-/NO]** and **[+/YES]** buttons to lower or raise the pitch of the A3 key in approximately 0.2 Hz increments.

[427].....[440].....[453]

Tenths of a hertz are indicated on the LED display by the appearance and position of one or two dots, as in the following example:

Display	Value
[440]	440.0
[440.]	440.2
[440.]	440.4
[440.]	440.6
[440.]	440.8

Setting range:
427.0–453.0 (Hz)

Normal setting:
440.0 (Hz)

TERMINOLOGY

Hz (Hertz):

This unit of measurement refers to the frequency of a sound and represents the number of times a sound wave vibrates in a second.

TIP

You can also use the keyboard to set the pitch (in any mode other than Function mode).

To tune up (in about 0.2Hz steps): Hold the A-1 and B-1 keys (two white keys at the left end) simultaneously and press any key between C3 and B3.

To tune down (in about 0.2Hz steps): Hold the A-1 and A[♯]-1 keys (a white and a black key at the left end) simultaneously and press any key between C3 and B3.

To restore standard pitch: Hold the A-1, A[♯]-1 and B-1 (two white keys and one black key at the left end) simultaneously and press any key between C3 and B3.

- Refer to “Part Names” on page 12 for information on the key and key name assignment.

(During the procedure described above, the display indicates a value in Hz <**[427]...[453]**>. After the procedure, the display returns to the previous indication.)

TIP

You can also tune in about 1Hz steps (in any mode other than Function mode).

To tune down or up, respectively, in approximately 1 Hz increments: Hold the A-1 and A[♯]-1 keys (a white and a black key at the left end) or A-1 and B-1 keys (two white keys at the left end) simultaneously and press the **[-/NO]** or **[+/YES]** button.

To restore standard pitch: Hold the A-1 and A[♯]-1 keys (a white and a black key at the left end) or A-1 and B-1 keys (two white keys at the left end) simultaneously and press the **[-/NO]** **[+/YES]** buttons simultaneously.

(During the procedure described above, the display indicates a value in Hz <**[427]...[453]**>. After the procedure, the display returns to the previous indication.)

F2. Selecting a Scale

You can select various scales.

Equal Temperament is the most common contemporary piano tuning scale. However, history has known numerous other scales, many of which serve as the basis for certain genres of music.

1. Engage Function mode and select **[F2.4]**.
2. Press the **[+/YES]** button to engage the scale function's sub-mode, then use the **[TEMPO/FUNCTION# ▼, ▲]** buttons to select the desired sub-mode.
Press the **[-/NO]** and **[+/YES]** buttons to select the number of the desired tuning.

Sub-mode

[F2.1] Scale

Setting range: 1: Equal Temperament
2: Pure Major
3: Pure Minor
4: Pythagorean
5: Mean Tone
6: Werckmeister
7: Kirnberger

Normal setting: 1: Equal Temperament

[F2.2] Base Note

If you select a scale other than Equal Temperament, you need to specify the root. (You can specify the root note with Equal Temperament selected, but it is not effective. The base note setting is effective for tunings other than the Equal Temperament tuning.)

Setting range: C, C[♯], D, E[♭], E, F, F[♯], G, A[♭], A, B[♭], B

Normal setting: C

- Root indication example

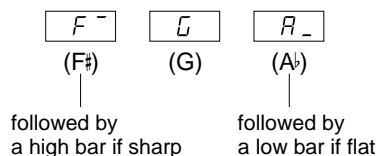

TERMINOLOGY

Equal:

One octave is divided into twelve equal intervals. Currently the most popular piano tuning scale.

PureMajor/PureMinor:

Based on natural overtones, three major chords using these scales produce a beautiful, pure sound. They are sometimes used for chorus parts.

Pythagorean:

This scale, designed by Pythagoras, a Greek philosopher, is based on the interval of a perfect 5th.

The 3rd produces swells, but the 4th and 5th are beautiful and suitable for some leads.

MeanTone:

This scale is an improvement of the Pythagorean in that the swell of the 3rd has been eliminated. The scale became popular during the late 16th century through the late 18th century, and was used by Handel.

Werckmeister/KirnBerger:

These scales combine Mean Tone and Pythagorean in different ways. With these scales, modulation changes the impression and feel of the songs. They were often used in the era of Bach and Beethoven. They are often used today to reproduce the music of that era on harpsichords.

F3. Dual Mode Functions

You can set various parameters for Dual mode to optimize the settings for the songs you play, such as adjusting the volume balance between two voices.

Dual mode function settings are set individually for each voice combination.

1. Select the voices in Dual mode and engage Function mode and select **F34**.
2. Press the [+ / YES] button to engage the Dual mode function's sub-mode, then use the [TEMPO / FUNCTION# ▼, ▲] buttons to select the desired sub-mode. Press the [- / NO] [+ / YES] button to assign values.

NOTE

If Dual mode is not engaged, **F3-** will appear instead of **F34** and you will be unable to select Dual mode functions. You can switch from Function mode to Dual mode.

Sub-mode

F31 Dual Balance

Setting range: 0 – 20

A setting of “10” produces an equal balance between the two Dual mode voices. Settings below “10” increase the volume of Voice 2 in relation to Voice 1, and settings above “10” increase the volume of Voice 1 in relation to Voice 2.

Normal setting: Different for each voice combination.

You can set one voice as the main voice, and another voice as a softer, mixed voice.

F32 Dual Detune

Setting range: -10 – 0 – 10

With positive values, the pitch of Voice 1 is raised and the pitch of Voice 2 is lowered. With negative values, the pitch of Voice 1 is lowered and the pitch of Voice 2 is raised.

TIP

The available setting range is wider in the lower range (± 60 cents for A-1), and narrower in the higher range (± 5 cents for C7). (100 cents equal one semitone.)

Normal setting: Different for each voice combination.

Detune Voice 1 and Voice 2 for Dual mode to create a thicker sound.

F33 Voice 1 Octave Shift

F34 Voice 2 Octave Shift

Setting range: -1, 0, 1

Normal setting: Different for each voice combination.

You can shift the pitch up and down in octave steps for Voice 1 and Voice 2 independently. Depending on which voices you combine in Dual mode, the combination may sound better if one of the voices is shifted up or down an octave.

F35 Voice 1 Effect Depth

F36 Voice 2 Effect Depth

Setting range: 0 – 20

Normal setting: Different for each voice combination.

These functions make it possible to individually set the depth of the effect for Voices 1 and 2 for Dual mode. (The effect depth settings cannot be changed unless the [EFFECT] is ON. Function mode must be exited before the [EFFECT] can be turned ON.)

- “Voice 1” and “Voice 2” are explained on page 23.

F37 Reset

This function resets all Dual mode functions to their default values. Press the [+ / YES] button to reset the values.

TIP

SHORTCUT:

You can jump directly to the Dual mode functions **F3*** by pressing the [FUNCTION] button while holding the two Dual mode voice buttons.

Even if you entered a Function mode via a shortcut, you must use the usual method to exit (i.e., press [FUNCTION] button to make the function indicator go dark).

F4. Split Mode Functions

This menu enables you to make various detailed settings for Split mode.

By changing the split point or other setting, you can optimize the settings for the songs you play.

1. Select the voices in Split mode and engage Function mode and select **[F44]**.
2. Press the **[+/YES]** button to engage the Split mode function's sub-mode, then use the **[TEMPO/FUNCTION# ▼, ▲]** buttons to select the desired sub-mode. Press the **[-/NO]** **[+/YES]** button to assign values.

NOTE

If Split mode is not engaged, **[F4-]** will appear instead of **[F44]** and you will be unable to select Split mode functions. Also note that you must exit Function mode before you can engage Split mode.

Sub-mode

[F41] Split Point

Setting range: The entire keyboard

Normal setting: F#2

Set the point on the keyboard that separates the right and left-hand sections (split point). The pressed key is included in the left-hand range.

- Instead of pressing the **[-/NO]** **[+/YES]** buttons, you can engage the split point by pressing the appropriate key on the keyboard.
- If Function mode is not engaged, you can change the split point to any other key by pressing the key while holding the **[SPLIT]** button (page 24).
- An example of a key name indication for a split point

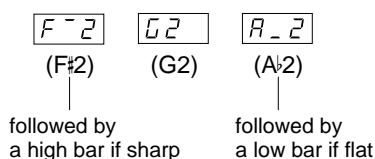

[F42] Split Balance

Setting range: 0 – 20

A setting of “10” produces an equal balance between the two Split mode voices. Settings below “10” increase the volume of the left voice in relation to the right voice, and settings above “10” increase the volume of the right voice in relation to the left voice.

Normal setting: Different for each voice combination.

The volume level of the two voices combined in Split mode can be adjusted as required.

You can make this setting for each combination of the songs you play.

[F43] Right Voice Octave Shift

[F44] Left Voice Octave Shift

Setting range: -1, 0, 1

Normal setting: Different for each voice combination

You can shift the pitch up and down in octave steps for the Right Voice and Left Voice independently. Make a setting depending on the note range of the songs you play.

You can make these settings for each combination of voices individually.

[F45] Right Voice Effect Depth

[F46] Left Voice Effect Depth

Setting range: 0 – 20

Normal setting: Different for each voice combination

These functions make it possible to individually set the depth of the effect for the left and right Split mode voices.

You can make these settings for each combination of voices individually.

The effect depth settings cannot be changed unless the **[EFFECT]** is ON. You must exit Function mode before you can turn on an **[EFFECT]**.

[F47] Sustain Pedal Range

Setting range: ALL (for both voices)
1 (for the right Voice)
2 (for the left Voice)

Normal setting: ALL

The Sustain Pedal Range function determines whether the sustain pedal affects the right voice, the left voice, or both the left and right voices in Split mode.

[F48] Reset

This function resets all Split mode functions to their default values. Press the **[+/YES]** button to reset the values.

TIP

SHORTCUT:

You can jump directly to Split mode functions **[F4*]** by pressing the **[FUNCTION]** button while holding the **[SPLIT]** button. Even if you entered a Function mode via a shortcut, you must use the usual method to exit (i.e., press **[FUNCTION]** button to make the function indicator go dark).

F5. Other Functions

This function conveniently lets you set operation of the sustain pedal to one of the modes listed below.

1. Engage Function mode and select **[F5.4]**.
2. Press the [+ / YES] button to engage the other functions' sub-mode, then use the [TEMPO / FUNCTION# ▼, ▲] buttons to select the desired sub-mode.
Press the [- / NO] or [+ / YES] button to select the desired pedal function or assign the values.

Sub-mode

[F5.1] Sustain Sample Depth

Setting range: 0 – 20

Normal setting: 12

The [GRAND PIANO 1] voices feature special “Sustain Samples” that recreate the unique resonance of an acoustic grand piano’s soundboard and strings when the sustain pedal is pressed. This function lets you adjust the depth of this effect.

[F5.2] Key-off Sample Volume

Setting range: 0 – 20

Normal setting: 10

You can adjust the volume of the keyoff sound (the subtle sound produced when the keys are released) for voices [GRAND PIANO1], [CLAVI./HARPSI.] (including their variations).

F6. Metronome Volume

You can change the volume of the metronome sound.

Use this function to adjust the metronome volume.

1. Engage Function mode and select **[F6]**.
2. Use the [- / NO] and [+ / YES] buttons to set the metronome volume as required.

Setting range: 1 – 20

Normal setting: 10

TIP

SHORTCUT:

You can jump directly to the metronome functions **[F6]** by pressing the [FUNCTION] button while holding the METRONOME [START/STOP] button.

Even if you entered a Function mode via a shortcut, you must use the usual method to exit (i.e., press [FUNCTION] button to make the function indicator go dark).

F7. Preset Song Part Cancel Volume

This function sets the volume at which a “canceled” part is played during preset song playback. Adjust the part volume to a comfortable level and use the “canceled” part as a guide with which to play along.

1. Engage Function mode and select **[F7]**.
2. Use the [- / NO] and [+ / YES] buttons to set the volume as required.

Setting range: 0 – 20

Normal setting: 5

F8. MIDI Functions

You can make detailed adjustments to MIDI settings.

For more information about MIDI, see the “About MIDI” section (page 44).

TIP

The [HOST SELECT] switch on the bottom surface must be set to “MIDI” to enable the MIDI connectors. When you use the [TO HOST] connector, set the [HOST SELECT] switch to the appropriate position for the type of computer you are using (pages 44–48). In this situation, all MIDI settings described below will affect the MIDI signal in and out of the [TO HOST] connector.

1. Engage Function mode and select **[F8.4]**.
2. Press the [+ / YES] button to engage the MIDI function's sub-mode, then use the [TEMPO / FUNCTION# ▼, ▲] buttons to select the desired sub-mode.
Press the [- / NO] or [+ / YES] button to set a selected parameter.

Sub-mode

[F8.1] MIDI Transmit Channel Selection

In any MIDI control setup, the MIDI channels of the transmitting and receiving equipment must be matched for proper data transfer.

This parameter enables you to specify the channel on which the P-90 transmits MIDI data.

Setting range: 1 – 16, OFF (not transmitted)

Normal setting: 1

NOTE

In Dual mode, Voice 1 data is transmitted on its specified channel. In Split mode, right voice data is transmitted on its specified channel. In Dual mode, Voice 2 data is transmitted on the next greater channel number relative to the specified channel. In Split mode, left voice data is transmitted on the next greater channel number relative to the specified channel. In either mode, no data is transmitted if the transmit channel is set to “OFF”.

NOTE

Demo/preset song data and recorder playback data are not transmitted via MIDI.

[F8.2] MIDI Receive Channel Selection

In any MIDI control setup, the MIDI channels of the transmitting and receiving equipment must be matched for proper data transfer. This parameter enables you to specify the channel on which the P-90 receives MIDI data.

Setting range: ALL, 1&2, 1 – 16

Normal setting: ALL

TIP

ALL:

A “Multi-timbre” Receive mode is available. It allows simultaneous reception of different parts on all 16 MIDI channels, enabling the P-90 to play multi-channel song data received from a music computer or sequencer.

1&2:

A “1&2” Receive mode is available. It allows simultaneous reception on channels 1 and 2 only, enabling the P-90 to play 1 and 2 channel song data received from a music computer or sequencer.

TIP

Program change and other like channel messages received will not affect the P-90's panel settings or the notes you play on the keyboard.

NOTE

No MIDI reception occurs when Demo/Preset Song mode is engaged.

[F8.3] Local Control ON/OFF

“Local Control” refers to the fact that, normally, the P-90 keyboard controls its internal tone generator, allowing the internal voices to be played directly from the keyboard. This situation is “Local Control On,” since the internal tone generator is controlled locally by its own keyboard.

Local control can be turned OFF, however, so that the P-90 keyboard does not play the internal voices, but the appropriate MIDI information is still transmitted via the MIDI OUT connector when notes are played on the keyboard. At the same time, the internal tone generator responds to MIDI information received via the MIDI IN connector.

Setting range: ON/OFF

Normal setting: ON

F B 4 Program Change ON/OFF

Normally the P-90 will respond to MIDI program change numbers received from an external keyboard or other MIDI device, causing the correspondingly-numbered voice to be selected on the corresponding channel (the keyboard voice does not change). The P-90 will normally also send a MIDI program change number whenever one of its voices is selected, causing the correspondingly-numbered voice or program to be selected on the external MIDI device if the device is set up to receive and respond to MIDI program change numbers.

This function makes it possible to cancel program change number reception and transmission so that voices can be selected on the P-90 without affecting the external MIDI device.

TIP

For information on program change numbers for each of the P-90's voices, refer to page 56 in the MIDI Data Format section.

Setting range: ON/OFF

Normal setting: ON

F B 5 Control Change ON/OFF

Normally the P-90 will respond to MIDI control change data received from an external MIDI device or keyboard, causing the voice on the corresponding channel to be affected by pedal and other "control" settings received from the controlling device (the keyboard voice is not affected).

The P-90 also transmits MIDI control change information when the pedal or other appropriate controls are operated.

This function makes it possible to cancel control change data reception and transmission so that, for example, the P-90's pedal and other controls can be operated without affecting an external MIDI device.

TIP

For information on control changes that can be used with the P-90, refer to the MIDI Data Format on page 56.

Setting range: ON/OFF

Normal setting: ON

F B 6 MIDI Transmit Transpose

This function allows the MIDI note data transmitted by the P-90 to be transposed up or down in semitone increments by up to plus or minus 12 semitones. The pitch of the P-90 itself is not affected.

Setting range: -12 – 0 – 12 (in semitones)

Normal setting: 0

F B 7 Panel/Status Transmit

This function causes all the current P-90 panel settings (selected voice, etc.) to be transmitted via the MIDI OUT terminal. This is particularly useful if you will be recording performances to a MIDI sequence recorder, such as the Yamaha MIDI Data Filer MDF3, which will be used to control the P-90 on playback. By transmitting the P-90 panel settings and recording them on the MIDI sequence recorder prior to the actual performance data, the P-90 will be automatically restored to the same settings when the performance is played back.

TERMINOLOGY**Setup Data:**

Data that contains a set of panel settings for the P-90.

Procedure

1. Set up the panel controls as desired.
2. Connect the P-90 to a sequencer via MIDI, and set up the sequencer so it can receive the setup data.
3. Engage Function mode and select **F B 7**.
4. Press the **[+/YES]** button to transmit the panel/status data.

End will appear on the LED display when the data has been successfully transmitted.

TIP

See page 57 for a list of the "Panel Data Contents" transmitted by this function.

TIP**Receiving the transmitted data:**

1. Connect the P-90 via MIDI to the device to which the setup data was transmitted previously.
2. Start sending the setup data from the device.
The P-90 automatically receives the setup data, which will be reflected in the panel settings.
(For the data to be accepted, the P-90 that receives the setup data should be the same model as the one that transmitted the setup data to the sequencer.)

TIP

For more information on transmitting and receiving setup data via MIDI, refer to the owner's manual for the connected MIDI device.

F88 Bulk Data Dump

You can save current song data on the P-90 as MIDI bulk data by transferring it to a connected MIDI data filer (such as an MDF3) or a sequencer. To play back the saved song data, send the bulk data back from the storage device to the P-90 and follow the usual playback procedure.

TERMINOLOGY**Bulk Data:**

A complete set or extended sequence of data

Procedure

1. Record your performance on the P-90.
2. Connect the P-90 to MDF3, a MIDI data filer via MIDI, and set up the MDF3 so it will receive bulk data.
3. Engage Function mode and select **F88**.
4. Press the **[+/YES]** button to begin bulk transmission.

END will appear on the LED display when the data has been successfully transmitted.

NOTE

No MIDI note/panel data transmission or data reception occurs during a bulk data dump transmit operation.

TIP**Receiving (returning) the transmitted data:**

1. Connect the P-90 via MIDI to the device to which the data was previously transmitted.
2. Start sending the data from the device.

The P-90 automatically receives the data from the unit. (At this time, any data previously stored in the P-90 will be erased.)

Then, follow the usual playback procedure.

(For the data to be accepted, the P-90 that receives the data should be the same model as the one from which the data was once transmitted to the MIDI data filer.)

NOTE

The reload operation cannot be executed when Demo/Preset Song mode or the user song recorder is in operation, or when Function mode is engaged.

TIP

For more information on transmitting and receiving bulk data via MIDI, refer to the owner's manual for the connected MIDI device.

F9. Backup Functions**TERMINOLOGY****Backup:**

You can back up some settings, such as voice selection and reverb type, so that they will not be lost when you turn off the power to the P-90.

If the backup function is turned on, the settings at power off are effective. If the backup function is turned off, the settings in memory are erased when you turn off the power. In this case, when you turn on the power to the unit, the default settings (the initial settings) will be used. (The factory setting default list is found on page 55.)

However, the backup settings themselves, and the contents of the user song recorder memory, are always backed up.

CAUTION

Even if the backup function is turned on via one of the functions described below, the data will be retained in memory for only about one week if the power is not turned on during this time. If the backup period is exceeded, all settings will be reset to their default values. If you want to retain the backup settings for longer periods, be sure to turn the power on for a few minutes at least once a week.

You can turn the backup function on or off for each function group (each of the following sub-mode functions).

1. Engage Function mode and select **F94**.
2. Press the **[+/YES]** button to engage the backup function's sub-mode, then use the **[TEMPO/FUNCTION# ▼, ▲]** buttons to select the desired sub-mode.
Press the **[-/NO]** or **[+/YES]** button to turn the backup function on or off.

Sub-mode**F91** Voice**F92** MIDI**F93** Tuning**F94** Others**Setting range:** ON/OFF**Normal setting:** OFF (all groups)

Description of sub-modes

Voice

- Voice (Keyboard, Dual, and Split)
- Dual (ON/OFF, Voice, and Dual Functions for each voice combination)
- Split (ON/OFF, Voice, and Split Functions for each voice combination)
- Reverb (ON/OFF, Type, and Depth for each voice)
- Effect (ON/OFF, Type, and Depth for each voice)
- Touch Sensitivity (including the FIXED volume)
- Metronome (Beat, Volume < [F 5] settings >)
- Preset Song Part Cancel Volume ([F 7] settings)

[F 9 2] MIDI

- The MIDI functions ([F B *] settings)
(expect for the [F B 7] [F B B])

[F 9 3] Tuning

- Transpose
- Tuning ([F t] settings)
- Scale (including base note) ([F 2 *] settings)

[F 9 4] Others

- Other functions ([F 5 *])

Factory Preset Recall

All Dual mode, Split mode, reverb, effect, touch sensitivity, tuning settings, and the settings affected by the Backup Functions can be restored to their original factory preset values by holding the C7 key (right-most key on the keyboard) while turning the [STANDBY/ON] switch ON. This also erases all user song recorder data, and sets all backup on/off settings (F9) to "OFF". (The factory setting list is found on page 55.)

About MIDI

MIDI (Musical Instrument Digital Interface) is a standard format for data transmission/reception. It enables the transfer of performance data and commands between MIDI devices and personal computers.

Using MIDI, you can control a connected MIDI device from the P-90, or control the P-90 from a connected MIDI device or computer.

MIDI connectors

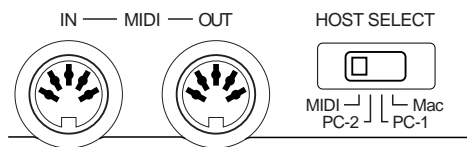

MIDI [IN]: Receives MIDI data.

MIDI [OUT]: Transmits MIDI data.

MIDI cables

Prepare dedicated MIDI cables.

[TO HOST] connector

Use this connector to connect the P-90 to a computer.

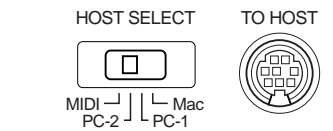

TIP

MIDI performance data and commands are transferred in the form of numeric values.

TIP

Since MIDI data that can be transmitted or received varies depending on the type of MIDI device, check the "MIDI Implementation Chart" to find out what MIDI data and commands your devices can transmit or receive. The P-90's MIDI Implementation Chart appears on page 60.

NOTE

When you are using the MIDI connectors, set the **[HOST SELECT]** switch to "MIDI" (page 47).

NOTE

When you are using the **[TO HOST]** connector, set the **[HOST SELECT]** switch, according to the type of computer you are using (page 47).

TIP

You can also obtain detailed information about MIDI from various music books and other publications.

Connecting a Personal Computer

You can enjoy computer music data on the P-90 by connecting a computer to the [TO HOST] (or MIDI) connector.

NOTE

When the P-90 is used as a tone module, performance data with voices that are not found on the P-90 will not be played correctly.

There are three methods by which to connect the P-90 to a personal computer:

1. Connect the serial port on the computer to the P-90's [TO HOST] connector (page 46).
2. Use a MIDI interface and the P-90's MIDI connectors (page 47).
3. Use the USB port on the computer and the UX256, UX96, or UX16, a USB interface (page 48).

For more information, refer to the specified pages.

NOTE

When connecting the P-90 to a personal computer, first turn off the power to both the P-90 and the computer before you connect any cables or set the [HOST SELECT] switch. After making the connections and switch settings, turn on the power to the computer first, then to the P-90.

NOTE

If you do not use the [TO HOST] connector of the P-90, make sure you disconnect the cable from the jack. If the cable is left connected, the P-90 may not function properly.

NOTE

[HSF] will appear in the display if the host computer is not turned on, the connecting cable is not properly connected, the [HOST SELECT] switch is not in the proper position, or the MIDI driver or MIDI application is not active. In this situation, turn the power off to both the P-90 and the computer, and check the cable connection and the position of the [HOST SELECT] switch. Once the connection and [HOST SELECT] switch position is verified, turn the power of the computer on first, then the P-90, and check whether the MIDI driver and MIDI application function properly.

NOTE

When the [HOST SELECT] switch is set to "PC-1," "PC-2," or "Mac," you can use the [TO HOST] connector, but the MIDI connectors are disabled since no data transfer occurs via the MIDI connectors. On the other hand, when the [HOST SELECT] switch is set to "MIDI," you can use the MIDI connectors, but not the [TO HOST] connector since no data is transferred via the [TO HOST] connector.

1. Connecting the serial port on the computer to the P-90's [TO HOST] connector

Connect the computer's serial port (RS-232C or RS-422) to the P-90's [TO HOST] connector. With this connection, the P-90 functions as a MIDI interface. Therefore, you do not need a special MIDI interface.

Connection

Use a special serial cable (page 46) to connect the computer's serial port (RS-232C or RS-422) to the P-90's [TO HOST] connector.

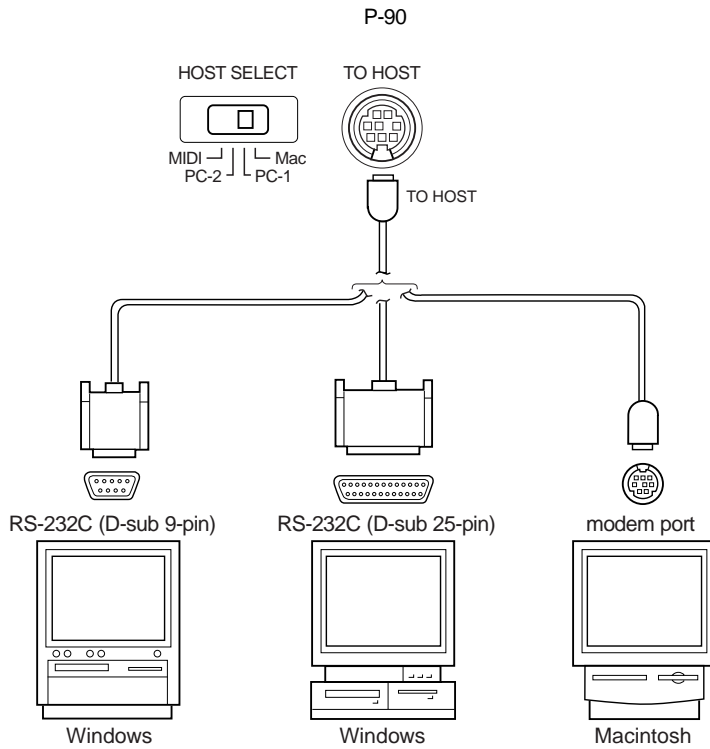

Note for Windows users (regarding the MIDI driver)
 To transfer data via the computer's serial port and the P-90's [TO HOST] connector, you need to install a specific MIDI driver (the Yamaha CBX driver for Windows). You can download this driver from the following XG Library on the Yamaha web site:
<http://www.yamaha-xg.com>

Type of serial cables and connection pin assignments

Depending on the type of computer you connect, use one of the following serial cables.

Windows (with a serial port of D-sub 9-pin)

8-pin mini DIN plug → D-sub 9-pin plug
 (Yamaha CCJ-PC2 or equivalent)

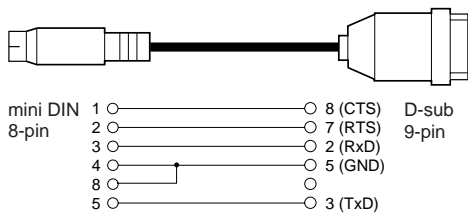

Macintosh

System peripheral plug → 8-pin plug
 (Yamaha CCJ-MAC or equivalent)

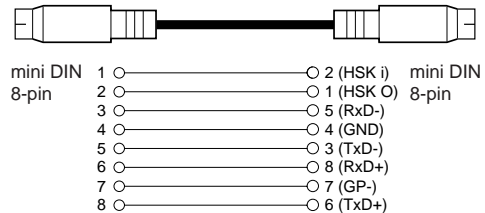

Windows (with a serial port of D-sub 25-pin)

8-pin mini DIN plug → D-sub 25-pin plug
 (Yamaha CCJ-PC1NF or equivalent)

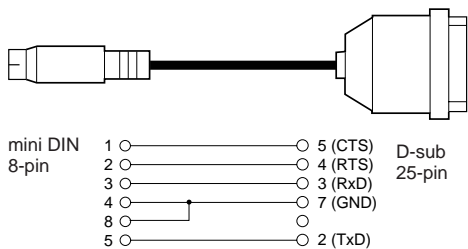

Pin assignment

The following diagram shows the pin assignments for each cable.

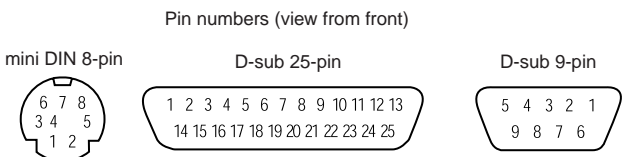

P-90 [HOST SELECT] switch setting

Set the P-90 [HOST SELECT] switch properly according to the type of connected computer.

- **Macintosh:** “Mac” (data transfer rate: 31,250bps, 1MHz clock)
- **Windows:** “PC-2” (data transfer rate: 38,400bps)



If your system does not work properly with the connections and settings listed above, your software may require different settings. Check your software operation manual and set the [HOST SELECT] switch to the proper data transfer rate. (Data transfer rate of “PC-1” is 31,250bps.)

2. Using a MIDI interface and the P-90’s MIDI connectors

Connection

Use a MIDI interface device to connect a computer to the P-90 using special MIDI cables.

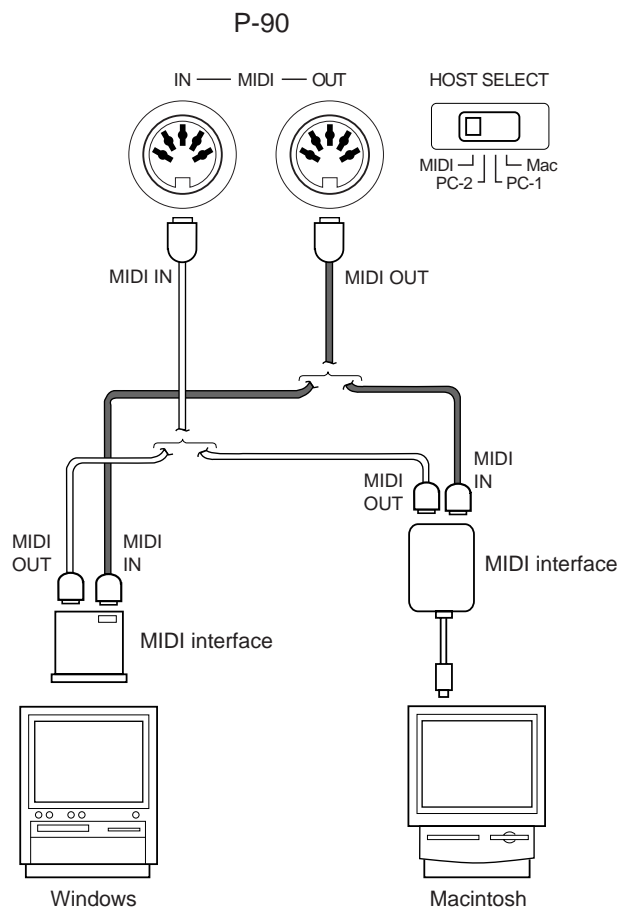

P-90 [HOST SELECT] switch setting

Set the P-90 [HOST SELECT] switch to “MIDI.”

3. Connecting the computer's USB port to the P-90 via a USB interface, such as the UX256, UX96, or UX16

Connect the computer's USB port to the USB interface (such as the UX256, UX96, or UX16) using a USB cable. Install the driver (that came with the USB interface) on the computer, and connect the USB interface to the P-90 using a serial cable or MIDI cables.

For more information, refer to the instruction manual for the USB interface.

An example of connecting the USB interface to the P-90 using a serial cable

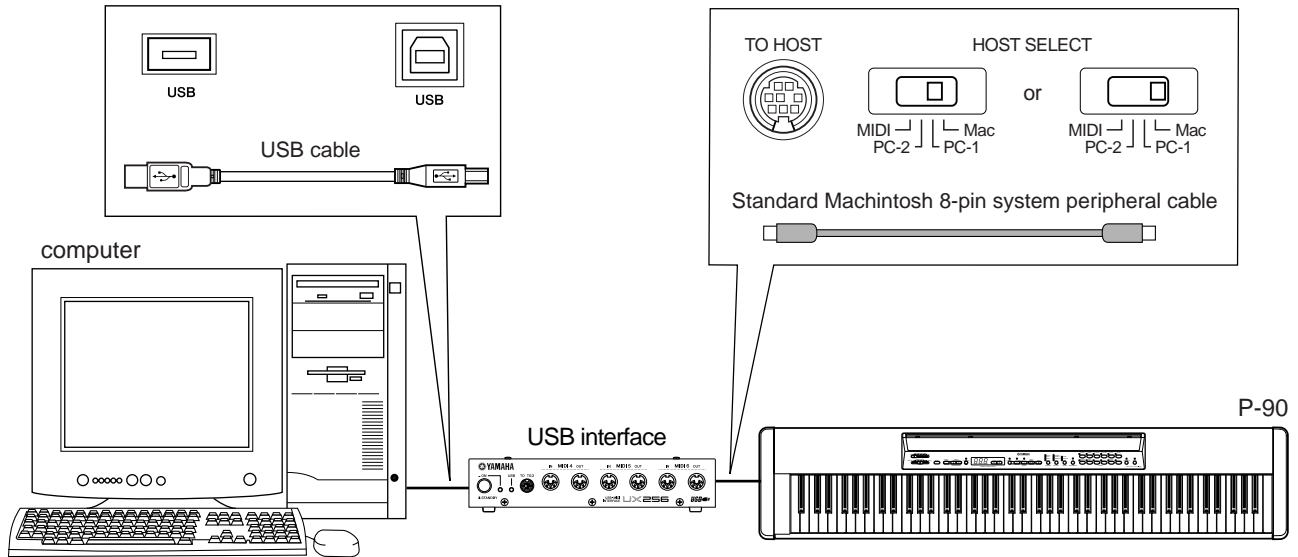

An example of connecting the USB interface to the P-90 using MIDI cables

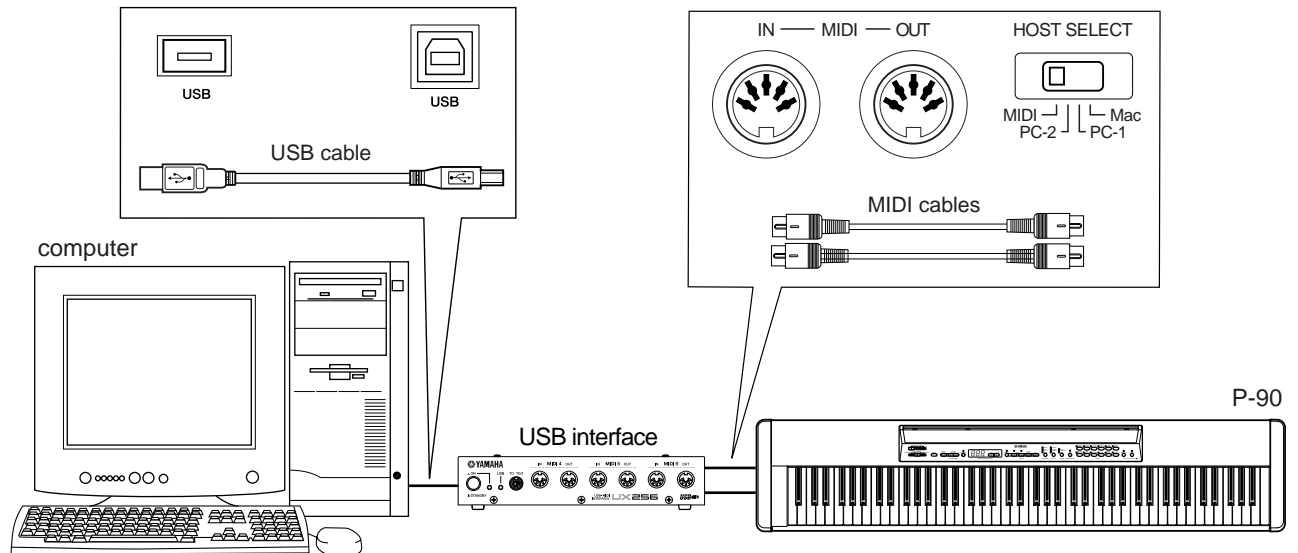

Troubleshooting

Problem	Possible Cause and Solution
The P-90 does not turn on.	The P-90 has not been plugged in properly. Insert the adaptor plug into an AC outlet and the adaptor socket into the unit securely. (page 8).
A click or pop is heard when the power is turned on or off.	This is normal when electrical current is being applied to the instrument.
Noise from the speakers or headphones is audible.	The noise may be due to interference caused by the use of a mobile phone in close proximity to the P-90. Turn off the mobile phone, or move it further away from the P-90.
The overall volume is low, or no sound is heard.	<ul style="list-style-type: none">• The Master Volume is set too low. Set it to an appropriate level using the [MASTER VOLUME] control.• Make sure that Local Control (page 40) is ON.
The foot pedal has no effect, or the sound continuously sustains even when the foot pedal is not pressed.	The pedal cord may not be properly connected. Make sure to securely insert the pedal cord into the [SUSTAIN] jack (page 10).
The foot pedal seems to produce the opposite effect. For example, pressing the foot switch cuts off the sound and releasing it sustains the sounds.	The polarity of the foot pedal is reversed. Make sure that the foot pedal plug is properly connected to the [SUSTAIN] jack before turning on the power. Do not press the pedal while turning the power on.

TIP

If **[5 c n]** appears on the display, an internal malfunction has occurred. In this case, contact your Yamaha dealer.

Preset Voice List

Printed on the panel	[VARIATION] button	Voice Name	Stereo Sampling	Touch Response	Dynamic Sampling ^{*1}	Key-Off Sampling ^{*2}	Voice Descriptions
GRAND PIANO 1	OFF	GrandPiano 1	✓	✓	✓	✓	Recorded samples from a full concert grand piano. Also includes three levels of dynamic sampling, sustain samples, and key-off samples for exceptionally realistic acoustic grand piano sound. Perfect for classical compositions as well as any other style that requires acoustic piano.
	ON	(Variation)	✓	✓	✓	✓	Warm and mellow piano. Good for classical compositions.
GRAND PIANO 2	OFF	GrandPiano 2	✓	✓			Spacious and clear piano with bright reverb. Good for popular music.
	ON	(Variation)	✓	✓			Bright, spacious piano. Good for popular or rock music.
E.PIANO1	OFF	E.Piano1		✓	✓		An electronic piano sound created by FM synthesis. Extremely "musical" response with varying timbre according to keyboard dynamics. Good for standard popular music.
	ON	(Variation)		✓			A synth-generated type electronic piano sound often heard in popular music. Used in the DUAL mode it blends well with an acoustic piano voice.
E.PIANO2	OFF	E.Piano2		✓	✓		The sound of an electric piano using hammer-struck metallic "tines". Soft tone when played lightly, and an aggressive tone when played hard.
	ON	(Variation)		✓			A slightly different electric piano sound often heard in rock and popular music.
CLAVI./ HARPSI.	OFF	Clavi.		✓		✓	A hammer-struck keyboard instrument that utilizes an electric pickup that is often heard in funk and soul music. Its tone is noted for the unique sound produced when the keys are released.
	ON	Harpsichord	✓			✓	The definitive instrument for baroque music. Since harpsichord uses plucked strings, there is no touch response. There is, however, a characteristic additional sound when the keys are released.
VIBES/ GUITAR	OFF	Vibraphone	✓	✓	✓		Vibraphone played with relatively soft mallets. The tone becomes more metallic the harder you play.
	ON	NylonGuitar		✓			Warm and natural-sounding nylon guitar. Enjoy the quiet ambience of nylon strings.

Printed on the panel	[VARIATION] button	Voice Name	Stereo Sampling	Touch Response	Dynamic Sampling ^{*1}	Key-Off Sampling ^{*2}	Voice Descriptions
CHURCH ORGAN	OFF	ChurchOrgan	✓				This is a typical pipe organ sound (8 feet + 4 feet + 2 feet). Good for sacred music from the Baroque period.
	ON	(Variation)	✓				This is the organ's full coupler sound often associated with Beach's "Toccata and Fugue".
JAZZ ORGAN	OFF	JazzOrgan					The sound of a "tonewheel" type electric organ. Often heard in jazz and rock idioms.
	ON	(Variation)					Uses a rotary speaker effect with a different speed. The variations speed is faster. If the variation is selected while holding a chord, the speed of the effect will gradually change.
STRINGS	OFF	Strings	✓	✓			Stereo-sampled, large-scale strings ensemble with realistic reverb. Try combining this voice with piano in the DUAL mode.
	ON	SlowStrings		✓			Spacious strings ensemble with a slow attack. Try combining this voice with a piano or electric piano in the DUAL mode.
CHOIR	OFF	Choir		✓			A big, spacious choir voice. Perfect for creating rich harmonies in slow pieces.
	ON	SlowChoir		✓			A choir voice with a slow attack. Try combining this voice with a piano or electric piano in the DUAL mode.
WOOD BASS	OFF	WoodBass		✓			An upright bass played fingerstyle. Ideal for jazz and Latin music.
	ON	(Variation)		✓			Adds a cymbal voice to the bass sound. Ideal for walking bass lines in jazz tunes.
E.BASS	OFF	E.Bass		✓			Electric bass for a wide range of music styles, jazz, rock, popular, and more.
	ON	(Variation)		✓			A fretless bass good for styles such as jazz, fusion, etc.

*1. Dynamic Sampling provides multiple velocity-switched samples to accurately simulate the timbral response of an acoustic instrument.

*2. Contains a very subtle sample that is produced when the keys are released.

Demo Song List

Piano Voice Demo Description

Printed on the panel	Piano Voice Demo
GRAND PIANO1	Stereo sampling
GRAND PIANO2	Monaural sampling
E.PIANO1	Dynamic sampling; mezzo piano
E.PIANO2	Dynamic sampling; mezzo forte
CLAVI./HARPSI.	Dynamic sampling; forte
VIBES/GUITAR	With sustain sampling
CHURCH ORGAN	Without sustain sampling
JAZZ ORGAN	With key-off sampling
STRINGS	Without key-off sampling

Preset Song List

No.	Title	Composer
1	Invention No. 1	J.S.Bach
2	Invention No. 8	J.S.Bach
3	Gavotte	J.S.Bach
4	Prelude (Wohltemperierte Klavier I No.1)	J.S.Bach
5	Menuett G dur BWV.Anh.114	J.S.Bach
6	Le Coucou	L.-C.Daquin
7	Piano Sonate No.15 K.545 1st mov	W.A.Mozart
8	Turkish March	W.A.Mozart
9	Menuett G dur	W.A.Mozart
10	Little Serenade	J.Haydn
11	Perpetuum mobile	C.M.v.Weber
12	Ecosaise	L.v.Beethoven
13	Für Elise	L.v.Beethoven
14	Marcia alla Turca	L.v.Beethoven
15	Piano Sonate op.13 "Pathétique" 2nd mov.	L.v.Beethoven
16	Piano Sonate op.27-2 "Mondschein" 1st mov.	L.v.Beethoven
17	Piano Sonate op.49-2 1st mov.	L.v.Beethoven
18	Impromptu op.90-2	F.P.Schubert
19	Moments Musicaux op.94-3	F.P.Schubert
20	Frühlingslied op.62-2	J.L.F.Mendelssohn
21	Jägerlied op.19b-3	J.L.F.Mendelssohn
22	Fantaisie-Impromptu	F.F.Chopin
23	Prelude op.28-15 "Raindrop"	F.F.Chopin
24	Etude op.10-5 "Black keys"	F.F.Chopin
25	Etude op.10-3 "Chanson de l'adieu"	F.F.Chopin

No.	Title	Composer
26	Etude op.10-12 "Revolutionary"	F.F.Chopin
27	Valse op.64-1 "Petit chien"	F.F.Chopin
28	Valse op.64-2	F.F.Chopin
29	Valse op.69-1 "L'adieu"	F.F.Chopin
30	Nocturne op.9-2	F.F.Chopin
31	Träumerei	R.Schumann
32	Fröhlicher Landmann	R.Schumann
33	La prière d'une Vierge	T.Badarzewska
34	Dolly's Dreaming and Awakening	T.Oesten
35	Arabesque	J.F.Burgmüller
36	Pastorale	J.F.Burgmüller
37	La chevaleresque	J.F.Burgmüller
38	Liebesträume Nr.3	F.Liszt
39	Blumenlied	G.Lange
40	Barcarolle	P.I.Tchaikovsky
41	Melody in F	A.Rubinstein
42	Humoresque	A.Dvorák
43	Tango (España)	I.Albéniz
44	The Entertainer	S.Joplin
45	Maple Leaf Rag	S.Joplin
46	La Fille aux Cheveux de Lin	C.A.Debussey
47	Arabesque 1	C.A.Debussey
48	Clair de lune	C.A.Debussey
49	Rêverie	C.A.Debussey
50	Golliwog's Cakewalk	C.A.Debussey

Index

Numerics

50 Piano Preset Songs15

A

A-B Repeat for 50 Preset Songs18

AC Power Adaptor9

Accessories6

Adding Variations19

Adjust

Brilliance14, 20

Tempo (50 Piano Preset Songs)15

Tempo (Recorded Songs)30

Volume.....11

Volume (50 Piano Preset Songs)15

Volume (Demo)14

Volume (Metronome)39

Volume (Recorded Songs).....31

ALL (LED display)15

B

Backup Functions.....42

[BRILLIANCE] control.....20

C

Combining Two Voices (Dual mode).....23

Connecting a Personal Computer45

D

[DC IN 12V] connector9

[DEMO] button14

Demo Song List52

Detailed Settings (FUNCTION).....32

Dual mode23, 37

E

[EFFECT] button20

F

Factory Setting List.....55

Fine Tuning of the Pitch35

FUL (LED display)27

FUNCTION.....35-42

Basic Procedure33

Function Parameter List55

H

[HOST SELECT] switch11, 47

HST (LED display).....45

L

List

Demo Song52

Factory Setting.....55

Functions32

Preset Song List52

Preset Voice50-51

M

METRONOME25

Metronome Volume39

MIDI44

MIDI [IN] [OUT] connectors11, 44, 47

MIDI cables44, 47, 48

MIDI Data Format.....56

MIDI driver46

MIDI Functions40

Music Rest9

N

Normal setting19

O

OUTPUT [L][R] jacks, [L/L+R][R] jacks10

P

[PHONES] jacks10

Piano Voice Demo Description52

Pitch → Fine Tuning of the Pitch35

Practicing a One-Hand Part Using 50 Preset Songs16

Precautions.....3-4

PRESET.....15

Preset Song List52

Preset Song Part39

Preset Voice List.....50-51

R

REC → Recording	27
Recording.....	26
Initial Settings.....	29
Re-recording.....	27
[REVERB] button	20
rnd (LED display).....	15

S

Scale.....	36
Scn (LED display).....	49
Serial cable	46, 48
Specifications.....	61
SPLIT	38
[SPLIT] button	24
[STANDBY/ON] switch	10
[START/STOP] button (Demo)	14
[START/STOP] button (METRONOME)	25
Start/Stop playback	
50 Piano Preset Songs.....	15
Demonstration Tunes	14
Recorded Songs	30
Useful Playback Functions.....	31
Start/Stop recording.....	27
[SUSTAIN] jack	10
Sustain Pedal.....	38, 39
Synchro Start	
50 Piano Preset Songs.....	17
Recorded Songs	31

T

TEMPO	15, 30
[TO HOST] connector.....	11, 44
TOUCH	21
Touch Sensitivity.....	21
Track Playback On and Off	31
TRACK1/2 (50 Piano Preset Songs).....	16
TRACK1/2 (Recording).....	27
TRANSPOSE	22
Troubleshooting.....	49
Tuning → Fine Tuning of the Pitch	35
Turning the power on	11

U

USB	48
-----------	----

V

[VARIATION] button.....	19
[VOICE] buttons	19

Factory Setting List / Liste der Vorgabeeinstellungen / Liste des réglages / Lista de ajustes de fábrica

Function	Default	Backup Group
Voice	[GRAND PIANO 1]	F9.1
Dual Mode	OFF	
Split Mode	OFF	
Split Mode Left Voice	WOOD BASS	
Reverb Type	Preset for each voice	
Reverb Depth	Preset for each voice	
Effect Type	Preset for each voice	
Effect Depth	Preset for each voice	
Touch Sensitivity	MEDIUM	
Volume in the FIXED Mode	64	
Metronome	OFF	—
Metronome Time Signature	0 (no accent)	F9.1
Tempo	120	—
Transpose	0	F9.3

Function Mode

	Function	Default	Backup Group
F1	Tuning	A3=440Hz	F9.3
F2.1	Scale	1 (Equal Temperament)	
F2.2	Base Note	C	
F3.1	Dual Balance	Preset for each voice combination	F9.1
F3.2	Dual Detune	Preset for each voice combination	
F3.3, F3.4	Dual Octave Shift	Preset for each voice combination	
F3.5, F3.6	Dual Effect Depth	Preset for each voice combination	
F4.1	Split Point	F#2	
F4.2	Split Balance	Preset for each voice combination	
F4.3, F4.4	Split Octave Shift	Preset for each voice combination	
F4.5, F4.6	Split Effect Depth	Preset for each voice combination	
F4.7	Sustain Pedal Range	ALL	F9.4
F5.1	Sustain Sample Depth	12	
F5.2	Keyoff Sample Volume	10	
F6	Metronome Volume	10	F9.1
F7	Preset Song Part Cancel Volume	5	F9.2
F8.1	MIDI Transmit Channel	1	
F8.2	MIDI Receive Channel	ALL	
F8.3	Local Control	ON	
F8.4	Program Change Send & Receive	ON	
F8.5	Control Change Send & Receive	ON	
F8.6	MIDI Transmit Transpose	0	
F9	Backup	All OFF	Always backed up

MIDI Data Format / MIDI-Datenformat / Format des données MIDI / Formato de datos MIDI

If you're already very familiar with MIDI, or are using a computer to control your music hardware with computer generated MIDI messages, the data provided in this section can help you to control the P-90.

Falls Sie bereits mit MIDI vertraut sind oder einen Computer zur Erzeugung von MIDI-Steuermeldungen für die Instrumente verwenden, können Sie sich zur Steuerung des P-90 nach den im folgenden Abschnitt aufgeführten Spezifikationen richten.

1. NOTE ON/OFF

Data format: [9nH] -> [kk] -> [vv]

9nH = Note ON/OFF event (n = channel number)
kk = Note number (Transmit: 09H ~ 78H = A-2 ~ C8 /
Receive: 00H ~ 7FH = C-2 ~ G8)*
vv = Velocity (Key ON = 01H ~ 7FH, Key OFF = 00H)

Data format: [8nH] -> [kk] -> [vv] (reception only)

8nH = Note OFF event (n = channel number)
kk = Note number: 00H ~ 7FH = C-2 ~ G8
vv = Velocity

* If received value exceeds the supported range for the selected voice, the note is adjusted by the necessary number of octaves.

2. CONTROL CHANGE

Data format: [BnH] -> [cc] -> [vv]

BnH = Control change (n = channel number)
cc = Control number
vv = Data Range

(1) Bank Select

ccH	Parameter	Data Range (vvH)
00H	Bank Select MSB	00H:Normal
20H	Bank Select LSB	00H...7FH

Bank selection processing does not occur until receipt of next Program Change message.

(2) Main Volume (reception only)

ccH	Parameter	Data Range (vvH)
07H	Volume MSB	00H...7FH

(3) Expression

ccH	Parameter	Data Range (vvH)
0BH	Expression MSB	00H...7FH

(4) Damper

ccH	Parameter	Data Range (vvH)
40H	Damper MSB	00H...7FH

(5) Sostenuto (reception only)

ccH	Parameter	Data Range (vvH)
42H	Sostenuto	00H-3FH:off, 40H-7FH:on

(6) Soft Pedal (reception only)

ccH	Parameter	Data Range (vvH)
43H	Soft Pedal	00H-3FH:off, 40H-7FH:on

(7) Effect1 Depth (Reverb Send Level)

ccH	Parameter	Data Range (vvH)
5BH	Effect1 Depth	00H...7FH

Adjusts the reverb send level.

(8) Effect4 Depth (Variation Effect Send Level)

ccH	Parameter	Data Range (vvH)
5EH	Effect4 Depth	00H...7FH

Si vous êtes très familier avec l'interface MIDI ou si vous utilisez un ordinateur pour commander votre matériel de musique au moyen de messages MIDI générés par ordinateur, les données suivantes vous seront utiles et vous aideront à commander le P-90.

Si usted está ya familiarizado con MIDI, o si emplea una computadora para controlar sus aparatos musicales con mensajes MIDI generados por computadora, los datos proporcionados en esta sección le ayudarán a controlar la P-90.

3. MODE MESSAGES

Data format: [BnH] -> [cc] -> [vv]

BnH = Control event (n = channel number)
cc = Control number
vv = Data Range

(1) All Sound Off

ccH	Parameter	Data Range (vvH)
78H	All Sound Off	00H

Switches off all sound from the channel. Does not reset Note On and Hold On conditions established by Channel Messages.

(2) Reset All Controllers

ccH	Parameter	Data Range (vvH)
79H	Reset All Controllers	00H

Resets controllers as follows.

Controller	Value
Expression	127 (max)
Damper Pedal	0 (off)
Sostenuto	0 (off)
Soft Pedal	0 (off)

(3) Local Control (reception only)

ccH	Parameter	Data Range (vvH)
7AH	Local Control	00H (off), 7FH (on)

(4) All Notes Off

ccH	Parameter	Data Range (vvH)
7BH	All Notes Off	00H

Switches OFF all the notes that are currently ON on the specified channel. Any notes being held by the damper or sostenuto pedal will continue to sound until the pedal is released.

(5) Omni Off (reception only)

ccH	Parameter	Data Range (vvH)
7CH	Omni Off	00H

Same processing as for All Notes Off.

(6) Omni On (reception only)

ccH	Parameter	Data Range (vvH)
7DH	Omni On	00H

Same processing as for All Notes Off.

(7) Mono (reception only)

ccH	Parameter	Data Range (vvH)
7EH	Mono	00H

Same processing as for All Sound Off.

(8) Poly (reception only)

ccH	Parameter	Data Range (vvH)
7FH	Poly	00H

Same processing as for All Sound Off.

- When control change reception is turned OFF in the Function mode, control change data will not be transmitted or received except for Bank Select and Mode messages.
- Local on/off, OMNI on/off are not transmitted. (The appropriate note off number is supplied with "All Note Off" transmission).
- When a voice bank MSB/LSB is received, the number is stored in the internal buffer regardless of the received order, then the stored value is used to select the appropriate voice when a program change message is received.
- The Multi-timbre and Poly modes are always active. No change occurs when OMNI ON, OMNI OFF, MONO, or POLY mode messages are received.

4. PROGRAM CHANGE

Data format: [CnH] -> [ppH]

CnH = Program event (n = channel number)

ppH = Program change number

P.C.#=Program Change number

Printed on the panel	[VARIATION] button	Voice Name	MSB (0-127)	LSB (0-127)	P.C# (1-128)
GRANDPIANO 1	OFF	GrandPiano1	0	122	1
	ON	(Variation)	0	123	1
GRANDPIANO 2	OFF	GrandPiano2	0	112	1
	ON	(Variation)	0	112	2
E.PIANO1	OFF	E.Piano1	0	122	6
	ON	(Variation)	0	122	89
E.PIANO2	OFF	E.Piano2	0	122	5
	ON	(Variation)	0	123	5
CLAVI./HARPSI.	OFF	Clavi.	0	122	8
	ON	Harpichord	0	122	7
VIBES/GUITAR	OFF	Vibraphone	0	122	12
	ON	NylonGuitar	0	122	25
CHURCH ORGAN	OFF	ChurchOrgan	0	123	20
	ON	(Variation)	0	122	20
JAZZ ORGAN	OFF	JazzOrgan	0	122	17
	ON	(Variation)	0	123	17
STRINGS	OFF	Strings	0	122	49
	ON	SlowStrings	0	122	50
CHOIR	OFF	Choir	0	122	53
	ON	SlowChoir	0	123	53
WOOD BASS	OFF	WoodBass	0	122	33
	ON	(Variation)	0	124	33
E.BASS	OFF	E.Bass	0	122	34
	ON	(Variation)	0	122	36

- When program change reception is turned OFF in the Function mode, no program change data is transmitted or received. Also, Bank MSB/LSB is not transmitted or received.

5. SYSTEM REALTIME MESSAGES

[rrH]

F8H: Timing clock

FAH: Start

FCH: Stop

FEH: Active sensing

Data	Transmission	Reception
F8H	Transmitted every 96 clocks	Received as 96-clock tempo timing when MIDI clock is set to External
FAH	Recorder start	Recorder start Not received when the MIDI clock is set to Internal.
FCH	Recorder stop	Recorder stop Not received when the MIDI clock is set to Internal.
FEH	Transmitted every 200 milliseconds	If a signal is not received via MIDI for more than 400 milliseconds, the same processing will take place for All Sound Off, All Notes Off and Reset All Controllers as when those signals are received.

- Caution: If an error occurs during MIDI reception, the Damper, Sostenuto, and Soft effects for all channels are turned off and an All Note Off occurs.

6. SYSTEM EXCLUSIVE MESSAGES (Yamaha MIDI Format)

Panel Data Transmit

Data format: [F0H] -> [43H] -> [0nH] -> [7CH] -> ... -> [F7H]
F0H, 43H, 0nH, 7CH (n: channel number)

00H, 2BH (data length)

43H, 4CH, 20H, 20H (CL)

43H, 4CH, 50H, 27H, 30H, 33H (CLP'03)

30H, 30H (version x, y)

[PANEL DATA]

[CHECK SUM (1byte)] = 0-(43H+4CH+20H+.....+Data end)
F7H

Panel Data Contents

- | | |
|--------------------------------|-------------------------------|
| (1) 1'st Voice | (18) Split Dumper Mode |
| (2) Dual On/Off | (19) Reverb Type 1 |
| (3) Dual Voice | (20) Reverb Type 2 |
| (4) Dual Balance | (21) Reverb Depth 1 |
| (5) Dual Detune | (22) Reverb Depth 2 |
| (6) Dual Voice1 Octave | (23) Effect Type 1 |
| (7) Dual Voice2 Octave | (24) Effect Type 2 |
| (8) Dual Voice1 Effect Depth | (25) Effect Depth |
| (9) Dual Voice2 Effect Depth | (26) Variation On/Off |
| (10) Split On/Off | (27) Touch Sensitivity |
| (11) Split Voice | (28) Fixed Data |
| (12) Split Point | (29) Absolute tempo low byte |
| (13) Split Balance | (30) Absolute tempo high byte |
| (14) Split Voice1 Octave | (31) Key-Off Sampling Depth |
| (15) Split Voice2 Octave | |
| (16) Split Voice1 Effect Depth | |
| (17) Split Voice2 Effect Depth | |

- Panel data send requests cannot be received.

7. SYSTEM EXCLUSIVE MESSAGES (Universal System Exclusive)

(1) Universal Realtime Message

Data format: [F0H] -> [7FH] -> [XnH] -> [04H] -> [01H] -> [IH] -> [mmH] -> [F7H]

MIDI Master Volume

- Simultaneously changes the volume of all channels.
- When a MIDI master volume message is received, the volume only has affect on the MIDI receive channel, not the panel master volume.

F0H = Exclusive status

7FH = Universal Realtime

7FH = ID of target device

04H = Sub-ID #1=Device Control Message

01H = Sub-ID #2=Master Volume

I/H = Volume LSB

mmH = Volume MSB

F7H = End of Exclusive

or

F0H = Exclusive status

7FH = Universal Realtime

XnH = When n is received n=0~F, whichever is received.

X = don't care

04H = Sub-ID #1=Device Control Message

01H = Sub-ID #2=Master Volume

I/H = Volume LSB

mmH = Volume MSB

F7H = End of Exclusive

(2) Universal Non-Realtime Message (GM On)

General MIDI Mode On

Data format: [F0H] -> [7EH] -> [XnH] -> [09H] -> [01H] -> [F7H]

F0H = Exclusive status
 7EH = Universal Non-Realtime
 7FH = ID of target device
 09H = Sub-ID #1=General MIDI Message
 01H = Sub-ID #2=General MIDI On
 F7H = End of Exclusive

or

F0H = Exclusive status
 7EH = Universal Non-Realtime
 XnH = When received, n=0~F.
 X = don't care
 09H = Sub-ID #1=General MIDI Message
 01H = Sub-ID #2=General MIDI On
 F7H = End of Exclusive

When the General MIDI mode ON message is received, the MIDI system will be reset to its default settings. This message requires approximately 50ms to execute, so sufficient time should be allowed before the next message is sent.

8. SYSTEM EXCLUSIVE MESSAGES (XG Standard)

(1) XG Native Parameter Change

Data format: [F0H] -> [43H] -> [1nH] -> [4CH] -> [hhH] -> [mmH] -> [l/H] -> [ddH] -> [F7H]

F0H = Exclusive status
 43H = YAMAHA ID
 1nH = When received, n=0~F.
 When transmitted, n=0.
 4CH = Model ID of XG
 hhH = Address High
 mmH = Address Mid
 l/H = Address Low
 ddH = Data

|
 F7H = End of Exclusive

Data size must match parameter size (2 or 4 bytes).
 When the XG System On message is received, the MIDI system will be reset to its default settings. The message requires approximately 50ms to execute, so sufficient time should be allowed before the next message is sent.

(2) XG Native Bulk Data (reception only)

Data format: [F0H] -> [43H] -> [0nH] -> [4CH] -> [aaH] -> [bbH] -> [hhH] -> [mmH] -> [l/H] -> [ddH] -> ...-> [ccH] -> [F7H]

F0H = Exclusive status
 43H = YAMAHA ID
 0nH = When received, n=0~F.
 When transmitted, n=0.
 4CH = Model ID of XG
 aaH = ByteCount
 bbH = ByteCount
 hhH = Address High
 mmH = Address Mid
 l/H = Address Low
 ddH = Data

| |
 | |
 ccH = Check sum
 F7H = End of Exclusive

- Receipt of the XG SYSTEM ON message causes reinitialization of relevant parameters and Control Change values. Allow sufficient time for processing to execute (about 50 msec) before sending the P-90 another message.
- XG Native Parameter Change message may contain two or four bytes of parameter data (depending on the parameter size).
- For information about the Address and Byte Count values, refer to Table 1 below. Note that the table's Total Size value gives the size of a bulk block. Only the top address of the block (00H, 00H, 00H) is valid as a bulk data address.

9. SYSTEM EXCLUSIVE MESSAGES (P-90 MIDI Format)

Data format: [F0H] -> [43H] -> [73H] -> [01H] -> [nnH] -> [F7H]

F0H = Exclusive status
 43H = Yamaha ID
 73H = Clavinova ID
 01H = Product ID (CLP common)
 nnH = Substatus
 nn Control
 02H Internal MIDI clock
 03H External MIDI clock
 F7H = End of Exclusive

or

Data format: [F0H] -> [43H] -> [73H] -> [7FH] -> [xxH] -> [nnH] -> [F7H]

F0H = Exclusive status
 43H = Yamaha ID
 73H = Clavinova ID
 7FH = Extended Product ID
 xxH = Product ID (P-90: 32H)
 nnH = Substatus
 nn Control
 02H Internal MIDI clock
 03H External MIDI clock
 06H Bulk Data (the bulk data follows 06H)
 F7H = End of Exclusive

BULK DUMP FORMAT

F0H, 43H, 73H
 7FH = Extended Product ID
 xxH = Product ID (P-90: 32H)
 06H = Bulk ID
 05H = Sequence data
 0nH, 0nH, 0nH, 0nH = Data length
 [BULK DATA]
 [CHECK SUM (1byte)] = 0-sum (BULK DATA)
 F7H = End of Exclusive

10. SYSTEM EXCLUSIVE MESSAGES (Special Control)

Data format: [F0H] -> [43H] -> [73H] -> [7FH] -> [xxH] -> [11H] -> [0nH] -> [ccH] -> [vvH] -> [F7H]

F0H = Exclusive status
 43H = Yamaha ID
 73H = Clavinova ID
 7FH = Extended Product ID
 xxH = Product ID (P-90: 32H)
 11H = Special control
 0nH = Control MIDI change (n=channel number)
 cc = Control number
 vv = Value
 F7H = End of Exclusive

Control	0n	ccH	vvH
Split Point	Always 00H	14H	14H : Split Key Number
Metronome	Always 00H	1BH	00H : off 01H : - 02H : 2/4 03H : 3/4 04H : 4/4 05H : 5/4 06H : 6/4 07H : No accent
Damper Level	ch: 00H-0FH	3DH	(Sets the Damper Level for each channel) 00H-7FH
Channel Detune	ch: 00H-0FH	43H	(Sets the Detune value for each channel) 00H-7FH
Voice Reserve	ch: 00H-0FH	45H	00H : Reserve off 7FH : on*

* When Volume, Expression is received for Reserve On, they will be effective from the next Key On. Reserve Off is normal.

11. SYSTEM EXCLUSIVE MESSAGES (Others)

Data format: [F0H] -> [43H] -> [1nH] -> [27H] -> [30H] -> [00H]
-> [00H] -> [mmH] -> [/H] -> [ccH] -> [F7H]

Master Tuning (XG and last message priority) simultaneously changes the pitch of all channels.

F0H = Exclusive Status

43H = Yamaha ID

1nH = When received, n=0~F.
When transmitted, n=0.

27H = Model ID of TG100

30H = Sub ID

00H

00H

mmH = Master Tune MSB

/H = Master Tune LSB

ccH = don't care (under 7FH)

F7H = End of Exclusive

<Table 1>

MIDI Parameter Change table (SYSTEM)

Address (H)	Size (H)	Data (H)	Parameter	Description	Default value (H)
00 00 00	4	020C - 05F4(*1)	MASTER TUNE	-50 - +50[cent]	00 04 00 00
01				1st bit 3 - 0 → bit 15 - 12	400
02				2nd bit 3 - 0 → bit 11 - 8	
03				3rd bit 3 - 0 → bit 7 - 4	
				4th bit 3 - 0 → bit 3 - 0	
04	1	00 - 7F	MASTER VOLUME	0 - 127	7F
05	1	—	—		
06	1	34 - 4C(*2)	TRANPOSE	-12 - +12[semitones]	40
7E		00	XG SYSTEM ON	00=XG system ON	
7F		00	RESET ALL PARAMETERS	00=ON (receive only)	

TOTAL SIZE 07

*1: Values lower than 020CH select -50 cents. Values higher than 05F4H select +50 cents.

*2: Values from 28H through 33H are interpreted as -12 through -1. Values from 4DH through 58H are interpreted as +1 through +12.

<Table 2>

MIDI Parameter Change table (EFFECT 1)

Refer to the "Effect MIDI Map" for a complete list of Reverb, Chorus and Variation type numbers.

Address (H)	Size (H)	Data (H)	Parameter	Description	Default value (H)
02 01 00	2	00-7F	REVERB TYPE MSB	Refer to Effect MIDI Map	01(=HALL1)
		00-7F	REVERB TYPE LSB	00 : basic type	00
02 01 40	2	00-7F	VARIATION TYPE MSB	Refer to Effect MIDI Map	00(=Effect off)
		00-7F	VARIATION TYPE LSB	00 : basic type	00

• "VARIATION" refers to the EFFECT on the panel.

<Table 3>

MIDI Parameter Change table (MULTI PART)

Address (H)	Size (H)	Data (H)	Parameter	Description	Default value (H)
08 nn 11	1	00 - 7F	DRY LEVEL	0 - 127	7F

nn = Part Number

• Effect MIDI Map

REVERB

	MSB	LSB
ROOM	02H	10H
HALL 1	01H	10H
HALL 2	01H	11H
STAGE	03H	10H
Sound board	03H	12H

EFFECT

	MSB	LSB
CHORUS	42H	10H
PHASER	48H	10H
TREMOLO	46H	10H
DELAY	05H	10H

Function...		Transmitted	Recognized	Remarks
Basic Channel	Default Changed	1 1 - 16	1 1 - 16	
Mode	Default Messages Altered	3 X *****	1 X X	*1 Poly Mode only
Note Number : True voice		9 - 120 *****	0 - 127 0 - 127	
Velocity	Note ON Note OFF	O 9nH,v=1-127 X 9nH,v=0	O 9nH,v=1-127 X 9nH,v=0 or 8nH	
After Touch	Key's Ch's	X X	X X	
Pitch Bend		X	X	
Control Change	0,32 7 11 64 66 67 91 94	O O O O X X O O	O O O O O O O O	Bank Select Volume Expression Damper Sostenuto Soft pedal Reverb Depth Effect Depth
Prog Change : True #		O *****	O	
System Exclusive		O	O	
Common : Song Pos. : Song Sel. : Tune		X X X	X X X	
System : Clock Real Time : Commands		O O	O O	
Aux : All Sound Off : Reset All Cntrls : Local ON/OFF Mes- : All Notes OFF sages: Active Sense : Reset		O O X O O X	O (120,126,127) O (121) O (122) O (123-125) O X	

Notes: *1= Receive Mode is always multi timbre and Poly mode.

Specifications / Technische Daten / Caractéristiques techniques / Especificaciones

Item	Specification
KEYBOARD	88 Keys (A-1–C7)
SOUND SOURCE	AWM Dynamic Stereo Sampling
POLYPHONY	64 Notes Max.
VOICE SELECTION	24 voices (including Variation)
REVERB	ROOM, HALL 1, HALL 2, STAGE
EFFECT	CHORUS, PHASER, TREMOLO, DELAY
DEMO SONGS	12 Voice Demo Songs, 9 Piano Voice Demo Songs, 50 Preset Songs
TOUCH SENSITIVITY	HARD, MEDIUM, SOFT, FIXED
SONG CONTROLS	PRESET, TRACK 1, 2, START/STOP, REC
PEDAL CONTROL	SUSTAIN
OTHER CONTROLS	MASTER VOLUME, BRILLIANCE, DEMO, TRANSPOSE, SPLIT, METRONOME START/STOP, TEMPO/FUNCTION#, FUNCTION, –/NO, +/YES, LED Display, HOST SELECT
JACKS/CONNECTORS	OUTPUT: L and R Pin Jacks, L/L+R and R Phone Jacks, MIDI IN/OUT, TO HOST, PHONES x 2, SUSTAIN, DC IN 12V
POWER SUPPLY	Yamaha PA-3C power adaptor
DIMENSIONS (W x D x H)	1347 x 285 x 128 mm (53" x 11-1/4" x 5")
WEIGHT	16.9 kg (37 lbs., 4oz)

- * Specifications and descriptions in this owner's manual are for information purposes only. Yamaha Corp. reserves the right to change or modify products or specifications at any time without prior notice. Since specifications, equipment or options may not be the same in every locale, please check with your Yamaha dealer.
- * Die technischen Daten und Beschreibungen in dieser Bedienungsanleitung dienen nur der Information. Yamaha Corp. behält sich das Recht vor, Produkte oder deren technische Daten jederzeit ohne vorherige Ankündigung zu verändern oder zu modifizieren. Da die technischen Daten, das Gerät selbst oder Sonderzubehör nicht in jedem Land gleich sind, setzen Sie sich im Zweifel bitte mit Ihrem Yamaha-Händler in Verbindung.
- * Les caractéristiques techniques et les descriptions du mode d'emploi ne sont données que pour information. Yamaha Corp. se réserve le droit de changer ou modifier les produits et leurs caractéristiques techniques à tout moment sans aucun avis. Du fait que les caractéristiques techniques, les équipements et les options peuvent différer d'un pays à l'autre, adressez-vous au distributeur Yamaha le plus proche.
- * Las especificaciones y descripciones de este manual del propietario tienen sólo el propósito de servir como información. Yamaha Corp. se reserva el derecho a efectuar cambios o modificaciones en los productos o especificaciones en cualquier momento sin previo aviso. Puesto que las especificaciones, equipos u opciones pueden no ser las mismas en todos los mercados, solicite información a su distribuidor Yamaha.

FCC INFORMATION (U.S.A.)

1. **IMPORTANT NOTICE: DO NOT MODIFY THIS UNIT!**

This product, when installed as indicated in the instructions contained in this manual, meets FCC requirements. Modifications not expressly approved by Yamaha may void your authority, granted by the FCC, to use the product.

2. **IMPORTANT:** When connecting this product to accessories and/or another product use only high quality shielded cables. Cable/s supplied with this product **MUST** be used. Follow all installation instructions. Failure to follow instructions could void your FCC authorization to use this product in the USA.

3. **NOTE:** This product has been tested and found to comply with the requirements listed in FCC Regulations, Part 15 for Class "B" digital devices. Compliance with these requirements provides a reasonable level of assurance that your use of this product in a residential environment will not result in harmful interference with other electronic devices. This equipment generates/uses radio frequencies and, if not installed and used according to the instructions found in the users manual, may cause interference harmful to the operation of

other electronic devices. Compliance with FCC regulations does not guarantee that interference will not occur in all installations. If this product is found to be the source of interference, which can be determined by turning the unit "OFF" and "ON", please try to eliminate the problem by using one of the following measures:

Relocate either this product or the device that is being affected by the interference.

Utilize power outlets that are on different branch (circuit breaker or fuse) circuits or install AC line filter/s.

In the case of radio or TV interference, relocate/reorient the antenna. If the antenna lead-in is 300 ohm ribbon lead, change the lead-in to co-axial type cable.

If these corrective measures do not produce satisfactory results, please contact the local retailer authorized to distribute this type of product. If you can not locate the appropriate retailer, please contact Yamaha Corporation of America, Electronic Service Division, 6600 Orangethorpe Ave, Buena Park, CA90620

The above statements apply **ONLY** to those products distributed by Yamaha Corporation of America or its subsidiaries.

* This applies only to products distributed by YAMAHA CORPORATION OF AMERICA.

(class B)

For details of products, please contact your nearest Yamaha representative or the authorized distributor listed below.

Pour plus de détails sur les produits, veuillez-vous adresser à Yamaha ou au distributeur le plus proche de vous figurant dans la liste suivante.

Die Einzelheiten zu Produkten sind bei Ihrer unten aufgeführten Niederlassung und bei Yamaha Vertragshändlern in den jeweiligen Bestimmungsländern erhältlich.

Para detalles sobre productos, contacte su tienda Yamaha más cercana o el distribuidor autorizado que se lista debajo.

NORTH AMERICA

CANADA

Yamaha Canada Music Ltd.
135 Milner Avenue, Scarborough, Ontario,
M1S 3R1, Canada
Tel: 416-298-1311

U.S.A.

Yamaha Corporation of America
6600 Orangethorpe Ave., Buena Park, Calif. 90620,
U.S.A.
Tel: 714-522-9011

CENTRAL & SOUTH AMERICA

MEXICO

Yamaha de Mexico S.A. De C.V.,
Departamento de ventas
Javier Rojo Gomez No.1149, Col. Gpe Del
Moral, Deleg. Iztapalapa, 09300 Mexico, D.F.
Tel: 686-00-33

BRAZIL

Yamaha Musical do Brasil LTDA.
Av. Rebouças 2636, São Paulo, Brasil
Tel: 011-853-1377

ARGENTINA

Yamaha Music Latin America, S.A.
Sucursal de Argentina
Viamonte 1145 Piso2-B 1053,
Buenos Aires, Argentina
Tel: 1-4371-7021

PANAMA AND OTHER LATIN AMERICAN COUNTRIES/ CARIBBEAN COUNTRIES

Yamaha Music Latin America, S.A.
Torre Banco General, Piso 7, Urbanización Marbella,
Calle 47 y Aquilino de la Guardia,
Ciudad de Panamá, Panamá
Tel: +507-269-5311

EUROPE

THE UNITED KINGDOM

Yamaha-Kemble Music (U.K.) Ltd.
Sherbourne Drive, Tilbrook, Milton Keynes,
MK7 8BL, England
Tel: 01908-366700

IRELAND

Danfay Ltd.
61D, Sallynoggin Road, Dun Laoghaire, Co. Dublin
Tel: 01-2859177

GERMANY

Yamaha Music Central Europe GmbH
Siemensstraße 22-34, 25462 Rellingen, Germany
Tel: 04101-3030

SWITZERLAND/LIECHTENSTEIN

Yamaha Music Central Europe GmbH,
Branch Switzerland
Seefeldstrasse 94, 8008 Zürich, Switzerland
Tel: 01-383 3990

AUSTRIA

Yamaha Music Central Europe GmbH,
Branch Austria
Schleiergasse 20, A-1100 Wien, Austria
Tel: 01-60203900

THE NETHERLANDS

Yamaha Music Central Europe,
Branch Nederland
Clarissenhof 5-b, 4133 AB Vianen, The Netherlands
Tel: 0347-358 040

BELGIUM/LUXEMBOURG

Yamaha Music Central Europe GmbH,
Branch Belgium
Rue de Geneve (Genevastraat) 10, 1140 - Brussels,
Belgium
Tel: 02-726 6032

FRANCE

Yamaha Musique France, S.A.
Division Professionnelle
BP 70-77312 Marne-la-Vallée Cedex 2, France
Tel: 01-64-61-4000

ITALY

Yamaha Musica Italia S.P.A.
Combo Division
Viale Italia 88, 20020 Lainate (Milano), Italy
Tel: 02-935-771

SPAIN/PORTUGAL

Yamaha-Hazen Música, S.A.
Ctra. de la Coruna km. 17, 200, 28230
Las Rozas (Madrid), Spain
Tel: 91-639-8888

GREECE

Philippos Nakas S.A. The Music House
147 Skiathou Street, 112-55 Athens, Greece
Tel: 01-228 2160

SWEDEN

Yamaha Scandinavia AB
J. A. Wettergrens Gata 1
Box 30053
S-400 43 Göteborg, Sweden
Tel: 031 89 34 00

DENMARK

YS Copenhagen Liaison Office
Generatorvej 8B
DK-2730 Herlev, Denmark
Tel: 44 92 49 00

FINLAND

F-Musiikki Oy
Kluuvikatu 6, P.O. Box 260,
SF-00101 Helsinki, Finland
Tel: 09 618511

NORWAY

Norsk filial av Yamaha Scandinavia AB
Grini Næringspark 1
N-1345 Østerås, Norway
Tel: 67 16 77 70

ICELAND

Skifan HF
Skeifan 17 P.O. Box 8120
IS-128 Reykjavik, Iceland
Tel: 525 5000

OTHER EUROPEAN COUNTRIES

Yamaha Music Central Europe GmbH
Siemensstraße 22-34, 25462 Rellingen, Germany
Tel: +49-4101-3030

AFRICA

Yamaha Corporation,
Asia-Pacific Music Marketing Group
Nakazawa-cho 10-1, Hamamatsu, Japan 430-8650
Tel: +81-53-460-2312

MIDDLE EAST

TURKEY/CYPRUS

Yamaha Music Central Europe GmbH
Siemensstraße 22-34, 25462 Rellingen, Germany
Tel: 04101-3030

OTHER COUNTRIES

Yamaha Music Gulf FZE
LB21-128 Jebel Ali Freezone
P.O.Box 17328, Dubai, U.A.E.
Tel: +971-4-881-5868

ASIA

HONG KONG

Tom Lee Music Co., Ltd.
11/F., Silvercord Tower 1, 30 Canton Road,
Tsimshatsui, Kowloon, Hong Kong
Tel: 2737-7688

INDONESIA

PT. Yamaha Music Indonesia (Distributor)
PT. Nusantik
Gedung Yamaha Music Center, Jalan Jend. Gatot
Subroto Kav. 4, Jakarta 12930, Indonesia
Tel: 21-520-2577

KOREA

Yamaha Music Korea Ltd.
Tong-Yang Securities Bldg. 16F 23-8 Yoido-dong,
Youngdungpo-ku, Seoul, Korea
Tel: 02-3770-0661

MALAYSIA

Yamaha Music Malaysia, Sdn., Bhd.
Lot 8, Jalan Perbandaran, 47301 Kelana Jaya,
Petaling Jaya, Selangor, Malaysia
Tel: 3-703-0900

PHILIPPINES

Yupangco Music Corporation
339 Gil J. Puyat Avenue, P.O. Box 885 MCPO,
Makati, Metro Manila, Philippines
Tel: 819-7551

SINGAPORE

Yamaha Music Asia Pte., Ltd.
11 Ubi Road #06-00, Meiban Industrial Building,
Singapore
Tel: 65-747-4374

TAIWAN

Yamaha KHS Music Co., Ltd.
3F, #6, Sec.2, Nan Jing E. Rd. Taipei.
Taiwan 104, R.O.C.
Tel: 02-2511-8688

THAILAND

Siam Music Yamaha Co., Ltd.
121/60-61 RS Tower 17th Floor,
Ratchadaphisek RD., Dindaeng,
Bangkok 10320, Thailand
Tel: 02-641-2951

THE PEOPLE'S REPUBLIC OF CHINA AND OTHER ASIAN COUNTRIES

Yamaha Corporation,
Asia-Pacific Music Marketing Group
Nakazawa-cho 10-1, Hamamatsu, Japan 430-8650
Tel: +81-53-460-2317

OCEANIA

AUSTRALIA

Yamaha Music Australia Pty. Ltd.
Level 1, 99 Queensbridge Street, Southbank,
Victoria 3006, Australia
Tel: 3-9693-5111

NEW ZEALAND

Music Houses of N.Z. Ltd.
146/148 Captain Springs Road, Te Papapa,
Auckland, New Zealand
Tel: 9-634-0099

COUNTRIES AND TRUST TERRITORIES IN PACIFIC OCEAN

Yamaha Corporation,
Asia-Pacific Music Marketing Group
Nakazawa-cho 10-1, Hamamatsu, Japan 430-8650
Tel: +81-53-460-2312

HEAD OFFICE Yamaha Corporation, Pro Audio & Digital Musical Instrument Division
Nakazawa-cho 10-1, Hamamatsu, Japan 430-8650
Tel: +81-53-460-2445



Yamaha Web Site (English only)

<http://www.yamahasyth.com/>

Yamaha Manual Library

<http://www2.yamaha.co.jp/manual/english/>

This document is printed on recycled chlorine free (ECF) paper with soy ink.

Auf Recycling-Umweltpapier mit Sojatinte gedruckt.

Ce document a été imprimé sur du papier recyclé non blanchi au chlore avec de l'encre d'huile de soja.

Este documento se ha impreso reciclado en papel sin cloro alguno, con tinta de soja.

M.D.G., Pro Audio & Digital Musical Instrument Division, Yamaha Corporation

© 2003 Yamaha Corporation

WB00060 306APAP2.3-02B0 Printed in Japan