

NS-P20

(NS-B20 + NS-C20 + NS-SW20)

SPEAKER PACKAGE

PACKAGE ENCEINTES



**OWNER'S MANUAL
MODE D'EMPLOI**

IMPORTANT SAFETY INSTRUCTIONS

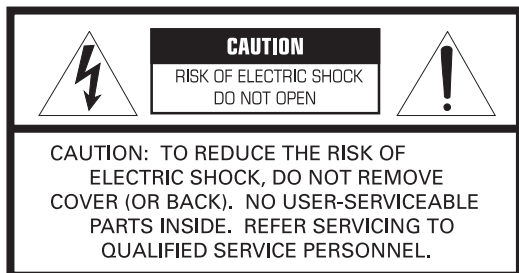

• Explanation of Graphical Symbols



The lightning flash with arrowhead symbol, within an equilateral triangle, is intended to alert you to the presence of uninsulated "dangerous voltage" within the product's enclosure that may be of sufficient magnitude to constitute a risk of electric shock to persons.



The exclamation point within an equilateral triangle is intended to alert you to the presence of important operating and maintenance (servicing) instructions in the literature accompanying the appliance.

IMPORTANT

Please record the serial number of this system in the space below.

Model:

Serial No.:

The serial number is located on the rear of the main unit.
Retain this Owner's Manual in a safe place for future reference.

- 1 Read these instructions.
- 2 Keep these instructions.
- 3 Heed all warnings.
- 4 Follow all instructions.
- 5 Do not use this apparatus near water.
- 6 Clean only with dry cloth.
- 7 Do not block any ventilation openings. Install in accordance with the manufacturer's instructions.
- 8 Do not install near any heat sources such as radiators, heat registers, stoves, or other apparatus (including amplifiers) that produce heat.
- 9 Do not defeat the safety purpose of the polarized or grounding-type plug. A polarized plug has two blades with one wider than the other. A grounding type plug has two blades and a third grounding prong. The wide blade or the third prong are provided for your safety. If the provided plug does not fit into your outlet, consult an electrician for replacement of the obsolete outlet.
- 10 Protect the power cord from being walked on or pinched particularly at plugs, convenience receptacles, and the point where they exit from the apparatus.
- 11 Only use attachments/accessories specified by the manufacturer.
- 12 Use only with the cart, stand, tripod, bracket, or table specified by the manufacturer, or sold with the apparatus. When a cart is used, use caution when moving the cart/apparatus combination to avoid injury from tip-over.
- 13 Unplug this apparatus during lightning storms or when unused for long periods of time.
- 14 Refer all servicing to qualified service personnel. Servicing is required when the apparatus has been damaged in any way, such as power-supply cord or plug is damaged, liquid has been spilled or objects have fallen into the apparatus, the apparatus has been exposed to rain or moisture, does not operate normally, or has been dropped.



Information for Users on Collection and Disposal of Old Equipment



This symbol on the products, packaging, and/or accompanying documents means that used electrical and electronic products should not be mixed with general household waste.

For proper treatment, recovery and recycling of old products, please take them to applicable collection points, in accordance with your national legislation and the Directives 2002/96/EC.

By disposing of these products correctly, you will help to save valuable resources and prevent any potential negative effects on human health and the environment which could otherwise arise from inappropriate waste handling.

For more information about collection and recycling of old products, please contact your local municipality, your waste disposal service or the point of sale where you purchased the items.

[Information on Disposal in other Countries outside the European Union]

This symbol is only valid in the European Union. If you wish to discard these items, please contact your local authorities or dealer and ask for the correct method of disposal.

FCC INFORMATION (for US customers)

1 **IMPORTANT NOTICE : DO NOT MODIFY THIS UNIT!**

This product, when installed as indicated in the instructions contained in this manual, meets FCC requirements. Modifications not expressly approved by Yamaha may void your authority, granted by the FCC, to use the product.

2 IMPORTANT : When connecting this product to accessories and/or another product use only high quality shielded cables. Cable/s supplied with this product **MUST** be used. Follow all installation instructions. Failure to follow instructions could void your FCC authorization to use this product in the USA.

3 NOTE : This product has been tested and found to comply with the requirements listed in FCC Regulations, Part 15 for Class “B” digital devices. Compliance with these requirements provides a reasonable level of assurance that your use of this product in a residential environment will not result in harmful interference with other electronic devices.

This equipment generates/uses radio frequencies and, if not installed and used according to the instructions found in the users manual, may cause interference harmful to the operation of other electronic devices.

Compliance with FCC regulations does not guarantee that interference will not occur in all installations. If this product is found to be the source of interference, which can be determined by turning the unit “OFF” and “ON”, please try to eliminate the problem by using one of the following measures:

Relocate either this product or the device that is being affected by the interference.

Utilize power outlets that are on different branch (circuit breaker or fuse) circuits or install AC line filter/s.

In the case of radio or TV interference, relocate/reorient the antenna. If the antenna lead-in is 300 ohm ribbon lead, change the lead-in to coaxial type cable.

If these corrective measures do not produce satisfactory results, please contact the local retailer authorized to distribute this type of product. If you can not locate the appropriate retailer, please contact Yamaha Electronics Corp., USA 6660 Orangethorpe AV., Buena Park, CA 90620.

The above statements apply **ONLY** to those products distributed by Yamaha Corporation of America or its subsidiaries.

We Want You Listening For A Lifetime

Yamaha and the Electronic Industries Association’s Consumer Electronics Group want you to get the most out of your equipment by playing it at a safe level. One that lets the sound come through loud and clear without annoying blaring or distortion – and, most importantly, without affecting your sensitive hearing.

Since hearing damage from loud sounds is often undetectable until it is too late, Yamaha and the Electronic Industries Association’s Consumer Electronics Group recommend you to avoid prolonged exposure from excessive volume levels.



Precautions

Please read the following operating precautions before use. Yamaha will not be held responsible for any damage and/or injury caused by not following the cautions below.

1. To assure the finest performance, please read this manual carefully. Keep it in a safe place for future reference.
2. Install the speakers in a cool, dry, clean place – away from windows, sources of heat, sources of excessive vibration, dust, moisture or cold. Avoid sources of electrical humming (e.g., transformers and motors). To prevent fire or electric shock, do not expose the speakers to rain or water.
3. To prevent the enclosure from warping or discoloring, do not expose the speakers to direct sunlight or excessive humidity.
4. Avoid installing the speakers where foreign objects may fall onto them and/or where they may be exposed to liquid dripping or splashing.
5. Do not place the following objects on top of the speakers:
 - Other components, as they might damage or discolor the surface of the speakers.
 - Burning objects (e.g., candles), as they might cause fire, damage to the speakers or personal injury.
 - Containers of liquid, as they might spill and cause electric shock to the user or damage to the speakers.
6. Do not place the speakers where they are liable to be knocked over or struck by falling objects. Stable placement will also ensure better sound performance.
7. Placing the speakers on the same shelf or rack as the turntable can result in feedback.
8. Any time you note distortion, reduce the volume control on your amplifier to lower setting. Never allow your amplifier to be driven into “clipping”. Otherwise, the speakers may be damaged.
9. When using an amplifier with a rated output power higher than the nominal input power of the speakers, care should be taken not to exceed the maximum input of the speakers.
10. Do not attempt to clean the speakers with chemical solvents as this might damage the finish. Use a clean, dry cloth.
11. Do not attempt to modify or fix the speakers. Contact qualified Yamaha service personnel when service is needed. The cabinet should never be opened for any reason.

12. Be sure to read the “Troubleshooting” section regarding common operating errors before concluding that the speakers are faulty.
13. **Secure placement or installation is the owner’s responsibility. Yamaha is not liable for accidents caused by improper placement or installation of speakers.**

For NS-SW20

WARNING

TO REDUCE THE RISK OF FIRE OR ELECTRIC SHOCK, DO NOT EXPOSE THIS APPLIANCE TO RAIN OR MOISTURE.

1. Do not operate this unit upside down. It may overheat, possibly causing damage.
2. Do not use excessive force on switches, controls or connection wires. When moving this unit, first disconnect the power plug and the wires connected to other equipment. Never pull the wires themselves.
3. Never put a hand or a foreign object into the port located on the right side of this unit. When moving this unit, do not hold the port, as it might cause personal injury and/or damage to this unit.
4. Since this unit has a built-in power amplifier, heat radiates from the rear panel. Place the unit away from walls, allowing at least 20 cm (8”) of space above, behind and on both sides of the unit to prevent fire or damage. Furthermore, do not position the unit with the rear panel facing down on the floor or other surfaces.
5. When using a humidifier, be sure to avoid condensation inside this unit by allowing enough space around the unit and avoiding excess humidification. Condensation might cause fire, damage to the unit, and/or electric shock.
6. Do not cover the rear panel of this unit with a newspaper, tablecloth, curtain, etc. to avoid obstructing heat radiation. If the temperature inside the unit rises, it may cause fire, damage to the unit, or personal injury.
7. Do not plug this unit into a wall outlet until all connections are complete.
8. The voltage to be used must match that specified on the rear panel. Using this unit with a voltage higher than specified is dangerous and may cause fire, damage to the unit, and/or personal injury. Yamaha is not responsible for damage resulting from use of this unit with a voltage other than specified.
9. Super-bass sound reproduced by this unit may cause a turntable to generate audio feedback. In this case, move the unit away from the turntable.
10. This unit may be damaged if certain sounds are continuously output at high volume level. For example, if 20 Hz–50 Hz sine waves from a test disc or bass sounds from an electronic instrument, etc. are continuously output, or if a turntable stylus touches the surface of a disc, reduce the volume level to prevent the unit from being damaged.
11. If you hear distorted noise (i.e., unnatural, intermittent “rapping” or “hammering” sounds) from this unit, reduce the volume level. Extremely loud movie soundtrack low frequency, bass-heavy sounds, or similarly loud popular music passages can damage this unit.

12. Vibration generated by super-bass sound may distort images on a TV. In this case, move the unit away from the TV set.
13. When disconnecting the power cord from the wall outlet, grasp the plug; do not pull the cord.
14. When you plan not to use this unit for a long period of time (i.e. vacation, etc.), disconnect the AC power plug from the wall outlet.
15. Install this unit near the wall outlet and where the AC power plug can be reached easily.

• **VOLTAGE SELECTOR**

(For China, Korea, Asia and General models)

The voltage selector switch on the rear panel of this unit must be set to your local main voltage BEFORE plugging this unit into the AC main supply. Voltages are 110-120/220-240 V AC, 50/60 Hz.

This unit is not disconnected from the AC power source as long as it is connected to the wall outlet, even if this unit itself is turned off. In this state, this unit is designed to consume a very small quantity of power.

For U.K. customers

If the socket outlets in the home are not suitable for the plug supplied with this appliance, it should be cut off and an appropriate 3 pin plug fitted. For details, refer to the instructions described below.

Note: The plug severed from the mains lead must be destroyed, as a plug with bared flexible cord is hazardous if engaged in a live socket outlet.

SPECIAL INSTRUCTIONS FOR U.K. MODEL

IMPORTANT:

THE WIRES IN MAINS LEAD ARE COLOURED IN ACCORDANCE WITH THE FOLLOWING CODE:

Blue: NEUTRAL

Brown: LIVE

As the colours of the wires in the mains lead of this apparatus may not correspond with the coloured markings identifying the terminals in your plug, proceed as follows: The wire which is coloured BLUE must be connected to the terminal which is marked with the letter N or coloured BLACK. The wire which is coloured BROWN must be connected to the terminal which is marked with the letter L or coloured RED. Make sure that neither wire is connected to the earth terminal of a three pin plug.

For Canadian Customers

To prevent electric shock, match wide blade of plug to wide slot and fully insert.

This Class B digital apparatus complies with Canadian ICES-003.

Contents

Package contents.....	1	Connecting the speakers.....	3
Installing the speakers.....	1	Connection diagram.....	3
Installing the front, center, and surround speakers.....	2	Connecting the power cables.....	4
Installing the subwoofer.....	2	Using the Subwoofer.....	4
Wall-mounting the speakers.....	2	Setting the subwoofer volume.....	4
		Troubleshooting.....	5
		Specifications.....	6

Package contents

Make sure the package contains the following items.

Front and surround speakers (NS-B20) x4

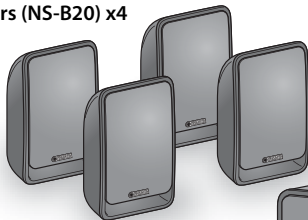

Subwoofer (NS-SW20) x1

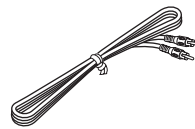
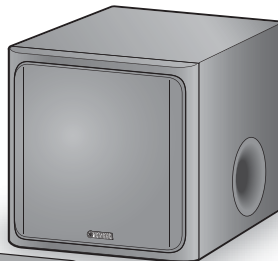

Subwoofer cable 5 m (16 ft.) x1



Center speaker (NS-C20) x1

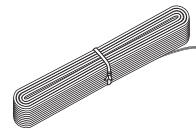

Speaker cable 25 m (82 ft.) x1
(To be cut into 5 lengths for the front, center, and surround speakers. Take care to prevent injury when preparing the cables.)

Non-skid pads: When placing the speakers on a flat surface, affix the included non-skid pads to the corners of the speaker undersides, as shown. The pads will prevent the speaker from moving around.

Non-skid pad



Non-skid pads (24 pcs.) x1
(For the front, center and surround speakers. Including 4 spare non-skid pads.)

Installing the speakers

Before you connect the speakers, place each speaker in its respective location. Speaker positioning is very important as it affects the overall sound quality of the system. Place the speakers in locations that will optimize the sound quality at your listening position. Refer to the illustration.

The position of the subwoofer is not as critical as the position of the other speakers because sub-bass sounds are not very directional. Refer to “Installing the subwoofer” on page 2 for more information.

Note

- Placing the speakers too close to a CRT-type TV may impair the picture color or cause a buzzing noise. In this case, move the speakers at least 20 cm (8") away from the TV. This is not an issue with LCD and plasma TVs.

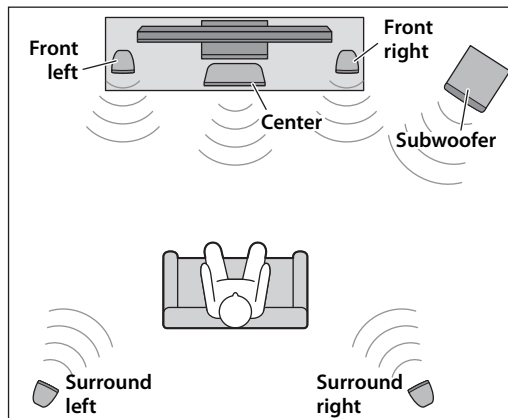

Installing the front, center, and surround speakers

Front speakers: Place the two front speakers on the left and right sides of the TV facing directly forward.

Surround speakers: Place the left and right surround speakers behind your listening position, facing slightly inward.

The front and surround speakers can be placed on a flat surface or wall-mounted.

See “Wall-mounting the speakers” for more information.

Center speaker: Place the center speaker centrally between the front speakers, facing directly forward.

Installing the subwoofer

Place the subwoofer on the outside of either the right or the left front speaker, as shown in **A** and **B**.

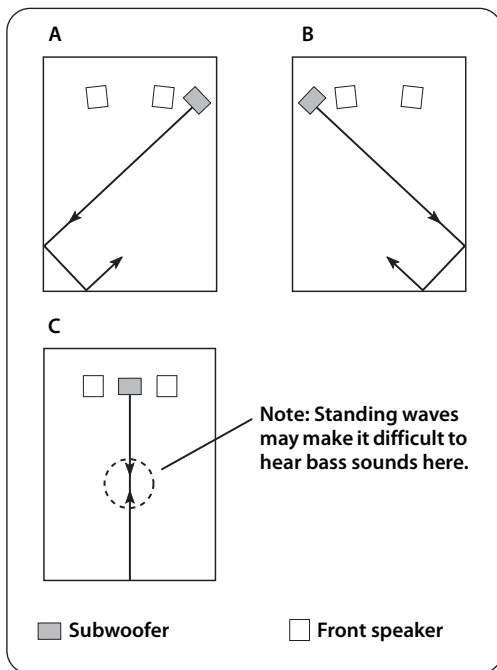

The placement shown in **C** is also possible, however, if the subwoofer is placed directly facing a wall and your listening position is in the center of the room, you may not be able to obtain enough bass sound from the subwoofer. This is because “standing waves” are forming between the two parallel walls and cancelling out the bass sounds. In this case, position the subwoofer at an angle to the wall. It may be necessary to break up parallel wall surfaces by placing bookshelves, etc., along them.

Wall-mounting the speakers

You can mount the speakers on the wall as follows.

- 1** Install screws into a solid wall or wall support as shown below. Use 3.5 to 4 mm (1/8") diameter self-tapping screws.
- 2** Hang each speaker by its keyhole slots onto the protruding screws.

Note

- Make sure the shaft of the screw is seated in the narrow part of the keyhole slot. Otherwise, the speaker may fall.

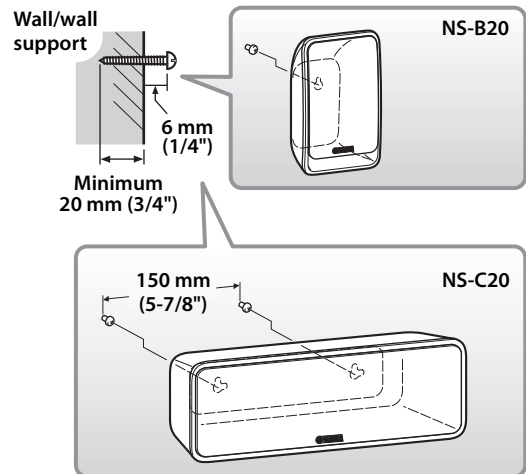

Warnings

- NS-B20 speaker weighs 0.48kg (1.06 lbs.) and NS-C20 speaker weighs 0.68 kg (1.50 lbs.). Do not mount the speakers on thin plywood or on a wall with a soft surface material. Otherwise, the screws may pull out of the surface and the speakers may fall, possibly damaging the speakers or causing personal injury.
- Do not affix the speakers to a wall using nails, adhesives, or unstable hardware. Long-term use and vibration may cause the speakers to fall.
- To avoid accidents resulting from tripping over loose speaker cables, affix the cables to the wall.
- Mount the speakers in a wall location that will be unlikely to result in injury to an individual's head.

Connecting the speakers

Caution: Make sure the power cables for the subwoofer and your other AV components are disconnected from the AC wall outlets before making any connections.

Connection diagram

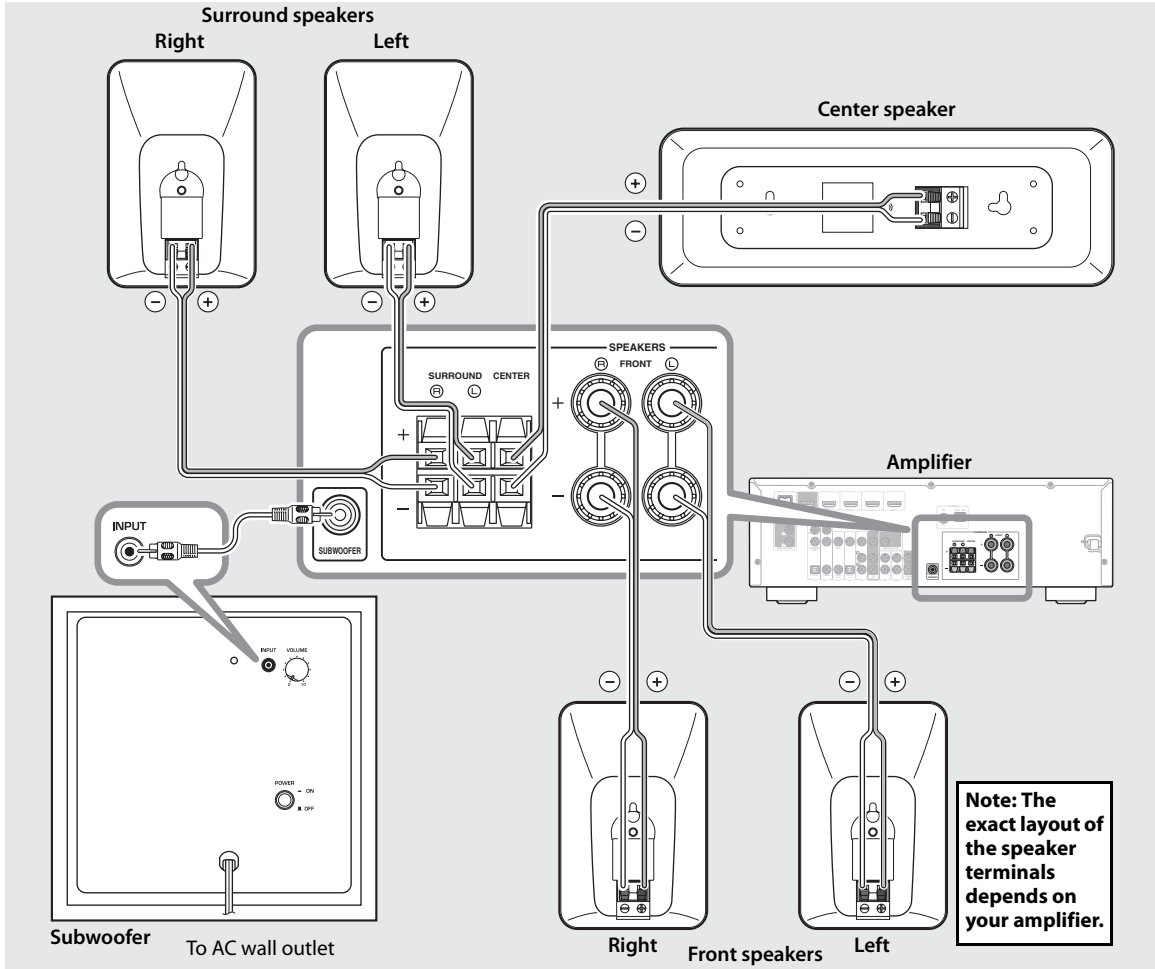

■ Preparing the speaker cables

Once you've positioned the speakers, you'll need to cut the 25-meter (82 ft.) speaker cable to make five cables for connecting the two front speakers, center speaker, and the two surround speakers.

- 1** Cut the included speaker cable to suitable lengths for the front, center, and surround speakers. You need five cables.
- 2** Remove about 10 mm (3/8") of insulation from the end of each speaker cable.

3 Twist the bare wires tightly.

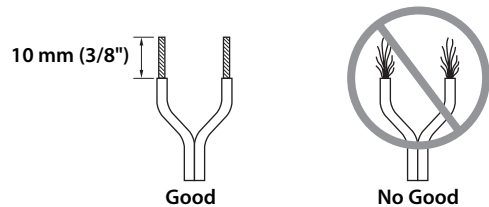

Notes

- Make the speaker cables as short as possible. Do not bundle or roll up excess cable.
- Twist the bare wires tightly so the individual strands are not splayed.
- Be careful not to injure yourself while preparing the speaker cables.

■ Operating the speaker terminals

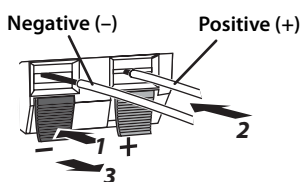

Note: Make sure the terminal is gripping the bare wire, not the insulation.

- 1** Press and hold the terminal tab.
- 2** Insert the bare wire.
- 3** Release the tab so that it closes securely on the bare wire, not the insulation.
- 4** Test the security of the connection by pulling gently on the cable.

Notes

- Make sure the bare wires do not touch each other, as this could damage the speaker or the amplifier.
- If the connections are faulty, you will hear no sound from the speakers.

■ Connecting the speakers

Connect each speaker to the appropriate speaker terminals on your amplifier by using the cables you prepared earlier. See the “Connection diagram” on page 3 for reference.

Make sure you connect the speakers with the correct polarity—positive (+) terminals to positive (+) terminals, and negative (-) terminals to negative (-) terminals. If you get them crossed over, the sound will be unnatural and lack bass.

In your AV receiver’s speaker size settings, specify small (or “S”) for all of the NS-P20 speakers.

If you’re connecting the subwoofer to a Yamaha DSP amplifier or AV receiver, connect to its SUBWOOFER or LOW PASS output.

Connecting the power cables

Once you’ve completed all of the speaker and subwoofer connections, plug the subwoofer, amplifier, and your other AV components into suitable AC wall outlets.

Using the Subwoofer

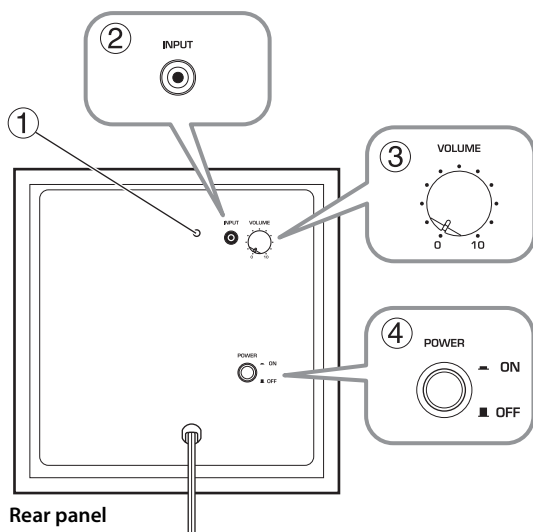

- 1 Power indicator**
Lights up when the POWER switch is set to ON; goes off when the POWER switch is set to OFF.
- 2 INPUT jack**
Input jack for connecting the line-level subwoofer output on your amplifier.
- 3 VOLUME control**
Adjusts the volume of the subwoofer. Turn it clockwise to increase the volume; counterclockwise to decrease the volume.

- 4 POWER switch**
Set this to ON to turn on the subwoofer. Set it to OFF to turn off the subwoofer.

Setting the subwoofer volume

The very first time you use the subwoofer, you need to set the volume balance between the subwoofer and the front speakers as follows.

- 1** Turn on your other AV components.
- 2** Set the subwoofer’s VOLUME control to minimum (0).
- 3** Set the subwoofer’s POWER switch to ON.
The power indicator on the rear panel lights up.
- 4** Play a audio source that contains low-frequency bass sounds. Set the amplifier’s volume control to a suitable level.
- 5** Turn the subwoofer’s VOLUME control up gradually until you achieve a good balance between the subwoofer and the other speakers.

Notes

- Once the subwoofer volume has been set, you can leave the subwoofer’s VOLUME control set as it is and use your amplifier’s volume control to adjust the volume of the entire system.

- If you replace the front speakers (NS-B20) with other speakers, you will need to re-adjust the subwoofer's volume.

Troubleshooting

If this product doesn't work as expected, look for a possible cause below. If the issue you are experiencing is not listed, or you cannot resolve it after reading through these instructions, disconnect the power cable and contact an authorized Yamaha dealer or service center.

■ Front, surround speakers (NS-B20) and center speaker (NS-C20)

Issue	Possible cause	Remedy
There's no sound.	The speaker cables are not connected properly.	Make sure the speaker cables are connected properly.
The sound is very quiet.	The speaker cables are not connected properly.	Make sure the speaker cables are connected properly: L (left) to L, R (right) to R, "+" to "+" and "-" to "-".

■ Subwoofer (NS-SW20)

Issue	Possible cause	Remedy
The POWER switch is set to ON but the subwoofer doesn't work.	The power cable is not connected properly.	Set the POWER switch to OFF, then make sure the power cable is connected properly.
There's no sound.	The VOLUME control is set to 0.	Turn up the VOLUME control.
	The subwoofer cable is not connected properly.	Make sure the subwoofer cable is connected properly.
The subwoofer is too quiet.	The source material doesn't contain much bass.	Try playing source material that contains more bass.
	Bass sounds are being cancelled out by standing waves.	Reposition the subwoofer, or break up parallel wall surfaces by placing bookshelves or other large objects along the wall.

Specifications

■ Front, surround speakers (NS-B20) and center speaker (NS-C20)

Type	Full range acoustic suspension non magnetic shielding type
Driver	7 cm (2-3/4") cone type
Nominal input power	30 W
Maximum input power	100 W
Impedance	6 Ω
Frequency response	
NS-B20	70 Hz-25 kHz (-10 dB) -45 kHz (-30 dB)
NS-C20	65 Hz-25 kHz (-10 dB) -45 kHz (-30 dB)
Sensitivity	
NS-B20	83 dB/2.83 V, 1 m
NS-C20	84 dB/2.83 V, 1 m
Dimensions (W x H x D)	
NS-B20	115 x 176 x 88 mm (4-1/2" x 6-7/8" x 3-1/2")
NS-C20	291 x 101 x 103 mm (11-1/2" x 4" x 4")
Weight	
NS-B20	0.48 kg (1.06 lbs.)
NS-C20	0.68 kg (1.50 lbs.)

■ Subwoofer (NS-SW20)

Type	Advanced Yamaha Active Servo Technology
Driver	16 cm (6-1/2") cone woofer non magnetic shielding type
Amp output power	50 W (100 Hz, 5 Ω , 10% T.H.D)
Amp dynamic power	100 W, 5 Ω
Input impedance	INPUT (1P RCA pin jack): 10 k Ω
Frequency response	30 Hz-160 Hz
Input sensitivity	INPUT (1P RCA pin jack): 80 mV (50 Hz, 50 W/5 Ω)
Power supply	
U.S.A. and Canada models	AC 120 V, 60 Hz
Australia model	AC 240 V, 50 Hz
U.K. and Europe models	AC 230 V, 50 Hz
China, Korea, Asia and General models	AC 110-120/220-240 V, 50/60 Hz
Dimensions (W x H x D)	262 x 264 x 299 mm (10-3/8" x 10-3/8" x 11-3/4")
Weight	7.0 kg (15.4 lbs.)

Specifications are subject to change without notice.

Fiche technique

■ Enceintes avant, surround (NS-B20) et enceinte centrale (NS-C20)

Type..... Suspension acoustique pleine gamme
blindage non magnétique

Haut-parleur Type de cône de 7 cm

Puissance d'entrée nominale..... 30 W

Puissance d'entrée maximum 100 W

Impédance 6 Ω

Réponse en fréquences

NS-B20 70 Hz–25 kHz (–10 dB)
–45 kHz (–30 dB)

NS-C20 65 Hz–25 kHz (–10 dB)
–45 kHz (–30 dB)

Sensibilité

NS-B20 83 dB/2,83 V, 1 m

NS-C20 84 dB/2,83 V, 1 m

Dimensions (L x H x P)

NS-B20 115 x 176 x 88 mm

NS-C20 291 x 101 x 103 mm

Poids

NS-B20 0,48 kg

NS-C20 0,68 kg

■ Subwoofer (NS-SW20)

Type Advanced Yamaha Active Servo Technology

Haut-parleur Grave à cône de 16 cm
blindage non magnétique

Puissance de sortie de l'amplificateur 50 W
(100 Hz, 5 Ω , 10% D.H.T)

Puissance dynamique de l'amplificateur 100 W, 5 Ω

Impédance d'entrée INPUT (prise RCA, 1 broche): 10 k Ω

Réponse en fréquences 30 Hz–160 Hz

Sensibilité d'entrée INPUT (prise RCA, 1 broche):
80 mV (50 Hz, 50 W/5 Ω)

Alimentation

Modèles pour les Etats-Unis

et le Canada CA 120 V, 60 Hz

Modèle pour l'Australie CA 240 V, 50 Hz

Modèles pour le Royaume-Uni

et l'Europe CA 230 V, 50 Hz

Modèles pour la Chine, la Corée,

l'Asie et Universel CA 110–120/220–240 V, 50/60 Hz

Dimensions (L x H x P) 262 x 264 x 299 mm

Poids 7,0 kg

Les caractéristiques techniques sont susceptibles d'être modifiées sans préavis.

