

AV Receiver

RX-V373

Easy Setup Guide

English

This document explains how to set up a 5.1-channel system and play back surround sound from a BD/DVD on the unit.

To reduce the impact on natural resources, the Owner's Manual for this product is supplied on CD-ROM. For more information about this product, refer to the Owner's Manual on the supplied CD-ROM.

PDF versions of this guide and "Owner's Manual" can be downloaded from the following website.

<http://download.yamaha.com/>

[For U.S. customers only]

Visit the following website for additional information, FAQ's, downloads such as "Owner's Manual" and product updates.

<http://usa.yamaha.com/support/>

1 Preparation

Accessories

Check that the following accessories are supplied with the product.

 Remote control

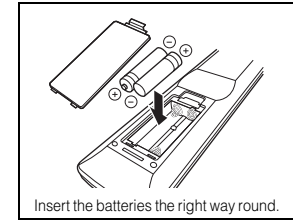
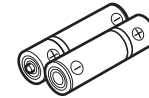
 Batteries
(AAA, R03, UM-4) (x2)

 AM antenna

 FM antenna

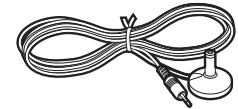
*The supplied FM antenna varies depending on the region of purchase.

 YPAO microphone

 CD-ROM
(Owner's Manual)

 Safety Brochure

 Easy Setup Guide

- The illustrations of the remote control used in this guide are of the U.S.A. model.
- (Australia model only)
For information on how to control external devices with the remote control, refer to "Supplement for Remote Control" on the supplied CD-ROM.

Cables required for connections

The following cables (not supplied) are required to build the system described in this document.

- Speaker cables (x5)
- HDMI cable (x2)
- Audio pin cable (x1)
- Digital optical cable (x1) (not required if your TV supports ARC [Audio Return Channel])

2 Placing speakers

Set up the speakers in the room using the following diagram as a reference.
For information on other speaker systems, refer to "Owner's Manual".

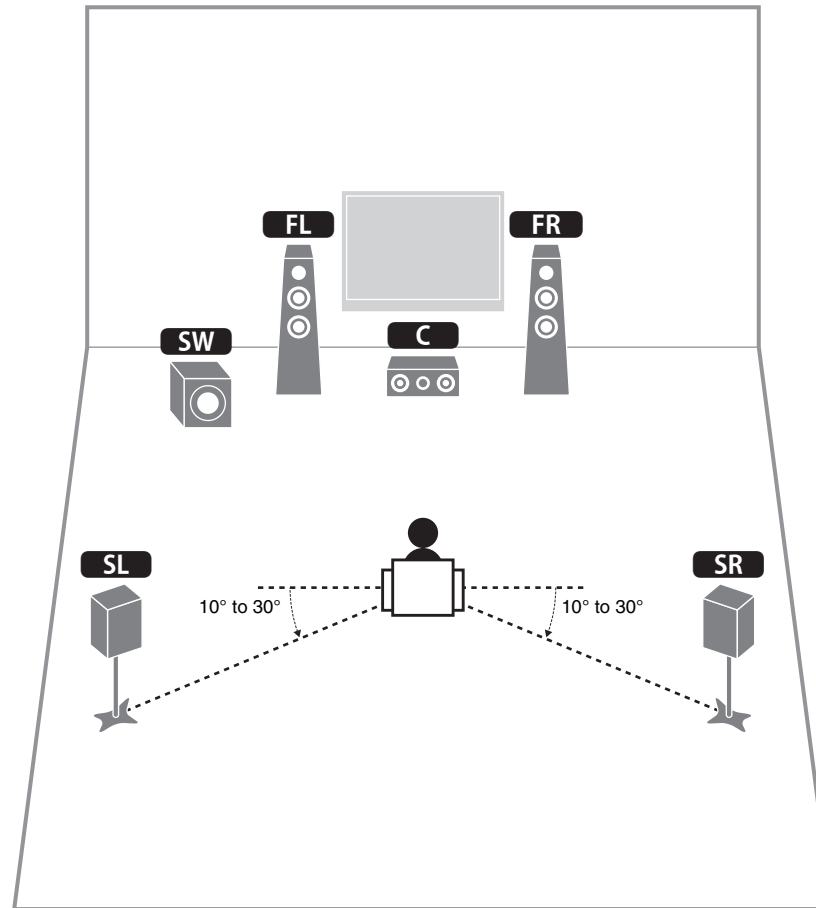

3 Connecting speakers/subwoofer

- (U.S.A. and Canada models only)
Under its default settings, the unit is configured for 8-ohm speakers. When connecting 6-ohm speakers, set the unit's speaker impedance to "6 Ω MIN". For details, see "Setting the speaker impedance" in "Owner's Manual".
- Use a subwoofer equipped with built-in amplifier.
- Before connecting the speakers, remove the unit's power cable from the AC wall outlet and turn off the subwoofer.
- Ensure that the core wires of the speaker cable do not touch each other or come into contact with the unit's metal areas. This may damage the unit or the speakers. If the speaker cables short circuit, "Check SP Wires" will appear on the front display when the unit is turned on.

■ Connecting speaker cables

Speaker cables have two wires. One is for connecting the negative (-) terminals of the unit and the speaker, and the other is for the positive (+) terminals. If the wires are colored to prevent confusion, connect the black wire to the negative and the other wire to the positive terminals.

(Connecting front speakers)

- ① Remove approximately 10 mm (3/8") of insulation from the ends of the speaker cable and twist the bare wires of the cable firmly together.
- ② Loosen the speaker terminal.
- ③ Insert the bare wires of the cable into the gap on the side (upper right or bottom left) of the terminal.
- ④ Tighten the terminal.

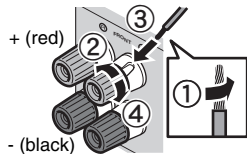

Using a banana plug

(U.S.A., Canada, Australia and General models only)

- ① Tighten the speaker terminal.
- ② Insert a banana plug into the end of the terminal.

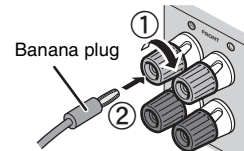

(Connecting center/surround speakers)

- ① Remove approximately 10 mm (3/8") of insulation from the ends of the speaker cable and twist the bare wires of the cable firmly together.
- ② Press down the tab.
- ③ Insert the bare wires of the cable into the hole in the terminal.
- ④ Release the tab.

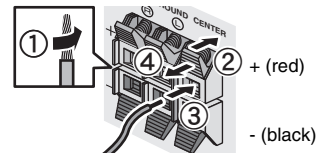

1 Connect the front speakers (FL/FR) to the FRONT (L/R) terminals.

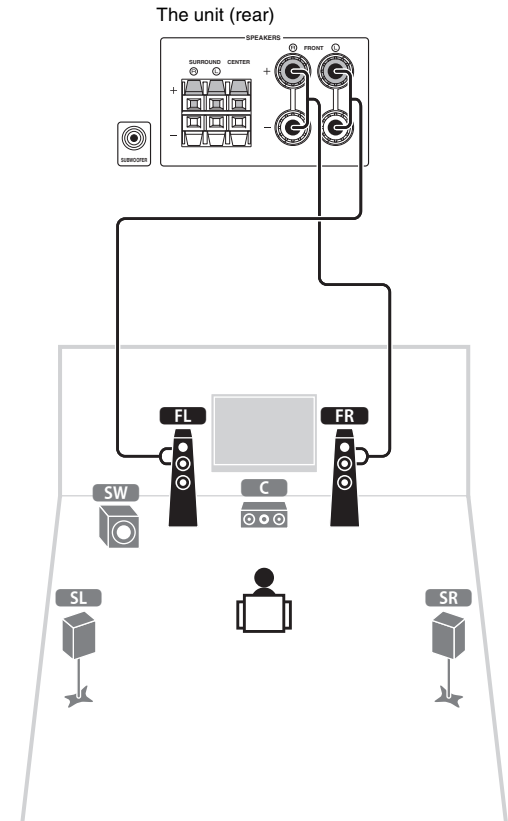

2 Connect the center speaker (**C**) to the **CENTER** terminal.

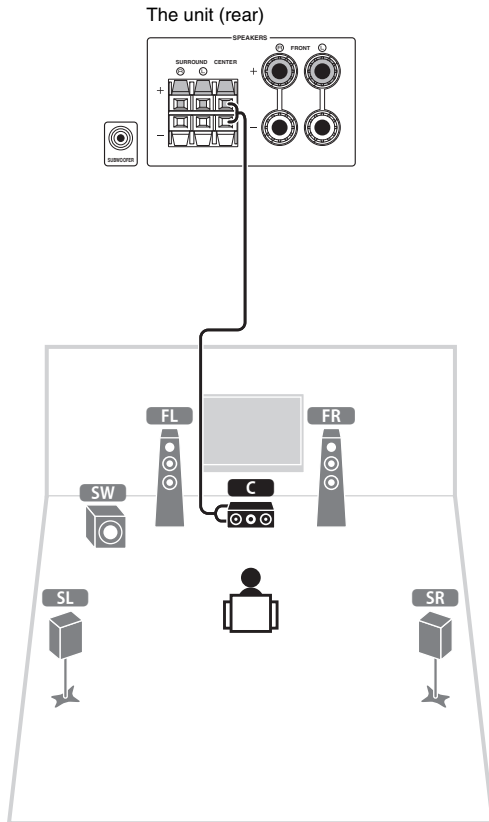

3 Connect the surround speakers (**SL**/**SR**) to the **SURROUND** (L/R) terminals.

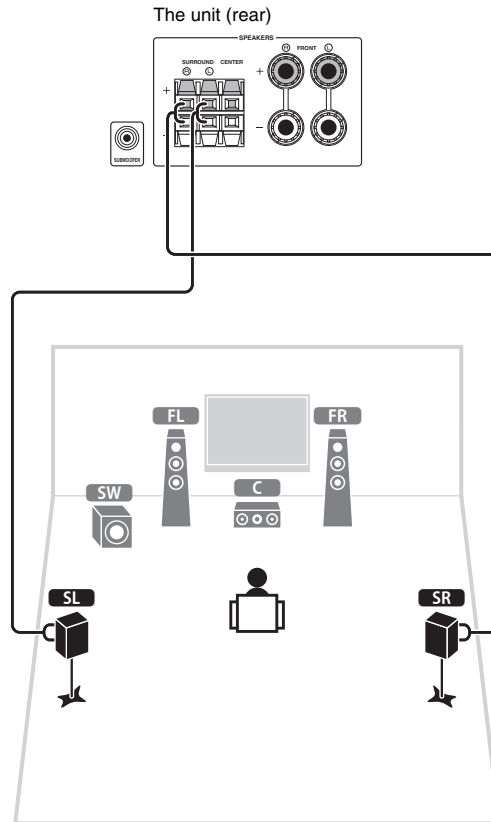

4 Connect the subwoofer (**SW**) to the **SUBWOOFER** jack.

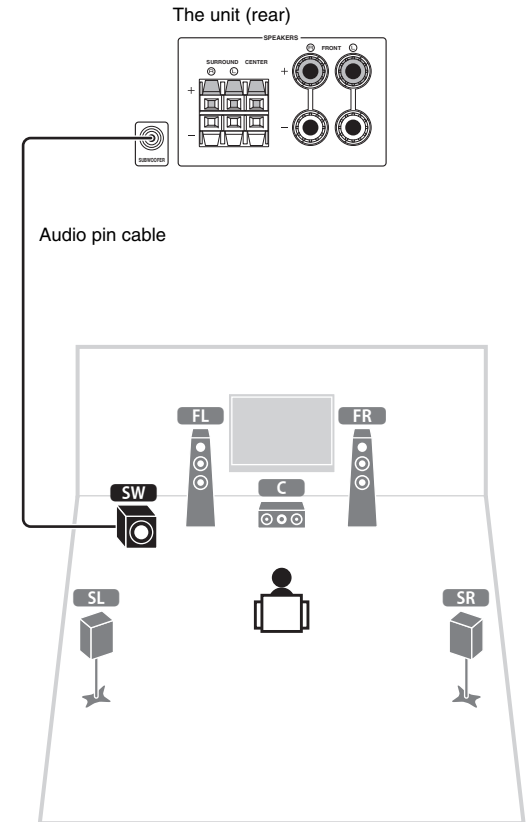

4 Connecting external devices

Before connecting the power cable (General model only)

Make sure you set the switch position of VOLTAGE SELECTOR according to your local voltage. Voltages are AC 110-120/220-240 V, 50/60 Hz.

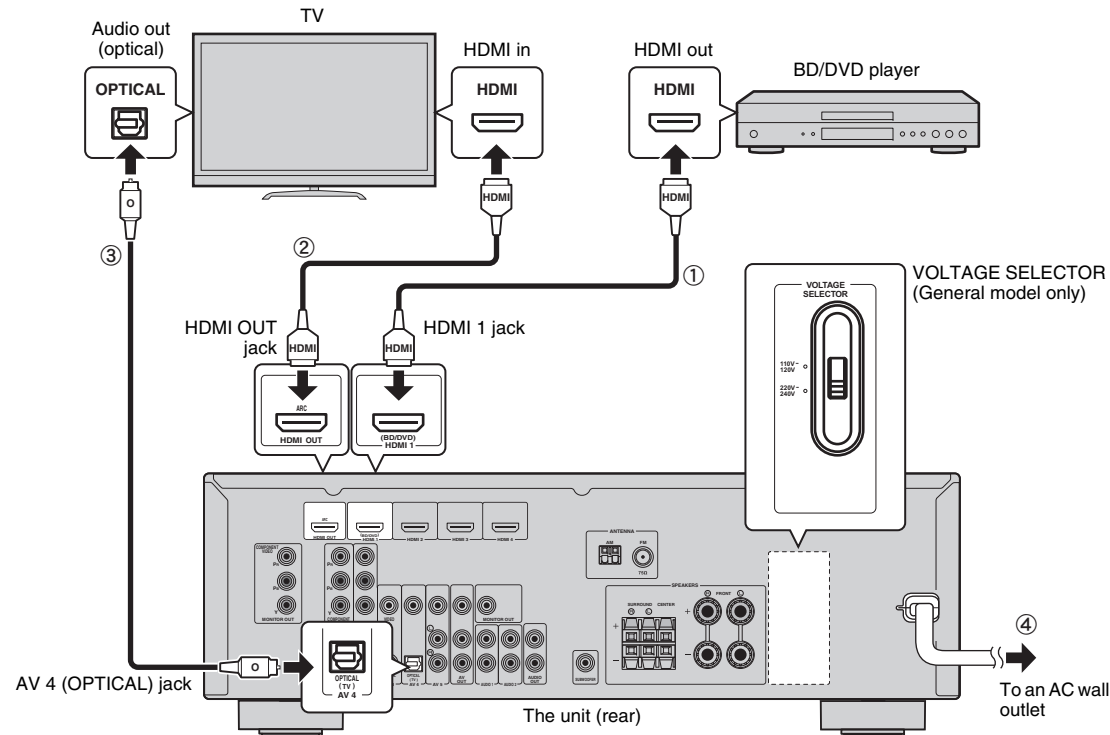

1 Connect external devices to the unit.

- 1 Connect a BD/DVD player to the unit with an HDMI cable.
If the BD/DVD player is currently connected to the TV directly with an HDMI cable, disconnect the cable from the TV and connect it to this unit.
- 2 Connect a TV to the unit with the other HDMI cable.
- 3 Connect a TV to the unit with a digital optical cable.
This connection is required to play back TV audio on the unit. This connection is not required if your TV supports ARC (Audio Return Channel).
- 4 Connect the power cable to an AC wall outlet.



- For information on how to connect radio antennas or other external devices, see "PREPARATIONS" in "Owner's Manual".

2 Turn on the unit, the TV and the BD/DVD player.

3 Use the TV remote control to change the TV input to video from the unit.

The connections are complete. Proceed to the next page to optimize the speaker settings.



- By connecting a TV to the unit with an HDMI cable, you can configure the unit's settings with the menu displayed on the TV. In addition, you can select the on-screen menu language from English (default), French, German, Spanish, Russian and Chinese. For details, refer to "Owner's Manual". In this guide, illustrations of English menu screens are used as examples.

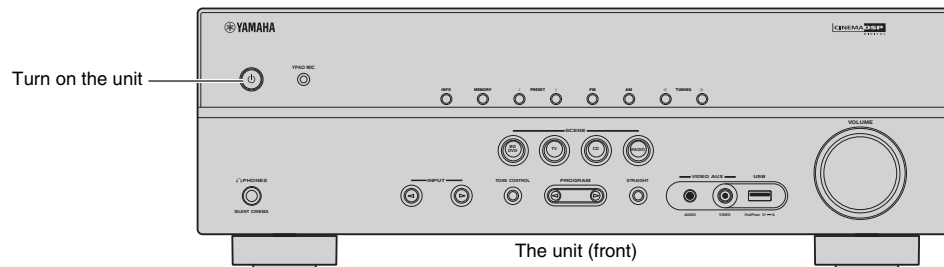

5 Optimizing the speaker settings automatically (YPAO)

The Yamaha Parametric room Acoustic Optimizer (YPAO) function detects speaker connections, measures the distances from them to your listening position(s), and then automatically optimizes the speaker settings, such as volume balance and acoustic parameters, to suit your room.

- During the measuring process, test tones are output at high volume. Ensure that the test tones do not frighten small children. Also, refrain from using this function at night when it may be a nuisance to others.
- During the measuring process, you cannot adjust the volume.
- During the measuring process, keep the room as quiet as possible.
- Do not connect headphones.
- Do not stand between the speakers and the YPAO microphone during the measurement process (about 3 minutes).
- Move to the corner of the room or leave the room.

Preparing for YPAO

Turn on the subwoofer and set the volume to half. If the cross-over frequency is adjustable, set it to maximum.

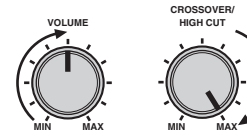

The unit (front)

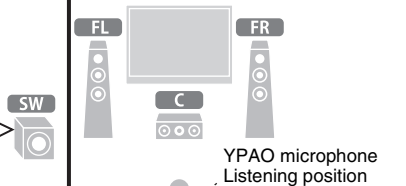
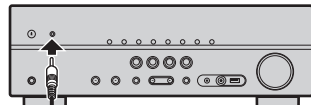

YPAO microphone
Listening position



Place the YPAO microphone at your listening position (same height as your ears). We recommend the use of a tripod as a microphone stand. You can use the tripod screws to fix the microphone in place.



SETUP

Cursor keys
ENTER

1 Connect the YPAO microphone to the YPAO MIC jack on the front panel.

The following screen appears.

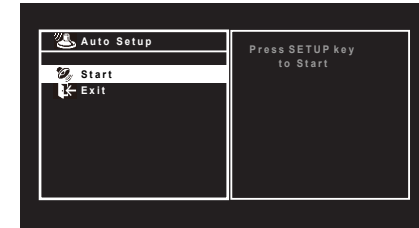

- To cancel the operation, disconnect the YPAO microphone, or use the cursor keys to select "Exit" and press ENTER, before starting the measurement.

2 To start the measurement, press SETUP.

The measurement will start in 10 seconds.

The following screen appears on the TV when the measurement finishes.

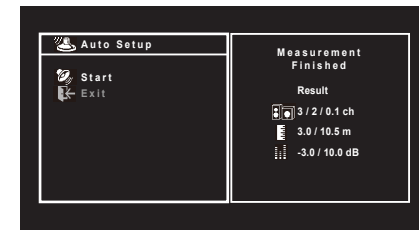



- If any error message (such as E-1) or warning message (such as W-2) appears, see “Error messages” or “Warning messages” in “Owner’s Manual”.
- If the warning message “W-1:Out of Phase” appears, see “If “W-1:Out of Phase” appears”.

3 Use the cursor keys to select “SAVE” (Save) and press ENTER.

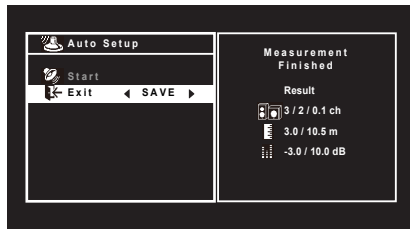

4 Disconnect the YPAO microphone from the unit.

This completes optimization of the speaker settings.

- The YPAO microphone is sensitive to heat, so should not be placed anywhere where it could be exposed to direct sunlight or high temperatures (such as on top of AV equipment).

If “W-1:Out of Phase” appears

Follow the procedure below to check the speaker connections.

Depending on the type of speakers or room environment, this message may appear even if the speakers are connected correctly.

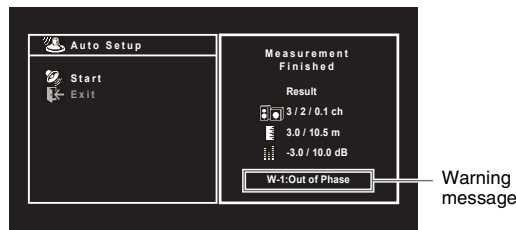

- ① Check for the blinking of the front display's indicator to identify the problem speaker.

Problem speaker (blinks)



- ② Check the cable connections (+/-) of the problem speaker.

If the speaker is connected correctly:

You can save the current settings.

Proceed to step 3.

If the speaker is connected incorrectly:

Turn off the unit, reconnect the speaker cable, and then try YPAO measurement again.

6 Playing back a BD/DVD

Now let's play back a BD/DVD.

We recommend playing back multichannel audio (5.1-channel or more) to feel surround sound produced by the unit.

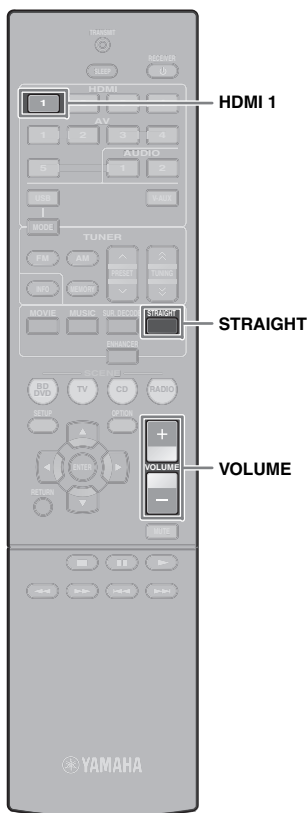

- 1 Press **HDMI 1** to select “HDMI 1” as the input source.



- 2 Start playback on the BD/DVD player.

- 3 Press **STRAIGHT** repeatedly to select “STRAIGHT”.



- When “STRAIGHT” (straight decode) is enabled, each speaker produces each channel audio signal directly (without sound field processing).

- 4 Press **VOLUME** to adjust the volume.



This completes the basic setup procedure.

If surround sound is not working

Sound is only being output from the front speakers during multichannel audio playback

Check the digital audio output setting on the BD/DVD player.

It may be set to 2-channel output (such as PCM).

No sound is coming from a specific speaker

See “Troubleshooting” in “Owner’s Manual”.

Many more features!

The unit has various other functions.

Please refer to “Owner’s Manual” on the supplied CD-ROM to help you get the most out of the unit.

Connecting other playback devices

Connect audio devices (such as CD player), game consoles, camcorders, and many others.

Selecting the sound mode

Select the desired sound program (CINEMA DSP) or surround decoder suitable for movies, music, games, sports programs, and other uses.

Playing back from iPod

By using a USB cable supplied with iPod, you can enjoy iPod music on the unit.

- Listening to FM/AM radio
- Playing back music stored on a USB storage device

For more information, see “What you can do with the unit”.



YAMAHA CORPORATION