



YST-SW010 YST-SW030

SUBWOOFER SYSTEM



OWNER'S MANUAL

IMPORTANT SAFETY INSTRUCTIONS

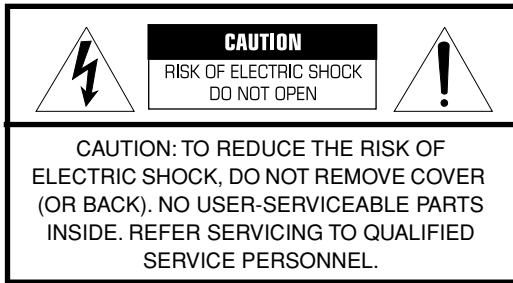

- Explanation of graphic symbols:

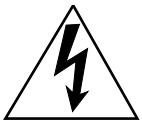

The lightning flash with arrowhead symbol within an equilateral triangle is intended to alert you to the presence of uninsulated "dangerous voltage" within the product's enclosure that may be of sufficient magnitude to constitute a risk of electric shock to persons.



The exclamation point within an equilateral triangle is intended to alert you to the presence of important operating and maintenance (servicing) instructions in the literature accompanying the appliance.

IMPORTANT

Please record the serial number of this system in the space below.

Model:

Serial No.:

The serial number is located on the rear of the unit. Retain this Owner's Manual in a safe place for future reference.

For Canadian Customers

To prevent electric shock, match wide blade of plug to wide slot and fully insert.

This Class B digital apparatus complies with Canadian ICES-003.

This unit features a magnetically shielded design, but there is still a chance that placing it too close to a TV set might impair picture color. Should this happen, move this unit away from the TV set.

- 1 Read these instructions.
- 2 Keep these instructions.
- 3 Heed all warnings.
- 4 Follow all instructions.
- 5 Do not use this apparatus near water.
- 6 Clean only with dry cloth.
- 7 Do not block any ventilation openings. Install in accordance with the manufacturer's instructions.
- 8 Do not install near any heat sources such as radiators, heat registers, stoves, or other apparatus (including amplifiers) that produce heat.
- 9 Do not defeat the safety purpose of the polarized or grounding-type plug. A polarized plug has two blades with one wider than the other. A grounding type plug has two blades and a third grounding prong. The wide blade or the third prong are provided for your safety. If the provided plug does not fit into your outlet, consult an electrician for replacement of the obsolete outlet.
- 10 Protect the power cord from being walked on or pinched particularly at plugs, convenience receptacles, and the point where they exit from the apparatus.
- 11 Only use attachments/accessories specified by the manufacturer.
- 12 Use only with the cart, stand, tripod, bracket, or table specified by the manufacturer, or sold with the apparatus. When a cart is used, use caution when moving the cart/apparatus combination to avoid injury from tip-over.
- 13 Unplug this apparatus during lightning storms or when unused for long periods of time.
- 14 Refer all servicing to qualified service personnel. Servicing is required when the apparatus has been damaged in any way, such as power-supply cord or plug is damaged, liquid has been spilled or objects have fallen into the apparatus, the apparatus has been exposed to rain or moisture, does not operate normally, or has been dropped.



FCC INFORMATION (for US customers)

1. **IMPORTANT NOTICE: DO NOT MODIFY THIS UNIT!**

This product, when installed as indicated in the instructions contained in this manual, meets FCC requirements. Modifications not expressly approved by Yamaha may void your authority, granted by the FCC, to use the product.

2. **IMPORTANT:** When connecting this product to accessories and/or another product, use only high quality shielded cables. Cable(s) supplied with this product **MUST** be used. Follow all installation instructions. Failure to follow instructions could void your FCC authorization to use this product in the USA.

3. **NOTE:** This product has been tested and found to comply with the requirements listed in FCC Regulations, Part 15 for Class "B" digital devices. Compliance with these requirements provides a reasonable level of assurance that your use of this product in a residential environment will not result in harmful interference with other electronic devices.

This equipment generates or uses radio frequencies and, if not installed and used in accordance with the instructions in the user's manual, may cause interference harmful to the operation of other electronic devices.

Compliance with FCC regulations does not guarantee that interference will not occur in all installations. If this product is found to be the source of interference, which can be determined by turning the unit "OFF" and "ON," please try to eliminate the problem using one of the following measures:

- Relocate either this product or the device that is being affected by the interference.
- Utilize power outlets that are on different branch circuits (circuit breaker or fuse) or install AC line filter(s).
- In the case of radio or TV interference, relocate or reorient the antenna. If the antenna lead-in is 300 ohm ribbon lead, change the lead-in to a coaxial type cable.

If these corrective measures do not produce satisfactory results, please contact the local retailer authorized to distribute this product. If you cannot locate the appropriate retailer, please contact Yamaha Electronics Corp., U.S.A.; 6660 Orangethorpe Ave; Buena Park, CA 90620.

The above statements apply **ONLY** to those products distributed by Yamaha Corporation of America or its subsidiaries.

For U.K. customers

If the socket outlets in the home are not suitable for the plug supplied with this appliance, it should be cut off and an appropriate 3 pin plug fitted. For details, refer to the following instructions.

Note: The plug severed from the mains lead must be destroyed, as a plug with bared flexible cord is hazardous if engaged in a live socket outlet.

SPECIAL INSTRUCTIONS FOR U.K. MODEL

IMPORTANT:

THE WIRES IN MAINS LEAD ARE COLOURED IN ACCORDANCE WITH THE FOLLOWING CODE:

Blue: NEUTRAL

Brown: LIVE

As the colours of the wires in the mains lead of this apparatus may not correspond with the coloured markings identifying the terminals in your plug, proceed as follows: The wire which is coloured **BLUE** must be connected to the terminal which is marked with the letter **N** or coloured **BLACK**. The wire which is coloured **BROWN** must be connected to the terminal which is marked with the letter **L** or coloured **RED**. Making sure that neither core is connected to the earth terminal of the three pin plug.

We Want You Listening for a Lifetime

Yamaha and the Electronic Industries Association's Consumer Electronics Group want you to get the most enjoyment out of your equipment by playing it at a safe level — a level that lets the sound come through loud and clear without annoying blaring or distortion — and, most importantly, without damaging your sensitive hearing.

Since hearing damage from loud sounds is often undetectable until it is too late, Yamaha and the Electronic Industries Association's Consumer Electronics Group recommend that you avoid prolonged exposure to excessive volume levels.



Precautions: Read this before operating this unit

- To assure the finest performance, please read this manual carefully. Keep it in a safe place for future reference.
 - Install this unit in a cool, dry, clean place - away from windows, heat sources, sources of excessive vibration, dust, moisture and cold. Avoid sources of humming (transformers, motors). To prevent fire or electrical shock, do not expose this unit to rain or water.
 - Never open the cabinet. If any foreign objects drop into the set, contact your dealer.
 - The voltage to be used must be the same as that specified on the rear panel. Using this unit with a higher voltage than specified is dangerous and may cause a fire and/or electric shock.
 - To reduce the risk of fire or electric shock, do not expose this unit to rain or moisture.
 - Do not use force on switches, controls, or connection wires. When moving the unit, first disconnect the power plug and the wires connected to other equipments. Never pull the wires themselves.
 - When not planning to use this unit for a long period (ie., vacation, etc.), disconnect the AC power plug from the wall outlet.
 - To prevent lightning damage, disconnect the AC power plug when there is an electric storm.
 - Since this unit has a built-in power amplifier, heat will radiate from the rear panel. Place the unit apart from the walls, allowing at least 20 cm of space above, behind and on both sides of the unit to prevent fire or damage. Furthermore, do not position with the rear panel facing down on the floor or other surfaces.
 - Do not cover the rear panel of this unit with a newspaper, a tablecloth, a curtain, etc. in order not to obstruct heat radiation. If the temperature inside the unit rises, it may cause fire, damage to the unit and/or personal injury.
 - Do not place the following objects on this unit:
 - Glass, china, small metallic etc.
 - If glass etc. falls by vibrations and breaks, it may cause bodily injury.
 - A burning candle etc.
 - If the candle falls by vibrations, it may cause fire and bodily injury.
 - A vessel with water in it
 - If the vessel falls by vibrations and water spills, it may cause damage to the speaker, and/or you may get an electric shock.
 - Do not place this unit where foreign objects such as water drips might fall. It might cause a fire, damage to this unit, and/or personal injury.
 - Never put a hand or a foreign object into the YST port located on the right side of this unit. When moving this unit, do not hold the port as it might cause personal injury and/or damage to this unit.
 - Never place a fragile object near the YST port of this unit. If the object falls or drops by the air pressure, it may cause damage to the unit and/or personal injury.
 - Never open the cabinet. It might cause an electric shock since this unit uses a high voltage. It might also cause personal injury and/or damage to this unit.
 - When using a humidifier, be sure to avoid condensation inside this unit by allowing enough spaces around this unit or avoiding excess humidification. Condensation might cause a fire, damage to this unit, and/or electric shock.
 - Super-bass frequencies reproduced by this unit may cause a turntable to generate a howling sound. In such a case, move this unit away from the turntable.
 - This unit may be damaged if certain sounds are continuously outputted at high volume level. For example, if 20 Hz-50 Hz sine waves from a test disc, bass sounds from electronic instruments, etc. are continuously outputted, or when the stylus of a turntable touches the surface of a disc, reduce the volume level to prevent this unit from being damaged.
 - If you hear distorted noise (i.e., unnatural, intermittent “rapping” or “hammering” sounds) coming from this unit, reduce the volume level. Extremely loud playing of a movie soundtrack’s low frequency, bass-heavy sounds or similarly loud popular music passages can damage this subwoofer system.
 - Vibration generated by super-bass frequencies may distort images on a TV. In such a case, move this unit away from the TV set.
 - Do not attempt to clean this unit with chemical solvents as this might damage the finish. Use a clean, dry cloth.
 - Be sure to read the “TROUBLESHOOTING” section regarding common operating errors before concluding that the unit is faulty.
 - **Secure placement or installation is the owner’s responsibility. YAMAHA shall not be liable for any accident caused by improper placement or installation of the subwoofer.**
- VOLTAGE SELECTOR**
(For China, Korea and General models)
The voltage selector switch on the rear panel of this unit must be set for your local main voltage BEFORE plugging this unit into the AC main supply. Voltages are 110–120/220–240 V AC, 50/60 Hz.

WARNING

TO REDUCE THE RISK OF FIRE OR ELECTRIC SHOCK, DO NOT EXPOSE THIS UNIT TO RAIN OR MOISTURE.

Table of contents

Precautions: Read this before operating this unit	iii
Introduction	1
Features	1
Supplied accessories	1
Positioning the subwoofer	2
Connections	3
Basic connection example	3
Connecting components and the subwoofer to AC power	3
Using the subwoofer	4
Pre-adjusting the subwoofer volume	4
Advanced Yamaha Active Servo Technology	5
Troubleshooting	6
Specifications	7
Frequency characteristics.	7

Introduction

Features



Advanced YST

Advanced Yamaha Active Servo Technology is a unique system to let the speaker unit have a perfectly linear motion by the speaker and amplifier combination.



QD-Bass Technology

QD-Bass (Quatre Dispersion Bass) technology is a Yamaha unique technology to radiate the sound efficiently in four horizontal direction.

Supplied accessories

Please confirm that the following item is included in the package.

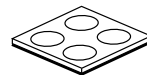

Non-skid pads

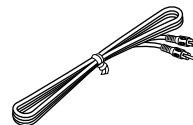

Subwoofer cable (5 m)

Positioning the subwoofer

Although the placement of the subwoofer is not as critical as that of the other speakers, it is best to place the subwoofer outside either the right or left front speaker as shown in figure A.

A (Recommended)

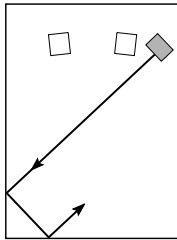

- : Subwoofer
- : Front speaker

The placement shown in Figure **B** is also acceptable. However, in some cases, if you listen from the center of the room, the super-bass range from the subwoofer may sound weak. This is due to “standing waves” that can develop between parallel walls that effectively diminish or cancel the bass sound. In this event, face the subwoofer obliquely to the wall. It also may help to break up the parallel surface by placing bookshelves or other large objects along the wall.

B (Acceptable)

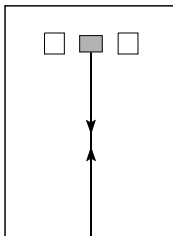

- : Subwoofer
- : Front speaker

Non-skid pads: Place the included non-skid pads at the four corners of the bottom of the subwoofer to prevent the subwoofer from sliding due to vibration or minor impact.

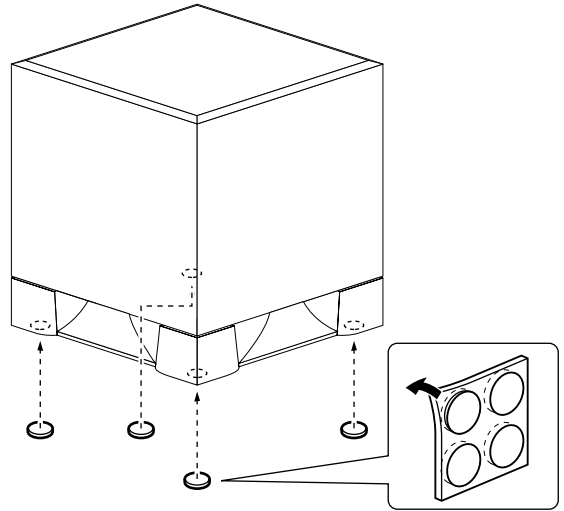

Connections

Caution: Plug the power cables for the subwoofer and other audio/video components into an AC outlet only after you complete all other connections.

Basic connection example

Connect a subwoofer cable to the output jack of your AV amplifier and to the INPUT jack of the subwoofer.

Amplifier (The rear panel of various amplifiers may differ in appearance.)

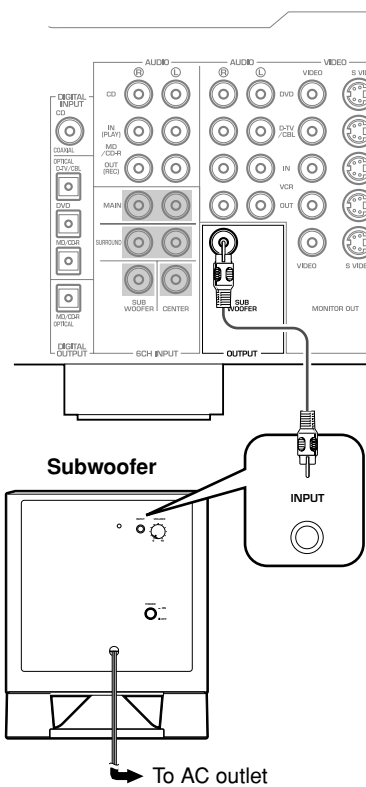

Connecting components and the subwoofer to AC power

After you complete a subwoofer connection, plug the amplifier, other audio/video component, and the subwoofer into an AC outlet of appropriate voltage. Make sure the subwoofer's VOLUME control is set to 0 before proceeding to adjust the speaker balance as described on page 4.

Using the subwoofer

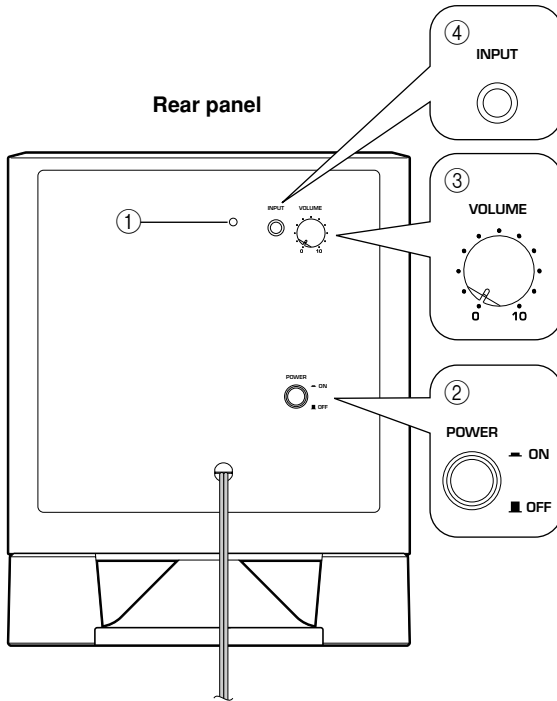

Pre-adjusting the subwoofer volume

Before you use the subwoofer, first adjust the volume balance between the subwoofer and the front speakers by following the procedure below.

1. Set the **VOLUME** control to minimum (0).
2. Turn on the power to all other components.
3. Press the **POWER** switch to the ON position.
The power indicator on the rear panel lights up green.
4. Play a source that contains low-frequency sounds. Adjust the amplifier's volume control to the desired listening level.
5. Increase the volume gradually to adjust the volume balance between the subwoofer and the front speakers. To enjoy natural bass sound, keep the subwoofer volume at a level where it is barely distinguishable from other speakers.
6. Adjust the volume of the entire sound system using the amplifier's volume control.

① Power indicator

Lights up GREEN when the **POWER** switch (②) is turned ON; turns off when the **POWER** switch is turned OFF.

② POWER switch

Press this switch to the ON position to turn on the power to the subwoofer. When the power of the subwoofer is on, the power indicator (①) on the rear panel lights up green. Press this switch again to set it to the OFF position to turn off the power of the subwoofer.

③ VOLUME control

Adjusts the volume level. Turn the control clockwise to increase the volume, and counter-clockwise to decrease the volume.

④ INPUT terminal

Input terminal for line level signals from the amplifier.

Note: It is recommended to set the **VOLUME** control about in the middle position when using in a multi channel home theater system.

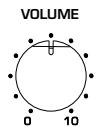

Advanced Yamaha Active Servo Technology

The theory behind Yamaha Active Servo Technology is based on two factors: the Helmholtz resonator and negative-impedance drive. Active Servo Processing speakers reproduce the bass frequencies through an “air woofer,” which is a port or opening in the speaker’s cabinet.

This opening is used instead of, and performs the functions of, a woofer in a conventionally designed speaker system.

Thus, signals of low amplitude within the cabinet can, according to Helmholtz resonance theory, be output from this opening as waves of great amplitude if the size of the opening and the volume of the cabinet are in proportion to satisfy a certain ratio. In order to accomplish this, moreover, the amplitudes within the cabinet must be both precise and of sufficient power because these amplitudes must overcome the “load” presented by the air in the cabinet.

This problem is resolved by a design in which the amplifier supplies special signals. If the electrical resistance of the voice coil could be reduced to zero, the movement of the speaker unit would become linear with respect to signal voltage. To accomplish this, the system utilizes a special negative-impedance output-drive amplifier that subtracts the output impedance of the amplifier.

By employing negative-impedance drive circuits, the amplifier is able to generate precise, low-amplitude, low frequency waves with superior damping characteristics.

These waves are then radiated from the cabinet opening as high-amplitude signals. The system can, therefore, by employing the negative-impedance output drive amplifier and a speaker cabinet featuring a Helmholtz resonator, reproduce an extremely wide range of frequencies with outstanding sound quality and low distortion.

The features described above combine to create the fundamental structure of conventional Yamaha Active Servo Technology.

Our new Active Servo Technology — Advanced Yamaha Active Servo Technology — adopts Advanced Negative Impedance Converter (ANIC) circuits, which allow the conventional negative impedance converter to dynamically vary to select an optimum value for speaker impedance variation. With these new ANIC circuits, Advanced Yamaha Active Servo Technology provides a more stable performance and improved sound pressure compared to conventional Yamaha Active Servo Technology, resulting in more natural and dynamic bass reproduction.

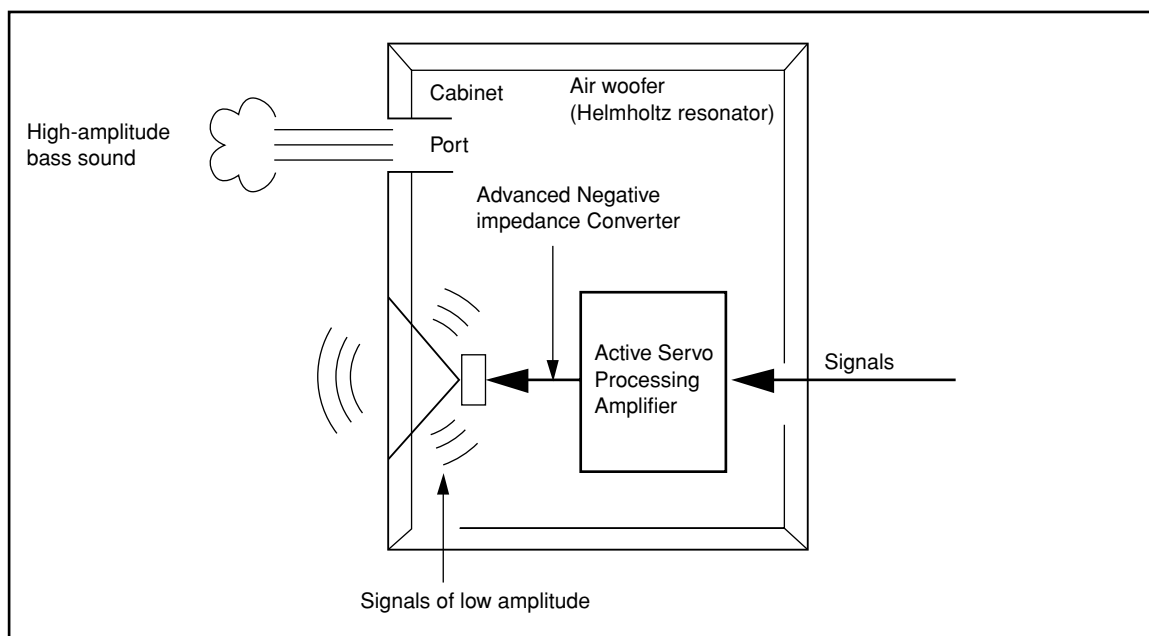

Troubleshooting

Refer to the chart below if the unit does not function properly. If the problem you are experiencing is not listed, or if the instructions fail to help you resolve the problem, disconnect the power cord and contact your authorized Yamaha dealer or service center.

Problem	Cause	Remedy
Power is not supplied even though the POWER switch is set to the ON position.	The power plug is not securely connected.	Turn the power switch OFF, then connect the power plug securely.
No sound.	The VOLUME control is set to 0.	Turn the VOLUME control to the right (clockwise).
	A subwoofer cable is not connected securely.	Connect a subwoofer cable securely.
Sound level is too low.	You are playing a sound source that includes inadequate bass frequencies.	Play a sound source that includes more bass frequencies.
	The sound level has been diminished by standing waves.	Reposition the subwoofer, or break up the parallel wall surface by placing bookshelves or other large objects along the wall.

Specifications

YST-SW010

Type.....Advanced Yamaha Active Servo Technology
Driver 16 cm (6.5") cone woofer
 Magnetically shielded type
Output Power 50 W
Dynamic Power 100 W, 5 Ω
Input Impedance 12 k Ω
Frequency Response 30 Hz – 200 Hz
Input Sensitivity 50 mV (50 Hz, 50 W/5 Ω)

Power Supply

[U.S.A. and Canada models] AC 120 V, 60 Hz
 [Australia model] AC 240 V, 50 Hz
 [China model] AC 110–120/220–240 V, 50/60 Hz
 [Korea model] AC 110/220 V, 60 Hz
 [U.K. and Europe models]..... AC 230 V, 50 Hz
 [Asia model]..... AC 110–120/220–240 V, 50/60 Hz
 [General model].. AC 110–120/220–240 V, 50/60 Hz

Power Consumption..... 45 W

Dimensions (W x H x D)

.....280 mm x 325 mm x 293 mm

Weight..... 8.5 kg

YST-SW030

Type Advanced Yamaha Active Servo Technology
Driver 20 cm (8") cone woofer
 Magnetically shielded type
Output Power 75 W
Dynamic Power 130 W, 5 Ω
Input Impedance 12 k Ω
Frequency Response..... 28 Hz – 200 Hz
Input Sensitivity 70 mV (50 Hz, 75 W/5 Ω)

Power Supply

[U.S.A. and Canada models].....AC 120 V, 60 Hz
 [Australia model]AC 240 V, 50 Hz
 [China model].....AC 110–120/220–240 V, 50/60 Hz
 [Korea model].....AC 110/220 V, 60 Hz
 [U.K. and Europe models].....AC 230 V, 50 Hz
 [Asia model]..... AC 110–120/220–240 V, 50/60 Hz
 [General model].. AC 110–120/220–240 V, 50/60 Hz

Power Consumption 70 W

Dimensions (W x H x D)

..... 290 mm x 360 mm x 311 mm

Weight..... 10 kg

Frequency characteristics

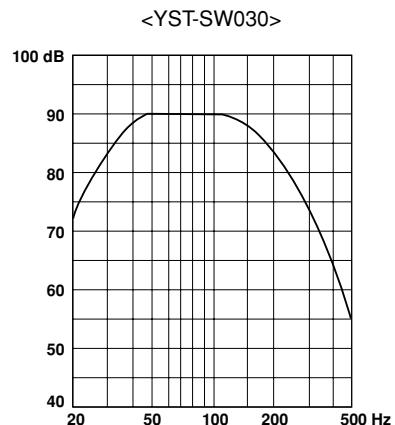
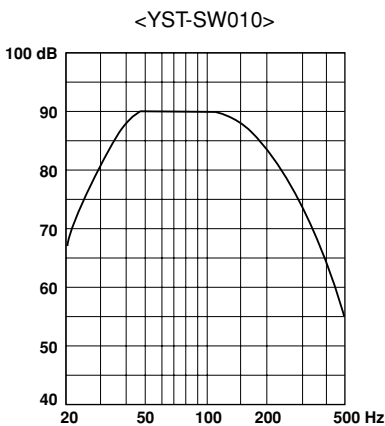

Specifications are subject to change without notice.



©2004 YAMAHA CORPORATION All rights reserved.

YAMAHA ELECTRONICS CORPORATION, USA 6660 ORANGETHORPE AVE., BUENA PARK, CALIF. 90620, U.S.A.
YAMAHA CANADA MUSIC LTD. 135 MILNER AVE., SCARBOROUGH, ONTARIO M1S 3R1, CANADA
YAMAHA ELECTRONIK EUROPA G.m.b.H. SIEMENSSTR. 22-34, 25462 RELLINGEN BEI HAMBURG, F.R. OF GERMANY
YAMAHA ELECTRONIQUE FRANCE S.A. RUE AMBROISE CROIZAT BP70 CROISSY-BEAUBOURG 77312 MARNE-LA-VALLEE CEDEX02, FRANCE
YAMAHA ELECTRONICS (UK) LTD. YAMAHA HOUSE, 200 RICKMANSWORTH ROAD WATFORD, HERTS WD18 7GQ, ENGLAND
YAMAHA SCANDINAVIA A.B. J A WETTERGRENS GATA 1, BOX 30053, 400 43 VÄSTRA FRÖLUNDA, SWEDEN
YAMAHA MUSIC AUSTRALIA PTY, LTD. 17-33 MARKET ST., SOUTH MELBOURNE, 3205 VIC., AUSTRALIA

YAMAHA CORPORATION
Printed in China © WC73030