

DVD PLAYER
LECTEUR DE DVD

DVD-S659

*OWNER'S MANUAL
MODE D'EMPLOI
MANUAL DE INSTRUCCIONES*

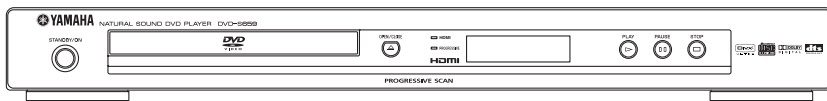

IMPORTANT SAFETY INSTRUCTIONS

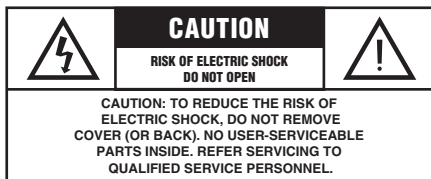

Explanation of Graphical Symbols



The lightning flash with arrowhead symbol, within an equilateral triangle, is intended to alert you to the presence of uninsulated "dangerous voltage" within the product's enclosure that may be of sufficient magnitude to constitute a risk of electric shock to persons.



The exclamation point within an equilateral triangle is intended to alert you to the presence of important operating and maintenance (servicing) instructions in the literature accompanying the appliance.

- 1 Read Instructions — All the safety and operating instructions should be read before the product is operated.
- 2 Retain Instructions — The safety and operating instructions should be retained for future reference.
- 3 Heed Warnings — All warnings on the product and in the operating instructions should be adhered to.
- 4 Follow Instructions — All operating and use instructions should be followed.
- 5 Cleaning — Unplug this product from the wall outlet before cleaning. Do not use liquid cleaners or aerosol cleaners. Use a damp cloth for cleaning.
- 6 Attachments — Do not use attachments not recommended by the product manufacturer as they may cause hazards.
- 7 Water and Moisture — Do not use this product near water — for example, near a bath tub, wash bowl, kitchen sink, or laundry tub; in a wet basement; or near a swimming pool; and the like.
- 8 Accessories — Do not place this product on an unstable cart, stand, tripod, bracket, or table. The product may fall, causing serious injury to a child or adult, and serious damage to the product. Use only with a cart, stand, tripod, bracket, or table recommended by the manufacturer, or sold with the product.
Any mounting of the product should follow the manufacturer's instructions, and should use a mounting accessory recommended by the manufacturer.
- 9 A product and cart combination should be moved with care. Quick stops, excessive force, and uneven surfaces may cause the product and cart combination to overturn.
- 10 Ventilation — Slots and openings in the cabinet are provided for ventilation and to ensure reliable operation of the product and to protect it from overheating, and these openings must not be blocked or covered. The openings should never be blocked by placing the product on a bed, sofa, rug, or other similar surface.
This product should not be placed in a built-in installation such as a bookcase or rack unless proper ventilation is provided or the manufacturer's instructions have been adhered to.
- 11 Power Sources — This product should be operated only from the type of power source indicated on the marking label. If you are not sure of the type of power supply to your home, consult your product dealer or local power company. For products intended to operate from battery power, or other sources, refer to the operating instructions.



- 12 Grounding or Polarization — This product may be equipped with a polarized alternating current line plug (a plug having one blade wider than the other). This plug will fit into the power outlet only one way. This is a safety feature. If you are unable to insert the plug fully into the outlet, try reversing the plug. If the plug should still fail to fit, contact your electrician to replace your obsolete outlet. Do not defeat the safety purpose of the polarized plug.
- 13 Power-Cord Protection — Power-supply cords should be routed so that they are not likely to be walked on or pinched by items placed upon or against them, paying particular attention to cords at plugs, convenience receptacles, and the point where they exit from the product.
- 14 Lightning — For added protection for this product during a lightning storm, or when it is left unattended and unused for long periods of time, unplug it from the wall outlet and disconnect the antenna or cable system. This will prevent damage to the product due to lightning and power-line surges.
- 15 Power Lines — An outside antenna system should not be located in the vicinity of overhead power lines or other electric light or power circuits, or where it can fall into such power lines or circuits. When installing an outside antenna system, extreme care should be taken to keep from touching such power lines or circuits as contact with them might be fatal.
- 16 Overloading — Do not overload wall outlets, extension cords, or integral convenience receptacles as this can result in a risk of fire or electric shock.
- 17 Object and Liquid Entry — Never push objects of any kind into this product through openings as they may touch dangerous voltage points or short-out parts that could result in a fire or electric shock. Never spill liquid of any kind on the product.
- 18 Servicing — Do not attempt to service this product yourself as opening or removing covers may expose you to dangerous voltage or other hazards. Refer all servicing to qualified service personnel.
- 19 Damage Requiring Service — Unplug this product from the wall outlet and refer servicing to qualified service personnel under the following conditions:
 - a) When the power-supply cord or plug is damaged,
 - b) If liquid has been spilled, or objects have fallen into the product,
 - c) If the product has been exposed to rain or water,
 - d) If the product does not operate normally by following the operating instructions. Adjust only those controls that are covered by the operating instructions as an improper adjustment of other controls may result in damage and will often require extensive work by a qualified technician to restore the product to its normal operation,
 - e) If the product has been dropped or damaged in any way, and
 - f) When the product exhibits a distinct change in performance - this indicates a need for service.
- 20 Replacement Parts — When replacement parts are required, be sure the service technician has used replacement parts specified by the manufacturer or have the same characteristics as the original part. Unauthorized substitutions may result in fire, electric shock, or other hazards.
- 21 Safety Check — Upon completion of any service or repairs to this product, ask the service technician to perform safety checks to determine that the product is in proper operating condition.
- 22 Wall or Ceiling Mounting — The unit should be mounted to a wall or ceiling only as recommended by the manufacturer.
- 23 Heat — The product should be situated away from heat sources such as radiators, heat registers, stoves, or other products (including amplifiers) that produce heat.

FCC INFORMATION (for US customers)

1. IMPORTANT NOTICE: DO NOT MODIFY THIS UNIT!

This product, when installed as indicated in the instructions contained in this manual, meets FCC requirements. Modifications not expressly approved by Yamaha may void your authority, granted by the FCC, to use the product.

2. IMPORTANT: When connecting this product to accessories and/or another product use only high quality shielded cables. Cable/s supplied with this product MUST be used. Follow all installation instructions. Failure to follow instructions could void your FCC authorization to use this product in the USA.

3. NOTE: This product has been tested and found to comply with the requirements listed in FCC Regulations, Part 15 for Class "B" digital devices.

Compliance with these requirements provides a reasonable level of assurance that your use of this product in a residential environment will not result in harmful interference with other electronic devices. This equipment generates/uses radio frequencies and, if not installed and used according to the instructions found in the users manual, may cause interference harmful to the operation of other electronic devices. Compliance with FCC regulations does not guarantee that interference will not occur in all installations. If this product is found to be the source of interference, which can be determined by turning the product "OFF" and "ON", please try to eliminate the problem by using one of the following measures:

Relocate either this product or the device that is being affected by the interference.

Utilize power outlets that are on different branch (circuit breaker or fuse) circuits or install AC line filter/s.

In the case of radio or TV interference, relocate/reorient the antenna. If the antenna lead-in is 300 ohm ribbon lead, change the lead-in to coaxial type cable.

If these corrective measures do not produce satisfactory results, please contact the local retailer authorized to distribute this type of product. If you can not locate the appropriate retailer, please contact Yamaha Electronics Corp., 6660 Orangethorpe Ave. Buena Park, CA90622.

The above statements apply ONLY to those products distributed by Yamaha Corporation of America or its subsidiaries.

We Want You Listening For A Lifetime

YAMAHA and the Electronic Industries Association's Consumer Electronics Group want you to get the most out of your equipment by playing it at a safe level. One that lets the sound come through loud and clear without annoying blaring or distortion - and, most importantly, without affecting your sensitive hearing.

Since hearing damage from loud sounds is often undetectable until it is too late, YAMAHA and the Electronic Industries Association's Consumer Electronics Group recommend you to avoid prolonged exposure from excessive volume levels.

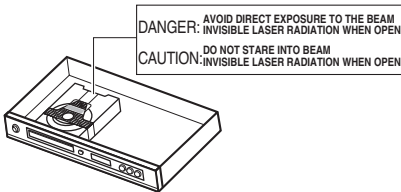
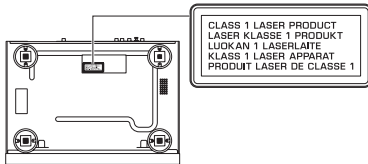

LASER SAFETY

This unit employs a laser. Due to possible eye injury, only a qualified service person should remove the cover or attempt to service this device.

DANGER

This unit emits visible laser radiation when open. Avoid direct eye exposure to beam. When this unit is plugged into a wall outlet, do not place your eyes close to the opening of the disc tray and other openings or look inside.

SECURITE LASER

L'appareil utilise un laser. En raison des risques de blessure des yeux, le retrait du couvercle ou les réparations de l'appareil devront être confiés exclusivement à un technicien d'entretien qualifié.

DANGER

Risque d'exposition au laser en cas d'ouverture. Eviter toute exposition au faisceau. Lorsque cet appareil est branché à la prise de courant, ne pas approcher les yeux de l'ouverture du plateau changeur et des autres ouvertures pour regarder à l'intérieur.

SEGURIDAD CONTRA LA RADIACIÓN LÁSER

Esta unidad utiliza rayos láser. Debido a la posibilidad de que se produzcan daños en los ojos, la extracción de la cubierta de la unidad o las

PELIGRO

Esta unidad emite radiación láser visible cuando se abre. Evite la exposición directa a los rayos láser. Cuando esta unidad esté enchufada a una toma de corriente, no ponga sus ojos cerca de la abertura de la bandeja del disco ni otras aberturas para mirar al interior.

CAUTION: READ THIS BEFORE OPERATING THIS UNIT.

- 1 To assure the finest performance, please read this manual carefully. Keep it in a safe place for future reference.
- 2 Install this unit in a well ventilated, cool, dry, clean place — away from direct sunlight, heat sources, vibration, dust, moisture, or cold. In a cabinet, allow about 2.5cm (1 inch) of free space all around this unit for adequate ventilation.
- 3 Locate this unit away from other electrical appliances, motors, or transformers to avoid humming sounds.
- 4 Do not expose this unit to sudden temperature changes from cold to hot, nor locate this unit in an environment with high humidity (i.e., a room with a humidifier) to prevent condensation inside this unit, which may cause an electrical shock, fire, damage to this unit, and/or personal injury.
- 5 Avoid installing this unit where foreign objects may fall onto this unit and/or this unit may be exposed to liquid dripping or splashing. On the top of this unit, do not place:
 - Other components, as they may cause damage and/or discoloration on the surface of this unit.
 - Burning objects (i.e., candles), as they may cause fire, damage to this unit, and/or personal injury.
 - Containers with liquid in them, as they may fall, spilling the liquid and causing an electrical shock to the user and/or damage to this unit.
- 6 Do not cover this unit with a newspaper, tablecloth, curtain, etc. in order not to obstruct heat radiation. If the temperature inside this unit rises, it may cause fire, damage to this unit, and/or personal injury.
- 7 Do not plug in this unit to a wall outlet until all connections are complete.
- 8 Do not operate this unit upside-down. It may overheat, possibly causing damage.
- 9 Do not use excessive force on switches, knobs and/or cords.
- 10 When disconnecting the power cord from the wall outlet, grasp the plug; do not pull the cord.
- 11 Do not clean this unit with chemical solvents; this might damage the finish. Use a clean, dry cloth.
- 12 Use only the voltage specified on this unit. Using this unit with a higher voltage than specified is dangerous and may cause fire, damage to this unit, and/or personal injury. YAMAHA will not be held responsible for any damage resulting from use of this unit with a voltage other than as specified.
- 13 Do not attempt to modify or fix this unit. Contact qualified YAMAHA service personnel when any service is needed. The cabinet should never be opened for any reason.
- 14 When not planning to use this unit for long periods of time (i.e., vacation), disconnect the AC power plug from the wall outlet.
- 15 Be sure to read the “Troubleshooting” section on common operating errors before concluding that this unit is faulty.
- 16 Before moving this unit, press STANDBY/ON to set the unit in standby mode, and then disconnect the AC power plug from the wall outlet.
- 17 Install this unit near the AC wall outlet and where the AC power plug can be reached easily.

This unit is not disconnected from the AC power source as long as it is connected to the wall outlet, even if this unit itself is tuned off. This is called the standby mode. In this state, this unit is designed to consume a very small quantity of power.

FOR CANADIAN CUSTOMERS

To prevent electric shock, match wide blade of plug to wide slot and fully insert.

This Class B digital apparatus complies with Canadian ICES-003.

For Customer Use:

Read carefully the information located at the rear panel of this unit and enter below the Serial No. Retain this information for future reference.

Model No. _____

Serial No. _____

CAUTION

Use of controls or adjustments or performance of procedures other than those specified herein may result in hazardous radiation exposure.

LASER

Type	Semiconductor laser GaAlAs
Wave length	650 nm (DVD) 780 nm (VCD/CD)
Output Power	7 mW (DVD) 10 mW (VCD/CD)
Beam divergence	60 degree

WARNING

TO REDUCE THE RISK OF FIRE OR ELECTRIC SHOCK, DO NOT EXPOSE THIS UNIT TO RAIN OR MOISTURE.

Introduction

Region codes	3
Supplied accessories	3
Notes about discs/content format	3
Cleaning discs	4
Patent information	4

Functional Overview

Front panel	5
Rear panel	5
Remote control	6

Connections

General notes on connections	7
Audio connections	7
Digital connection	7
Analog connection	7
Video connections	8
Component video jacks <A>	8
S-video jack 	8
Composite video jack <C>	8
HDMI connections	9
HDMI jack	9

Getting Started

Step 1: Inserting batteries into the remote control ...	10
Using the remote control	10
Step 2: Turning on the power	11
Step 3: Setting a TV type and display	11
Setting a color system for your TV	11
Setting an aspect ratio for your TV	12
Step 4: Setting a language preference	12
Setting the OSD Language	12
Setting the audio, subtitle and disc menu languages (DVD-Video only)	13

Disc Operation

Basic playback	14
General operation	14
Pausing playback	14
Selecting track/chapter	14
Searching backward/forward	14
Stopping playback	14
Selecting the various repeat/shuffle functions ...	15
Repeat and shuffle	15
Repeating a section within a chapter/track	15
Operations for video playback (DVD/VCD/SVCD) ...	15
Using the disc menu	15
Slow motion	15
Zooming in	16
Resuming playback from the last stopped point ...	16
On-screen display (OSD)	16
Special DVD features	17
Playing by title	17
Camera angle	17
Audio	18
Subtitles	18
Special VCD/SVCD features	18
Playback control (PBC)	18
Preview function	18
Playing data discs (MP3/WMA/JPEG/DivX)	19
General operation	19
Selecting a folder and track/file	20
Repeat and shuffle	20
Special picture disc features	20
Preview function	20
Zooming pictures	20
Playback with multi-angles	21
Scan effect	21
Playing MP3 music and JPEG picture simultaneously	21
Special DivX features	21
Interactive menu	21
Multiple audio and subtitle languages	21

Contents

Setup Menu

General setup menu	22
Locking/Unlocking the disc for viewing.....	22
Dimming the front panel display.....	22
Programming disc tracks (except MP3/WMA/ JPEG/DivX).....	22
OSD language	23
Screen saver.....	23
Sleep timer.....	23
Auto standby.....	24
DivX [®] VOD registration code.....	24
Audio setup menu	24
Setting the analog output.....	24
Setting the digital output.....	25
Setting the HDMI audio.....	26
CD upsampling	26
Night mode.....	26
Lip synchronization.....	27
Video setup menu	27
TV type.....	27
Setting the TV display	27
Progressive	28
Picture setting.....	29
Selecting the black level	30
Closed caption.....	30
HDMI setup.....	30
Preference setup menu	31
Audio, subtitle and disc menu.....	32
Restricting playback with parental control	32
Playback of VR format.....	32
MP3/JPEG menu.....	34
Displaying DivX external subtitle files	34
Changing the password.....	35
PBC (Playback control).....	35
Resetting the system.....	35

Language Codes	36
-----------------------------	----

Troubleshooting	38
------------------------------	----

Glossary	40
-----------------------	----

Specifications	42
-----------------------------	----

Thank you for purchasing this unit. This Owner's Manual explains the basic operation of this unit.

Region codes

DVD discs must be labeled ALL regions or Region 1 in order to play on this unit.

You cannot play discs labeled for other regions.



Supplied accessories

- Remote control
- Two batteries (AA, R06, UM-3) for the remote control
- Audio/Video pin cable (red/white/yellow plugs)
- Owner's Manual

Notes about discs/content format

- This unit can play the disc types associated with the logos shown below. Do not attempt to load any other type of disc into this unit. Doing so may damage this unit.

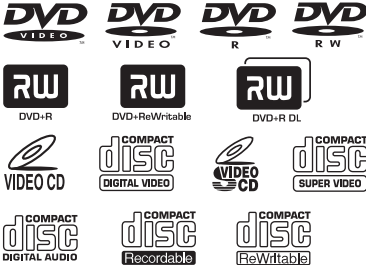

- This unit can play DVD+R/RW DL and DVD-R/RW/R DL discs recorded in DVD-Video compatible format.
- This unit can play DVD-RW discs recorded in VR format (compatible with CPRM).

- This unit can play the following data discs (For MP3 and WMA files, the parenthetic words represent the compatible sampling rate and bit rate):
 - MP3 files recorded on CD-R/RW, DVD+R/RW and DVD-R/RW (fs 32, 44.1, 48 kHz / 96 – 320 kbps (CBR only))
 - WMA (except copy protected WMA) files recorded on CD-R/RW, DVD+R/RW and DVD-R/RW (When in fs 44.1 kHz: 64 – 192 kbps (CBR only)/ When in fs 48 kHz: 128 – 192 kbps (CBR only))
 - JPEG (except Progressive JPEG) files recorded on CD-R/RW, DVD+R/RW and DVD-R/RW (compatible resolution: 3072 x 2048 or less)
 - KODAK Picture CD
 - FUJICOLOR CD
 - DivX Video files recorded on CD-R/RW, DVD+R/RW and DVD-R/RW
 - Official DivX[®] Ultra Certified product
 - Plays all versions of DivX[®] video (including DivX[®] 6) with enhanced playback of DivX[®] media files and the DivX[®] Media Format
 - ISO 9660 Level1/Level2 for CD-R/RW
 - Up to 298 folders per disc and up to 648 files per folder with up to 8 hierarchies

Notes:

- CD-R/RW, DVD+R/RW/R DL and DVD-R/RW/R DL cannot be played unless finalized.
- Only the first session of DVD+R DL and DVD-R/RW/R DL can be played.
- Some discs cannot be played depending on disc characteristics or recording conditions.
- Do not use any non-standard shaped discs (heart-shaped, etc.).
- Do not use discs with tape, seals, or paste on their surface.
- Do not use discs with many scratches on their surface.

Introduction

Cleaning discs

- When a disc becomes dirty, clean it with a cleaning cloth. Wipe the disc from the center out. Do not wipe in a circular motion.
- Do not use solvents such as benzene, thinner, commercially available cleaners, or antistatic spray intended for analog records.

Patent information



Manufactured under license from Dolby Laboratories. "Dolby", "Pro Logic" and the double-D symbol are trademarks of Dolby Laboratories.



"DTS" and "DTS Digital Out" are trademarks of Digital Theater Systems, Inc.



DivX, DivX Ultra Certified, and associated logos are trademarks of DivX, Inc. and are used under license.



HDMI, the HDMI logo and High Definition Multimedia Interface are trademarks or registered trademarks of HDMI Licensing LLC.

This product incorporates copyright protection technology that is protected by method claims of certain U.S. patents and other intellectual property rights owned by Macrovision Corporation and other rights owners. Use of this copyright protection technology must be authorized by Macrovision Corporation, and is intended for home and other limited viewing uses only unless otherwise authorized by Macrovision Corporation. Reverse engineering or disassembly is prohibited.

Front panel

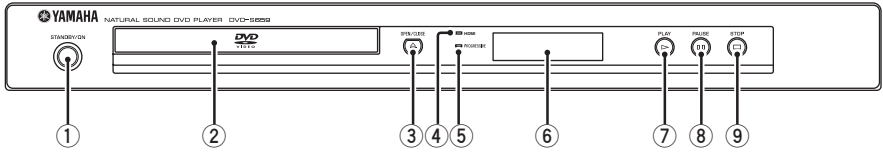

- ① **STANDBY/ON**
Turns on this unit or sets it to the standby mode.
- ② **Disc tray**
Loads a disc in the disc tray.
- ③ **OPEN/CLOSE (▲)**
Opens or closes the disc tray.
- ④ **HDMI indicator**
Lights up when an HDMI component is connected, and signals output via the HDMI jack of this unit.
- ⑤ **PROGRESSIVE indicator**
Lights up when this unit enters the progressive mode.
- ⑥ **Front panel display**
Shows the current status of this unit.
- ⑦ **PLAY (▶)**
Starts playback.
- ⑧ **PAUSE (II)**
Pauses playback.
- ⑨ **STOP (■)**
Stops playback.

Rear panel

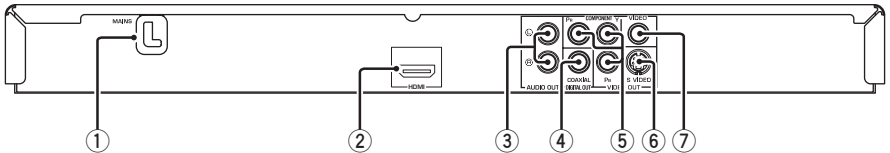

- ① **AC power cord**
Connect to a standard AC outlet.
- ② **HDMI output jack**
Connect to the HDMI input jack of your HDMI component.
- ③ **AUDIO OUT (L, R) jacks**
Connect to the audio input jacks of your AV receiver or stereo system.
- ④ **DIGITAL OUT - COAXIAL jack**
Connect to the coaxial input jack of your AV receiver.
- ⑤ **VIDEO OUT - COMPONENT (Y, PB, PR) jacks**
Connect to the component input jacks of your AV receiver.
- ⑥ **VIDEO OUT - S VIDEO jack**
Connect to the S-video input jack of your AV receiver.
- ⑦ **VIDEO OUT - VIDEO jack**
Connect to the composite video input jack of your AV receiver.

Caution: Do not touch the inner pins of the jacks on the rear panel of this unit. Electrostatic discharge may cause permanent damage to this unit.

Functional Overview

Remote control

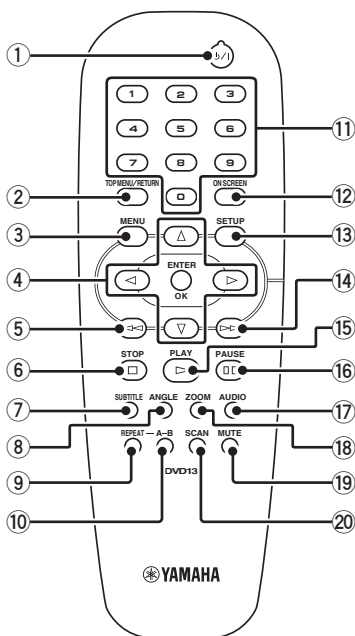

- ① **⏻/|**
Turns on this unit or sets it to the standby mode.
- ② **TOP MENU/RETURN**
Displays the top-level disc (DVD).
Moves back to the previous menu (DVD*/VCD).
- ③ **MENU**
Accesses the menu of a disc (DVD).
Switches PBC on or off (VCD).
- ④ **◀/▶/▲/▼**
Selects an item in the currently displayed menu. Search or slow playback.
ENTER/OK
Confirms the menu selection.
- ⑤ **◀◀**
Searches backward.*
Moves to the previous chapter or track.
- ⑥ **STOP (■)**
Stops playback.
Opens the disc tray.*

- ⑦ **SUBTITLE**
Selects the subtitle language.
- ⑧ **ANGLE**
Selects the DVD camera angle.
- ⑨ **REPEAT**
Repeats the chapter, track, title or disc.
Shuffles the chapter or track.
- ⑩ **A-B**
Repeats a specific segment.
- ⑪ **Numeric buttons (0-9)**
Selects numbered items in the currently displayed menu.
- ⑫ **ON SCREEN**
Accesses or exits from the on-screen display (OSD) menu of this unit.
- ⑬ **SETUP**
Accesses or exits from the setup menu of this unit.
- ⑭ **▶▶**
Searches forward.*
Moves to the next chapter or track.
- ⑮ **PLAY (▶)**
Starts playback.
- ⑯ **PAUSE (||)**
Pauses playback temporarily.
Frame-by-frame playback.
- ⑰ **AUDIO**
Selects the audio language or format.
- ⑱ **ZOOM**
Enlarges the video image.
- ⑲ **MUTE**
Mutes the audio output. Press again to restore the audio output to previous volume level.
- ⑳ **SCAN**
Previews the content of a track or whole disc (VCD).
Plays the first 6 seconds or less of each track (CD).

* Press and hold the button for about two seconds.

General notes on connections

Be sure to turn off this unit and unplug the power supply cable, before you make or change connections.

- Depending on the equipment you wish to connect, there are various ways to make connections. Possible connections are described below.
- Refer to the manuals of your other components as necessary to make the best connections.
- Do not connect this unit via your VCR. The video quality could be distorted by the copy protection system.
- Do not connect the audio out jack of this unit to the phono in jack of your audio system.

Audio connections

Digital connection

This unit has a coaxial digital out jack. Connect DIGITAL OUT - COAXIAL jack of this unit to your AV receiver equipped with Dolby Digital, DTS, or MPEG decoder using a commercially available coaxial cable.

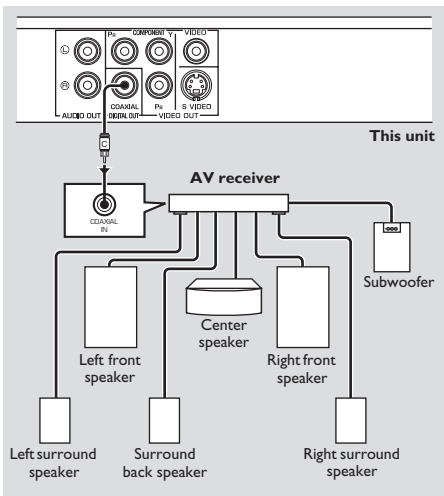

You need to set "DIGITAL OUTPUT" to "ALL" (see "DIGITAL OUTPUT" on page 25).

Notes:

- If the audio format of the digital output does not match the capabilities of your receiver, the receiver produces a distorted sound or no sound at all. Make sure to select the appropriate audio format from the menu screen on the disc. Pressing AUDIO on the remote control once or more may change not only the audio languages but also the audio format. The selected format appears in the front panel display for several seconds.
- If you wish to enjoy Dolby Digital, DTS and MPEG formats, you must connect this unit to an AV receiver that supports these formats.

Analog connection

This unit has analog output jacks. Connect AUDIO OUT (L, R) jacks of this unit to the corresponding input jacks of your audio component (such as a stereo amplifier) using the supplied audio pin cable.

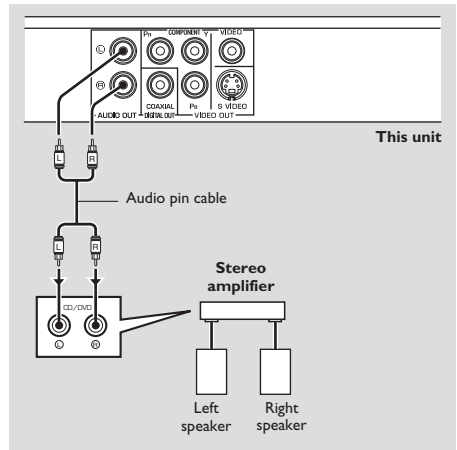

Connections

Video connections

If your AV receiver has video output jacks, connect your receiver and then your TV so that you can use one TV for several different video sources (LD, VCR, etc.) by simply switching the input source selector of your receiver.

This unit has four types of video output jacks. Use the one that corresponds to the input jacks of the component to be connected.

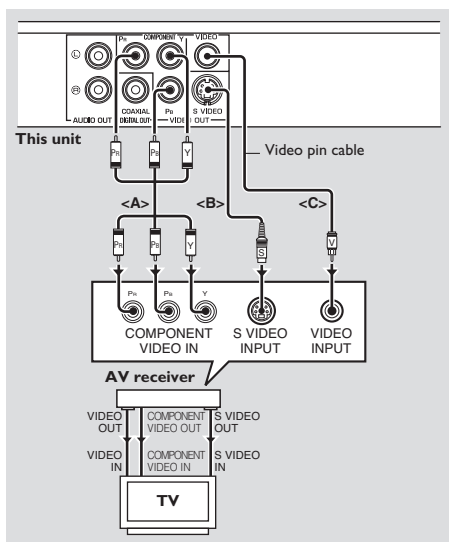

Component video jacks <A>

Component video connections achieve high fidelity color reproduction than S-video connections by transmitting video signals on separate wires for luminance (Y: green) and chrominance (PB: blue, PR: red). Connect VIDEO OUT - COMPONENT (Y, PB, PR jacks of this unit to component input jacks of your AV receiver and then to those of your TV using a commercially available component cable. Observe the color of each jack when you make connections.

If your receiver does not have component output jacks, you can achieve a better video image by connecting the component output jacks of this unit directly to the component input jacks of your TV.

S-video jack

S-video connections achieve a clearer picture than composite video connections by transmitting video signals on separate wires for luminance (Y) and chrominance (C).

Connect VIDEO OUT - S VIDEO jack of this unit to S-video input jack of your AV receiver and then to that of your TV using a commercially available S-video cable.

Composite video jack <C>

Connect VIDEO OUT - VIDEO jack of this unit to video input jack of your AV receiver and then to that of your TV using the supplied video pin cable.

HDMI connections

HDMI jack

Connect the HDMI output jack of this unit to an HDMI input jack of your TV using a commercially available HDMI cable.

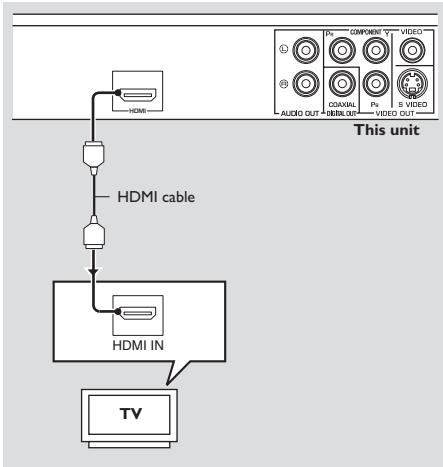

You need to set “HDMI AUDIO” (see page 26) and “HDMI VIDEO” (see page 30).

Notes:

- You need to make an appropriate audio connections if the connected component does not output audio signals (see “Audio connections” on page 7).
- This unit is not compatible with HDCP-incompatible HDMI or DVI components.
- You need a commercially available HDMI/DVI conversion cable when you connect this unit to other DVI components. In this case, the HDMI jack of this unit does not output any audio signals.
- Depending on the connected DVI component, black and white in the image may not be distinct. In that case, adjust the picture setting of the connected DVI component.
- When connecting an HDMI component, refer to the instruction manual for the component.
- Do not disconnect or turn off the power of the HDMI/DVI component connected to the HDMI jack of this unit while data is being transferred. Doing so may disrupt playback or cause noise.

Getting Started

Step 1: Inserting batteries into the remote control

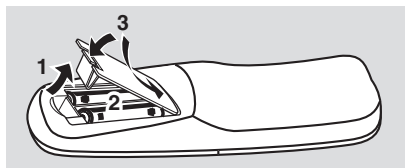

- 1 Open the battery compartment.
- 2 Insert the two supplied batteries (AA, R06, UM-3) following the indications (+/-) inside the compartment.
- 3 Close the cover.

Notes:

- Insert batteries correctly according to the polarity markings (+/-). The batteries inserted in the opposite direction may leak.
- Replace the exhausted batteries immediately with new ones to prevent a leakage.
- Remove the batteries from the compartment if the remote control is not used for more than a month.
- If the batteries have leaked, dispose of them immediately. Avoid touching the leaked material or letting it come into contact with clothing, etc. Clean the battery compartment thoroughly before installing new batteries.
- Do not use old batteries together with new ones.
- Do not use different types of batteries (such as alkaline and manganese batteries) together. Read the packaging carefully as these different types of batteries may have the same shape and color.
- Dispose of the batteries correctly in accordance with your local regulations.

Using the remote control

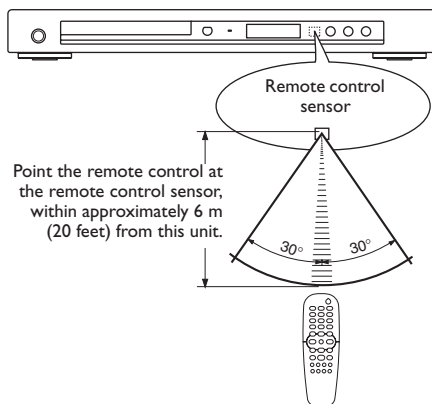

Point the remote control at the remote control sensor, within approximately 6 m (20 feet) from this unit.

Handling the remote control

- Do not spill water or other liquids on the remote control.
- Do not drop the remote control.
- Do not leave or store the remote control in the following types of conditions:
 - places of high humidity, such as near a bath
 - places of high temperature, such as near a heater or stove
 - places of extremely low temperature
 - dusty places

Step 2: Turning on the power

- 1 Connect the AC power cord to the power outlet.
- 2 Turn on your TV and AV receiver.
- 3 Select the appropriate input source of the AV receiver connected to this unit. Refer to the manual supplied with your AV receiver for details.
- 4 Turn on this unit.
- 5 Set the TV to the correct Video IN channel (e.g. EXT1, EXT2, AV1, AV2, AUDIO/VIDEO, etc. Refer to the manual supplied with your TV for details).
→ The front panel display lights up and the default screen appears on the TV.

Step 3: Setting a TV type and display**Setting a color system for your TV**

This unit is compatible with both NTSC and PAL video formats. Select the color system that matches your TV.

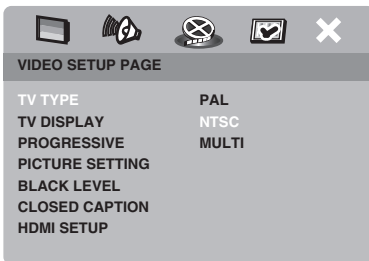

- 1 Press **SETUP**.
- 2 Press **▶** repeatedly to select "VIDEO SETUP PAGE".

- 3 Press **▲/▼** to highlight [TV TYPE], and then press **▶**.
- 4 Press **▲/▼** to highlight one of the following options.

PAL

Select this if the connected TV is a PAL system TV. It will change the video signals of NTSC discs and output them in PAL format.

NTSC

Select this if the connected TV is an NTSC system TV. It will change the video signals of PAL discs and output them in NTSC format.

MULTI

Select this if the connected TV is compatible with both NTSC and PAL formats (such as a multi-system TV). The output format will be in accordance with the video signals of the disc.

- 5 Select an item, and then press **ENTER/OK** to confirm your selection.

Notes:

- Before changing the current TV standard setting, ensure that your TV supports the selected TV type.
- If the picture is not displayed properly on your TV, wait for 15 seconds for this unit to activate automatic recovery.
- When making HDMI connections, you cannot change or select [TV TYPE].



TIPS: To return to the previous menu, press **◀**.
To exit from the menu, press **SETUP**.

Getting Started

Setting an aspect ratio for your TV

You can set the aspect ratio of this unit to match your TV. If the aspect ratio of your TV is 4:3, you do not need to change this setting. If you have a widescreen TV, change this setting according to the following procedure.

For details, see “Setting the TV display” on page 27.

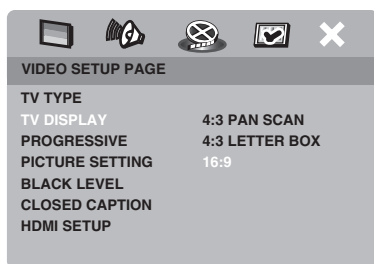

- 1 Press **SETUP**.
- 2 Press **▶** repeatedly to select “VIDEO SETUP PAGE”.
- 3 Press **▲/▼** to highlight [TV DISPLAY], and then press **▶**.
- 4 Press **▲/▼** to highlight [16:9], and then press **ENTER/OK** to confirm the selection.

Step 4: Setting a language preference

You can select your own preferred language settings. This unit automatically switches to your preferred language whenever you load a disc. If the selected language is not available on the disc, the default language of the disc will be used instead. The OSD language in the system menu remains once selected.

Setting the OSD Language

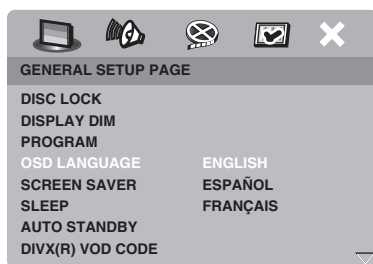

- 1 Press **SETUP**.
- 2 Press **◀/▶** to select “GENERAL SETUP PAGE”.
- 3 Press **▲/▼** to highlight [OSD LANGUAGE], and then press **▶**.
- 4 Press **▲/▼** to select a language, and then press **ENTER/OK** to confirm your selection.

TIPS: To return to the previous menu, press **◀**.
To exit from the menu, press **SETUP**.

Setting the audio, subtitle and disc menu languages (DVD-Video only)



- 1 Press **STOP** (■) twice, and then press **SETUP**.
- 2 Press ► repeatedly to select “PREFERENCE PAGE”.
- 3 Press ▲/▼ to highlight one of the options below at a time, and then press ►.
 - AUDIO (audio language)
 - SUBTITLE (subtitle language)
 - DISC MENU (disc menu language)
- 4 Press ▲/▼ to select a language, and then press **ENTER/OK** to confirm your selection.

If the language you want is not in the list, select [OTHERS], and then use the **numeric buttons (0-9)** on the remote control to enter the 4-digit language code (see “Language Codes” on page 36), and then press **ENTER/OK** to confirm the code.

- 5 Repeat steps 3–4 for other language settings.

TIPS: To return to the previous menu, press ◀.
To exit from the menu, press **SETUP**.

Disc Operation

IMPORTANT!

- If the inhibition icon (⊘) appears on the TV screen when a button is pressed, the function for that button is not available on the current disc or at the current time.
- Depending on the DVD or VIDEO CD disc, some operations may operate differently or be restricted.
- Do not push on the disc tray or put any objects other than discs on the disc tray. Doing so may cause this unit to malfunction.

Basic playback

- 1 Press **STANDBY/ON** on the front panel or \odot /I on the remote control to turn on this unit.
- 2 Press **OPEN/CLOSE** (▲) on the front panel to open the disc tray.
- 3 Place the disc in the disc tray with the printed side up.
- 4 Press **OPEN/CLOSE** (▲) again to close the disc tray.
 - After recognizing the disc, this unit begins to play back automatically.
 - If you press **PLAY** (▶) when the disc tray is open, the disc tray closes and playback starts automatically.

General operation

Unless stated otherwise, all operations described here are carried out using the supplied remote control.

Pausing playback

- 1 During playback, press **PAUSE** (II).
 - Playback is paused and the sound is muted.
- 2 Press **PAUSE** (II) again to select the next picture frame.
- 3 To resume normal playback, press **PLAY** (▶).

Selecting track/chapter

- Press |◀◀ / ▶▶| or use the **numeric buttons (0-9)** to select a track/chapter number.
- During repeated playback, press |◀◀ / ▶▶| to replay the same track/chapter.

Searching backward/forward

- 1 Press and hold |◀◀ / ▶▶| or press ◀/▶.
- 2 While searching, press |◀◀ / ▶▶| or ◀/▶ repeatedly to select the desired speed.
- 3 To resume normal playback, press **PLAY** (▶).

Notes:

- ◀/▶ key may not be available with some discs.
- For MP3 and WMA, the search function allows you to search the track currently being played.

Stopping playback

- Press **STOP** (■).

TIPS: The operating features described here might not be possible for certain discs. Always refer to the instructions supplied with the disc.

Selecting the various repeat/shuffle functions

Repeat and shuffle

- Each time you press **REPEAT** during playback, the front panel display changes as follows:

DVD

- RPT ONE (repeat chapter)
- RPT TT (repeat title)
- RPT ALL (repeat disc)
- SHUFFLE (shuffle)
- RPT SHF (shuffle repeat)
- RPT OFF (repeat off)

VCD/SVCD/CD

- RPT ONE (repeat track)
- RPT ALL (repeat disc)
- SHUFFLE (shuffle)
- RPT SHF (shuffle repeat)
- RPT OFF (repeat off)

MP3/WMA/DivX

- RPT ONE (repeat track)
- RPT FLD (repeat folder)
- SHUFFLE (shuffle)
- RPT OFF (repeat off)

Note:

- For VCD, repeat playback is not possible when the PBC mode is selected.

Repeating a section within a chapter/track

- While playing a disc, press **A-B** at the desired starting point.
- Press **A-B** again at the desired end point.
 - A and B can only be set within the same chapter/track.
 - The selected section repeats continuously.
- To exit from the sequence, press **A-B**.

Operations for video playback (DVD/VCD/SVCD)

Using the disc menu

Depending on the disc, a menu may appear on the TV screen once you load the disc.

To select a playback feature or item

- Use **◀/▶/▲/▼** or the **numeric buttons (0-9)**, and then press **ENTER/OK** to start playback.

To access or exit from the menu

- Press **MENU**.

Slow motion

You can play back in slow motion.

- Press **▲** for reverse slow motion or **▼** for forward slow motion.
- During slow motion, press **▲/▼** repeatedly to select the desired speed.
- To resume normal playback, press **PLAY (▶)**.

Note:

- Reverse slow motion is not available for VCDs and SVCDs.

TIPS: The operating features described here might not be possible for certain discs. Always refer to the instructions supplied with the disc.

Disc Operation

Zooming in

This function allows you to enlarge or lessen the picture on the TV screen and to pan through the enlarged picture.

- 1 During playback, press **ZOOM** repeatedly to display the picture at different scales.
 - Use ◀/▶/▲/▼ to pan through the enlarged picture.
 - Playback continues.
- 2 Press **ZOOM** repeatedly to return to the original size.

Resuming playback from the last stopped point

You can resume playback of the last 10 discs, even if the discs were ejected or the power of this unit was turned off.

- 1 Load one of the last 10 discs.
→ “LOADING” appears on the TV screen.
- 2 Press **PLAY** (▶) while “LOADING” is displayed on the TV screen.
→ “RESUME PLAY” appears on the TV screen and the disc is played back from the last point.

To cancel the resume mode

- When playback is stopped, press **STOP** (■) again.

On-screen display (OSD)

The OSD menu shows disc playback information (e.g., the title or chapter number, elapsed playing time or audio/subtitle language). A number of operations are possible without interrupting disc playback.

- 1 During playback, press **ON SCREEN**.
→ A list of available disc information appears on the TV screen.

DVD

MENU	
TITLE	02/14
CHAPTER	02/14
AUDIO	5.1CH
SUBTITLE	ENG
BITRATE 16 III TITLE ELAPSED 0:02:25	

VCD/SVCD

MENU	
TRACK	02/14
DISC TIME	0:49:17
TRACK TIME	0:03:43
REPEAT	OFF
BITRATE 16 III TOTAL ELAPSED 0:02:25	

- 2 Press ▲/▼ to view the information, and then press **ENTER/OK** to access the selected item.
- 3 Use the **numeric buttons (0-9)** to input the number/time or press ▲/▼ to make a selection, and then press **ENTER/OK** to confirm the selection.
→ Playback changes to the selected time or to the selected title/chapter/track.

TIPS: The operating features described here might not be possible for certain discs. Always refer to the instructions supplied with the disc.

Title/Chapter/Track selection (DVD/VCD)

- 1 Press **▲/▼** to select [TITLE] or [CHAPTER] (DVD) or [TRACK] (VCD).
- 2 Press **ENTER/OK** to confirm the selection.
- 3 Select a title, chapter or track number using the **numeric buttons (0-9)**.

Time search (DVD/VCD)

- 1 Press **▲/▼** to select [TT TIME] or [CH TIME] (DVD) or [TRACK TIME] or [DISC TIME] (VCD).
 - [TT TIME] refers to the total time of the current title, and [CH TIME] refers to the total time of the current chapter.
- 2 Press **ENTER/OK** to confirm the selection.
- 3 Enter hours, minutes and seconds from left to right using the **numeric buttons (0-9)** (e.g. 0:34:27).

Audio/Subtitle/Angle (DVD)

You can change [AUDIO], [SUBTITLE] or [ANGLE] if these functions are available on the disc you are playing.

- 1 Press **▲/▼** to select [AUDIO], [SUBTITLE] or [ANGLE].
- 2 Press **ENTER/OK** to confirm the selection.
- 3 For Audio and Subtitle:
Press **▲/▼** to highlight your selection, and then press **ENTER/OK**.

OR

For Angle:
Select an angle using the **numeric buttons (0-9)**.

Repeat/Time Display (DVD/VCD)

- 1 Press **▲/▼** to select [REPEAT] or [TIME DISP.].
- 2 Press **ENTER/OK** to confirm the selection.
- 3 Press **▲/▼** to highlight your selection, and then press **ENTER/OK**.

Time display (CD)

Each time you press **ON SCREEN**, the time display changes as follows:

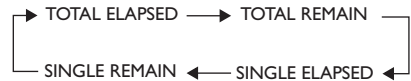

Special DVD features

Playing by title

- 1 Press **MENU**.
→ The disc title menu appears on the TV screen.
- 2 Use **◀/▶/▲/▼** or the **numeric buttons (0-9)** to select a playback option.
- 3 Press **ENTER/OK** to confirm your selection.

Camera angle

- Press **ANGLE** repeatedly to select the desired angle.

TIPS: The operating features described here might not be possible for certain discs. Always refer to the instructions supplied with the disc.

Disc Operation

Audio

Changing the audio language and/or format

- Press **AUDIO** repeatedly to select an audio language.

Subtitles

- Press **SUBTITLE** repeatedly to select a subtitle language.

Special VCD/SVCD features

Playback control (PBC)

For VCD with playback control (PBC) feature (version 2.0 only)

Press **MENU** to toggle between “PBC ON” and “PBC OFF”.

→ If you select “PBC ON”, the disc menu (if available) appears on the TV screen.

- Use **|◀◀| ▶▶|** or the **numeric buttons (0-9)** to select a playback option.
- During playback, press **TOP MENU/RETURN** to return to the menu screen.

If you want to skip the index menu and play back a disc directly from the beginning,

- Press **MENU** on the remote control to turn off PBC.

Preview function

- 1 Press **SCAN**.
→ A list appears on the TV screen.



```
SELECT DIGEST TYPE:
TRACK DIGEST
DISC INTERVAL
TRACK INTERVAL
```

- 2 Press **▲/▼** to highlight [TRACK DIGEST], [DISC INTERVAL] or [TRACK INTERVAL].

TRACK DIGEST

This function minimizes the picture for every track and displays six at a time on the screen to help you view the tracks on the disc.

DISC INTERVAL

This function is used to divide a disc into six parts at regular intervals, and display them on one page to help you preview the entire disc.

TRACK INTERVAL

This function is used to divide a single track into six parts at regular intervals, and display them on one page to help you preview the selected track.

Note:

- You can only select [TRACK INTERVAL] during playback when PBC is turned off.

TIPS: The operating features described here might not be possible for certain discs. Always refer to the instructions supplied with the disc.

3 Press **ENTER/OK**.

→ Thumbnail pictures appear on the TV screen.

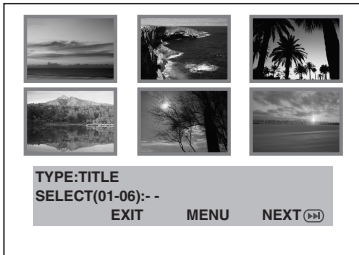

(Example of 6 thumbnails in the display)

4 Use **◀/▶/▲/▼** to select a track or use the **numeric buttons (0-9)** to input the selected track number.

5 Press **|◀◀/▶▶|** to open the previous or next page.

6 Press **ENTER/OK** to confirm the selection.

To quit the preview function

- Use **◀/▶/▲/▼** to highlight [EXIT] and press **ENTER/OK**.

To return to the preview menu

- Use **◀/▶/▲/▼** to highlight [MENU] and press **ENTER/OK**.

For CD:

- When playback is stopped, press **SCAN**.
- Each track is played for a few seconds.

Playing data discs (MP3/WMA/JPEG/DivX)

General operation

1 Load a disc.

- The disc reading time may exceed 30 seconds due to the complexity of the directory/file configuration.
- The data disc menu appears on the TV screen.

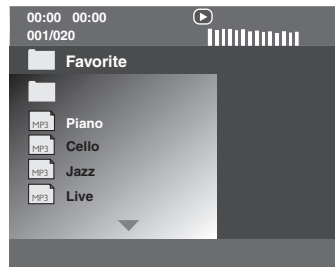

2 Playback starts automatically. If not, press **PLAY (▶)**.

During playback, you can:

- Press **|◀◀/▶▶|** to select another track/file in the current folder.
- Press **PAUSE (II)** to pause playback.

Note:

- It may not be possible to play certain MP3/WMA/JPEG/DivX discs due to the configuration and characteristics of the discs or the recording conditions.

TIPS: The operating features described here might not be possible for certain discs. Always refer to the instructions supplied with the disc.

Disc Operation

Selecting a folder and track/file

- 1 Press **▲/▼** to select a folder, and then press **ENTER/OK** to open the folder.
- 2 Press **▲/▼** to select a track/file.
- 3 Press **ENTER/OK** to confirm your selection.
→ Playback starts from the selected file to the end of the folder.

Repeat and shuffle

When the MP3 disc/WMA disc/picture disc menu is shown on the screen;

- Press **REPEAT** repeatedly to select a "Play Mode".
→ **FOLDER**: files are played back once.
→ **REPEAT ONE**: one file is played repeatedly.
→ **REPEAT FOLDER**: all files in one folder are played repeatedly.
→ **SHUFFLE**: all files in the current folder are played in random order.

Special picture disc features

- 1 Load a picture disc (JPEG, Kodak Picture CD and Fujicolor CD).
→ For JPEG discs, the picture menu appears on the TV screen.
→ For Kodak Picture CDs and Fujicolor CDs, the slideshow begins.
- 2 Press **PLAY (▶)** to start the slideshow.

Preview function

This function displays the content of the current folder or the entire disc.

- 1 Press **STOP (■)** during playback.
→ 12 thumbnail pictures appear on the TV screen.

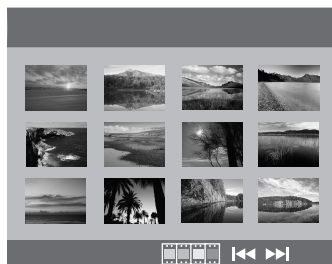

- 2 Press **◀◀/▶▶** to display the other pictures on the previous/next page.
- 3 Use **◀/▶/▲/▼** to highlight one of the pictures, and then press **ENTER/OK** to start playback.

OR

Move the cursor to highlight  on the bottom of the page to start playback from the first picture on the current page.

For JPEG discs:

- 4 Press **MENU** to return to JPEG disc menu.

Zooming pictures

- 1 During playback, press **ZOOM** repeatedly to display the picture at different scales.
- 2 Use **◀/▶/▲/▼** to view the zoomed picture.

TIPS: The operating features described here might not be possible for certain discs. Always refer to the instructions supplied with the disc.

Playback with multi-angles

- During playback, press ◀/▶/▲/▼ to rotate the picture on the TV screen.
 - ◀: rotates the picture counter-clockwise
 - ▶: rotates the picture clockwise
 - ▲: flips the picture vertically
 - ▼: flips the picture horizontally

Scan effect

- Press **ANGLE** repeatedly to choose a scan effect.
- Various scan effects appear in the top left corner of the TV screen.

Playing MP3 music and JPEG picture simultaneously

- 1 Load a disc that contains both MP3 music and JPEG picture data.

→ The disc menu appears on the TV screen.
- 2 Select an MP3 music track.
- 3 During MP3 music playback, select a JPEG picture file from the TV screen, and then press **PLAY (▶)**.

→ The picture files are played back one after another until the end of the folder.
- 4 To quit simultaneous playback, press **MENU**, and then press **STOP (■)**.

Note:

- Some files cannot be played correctly depending on disc characteristics or recording conditions.

Special DivX features

DivX files including DMF (DivX Media Format) features only

Interactive menu

- 1 Load a disc.

→ The interactive menu appears on the TV screen.
- 2 Use ◀/▶/▲/▼ to select a chapter.
- 3 Press **ENTER/OK** or **PLAY (▶)** to start playback of the selected chapter.

To access the interactive menu

- During playback, press **MENU**.

To return to the data disc menu screen

- When the interactive menu is displayed, press **STOP (■)**.

Multiple audio and subtitle languages

To select an audio language

- During playback, press **AUDIO** to switch the audio language recorded on the contents.

To select a subtitle language

- During playback, press **SUBTITLE** to switch or turn on/off the subtitle language recorded on the contents.

Note:

- For information about external subtitle files, see “Displaying DivX external subtitle files” on page 34.

TIPS: The operating features described here might not be possible for certain discs. Always refer to the instructions supplied with the disc.

Setup Menu

Setup is carried out on the TV screen, enabling you to customize this unit to suit your own particular requirements.

General setup menu

- 1 Press **SETUP**
- 2 Press **◀/▶** to select "GENERAL SETUP PAGE".
- 3 Press **ENTER/OK** to confirm your selection.

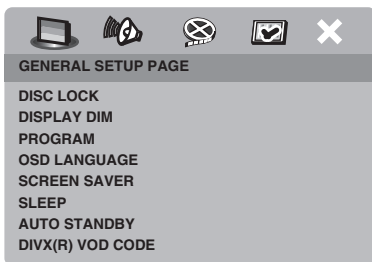

Locking/Unlocking the disc for viewing

Not all discs are rated or coded by the manufacturer of the disc. You can prevent playback of a specific disc by locking the disc. You can lock up to 40 discs on this unit.

- 1 In "GENERAL SETUP PAGE", press **▲/▼** to highlight [DISC LOCK], and then press **▶**.

LOCK

Select this to lock playback of the current disc. Subsequent access to a locked disc requires six-digit password.

The default password is "000 000" (see "Changing the password" on page 35).

UNLOCK

Select this to unlock the disc and allow future playback.

- 2 Press **▲/▼** to select a setting, and then press **ENTER/OK** to confirm your selection.

Dimming the front panel display

You can select different levels of brightness for the front panel display.

- 1 In "GENERAL SETUP PAGE", press **▲/▼** to highlight [DISPLAY DIM], and then press **▶**.

100%

Select this for full brightness.

70%

Select this for medium brightness.

40%

Select this for dimming display.

- 2 Press **▲/▼** to select a setting, and then press **ENTER/OK** to confirm your selection.

Programming disc tracks (except MP3/WMA/JPEG/DivX)

You can play back the contents of a disc in the desired order by programming the tracks to be played. You can store up to 20 tracks per disc with a maximum of 10 discs.

- 1 In "GENERAL SETUP PAGE", press **▲/▼** to highlight [PROGRAM], and then press **▶** to select [INPUT MENU].

- 2 Press **ENTER/OK** to confirm your selection.

→ The input menu appears on the TV screen.

TIPS: To return to the previous menu, press **◀**.
To exit from the menu, press **SETUP**.

PROGRAM: TRACK (01-17)

To input your favorite tracks/chapters

- Use the **numeric buttons (0-9)** to enter a valid track/chapter number.
 - Use **◀/▶/▲/▼** to move the cursor to the next position.
 - If the track/chapter number is more than ten, press **▶▶** to move to the next page, and then proceed with programming.
- OR
- Use **◀/▶/▲/▼** to highlight [NEXT] on the program menu, and then press **ENTER/OK**.
 - Repeat steps 3–4 to input another track/chapter number.

To remove a track

- Use **◀/▶/▲/▼** to move the cursor to the track you want to remove.
- Press **ENTER/OK** to remove this track from the program menu.

To start program playback

- Use **◀/▶/▲/▼** to highlight [START] on the program menu, and then press **ENTER/OK**.
→ Playback starts for the selected tracks in the programmed sequence.

To exit from program playback

- Use **◀/▶/▲/▼** to highlight [EXIT] on the program menu, and then press **ENTER/OK**.

OSD language

This menu contains various options for the on-screen display (OSD) language. For details, see “Setting the OSD Language” on page 12.

Screen saver

This function is used to turn on or off the screen saver.

- In “GENERAL SETUP PAGE”, press **▲/▼** to highlight [SCREEN SAVER], and then press **▶**.

ON

Select this if you wish to turn off the TV screen when disc playback is stopped or paused for more than 15 minutes.

OFF

Select this to disable the screen saver function.

- Press **▲/▼** to select a setting, and then press **ENTER/OK** to confirm your selection.

Sleep timer

This feature automatically sets this unit to the standby mode after a certain elapsed period.

- In “GENERAL SETUP PAGE”, press **▲/▼** to highlight [SLEEP], and then press **▶**.
- Press **▲/▼** to select a setting.
 - You can select from 30, 60, 90, 120 and 150 minutes. Select [OFF] to cancel the sleep timer function.
- Press **ENTER/OK** to confirm your selection.

TIPS: To return to the previous menu, press **◀**.
To exit from the menu, press **SETUP**.

Setup Menu

Auto standby

This function is used to turn the auto standby mode on or off when disc playback is stopped for more than 30 minutes.

- 1 In "GENERAL SETUP PAGE", press ▲/▼ to highlight [AUTO STANDBY], and then press ►.

ON

Select this if you wish to set this unit to the standby mode automatically when disc playback is stopped or paused for more than 30 minutes.

OFF

Select this to disable the auto standby function.

- 2 Press ▲/▼ to select a setting, and then press **ENTER/OK** to confirm your selection.

DivX® VOD registration code

Yamaha provides you with a DivX® VOD (Video On Demand) registration code that allows you to rent and purchase videos using the DivX® VOD service.

For more information, visit at www.divx.com/vod.

- 1 In "GENERAL SETUP PAGE", press ▲/▼ to highlight [DIVX(R) VOD CODE], and then press ►.
→ The registration code appears.

- 2 Press **ENTER/OK** to exit.
- 3 Use the registration code to purchase or rent the videos from DivX® VOD service at www.divx.com/vod. Follow the instructions and download the video onto a CD-R for playback on this unit.

Notes:

- All the downloaded videos from DivX® VOD can only be played back on this unit.
- Time search feature is not available during DivX movie playback.

Audio setup menu

- 1 Press **SETUP**.
- 2 Press ◀/▶ to select "AUDIO SETUP PAGE".
- 3 Press **ENTER/OK** to confirm your selection.

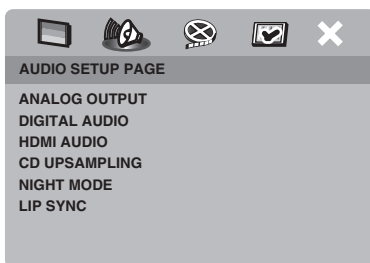

Setting the analog output

Set the analog output to match the playback capability of this unit.

- 1 In "AUDIO SETUP PAGE", press ▲/▼ to highlight [ANALOG OUTPUT], and then press ►.

STEREO

Select this to change channel output to stereo, which only delivers sound from the two front speakers.

LT/RT

Select this if this unit is connected to a Dolby Pro Logic decoder.

TIPS: To return to the previous menu, press ◀.
To exit from the menu, press **SETUP**.

VIRTUAL SURR

Select this to virtually reproduce the surround channels.

- 2 Press ▲/▼ to select a setting, and then press **ENTER/OK** to confirm your selection.

Setting the digital output

The [DIGITAL AUDIO] options are: "DIGITAL OUTPUT" and "LPCM OUTPUT".

- 1 In "AUDIO SETUP PAGE", press ▲/▼ to highlight [DIGITAL AUDIO], and then press ►.
- 2 Press ▲/▼ to highlight an option.
- 3 Press ► to enter a submenu.

DIGITAL OUTPUT

Set the digital output according to your optional audio component connections.

OFF

Select this to turn off the digital output.

ALL

Select this if you have connected the digital audio output jack to a multi-channel decoder/receiver.

PCM ONLY

Select this only if your receiver is not capable of decoding multi-channel audio signals.

LPCM OUTPUT

Select this if you have connected this unit to a PCM-compatible receiver via a digital terminal, such as the coaxial terminal. In this case, you may need to adjust "LPCM OUTPUT".

Discs are recorded at a certain sampling rate. The higher the sampling rate, the better the sound quality.

48KHz

Select this to play back discs recorded at the sampling rate of 48 kHz. All 96 kHz PCM data streams (if available) are converted to the sampling rate of 48 kHz.

96KHz

Select this to play back discs recorded at the sampling rate of 96 kHz. If the 96 kHz disc is copy protected, the digital output is automatically converted to the sampling rate of 48 kHz.

- 4 Press ▲/▼ to select a setting, and then press **ENTER/OK** to confirm your selection.

TIPS: To return to the previous menu, press ◀.
To exit from the menu, press **SETUP**.

Setup Menu

Setting the HDMI audio

When you connect this unit to an HDMI compatible component via the HDMI jack, select to turn on or off the HDMI audio output.

- 1 In 'AUDIO SETUP PAGE', press ▲▼ to highlight [HDMI AUDIO], then press ►.

ON

Select this to turn on the HDMI audio output.

OFF

Select this to turn off the HDMI audio output.

Notes:

- If you are not using the HDMI audio output, you should set this to [OFF].
- If the monitor/receiver connected to this unit using HDMI does not support HDMI audio signal input, set this to [OFF].
- This unit can output following audio signals using HDMI: 32/44.1/48 kHz, 2ch linear PCM signals and bitstream signals (Dolby Digital, DTS and MPEG).
- When audio signals are being output by HDMI-compatible components, digital output signals are muted.
- When [DIGITAL OUTPUT] is set to [OFF] on this unit, HDMI audio is muted even if [HDMI AUDIO] is set to [ON] and an HDMI connection is established between the monitor and receiver.
- When [DIGITAL OUTPUT] is set to [ALL] on this unit, PCM signals are still output if the monitor and receiver only support the PCM format. However, the audio output is muted when audio format plays back the DTS source.

CD upsampling

This feature allows you to convert your music CD to a higher sampling rate using sophisticated digital signal processing for better sound quality. If you activate the upsampling function, this unit automatically switches to the stereo mode.

- 1 In "AUDIO SETUP PAGE", press ▲/▼ to highlight [CD UPSAMPLING], and then press ►.

OFF

Select this to disable CD-upsampling.

88.2kHz (X2)

Select this to convert the sampling rate of CDs to twice that of the original.

176.4kHz (X4)

Select this to convert the sampling rate of CDs to four times that of the original.

- 2 Press ▲/▼ to select a setting, and then press **ENTER/OK** to confirm your selection.

Note:

- This setting is only valid for the signals output at the analog jacks.

Night mode

In the night mode, high volume output is softened and low volume output is brought upward to an audible level. It is useful when you watch your favorite action movie without disturbing others at night.

- 1 In "AUDIO SETUP PAGE", press ▲/▼ to highlight [NIGHT MODE], and then press ►.

TIPS: To return to the previous menu, press ◀.
To exit from the menu, press **SETUP**.

ON

Select this to level out the volume. This feature is only available for movies with the Dolby Digital mode.

OFF

Select this when you want to enjoy the full dynamic range of surround sound.

- 2 Press ▲/▼ to select a setting, and then press **ENTER/OK** to confirm your selection.

Lip synchronization

This feature allows you to delay the sound output in order to synchronize it with the video image. This may be necessary when you use certain LCD monitors or projectors.

- 1 In “AUDIO SETUP PAGE”, press ◀/▶ to highlight [LIP SYNC], and then press ▶.
- 2 Press ◀/▶ to adjust the delay time (between 00 ms and 200 ms), and then press **ENTER/OK** to confirm your selection.

Video setup menu

- 1 Press **SETUP**.
- 2 Press ◀/▶ to select “VIDEO SETUP PAGE”.
- 3 Press **ENTER/OK** to confirm your selection.

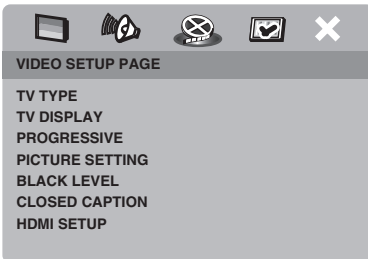

TV type

This menu contains the options for selecting the color system that matches your TV. For details, see “Step 3: Setting a TV type and display” on page 11.

Setting the TV display

Set the aspect ratio of this unit to match your TV. The format you select must be available on the disc. Otherwise, the TV display setting will not affect the picture during playback.

- 1 In “VIDEO SETUP PAGE”, press ▲/▼ to highlight [TV DISPLAY], and then press ▶.
- 2 Press ▲/▼ to highlight one of the following options.

4:3 PAN SCAN

Select this if the aspect ratio of your TV is 4:3 and you want both sides of the picture to be trimmed or formatted to fit your TV screen.

4:3 LETTER BOX

Select this if the aspect ratio of your TV is 4:3. In this case, a wide picture with black bands on the upper and lower portions of the TV screen are displayed.

16:9

Select this if you have a widescreen TV.





TIPS: To return to the previous menu, press ◀.
To exit from the menu, press **SETUP**.

Setup Menu



- 3 Select an item, and then press **ENTER/OK** to confirm your selection.

The relationship between the setting of this unit and the TV display

When the aspect ratio of your TV is 4:3:

Setting	Playback disc	TV display	
4:3 PAN SCAN	16:9		*1
	4:3		
4:3 LETTER BOX	16:9		
	4:3		

When the aspect ratio of your TV is 16:9 (widescreen):

Setting	Playback disc	TV display	
16:9	16:9		
	4:3		*2

*1: If the disc is not assigned to playback with panscan, it is played with letterbox.

*2: The side of the picture may be stretched depending on the TV. In this case, check the screen size and aspect ratio of your TV.

Progressive

This feature is only valid if you have connected this unit to a progressive scan TV through the component video jacks (see “Component video jacks <A>” on page 8).

- 1 In “VIDEO SETUP PAGE”, press ▲/▼ to highlight [PROGRESSIVE], and then press ►.

OFF

Select this to disable the progressive scan function.

ON

Select this to enable the progressive scan function.

- 2 Press ▲/▼ to select a setting, and then press **ENTER/OK** to confirm your selection.

Notes on activating progressive scan:

- Ensure that your TV is equipped with progressive scan.
- Connect using a component video cable.
- When making HDMI connections, you cannot select [PROGRESSIVE].

CONSUMERS SHOULD NOTE THAT NOT ALL HIGH DEFINITION TELEVISION SETS ARE FULLY COMPATIBLE WITH THIS PRODUCT AND MAY CAUSE ARTIFACTS TO BE DISPLAYED IN THE PICTURE. IN CASE OF 525 OR 625 PROGRESSIVE SCAN PICTURE PROBLEMS, IT IS RECOMMENDED THAT THE USER SWITCH THE CONNECTION TO THE “STANDARD DEFINITION” OUTPUT. IF THERE ARE QUESTIONS REGARDING OUR VIDEO MONITOR COMPATIBILITY WITH THIS MODEL 525P AND 625P DVD PLAYER, PLEASE CONTACT OUR CUSTOMER SERVICE CENTER.

This unit is compatible with the complete line of YAMAHA products, including the projectors DPX-1300, DPX-830 and the plasma monitor PDM-4220.

TIPS: To return to the previous menu, press ◀.
To clear the menu, press **SETUP**.

Picture setting

This unit comes with three predefined sets of picture color settings and one personal setting that you can define yourself.

- 1 In "VIDEO SETUP PAGE", press ▲/▼ to highlight [PICTURE SETTING], and then press ►.

STANDARD

Select this for the standard picture setting.

BRIGHT

Select this to make the TV picture brighter.

SOFT

Select this to make the TV picture softer.

PERSONAL

Select this to personalize your picture color by adjusting the brightness, contrast, tint and color (saturation).

- 2 Press ▲/▼ to select a setting, and then press **ENTER/OK** to confirm your selection.
- 3 If you select [PERSONAL] in step 1, proceed to steps 4–7.
→ The "PERSONAL PICTURE SETUP" menu appears.

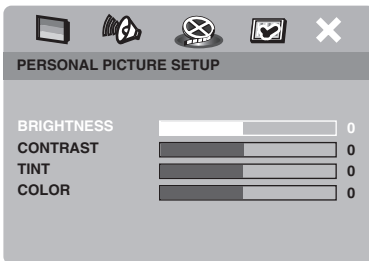

- 4 Press ▲/▼ to select one of the following options.

BRIGHTNESS

Increase the value to brighten the picture or vice versa. Zero (0) is the average brightness setting value.

CONTRAST

Increase the value to sharpen the picture or vice versa. Zero (0) is the average contrast setting value.

TINT

Increase the value to darken the picture or vice versa. Zero (0) is the average tint setting value.

COLOR

Increase the value to enhance the color in your picture or vice versa. Zero (0) is the average color setting value.

- 5 Press ◀/▶ to adjust the setting that best suits your personal preference.
- 6 Repeat steps 4–5 to adjust other color features.
- 7 Press **ENTER/OK** to confirm your selection.

Notes:

- All picture settings are not available for HDMI output.

TIPS: To return to the previous menu, press ◀.
To exit from the menu, press **SETUP**.

Setup Menu

Selecting the black level

If you set the TV type to NTSC, set the black level shift to ON to improve the color contrast during playback. The black level setting has no effect if the TV type is set to PAL.

- 1 In "VIDEO SETUP PAGE", press ▲/▼ to highlight [BLACK LEVEL], and then press ►.

ON

Select this to enhance the black level.

OFF

Select this for standard black level setting.

- 2 Press ▲/▼ to select a setting, and then press **ENTER/OK** to confirm your selection.

Closed caption

Closed captions are data hidden in the video signals of specific discs and are invisible without the use of a special decoder. The difference between subtitles and captions is that subtitles are intended for hearing persons and captions are for the hearing impaired. Subtitles rarely show all of the audio. For example, captions show sound effects (e.g., "phone ringing" and "footsteps"), while subtitles do not. Before you select this function, please ensure that the disc contains closed caption information and your TV set also supports this function.

- 1 In "VIDEO SETUP PAGE", press ▲/▼ to highlight [CLOSED CAPTION], and then press ►.

ON

Select this to enable the closed caption function.

OFF

Select this to disable the closed caption function.

- 2 Press ▲/▼ to select a setting, and then press **ENTER/OK** to confirm your selection.

HDMI setup

When you connect this unit to an HDMI compatible component via the HDMI jack, select the following video output settings depending on the connected component.

WIDE SCREEN FORMAT

Set the aspect ratio of the projected images on the screen. This feature is only available for HDMI video output.

SUPERWIDE

Select to display 4:3 image on the 16:9 screen with non-linear stretching (Center position of screen is stretched less than the side). This feature is not available when the resolution is 480p or 570p.

4:3 PILLAR BOX

Select to display 4:3 image on the 16:9 screen without stretching.

OFF

No aspect ratio adjustment is made when this option is selected.

TIPS: To return to the previous menu, press ◀.
To exit from the menu, press **SETUP**.

HDMI VIDEO

Enables you to adjust the resolution depending on the monitor you are using.

Note:

- For settings other than [AUTO], HDMI video output may not be display properly if a resolution output setting is not supported by the HDMI-compatible monitor you are using. In that case, follow the steps below to return to the initial setting:

1 Press **OPEN/CLOSE ▲** to open the disc tray.

2 Press **◀**.

3 Press **ANGLE**.

Do not perform this operation while playing back a disc on this unit.

480P

480 progressive-scan video

576P

576 progressive-scan video

720P

720 progressive-scan video

1080I

1080 interlace video

AUTO

The resolution is automatically selected to match the monitor you are using.

Notes:

- You cannot set [TV TYPE] when making HDMI connections.
- When disconnecting the HDMI cable, the setting of [TV TYPE] may be changed. If Component video, S-video and Composite video output does not display correctly, see “Troubleshooting” on page 38 to set the correct TV type again.

Preference setup menu

- 1 Press **STOP (■)** twice to stop playback (if necessary), and then press **SETUP**.
- 2 Press **◀/▶** to select “PREFERENCE PAGE”.
- 3 Press **ENTER/OK** to confirm your selection.

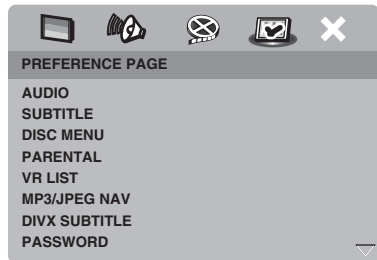

TIPS: To return to the previous menu, press **◀**.
To exit from the menu, press **SETUP**.

Setup Menu

Audio, subtitle and disc menu

These menus contain various language options for the audio, subtitles and disc menus recorded on the DVD-Video. For details, see “Setting the audio, subtitle and disc menu languages (DVD-Video only)” on page 13.

Restricting playback with parental control

Some DVDs may have a parental level assigned to the complete disc or to certain scenes on the disc. This feature lets you set a playback limitation level.

The rating levels are from 1 to 8 and are country dependent. You can prohibit playback of certain discs that are not suitable for your children or play certain discs in alternative scenes.

- 1 In “PREFERENCE PAGE”, press ▲/▼ to highlight [PARENTAL], and then press ►.

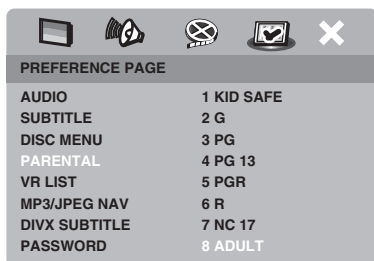

- 2 Press ▲/▼ to highlight a rating level for the inserted disc, and then press **ENTER/OK**.
 - To disable parental controls and have all discs play, select [8 ADULT].
- 3 Use the **numeric buttons (0-9)** to enter the six-digit password (see “Changing the password” on page 35).
 - DVDs that are rated above the level you selected do not play unless you enter your six-digit password.

Note:

- Some DVDs are not encoded with a rating though the movie rating may be printed on the disc cover. The rating level feature does not work for such discs.

Playback of VR format

There are two ways to play back a disc in VR (Video Recording) format: ORIGINAL and PLAY LIST. This feature is not available with non-VR format discs.

- 1 In “PREFERENCE PAGE”, press ▲/▼ to highlight [VR LIST], and then press ►.

ORIGINAL LIST

Select this to play the originally recorded titles on the disc.

PLAY LIST

Select this to play the edited version of the disc. This feature is only available when a play list has been created.

- 2 Press ▲/▼ to highlight a setting, and then press **ENTER/OK** to confirm your selection.

TIPS: To return to the previous menu, press ◀.
To exit from the menu, press **SETUP**.

To play back a disc in VR format

- 3 Press **SETUP** to close the setup menu.
- 4 Press **PLAY** (▶) to begin to play back the setting you selected.

Previewing VR format

- 5 During playback, press **SCAN**.
→ A list appears on the TV screen.

SELECT DIGEST TYPE:
TITLE DIGEST
TITLE INTERVAL

- 6 Press ▲/▼ to highlight either [TITLE DIGEST] or [TITLE INTERVAL].

TITLE DIGEST

This function displays thumbnail pictures of titles on the screen. Up to six thumbnail pictures per page are displayed.

- In ORIGINAL LIST mode, the originally recorded titles on the disc are displayed.
- In PLAY LIST mode, every title in the play list is displayed.

TITLE INTERVAL

This function is used to divide and display the contents of each title being played back in regular intervals, making it easy to preview the recording. Up to six thumbnail pictures per page are displayed.

- If the title being played back is short, the TITLE DIGEST function is performed instead.

- 7 Press **ENTER/OK** to confirm the selection.

→ Thumbnail pictures appear on the TV screen.

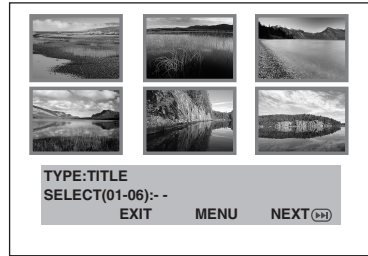

(Example of 6 thumbnails in the display)

- 8 Use ◀/▶/▲/▼ to select a title or use the **numeric buttons (0-9)** to input the title number.
 - Press |◀◀ / ▶▶| to access the previous/next page.
- 9 Press **ENTER/OK** to confirm the selection.

To quit the preview function

- Use ◀/▶/▲/▼ to highlight [EXIT] and press **ENTER/OK**.

To return to the preview menu

- Use ◀/▶/▲/▼ to highlight [MENU] and press **ENTER/OK**.

TIPS: To return to the previous menu, press ◀.
To exit from the menu, press **SETUP**.

Setup Menu

MP3/JPEG menu

MP3/JPEG Navigator can be set only if the disc was recorded with a menu. It allows you to select different display menus for easy navigation.

- 1 In “PREFERENCE PAGE”, press ▲/▼ to highlight [MP3/JPEG NAV], and then press ►.

WITHOUT MENU

Select this to display all the files contained in the MP3/Picture CD.

WITH MENU

Select this to display only the folder menu of the MP3/Picture CD.

- 2 Press ▲/▼ to select a setting, and then press **ENTER/OK** to confirm your selection.

Displaying DivX external subtitle files

The font sets listed below are available for DivX external subtitle files. This setting allows you to see the proper font set on-screen to match the subtitle file.

- 1 In “PREFERENCE PAGE”, press ▲/▼ to highlight [DIVX SUBTITLE], and then press ►.
- 2 Press ▲/▼ to highlight one of the following language groups.

GROUP1:

Albanian (sq), Basque (eu), Catalan (ca), Danish (da), Dutch (nl), English (en), Faroese (fo), Finnish (fi), French (fr), German (de), Icelandic (is), Irish (ga), Italian (it), Norwegian (no), Portuguese (pt), Rhaeto-Romanic (rm), Scottish (gd), Spanish (es), Swedish (sv)

GROUP2:

Albanian (sq), Croatian (hr), Czech (cs), Hungarian (hu), Polish (pl), Romanian (ro), Slovak (sk), Slovenian (sl)

GROUP3:

Bulgarian (bg), Byelorussian (be), Macedonian (mk), Russian (ru), Serbian (sr), Ukrainian (uk)

GROUP4:

Hebrew (iw), Yiddish (ji)

GROUP5:

Turkish (tr)

- 3 Select a group, and then press **ENTER/OK** to confirm your selection.

Notes:

- Some discs cannot be played depending on disc characteristics or recording conditions.
- Some external subtitle files may be displayed incorrectly or not at all.
- For external subtitle files, the following subtitle format filename extensions are supported (note that these files are not shown within the disc navigation menu):
.srt, .sub, .ssa, .smi
- The filename of the movie file has to be repeated at the beginning of the filename for the external subtitle file.
- The number of external subtitle files which can be switched for the same movie file is limited to a maximum of 10.

TIPS: To return to the previous menu, press ◀.
To exit from the menu, press **SETUP**.

Changing the password

The same password is used for both parental control and disc lock. Enter your six-digit password when prompted on the screen. The default password is 000 000.

- 1 In "PREFERENCE PAGE", press ▲/▼ to highlight [PASSWORD], and then press ► to select [CHANGE].

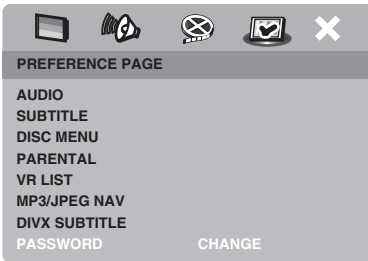

- 2 Press **ENTER/OK** to enter the "Password Change Page".

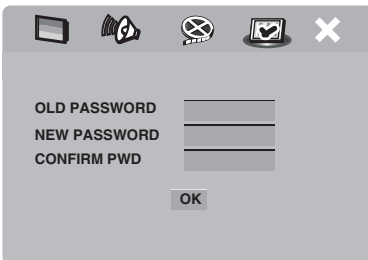

- 3 Use the **numeric buttons (0-9)** to enter your old six-digit password.
 - When doing this for the first time, enter "000 000".
 - If you forget your old six-digit password, enter "000 000".

- 4 Enter the new six-digit password.
- 5 Enter the new six-digit password again to confirm the password.
- 6 Press **ENTER/OK** to confirm your new password.
 - The new six-digit password is now valid.

PBC (Playback control)

You can turn on or off PBC. This feature is available only on Video CD 2.0 with the playback control (PBC) feature. For details, see "Playback control (PBC)" on page 18.

Resetting the system

Setting the DEFAULT function resets all options and your personal settings to the initial factory settings, except your password for PARENTAL and DISC LOCK.

- 1 In "PREFERENCE PAGE", press ▲/▼ to highlight [DEFAULT], and then press ► to select [RESET].
- 2 Press **ENTER/OK** to confirm your selection.
 - All settings are reset to the initial factory settings.

TIPS: To return to the previous menu, press ◀.
To exit from the menu, press **SETUP**.

Language Codes

These codes can be used to select other languages. This does not affect the options in “AUDIO”, “SUBTITLE” or “DISC MENU”.

Abkhazian	6566	German	6869
Afar	6565	Gikuyu; Kikuyu	7573
Afrikaans	6570	Greek,	6976
Albanian	8381	Guarani	7178
Amharic	6577	Gujarati	7185
Arabic	6582	Hausa	7265
Armenian	7289	Hebrew	7269
Assamese	6583	Herero	7290
Avestan	6569	Hindi	7273
Aymara	6589	Hiri Motu	7279
Azerbaijani	6590	Hungarian	7285
Bashkir	6665	Icelandic	7383
Basque	6985	Ido	7379
Belarusian	6669	Indonesian	7368
Bengali	6678	Interlingua (International)	7365
Bihari	6672	Interlingue	7369
Bislama	6673	Inuktitut	7385
Bokmål, Norwegian	7866	Inupiaq	7375
Bosnian	6683	Irish	7165
Breton	6682	Italian	7384
Bulgarian	6671	Japanese	7465
Burmese	7789	Javanese	7486
Castilian, Spanish	6983	Kalaallisut	7576
Catalan	6765	Kannada	7578
Chamorro	6772	Kashmiri	7583
Chechen	6769	Kazakh	7575
Chewa; Chichewa; Nyanja	7889	Khmer	7577
Chichewa; Chewa; Nyanja	7889	Kikuyu; Gikuyu	7573
Chinese	9072	Kinyarwanda	8287
Chuang; Zhuang	9065	Kirghiz	7589
Church Slav; Slavonic;	6785	Komi	7586
Church Slavonic; Church	6785	Korean	7579
Chuvash	6786	Kuanyama; Kwanyama	7574
Cornish	7587	Kurdish	7585
Corsican	6779	Kwanyama; Kuanyama	7574
Croatian	7282	Lao	7679
Czech	6783	Latin	7665
Danish	6865	Latvian	7686
Dutch	7876	Letzeburgesch;	7666
Dzongkha	6890	Limburgan; Limburger;	7673
English	6978	Limburger; Limburgan;	7673
Esperanto	6979	Limburgish; Limburger;	7673
Estonian	6984	Lingala	7678
Faroese	7079	Lithuanian	7684
Fijian	7074	Luxembourgish;	7666
Finnish	7073	Macedonian	7775
French	7082	Malagasy	7771
Frisian	7089	Malay	7783
Gaelic; Scottish Gaelic	7168	Malayalam	7776
Gallegan	7176	Maltese	7784
Georgian	7565	Manx	7186

These codes can be used to select other languages. This does not affect the options in “AUDIO”, “SUBTITLE” or “DISC MENU”.

Maori	7773	Sotho, Southern	8384
Marathi	7782	South Ndebele	7882
Marshallese	7772	Spanish; Castilian	6983
Moldavian	7779	Sundanese	8385
Mongolian	7778	Swahili	8387
Nauru	7865	Swati	8383
Navaho, Navajo	7886	Swedish	8386
Navajo; Navaho	7886	Tagalog	8476
Ndebele, North	7868	Tahitian	8489
Ndebele, South	7882	Tajik	8471
Ndonga	7871	Tamil	8465
Nepali	7869	Tatar	8484
Northern Sami	8369	Telugu	8469
North Ndebele	7868	Thai	8472
Norwegian	7879	Tibetan	6679
Norwegian Bokmål; Bokmål,	7866	Tigrinya	8473
Norwegian Nynorsk;	7878	Tonga (Tonga Islands)	8479
Nyanja; Chichewa; Chewa	7889	Tsonga	8483
Nynorsk, Norwegian;	7878	Tswana	8478
Occitan (post 1500); Proven	7967	Turkish	8482
Old Bulgarian; Old Slavonic;	6785	Turkmen	8475
Old Church Slavonic; Old	6785	Twi	8487
Old Slavonic; Church	6785	Uighur	8571
Oriya	7982	Ukrainian	8575
Oromo	7977	Urdu	8582
Ossetian; Ossetic	7983	Uzbek	8590
Ossetic; Ossetian	7983	Vietnamese	8673
Pali	8073	Volapük	8679
Panjabi	8065	Walloon	8765
Persian	7065	Welsh	6789
Polish	8076	Wolof	8779
Portuguese	8084	Xhosa	8872
Provençal; Occitan (post)	7967	Yiddish	8973
Pushto	8083	Yoruba	8979
Quechua	8185	Zhuang; Chuang	9065
Raeto-Romance	8277	Zulu	9085
Romanian	8279		
Rundi	8278		
Russian	8285		
Samoan	8377		
Sango	8371		
Sanskrit	8365		
Sardinian	8367		
Scottish Gaelic; Gaelic	7168		
Serbian	8382		
Shona	8378		
Sindhi	8368		
Sinhalese	8373		
Slovak	8375		
Slovenian	8376		
Somali	8379		

Troubleshooting

Refer to the chart below when this unit does not function properly. If the problem you are experiencing is not listed below or if the instruction below does not help, set this unit to the standby mode, disconnect the power cord, and contact the nearest authorized YAMAHA dealer or service center.

Problem	Solution
No power	<ul style="list-style-type: none"> – Connect the AC power cord properly. – Press STANDBY/ON on the front panel to turn on the power.
No picture	<ul style="list-style-type: none"> – Refer to the manual supplied with your TV for correct Video In channel selection. Change the TV channel until you see the DVD screen. – Turn on your TV. – Check the video connection.
No picture is displayed when you make HDMI connections (using the HDMI jacks)	<ul style="list-style-type: none"> – Follow the steps below to change the [HDMI VIDEO] to [AUTO]; 1. Press OPEN/CLOSE (▲) on the front panel or press and hold STOP (■) on the remote control to open the disc tray. 2. Press ◀ on the remote control. 3. Press ANGLE on the remote control.
No picture is displayed when you do not use progressive scan connections (using the component video jacks)	<ul style="list-style-type: none"> – Follow the steps below to turn off the progressive scan; 1. Press OPEN/CLOSE (▲) on the front panel or press and hold STOP (■) on the remote control to open the disc tray. 2. Press ◀ on the remote control. 3. Press MUTE on the remote control to deactivate progressive scan. This unit is set to Component/Interlaced video.
Completely distorted picture or black/white picture or no picture	<ul style="list-style-type: none"> – Check that the disc is compatible with this unit (see “Notes about discs/content format” on page 3). – Check that the TV Type of this unit is set to match that of the disc and your TV (see “Setting a color system for your TV” on page 11). Follow the steps below to change the setting of [TV TYPE]. 1. Press OPEN/CLOSE (▲) on the front panel or press and hold STOP (■) on the remote control to open the disc tray. 2. Press ▶ on the remote control. 3. Press AUDIO on the remote control.
Distorted picture	<ul style="list-style-type: none"> – Occasionally, a small amount of picture distortion may appear depending on the disc being played back. This is not a malfunction.
The screen size looks unnatural, or the caption is displayed only partially on the TV monitor or is not displayed at all	<ul style="list-style-type: none"> – Check that the TV setting of this unit matches the screen size of your TV (see “Setting the TV display” on page 27). – Change the screen size and the aspect ratio of your TV.
No sound or distorted sound	<ul style="list-style-type: none"> – Adjust the volume. – Check that the speakers are connected correctly. – For MP3/WMA files, check that the sampling rate and bit rate are compatible with this unit (see “Notes about discs/content format” on page 3).

Problem	Solution
No audio at digital output	<ul style="list-style-type: none"> – Check the digital connections. – If you are playing a DTS source, check that your receiver can decode DTS and "DIGITAL OUTPUT" is set to "ALL" (see page 25). – If you are playing an MPEG-2 source, check that your receiver can decode MPEG-2. Otherwise, make sure "DIGITAL OUTPUT" is set to "PCM ONLY" (see page 25). – Check that the audio format of the selected audio language matches your receiver capabilities.
Disc does not play	<ul style="list-style-type: none"> – The CD-R/RW, DVD+R/RW/R DL and DVD-R/RW/R DL must be finalized. – Check that the disc label is facing up. – Check that the disc is defective by trying another disc. – If you have recorded a JPEG, MP3 or WMA disc yourself, check that your disc contains at least 10 JPEG picture files or 5 MP3/WMA music tracks. – For MP3/WMA files, check that the sampling rate and bit rate are compatible. For JPEG files, check that the resolution is compatible (see "Notes about discs/content format" on page 3). – Check the region code (see "Region codes" on page 3).
Picture freezes momentarily during playback	<ul style="list-style-type: none"> – Check the disc for fingerprints/scratches and clean it with a soft cloth wiping from center to edge.
This unit does not respond to the remote control	<ul style="list-style-type: none"> – Aim the remote control directly at the remote control sensor on the front panel. – Reduce the distance of the remote control from this unit. – Replace the batteries in the remote control. – Reinsert the batteries with their polarities (+/– signs) as indicated.
Buttons do not work	<ul style="list-style-type: none"> – To completely reset this unit, unplug the AC cord from the AC outlet for 5-10 seconds.
This unit does not respond to some operating commands during playback	<ul style="list-style-type: none"> – Operations may not be permitted by the disc. Refer to the instructions of the disc jacket.
This unit cannot read CDs/DVDs	<ul style="list-style-type: none"> – Use a commonly available CD/DVD lens cleaner to clean the lens before sending this unit for repair.
Menu items cannot be selected	<ul style="list-style-type: none"> – Press STOP (■) twice on the remote control before selecting Setup Menu. – Depending on the disc availability, some menu items cannot be selected.
No sound during DivX movies playback	<ul style="list-style-type: none"> – The audio code may not be supported by this unit.

Glossary

Analog: Sound that has not been turned into numbers. Analog sound varies, while digital sound has specific numerical values. These jacks send audio through two channels, the left and right.

Aspect ratio: The ratio of vertical and horizontal sizes of a displayed image. The horizontal vs. vertical ratio of conventional TVs is 4:3, and that of widescreens is 16:9.

Audio output jacks: Jacks on the back of the DVD System that send audio to another system (TV, Stereo, etc.).

Bit rate: The amount of data used to hold a given length of music; measured in kilobits per seconds, or kbps. Or, the speed at which you record. Generally, the higher the bit rate, or the higher the recording speed, the better the sound quality. However, higher bit rates use more space on a Disc.

Chapter: Sections of a picture or a music piece on a DVD that are smaller than titles. A title is composed of several chapters. Each chapter is assigned a chapter number enabling you to locate the chapter you want.

Component video output jacks: Jacks on the back of the DVD System that send high-quality video to a TV that has Component Video In jacks (R/G/B, Y/Pb/Pr, etc.).

Disc menu: A screen display prepared for allowing selection of images, sounds, subtitles, multi-angles, etc. recorded on a DVD.

Digital: Sound that has been converted into numerical values. Digital sound is available when you use the digital audio output jacks. These jacks send audio through multiple channels, instead of just two channels as analog does.

DivX: DivX is a popular media technology created by DivX, Inc. DivX media files contain highly compressed video with high visual quality that maintains a relatively small file size. DivX files can also include advanced media features like menus, subtitles, and alternate audio tracks. Many DivX media files are available for download online, and you can create your own using your personal content and easy-to-use tools from DivX.com.

DivX Ultra: DivX Ultra Certified products provide enhanced playback of advanced media features supported by the DivX Media Format. Key features include interactive video menus, subtitles, alternate audio tracks, video tags and chapter points.

DMF (DivX Media Format): The DivX Media Format supports advanced media features, adding controls for an interactive media experience: interactive video menus, chapter points, multi-language subtitles and alternate audio tracks.

Dolby Digital: A surround sound system developed by Dolby Laboratories containing up to six channels of digital audio (front left and right, surround left and right, center and subwoofer).

DTS: Digital Theatre Systems. This is a surround sound system, but it is different from Dolby Digital. The formats were developed by different companies.

HDMI: HDMI (High-Definition Multimedia Interface) is the first industry-supported, uncompressed, all-digital A/V (audio/video) interface. Providing an interface between any A/V source (such as a set-top box or A/V receiver) and an audio/video monitor (such as a digital television - DTV), HDMI supports standard, enhanced or high-definition video as well as multi-channel digital audio using a single cable. HDMI transmits all ATSC HDTV standards and supports 8-channel digital audio, with bandwidth to spare to accommodate future enhancements and requirements.

When used in combination with HDCP (High-bandwidth Digital Content Protection), HDMI provides a secure audio/video interface that meets the security requirements of content providers and system operations. For further information on HDMI, visit the HDMI website at "www.hdmi.org/"

HDCP: HDCP (High-bandwidth Digital Content Protection) developed by Intel corporation, is a method to encrypt digital video and audio data for purpose of content protection. For further information on HDCP, visit the HDCP website at “www.digital-cp.com”.

Interactive menu: Interactive video menus offer unprecedented convenience and control so you can quickly navigate between various scenes or bonus features, and select from audio track and subtitle options.

JPEG: A very common digital still picture format. A still-picture data compression system proposed by the Joint Photographic Expert Group, which features small decrease in image quality in spite of its high compression ratio.

MP3: A file format with a sound data compression system. “MP3” is the abbreviation of Motion Picture Experts Group 1 (or MPEG-1) Audio Layer 3. By using MP3 format, one CD-R or CD-RW can contain about 10 times as much data volume as a regular CD can.

Parental control: A function of the DVD to limit playback of the disc by the age of the users according to the limitation level in each country. The limitation varies from disc to disc; when it is activated, playback will be prohibited if the software's level is higher than the user-set level.

PCM (Pulse Code Modulation): A system for converting analog sound signal to digital signal for later processing, with no data compression used in conversion.

Playback control (PBC): Refers to the signal recorded on video CDs or SVCDs for controlling reproduction. By using menu screens recorded on a Video CD or SVCD that supports PBC, you can enjoy interactive-type software as well as software having a search function.

Play list: A list of selected titles to be played back in a specific order. This option is only available with VR format and must be created beforehand.

Progressive scan: It displays all the horizontal lines of a picture at one time, as a signal frame. This system can convert the interlaced video from DVD into progressive format for connection to a progressive display. It dramatically increases the vertical resolution.

Region code: A system for allowing discs to be played back only in the region designated beforehand. This unit will only play discs that have compatible region codes. You can find the region code of your unit by looking on the product label. Some discs are compatible with more than one region (or ALL regions).

S-video: Produces a clear picture by sending separate signals for the luminance and the color. You can use S-video only if your TV has S-video input jack.

Surround: A system for creating realistic three dimensional sound fields full of realism by arranging multiple speakers around the listener.

Title: The longest section of a picture or music feature on DVD, music, etc., in video software, or the entire album in audio software. Each title is assigned a title number enabling you to locate the title you want.

Video output jack: Jack on the back of the DVD System that sends video to a TV.

VR (Video Recording) format: A format which enables you to create a DVD disc that can be extensively re-edited.

Specifications

PLAYBACK SYSTEM

DVD Video
Video CD & SVCD
CD
PICTURE CD
CD-R, CD-RW
DVD+R, DVD+RW, DVD+R DL
DVD-R, DVD-RW, DVD-R DL

VIDEO PERFORMANCE

Video (CVBS) Output 1 Vpp into 75 ohm
S-Video output Y: 1 Vpp into 75 ohm
C: 0.3 Vpp into 75 ohm
Component video output Y: 1 Vpp into 75 ohm
Pb Pr: 0.7 Vpp into 75 ohm

AUDIO FORMAT

Digital Dolby Digital/DTS/MPEG
Compressed Digital
PCM 16, 20, 24 bits
fs, 44.1, 48, 96 kHz
MP3 (ISO 9660) 96, 128, 256, 320 kbps
fs, 32, 44.1, 48 kHz
WMA 64 kbps–192 kbps
fs, 44.1, 48 kHz
Analog Sound Stereo

AUDIO PERFORMANCE

DA Converter 24 bit
Signal-Noise (1 kHz) 105 dB
Dynamic range (1 kHz) 97 dB
DVD fs 96 kHz 2 Hz-44 kHz
fs 48 kHz 2 Hz-22 kHz
SVCD fs 48 kHz 2 Hz-22 kHz
fs 44.1 kHz 2 Hz-20 kHz
CD/VCD fs 44.1 kHz 2 Hz-20 kHz
Distortion and Noise (1 kHz) 0.0035%

TV STANDARD (PAL/50 Hz) (NTSC/60 Hz)

Number of lines 625 525
Playback Multistandard (PAL/NTSC)

CONNECTIONS

HDMI TYPE A x 1
Y Output Cinch (green)
Pb Output Cinch (blue)
Pr Output Cinch (red)
S-Video Output Mini DIN, 4 pins
Video Output Cinch
Audio Output (L+R) Cinch
Digital Output 1 coaxial
IEC60958 for CDDA/LPCM
IEC61937 for MPEG 1/2, Dolby
Digital and DTS

CABINET

Dimensions (w x d x h) 435 x 310 x 51 mm
Weight Approx. 2.6 Kg

POWER SUPPLY

Power inlet 120 V, 60 Hz
Power usage Approx. 14 W
Power usage standby < 1 W

Specifications are subject to change without prior notice.



©2006 YAMAHA CORPORATION All rights reserved.

YAMAHA ELECTRONICS CORPORATION, USA 6660 ORANGETHORPE AVE., BUENA PARK, CALIF. 90620, U.S.A.

YAMAHA CANADA MUSIC LTD. 135 MILNER AVE., SCARBOROUGH, ONTARIO M1S 3R1, CANADA

YAMAHA ELECTRONIK EUROPA G.m.b.H. SIEMENSSTR. 22-34, 25462 RELINGEN BEI HAMBURG, GERMANY

YAMAHA ELECTRONIQUE FRANCE S.A. RUE AMBROISE CROIZAT BP70 CROISSY-BEAUBOURG 77312 MARNE-LA-VALLEE CEDEX02, FRANCE

YAMAHA ELECTRONICS (UK) LTD. YAMAHA HOUSE, 200 RICKMANSWORTH ROAD WATFORD, HERTS WD18 7GQ, ENGLAND

YAMAHA SCANDINAVIA A.B. J.A. WETTERGRENS GATA 1, BOX 30053, 400 43 VASTRA FROLINDA, SWEDEN

YAMAHA MUSIC AUSTRALIA PTY, LTD. 17-33 MARKET ST., SOUTH MELBOURNE, 3205 VIC., AUSTRALIA

YAMAHA CORPORATION

Printed in China  3139 245 22231