



YSP-3000

Digital Sound Projector™

OWNER'S MANUAL

IMPORTANT SAFETY INSTRUCTIONS

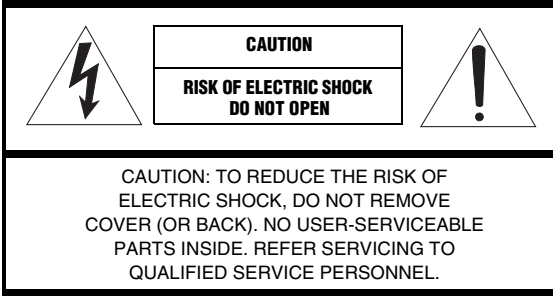

■ Explanation of Graphical Symbols



The lightning flash with arrowhead symbol, within an equilateral triangle, is intended to alert you to the presence of uninsulated “dangerous voltage” within the product’s enclosure that may be of sufficient magnitude to constitute a risk of electric shock to persons.



The exclamation point within an equilateral triangle is intended to alert you to the presence of important operating and maintenance (servicing) instructions in the literature accompanying the appliance.

- 1 Read these instructions.
- 2 Keep these instructions.
- 3 Heed all warnings.
- 4 Follow all instructions.
- 5 Do not use this apparatus near water.
- 6 Clean only with dry cloth.
- 7 Do not block any ventilation openings. Install in accordance with the manufacturer’s instructions.
- 8 Do not install near any heat sources such as radiators, heat registers, stoves, or other apparatus (including amplifiers) that produce heat.
- 9 Do not defeat the safety purpose of the polarized or grounding-type plug. A polarized plug has two blades with one wider than the other. A grounding type plug has two blades and a third grounding prong. The wide blade or the third prong are provided for your safety. If the provided plug does not fit into your outlet, consult an electrician for replacement of the obsolete outlet.
- 10 Protect the power cord from being walked on or pinched particularly at plugs, convenience receptacles, and the point where they exit from the apparatus.
- 11 Only use attachments/accessories specified by the manufacturer.
- 12 Use only with the cart, stand, tripod, bracket, or table specified by the manufacturer, or sold with the apparatus. When a cart is used, use caution when moving the cart/apparatus combination to avoid injury from tip-over.
- 13 Unplug this apparatus during lightning storms or when unused for long periods of time.
- 14 Refer all servicing to qualified service personnel. Servicing is required when the apparatus has been damaged in any way, such as power supply cable or plug is damaged, liquid has been spilled or objects have fallen into the apparatus, the apparatus has been exposed to rain or moisture, does not operate normally, or has been dropped.



FCC INFORMATION (for US customers)

1. IMPORTANT NOTICE: DO NOT MODIFY THIS UNIT!

This product, when installed as indicated in the instructions contained in this manual, meets FCC requirements. Modifications not expressly approved by Yamaha may void your authority, granted by the FCC, to use the product.

2. IMPORTANT:

When connecting this product to accessories and/or another product use only high quality shielded cables. Cable/s supplied with this product **MUST** be used. Follow all installation instructions. Failure to follow instructions could void your FCC authorization to use this product in the USA.

3. NOTE:

This product has been tested and found to comply with the requirements listed in FCC Regulations, Part 15 for Class “B” digital devices. Compliance with these requirements provides a reasonable level of assurance that your use of this product in a residential environment will not result in harmful interference with other electronic devices.

This equipment generates/uses radio frequencies and, if not installed and used according to the instructions found in the users manual, may cause interference harmful to the operation of other electronic devices.

Compliance with FCC regulations does not guarantee that interference will not occur in all installations. If this product is found to be the source of interference, which can be determined by turning the unit “OFF” and “ON”, please try to eliminate the problem by using one of the following measures:

Relocate either this product or the device that is being affected by the interference.

Utilize power outlets that are on different branch (circuit breaker or fuse) circuits or install AC line filter/s.

In the case of radio or TV interference, relocate/reorient the antenna. If the antenna lead-in is 300 ohm ribbon lead, change the lead-in to coaxial type cable.

If these corrective measures do not produce satisfactory results, please contact the local retailer authorized to distribute this type of product. If you can not locate the appropriate retailer, please contact Yamaha Electronics Corp., U.S.A. 6660 Orangethorpe Ave, Buena Park, CA 90620.

The above statements apply **ONLY** to those products distributed by Yamaha Corporation of America or its subsidiaries.

We Want You Listening For A Lifetime

Yamaha and the Electronic Industries Association’s Consumer Electronics Group want you to get the most out of your equipment by playing it at a safe level. One that lets the sound come through loud and clear without annoying blaring or distortion – and, most importantly, without affecting your sensitive hearing.

Since hearing damage from loud sounds is often undetectable until it is too late, Yamaha and the Electronic Industries Association’s Consumer Electronics Group recommend you to avoid prolonged exposure from excessive volume levels.



Caution: Read this before operating this unit.

- 1 To assure the finest performance, please read this manual carefully. Keep it in a safe place for future reference.
- 2 Install this sound system in a well ventilated, cool, dry, clean place with at least 5 cm (2 in) of space above (or below) this unit – away from direct sunlight, heat sources, vibration, dust, moisture, and/or cold.
- 3 Locate this unit away from other electrical appliances, motors, or transformers to avoid humming sounds.
- 4 Do not expose this unit to sudden temperature changes from cold to hot, and do not locate this unit in an environment with high humidity (i.e. a room with a humidifier) to prevent condensation inside this unit, which may cause an electrical shock, fire, damage to this unit, and/or personal injury.
- 5 Avoid installing this unit where foreign object may fall onto this unit and/or this unit may be exposed to liquid dripping or splashing. On the top of this unit, do not place:
 - Other components, as they may cause damage and/or discoloration on the surface of this unit.
 - Burning objects (i.e. candles), as they may cause fire, damage to this unit, and/or personal injury.
 - Containers with liquid in them, as they may fall and liquid may cause electrical shock to the user and/or damage to this unit.
- 6 Do not cover this unit with a newspaper, tablecloth, curtain, etc. in order not to obstruct heat radiation. If the temperature inside this unit rises, it may cause fire, damage to this unit, and/or personal injury.
- 7 Do not plug in this unit to a wall outlet until all connections are complete.
- 8 Do not operate this unit upside-down. It may overheat, possibly causing damage.
- 9 Do not use force on switches, knobs and/or cords.
- 10 When disconnecting the power supply cable from the wall outlet, grasp the plug; do not pull the cable.
- 11 Do not clean this unit with chemical solvents; this might damage the finish. Use a clean, dry cloth.
- 12 Only voltage specified on this unit must be used. Using this unit with a higher voltage than specified is dangerous and may cause fire, damage to this unit, and/or personal injury. Yamaha will not be held responsible for any damage resulting from use of this unit with a voltage other than specified.
- 13 To prevent damage by lightning, keep the power supply cable disconnected from a wall outlet or this unit during a lightning storm.
- 14 Do not attempt to modify or fix this unit. Contact qualified Yamaha service personnel when any service is needed. The cabinet should never be opened for any reasons.
- 15 When not planning to use this unit for long periods of time (i.e. vacation), disconnect the power supply cable from the wall outlet.
- 16 Be sure to read the “Troubleshooting” section on common operating errors before concluding that this unit is faulty.
- 17 Before moving this unit, press STANDBY/ON to set this unit in standby mode, and disconnect the power supply cable from the wall outlet.
- 18 Condensation will form when the surrounding temperature changes suddenly. Disconnect the power supply cable from the outlet, then leave the unit alone.
- 19 When using the unit for a long time, the unit may become warm. Turn the power off, then leave the unit alone for cooling.
- 20 Install this unit near the AC outlet and where the AC power plug can be reached easily.

- 21 The batteries shall not be exposed to excessive heat such as sunshine, fire or the like.

WARNING

TO REDUCE THE RISK OF FIRE OR ELECTRIC SHOCK, DO NOT EXPOSE THIS UNIT TO RAIN OR MOISTURE.

WARNING

THE POWER SUPPLY CABLE OF THIS UNIT MUST BE CONNECTED TO THE MAIN SOCKET OUTLET VIA A PROTECTIVE EARTHING CONNECTION.

This unit is not disconnected from the AC power source as long as it is connected to the AC wall outlet, even if this unit itself is turned off by STANDBY/ON. This state is called the standby mode. In this state, this unit is designed to consume a very small quantity of power.

IMPORTANT

Please record the serial number of this unit in the space below.

MODEL:

Serial No.:

The serial number is located on the rear of the unit. Retain this Owner's Manual in a safe place for future reference.

FOR CANADIAN CUSTOMERS

To prevent electric shock, match wide blade of plug to wide slot and fully insert.

This Class B digital apparatus complies with Canadian ICES-003.

FOR U.K. CUSTOMERS

If the socket outlets in the home are not suitable for the plug supplied with this appliance, it should be cut off and an appropriate 3 pin plug fitted. For details, refer to the instructions described below. Note that the plug severed from the mains lead must be destroyed, as a plug with bared flexible cord is hazardous if engaged in a live socket outlet.

IMPORTANT

THE WIRES IN MAINS LEAD ARE COLOURED IN ACCORDANCE WITH THE FOLLOWING CODE:

Blue: NEUTRAL

Brown: LIVE

As the colours of the wires in the mains lead of this apparatus may not correspond with the coloured markings identifying the terminals in your plug, proceed as follows:

The wire which is coloured BLUE must be connected to the terminal which is marked with the letter N or coloured BLACK.

The wire which is coloured BROWN must be connected to the terminal which is marked with the letter L or coloured RED. Make sure that neither core is connected to the earth terminal of the three pin plug.

CAUTION

Danger of explosion if battery is incorrectly replaced. Replace only with the same or equivalent type.

CAUTION

Use of controls or adjustments or performance of procedures other than those specified herein may result in hazardous radiation exposure.

Contents

INTRODUCTION

Overview	2
Features	3
Using this manual	5
Supplied accessories	6
Controls and functions	7
Front panel	7
Front panel display	8
Rear panel	9
Remote control (Europe, Australia, Asia, and Korea models)	10
Remote control (U.S.A. and Canada models)	13

PREPARATION

Installation	16
Before installing this unit	16
Installing this unit	16
Connections	19
Before connecting components	20
Connections using HDMI cables	21
Connecting a TV	22
Connecting a DVD player/recorder	23
Connecting a digital satellite tuner or a cable TV tuner	24
Connecting a digital airwave tuner	25
Connecting a portable audio player	26
Connecting other external components	27
Connecting a subwoofer	28
Connecting the FM antenna	29
About the IR IN terminal (U.S.A. and Canada models only)	29
Connecting the AC power supply cable	29

SETUP

Getting started	30
Installing batteries in the remote control	30
Operation range of the remote control	30
Turning on this unit or setting it to the standby mode	31
Using SET MENU	32
Displaying the OSD (on-screen display)	32
The flow chart of SET MENU	33
Changing OSD language	34
AUTO SETUP (IntelliBeam)	35
The flow chart of AUTO SETUP	35
Installing the IntelliBeam microphone	36
Using AUTO SETUP (IntelliBeam)	37
Using the system memory	42
Convenient usage of the system memory	42
Saving settings	42
Loading settings	43

BASIC OPERATION

Playback	45
Selecting the input source	45
Playing back sources	46
Adjusting the volume	47
FM tuning	48
FM controls and functions	48
Automatic tuning	49

Manual tuning	49
Automatic preset tuning	50
Manual preset tuning	51
Selecting a preset station	52
Displaying the Radio Data System information (Europe model only)	52
Enjoying surround sound	54
5 Beam	54
Stereo plus 3 Beam	55
3 Beam	55
My Surround	55
Enjoying 2-channel sources in surround sound	57
Enjoying TV in surround sound	58
Adjusting surround mode parameters	59
Enjoying stereo sound	60
2-channel stereo playback	60
5-channel stereo playback	60
Playing back sound clearly (My Beam)	61
Using auto-adjust function	61
Using manual-adjust function	62
Using sound field programs	63
CINEMA DSP programs	64
Using the music enhancer	66
Using the volume mode (Night listening enhancer/TV volume equal mode)	67
Using the sleep timer	68
Displaying the input source information	70
Using the HDMI control feature	71

ADVANCED OPERATION

MANUAL SETUP	72
Using MANUAL SETUP	73
BEAM MENU	74
SOUND MENU	78
INPUT MENU	80
DISPLAY MENU	83
Adjusting the audio balance	84
Using the test tone	84
Using the audio output being played back	85
Selecting the input mode	87
Adjusting the system parameters	88
Using the system parameters	88
Setting the MEMORY PROTECT	89
Setting the MAX VOLUME	90
Setting the TURN ON VOLUME	90
Setting the DEMO MODE	91
Setting the PANEL INPUT KEY	92
Disabling the front panel keys	93
Setting the FACTORY PRESET	94
Remote control features	96
Setting remote control codes	96
Controlling other components	97
Using the TV macro	100

ADDITIONAL INFORMATION

Troubleshooting	102
Glossary	105
Index	107
Specifications	108

List of remote control codes	i
---	---

Overview

It is generally accepted that in order to fully enjoy the benefits of surround sound at home, you must endure the agony of wiring and installing a great number of speakers in the hope that your listening room will give you the same kind of surround sound experience as your local movie theater.

Yamaha YSP-3000 Digital Sound Projector challenges this preconception that complicated speaker setup and troublesome wiring go hand-in-hand with the enjoyment of multi-channel surround sound.

This slimline unit does away with the need for complicated wiring and installation worries, leaving you with a unit that is not only easy to set up, but is also capable of reproducing the kind of powerful surround sound you have been waiting for from its built-in 2 woofers and 21 full-range small speakers.

You can fine-tune the parameters of this unit to adjust the delay time for separate sound beams, resulting in highly directional sound that comes in on the listening position from all directions.

The YSP-3000 projects sound beams containing surround sound information for the front right (R), front left (L), surround right (SR), and surround left (SL) speaker positions, which are reflected off the walls of your listening room before reaching the actual listening position. With the addition of center (C) sound beams, this Digital Sound Projector creates true-to-life 5.1-channel surround sound that makes you feel as if there are actual speakers around the room.

Sit back and enjoy the real sound experience of this simple, yet stylish Digital Sound Projector.

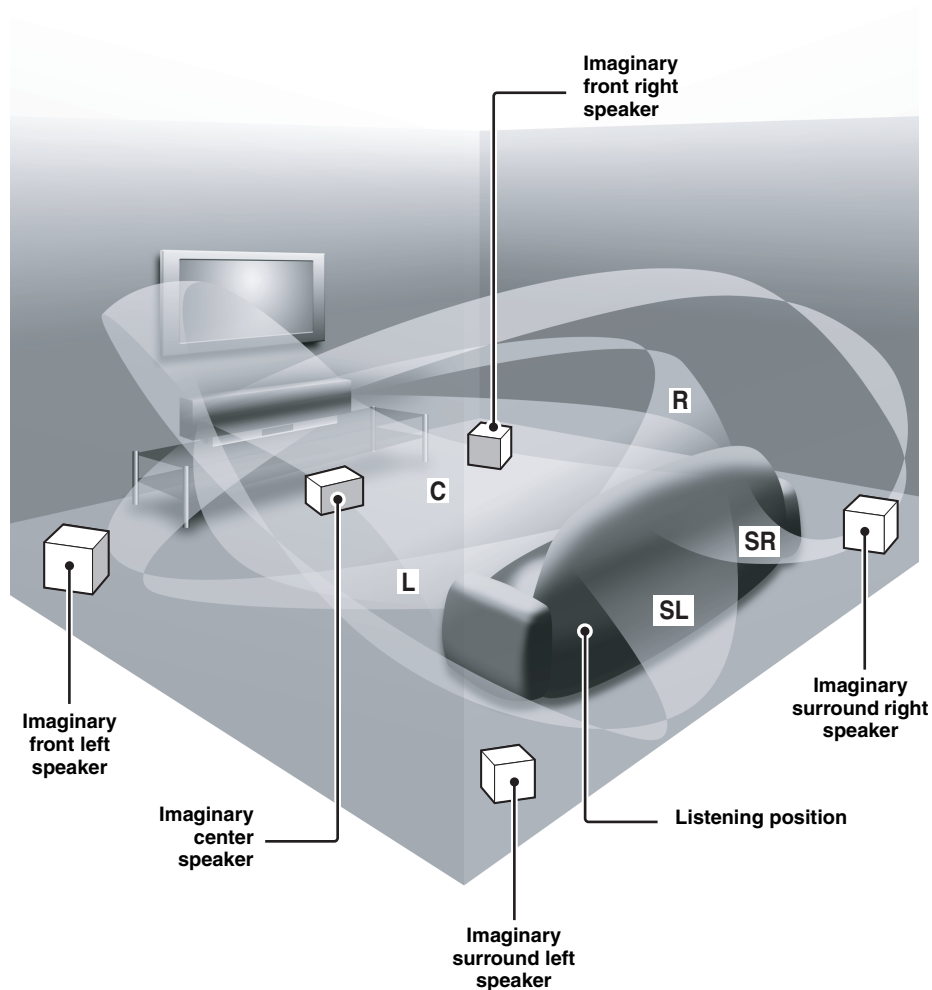

Features

Digital Sound Projector™

The Digital Sound Projector technology allows one slim unit to control and steer multiple channels of sound to generate multi-channel surround sound, thus eliminates the need for satellite loudspeakers and cabling normally associated with conventional surround sound systems. This unit also employs the beam modes that let you enjoy the surround sound (5 Beam, Stereo plus 3 Beam, 3 Beam, and My Surround), 2-channel and 5-channel stereo playback, and My Beam.

My Surround

In addition to the above mentioned beam modes, this unit is equipped with My Surround beam mode that allows you to enjoy surround system even in a small listening area.

My Beam

This unit employs My Beam that ensures a clear sound in a noisy environment. You can adjust the beam angle manually or automatically using the supplied remote control to the maximum of 45°, rightward and leftward.

Cinema DSP

This unit employs the Cinema DSP technology developed by Yamaha Electronics Corp. that lets you experience movies at home with all the original dramatic sound impact.

HDMI™ (High-Definition Multimedia Interface)

- ◆ HDMI interface for standard, enhanced, or high-definition video (including 1080p video signal transmission) as well as multi-channel digital audio based on HDCP
- ◆ Simple and easy connections with HDMI supported external components
- ◆ Functional link with an HDMI control-compatible TV

Versatile Remote Control

The supplied remote control comes with preset remote control codes used to control the DVD player, VCR, cable TV tuner, and digital satellite tuner connected to this unit. In addition, the remote control is equipped with the macro capability that enables a series of operations with the press of a single button.

AUTO SETUP (IntelliBeam)

This unit employs the automatic sound beam and acoustic optimization technology with the aid of the supplied IntelliBeam microphone. You can avoid troublesome listening-based speaker setup and achieve highly accurate sound beam adjustments that best match your listening environment.

Compatibility with the Newest Technologies

This unit employs decoders compatible with Dolby Digital, DTS, Dolby Pro Logic, Dolby Pro Logic II, DTS Neo:6, Music Enhancer, and Neural Surround.

- ◆ **Dolby Digital**
This is the standard audio signal format used on various digital media such as DVD, Blu-Ray, and HD DVD. This surround technology delivers high-quality digital audio for up to 5.1 discrete channels to produce a directional and more realistic effect.
- ◆ **DTS**
This is the standard audio signal format used on various digital media such as DVD, Blu-Ray, and HD DVD. This surround technology delivers high-quality digital audio for up to 5.1 discrete channels to produce a directional and more realistic effect.
- ◆ **Dolby Pro Logic**
This sophisticated, matrix decoding technology up-converts any 2-channel source audio to a 5.1-channel full bandwidth playback, resulting in a surround sound experience.
- ◆ **Dolby Pro Logic II**
This is a redesigned version of Dolby Pro Logic that employs 2 stereo surround channels, a subwoofer, and a greatly enhanced steering logic. This improved technology provides an exceptionally stable sound field that simulates 5.1 to a much greater degree than the original Dolby Pro Logic.
- ◆ **DTS Neo:6**
This technology decodes the conventional 2-channel sources for 6-channel playback, enabling playback with the full-range channels with higher separation. Music mode and Cinema mode are available to play back music and movie sources respectively.
- ◆ **Music Enhancer** to restore the original depth and width of compression artifacts such as the MP3 format.
- ◆ **Neural Surround decoder** (U.S.A and Canada models only)

Sophisticated FM tuner

- ◆ 40-station random and direct preset tuning
- ◆ Automatic preset tuning
- ◆ Radio Data System capability (Europe model only)

XM™ Satellite Radio

(U.S.A. and Canada models only)

- ◆ XM Satellite Radio tuning capability (using the XM Mini-Tuner Dock, and Antenna sold separately by XM Satellite Radio)
- ◆ Neural Surround decoder to play back the XM HD content of XM Satellite Radio broadcasts in multi-channels, resulting in a full surround sound experience
- ◆ XM Satellite Radio information displaying capability

iPod™ Controlling Capability

(U.S.A., Canada, and Australia models only)

- ◆ DOCK terminal to connect a Yamaha iPod universal dock (such as the YDS-10, sold separately), which supports iPod (Click and Wheel), iPod nano, and iPod mini
- ◆ Playback information displaying capability
- ◆ Battery charging capability

IntelliBeam

The “IntelliBeam” logo and “IntelliBeam” are trademarks of YAMAHA Corporation.



The “CINEMA DSP” logo and “Cinema DSP” are registered trademarks of YAMAHA Corporation.



Manufactured under license from Dolby Laboratories. “Dolby”, “Pro Logic”, and the double-D symbol are trademarks of Dolby Laboratories.



“DTS” and “Neo:6” are registered trademarks of DTS, Inc.

HDMI

“HDMI”, the “HDMI” logo and “High-Definition Multimedia Interface” are trademarks or registered trademarks of HDMI Licensing LLC.



Manufactured under license from 1 Ltd. Worldwide patents applied for.

The “1” logo and “Digital Sound Projector™” are trademarks of 1 Ltd.



TruBass, SRS and the “●” symbol are registered trademarks of SRS Labs, Inc. TruBass technology is incorporated under license from SRS Labs, Inc.



EUPHONY™ is a trademark of DiMAGIC Co., Ltd.

Using this manual

Notes

- This manual describes how to connect and operate this unit. For details regarding the operation of external components, refer to the supplied owner's manual for each component.
- Operations in this manual use keys on the supplied remote control of this unit unless otherwise specified.
- ✨ indicates a tip for your operation.
- This manual is printed prior to production. Designs and specifications are subject to change in part as a result of improvements, etc. In case of differences between the manual and the product, the product has priority.

1 Install this unit in your listening room.

See "Installation" on page 16.



2 Connect this unit to your TV and other external components.

See "Connections" on page 19.



3 Prepare the remote control and turn on the power of this unit.

See "Getting started" on page 30.



4 Run AUTO SETUP.

See "AUTO SETUP (IntelliBeam)" on page 35.



5 Play back a source.

See "Playback" on page 45.



6 Change the beam modes and/or CINEMA DSP settings.

See "Enjoying surround sound" on page 54.



If you want to make additional settings and adjustments

7 Run MANUAL SETUP to fine-tune settings and/or set remote control codes.

See "MANUAL SETUP" on page 72 and "Remote control features" on page 96.

Supplied accessories

Check that you have received all of the following parts.

Remote control (×1)

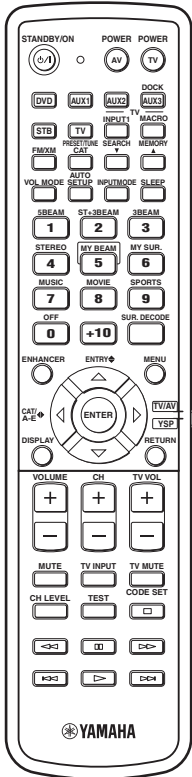

(U.S.A. and Canada models)

Fasteners (×4)

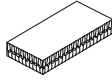

Cable clamp (×1)

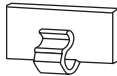

IntelliBeam microphone (×1)

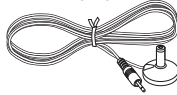

Cardboard microphone stand (×1)

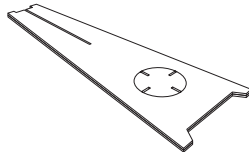

Optical cable (×1)



Digital audio pin cable (×1)

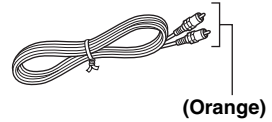

(Orange)

Audio pin cable (×1)

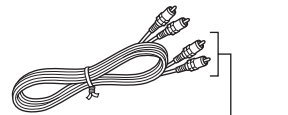

(White/Red)

REFERENCE GUIDE (iPod/XM Radio) (×1)

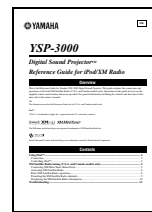

(U.S.A., Canada, and Australia models only)

Batteries (×2) (AA, R6, UM-3)

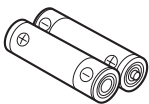

Indoor FM antenna (×1)

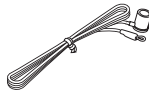

Demonstration DVD (×1)

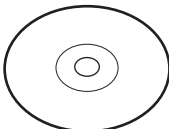

OSD* video pin cable (×1)

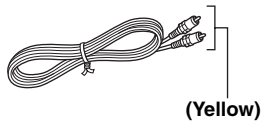

(Yellow)

*OSD: On-Screen Display

QUICK REFERENCE GUIDE

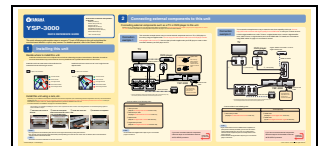

* The number of provided languages varies depending on the sales area.

Controls and functions

Front panel

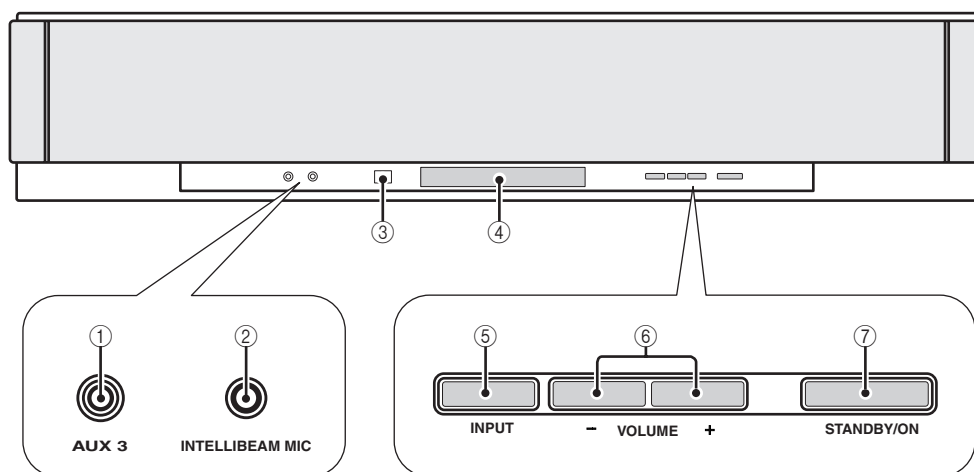

① AUX 3 input jack

Connect your portable audio player (see page 26).

② INTELLIBEAM MIC jack

Connect the supplied IntelliBeam microphone for AUTO SETUP (see page 36).

③ Remote control sensor

Receives infrared signals from the remote control.

④ Front panel display

Shows information about the operational status of this unit.

⑤ INPUT

Press repeatedly to switch between input sources (see page 45).

Outputs a test tone to experience the sound beam (see page 91).

⑥ VOLUME +/-

Controls the volume level of all audio channels (see page 47).

⑦ STANDBY/ON

Turns on the power of this unit or sets it to the standby mode (see page 31).

Notes

- When you turn on this unit, you will hear a click sound followed by the 4 to 5-second interval before sound reproducing.
- In the standby mode, this unit consumes a small amount of power in order to receive infrared signals from the remote control or to search for HDMI signals.

Front panel display

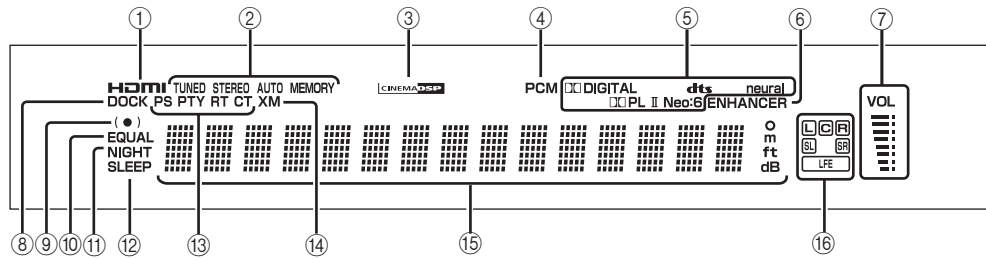

① HDMI indicator

Lights up when the signal of the selected input source is input at the HDMI IN jack(s).

② TUNER indicators

FM: Light up when this unit is receiving an FM broadcast.
XM: MEMORY flashes during the XM preset operation (U.S.A. and Canada models only).

③ CINEMA DSP indicator

Lights up when a sound field program is selected (see page 64).

④ PCM indicator

Lights up when this unit is reproducing PCM (Pulse Code Modulation) digital audio signals.

⑤ Decoder indicators

Light up when the corresponding decoder operates (see page 56).

Note

The neural decoder is available for the U.S.A. and Canada models only.

⑥ ENHANCER indicator

Lights up when the Music Enhancer is selected (see page 66).

⑦ Volume level indicator

Displays the current volume level.

⑧ DOCK indicator (U.S.A., Canada, and Australia models only)

Lights up when your iPod (Click and Wheel), iPod nano, or iPod mini is connected to this unit via the DOCK terminal on this unit.

⑨ SRS TruBass indicator

Lights up when TruBass is turned on (see page 79).

⑩ EQUAL indicator

Lights up when the TV volume equal mode is selected (see page 67).

⑪ NIGHT indicator

Lights up when one of the night listening enhancers is selected (see page 67).

⑫ SLEEP indicator

Lights up when the sleep timer is set (see page 68).

⑬ Radio Data System indicators (Europe model only)

Show the current Radio Data System status.

⑭ XM indicator (U.S.A. and Canada models only)

Lights up when XM is selected as the input source.

⑮ Multi-information display

Shows information with alphanumeric characters when you adjust the parameters of this unit.

⑯ Input channel indicators

Show information when you adjust the parameters of this unit. The channel component of the current digital input signal is displayed (see page 56).

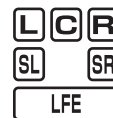

You can adjust the brightness and display setting of the front panel display using the F.DISPLAY SET parameter in MANUAL SETUP (see page 83).

Rear panel

The illustration below shows the rear panel of the U.S.A. and Canada models.

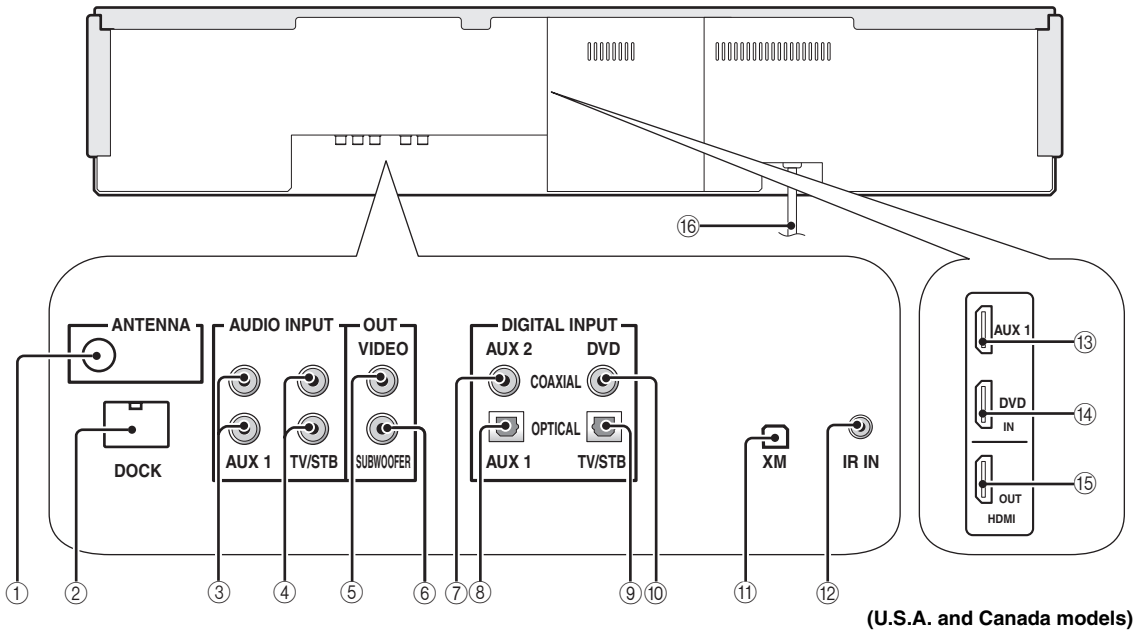

① ANTENNA jack

Connect the FM antenna (see page 29).

② DOCK terminal

(U.S.A., Canada, and Australia models only)

Connect the Yamaha iPod universal dock (such as YDS-10, sold separately) (see page 2 in the Reference Guide).

③ AUX 1 AUDIO INPUT jacks

Connect an external component via an analog connection (see page 23).

④ TV/STB AUDIO INPUT jacks

Connect your TV, digital satellite tuner, or cable TV tuner via an analog connection (see pages 22 and 24).

⑤ VIDEO OUT jack

Connect to the video input jack of your TV to display the OSD of this unit (see page 22).

⑥ SUBWOOFER OUT jack

Connect your subwoofer (see page 28).

⑦ AUX 2 COAXIAL DIGITAL INPUT jack

Connect an external component via a coaxial digital connection (see page 27).

⑧ AUX 1 OPTICAL DIGITAL INPUT jack

Connect an external component via an optical digital connection (see page 27).

⑨ TV/STB OPTICAL DIGITAL INPUT jack

Connect your TV, digital satellite tuner, or cable TV tuner via an optical digital connection (see pages 22 and 24).

⑩ DVD COAXIAL DIGITAL INPUT jack

Connect your DVD player via a coaxial digital connection (see page 23).

⑪ XM antenna jack

(U.S.A and Canada models only)

Connect your XM Mini-Tuner Dock (sold separately) (see page 5 in the Reference Guide).

⑫ IR IN terminal

(U.S.A and Canada models only)

This is a control expansion terminal for commercial use only (see page 29).

⑬ AUX 1 HDMI IN jack

Connect your digital satellite tuner, cable TV tuner, digital air wave tuner, or game console via an HDMI connection (see page 21).

⑭ DVD HDMI IN jack

Connect your DVD player via an HDMI connection (see page 21).

⑮ HDMI OUT jack

Connect to the HDMI IN jack on your HDMI component such as a TV or a projector connected to this unit (see page 21).

⑯ AC power supply cable

Connect to the AC wall outlet (see page 29).

Remote control (Europe, Australia, Asia, and Korea models)

This section describes the functions of the remote control used to control this unit. Some buttons marked with an asterisk (*) share the common functions between the YSP and TV/AV operation modes (29).



You can also control other components using the remote control once you set the appropriate remote control codes. See “Controlling other components” on page 97 for details.

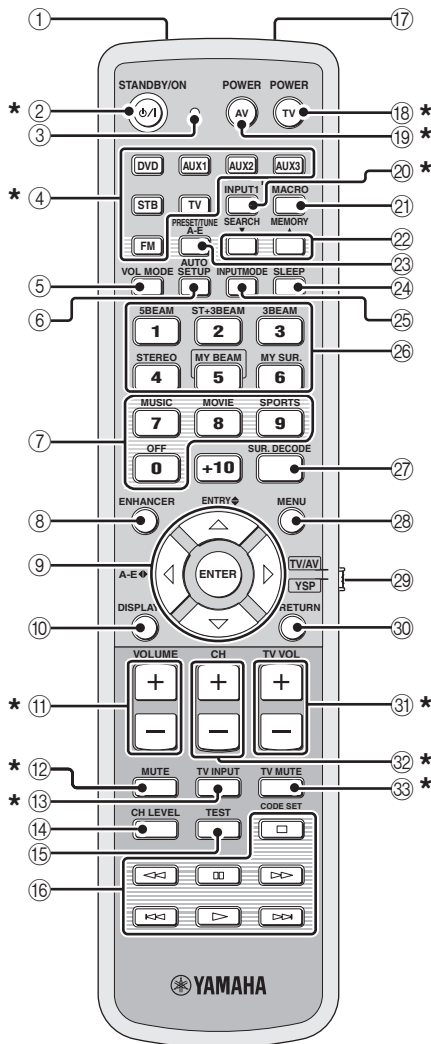

① Infrared window

Outputs infrared control signals. Aim this window at the component you want to operate.

② STANDBY/ON

Sets this system to the standby mode (see page 31).

③ Transmission indicator

Lights up when infrared control signals are being output.

④ Input selector buttons

Use to select an input source (DVD, AUX1, AUX2, AUX3, STB, TV, or FM).

⑤ VOL MODE

Turns on or off the volume modes (see page 67).

⑥ AUTO SETUP

Enters the AUTO SETUP menu (see page 35).

⑦ CINEMA DSP program buttons

Select the CINEMA DSP programs (see page 63).

⑧ ENHANCER

Turns on or off the Music Enhancer (see page 66).

⑨ Cursor buttons $\triangle / \nabla / \triangleleft / \triangleright$, ENTER

Select and adjust SET MENU items.

⑩ DISPLAY

Displays information on the selected input signal.

⑪ VOLUME +/-

Increases or decreases the volume level of this unit (see page 47).

⑫ MUTE

Mutes the sound. Press again to restore the audio output to the previous volume level (see page 47).

⑬ TV INPUT

Toggles between the input sources on the TV (see page 97).

⑭ CH LEVEL

Adjusts the volume level of each channel (see page 85).

⑮ TEST

Outputs a test tone when adjusting the output level of each channel (see page 84).

⑩ DVD player/VCR control buttons

Control your DVD player or VCR (see pages 98 and 99).

⑪ My Beam microphone

Collects the test tones from this unit when using the My Beam auto-adjust function (see page 61).

⑫ TV POWER

Turns on the power of your TV or sets it to the standby mode (see page 97).

⑬ AV POWER

Turns on the power of the selected component or sets it to the standby mode (see pages 98 and 99).

⑭ INPUT1

Switches the input source on your TV (see page 97).

⑮ MACRO

Use to set the TV macro (see page 100).

⑯ /▲

Switches the preset station number (1 to 8) when this unit is receiving an FM broadcast (see page 52).

⑰ A-E

Switches the preset station group (A to E) when this unit is receiving an FM broadcast (see page 52).

⑱ SLEEP

Sets the sleep timer (see page 68).

⑲ INPUTMODE

Toggles between input modes (AUTO, DTS, and ANALOG) (see page 87).

⑳ Beam mode buttons

Change the beam mode settings (see pages 54, 60, and 61).

㉑ SUR. DECODE

Selects the surround mode for playback (see page 57).

㉒ MENU

Displays the setup menu on your TV monitor (see pages 37 and 73).

㉓ Operation mode selector

Selects the operation mode of this unit. Select YSP when operating this unit and select TV/AV when operating your TV or other AV components.

㉔ RETURN

Selects sleep timer settings or returns to the previous SET MENU screen.

㉕ TV VOL +/-

Adjusts the volume level of your TV (see page 97).

㉖ CH +/-

Changes the channels of your TV, digital satellite tuner, cable TV tuner, or VCR (see pages 97 and 99).

㉗ TV MUTE, CODE SET

Mutes the audio output of your TV (see page 97).
Sets up remote control codes (see page 96).

Note

The functions ⑳ and ㉓ are available only when the FM stations are preset.

This section describes the functions of the remote control used to control FM, Radio Data System, or iPod when the TV/AV mode is selected with the operation mode selector (7). Note that the Radio Data System controls are available for Europe model only, and the iPod controls are available for Australia model only.

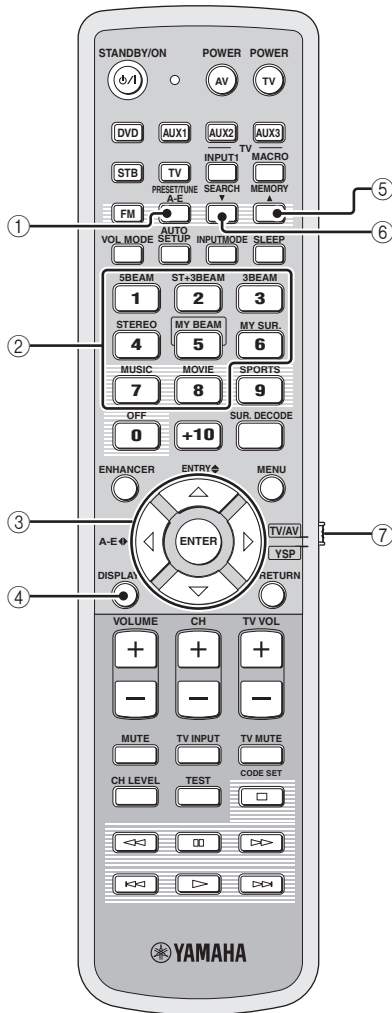

① PRESET/TUNE

FM: Switches between the preset search mode and the frequency search mode (see pages 49 to 52).

② Numeric buttons

FM: Enter numbers.

③ Cursor buttons $\triangle / \nabla / \leftarrow / \rightarrow$, ENTER

FM: Use ENTRY \blacklozenge (\triangle / ∇) to change the preset station number (1 to 8) or frequency level (see pages 49 to 52). Use A-E \blacklozenge (\leftarrow / \rightarrow) to change the preset station group (A to E) (see pages 51 and 52). Use ENTER to confirm the input above.



These functions are also available when this unit is receiving the Radio Data System (see page 52) or playing back your iPod (see page 2 in the Reference Guide).

④ DISPLAY

Radio Data System and iPod: Displays information when this unit is receiving the Radio Data System (see page 52) or playing back your iPod (see page 2 in the Reference Guide).

⑤ MEMORY

FM: Stores the preset stations (see pages 50 and 51).



This function is also available when this unit is receiving the Radio Data System (see page 52).

⑥ SEARCH

FM: Switches between automatic and manual tuning (see page 49).

⑦ Operation mode selector

Selects the operation mode of this unit. Select YSP when operating this unit and select TV/AV when operating your TV or other AV components.

Remote control (U.S.A. and Canada models)

This section describes the functions of the remote control used to control this unit. Some buttons marked with an asterisk (*) share the common functions between the YSP and TV/AV operation modes (29).



You can also control other components using the remote control once you set the appropriate remote control codes. See "Controlling other components" on page 97 for details.

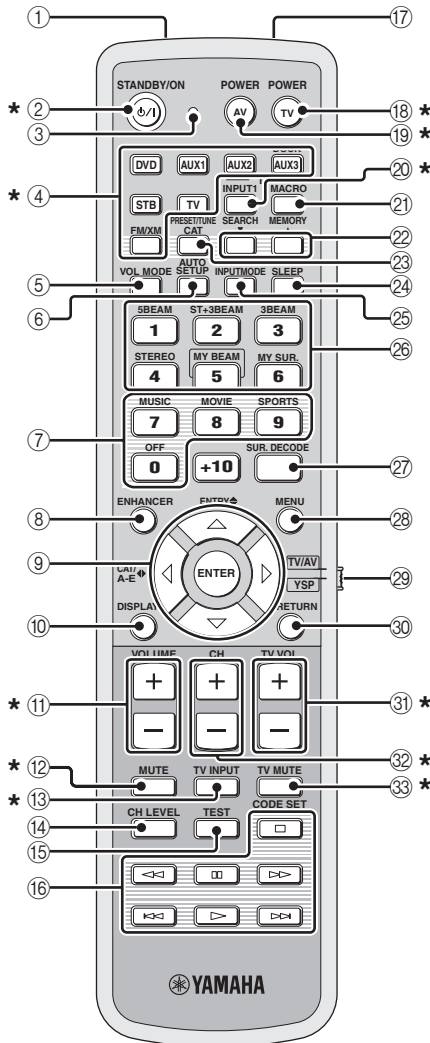

① Infrared window

Outputs infrared control signals. Aim this window at the component you want to operate.

② STANDBY/ON

Sets this system to the standby mode (see page 31).

③ Transmission indicator

Lights up when infrared control signals are being output.

④ Input selector buttons

Use to select an input source (DVD, AUX1, AUX2, AUX3/DOCK, STB, TV, or FM/XM).

⑤ VOL MODE

Turns on or off the volume modes (see page 67).

⑥ AUTO SETUP

Enters the AUTO SETUP menu (see page 35).

⑦ Sound field program buttons

Select the sound field programs (see page 63).

⑧ ENHANCER

Turns on or off the Music Enhancer (see page 66).

⑨ Cursor buttons $\triangle / \nabla / \triangleleft / \triangleright$, ENTER

Select and adjust SET MENU items.

⑩ DISPLAY

Displays information on the selected input signal.

⑪ VOLUME +/-

Increases or decreases the volume level of this unit (see page 47).

⑫ MUTE

Mutes the sound. Press again to restore the audio output to the previous volume level (see page 47).

⑬ TV INPUT

Toggles between the input source on your TV (see page 97).

⑭ CH LEVEL

Adjusts the volume level of each channel (see page 85).

⑮ TEST

Outputs a test tone when adjusting the output level of each channel (see page 84).

16 DVD player/VCR control buttons

Control your DVD player or VCR (see pages 98 and 99).

17 My Beam microphone

Collects the test tones from this unit when using the My Beam auto-adjust function (see page 61).

18 TV POWER

Turns on the power of your TV or sets it to the standby mode (see page 97).

19 AV POWER

Turns on the power of the selected component or sets it to the standby mode (see pages 98 and 99).

20 INPUT1

Switches the input source on your TV (see page 97).

21 MACRO

Use to set the TV macro (see page 100).

22 /▲

Switches the preset station number (1 to 8) when this unit is receiving an FM broadcast or XM channel (see page 52).

23 CAT

Switches the preset station group (A to E) when this unit is receiving an FM broadcast or XM channel (see page 52).

24 SLEEP

Sets the sleep timer (see page 68).

25 INPUTMODE

Toggles between input modes (AUTO, DTS, and ANALOG) (see page 87).

26 Beam mode buttons

Change the beam mode settings (see pages 54, 60, and 61).

27 SUR. DECODE

Selects the surround mode for playback (see page 57).

28 MENU

Displays the setup menu on your TV monitor (see pages 37 and 73).

29 Operation mode selector

Selects the operation mode of this unit. Select YSP when operating this unit and select TV/AV when operating your TV or other AV components.

30 RETURN

Selects sleep timer settings or returns to the previous SET MENU screen.

31 TV VOL +/-

Adjusts the volume level of your TV (see page 97).

32 CH +/-

Changes the channels of your TV, digital satellite tuner, cable TV tuner, or VCR (see pages 97 and 99).

33 TV MUTE, CODE SET

Mutes the audio output of your TV (see page 97). Sets up remote control codes (see page 96).

Note

The functions 22 and 23 are available only when the FM/XM stations are preset.

This section describes the functions of the remote control used to control FM, XM Satellite Radio, or iPod when the TV/AV mode is selected with the operation mode selector (7).

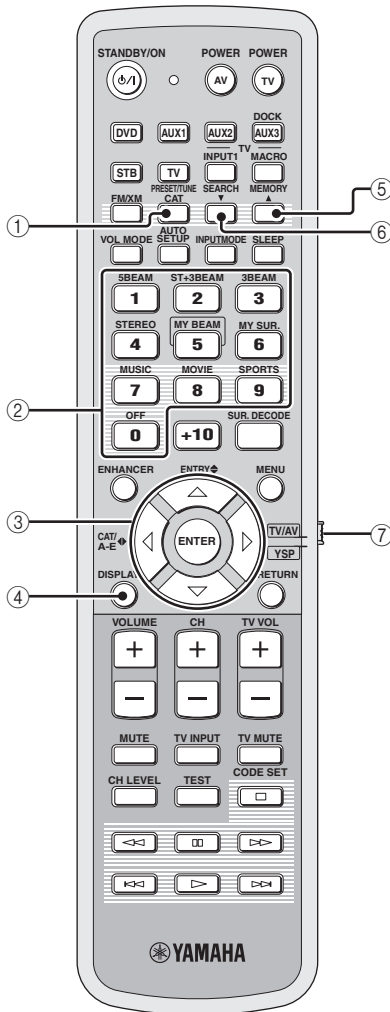

① PRESET/TUNE

FM: Switches between the preset search mode and the frequency search mode (see pages 49 to 52).

② Numeric buttons

FM, XM: Enter numbers.

③ Cursor buttons \triangle / ∇ / \blacktriangleleft / \blacktriangleright , ENTER

FM: Use ENTRY \blacktriangleleft (\triangle / ∇) to change the preset station number (1 to 8) or frequency level (see pages 49 to 52). Use CAT/A-E \blacktriangleleft (\blacktriangleleft / \blacktriangleright) to change the preset station group (A to E) (see pages 51 and 52). Use ENTER to confirm the input above.

XM: Use ENTRY \blacktriangleleft (\triangle / ∇) to select XM channels in All Channel Search mode/Category Search mode, and to select the preset channel number (1 to 8) in Preset Search mode. Use CAT/A-E \blacktriangleleft (\blacktriangleleft / \blacktriangleright) to select XM categories in All Channel Search mode/Category Search mode, and to select the preset channel group (A to E) in Preset Search mode. Use ENTER to confirm the input above (see pages 7 and 8 in the Reference Guide).



These functions are also available when this unit is playing back your iPod (see page 2 in the Reference Guide).

④ DISPLAY

XM and iPod: Displays information when this unit is receiving an XM channel (see page 10 in the Reference Guide) or playing back your iPod (see page 3 in the Reference Guide).

⑤ MEMORY

FM: Stores the preset stations (see pages 50 and 51).

XM: Use to store the preset stations (see page 9 in the Reference Guide).

⑥ SEARCH

FM: Switches between automatic and manual tuning (see page 49).

XM: Switches between search modes (All Channel Search, Category Search, and Preset Search) (see pages 7 and 8 in the Reference Guide).

⑦ Operation mode selector

Selects the operation mode of this unit. Select YSP when operating this unit and select TV/AV when operating your TV or other AV components.

Installation

This section describes a suitable installation location to install this unit using a metal wall bracket, a rack or a stand. Depending on your installation environment, connections with external components can be done before installing this unit. We recommend that you temporarily place and arrange all components, including this unit, in order to decide which procedure should come first. Especially when you make a connection over HDMI, we recommend that you make a connection first before installation (see page 21).

Before installing this unit

This unit creates surround sound by reflecting projected sound beams off the walls of your listening room. The surround sound effects produced by this unit may not be sufficient when this unit is installed in the following locations.

- Rooms with walls inadequate for reflecting sound beams
- Rooms with acoustically absorbent walls
- Rooms with measurements outside the following range: W (3 to 7 m (10 to 23 ft)) x H (2 to 3.5 m (7 to 11.5 ft)) x D (3 to 7 m (10 to 23 ft))
- Rooms with less than 1.8 m (6 ft) from the listening position to this unit
- Rooms where objects such as furniture are likely to obstruct the path of sound beams
- Rooms where the listening position is close to the walls
- Rooms where the listening position is not in front of this unit



- You can enjoy surround sound by selecting My Surround (see page 55) as the beam mode even if your listening room may not fulfill the above conditions (except when the listening position is not directly facing toward the front of this unit).
- You can also enjoy surround sound by selecting 2-channel or 5-channel stereo playback (see page 60) or My Beam (see page 61) as the beam mode even if your listening room may not fulfill the above conditions.

Make sure you leave an adequate amount of ventilation space so that heat can escape. Make at least 5 cm (2 in) of space above or below this unit.

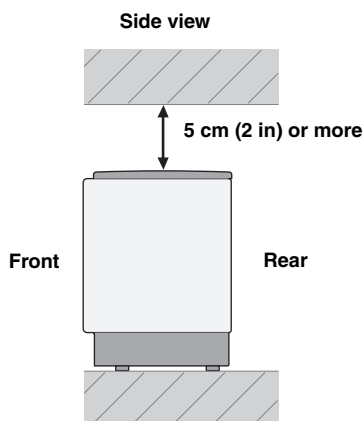

Notes

- We do not recommend putting this unit directly on the floor of your listening room. Please install this unit using a metal wall bracket, a rack, or a stand.
- This unit weighs 11.5 kg (25 lbs 6 oz). Be sure to install this unit where it will not fall subject to vibrations, such as from an earthquake, and where it is out of the reach of children.
- When using a cathode-ray tube (CRT) TV, do not install this unit directly above your TV.
- This unit is shielded against magnetic rays. However, if the picture on your TV screen becomes blurred or distorted, we recommend moving this unit away from your TV.

Installing this unit

Install this unit where there are no obstacles such as furniture obstructing the path of sound beams. Otherwise, the desired surround sound effects may not be achieved. You may install this unit in parallel with the wall or in the corner.

Parallel installation

Install this unit in the exact center of the wall when it is measured from the left and right corners.

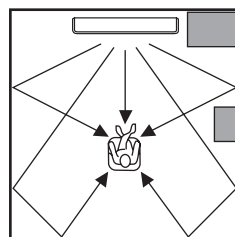

An object, such as furniture

Corner installation

Install this unit in the corner at a 40° to 50° angle from the adjacent walls.

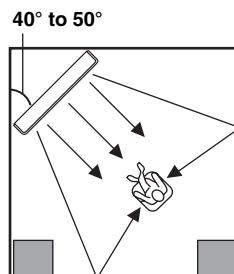

An object, such as furniture

■ Installation examples

Example 1

Install this unit as close to the exact center of the wall as possible.

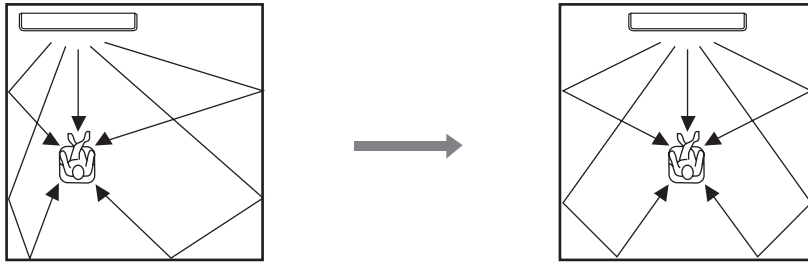

Example 2

Install this unit so that the sound beams can be reflected off the walls.

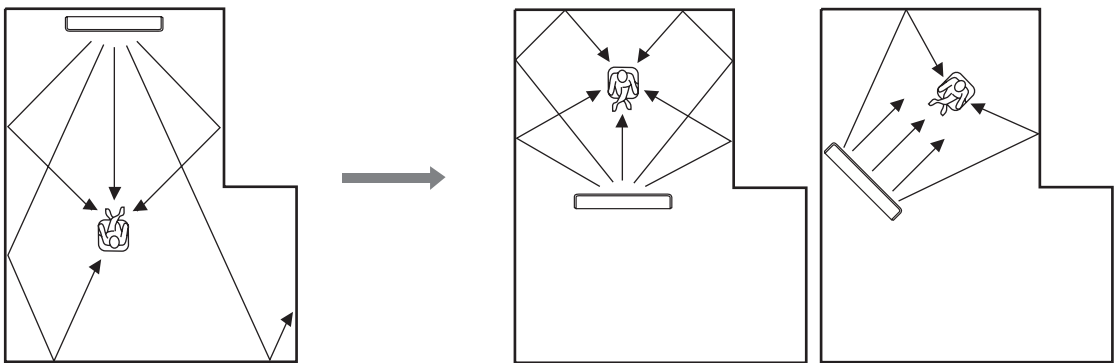

Example 3

Install this unit as close to the exact front of your normal listening position as possible.

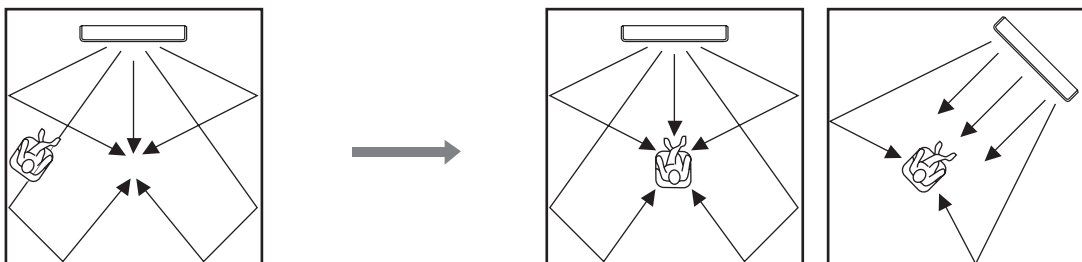

■ Using a metal wall bracket

You can use the optional metal wall bracket to mount this unit on the wall in your listening room.

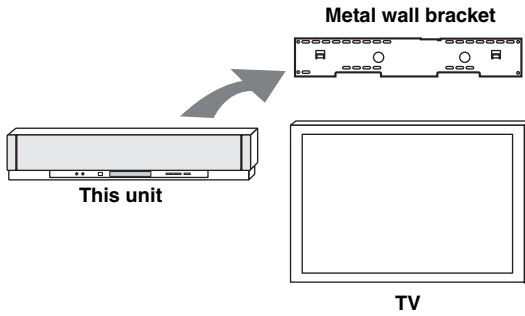

YSP-3000

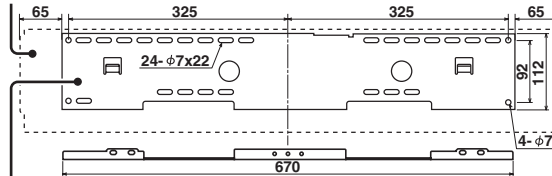

SPM-K30 (Option)



Refer to the instructions supplied with the metal bracket for details on how to attach the metal bracket to the wall or how to attach this unit to the metal bracket.

■ Using a stand

You can mount your TV on a stand placed on a commercially available rack and install this unit under your TV.

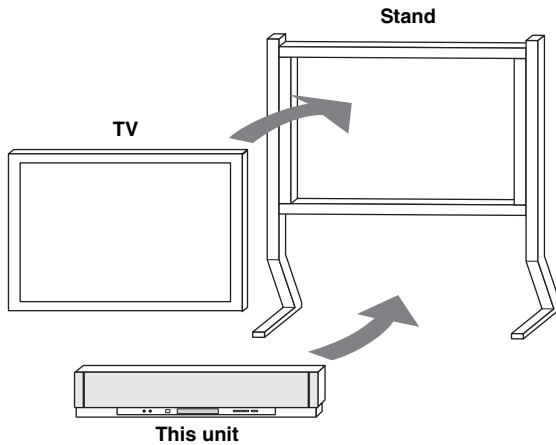

Refer to the instructions supplied with the stand for details on how to install the stand or how to mount the TV on the stand.

■ Using a rack

You can install this unit either above or under your TV in a commercially available rack.

When this unit is installed above your TV

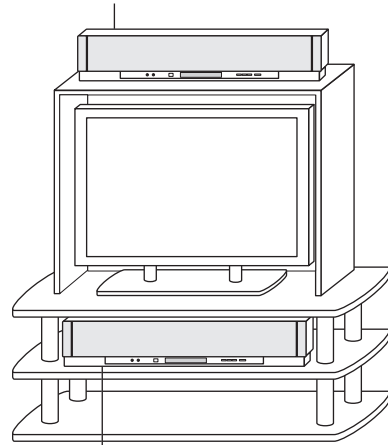

When this unit is installed under your TV

Note

Make sure that the rack is large enough to allow adequate ventilation space around this unit (see page 16) and that it is strong enough to support the weight of both this unit and your TV.

■ Affixing this unit

Peel off the film from each of the four supplied fasteners and then secure them to the bottom four corners of this unit and the top of the rack, etc.

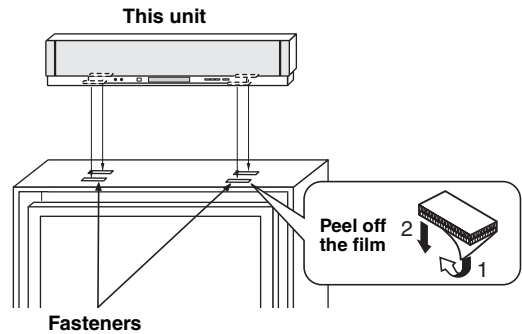

Notes

- Do not install this unit on top of a slanted surface. This unit may fall over and cause injury.
- Make sure you wipe the surface of the rack, etc. before securing the fasteners. Applying the tape to a dirty or wet surface will weaken the sticking power of the tape, and this unit may fall as a result.

Connections

This unit is equipped with the following types of audio/video input/output jacks/terminal:

For audio input

- 2 optical digital input jacks
- 2 coaxial digital input jacks
- 2 sets of analog input jacks
- 1 universal dock terminal
(U.S.A., Canada, and Australia models only)

For audio/video input

- 2 HDMI input jacks

For audio output

- 1 subwoofer output jack

For audio/video output

- 1 HDMI output jack

For video output

- 1 analog output jack

Use these jacks/terminal to connect external components such as your TV, DVD player, VCR, digital satellite tuner, cable TV tuner, digital air wave tuner, portable audio player, game console, and iPod. Further, by connecting a subwoofer to this unit, you can enjoy reinforced low-bass sounds. For details on how to connect various types of external components to this unit, see pages 21 to 28.

CAUTION

- Do not connect this unit or other components to the mains power until all connections between components are complete.
- Unplug the AC power supply cable before changing connections, moving or cleaning this unit.

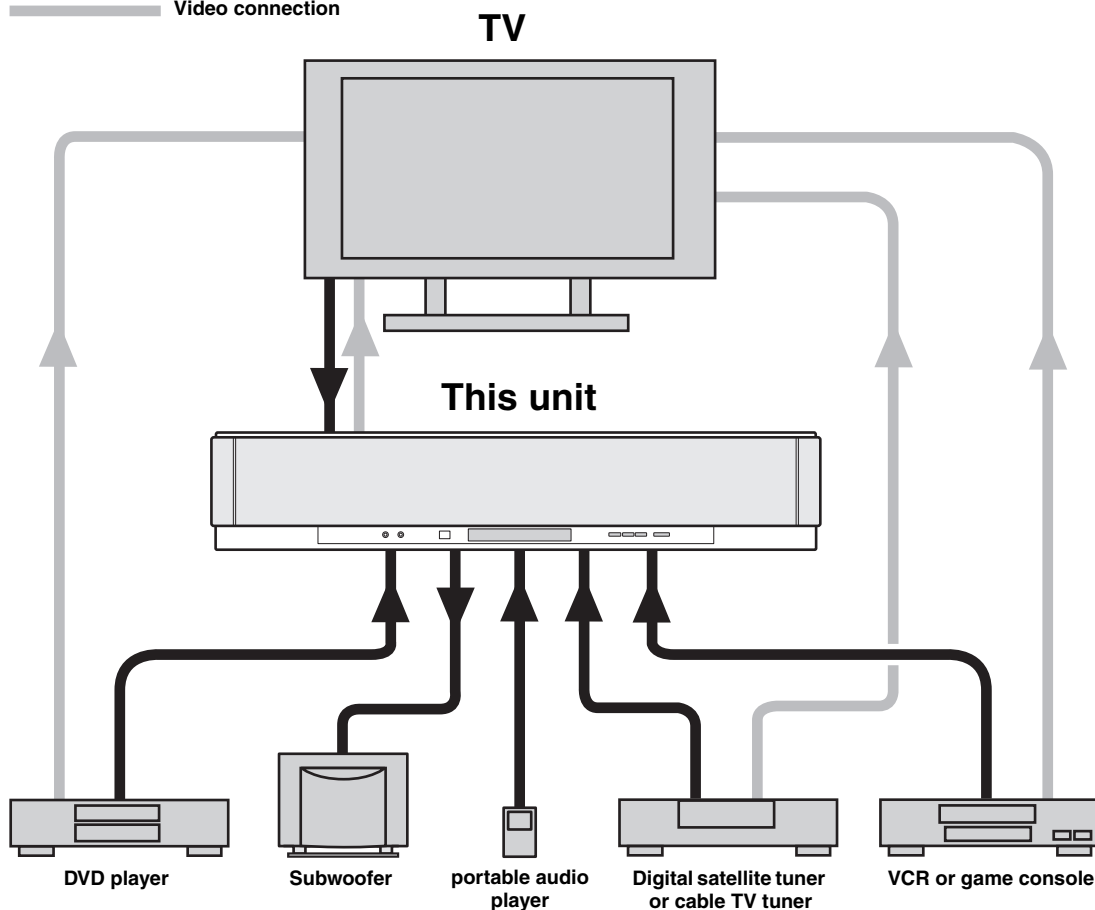

Before connecting components

■ Cables used for connections

Audio/Video

A HDMI cable

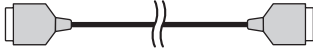

Audio

1 Audio pin cable (supplied)



2 Optical cable (supplied)

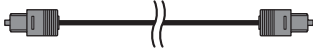

3 Digital audio pin cable (supplied)



4 3.5 mm stereo mini plug cable



5 Subwoofer pin cable

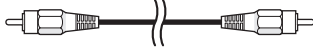

Video

1 OSD video pin cable (supplied)



■ Notes on connecting the optical cable

- Pull out the cap before connecting the optical cable. When you are not using the optical cable, be sure to put the cap back in place.
- When inserting the cable into the optical digital jack, make sure the direction is correct.

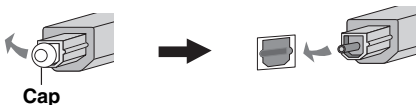

■ Affixing cables

To prevent cables from becoming unplugged, place the supplied cable clamp with the open side facing upward, attach it to the rear panel of this unit in a suitable position, and then affix cables in the cable clamp.

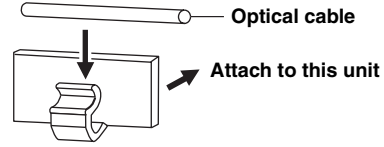

■ Information on HDMI™

Audio Signals

Input source	Audio signal type
DVD video	Dolby Digital, DTS, PCM
DVD audio	2-channel stereo (up to 96 kHz/24 bit)
Blu-ray Disc HD DVD	Dolby Digital, DTS, PCM

Notes

- When CPPM copy-protected DVD audio is played back, video and audio signals may not be output depending on the type of DVD player.
- This unit is not compatible with HDCP-incompatible HDMI or DVI components.



- We recommend that you use an HDMI cable shorter than 5 m (16 ft) with the HDMI logo printed on it.
- Use a conversion cable (HDMI jack ↔ DVI-D jack) to connect this unit to other DVI components.

■ Priority order for audio input signals

When multiple types of audio signals are simultaneously being input from a single source component, this unit plays back the audio signals in the following priority order: HDMI → Digital → Analog

As default settings, the following input jacks are assigned to the corresponding input sources:

Input jack	HDMI	Digital	Analog
TV/STB		○	
DVD	○	○	
AUX 1	○	○	
AUX 2		○	
AUX 3			○

Connections using HDMI cables

This unit is equipped with 2 HDMI input jacks and 1 HDMI output jack. If your TV and other components have HDMI jacks, use HDMI cables for simpler and easier connections, and you can skip the connection procedures from page 22 to 25. If your TV has a built-in digital satellite tuner and an optical digital output jack, connect the optical digital output jack on your TV to the TV/STB OPTICAL DIGITAL INPUT jack on this unit.

Notes

- Even if you connect your TV and this unit via the HDMI jack, you need to connect the video input jack on your TV to the VIDEO OUT jack on this unit in order to display the OSD of this unit.
- When HDMI CONTROL is set to OFF (see page 82) and this unit is in the standby mode, the signals input at the HDMI IN jacks are not output at the HDMI OUT jack.

 We recommend that you secure the HDMI cable(s) with adhesive tape, etc. once you have connected the HDMI cable(s) to the HDMI jack(s) of this unit.

Rear panel of this unit

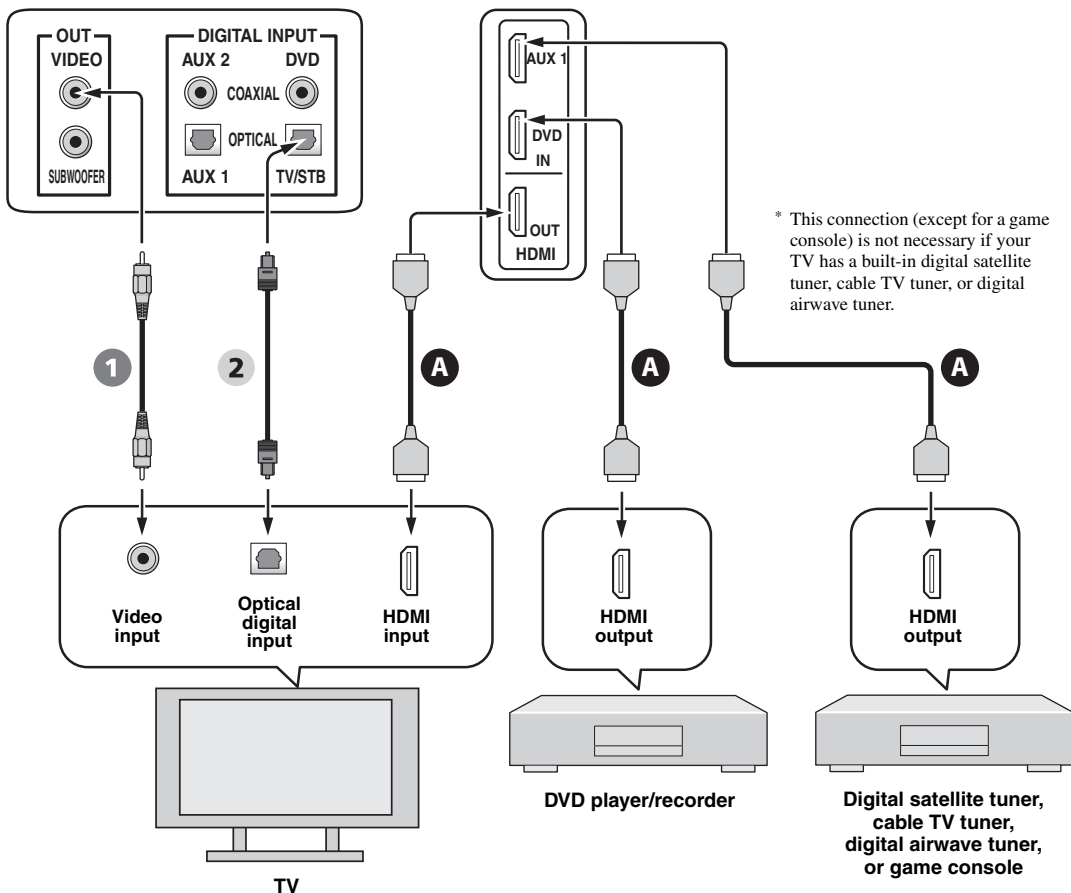

Audio/Video

A HDMI cable

Video

1 OSD video pin cable

Audio

2 Optical cable

Connecting a TV

For audio connection, connect the analog audio output jacks on your TV to the TV/STB AUDIO INPUT jacks on this unit. If your TV has an optical digital output jack, connect the optical digital output jack on your TV to the TV/STB OPTICAL DIGITAL INPUT jack on this unit.

For video connection, connect the video input jack on your TV to the VIDEO OUT jack on this unit to display the OSD for easy viewing when you adjust the system parameters in SET MENU.



To prevent the optical cable from being unplugged, affix the optical cable in the supplied cable clamp (see page 20).

Notes

- If you make analog and optical digital audio connections at the same time as shown in the illustration below, the digital audio signals input at the TV/STB OPTICAL DIGITAL INPUT jack take priority over the analog audio signals input at the TV/STB AUDIO INPUT jacks.
- Even if you connect your TV and this unit via the HDMI jack, you need to connect the video input jack on your TV to the VIDEO OUT jack on this unit in order to display the OSD of this unit.

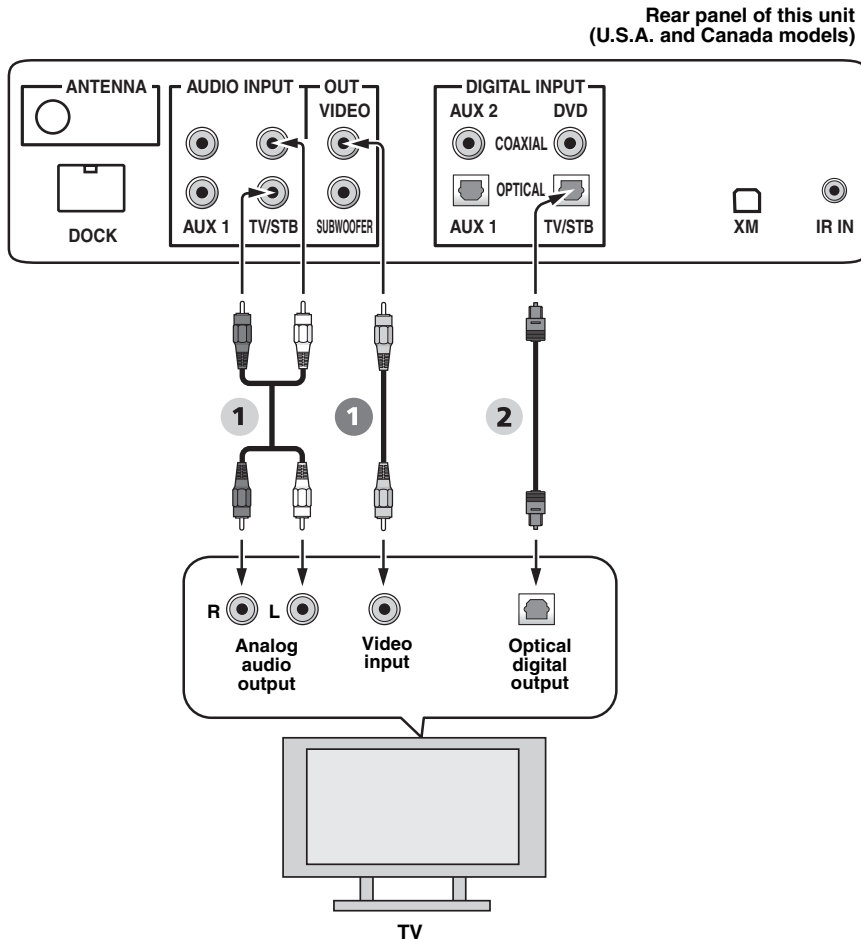

Video

- 1 OSD video pin cable

Audio

- 1 Audio pin cable
- 2 Optical cable

Connecting a DVD player/recorder

Connect the coaxial digital output jack on your DVD player/recorder to the DVD COAXIAL DIGITAL INPUT jack on this unit. When you connect this unit to your DVD/VCR combo player/recorder, connect the analog audio output jacks on your DVD/VCR combo player/recorder to the AUX 1 AUDIO INPUT jacks on this unit in addition to the coaxial digital audio connection.



To prevent the optical cable from being unplugged, affix the optical cable in the supplied cable clamp (see page 20).

Notes

- Check that your DVD player/recorder is properly set to output Dolby Digital and DTS digital audio signals. If not, adjust the system settings of your DVD player/recorder. For details, refer to the operation manual supplied with your DVD player/recorder.
- If your DVD player/recorder does not have a coaxial digital output jack, make an optical digital audio connection instead (see page 27).

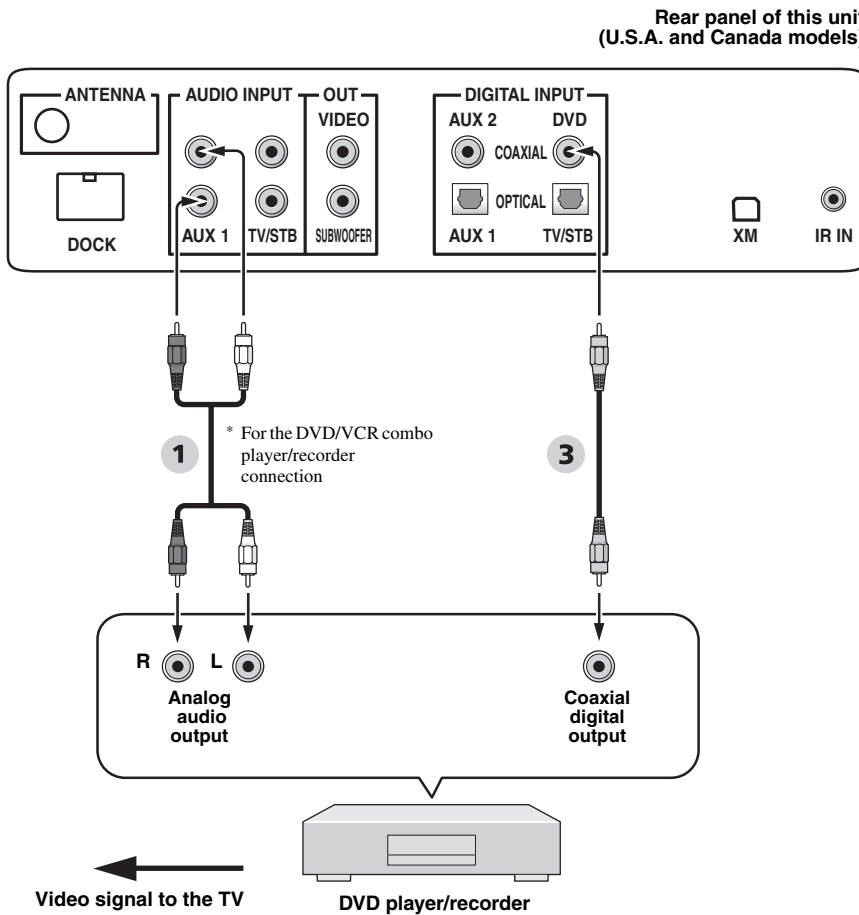

Audio

- 1 Audio pin cable
- 3 Digital audio pin cable

Connecting a digital satellite tuner or a cable TV tuner

Connect the optical digital output jack on your digital satellite tuner or cable TV tuner to the TV/STB OPTICAL DIGITAL INPUT jack on this unit. Connect the analog audio output jacks on your digital satellite tuner or cable TV tuner to the TV/STB AUDIO INPUT jacks on this unit.



To prevent the optical cable from being unplugged, affix the optical cable in the supplied cable clamp (see page 20).

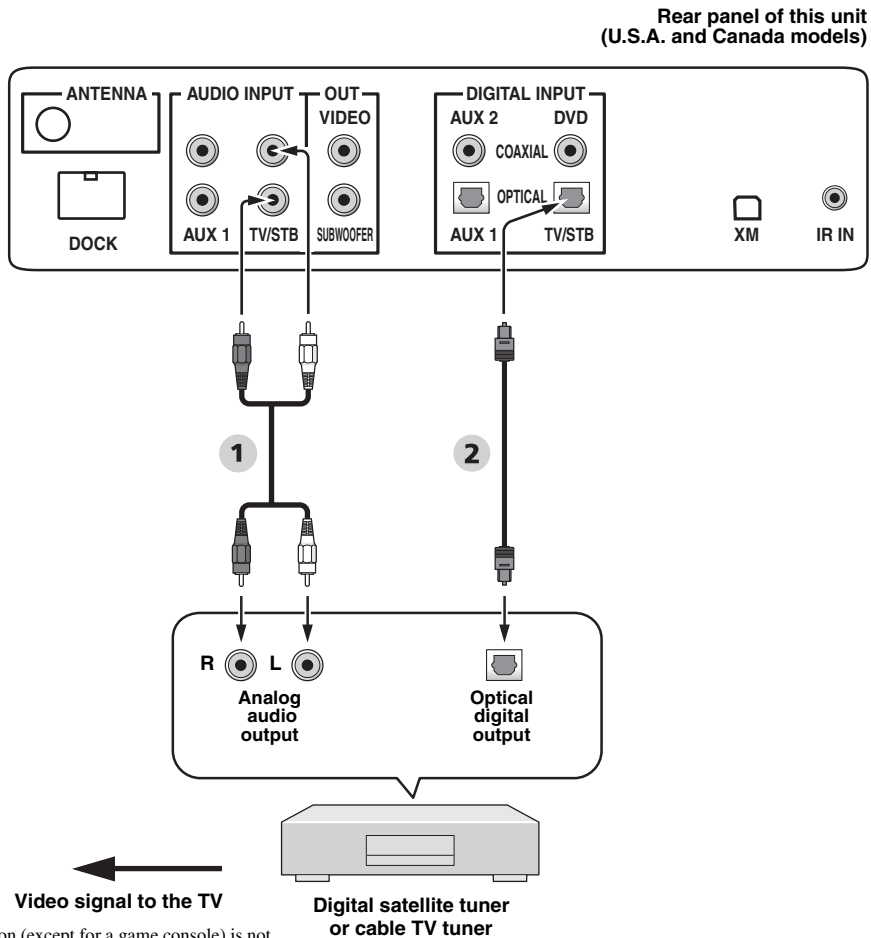

* This connection (except for a game console) is not necessary if your TV has a built-in digital satellite tuner, cable TV tuner, or digital airwave tuner.

Audio

- 1** Audio pin cable
- 2** Optical cable

Connecting a digital airwave tuner

Connect the TV/STB AUDIO INPUT jacks on this unit to the analog audio output jacks on your TV. Connect the optical digital output jack on your digital airwave tuner to the TV/STB OPTICAL DIGITAL INPUT jack on this unit in addition to the analog audio connection. By doing so, you can enjoy both analog and digital broadcasts.



To prevent the optical cable from being unplugged, affix the optical cable in the supplied cable clamp (see page 20).

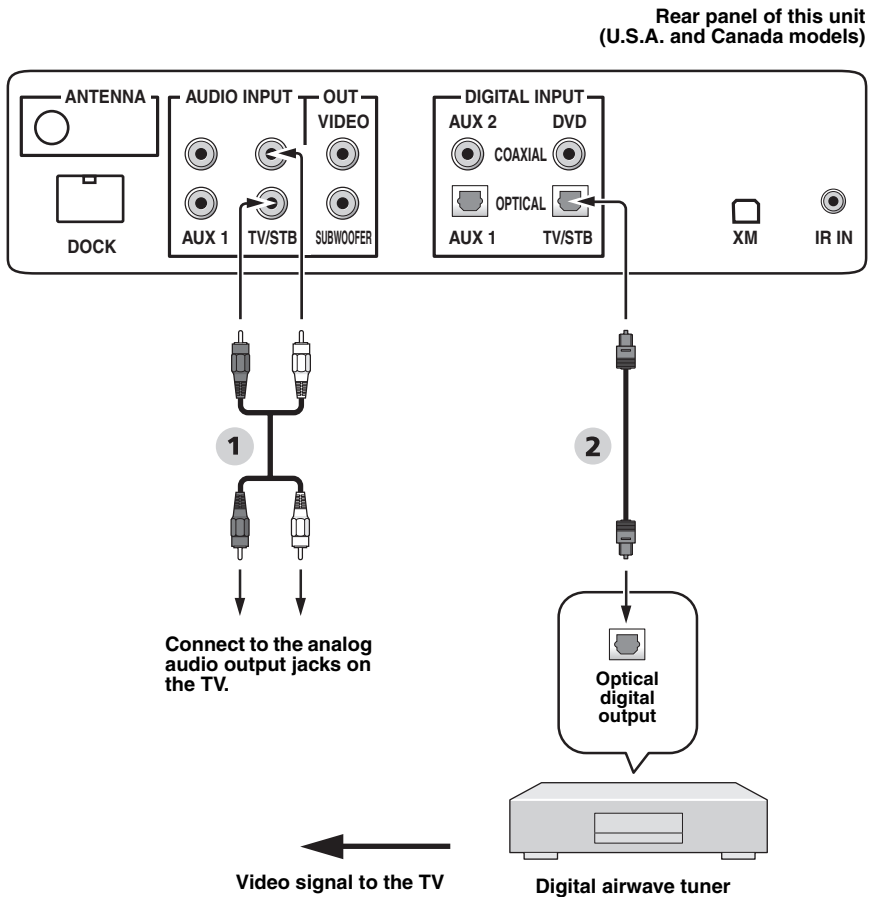

* This connection (except for a game console) is not necessary if your TV has a built-in digital satellite tuner, cable TV tuner, or digital airwave tuner.

Audio

- 1 Audio pin cable
- 2 Optical cable

Connecting a portable audio player

Connect the analog audio output jack on your portable audio player to the AUX 3 input jack on the front panel of this unit.

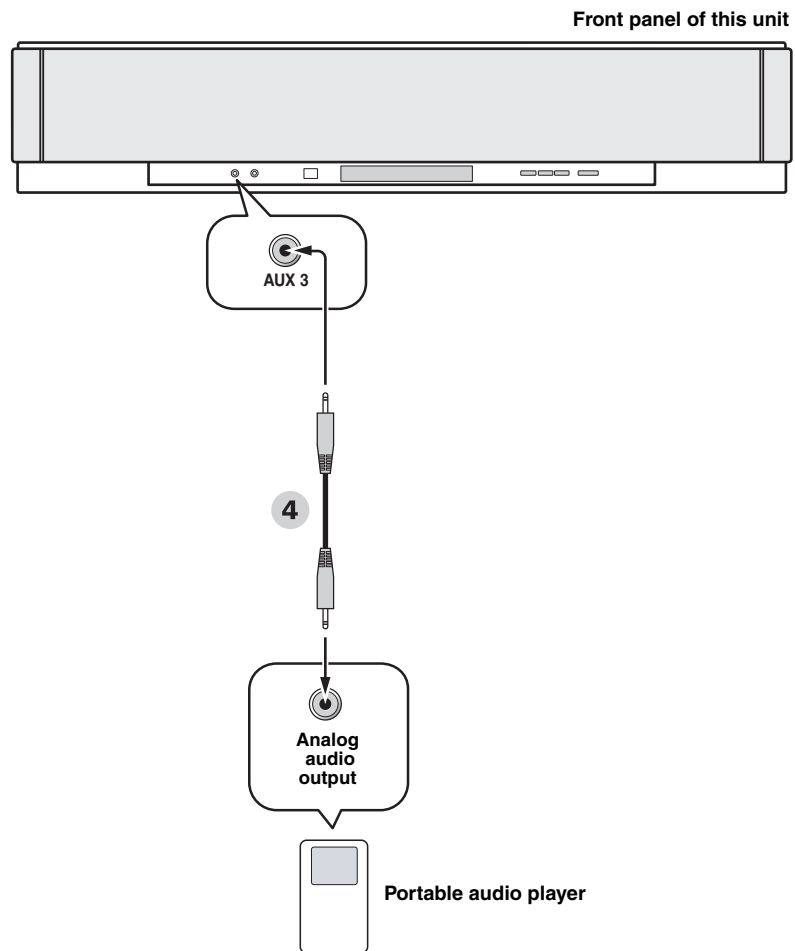

Audio

- 4 3.5 mm stereo mini plug cable

Connecting other external components

If your component supports optical digital connections, connect the optical digital output jack on your component to the AUX 1 OPTICAL DIGITAL INPUT jack on this unit. If your component does not support optical digital connections, connect the coaxial digital output jack on your component to the AUX 2 COAXIAL DIGITAL INPUT jack on this unit.

If your component does not support any digital connections, connect the analog audio output jacks on your component to the AUX 1 AUDIO INPUT jacks on this unit.



To prevent the optical cable from being unplugged, affix the optical cable in the supplied cable clamp (see page 20).

Note

If you make analog and digital audio connections at the same time as shown in the illustration below, the digital audio signals input at the AUX 1 OPTICAL DIGITAL INPUT or AUX 2 COAXIAL DIGITAL INPUT jack take priority over the analog audio signals input at the AUX 1 AUDIO INPUT jacks.

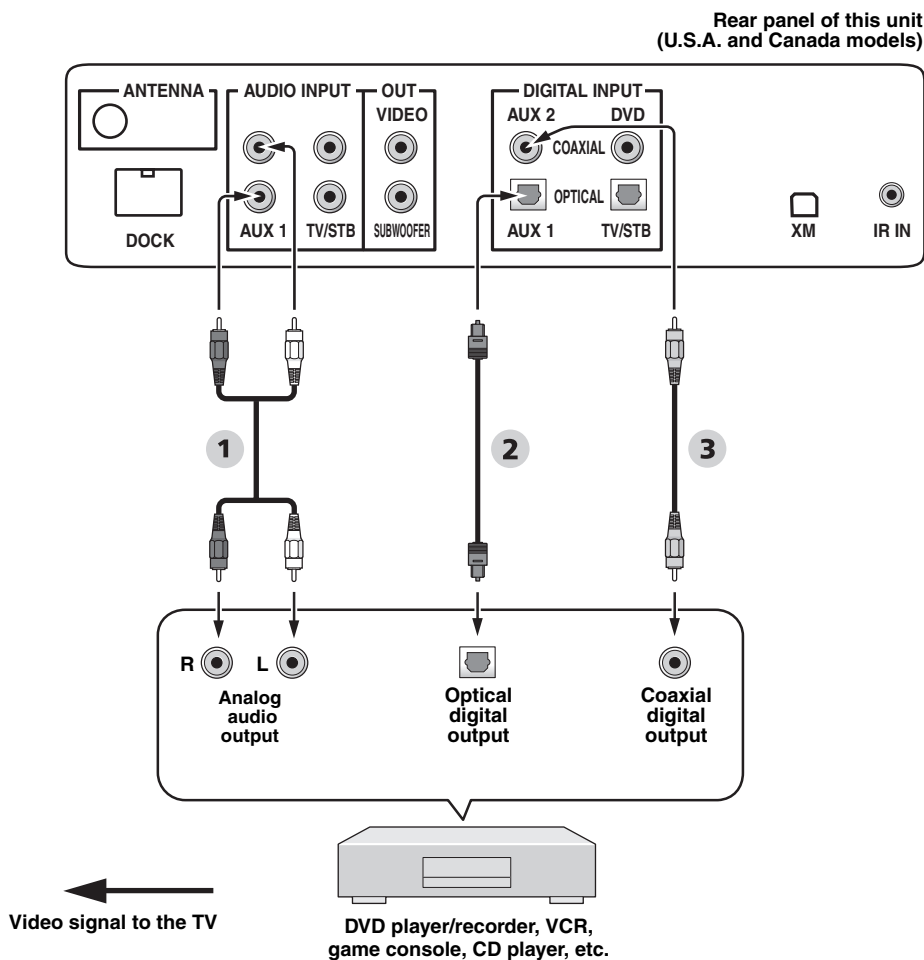

Audio

- 1 Audio pin cable
- 2 Optical cable
- 3 Digital audio pin cable

Connecting a subwoofer

Connect the monaural input jack on your subwoofer to the SUBWOOFER OUT jack on this unit.

This connection alone does not output sound from the connected subwoofer. To output sound from the connected subwoofer, turn on the power of your subwoofer and then run AUTO SETUP (see page 35) or select SWFR for BASS OUT in SUBWOOFER SET (see page 78).

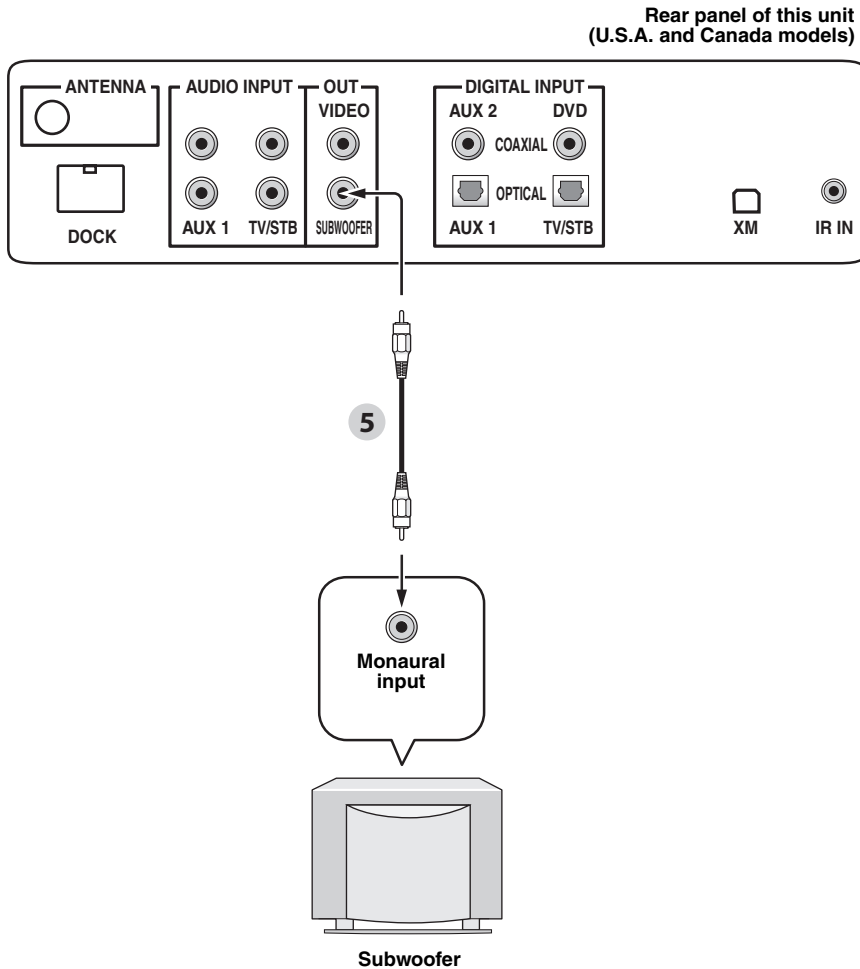

Audio

- 5 Subwoofer pin cable

Connecting the FM antenna

Connect the supplied FM antenna to the FM ANTENNA jack on this unit.

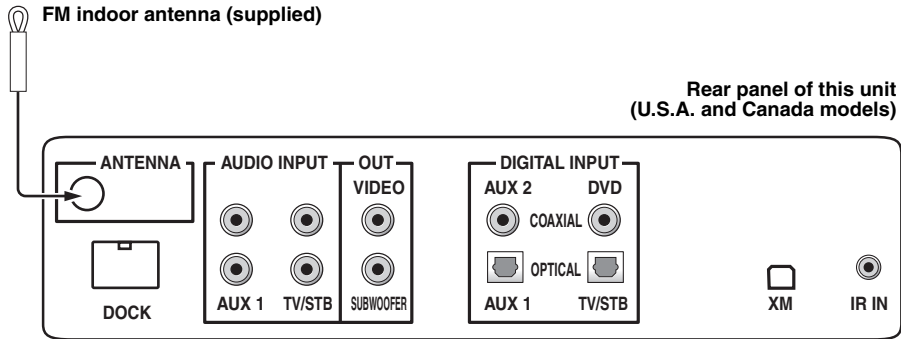

About the IR IN terminal (U.S.A. and Canada models only)

The IR IN terminal does not support normal external component connection. This is a control expansion terminal for commercial use only.

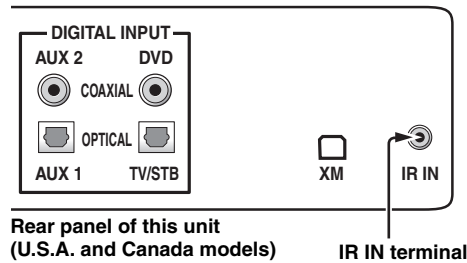

Connecting the AC power supply cable

Once all other connections are complete, plug the AC power supply cable into the AC wall outlet.

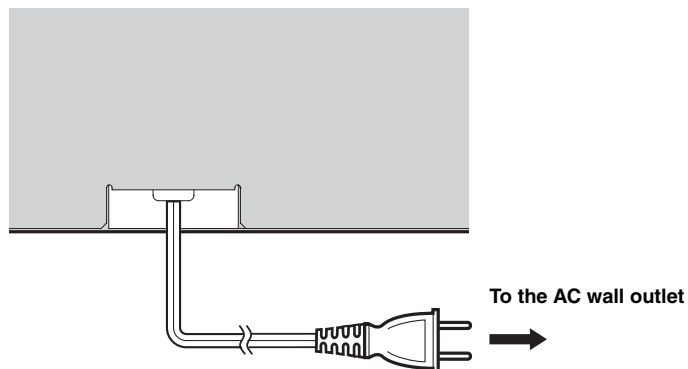

Getting started

Installing batteries in the remote control

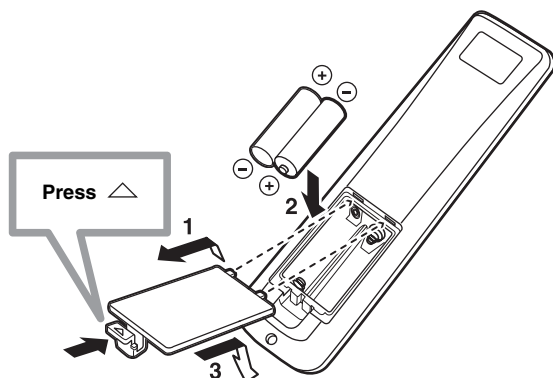

1 Press and hold the \triangle mark on the battery cover and then open the cover.

2 Insert the two supplied batteries (AA, R6, UM-3) into the battery compartment.

Make sure you insert the batteries according to the polarity markings (+/-).

3 Close the battery cover.

Notes

- Change all of the batteries if you notice the following conditions: the operation range of the remote control decreases or the transmission indicator does not light up or becomes dim.
- Do not use old batteries together with new ones.
- Do not use different types of batteries (such as alkaline and manganese batteries) together. Read the packaging carefully as these different types of batteries may have the same shape and color.
- Exhausted batteries may leak. If the batteries have leaked, dispose of them immediately. Avoid touching the leaked material or letting it come into contact with clothing, etc. Clean the battery compartment thoroughly before installing new batteries.
- Do not throw away batteries with general house waste. Dispose of them correctly in accordance with your local regulations.
- The memory stored in the remote control may be erased in the following cases:
 - The remote control is left without batteries for more than two minutes.
 - Exhausted batteries remain in the remote control.
 - The buttons on the remote control are accidentally pressed when you change batteries.
- If the memory stored in the remote control is unwantedly erased, insert new batteries and set the remote control codes again.



Remove the transparent sheet before using the remote control.

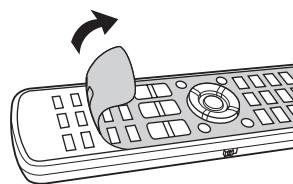

Operation range of the remote control

The remote control transmits a directional infrared beam. Use the remote control within 6 m (20 ft) of this unit and point it toward the remote control sensor of this unit during operation.

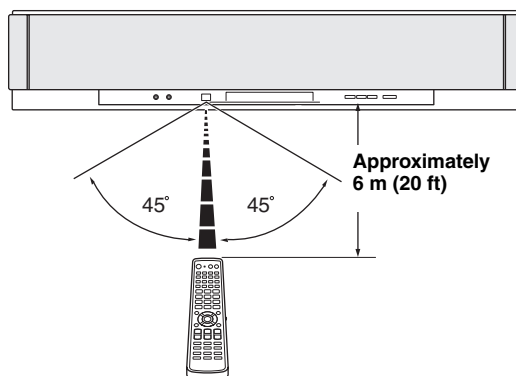

Notes

- Do not spill water or other liquids on the remote control.
- Do not drop the remote control.
- Do not leave or store the remote control in the following places:
 - places of high humidity, such as near a bath
 - places of high temperatures, such as near a heater or a stove
 - places of extremely low temperatures
 - dusty places
- Do not expose the remote control sensor of this unit to direct sunlight or lighting such as inverted fluorescent lamps.
- If the batteries grow old, the effective operation range of the remote control decreases considerably. If this happens, replace the batteries with two new ones as soon as possible.

Turning on this unit or setting it to the standby mode

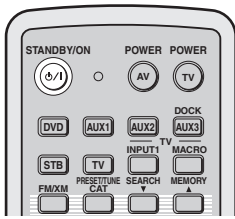
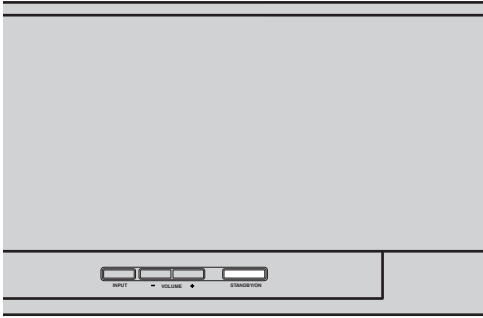

(U.S.A. and Canada models)

- 2 Press STANDBY/ON again to set this unit to the standby mode.

Note

When this unit is in the standby mode, only STANDBY/ON on the front panel or on the remote control is operational, and the other control buttons on the front panel or on the remote control are not operational until the power of this unit is turned on.

- 1 Press STANDBY/ON to turn on the power of this unit.

The volume level appears in the front panel display, and the current input source and beam mode are displayed.

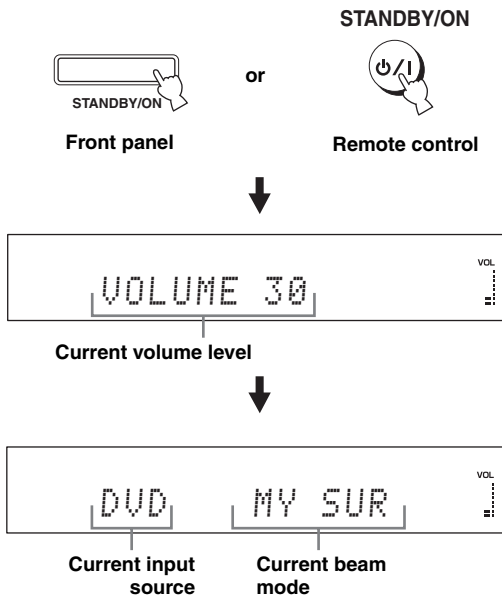

Using SET MENU

Displaying the OSD (on-screen display)

This section describes how to display the OSD (on-screen display) of this unit on your TV screen and to set the parameters for your listening room. Once this is complete, you can enjoy real surround sound while watching TV in the comfort of your own home.

1 Check that the video input jack on your TV is connected to the VIDEO OUT jack on this unit to display the OSD of this unit.

2 Press STANDBY/ON to turn on the power of this unit.

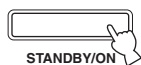

Front panel

or

STANDBY/ON



Remote control

3 Turn on the power of your TV.

The following screen appears on your TV.



OSD screen example

If the OSD does not appear, use the remote control supplied with your TV to switch the video input until the OSD appears.

The flow chart of SET MENU

The following diagram illustrates the overall flow of the setup procedure.

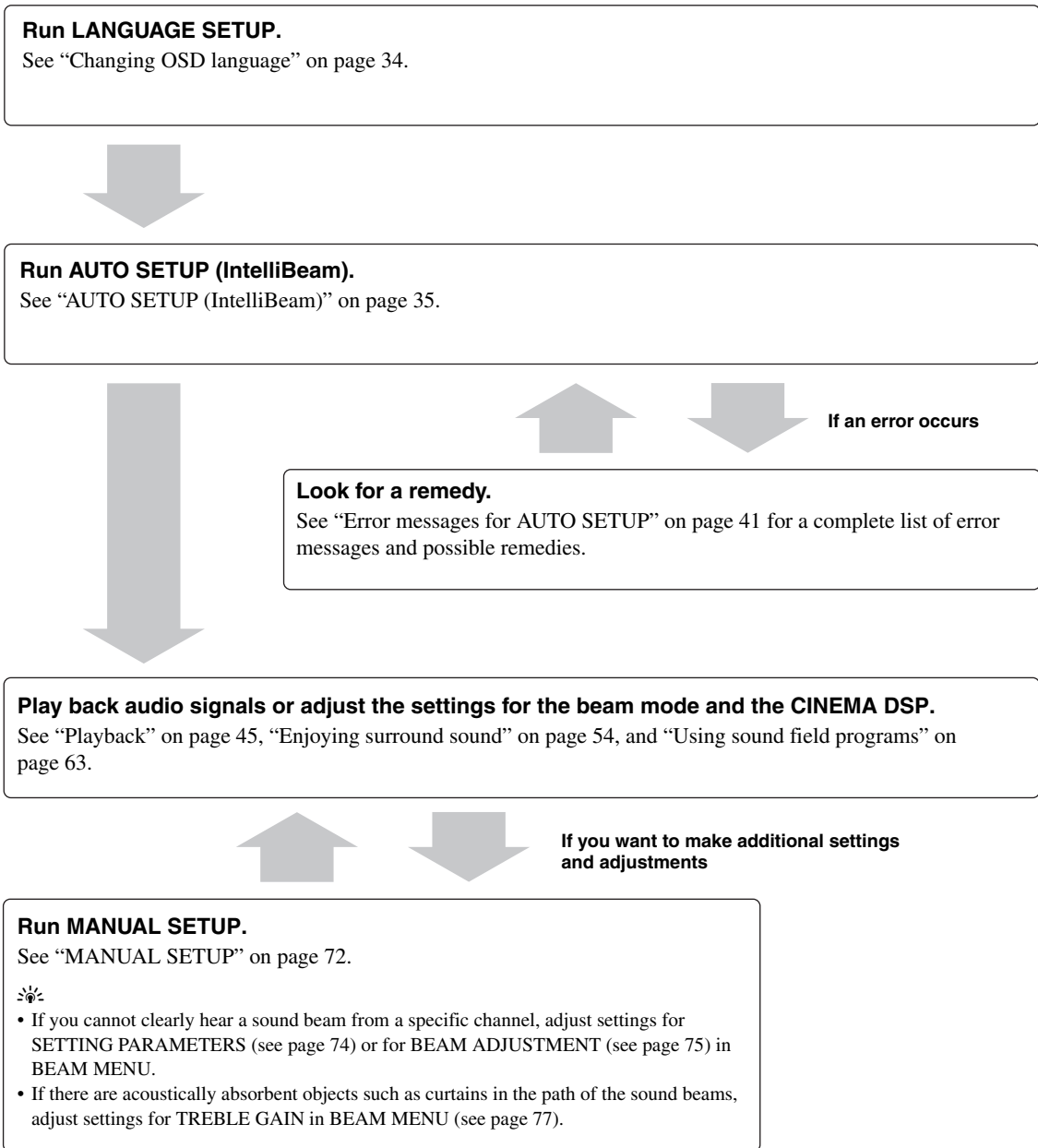

Changing OSD language

This feature allows you to select the language of your choice that appears in SET MENU of this unit.

1 Set the operation mode selector to YSP.

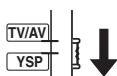

2 Press MENU.

The SET MENU screen appears on your TV.

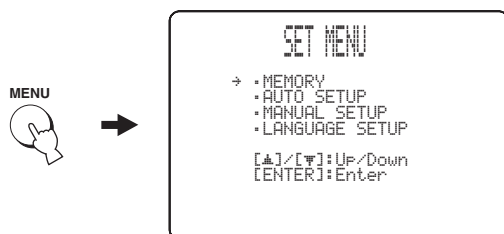

- The control buttons used for SET MENU are displayed at the bottom of the screen.
- To return to the previous screen while using SET MENU, press RETURN.
- To exit from SET MENU, press MENU once more.
- You can also perform the following operations while viewing information in the front panel display.

3 Press ▲ / ▼ to select LANGUAGE SETUP, and press ENTER.

The following screen appears on your TV.

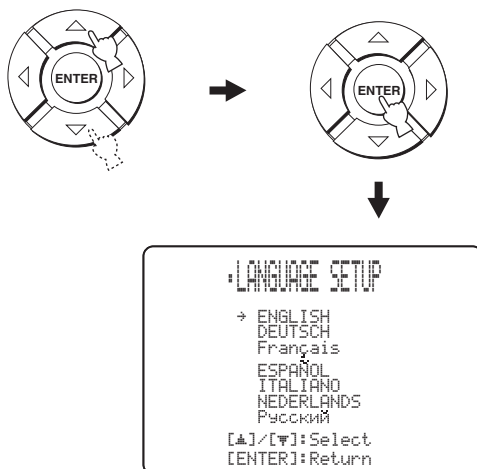

4 Press ▲ / ▼ to select the desired language, and press ENTER.

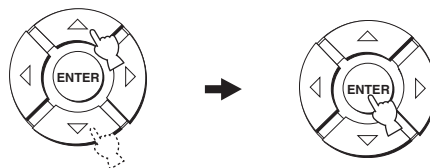

Choices: **ENGLISH** (English), **DEUTSCH** (German), **Français** (French), **ESPAÑOL** (Spanish), **ITALIANO** (Italian), **NEDERLANDS** (Dutch), **Русский** (Russian)

AUTO SETUP (IntelliBeam)

This unit creates a sound field by reflecting sound beams on the walls of your listening room and by broadening the cohesion of all the channels. Just as you would arrange the speaker position of other audio systems, you need to set the beam angle to enjoy the best possible sound from this unit.

This unit employs the beam optimization and sound optimization features with the aid of the supplied IntelliBeam microphone, allowing you to avoid troublesome listening-based setup and achieving highly accurate sound adjustments that best match your listening environment. We call these two features “**IntelliBeam**” generically.

Beam optimization:

This feature optimizes the beam angle so that the parameter best matches your listening environment.

Sound optimization:

This feature optimizes the beam delay, volume, and quality so that the parameters best match your listening environment.

The flow chart of AUTO SETUP

This unit performs a series of checks to optimize the beam angle, delay, volume, and quality. You can choose to optimize all or part of the parameters.

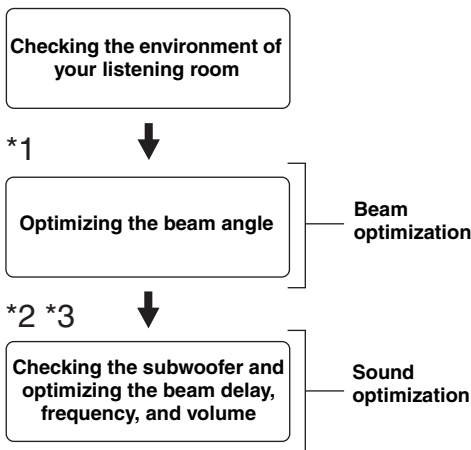

Notes

- *1 The beam angle checking procedure is skipped if SOUND OPTIMZ only is selected.
- *2 The sound optimization procedure is skipped if BEAM OPTIMZ only is selected.
- *3 The subwoofer checking procedure is skipped if BEAM OPTIMZ only is selected.

Installing the IntelliBeam microphone

The supplied IntelliBeam microphone collects and analyzes the sound that this unit produces in your actual listening environment. Follow the procedure below to connect the IntelliBeam microphone to this unit and make sure that the IntelliBeam microphone is placed in a proper location and that there are no large obstacles between the IntelliBeam microphone and the walls in your listening room.

Notes

- After you have completed the AUTO SETUP procedure, be sure to disconnect the IntelliBeam microphone.
- The IntelliBeam microphone is sensitive to heat.
 - Keep it away from direct sunlight.
 - Do not place it on top of this unit.
- Do not connect the IntelliBeam microphone to an extension cable as doing so may result in an inaccurate sound optimization.
- An error may occur during the AUTO SETUP procedure if the IntelliBeam microphone is not properly placed in your listening room. To avoid the possibility of an error:
 - Do not place the IntelliBeam microphone to the extreme right or left from the center of this unit.
 - Do not place the IntelliBeam microphone within 1.8 m (6.0 ft) from the front of this unit.
 - Do not place the IntelliBeam microphone more than 1 m (3.3 ft) upper or lower from the center height of this unit.
- Make sure that there are no obstacles between the IntelliBeam microphone and the walls in your listening room as these objects obstruct the path of sound beams. However, any objects that are in contact with the walls will be regarded as a protruding part of the walls.
- The best possible results are achieved if the IntelliBeam microphone is placed at the same height as your ears would be when you are seated in your listening position. However, if this is not possible, you can manually fine-tune the sound beam angle and balance the sound beam output levels using MANUAL SETUP (see page 72) once the AUTO SETUP procedure is completed.
- If a subwoofer with adjustable volume and crossover/high-cut frequency controls is connected to this unit, set the volume between 10 and 12 o'clock as viewed on a conventional clockface and set the crossover/high-cut frequency to the maximum.

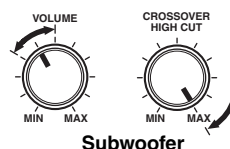

Subwoofer

1 Press STANDBY/ON to turn off the power of this unit.

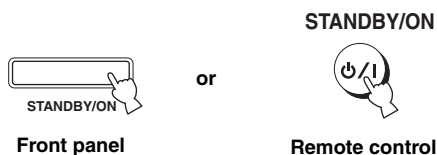

3 Place the IntelliBeam microphone on a flat level surface more than 1.8 m (6.0 ft) from the front of the unit and within 1 m (3.3 ft) upper or lower from the center height of the unit with the IntelliBeam microphone facing upward at your normal listening position.

Note

Be sure to place the IntelliBeam microphone on an imaginary center line drawn from this unit.



You may want to use the supplied cardboard microphone stand to affix the IntelliBeam microphone at the same height as your ears would be when you are seated in your listening position.

2 Connect the supplied IntelliBeam microphone to the INTELLIBEAM MIC jack on the front panel.

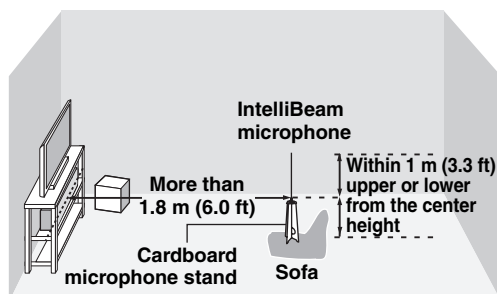
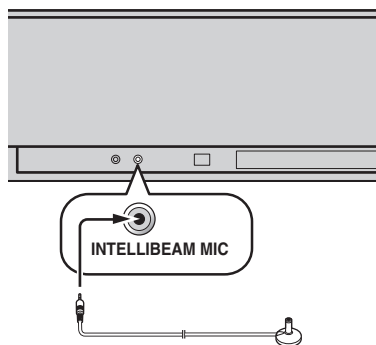

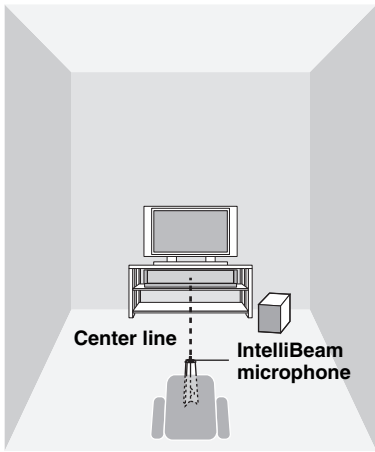

Using AUTO SETUP (IntelliBeam)

Once the IntelliBeam microphone is firmly connected to this unit and properly placed in your listening room, follow the procedure below to start the AUTO SETUP procedure.

You can also enter the AUTO SETUP procedure simply by pressing and holding AUTO SETUP for more than two seconds. In this case, this unit performs both of the beam optimization and sound optimization procedures.

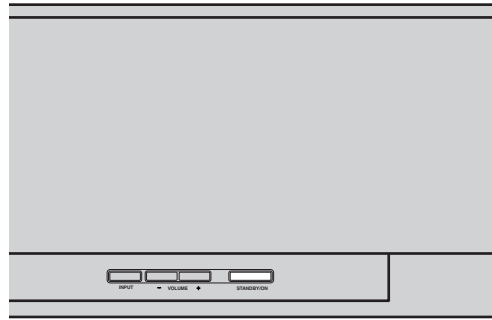

■ Assembling the supplied cardboard microphone stand

You will find three separate parts (one circular part and two longitudinal parts) of the cardboard microphone stand originally put together.

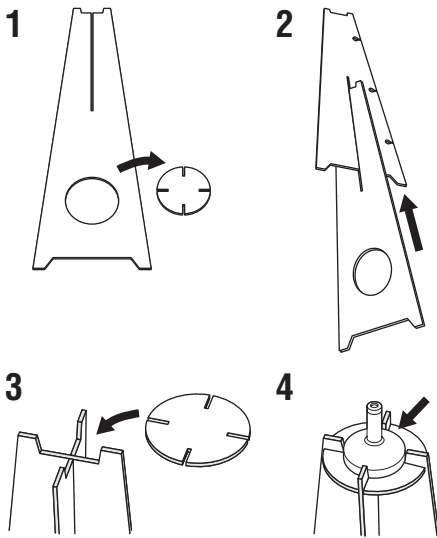

- 1** Disassemble the three parts of the cardboard microphone stand originally put together.
- 2** Insert one of the longitudinal part into the crevice of the other longitudinal part.
- 3** Place the circular part on top of the two combined longitudinal parts.
- 4** Place the supplied IntelliBeam microphone on top of the circular part.

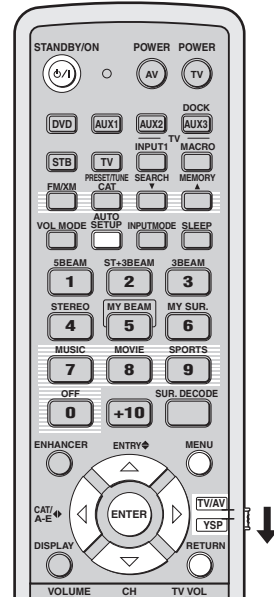

(U.S.A. and Canada models)

SETUP

English

Notes

- Make sure that your listening room is as quiet as possible while this unit is performing the AUTO SETUP procedure.
 - To achieve the best results possible, evacuate yourself from your listening room until the AUTO SETUP procedure is completed so that you may not obstruct the path of sound beams.
 - Be advised that it is normal for loud test tones to be output during the AUTO SETUP procedure.
 - The AUTO SETUP procedure may not be run successfully if this unit is installed in one of the rooms described in “Before installing this unit” on page 16. In such cases, run MANUAL SETUP (see page 72) to manually adjust the corresponding parameters.
 - If an error occurs, an error buzzer is played, the AUTO SETUP procedure stops, and an error message appears on the screen. See “Error messages for AUTO SETUP” on page 41 for appropriate remedies.
- 
- The AUTO SETUP procedure takes about three minutes maximum. A chime is played when the AUTO SETUP procedure is run successfully.
 - If there are curtains in your listening room, we recommend following the procedure below.
 1. Open the curtains to improve sound reflection.
 2. Run BEAM OPTIMZ only.
 3. Close the curtains.
 4. Run SOUND OPTIMZ only.
 - You can save the settings optimized by the AUTO SETUP procedure (see page 42). A set of settings optimized according to the specific conditions of your listening environment can be recalled later depending on the varying conditions of your listening environment (see page 43).

1 Press STANDBY/ON to turn on the power of this unit.

If a subwoofer is connected to this unit, turn on the power of the subwoofer.

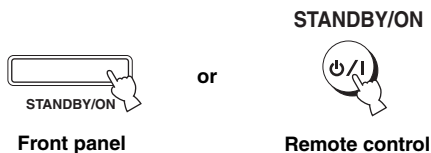

2 Set the operation mode selector to YSP.

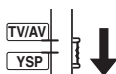

3 Press MENU.

The SET MENU screen appears on your TV.

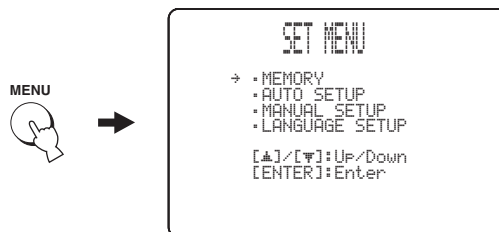

- The control buttons used for SET MENU are displayed at the bottom of the screen.
- To return to the previous screen while using SET MENU, press RETURN.
- To exit from the SET MENU screen, press MENU again.
- You can start the BEAM+SOUND OPTIMZ procedure simply by pressing and holding AUTO SETUP for more than two seconds. Steps 4 and 5 are skipped and then the screen shown in step 5 is displayed on your TV. Start the AUTO SETUP procedure from step 6.
- You can also perform the following operations in the front panel display.

4 Press \triangle / ∇ to select AUTO SETUP and press ENTER.

The following screen appears on your TV.

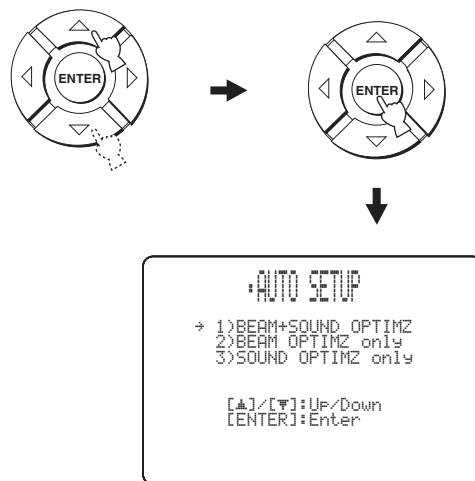

- 5 Press \triangle / ∇ to select BEAM+SOUND OPTIMZ, BEAM OPTIMZ only, or SOUND OPTIMZ only and then press ENTER.**

The following screen appears on your TV.

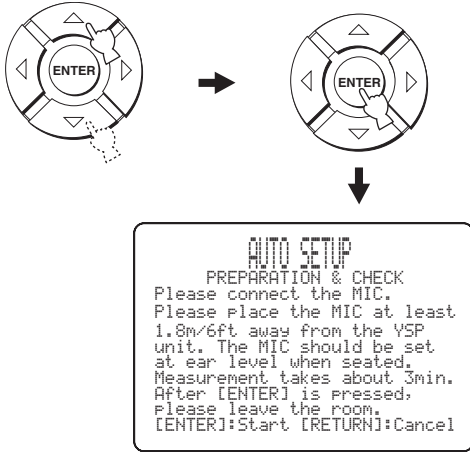

**BEAM+SOUND OPTIMZ
(Beam optimization and sound optimization)**

Use to optimize the beam angle, delay, volume, and quality so that the parameters best match your listening environment.

It is recommended that you should select this optimization feature in the following cases:

- If you make settings for the first time.
- If the unit has been relocated.
- If your listening room has been restructured.
- If the objects in your listening room (furniture, etc.) have been rearranged.

This menu takes about three minutes.

**BEAM OPTIMZ only
(Beam optimization only)**

Use to optimize the beam angle so that the parameter best matches your listening environment.

This menu takes about one minute.

**SOUND OPTIMZ only
(Sound optimization only)**

Use to optimize the beam delay, volume, and quality so that the parameters best match your listening environment.

It is recommended that you should select this optimization feature in the following cases:

- If you have opened or closed the curtains in your listening room before using this unit.
- If you have manually set the beam angle.

This menu takes about two minutes.

Note

You must optimize the beam angle in the BEAM OPTIMZ only procedure before starting the SOUND OPTIMZ only procedure.

- 6 Check the following points once again before starting the AUTO SETUP procedure.**

- Is the IntelliBeam microphone firmly connected to this unit?
- Is the IntelliBeam microphone placed in a proper location?
- Are there any large obstacles in between the IntelliBeam microphone and the walls in your listening room?

- 7 Press ENTER to start the AUTO SETUP procedure.**

The following screen appears on your TV and the AUTO SETUP procedure starts in 10 seconds.

Leave the room quietly before starting the AUTO SETUP procedure.

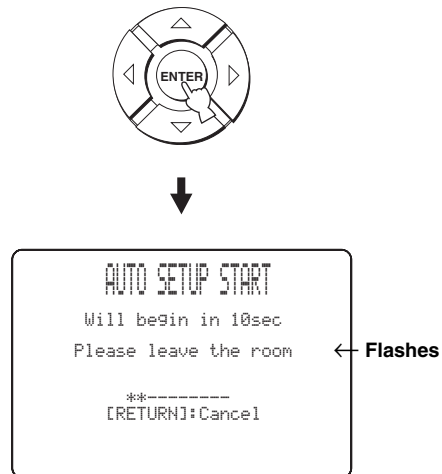

If an error occurs, an error buzzer is played and an error message is displayed. See “Error messages for AUTO SETUP” on page 41 for a complete list of error messages and their proper remedies. Follow the instructions and perform the AUTO SETUP procedure again.

SETUP

English

8 Check that the following screen is displayed on your TV.

The results of the AUTO SETUP procedure are displayed on your TV.

Example 1

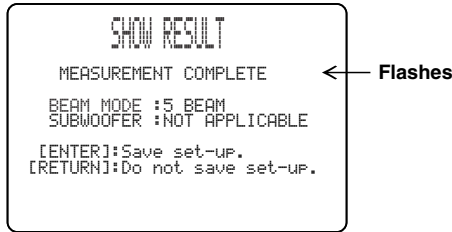

Example 2

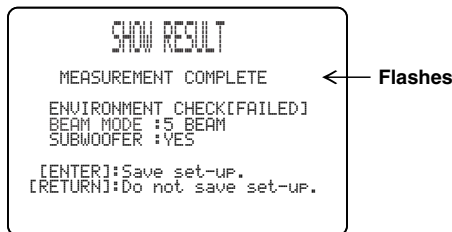

- If “ENVIRONMENT CHECK [FAILED]” is displayed, we recommend running the AUTO SETUP procedure again. For details, see step 9.
- If “SUBWOOFER : NOT APPLICABLE” is displayed even though a subwoofer is connected to this unit, increase the volume level of the subwoofer and run the AUTO SETUP procedure again.
- Depending on the environment of your listening room, the beam angle of front left and right, and surround left and right may be set to the same value even if “5 BEAM” is displayed as a result.

9 Press ENTER to confirm the results or press RETURN to cancel the results.

The following screen is displayed for two seconds and then disappears from your TV.

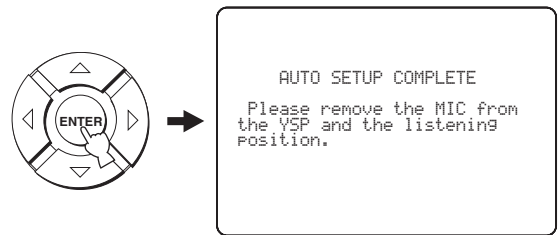

If “ENVIRONMENT CHECK [FAILED]” is displayed in step 8, the following screen is displayed after pressing ENTER. In this case, see ERROR E-1 in “Error messages for AUTO SETUP” on page 41. Press ENTER to exit AUTO SETUP and then run the procedure again from step 3.



10 Disconnect the IntelliBeam microphone from the INTELLIBEAM MIC jack on the front panel.

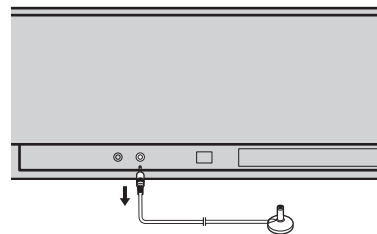

If you want to save and load settings, see “Using the system memory” on page 42.

■ Error messages for AUTO SETUP

Before the AUTO SETUP procedure starts

Error message	Cause	Remedy	See page
ERROR E-2 No MIC detected. Please check MIC connection and re-try.	The IntelliBeam microphone is not connected to this unit.	Connect the IntelliBeam microphone to this unit.	36

While the AUTO SETUP procedure is in progress

If one of the errors listed below except E-1 is displayed, press RETURN. In case you have started the AUTO SETUP procedure by pressing AUTO SETUP in step 3, run the procedure again from step 3 after the screen disappears. In case you have started the AUTO SETUP procedure by pressing MENU in step 3, run the procedure again from step 4 after the screen in step 3 is displayed. Run MANUAL SETUP if the problem is difficult to be saved.

Error message	Cause	Remedy	See page
ERROR E-1 Please test in quieter environment.	There is too much unwanted noise in your listening room.	Make sure that your listening room is as quiet as possible. You may want to choose certain hours during the day when there is not much noise coming from outside.	—
ERROR E-2 No MIC detected. Please check MIC connection and re-try.	The IntelliBeam microphone was disconnected while the AUTO SETUP procedure was in progress.	Make sure that the IntelliBeam microphone is firmly connected to this unit.	36
ERROR E-3 Unexpected control is detected. Please re-try.	Some other operations were performed on this unit while the AUTO SETUP procedure was in progress.	Do not perform any other operations while the AUTO SETUP procedure is in progress.	—
ERROR E-4 Please check MIC position. MIC should be set in front of YSP.	The IntelliBeam microphone is not placed in front of this unit.	Make sure that the IntelliBeam microphone is installed in front of this unit.	36
ERROR E-5 Please check MIC position. MIC should be set above 1.8m/6.0ft.	The IntelliBeam microphone is not placed in the right distance from this unit.	Make sure that the IntelliBeam microphone is installed more than 1.8 m (6.0 ft) from the front of this unit and within 1 m (3.3 ft) from the center height of this unit.	36
ERROR E-6 Volume level is lower than expected. Please check MIC position/connection and re-try.	The IntelliBeam microphone cannot collect the sound produced by this unit because the sound output level is too low.	Make sure that the IntelliBeam microphone is firmly connected to this unit and placed in a proper location. If the problem persists, contact the nearest authorized Yamaha service center for assistance.	36
ERROR E-7 Unexpected error happened. Please re-try.	An internal system error occurred.	Repeat the AUTO SETUP procedure.	—

SETUP

English

Using the system memory

Convenient usage of the system memory

You can save the current settings adjusted in SET MENU in the system memory of this unit. It is handy to save certain settings according to the varying conditions of your listening environment. For example, if there are curtains in the path of sound beams, the effectiveness of the sound beams will vary depending on whether the curtains are open or closed.

When the curtains are open

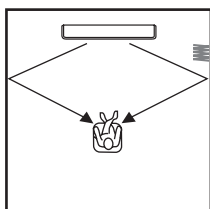

When the curtains are closed

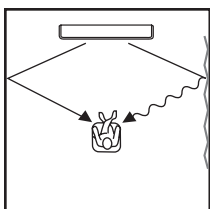

3 Press \triangle / ∇ to select MEMORY and press ENTER.

The following screen appears on your TV.

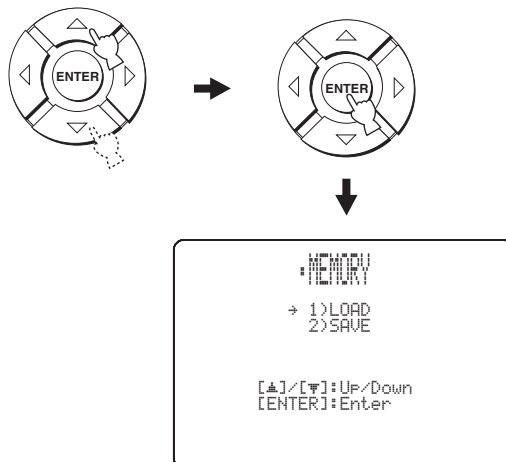

Saving settings

1 Set the operation mode selector to YSP.

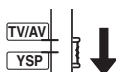

2 Press MENU.

The SET MENU screen appears on your TV.



4 Press \triangle / ∇ to select SAVE and press ENTER.

The following screen appears on your TV.

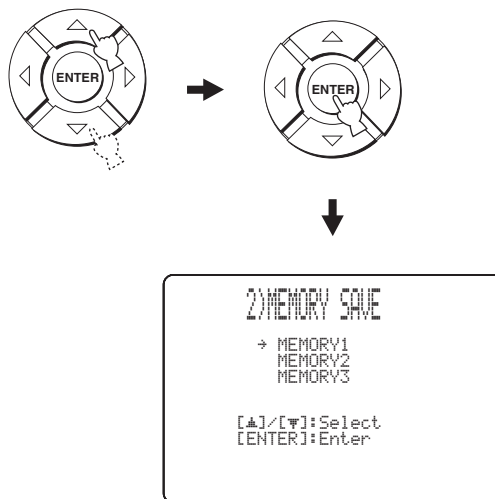

- The control buttons used for SET MENU are displayed at the bottom of the screen.
- To return to the previous screen while using SET MENU, press RETURN.
- To exit from the SET MENU screen, press MENU once more.
- You can also perform the following operations in the front panel display.

- 5 Press \triangle / ∇ to select MEMORY1, MEMORY2, or MEMORY3 and press ENTER.**
The following screen appears on your TV.

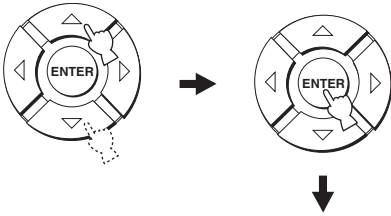

- 6 Press ENTER again.**

The new parameters are saved as MEMORY1, MEMORY2, or MEMORY3. Once the parameters are saved, the display returns to the SET MENU screen.

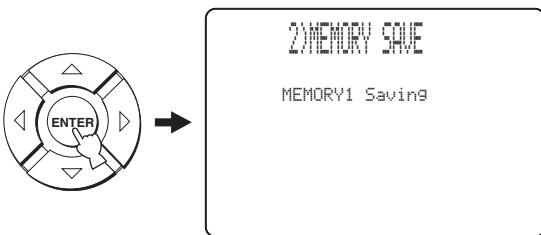

- 7 Press MENU to exit.**

The SET MENU screen disappears from your TV.



Loading settings

You can recall the settings saved in “Saving settings” on page 42 according to the varying conditions of your listening environment.

- 1 Set the operation mode selector to YSP.**

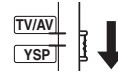

- 2 Press MENU.**

The SET MENU screen appears on your TV.

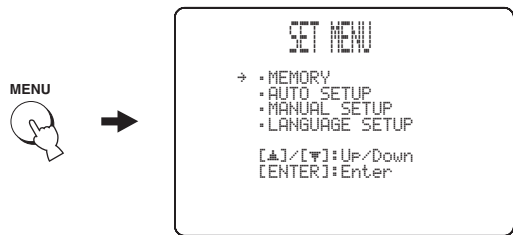

- The control buttons used for SET MENU are displayed at the bottom of the screen.
- To return to the previous screen while using SET MENU, press RETURN.
- To exit from the SET MENU screen, press MENU once more.
- You can also perform the following operations in the front panel display.

- 3 Press \triangle / ∇ to select MEMORY and press ENTER.**

The following screen appears on your TV.

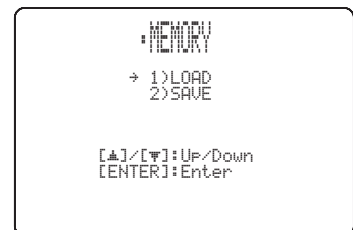
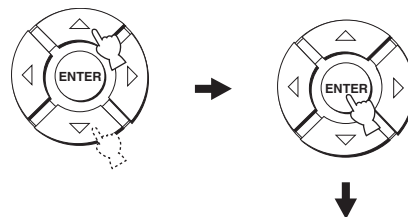

4 Press \triangle / ∇ to select LOAD and press ENTER.

The following screen appears on your TV.

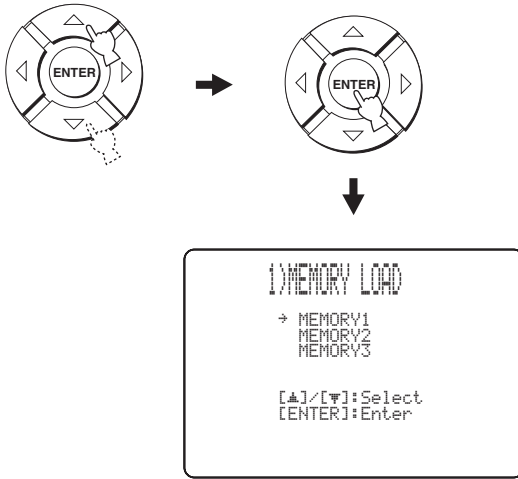

5 Press \triangle / ∇ to select MEMORY1, MEMORY2, or MEMORY3 and press ENTER.

The following screen appears on your TV.

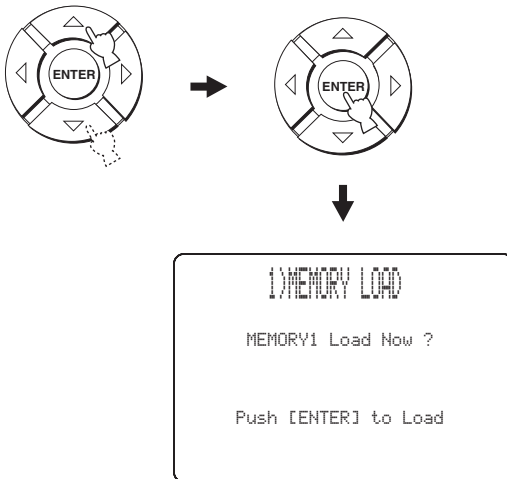

6 Press ENTER again.

The new parameters saved as MEMORY1, MEMORY2, or MEMORY3 are loaded. Once the parameters are loaded, the display returns to the SET MENU screen.

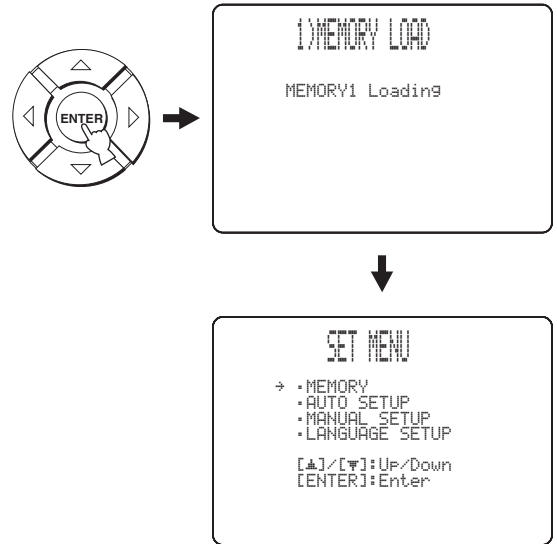

7 Press MENU to exit.

The SET MENU screen disappears from your TV.



Playback

Selecting the input source

You can play back sound from the components connected to this unit simply by pressing INPUT on the front panel repeatedly or pressing one of the input selector buttons (TV, STB, DVD, AUX1, AUX2, or AUX3) on the remote control. The name of the selected input source and the type of corresponding input mode appear in the front panel display.

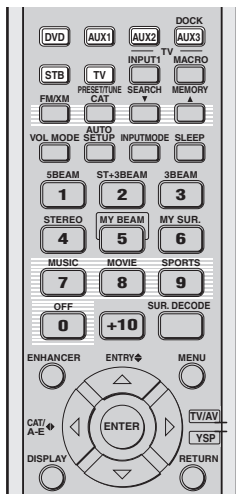

(U.S.A. and Canada models)

■ Front panel operations

Press **INPUT** on the front panel repeatedly to toggle between **TV, STB, DVD, AUX1, AUX2, and AUX3**.

The name of the corresponding input source and the type of current input mode are displayed in the front panel display.

■ Remote control operations



In addition to controlling this unit, you can also operate other AV components if you set up the remote control with the appropriate remote control codes and set the operation mode selector to TV/AV to change the control area (see page 96).

Press **TV** to play back a TV program.

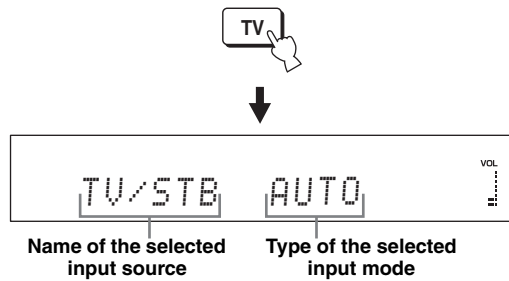

Press **STB** to play back a satellite broadcast.

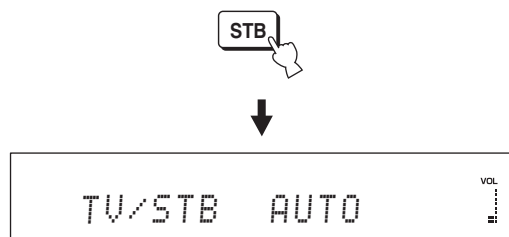

Press **DVD** to play back a DVD.

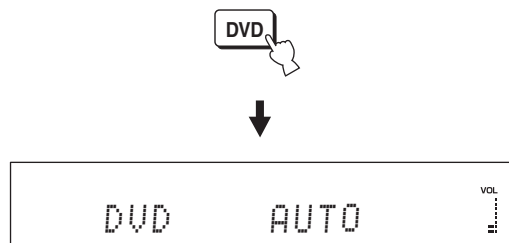

Press **AUX1** (or **AUX2**) to play back a component connected to the **AUX 1** (or **AUX 2**) jack on the rear panel of this unit.

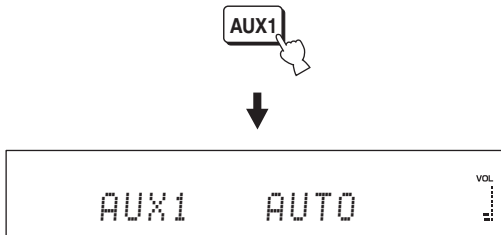

Press **AUX3** to play back a component connected to the **AUX 3** input jack on the front panel.

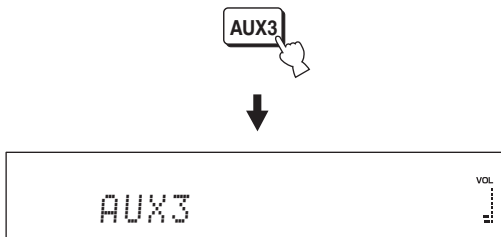

Playing back sources

Once an input source is selected (see page 45), you can play back the selected input source.

Note

This section uses a DVD player as an example of the playback source.



For details on your TV and DVD player, refer to the respective owner's manual.

- 2 Switch to the video input on your TV using the remote control supplied with the TV and display the DVD menu screen.

Note

If necessary, turn down the volume of your TV until no sound is heard.

- 3 Press **DVD** to select DVD as the input source.



- 4 Play back DVD on your DVD player using the supplied remote control.

Audio signals from your DVD player are output from this unit.



- You can use the supplied demonstration DVD to check the digital signals being input at the DVD player with the digital connection (optical/coaxial/HDMI). The input channel and LFE indicators light up when this unit detects the 5.1-channel signal input at the optical/coaxial/HDMI jack. If the **PCM** indicator lights up, confirm the settings of the digital output, bitstream output, DTS output, and/or HDMI output of the DVD player.
- If the output volume is too low, increase the volume of this unit to around 45.
- If you have set the appropriate remote control codes for your TV and DVD player, you can use the remote control supplied with this unit to operate these components. For details on how to set remote control codes, see page 96.

- 1 Turn on the power of your DVD player.

Adjusting the volume

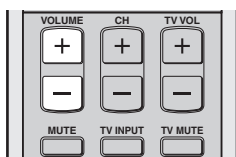
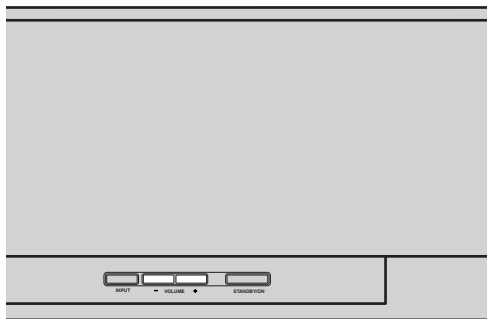

Press **VOLUME +/-** to increase or decrease the volume level.

The numeric value of the volume level appears in the front panel display.

Control range: MIN (minimum), 01 to 99, MAX (maximum)

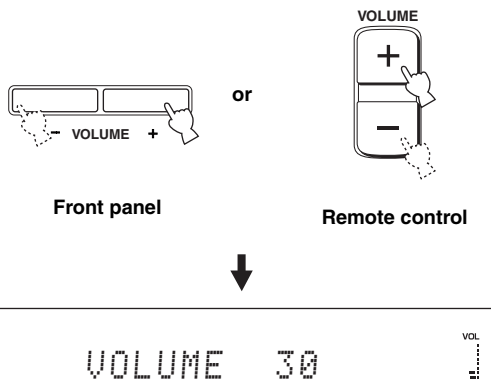

Notes

- The volume level of all input sources (including multi-channel as well as stereo sources) changes at the same time.
- One volume level increases or decreases each time you press VOLUME +/-.
- You can continuously increase or decrease the volume level if you press and hold VOLUME +/-.

Muting the sound

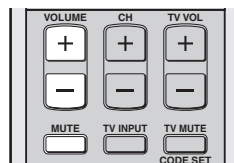

1 Press MUTE to mute the sound.

“AUDIO MUTE ON” appears in the front panel display, and the volume level indicator flashes.

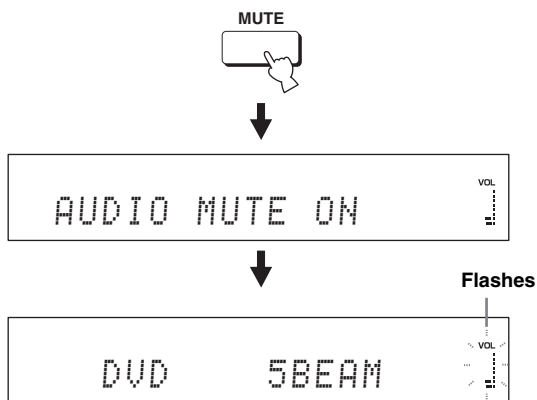

2 Press MUTE again (or press VOLUME +/-) to resume the sound output.

“AUDIO MUTE OFF” appears temporarily in the front panel display (or the numeric value of the current volume level appears if you press VOLUME +/-), and the volume level indicator lights up.

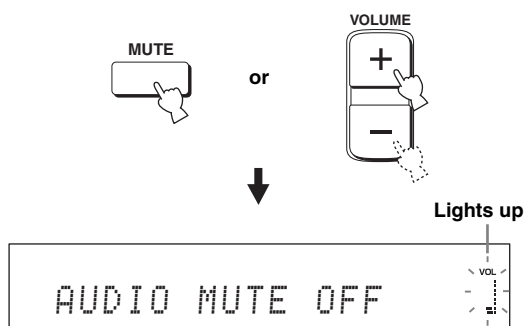

Note

The sound output of all input sources (including multi-channel as well as stereo sources) is muted at the same time.



You can select whether the sound output is to be muted completely or by 20 dB when you press MUTE (see page 78).

FM tuning

There are two tuning methods: automatic and manual. Automatic tuning is effective when the radio signal is strong and there is no interference. If the radio signal is weak, tune into the FM station manually. You can also use the automatic and manual preset tuning features to store up to 40 stations in total (A1 to E8: 5 preset station groups with 8 preset station numbers each).



- This section exceptionally uses the remote control for Europe, Australia, Asia, and Korea models.
- When the operation mode selector is set to TV/AV, you can operate all FM functions. When the operation mode selector is set to YSP, you can only operate the functions described in “Selecting a preset station” (see page 52).

Note

Orient the connected FM antenna for the best reception.

FM controls and functions

Remote control functions

Set the operation mode selector (⑧) to TV/AV before tuning or preset tuning.

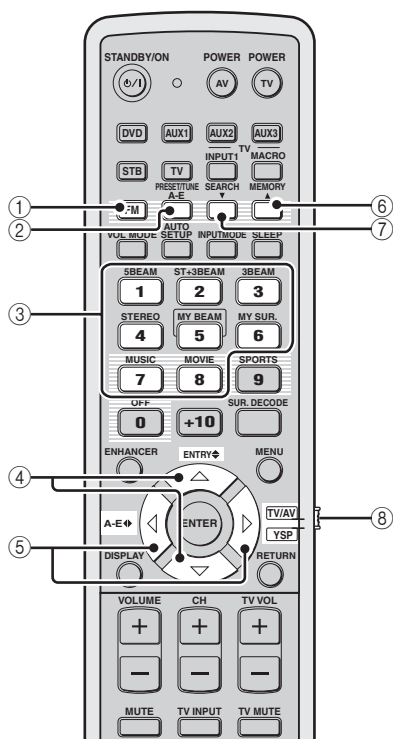

(Europe, Australia, Asia, and Korea models)

① FM

Selects FM as the input source. This unit is tuned into the last selected FM station.



U.S.A. and Canada models use FM/XM.

② PRESET/TUNE

Switches between the preset search mode and the frequency search mode (see page 51).

③ Numeric buttons

Use numbers 1 through 8 to select the preset station numbers (see page 52).

④ ENTRY $\blacktriangleleft/\blacktriangleright$

- Selects the preset station numbers (1 to 8) when the colon (:) is displayed in the front panel display (see page 52).
- Selects the tuning frequency when the colon (:) is not displayed in the front panel display (see page 49).

⑤ A-E $\blacktriangleleft/\blacktriangleright$

Selects the preset station groups (A to E) (see page 51).



U.S.A. and Canada models use CAT/A-E $\blacktriangleleft/\blacktriangleright$.

⑥ MEMORY

- Stores a preset station in the memory (see page 51).
- Hold down this button for more than three seconds to start automatic preset tuning (see page 50).

⑦ SEARCH

Switches between automatic tuning (the AUTO indicator is turned on) and manual tuning (the AUTO indicator is turned off) (see page 49).

⑧ Operation mode selector

Selects the operation mode of this unit.

Automatic tuning

Automatic tuning is effective when the radio station signals are strong and there is no interference.

1 Set the operation mode selector to TV/AV.

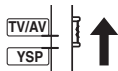

2 Press FM to select FM as the input source.

“FM” appears in the front panel display.



- You can also press INPUT on the front panel repeatedly to select FM as the input source.
- If “XM” appears in the front panel display, press FM/XM again to display “FM” (U.S.A. and Canada models only).

3 Press SEARCH repeatedly until the AUTO indicator lights up in the front panel display.



Lights up

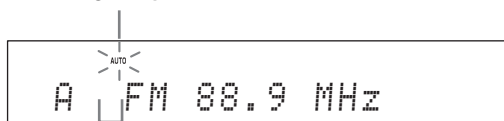

No colon (:)

If a colon (:) appears in the front panel display, tuning is not available. Press PRESET/TUNE to turn the colon (:) off.

4 Press ENTRY \diamond (\triangle / ∇) once to begin automatic tuning.

When this unit is tuned into an FM station, the TUNED indicator lights up and the frequency of the station appears in the front panel display.

- Press \triangle to tune into a higher frequency.
- Press ∇ to tune into a lower frequency.



Manual tuning

If the desired FM station signal is weak, tune into it manually.

Note

Manual tuning automatically switches the tuner to the monaural reception mode to increase the signal quality.

1 Set the operation mode selector to TV/AV.

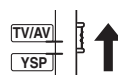

2 Press FM to select FM as the input source.

“FM” appears in the front panel display.



- You can also press INPUT on the front panel repeatedly to select FM as the input source.
- If “XM” appears in the front panel display, press FM/XM again to display “FM” (U.S.A. and Canada models only).

- 3 Press **SEARCH** repeatedly until the **AUTO** indicator disappears from the front panel display.

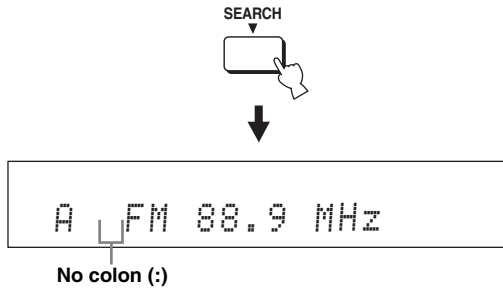

If a colon (:) appears in the front panel display, tuning is not available. Press **PRESET/TUNE** to turn the colon (:) off.

- 4 Press **ENTRY** (▲/▼) to tune into the desired station manually.



 Hold down the button for quick search.

Automatic preset tuning

You can use the automatic preset tuning feature to store up to 40 FM stations with strong signals (A1 to E8: 5 preset station groups with 8 preset station numbers each). You can recall the preset stations easily by selecting the preset station groups and numbers.

- 1 Set the operation mode selector to **TV/AV**.

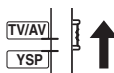

- 2 Press **FM** to select **FM** as the input source. “FM” appears in the front panel display.



- You can also press **INPUT** on the front panel repeatedly to select **FM** as the input source.
- If “**XM**” appears in the front panel display, press **FM/XM** again to display “**FM**” (U.S.A. and Canada models only).

- 3 Press and hold **MEMORY** for more than three seconds.

The preset station group and number, the **MEMORY** indicator, and the **AUTO** indicator flash. Automatic preset tuning starts from the current frequency and proceeds toward higher frequencies.

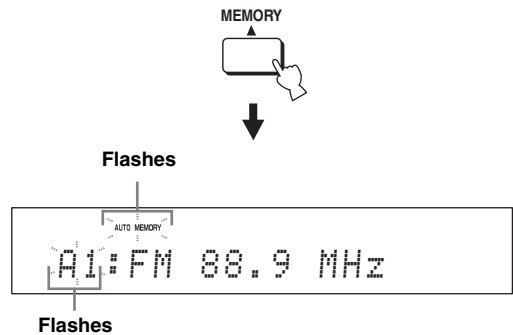

When automatic preset tuning is completed, the front panel display shows the frequency of the last preset station.

Notes

- When you overwrite an existing preset station, the previously stored FM station is cleared.
- If the number of automatically preset stations does not reach 40 (E8), this unit automatically stops searching.
- Only FM stations with sufficient signal strength are preset automatically. If the desired station is weak in signal strength, tune into it manually and store it as described in “Manual preset tuning” on page 51.

Manual preset tuning

You can also store up to 40 stations (A1 to E8: 5 preset station groups with 8 preset station numbers each) manually.

1 Set the operation mode selector to TV/AV.

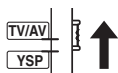

2 Tune into the desired FM station.

See page 49 for tuning instructions.

3 Press MEMORY.

The MEMORY indicator flashes in the front panel display for approximately 10 seconds.

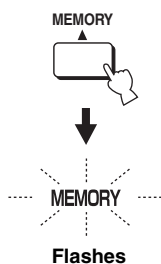

4 Press A-E ◀ (◀/▶) repeatedly to select a preset station group (A to E) while the MEMORY indicator is flashing.

The selected preset station group letter appears. Check that the colon (:) appears in the front panel display.

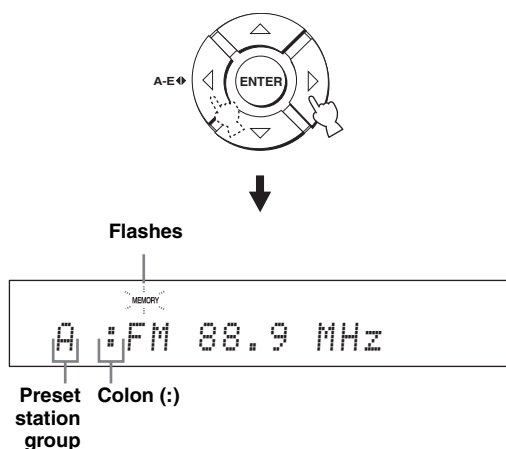

- If the colon (:) does not appear, press PRESET/TUNE to display the colon.
- U.S.A. and Canada models use CAT/A-E ◀.
- Even when the operation mode selector is set to YSP, you can select the desired preset group by pressing A-E (CAT for U.S.A. and Canada models).

5 Press ENTRY ◀ (▲/▼) to select a preset station number (1 to 8) while the MEMORY indicator is flashing.

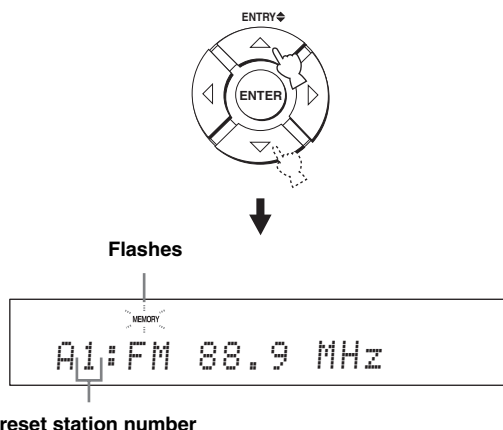

- You can also use the numeric buttons to select the desired preset station number.
- Even when the operation mode selector is set to YSP, you can select the desired preset number by pressing ▲/▼.

6 Press MEMORY while the MEMORY indicator is flashing.

The preset station group and number appear in the front panel display together with the station band and frequency. The MEMORY indicator disappears from the front panel display.

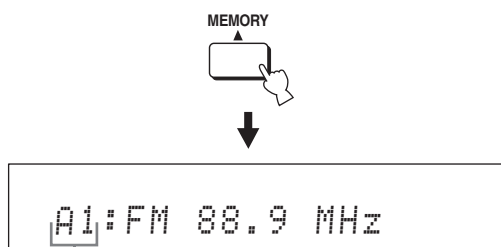

The displayed station has been stored as A1.

Notes

- When you overwrite an existing preset station, the previously stored FM station is cleared.
- The reception mode (stereo or monaural) is stored along with the station frequency.

Selecting a preset station

You can tune into the preset stations simply by selecting the preset station groups and numbers.

1 Set the operation mode selector to TV/AV.

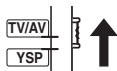

2 Press FM to select FM as the input source.

“FM” appears in the front panel display.



- You can also press INPUT on the front panel repeatedly to select FM as the input source.
- If “XM” appears in the front panel display, press FM/XM again to display “FM” (U.S.A. and Canada models only).

3 Press A-E ◀ (◀/▶) to select the desired preset station group (A to E).

The preset station group letter appears in the front panel display and changes each time you press the button.

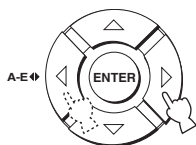

- If the colon (:) does not appear, press PRESET/TUNE to display the colon.
- U.S.A. and Canada models use CAT/A-E ◀.
- Even when the operation mode selector is set to YSP, you can select the desired preset group by pressing A-E (CAT for U.S.A. and Canada models).

4 Press ENTRY ◀ (△/▽) to select the desired preset station number (1 to 8).

The preset station group and number appear in the front panel display together with the station band and frequency.



A1:FM 88.9 MHz



- You can also use the numeric buttons to select the desired preset station number.
- Even when the operation mode selector is set to YSP, you can select the desired preset number by pressing △/▽.

Displaying the Radio Data System information (Europe model only)

Radio Data System is a data transmission system used by FM stations. You can display the four types of the Radio Data System information: PS (program service), PTY (program type), RT (radio text), and CT (clock time). The corresponding indicators light up in the front panel display.

Notes

- You can select the Radio Data System display modes only when the corresponding Radio Data System indicators are lit in the front panel display. It may take a while for this unit to receive all of the Radio Data System data from the station.
- If the signals being received are not strong enough, this unit may not be able to utilize the Radio Data System data. In particular, the “RT” mode requires a large amount of data and may not be available even when the other Radio Data System display modes are available.
- In case of poor reception conditions, tune into the desired station manually (see page 49).
- In case the signal strength is weakened by external interference while this unit is receiving the Radio Data System data, the reception may be cut off unexpectedly and “...WAIT” appears in the front panel display.
- If the reception is cut off when the “CT” mode is selected, “CT WAIT” appears in the front panel display.

1 Tune into the desired Radio Data System broadcasting station.

We recommend automatic preset tuning to tune into the Radio Data System broadcasting stations (see page 50).

Note

The AUTO PS feature of this unit changes the frequency display to the “PS” mode if the Radio Data System station broadcasts the PS data.

2 Press DISPLAY repeatedly to select the desired Radio Data System display mode.

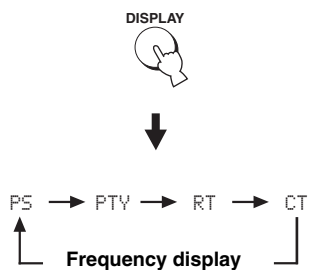

- Select “PS” to display the name of the Radio Data System program.
- Select “PTY” to display the type of Radio Data System program.
- Select “RT” to display the information on the Radio Data System program.
- Select “CT” to display the current time.

Note

In the “RT” mode, this unit can scroll the display with a maximum of 64 alphanumeric characters, including the umlaut symbol. Unavailable characters are displayed with the “_” (underscore).

Program type	Descriptions
NEWS	News
AFFAIRS	Current affairs
INFO	General information
SPORT	Sport
EDUCATE	Education
DRAMA	Drama
CULTURE	Culture
SCIENCE	Science
VARIED	Light entertainment
POP M	Pop music
ROCK M	Rock music
M.O.R.M	Middle-of-the-road music
LIGHT M	Light classical
CLASSICS	Serious classical
OTHER M	Other music

Enjoying surround sound

You can enjoy multi-channel surround sound by changing the beam mode using the beam mode buttons on the remote control. Select 5 Beam, Stereo plus 3 Beam, 3 Beam, or My Surround for multi-channel playback.

Notes

- When ANGLE TO WALL OR CORNER is set in MANUAL SETUP (see page 74), 5 Beam and 3 Beam cannot be selected.
- To enjoy 5 Beam, Stereo plus 3 Beam, or 3 Beam as the beam mode, you must perform AUTO SETUP or MANUAL SETUP so that the parameters best match your listening environment.

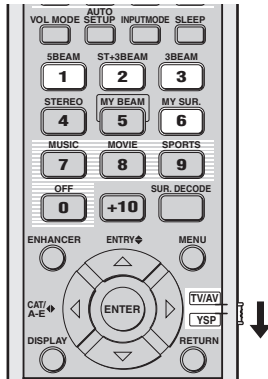

(U.S.A. and Canada models)

1 Set the operation mode selector to YSP.

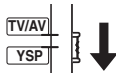

2 Press one of the beam mode buttons (5BEAM, ST+3BEAM, 3BEAM, or MY SUR.) to select the desired beam mode for 5.1-channel play back.

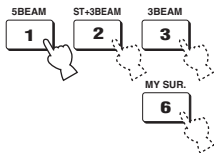

5 Beam

Outputs sound beams from the front left, front right, center, surround left, and surround right channels. This mode is ideal for enjoying surround sound effects to the fullest when you watch DVDs recorded in a multi-channel format or play back 2-channel sources in a multi-channel format.

Press 5BEAM to select 5 Beam.

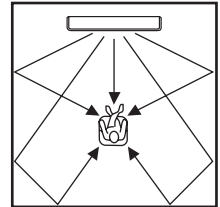

Notes

- To achieve the best surround sound effect, make sure that there are no obstacles placed in the path of sound beams in that the objects may prevent the sound beams from rebounding directly off the walls in your listening room.
- The front left and right sound beams are output toward the walls in your listening room.
- “SP Pos. Corner!” appears in the front panel display if INSTALLED POSITION is set to ANGLE TO WALL OR CORNER (see page 74).

Stereo plus 3 Beam

Outputs normal sound from the front left and right channels and sound beams from the center and surround left and right channels. This mode is ideal for watching live recordings on a DVD. Vocals and instrumental sounds can be heard close to the center of the listening position while sound reflections from the venue itself can be heard on your right and left, giving you the feeling that you are sitting right in front of the stage.

Press **ST+3BEAM** to select Stereo plus 3 Beam.

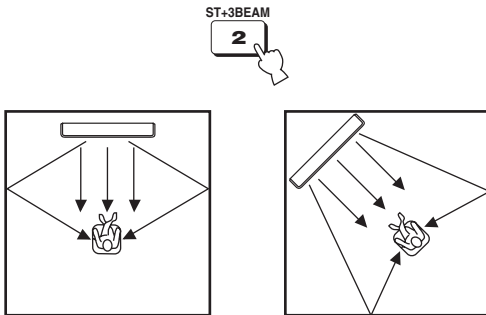

Note

The front left and right sound beams are output directly toward the listening position.

3 Beam

Outputs sound beams from the front left and right and center channels. This mode is ideal for enjoying movies with the whole family. Because the listening position area is widened, you can enjoy excellent quality surround sound over a wider area. In addition, you can use this mode when the listening position is close to the backside of the wall, and the surround left and right sound beams cannot be reflected off the wall.

Press **3BEAM** to select 3 Beam.

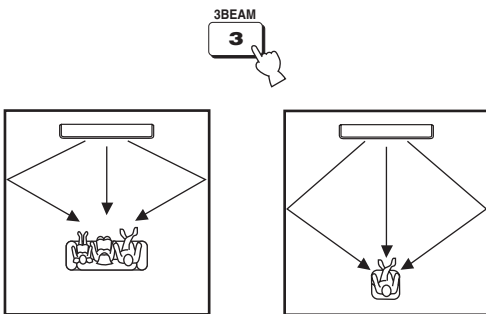

You can achieve a more realistic surround effect if you adjust settings for **IMAGE LOCATION** in **BEAM MENU** (see page 77).

Notes

- When you play back multi-channel sources, surround left and right signals are mixed down and output from the front left and right channels.
- The front left and right sound beams are output toward the walls in your listening room.
- “SP Pos. Corner!” appears in the front panel display if **INSTALLED POSITION** is set to **ANGLE TO WALL OR CORNER** (see page 74).

My Surround

This mode enables surround system in a small listening area which may not fulfill the listening room conditions for other beam modes (see “Before installing this unit” on page 16). Use this beam mode when you want to enjoy surround sound near this unit, or when the other beam modes are unavailable.

Press **MY SUR.** to select My Surround.

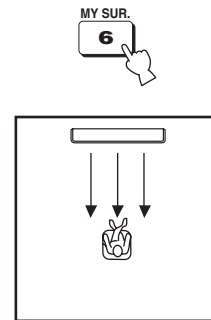

Notes

- Beam mode settings such as beam angles and distances are ineffective in this mode.
- For the full effect of My Surround, your listening position must face toward the front of this unit.

Decoder indicators

Depending on the input source and the selected surround mode, the decoder indicators in the front panel display light up as follows:

Status	Indicator
When PCM signals are being input	PCM
When DTS digital signals are being input	dts
When DTS Neo:6 is selected as the surround mode	dts + Neo:6
When Dolby Digital signals are being input	DIGITAL
When Dolby Pro Logic is selected as the surround mode	PL
When Dolby Pro Logic II is selected as the surround mode	PL II



- You can select an input mode (AUTO, DTS, or ANALOG) by pressing INPUTMODE repeatedly (see page 87).
- Discs encoded in DTS-ES, Dolby Digital 5.1 EX, Dolby Digital EX, or Dolby Digital Surround EX will be played back in DTS or Dolby Digital.

Input channel indicators

Depending on the channel component of the current digital input signal, the input channel indicators in the front panel display light up as follows:

Status	Indicator
When 2-channel stereo signals are being input	L R
When 5.1-channel signals are being input	L C R SL SR LFE

Surround modes and recommended sources

Surround mode		Recommended source
Dolby Pro Logic	–	All sources
Dolby Pro Logic II	Movie Music Game	Movies Music Games
DTS Neo:6	Cinema Music	Movies Music
Neural Surround (U.S.A. and Canada models only)	–	XM Satellite Radio (U.S.A. and Canada models only)

Notes

- When you select an input source (see page 45), the surround mode used for the previously selected input source is automatically selected.
- If the power of this unit is turned off and on again, the surround mode used for the previously selected input source before the power was turned off is automatically selected.
- If the surround modes are not available, “Prohibit” appears in the front panel display when you press SUR. DECODE.
- The surround modes are available:
 - when the beam mode is set to a setting other than the 2-channel or 5-channel stereo playback (see page 60) and My Surround (see page 55).
 - when the CINEMA DSP programs are turned off (see page 65).
 - when the movie program is selected as the CINEMA DSP program (see page 64). In this case, only Dolby Pro Logic, Dolby Pro Logic II Movie, and DTS Neo:6 Cinema are available.
 - when 2-channel signals are being input.
 - when the Music Enhancer is turned off (see page 66).

Enjoying 2-channel sources in surround sound

This unit can decode 2-channel sources for 5.1-channel playback so that you can enjoy a variety of surround sound effects by switching the surround mode.



The surround modes are available only when the CINEMA DSP programs are turned off (see page 65) or when the movie program is selected as the CINEMA DSP program (see page 64). In addition, the beam mode must be set to 5 Beam, Stereo plus 3 Beam, or 3 Beam (see page 54), while the Music Enhancer must be also turned off (see page 66).

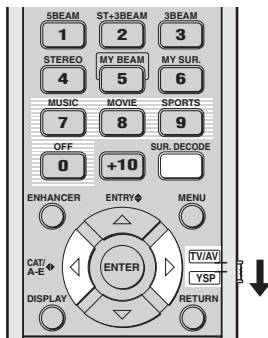

(U.S.A. and Canada models)

1 Set the operation mode selector to YSP.

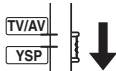

2 Press SUR. DECODE repeatedly (or press SUR. DECODE and then press $\triangleleft/\triangleright$) to switch between surround modes.

Choices: Neo:6 Cinema, Neo:6 Music, PRO LOGIC, PLII Movie, PLII Music, PLII Game, neural surround
Default setting: Neo:6 Cinema



or

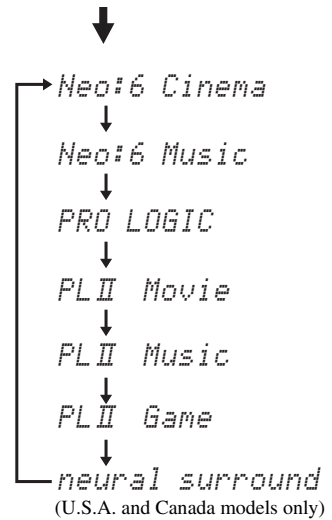
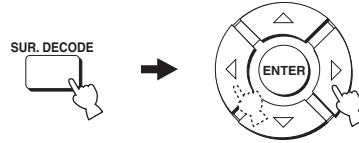

Example of the surround mode display in the front panel display when the CINEMA DSP program and the Music Enhancer are turned off

Enjoying TV in surround sound

You can enjoy analog audio signals output from your TV in real surround sound.



Before performing the steps below, set the volume of this unit to 30. If necessary, adjust the volume level in step 4 below.

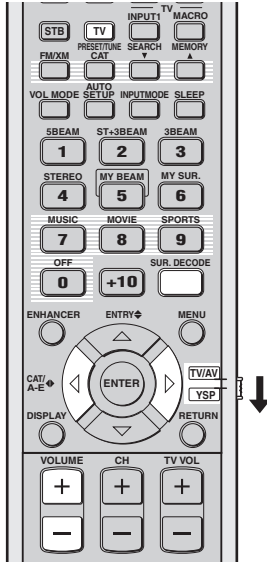

(U.S.A. and Canada models)

1 Select the TV channel you want to watch.

To select a TV channel, use the remote control supplied with your TV.

2 Set the operation mode selector to YSP.

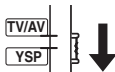

3 Press TV.

This unit outputs audio signals from your TV.



4 If you hear sound from your TV speakers, reduce the volume level of your TV until you can no longer hear any audio being output.

To reduce the TV volume level, use the remote control supplied with your TV.



5 Press VOLUME +/- to adjust the volume level.

6 Press SUR. DECODE repeatedly (or press SUR. DECODE and then press <|/> to switch between surround modes.

Signals input from 2-channel sources are played back in multi-channels.

For more information on surround modes, see page 56.



or

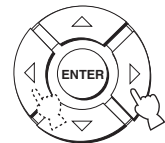

Adjusting surround mode parameters

You can configure the parameters for Dolby Pro Logic II Music and DTS Neo:6 Music to fine-tune the surround sound effect.

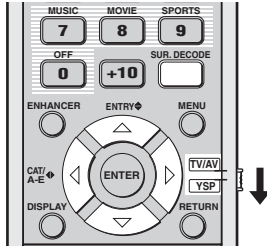

(U.S.A. and Canada models)

1 Repeat steps 1 and 2 in “Enjoying 2-channel sources in surround sound” on page 57 and select PL II Music or Neo:6 Music.

2 Press \triangle / ∇ to select the parameter.

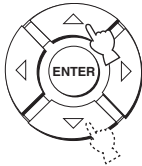

3 Press $\triangleleft / \triangleright$ to configure the selected parameter.

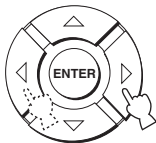

■ When Dolby Pro Logic II Music is selected

PANORAMA

Gives the front left and right channel sound a wraparound effect, distributed throughout the entire surround sound field to give you an expansive feeling.

Choices: ON/OFF

Default setting: OFF

DIMENSION

Adjusts the difference in volume between the front and surround channels to the desired volume balance.

Control range: -3 (toward the surround direction) to +3 (toward the front direction)

Default setting: STD (standard)

C. WIDTH

Distributes the center channel sound to the left and right. If 0 is selected, the center channel sound is output only from the center channel.

Control range: 0 to 7

Default setting: 3

■ When DTS Neo:6 Music is selected

C. IMAGE

Adjusts the center image from three channels (front left and right and center) to varying degrees.

Control range: 0.0 (wider) to 1.0 (toward the center)

Default setting: 0.3

Enjoying stereo sound

You can enjoy 2-channel and 5-channel stereo playback as the beam modes by pressing STEREO on the remote control.

Notes

- When you play back Dolby Digital audio signals in the 2-channel or 5-channel stereo playback, the dynamic range becomes compressed. If the volume level decreases to the extreme, use other beam modes except My Beam.
- When the 2-channel or 5-channel stereo playback is selected as the beam mode, the surround modes (see page 56) and the CINEMA DSP programs (see page 63) become ineffective.

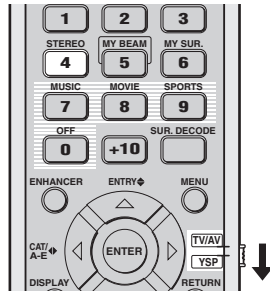

(U.S.A. and Canada models)

Note

When you play back multi-channel sources, all signals except those from the front left and right channels are mixed down and output from the front left and right channels. No audio is output from the center and surround channels.

5-channel stereo playback

Sounds are output from front left and right, center, and surround left and right. This is ideal for playback in a large listening area or at a party.

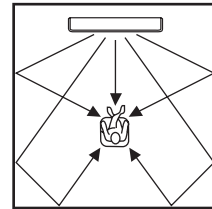

2-channel stereo playback

Sounds are output from the front right and left channels. This is ideal for playing back hi-fi sources, such as CDs, and can be used to replace your TV speakers.

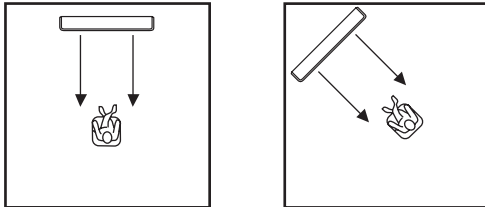

- 1 Set the operation mode selector to YSP.

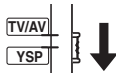

- 2 Press STEREO to select the 2-channel stereo playback as the beam mode.

“STEREO” appears in the front panel display.

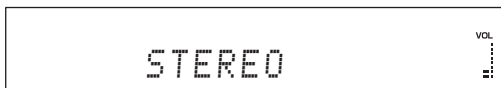

- 1 Set the operation mode selector to YSP.

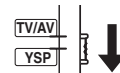

- 2 Press STEREO twice to select the 5-channel stereo playback as the beam mode.

“5CH STEREO” appears in the front panel display.



Playing back sound clearly (My Beam)

You can improve listenability in a noisy environment by changing the beam mode to My Beam, which outputs sound beams directly toward the listening position in a single channel. In addition, My Beam is also ideal when you do not want the sound beams to be reflected on the walls in your listening room or when you do not want to disturb other people while enjoying music or movies at night.

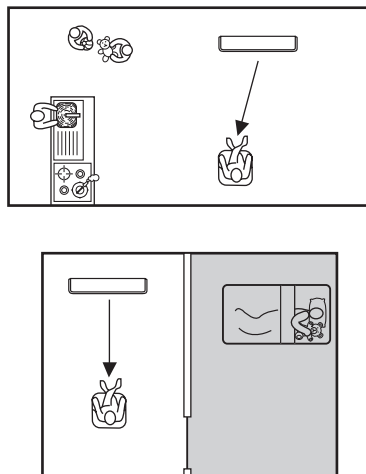
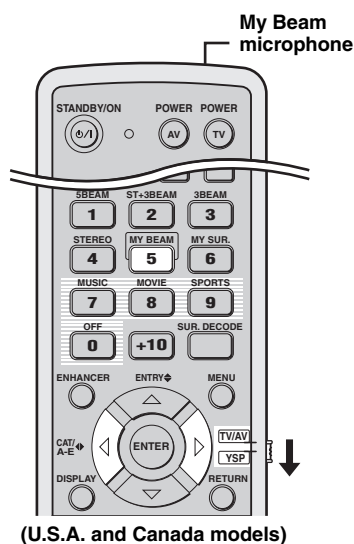

Note

If My Beam is selected as the beam mode, the surround modes (see page 56), the CINEMA DSP programs (see page 63), and TruBass (see page 79) become ineffective. In addition, no audio is output from the subwoofer connected to this unit.

Using auto-adjust function

The My Beam microphone on the remote control collects the test tones from this unit so that the beam angle can be automatically adjusted.

1 Set the operation mode selector to YSP.

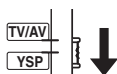

2 Press and hold MY BEAM for more than two seconds.

A test tone is output twice from this unit. Keep pointing the remote control toward this unit while the test tones are being output so that the My Beam microphone can collect the test tones.

Control range: L60° to R60°

Operation guarantee range: 6 m (20 ft), L45° to R45°



Notes

- If an error occurs, an error buzzer is played and “MY BEAM ERROR” is displayed in the front panel display.
- An error may occur if the listening room is noisy. Make sure that the listening room is as quiet as possible while the test tones are being output.
- Do not shake or move the remote control while the test tones are being output.
- Do not cover the My Beam microphone on the remote control while the test tones are being output.
- The batteries in the remote control may be weak if the remote control does not function properly. In this case, replace all the batteries and then try the procedure again.
- When the input signal with 64 kHz or 96 kHz of sampling frequency is being played back, the beam angle cannot be automatically adjusted.

Using manual-adjust function

You can adjust the beam angle manually while playing back an input source. This function is also ideal if the listening position is out of the operation guarantee range of the auto-adjust function.

1 Set the operation mode selector to YSP.

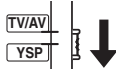

2 Press MY BEAM.

“MY BEAM” is displayed in the front panel display.



3 Press ◀ / ▶ while “MY BEAM” is displayed to adjust the beam angle.

Control range: L90° to R90°

- Press ◀ repeatedly to increase the horizontal angle on the left side.
- Press ▶ repeatedly to increase the horizontal angle on the right side.

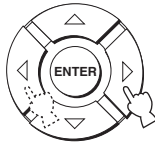

4 Press MY BEAM again to complete the beam angle adjustment.

Using sound field programs

This unit is equipped with a variety of precise digital decoders that allow you to enjoy multi-channel playback from stereo or multi-channel sources. This unit is also equipped with a Yamaha CINEMA DSP (digital sound field processing) chip containing several sound field programs used to enhance your playback experience. Most of the CINEMA DSP programs are precise digital recreations of actual acoustic environments found in famous concert halls, music venues, and movie theaters.



The Yamaha CINEMA DSP programs are compatible with all Dolby Digital, DTS, and Dolby Surround sources.

Note

Choose a CINEMA DSP program based on your listening preference and do not purely rely on the name of the CINEMA DSP program itself.

■ What is a sound field?

A significant factor that creates the rich, full tones of a live instrument is the multiple reflections from the walls of the room. In addition to making the sound live, these reflections enable the listener to tell where the player is situated as well as the size and shape of the room in which the listener is sitting.

■ Elements of a sound field

In any environment, there are two distinct types of sound reflections combined with the direct sound coming straight to our ears from the player's instrument to make up the sound field.

Early reflections

Reflected sounds reach our ears extremely rapidly (50 ms to 80 ms after the direct sound) after reflecting from one surface only (from the ceiling or the wall, for example). Early reflections help add clarity to the direct sound.

Reverberations

These are caused by reflections from more than one surface (i.e., wall, ceiling, the back of the room, etc.) so numerous that they merge together to form a continuous sonic afterglow. They are non-directional and lessen the clarity of the direct sound.

Direct sound, early reflections, and subsequent reverberations all together help us determine the subjective size and shape of the room, and it is this information that the digital sound field processor reproduces in order to create the sound fields.

With the appropriate early reflections and subsequent reverberations in your listening room, you can create your own listening environment. The acoustics in your room could be changed to those of a concert hall, a dance floor, or a listening room of virtually any size at all. This ability to create sound fields at will is exactly what Yamaha has done with the CINEMA DSP technology.

CINEMA DSP programs

You can select from three different CINEMA DSP programs (MUSIC, MOVIE, and SPORTS) depending on the type of source you want to enjoy. The CINEMA DSP indicator lights up in the front panel display when one of the CINEMA DSP programs is selected.

Notes

- The CINEMA DSP programs are ineffective when My Surround (see page 55) is selected as the beam mode.
- If the CINEMA DSP programs are not available, "Prohibit" appears in the front panel display when you press one of the CINEMA DSP program buttons on the remote control.

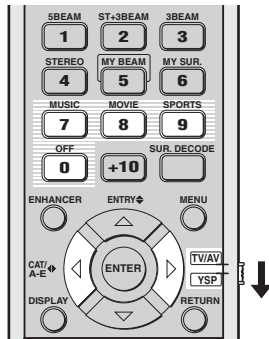

(U.S.A. and Canada models)

■ Music program

Select this CINEMA DSP program when you play back music sources. This program produces a vibrant atmosphere and lets you feel as if you are seated in an actual rock or jazz concert hall.

- 1 Set the operation mode selector to YSP.

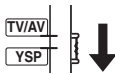

- 2 Press MUSIC to select the music CINEMA DSP program.



■ Movie program

Select this CINEMA DSP program when you play back movie sources, especially the ones encoded in Dolby Digital, DTS, or Dolby Surround. This program clearly reproduces dialog and sound effects, thus creating a broad and expansive cinematic space amid silence.

- 1 Set the operation mode selector to YSP.

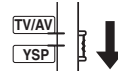

- 2 Press MOVIE to select the movie CINEMA DSP program.



■ Sports program

Select this CINEMA DSP program when you play back sports sources. This program densely concentrates the vocal sound of the commentator in the center while broadening the sound from the audience or the environment all around your listening room.

- 1 Set the operation mode selector to YSP.

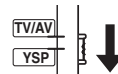

- 2 Press SPORTS to select the sports CINEMA DSP program.



■ Turning off CINEMA DSP programs

Turn off the CINEMA DSP programs if you want to enjoy the original sound without the CINEMA DSP program effect.

1 Set the operation mode selector to YSP.

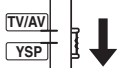

2 Press OFF to turn off the CINEMA DSP programs.

“CINEMA DSP OFF” is displayed in the front panel display and the CINEMA DSP indicator disappears.



■ Adjusting CINEMA DSP effect levels

You can enjoy good quality sound with the factory preset parameters. However, you can also adjust the effect level of the CINEMA DSP programs relative to the level of the direct sound so that each CINEMA DSP program can reflect your listening environment and your preference even more accurately.

1 Set the operation mode selector to YSP.

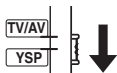

2 Press MUSIC, MOVIE, or SPORTS to select the desired CINEMA DSP program.



3 Press \triangle / ∇ .

“DSP LEVEL” is displayed in the front panel display.

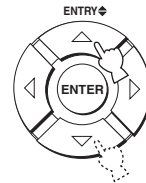

4 Press \triangleleft / \triangleright to adjust the effect level of the selected CINEMA DSP program.

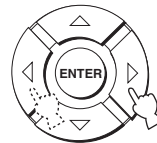

Control range: -6 dB to +3 dB

- A larger value increases the effect level.
- A smaller value decreases the effect level.

Using the music enhancer

You can use the Music Enhancer of this unit to improve the sound nearest to the original depth and width of compression artifacts such as the MP3 format.

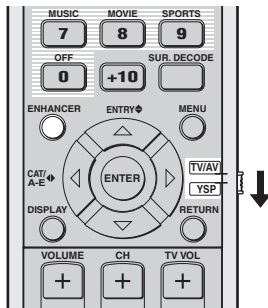

(U.S.A. and Canada models)

1 Set the operation mode selector to YSP.

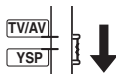

2 Press ENHANCER to select the Music Enhancer.

The currently selected mode appears in the front panel display.



3 Press ENHANCER repeatedly to switch between the Music Enhancer levels (OFF, MIN, and MAX).

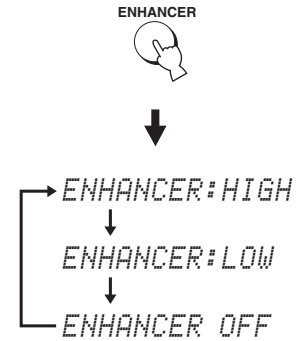

The ENHANCER indicator lights up when “ENHANCER:HIGH” or “ENHANCER:LOW” is selected.

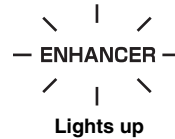

Notes

- The Music Enhancer is not compatible with the CINEMA DSP programs. If a CINEMA DSP program is selected while the Music Enhancer is on, the Music Enhancer is turned off automatically. In this case, the Music Enhancer remains off even after the CINEMA DSP program is canceled.
- The Music Enhancer is available only when a setting other than My Surround (see page 55) is selected as the beam mode.

Using the volume mode (Night listening enhancer/TV volume equal mode)

The night listening enhancers are designed to improve listenability at lower volumes or at night. In addition, you can limit the volume level of the TV so that it will not vary suddenly to a great extent whenever the contents being broadcast change (i.e. due to commercials, etc.).

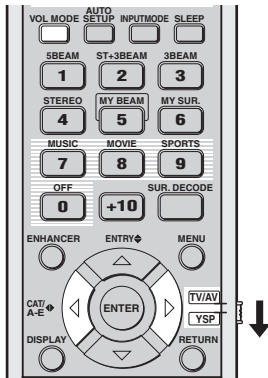

(U.S.A. and Canada models)

The EQUAL indicator lights up in the front panel display when “TV EQUAL VOLUME” is selected.

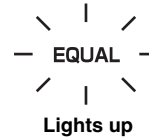

- Select NIGHT:CINEMA when watching films to reduce the dynamic range of film soundtracks and to make dialog easier to hear at lower volumes.
- Select NIGHT:MUSIC when listening to music sources to preserve ease-of-listening for all sounds.
- Select TV EQUAL VOLUME when watching TV programs.
- Select OFF to turn off the volume mode.

1 Set the operation mode selector to YSP.

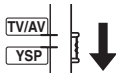

2 Press VOL MODE repeatedly to select NIGHT:CINEMA, NIGHT:MUSIC, TV EQUAL VOLUME, or OFF.

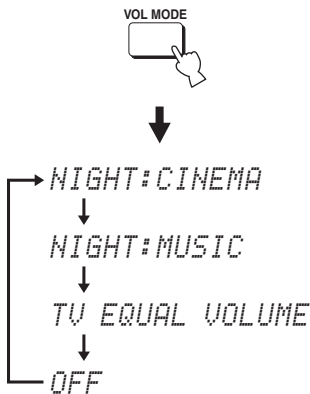

The NIGHT indicator lights up in the front panel display when “NIGHT:CINEMA” or “NIGHT:MUSIC” is selected.

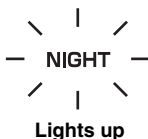

3 Press ◀/▶ to adjust the effect level of compression while NIGHT:CINEMA, NIGHT:MUSIC, or TV EQUAL VOLUME is displayed.

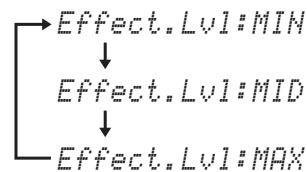
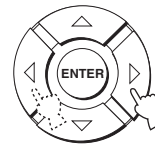

- Select Effect.Lvl:MIN for minimum compression.
- Select Effect.Lvl:MID for standard compression.
- Select Effect.Lvl:MAX for maximum compression.

Notes

- The volume mode settings are canceled if you press STANDBY/ON or disconnect the AC power supply cable from the AC wall outlet.
- The volume mode settings become ineffective when My Surround is selected as the beam mode (see page 55).

Using the sleep timer

Use this feature to automatically set this unit to the standby mode after a specified period of time. The sleep timer is useful if you are going to sleep after a certain amount of time while this unit is still playing back a source.

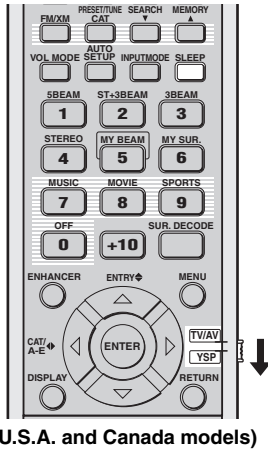

Each time you press SLEEP, the front panel display changes as shown below.

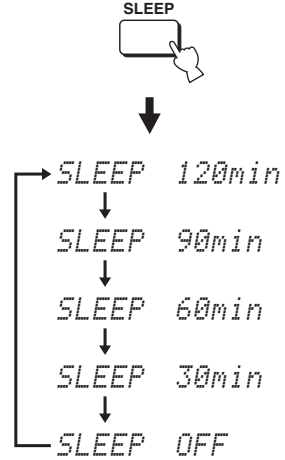

- 1 Set the operation mode selector to YSP.

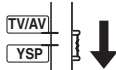

- 3 Wait for a few seconds without operating this unit to confirm the setting for the sleep timer.

The SLEEP indicator lights up in the front panel display, indicating that the sleep timer is activated.

- 2 Press SLEEP repeatedly to set the interval for the sleep timer.

Choices: 120min, 90min, 60min, 30min, OFF
The SLEEP indicator flashes in the front panel display while switching the interval for the sleep timer.

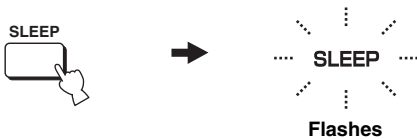

■ Canceling the sleep timer

1 Set the operation mode selector to YSP.

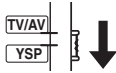

2 Press SLEEP repeatedly until “SLEEP OFF” appears in the front panel display.



3 Wait for a few seconds without operating this unit to confirm the setting for the sleep timer.

The SLEEP indicator disappears from the front panel display, indicating that the sleep timer is deactivated.

SLEEP
Disappears

Note

The previous setting for the sleep timer before you deactivate it is stored in the system memory.



The sleep timer setting can also be deactivated if you press STANDBY/ON to set this unit to the standby mode or unplug the AC power supply cable from the AC outlet.

Displaying the input source information

You can display the format and sampling frequency of the current input signal in the front panel display.

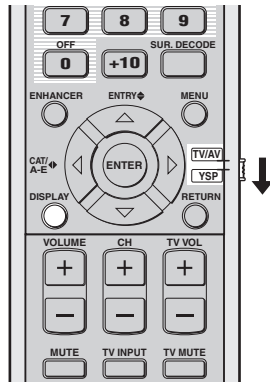

(U.S.A. and Canada models)

1 Set the operation mode selector to YSP.

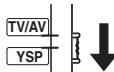

2 Press DISPLAY.

The information on the current input signal is displayed as follows:

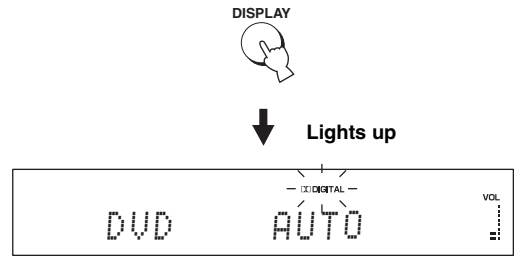

or

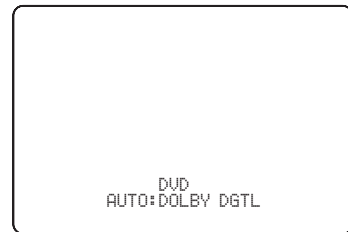

Input signal	Indicator	Sampling frequency
Dolby digital	DOLBY DGTL	32/44.1/48/64/ 88.2/96 kHz
DTS	DTS	
PCM	PCM	
Analog	ANALOG	—



When the input signal is unclear, “—” is displayed for the sampling frequency.

Using the HDMI control feature

You can operate the following functions using the remote control supplied with your TV if this unit and an HDMI control-compatible TV (except some models) are connected via HDMI.

- Turning on or off the power (synchronized operation with the TV)
- Selecting the audio output component (TV or this unit)
- Adjusting the volume level (up/down and mute)

An example of the HDMI control-compatible component is a Panasonic EZ Sync (for U.S.A. and Canada) or Viera Link (for other countries)-compatible component (TV, DVD recorder, Blu-ray recorder, etc.).



If you connect this unit to an HDMI control-compatible DVD player or Blu-ray Disc player via HDMI, you can also control the connected component in synchronization with this unit (except some models).

1 Connect this unit to your HDMI control-compatible TV via HDMI.

For details about HDMI and HDMI components, see “Information on HDMI™” on page 20 and “Connections using HDMI cables” on page 21. Also in the owner’s manual supplied with your TV, refer to the information on connecting an AV amplifier.

2 Turn on the power of all components connected via HDMI.

For details about controlling external components, see the owner’s manuals supplied with your components.

3 Check the system settings for all components connected via HDMI and activate the HDMI control feature.

For details about setting external components, see the owner’s manuals supplied with your components. Once you have followed steps 1 to 3, you do not need to carry out the same procedure again next time.

4 Turn off the power of your TV and then turn on the power again.

5 Set the input source selector of your TV to this unit (HDMI, etc.).

6 Select the connected component as the input source by pressing INPUT on the front panel of this unit (or press one of the input selector buttons on the remote control). Confirm that the video image played back on the DVD recorder (etc.) appears in your TV correctly.

7 Use the remote control supplied with your TV to turn on or off the power, select the audio output component, and adjust the volume level of this unit.

Notes

- Check the following if you cannot operate this unit in synchronization with your TV.
 - Whether HDMI CONTROL is set to ON (see page 82).
 - Whether the HDMI control feature is activated for your TV (see the owner’s manual supplied with your TV).
- While you are playing back audio from a non-HDMI component, turning off the power of your TV with the remote control supplied with your TV does not turn off the power of this unit. Playback continues without being affected.

MANUAL SETUP

To achieve the best quality surround sound, you can use **MANUAL SETUP** to fine-tune the listening environment parameters, as well as to make advanced settings for sound signals, sound beams, digital input, and the OSD. Change the initial settings (indicated in bold under each parameter) to reflect the needs of your own listening environment.



- You can save the settings optimized by the **AUTO SETUP** procedure (see page 42). A set of settings optimized according to the specific conditions of your listening environment can be recalled later depending on the varying conditions of your listening environment (see page 43).
- Most of the parameters in **SOUND MENU** and **BEAM MENU** are automatically set when you run **AUTO SETUP** (see page 35). Use **SOUND MENU** and **BEAM MENU** to make additional adjustments.
- **BEAM MENU** allows you to make settings for the surround sound effects normally available in the speaker settings menu.
- Make settings for the parameters in **BEAM MENU** first before making settings for the parameters in **SOUND MENU**, **INPUT MENU**, and **DISPLAY MENU**.

SOUND MENU

Use to manually adjust the various parameters related to the sound output.

Item	Features	Page
TONE CONTROL	Adjusts the output level of high-frequency or low-frequency sound.	78
SUBWOOFER SET	Adjusts the various subwoofer settings.	78
MUTE LEVEL	Adjusts the muting level.	78
AUDIO DELAY	Adjusts the audio delay.	79
ROOM EQ	Adjusts the tonal quality of the listening room.	79
DD/DTS Dynamic Range	Adjusts the dynamic range of Dolby Digital or DTS signals.	79
TruBass	Selects the bass sound enhancer.	79

BEAM MENU

Use to manually adjust the various parameters related to the sound beam output.

Item	Features	Page
SETTING PARAMETERS	Adjusts the listening room and listening position settings.	74
BEAM ADJUSTMENT	Adjusts the various sound beam settings.	75
IMAGE LOCATION	Adjusts the sound position of the front left and right channels.	77

INPUT MENU

Use to manually adjust the various parameters related to the audio and video input.

Item	Features	Page
INPUT ASSIGNMENT	Assigns jacks according to the component to be used.	80
INPUT MODE	Selects the initial input of the source.	80
INPUT TRIM	Adjusts the input level of the source.	80
INPUT RENAME	Renames the displayed input source.	81
HDMI SET	Adjusts the various HDMI settings.	81
XM ANTENNA LEVEL (U.S.A. and Canada models only)	Displays the current reception level of the XM Satellite Radio signal.	82

DISPLAY MENU

Use to manually adjust the various parameters related to the display.

Item	Features	Page
F.DISPLAY SET	Adjusts the front panel display settings.	83
OSD SET	Adjusts the OSD settings.	83
UNIT SET	Changes the display unit of measurement.	83

Using MANUAL SETUP

Use the remote control to access and adjust each parameter.

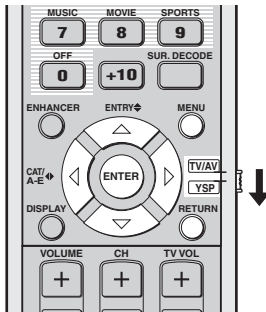

(U.S.A. and Canada models)



You can adjust the SET MENU parameters while the unit is reproducing sound.

1 Set the operation mode selector to YSP.

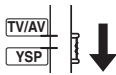

2 Press MENU.

The SET MENU screen appears on your TV.



- The control buttons used for SET MENU are displayed at the bottom of the screen.
- To return to the previous screen while using SET MENU, press RETURN.
- To exit from the SET MENU screen, press MENU once more.
- You can also perform the following operations in the front panel display.

3 Press ▲ / ▼ to select MANUAL SETUP and press ENTER.

The following screen appears on your TV.

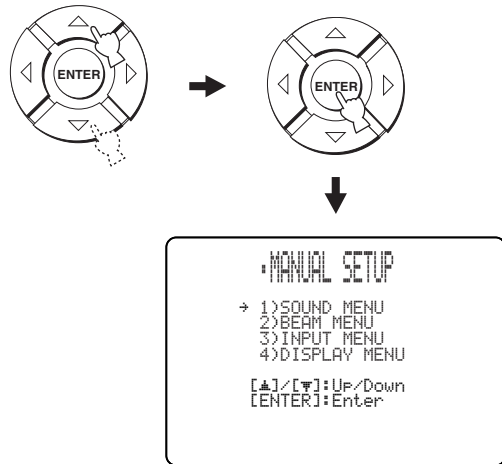

4 Press ▲ / ▼ to select a sub menu and press ENTER.

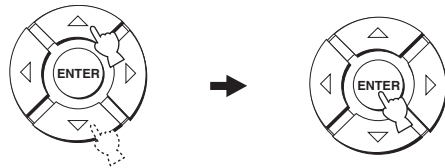

5 Press ▲ / ▼ / ◀ / ▶ and ENTER to configure each parameter.

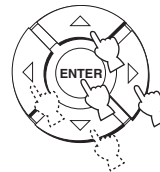

6 Press MENU to exit.

The OSD disappears from your TV screen.



BEAM MENU

Use to manually adjust the various parameters related to the sound beam output.

SET MENU → MANUAL SETUP → BEAM MENU

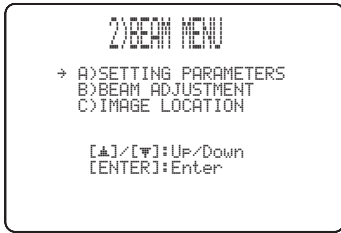

You can adjust the sound beam output level of each channel in "Adjusting the audio balance" (see page 84).

SETTING PARAMETERS (Setting parameters)

Use to set the position of this unit in your listening room and the distance of this unit from the listening position. When you make settings for each parameter, other related parameters are automatically adjusted to best match your listening environment.

Note

If you make adjustments in SETTING PARAMETERS, the beam optimization settings made in the AUTO SETUP procedure will be lost. If you want to keep the beam optimization settings made in the AUTO SETUP and make further adjustments, adjust settings in BEAM ADJUSTMENT first (see page 75).



INSTALLED POSITION (Installed position of this unit)

Use to adjust the installed position of this unit.
 Choices: **FLAT TO WALL** (Parallel to wall installation),
ANGLE TO WALL OR CORNER (Corner installation)

FLAT TO WALL

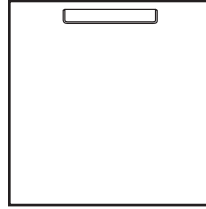

ANGLE TO WALL OR CORNER

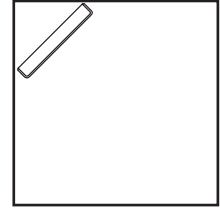

- Select **FLAT TO WALL** if this unit is installed in parallel with the wall in your listening room. Adjust the width and length of your listening room as well as the distance of the listening position from this unit and the distance of the center of this unit from the left wall.

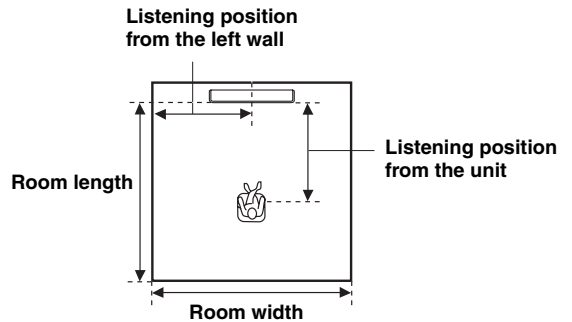

Choices for the room width and length:

2.0 m to 12.0 m (6.5 ft to 40.0 ft)

Choices for the listening position from this unit:

1.8 m to 9.0 m (6.0 ft to 30.0 ft)

Choices for the listening position from the left wall:

0.6 m to 11.4 m (2.0 ft to 38.0 ft)

Room width and length

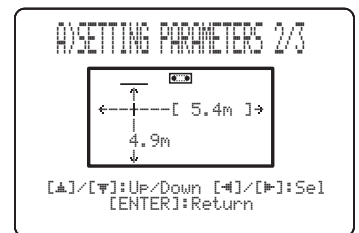

Listening position from the unit and the left wall

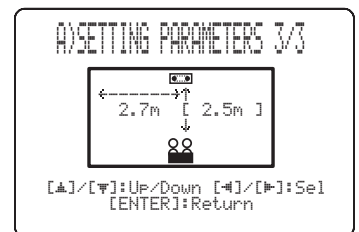

- Select ANGLE TO WALL OR CORNER if this unit is installed in the corner of your listening room. Adjust the width and length of your listening room as well as the distance of the listening position from this unit.

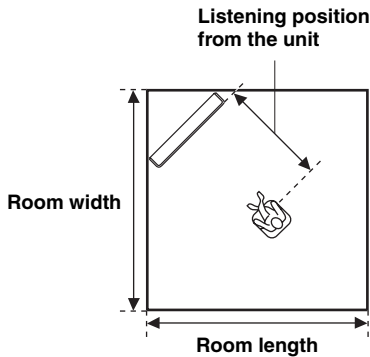

Choices for the room width and length:
2.0 m to 12.0 m (6.5 ft to 40.0 ft)
Choices for the listening position from this unit:
1.8 m to 9.0 m (6.0 ft to 30.0 ft)

Room width and length

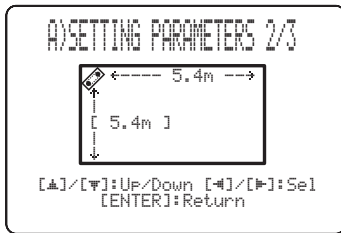

Listening position from the unit

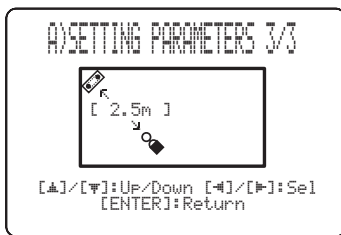

Note

When you set the INSTALLED POSITION parameter in MANUAL SETUP (see page 74), the parameters newly set for the width and length of your listening room are automatically set as the factory default value.

BEAM ADJUSTMENT (Beam adjustment)

Use to manually adjust the various sound beam settings. We recommend that you select 5 Beam as the beam mode before adjusting these parameters (see page 54).

Notes

- When INSTALLED POSITION is adjusted in MANUAL SETUP (see page 74), the factory default value is automatically set for this parameter except Center in FOCAL LENGTH (see page 76).
- Depending on the beam mode settings (see pages 54 and 60), some channel positions may not be available for selection. In this case, “--” is displayed. When using Stereo plus 3 Beam as the beam mode, set the surround left and right signals to be output from the front left and right channels.

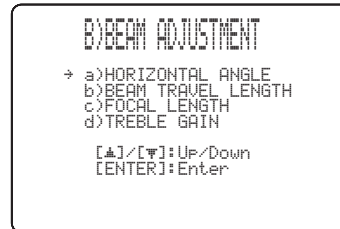

HORIZONTAL ANGLE (Horizontal angle)

Use to adjust the horizontal angle of sound beams for each channel. By adjusting the horizontal angle of the sound beams, you can optimize the sound beam paths. A test tone is automatically output.

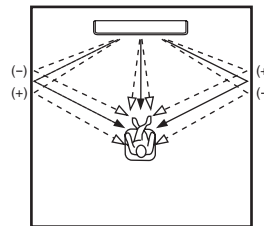

Choices: L90° to R90°

Adjust toward L (left) to move the direction of the output to the left and adjust toward R (right) to move it to the right.

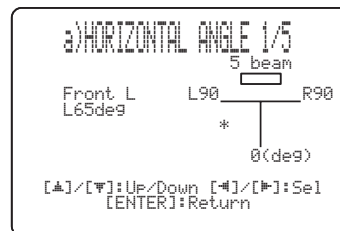

BEAM TRAVEL LENGTH (Beam travel length)

A certain amount of delay must be applied to the sound from each channel so that all sounds can arrive at the listening position at the same time. This menu sets the distance that sound beams travel after being output and reflected off the wall until they arrive at the listening position and adjusts the delay applied to the respective channel.

The lines in the illustration below indicate the distance.

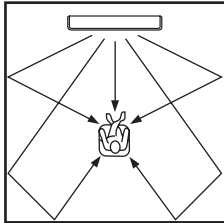

Choices: 0.3 m to 24.0 m (1.0 ft to 80.0 ft)

- **Front L** adjusts the distance the front left channel sound beams travel.
- **Front R** adjusts the distance the front right channel sound beams travel.
- **Center** adjusts the distance the center channel sound beams travel.
- **Surround L** adjusts the distance the surround left channel sound beams travel.
- **Surround R** adjusts the distance the surround right channel sound beams travel.

```

b) BEAM TRAVEL LENGTH
   5 beam
  → Front L.....6.0m
   Front R.....6.0m
   Center.....2.5m
   Surround L....9.1m
   Surround R....9.1m

  [▲]/[▼]:Up/Down [←]/[→]:Sel
  [ENTER]:Return
    
```



We recommend that you use the setting optimized by AUTO SETUP (see page 35). Adjust this parameter only when you changed HORIZONTAL ANGLE (see page 75).

FOCAL LENGTH (Focal length)

Use to set the distance from the front of this unit to the focal point of output for each channel to achieve an expansive feeling for each channel.

The focal points except for the center channel should be set near the reflection points on the walls. The shorter the distance, the larger the expansion.

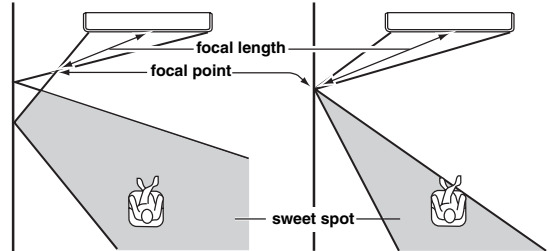

Front left channel

Center channel

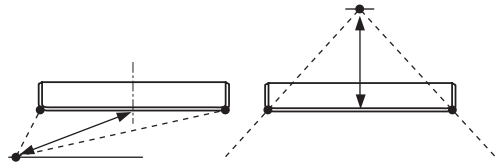

Choices: -1.0 m to +13.0 m (-3.5 ft to +43.5 ft)

Adjust toward - (minus) to move the focus outward and adjust toward + (plus) to move the focus toward the normal position.

- **Front L** adjusts the focal length for the front left sound beams.
- **Front R** adjusts the focal length for the front right sound beams.
- **Center** adjusts the focal length for the center sound beams. Initial setting: -0.5 m (-1.5 ft)
- **Surround L** adjusts the focal length for the surround left sound beams.
- **Surround R** adjusts the focal length for the surround right sound beams.



We recommend that you use the initial setting (-0.5 m (or 1.5 ft)) for the center channel.

```

c) FOCAL LENGTH
   5 beam
  → Front L.....+1.5m
   Front R.....+1.5m
   Center.....-0.5m
   Surround L....+2.3m
   Surround R....+2.3m

  [▲]/[▼]:Up/Down [←]/[→]:Sel
  [ENTER]:Return
    
```

TREBLE GAIN (Treble gain)

Use to adjust the high-frequency output level of each channel.



If the reflection points of the front left and right or surround left and right sound beams are on curtain or other acoustically absorbent surfaces, you can achieve more effective surround sound by increasing the treble level for those sound beams.

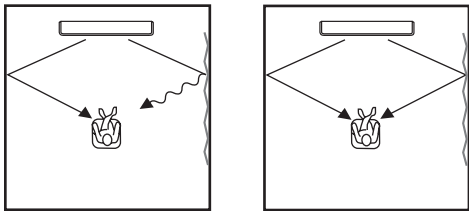

Choices: -12.0 dB to +12.0 dB

Initial setting: 0 dB

- **Front L** adjusts the high-frequency output level of the front left channel.
- **Front R** adjusts the high-frequency output level of the front right channel.
- **Center** adjusts the high-frequency output level of the center channel.
- **Surround L** adjusts the high-frequency output level of the surround left channel.
- **Surround R** adjusts the high-frequency output level of the surround right channel.

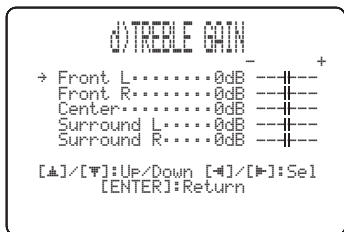

IMAGE LOCATION (Image location)

Use to adjust the direction from which the front left and right channel sound is heard so that each sound can be heard closer to the center channel.

Use this feature to redirect audio signals if the sound coming from the front left and right channels seems unnatural, such as when your listening position is not the center of your listening room.

You can only adjust this parameter when 3 Beam or 5 Beam is selected as the beam mode (see page 54).

Choices: **ON**, **OFF**

Setting range: 0% to 95%

Initial setting: 0%

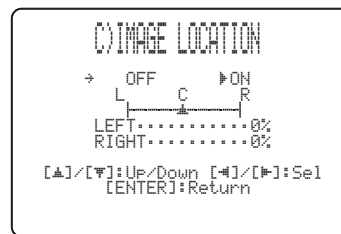

LEFT (Left)

Adjusts audio signals toward the left.

The higher the percentage, the louder the output from the center.

Without adjustment

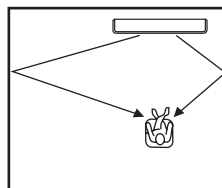

With the front left channel adjusted

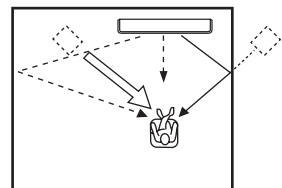

RIGHT (Right)

Adjusts audio signals toward the right.

The higher the percentage, the louder the output from the center.

Without adjustment

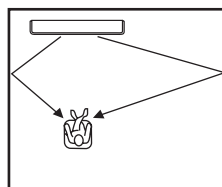

With the front right channel adjusted

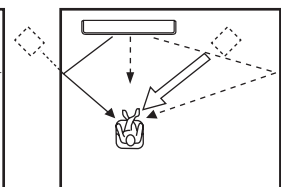

SOUND MENU

Use to manually adjust the various parameters related to the sound output.

SET MENU → MANUAL SETUP → SOUND MENU

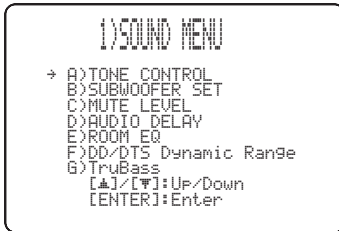

■ TONE CONTROL (Tone control)

You can adjust the tonal quality of sound beams.

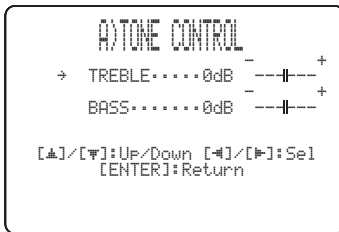

TREBLE (Treble)

Use to adjust the high-frequency response.

Choices: -12 dB to +12 dB

Initial setting: 0 dB

BASS (Bass)

Use to adjust the low-frequency response.

Choices: -12 dB to +12 dB

Initial setting: 0 dB

■ SUBWOOFER SET (Subwoofer settings)

Use to manually adjust the various subwoofer settings.

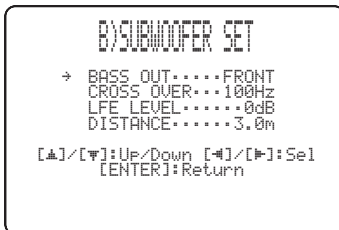

BASS OUT (Bass out)

Low-frequency (bass) signals can be directed to the subwoofer and/or the front left and right channels. This setting also determines the routing of LFE (low-frequency effect) signals found in Dolby Digital or DTS sources.

Choices: SWFR (Subwoofer), **FRONT**

- Select SWFR if you connect a subwoofer. LFE and low-frequency signals from other channels are directed to the subwoofer.
- Select FRONT if you do not use a subwoofer. LFE and low-frequency signals from other channels are directed to the front left and right channels.

CROSS OVER (Crossover)

When BASS OUT is set to SWFR, you can use this feature to select a crossover (cutoff) frequency for all low-frequency signals. All frequencies below the selected frequency will be sent to the subwoofer position.

Choices: 80Hz, **100Hz**, 120Hz

LFE LEVEL (Low-frequency effect level)

Select to adjust the output level of the LFE (low-frequency effect) channel according to the capacity of your subwoofer. The LFE channel carries low-frequency special effects which are only added to certain scenes.

This setting is effective only when this unit decodes Dolby Digital or DTS signals.

Choices: -20 to **0** dB

DISTANCE (Distance)

Select to adjust the distance of the subwoofer from the listening position.

Choices: 0.3 to 15.0 m (1.0 ft to 50.0 ft)

Initial setting: 3.0 m (10.0 ft)

■ MUTE LEVEL (Muting level)

Use to adjust how much the mute function reduces the volume level.

Choices: **MUTE**, -20 dB

- Select MUTE to completely halt all sound output.
- Select -20 dB to reduce the current volume level by 20 dB.



■ AUDIO DELAY (Audio delay)

Use to delay the sound output and synchronize it with the video image. This may be necessary when using certain LCD monitors or projectors.

Choices: **0** to 160 msec



■ ROOM EQ (Room equalizer)

Use to change the tonal qualities of your listening room when the unit is mounted on the wall.

Choices: MOUNTING (Mount type),
REFLECTING (Reflectivity type)

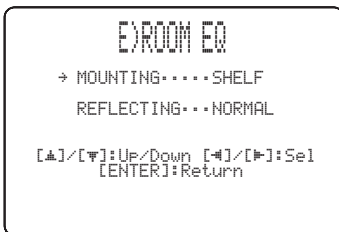

MOUNTING (Mounting type)

Use to enhance medium to low range sounds.

Choices: WALL (Wall mount), **SHELF** (Shelf mount)

- Select WALL if this unit is mounted on the wall in your listening room.
- Select SHELF if this unit is mounted on the shelf in your listening room.

REFLECTING (Reflectivity type)

Use to select the reflectivity of your listening room.

Choices: **NORMAL** (Normal), HI ECHO (High echo)

- Select NORMAL if your listening room has a normal reflectivity.
- Select HI ECHO if your listening room has highly reflective surfaces such as concrete walls.

■ DD/DTS Dynamic Range (Dynamic range of Dolby Digital and DTS signals)

Use to select the amount of dynamic range compression. This setting is effective only when the unit is decoding Dolby Digital and DTS signals. Dynamic range is the difference between the smallest sound that can be heard above the noise of the equipment and the biggest sound that can be heard without distortion.

Choices: MIN (minimum), STD (standard),
MAX (maximum)



Select to adjust the dynamic range compression.

- Select MIN for listening to sources at low volume levels.
- Select STD for general use.
- Select MAX for feature films.

■ TruBass

Use to turn on or off the bass sound enhancer. The SRS TruBass technology improves bass even without a subwoofer and provides deeper, richer bass in the presence of a subwoofer.

Choices: OFF, **ON**



Note

TruBass is not available when My Beam (see page 61) or My Surround (see page 55) is selected as the beam mode.

INPUT MENU

Use to manually adjust the various parameters related to the audio and video input.

SET MENU → MANUAL SETUP → INPUT MENU



Note

“F) XM ANTENNA LEVEL” is for U.S.A. and Canada models only.

■ INPUT ASSIGNMENT (Input assignment)

Use to assign the HDMI IN jacks of this unit to other components if the initial settings of this unit do not correspond to your needs. By assigning other components to the HDMI IN jacks of this unit, you can display the names of the connected components in the front panel display and OSD and operate the components with the input selector buttons of the same name. If you connect a component to one of the HDMI IN jacks of this unit and do not assign a name to it, the default component name for HDMI IN jack is displayed in the front panel and OSD when selected.

- Select HDMI1 to assign a component to the HDMI AUX 1 IN jack of this unit.
Choices: TV/STB, **AUX1**
- Select HDMI2 to assign a component to the HDMI DVD IN jack of this unit.
Choices: **DVD**, AUX2

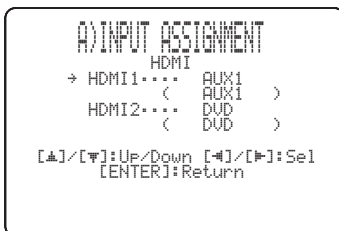

■ INPUT MODE (Input mode)

Use to designate the input mode for the input sources connected to the DIGITAL INPUT jacks when you turn on the power of this unit. For information on the types of audio signals that can be output by this unit, see “Surround modes and recommended sources” on page 56.

Choices: **AUTO**, LAST



- Select AUTO to set this unit to automatically detect the type of input signals and select the appropriate input mode.
- Select LAST to set this unit to automatically select the last input mode used for that input source. If the type of input signals is different from the setting, no sounds will be produced.

■ INPUT TRIM (Input trim)

Use to adjust the input level of the input source.

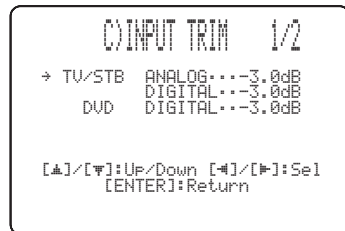

- Select TV/STB ANALOG to adjust the level of audio and video signals input at the TV/STB AUDIO INPUT jacks of this unit.
Control range: -6.0 dB to 0.0 dB
Initial setting: -3.0 dB
- Select TV/STB DIGITAL to adjust the level of audio and video signals input at the TV/STB OPTICAL DIGITAL INPUT jack of this unit.
Control range: -6.0 dB to 0.0 dB
Initial setting: -3.0 dB
- Select DVD DIGITAL to adjust the level of audio and video signals input at the DVD COAXIAL DIGITAL INPUT jack of this unit.
Control range: -6.0 dB to 0.0 dB
Initial setting: -3.0 dB

- Select AUX1 ANALOG to adjust the level of audio and video signals input at the AUX 1 AUDIO INPUT jacks of this unit.
Control range: -6.0 dB to 0.0 dB
Initial setting: -3.0 dB
- Select AUX1 DIGITAL to adjust the level of audio and video signals input at the AUX 1 OPTICAL DIGITAL INPUT jack of this unit.
Control range: -6.0 dB to 0.0 dB
Initial setting: -3.0 dB
- Select AUX2 DIGITAL to adjust the level of audio and video signals input at the AUX 2 COAXIAL DIGITAL INPUT jack of this unit.
Control range: -6.0 dB to 0.0 dB
Initial setting: -3.0 dB
- Select AUX3 ANALOG to adjust the level of audio signals input at the AUX 3 input jack on the front panel.
Control range: -6.0 dB to 0.0 dB
Initial setting: -3.0 dB
- Select DOCK ANALOG to adjust the level of audio signals input at the DOCK terminal of this unit (U.S.A., Canada, and Australia models only).
Control range: -6.0 dB to 0.0 dB
Initial setting: -3.0 dB

■ **INPUT RENAME (Input rename)**

Use to change the name of the input source in the OSD and the front panel display. Press an input selector button (e.g., DVD) to select the component you want to change the name for and perform the following procedure.



- 1 Press ◀/▶ to place the _ (underscore) under the space or the character you want to edit.**

The _ (underscore) flashes.

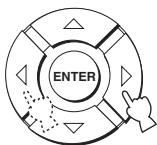

- 2 Press ▲ / ▼ to select the desired character.**

- You can use up to 8 characters for each input.
- Press ▲ to change the character in the following order or press ▼ to go in the reverse order:
A to Z, a space, 0 to 9, a space, a to z, a space, #, *, +, etc.

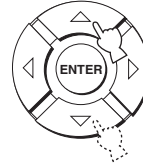

- 3 Repeat steps 1 to 2 to rename each input.**

- 4 Press ENTER to exit.**

The new names are registered, and the display returns to the previous screen.

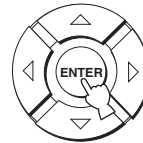

■ **HDMI SET (HDMI settings)**

Use to change the HDMI audio/video output/input to match the connected component.

Choices: SUPPORT AUDIO (Support audio),
VIDEO INFO (Video information),
HDMI CONTROL (HDMI control)



SUPPORT AUDIO (Support audio)

Use to select whether to play back HDMI audio signals on this unit or on another HDMI component connected to the HDMI OUT jack of this unit.

Choices: **YSP-3000**, OTHER

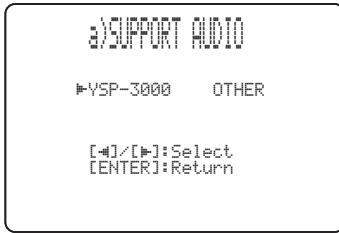

Notes

- This setting is effective when HDMI CONTROL is set to OFF (see right).
- When HDMI CONTROL is set to ON, this setting is ineffective. This unit follows the settings of the HDMI control-compatible TV.
- The HDMI video signals input at one of the HDMI IN jacks of this unit are always output at the HDMI OUT jack of this unit.

VIDEO INFO (Video information)

Use to display the video information of the current input signal.

Choices: HDMI RES., HDMI ERROR

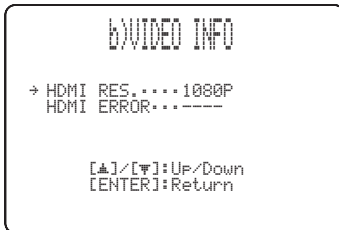

- Select HDMI RES. to display the resolution of the HDMI input/output signals.
- Select HDMI ERROR to display the error message for HDMI sources or devices connected (see page 104 for details).

HDMI CONTROL (HDMI control)

Use this function to link this unit and an HDMI control-compatible TV via HDMI. You can turn on or off the power, select the input mode, and adjust the volume level of this unit using the remote control supplied with your HDMI control-compatible TV. For details, see “Using the HDMI control feature” on page 71.

Choices: OFF, **ON**

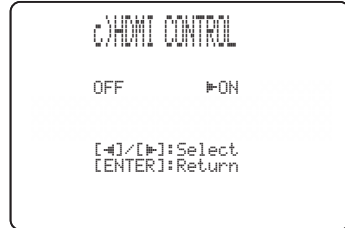

- Select ON to enable the HDMI control.
- Select OFF to disable the HDMI control.

Note

When HDMI CONTROL is set to OFF and this unit is in the standby mode, the signals input at the HDMI IN jacks are not output at the HDMI OUT jack.

■ XM ANTENNA LEVEL (XM antenna level) (U.S.A. and Canada models only)

Use to display the current reception level of the XM Satellite Radio signals. For the best reception, orient the connected XM Mini-Tuner Dock to obtain a value of 60% or more.

Display status: NONE, 0 to 100%



Note

“NONE” is displayed if the XM Mini-Tuner Dock is not connected to this unit. In this case, check the antenna connections (see page 5 in the Reference Guide).

DISPLAY MENU

Use to manually adjust the various parameters related to the display.
 SET MENU → MANUAL SETUP → DISPLAY MENU

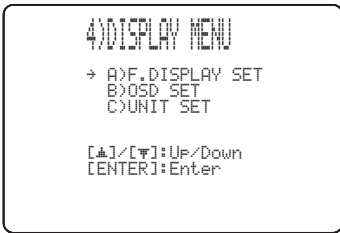

F.DISPLAY SET (Front panel display settings)

Use to adjust the brightness and display settings of the front panel display.

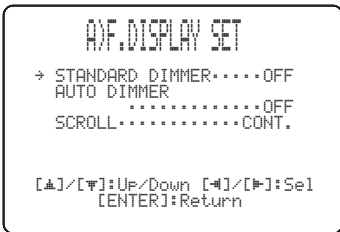

STANDARD DIMMER (Standard dimmer)

Use to adjust the brightness of the front panel display when you operate this unit by using the control buttons on the front panel or on the remote control.

Choices: -2, -1, **OFF**

AUTO DIMMER (Auto dimmer)

If no operation is performed for a specified period of time, the front panel display dims. Use to adjust the brightness of the front panel display in this case.

Choices: **OFF** (the same brightness as the STANDARD DIMMER setting), -1 to -3 (based on the STANDARD DIMMER setting), **DISPLAY OFF**

SCROLL (Front panel display scroll) (U.S.A., Canada, and Australia models only)

Use to select the mode to display information in the front panel display when operating your iPod or XM Satellite Radio.

Choices: **CONT.**, **ONCE**

- Select **CONT.** to continue to scroll the display.
- Select **ONCE** to scroll the display to the end once, after which the first 15 characters appear and stay.

OSD SET (OSD settings)

Use to adjust the display position and to set the display time of the OSD.

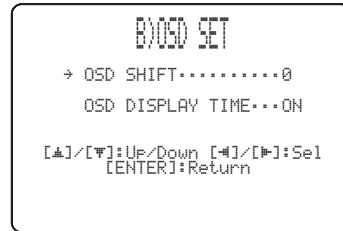

OSD SHIFT (OSD shift)

Use to adjust the vertical position of the OSD. Adjust toward the - (minus) direction to raise the position of the OSD, and adjust toward the + (plus) direction to lower it.
 Choices: -5 to +5

Initial setting: 0

OSD DISPLAY TIME (OSD display time) (U.S.A., Canada, and Australia models only)

Use to set the interval for which the OSD screen is displayed after an operation.

Choices: **ON**, 10s, 30s

- Select **ON** to show the OSD screen constantly.
- Select 10s to turn off the OSD screen 10 seconds after an operation.
- Select 30s to turn off the OSD screen 30 seconds after an operation.



The OSD display time setting is available for your iPod and XM Satellite Radio (U.S.A. and Canada models only). For details, see pages 4 and 10 in the Reference Guide.

UNIT SET (Unit settings)

Use this to change the display unit of measurement.

Choices: **METERS** (Australia, Europe, Asia, and Korea models), **FEET** (U.S.A. and Canada models)



- Select **METERS** to enter distances in meters.
- Select **FEET** to enter distances in feet.

Note

If you change this setting, the adjusted sound beam settings may change.

Adjusting the audio balance

You can adjust the sound beam output level of each channel by using the test tone or the audio output being played back in each beam mode to achieve a more true-to-life surround sound experience.

Using the test tone

You can use the test tone feature to output a test tone from each channel to manually balance the channel levels. Use this to set the channel levels so that the volume level of each channel is identical when heard from your listening position.

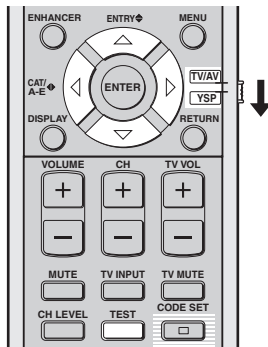

(U.S.A. and Canada models)

1 Set the operation mode selector to YSP.

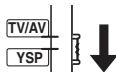

2 Press TEST.

“TEST FRONT L” appears in the front panel display and a test tone is output from the front left channel.

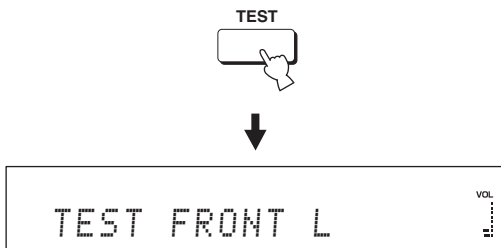

3 Press \triangle / ∇ to select the channel you want to adjust.

The front panel display changes as follows:

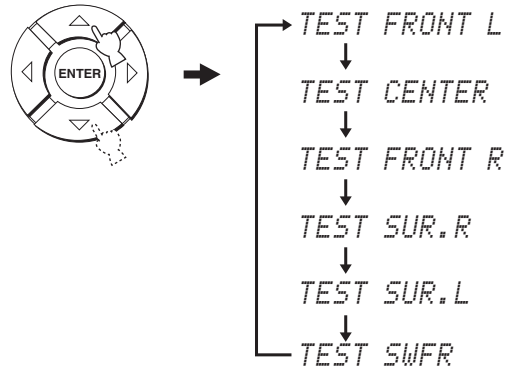

Note

“TEST SWFR” is only available when a subwoofer is connected to this unit and SWFR is selected for BASS OUT in SOUND MENU (see page 78).

4 Press \triangleleft / \triangleright to adjust the channel volume.

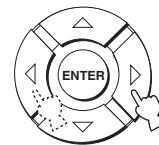

Control range: -10.0 dB to +10.0 dB

5 Press **TEST** when you have completed all your adjustments.



Notes

- All channel levels cannot be adjusted when the 2-channel or 5-channel stereo playback (see page 60), My Beam (see page 61), or My Surround (see page 55) is selected as the beam mode.
- “FRONT L/R” cannot be adjusted when Stereo plus 3 Beam is selected as the beam mode (see page 55).
- “FRONT L/R” are automatically adjusted depending on the settings of the other channels when Stereo plus 3 Beam or stereo playback is selected as the beam mode (see pages 55 and 60).



If the level of a particular channel cannot be adjusted, “--dB” appears in the front panel display.

Using the audio output being played back

You can also manually adjust the channel levels while playing back an input source such as a DVD.

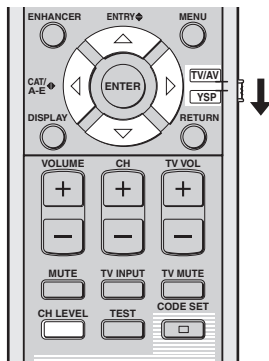

(U.S.A. and Canada models)

1 Set the operation mode selector to **YSP**.

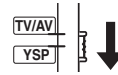

2 Press **CH LEVEL** repeatedly (or press **CH LEVEL** and \triangle / ∇) to select the channel you want to adjust.

The front panel display changes as follows.

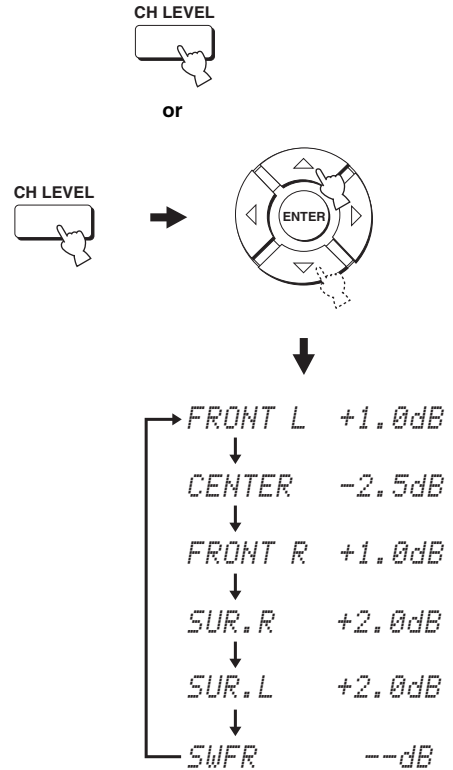

Note

“SWFR” is available only when a subwoofer is connected to this unit and SWFR is selected for BASS OUT in SOUND MENU (see page 78).

3 Press ◀ / ▶ to adjust the channel volume.

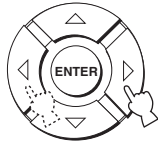

Control range: -10.0 dB to +10.0 dB

4 Wait for a few seconds without operating this unit when you have completed your adjustment.

Notes

- All channel levels cannot be adjusted when the 2-channel or 5-channel stereo playback (see page 60), or My Surround (see page 55) is selected as the beam mode.
- “FRONT L/R” cannot be adjusted when Stereo plus 3 Beam is selected as the beam mode (see page 41).
- Only CENTER can be adjusted when My Beam is selected as the beam mode (see page 61).
- “FRONT L/R” are automatically adjusted depending on the settings of the other channels when Stereo plus 3 Beam or stereo playback is selected as the beam mode (see pages 55 and 60).



If the level of a particular channel cannot be adjusted, “- dB” appears in the front panel display.

Selecting the input mode

You can select the type of audio input signals of the selected input source according to your preference or the conditions of the input source. This function is available for TV/STB, DVD, AUX1, and AUX2.



We recommend setting the input mode to AUTO in most cases.

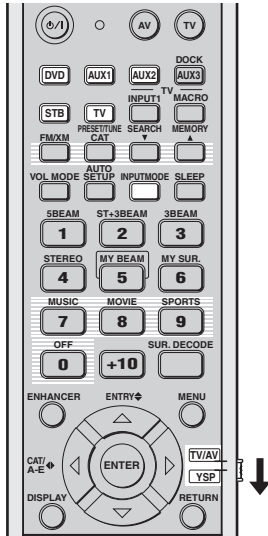

(U.S.A. and Canada models)

1 Set the operation mode selector to YSP.

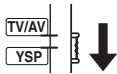

2 Press one of the input selector buttons to select the desired input source.

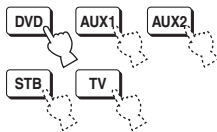

3 Press INPUTMODE repeatedly to toggle between input modes.

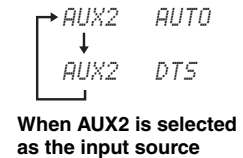
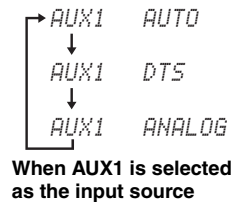
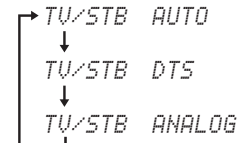
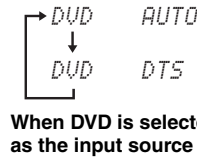
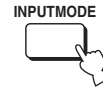

Note

ANALOG is not available as the input mode of DVD and AUX2.

• AUTO

Automatically selects audio input signals in the following priority order:

- 1) Dolby Digital or DTS
- 2) PCM
- 3) Analog



Use this input mode in most cases.

• DTS

Selects only digital signals encoded in DTS.

Compared to AUTO, this input mode provides greater stability while playing back CDs or LDs encoded in DTS.

• ANALOG

Selects only analog signals.

Even when both digital and analog signals are input simultaneously, only analog signals are selected.



You can adjust the default input mode to be selected when the power of this unit is turned on by adjusting INPUT MODE in INPUT MENU (see page 80).

Adjusting the system parameters

This unit has additional menus that are displayed in the front panel display. These menus offer additional operations to adjust and customize the way this unit operates.

Note

When “F.PANEL KEY” is set to “F.PANEL: OFF” (see page 93), STANDBY/ON on the front panel is ineffective. Use STANDBY/ON on the remote control instead to adjust the system parameters.

Using the system parameters

Follow the procedure below to enter the system parameters.

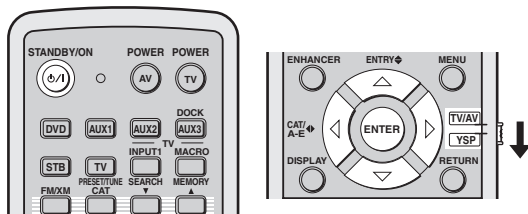
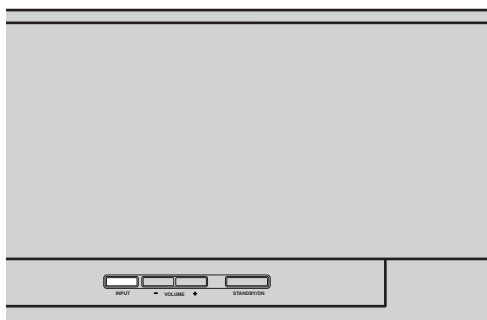

(U.S.A. and Canada models)

- 2 Press and hold INPUT on the front panel and press STANDBY/ON on the remote control to turn on the power of this unit.

“MEMORY PROTECT” is displayed in the front panel display.

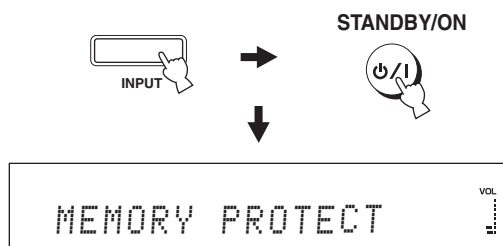

- 3 Release INPUT on the front panel.



- 1 Press STANDBY/ON on the remote control to turn off the power of this unit.

STANDBY/ON



Setting the MEMORY PROTECT

You can protect the settings you saved in the system memory of this unit from being accidentally erased or unwantedly changed.

1 Repeat steps 1 to 3 in “Using the system parameters” on page 88.

2 Set the operation mode selector to YSP.

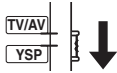

3 Confirm that “MEMORY PROTECT” is displayed in the front panel display and press ENTER.

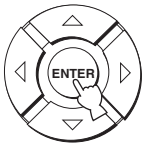

4 Press ◀ / ▶ to switch between “PROTECT: ON” and “PROTECT: OFF”.

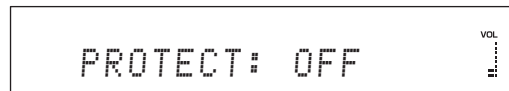
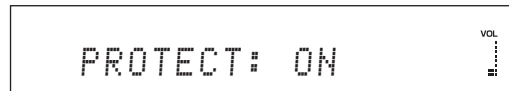
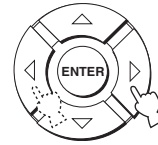

- Select PROTECT: ON to activate the protection feature.
- Select PROTECT: OFF to deactivate the protection feature.

5 Press STANDBY/ON on the remote control to set this unit to the standby mode.

STANDBY/ON



The new setting will be activated when you turn on the power of this unit next time.

Setting the MAX VOLUME

You can set the maximum volume level so that this unit will not output sound beyond the limited volume level.

1 Repeat steps 1 to 3 in “Using the system parameters” on page 88.

2 Set the operation mode selector to YSP.

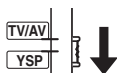

3 Press \triangle / ∇ so that “MAX VOLUME SET” is displayed in the front panel display.

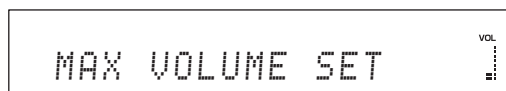
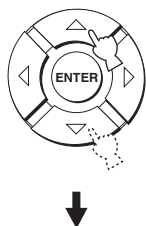

4 Press ENTER.

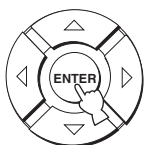

5 Press \triangle / ∇ to adjust the maximum volume level.

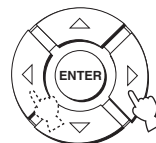

Control range: MAX, 99 to 01, MIN

Control step: 1

6 Press **STANDBY/ON** on the remote control to set this unit to the standby mode.

STANDBY/ON



The new setting for the maximum volume level will be activated when you turn on the power of this unit next time.

Setting the TURN ON VOLUME

You can set the initial volume level when the power of this unit is turned on.

1 Repeat steps 1 to 3 in “Using the system parameters” on page 88.

2 Set the operation mode selector to YSP.

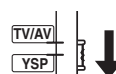

- 3** Press \triangle / ∇ so that "TURN ON VOLUME" is displayed in the front panel display.

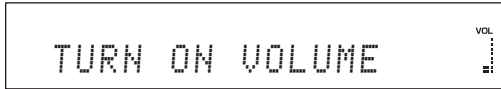

- 4** Press ENTER.



- 5** Press \triangleleft / \triangleright to adjust the initial volume level.

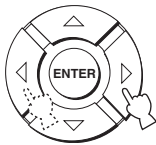

Control range: MAX, 99 to 01, OFF
Control step: 1

- 6** Press STANDBY/ON on the remote control to set this unit to the standby mode.

STANDBY/ON



The new setting for the maximum volume level will be activated when you turn on the power of this unit next time.

Setting the DEMO MODE

You can test the sound beam output from this unit to experience the sound beam.

- 1** Repeat steps 1 to 3 in "Using the system parameters" on page 88.

- 2** Set the operation mode selector to YSP.

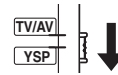

- 3** Press \triangle / ∇ so that "DEMO MODE" is displayed in the front panel display.

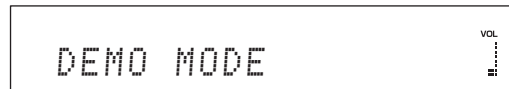
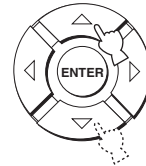

- 4 Press ◀ / ▶ to switch between “DEMO: ON” and “DEMO: OFF”.

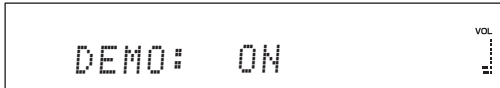
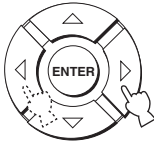

- Select DEMO: ON to activate the demo mode.
- Select DEMO: OFF to deactivate the demo mode.

- 5 Press STANDBY/ON on the remote control to set this unit to the standby mode.

STANDBY/ON



The new setting will be activated when you turn on the power of this unit next time.
 Press ENTER while playing back sources to test the sound beam.
 The sound beam being output shuttles between left and right. Press ENTER again to stop shuttling.

Setting the PANEL INPUT KEY

You can disable the INPUT on the front panel when you adjust the system parameters.

- 1 Repeat steps 1 to 3 in “Using the system parameters” on page 88.

- 2 Set the operation mode selector to YSP.

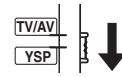

- 3 Press ▲ / ▼ so that “PANEL INPUT KEY” is displayed in the front panel display.

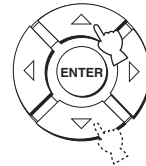

- 4 Press \triangle / ∇ to switch between “P.INPUT: ON” and “P.INPUT: OFF”.

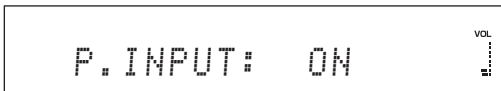
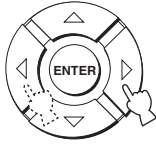

- Select P.INPUT: ON to enable the INPUT key on the front panel.
- Select P.INPUT: OFF to disable the INPUT key on the front panel. “F.PANEL KEY” is automatically set to “ON”.

- 5 Press **STANDBY/ON** on the remote control to set this unit to the standby mode.

STANDBY/ON



The new setting will be activated when you turn on the power of this unit next time.

Disabling the front panel keys

You can disable the front panel keys except when you adjust the system parameters.

- 1 Repeat steps 1 to 3 in “Using the system parameters” on page 88.
- 2 Set the operation mode selector to YSP.

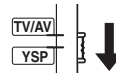

- 3 Press \triangle / ∇ so that “F.PANEL KEY” is displayed in the front panel display.

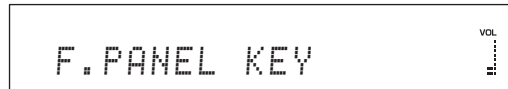

- 4 Press $\triangle / \triangleright$ to switch between “F.PANEL: ON” and “F.PANEL: OFF”.

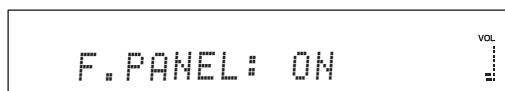
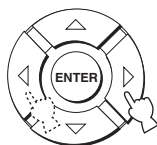

- Select F.PANEL: ON to enable the front panel keys.
- Select F.PANEL: OFF to disable the front panel keys. “P.INPUT” is automatically set to “ON”.

- 5 Press STANDBY/ON on the remote control to set this unit to the standby mode.

STANDBY/ON



The new setting will be activated when you turn on the power of this unit next time.

Setting the FACTORY PRESET

You can reset all of the parameters of this unit to the factory presets. This procedure completely resets ALL the parameters in SET MENU.

Note

After performing the following procedure you must run AUTO SETUP again to match your surround sound environment.

- 1 Repeat steps 1 to 3 in “Using the system parameters” on page 88.

- 2 Set the operation mode selector to YSP.



- 3 Press \triangle / ∇ so that “FACTORY PRESET” is displayed in the front panel display.



- 4 Press ENTER.

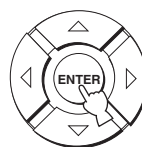

- 5** Press ◀/▶ to switch between “PRESET: RESET” and “PRESET: CANCEL”.

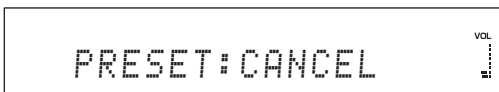
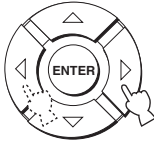

- Select PRESET: RESET to reset all of the current settings.
- Select PRESET: CANCEL to cancel the resetting procedure.

- 6** Press STANDBY/ON on the remote control to set this unit to the standby mode.

STANDBY/ON



The new setting will be activated when you turn on the power of this unit next time.

Remote control features

In addition to controlling this unit, the remote control can also operate other AV components made by Yamaha and other manufacturers. To control other components, you must set up the remote control with the appropriate remote control codes and set the operation mode selector to TV/AV to change the control area.

Note

Depending on the external AV component you are using, you may not be able to operate the component with the remote control, even if a remote control code is set. In this case, operate the component using the supplied remote control.

Setting remote control codes

You can control other components by setting the appropriate remote control codes. Codes can be set up for each input area (DVD, AUX1, AUX2, STB, and TV). For a complete list of available remote control codes, refer to “List of remote control codes” at the end of this manual.

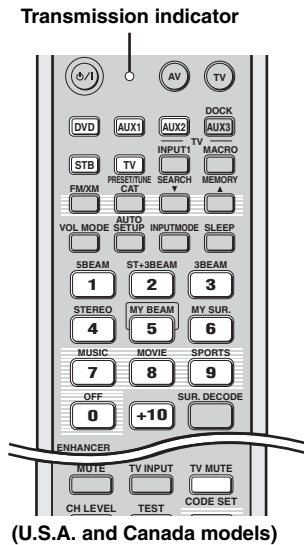

- 1 Press and hold CODE SET and press one of the input selector buttons to select the input source you want to set a remote control code for.**

The transmission indicator flashes twice and remains lit.

Proceed to step 2 while holding down CODE SET.



- 2 Press the numeric buttons to enter the remote control code while holding down CODE SET.**

Setting example: Yamaha DVD input area

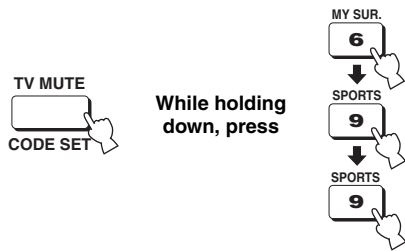

- 3 Refer to “Controlling other components” on page 97 to operate the external component using the remote control.**

If the external component functions correctly the remote control code setup is successful.

If the external component does not function correctly, the remote control code may be incorrect. Confirm that the remote control code is correct. See “List of remote control codes” at the end of this manual and start over from step 1.

Note

If the manufacturer of your component has more than one code, try each of them until you find the correct one.

If the remote control is without batteries for more than two minutes, or if exhausted batteries remain in the remote control, the contents of the memory may be cleared. When the memory is cleared, insert new batteries and reset the remote control codes. When changing the batteries, be careful not to press any of the buttons on the remote control. Doing so will clear the contents of the memory.

Controlling other components

■ Operating your TV

Set the operation mode selector to TV/AV, and press TV to select TV as the input source.

The control area of the remote control changes to the TV operation mode.

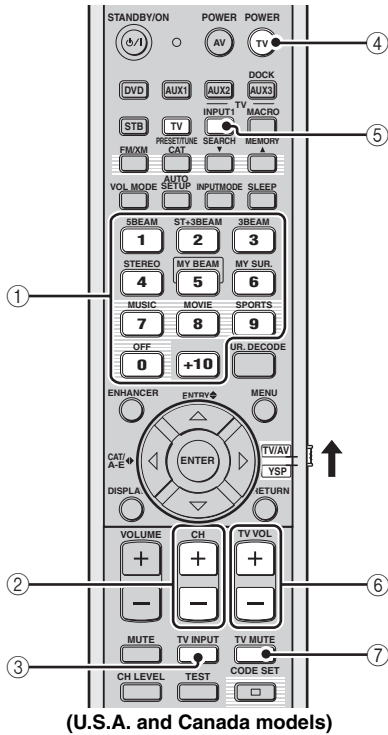

① Numeric buttons

Selects a TV channel for playback.

② CH +/-

Switches between the available TV channels.

③ TV INPUT

Switches the input source for your TV.

④ TV POWER

Turns on or off the power of your TV.

⑤ TV INPUT1

Selects the input source of your TV.

⑥ TV VOL +/-

Adjusts the audio output level of your TV.

⑦ TV MUTE

Temporarily mutes audio output from your TV.

■ Operating your DVD player/recorder

Set the operation mode selector to TV/AV and press DVD to select DVD as the input source.

The control area of the remote control changes to the DVD operation mode.

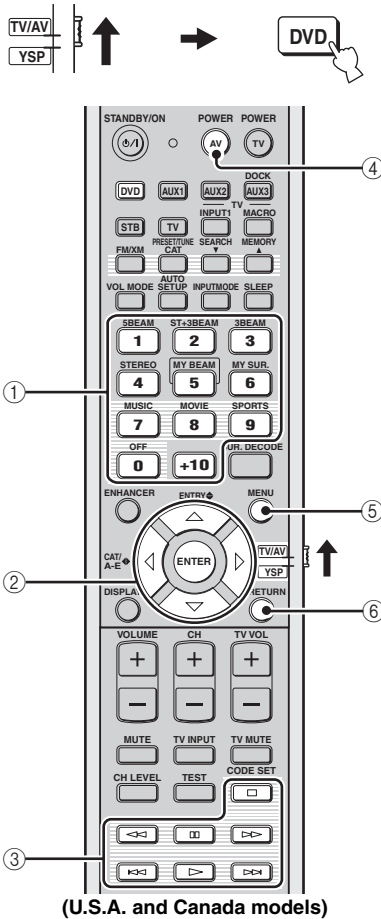

① **Numeric buttons**

Enter numeric digits.

② **Cursor buttons** \triangle / ∇ / \blacktriangleleft / \blacktriangleright , **ENTER**

Use to select DVD menu items.

③ **Operation buttons for DVD players**

Operate your DVD player/recorder, such as play and stop.

④ **AV POWER**

Turns on or off the power of your DVD player/recorder.

⑤ **MENU**

Displays the DVD menu.

⑥ **RETURN**

Use to return to the previous DVD menu screen or exit from the DVD menu.

■ Operating your STB (CATV/Satellite tuner)

Set the operation mode selector to TV/AV and press STB to select STB as the input source.

The control area of the remote control changes to the STB operation mode.

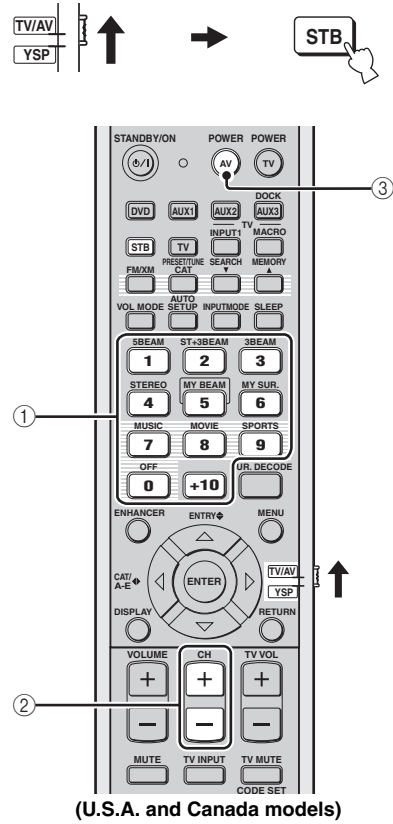

① **Numeric buttons**

Enter numeric digits.

② **CH +/-**

Switches between the available STB channels.

③ **AV POWER**

Turns on or off the power of your STB.

■ Operating your VCR

Set the operation mode selector to TV/AV and press **AUX1** to select VCR as the input source.

The control area of the remote control changes to the AUX1 operation mode.



This operation is available when your VCR is connected to the AUX 1 AUDIO INPUT jacks on this unit.

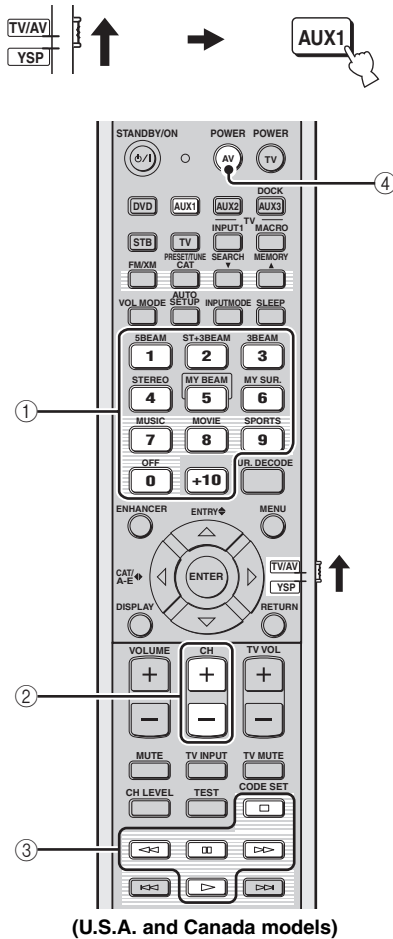

① Numeric buttons

Enter numeric digits.

② CH +/-

Switches between the available VCR channels.

③ Operation buttons for VCR

Operate your VCR, such as play and stop.

④ AV POWER

Turns on or off the power of your VCR.

Using the TV macro

The TV macro feature makes it possible to perform a series of operations with the press of a single button. For example, when you want to play a DVD, you would normally turn on the component, select DVD as the input source, and press the play button to start playback. The TV macro feature lets you perform all of these operations simply by pressing the DVD macro button.

Notes

- Be sure to set up a remote control code for your TV before setting macros.
- The ways to set macros differ if your TV does not have the tuning capability.
- If you press any control buttons on the remote control other than the ones used to set macros while setting macros, the setting procedure is automatically canceled.
- If it takes more than 10 seconds in steps 2 and 3, the setting procedure is automatically canceled. In this case, repeat from step 1.

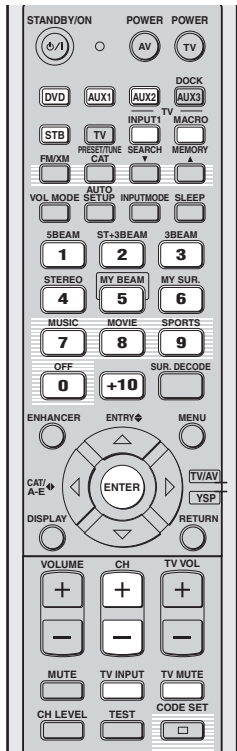

(U.S.A. and Canada models)

Setting macros for the TV with the tuning capability

- 1 Press and hold CODE SET and press one of the input selector buttons to select the input source you want to set macros for.**

Proceed to step 2 while holding down CODE SET.

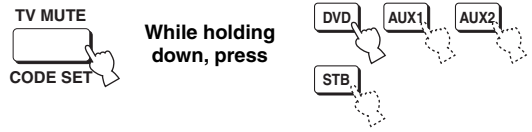

- 2 Press MACRO while holding down CODE SET.**

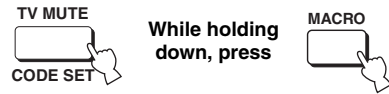

- 3 Press CH +/- or the numeric buttons to select the TV channel.**

Check that the TV screen changes to the tuner screen.

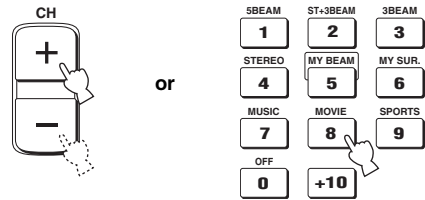

- 4 Press TV INPUT repeatedly until the screen changes to the display of the input source selected in step 1.**



- 5 Press ENTER to confirm the macro setting.**

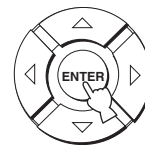

■ Setting macros for the TV without the tuning capability

- 1 Press and hold **CODE SET** and press one of the input selector buttons to select the input source you want to set macros for.

Proceed to step 2 while holding down **CODE SET**.



- 2 Press **MACRO** while holding down **CODE SET**.

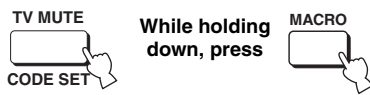

- 3 Press **INPUT1**.

Check that the TV screen changes to the input 1 screen.



- 4 Press **TV INPUT** repeatedly until the screen changes to the display of the input source selected in step 1.



- 5 Press **ENTER** to confirm the setting.

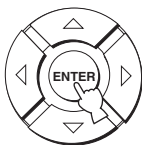

■ Operating macros

Press and hold one of the input selector buttons for approximately two seconds to select the input source you want to operate macros for.

The TV input changes at the same time the input mode changes.

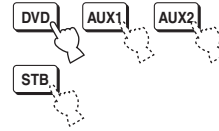

■ Canceling the macros

- 1 Press and hold **CODE SET** and press one of the input selector buttons to select the input source you want to cancel the macros for.

Proceed to step 2 while holding down **CODE SET**.



- 2 Press **MACRO** while holding down **CODE SET**.

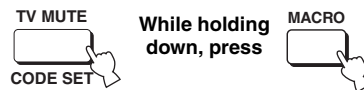

- 3 Press **ENTER** to cancel the macros.

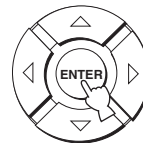

Troubleshooting

Refer to the chart below when this unit does not function properly. If the problem you are experiencing is not listed below or if the instruction below does not help, set this unit to the standby mode, disconnect the AC power supply cable, and contact the nearest authorized Yamaha dealer or service center.

■ General

Problem	Cause	Remedy	See page
This unit fails to turn on when STANDBY/ON is pressed, or enters the standby mode soon after the power has been turned on.	The AC power supply cable is not firmly connected to the AC wall outlet.	Connect the AC power supply cable firmly to the AC wall outlet.	29
	This unit has been exposed to a strong external electric shock (such as lightning and strong static electricity).	Set this unit to the standby mode, disconnect the AC power supply cable, plug it back in after 30 seconds, and use it normally.	—
This unit suddenly enters the standby mode.	The internal temperature becomes too high and the overheat protection circuitry has been activated.	Wait for about one hour for this unit to cool down and turn it back on.	—
	The sleep timer has turned the unit off.	Turn on the power and play back the source again.	—
No sound.	Incorrect input or output cable connections.	Connect the cables properly. If the problem persists, the cables may be defective.	19
	No appropriate input source has been selected.	Select an appropriate input source with INPUT or the input selector buttons.	45
	The volume is turned down.	Turn up the volume.	47
	The sound is muted.	Press MUTE or VOLUME +/- to resume audio output and adjust the volume level.	47
	The signals this unit cannot reproduce (such as PCM signals with more than 96 kHz of sampling frequency) are being received from the source component.	Play a source whose signals can be reproduced by this unit.	—
		Change the system settings of the source component.	—
	The HDMI components connected to this unit do not support the HDCP copy protection standards.	Connect the HDMI components that support the HDCP copy protection standards.	20
SUPPORT AUDIO is set to OTHER and HDMI audio signals are not being played back on this unit.	Set SUPPORT AUDIO to YSP-3000 in MANUAL SETUP	82	
The sound suddenly goes off.	The sleep timer has turned this unit off.	Turn on the power and play back the source again.	—
	The sound is muted.	Press MUTE or VOLUME +/- to resume audio output and adjust the volume level.	47
No sound from the effect channels.	You are playing back the source or program in the 2-channel stereo playback or My Beam mode.	Press one of the beam mode buttons on the remote control to select a multi-channel playback mode and play back the source or program once more.	54
No sound from the center channel.	The output level of the center channel is set to minimum.	Raise the level of the center channel.	84
No sound from the surround channels.	The output level of the surround channels is set to minimum.	Raise the output level of the surround channels.	84

Problem	Cause	Remedy	See page
No sound from the subwoofer.	BASS OUT in SUBWOOFER SET is set to FRONT.	Select SWFR.	78
	The source does not contain low bass signals.		
Distorted or too little bass sound.	CROSS OVER in SUBWOOFER SET is set incorrectly.	Set CROSS OVER correctly.	78
	One of the night listening enhancers is currently selected.	Turn off the night listening enhancers.	67
Too much bass sound.	TruBass is currently turned on.	Turn off TruBass.	79
	The volume level of the subwoofer is too high.	Turn down the volume level of the subwoofer.	—
Surround sound effects are insubstantial.	The listening room is not a regular shape.	Install this unit in a square or rectangular shaped room.	—
	There is no wall in the path of the sound beam.	Try placing a flat object, such as a board, in the path of the sound beam.	—
Dolby Digital or DTS sources cannot be played back. (Dolby Digital or DTS indicator does not light up in the front panel display.)	The connected component is not set to output Dolby Digital or DTS digital signals.	Make an appropriate setting following the operating instructions for your component.	—
	The input mode is set to ANALOG.	Set the input mode to AUTO.	87
There is noise interference when a subwoofer is not connected to this unit.	The protection circuitry was in operation because a source with strong bass elements was played back.	Turn down the volume level.	47
		Select SWFR for BASS OUT.	78
		Connect a subwoofer and adjust settings for SUBWOOFER SET.	78
Low-frequency sounds are distorted.	CROSS OVER in SUBWOOFER SET is set incorrectly.	Set CROSS OVER correctly.	78
On-screen display does not appear.	The OSD video pin cable is not connected properly.	Connect the cable properly.	22
This unit does not operate properly.	The internal microcomputer has been frozen by an external electric shock (such as lightning or excessive static electricity) or by a power supply with low voltage.	Disconnect the AC power supply cable from the outlet and plug it in again after about 30 seconds.	—
No sound is heard from the TV connected via HDMI.	The TV does not accept the multi-channel audio signals.	Convert the multi-channel audio signals to the 2-channel audio signals at the source component such as a DVD player.	—
	“SUPPORT AUDIO” is set to “YSP-3000”.	Set “SUPPORT AUDIO” to “OTHER”.	82
There is noise interference from digital or high-frequency equipment.	This unit is too close to the digital or high-frequency equipment.	Move this unit farther away from such equipment.	—
This unit does not output effect sounds properly.	The original source includes surround effects.	Disable the surround effect settings of this unit.	—
My Beam auto-adjust function does not work.	The listening room is too noisy.	Keep the listening room as quiet as possible.	—
		Try manual-adjust function.	62
	The sound reflectivity of the listening room is too much.	Set REFLECTING to HI ECHO.	79
	The remote control may be operated outside of the remote control operation range.	The remote control functions within a maximum range of 6 m (20 ft) and no more than 45 degrees off-axis from the front panel.	30
The function does not work properly because of the condition of the connected components.	Select My Beam and then try again.	61	

■ Remote control

Problem	Cause	Remedy	See page
The remote control does not work and/or function properly.	Wrong distance or angle.	The remote control functions within a maximum range of 6 m (20 ft) and no more than 45 degrees off-axis from the front panel.	30
	Direct sunlight or lighting (from an inverter type of fluorescent lamp, etc.) is striking the remote control sensor of this unit.	Reposition this unit.	—
	The batteries are weak.	Replace all batteries.	30
Cannot operate external components with the remote control of this unit.	The external component you want to operate is not selected as the input source.	Press INPUT on the front panel or the input selector buttons on the remote control to select the external component you want to operate.	45
	The remote control code was not correctly set.	Set the remote control code correctly or try another code for the same manufacturer using the “List of remote control codes” at the end of this manual.	96
	Even if the remote control code is correctly set, there are some models that do not respond to the remote control.	Use the remote control supplied with the external component.	—
The cursor buttons do not work during SET MENU operation.	The operation mode selector was unwantedly set to TV/AV.	Set the operation mode selector to YSP.	—
Cannot use the My Beam auto-adjust function.	Wrong distance or angle.	The remote control functions within a maximum range of 6 m (20 ft) and no more than 45 degrees off-axis from the front panel.	30

■ HDMI

Error message	Cause	Remedy	See page
Device Error	The number of the connected HDMI components exceeds the limit.	Reduce the number of the connected HDMI components.	—
HDCP Error	HDCP authentication failed.	Check that the connected HDMI components support the HDCP copy protection standards.	—

■ FM tuner

Problem	Cause	Remedy	See page
FM stereo reception is noisy.	The characteristics of FM stereo broadcasts may cause this problem when the transmitter is too far away or the antenna input is poor.	Check the antenna connections.	29
		Try using a high-quality directional FM antenna.	—
		Use the manual tuning method.	49
There is distortion, and clear reception cannot be obtained even with a good FM antenna.	There is multi-path interference.	Adjust the antenna position to eliminate multi-path interference.	—
The desired station cannot be tuned into with the automatic tuning method.	The signal is too weak.	Use a high-quality directional FM antenna.	—
		Use the manual tuning method.	49
Previously preset stations can no longer be tuned into.	This unit has been disconnected for a long period.	Preset the stations again.	50

Glossary

■ Dolby Digital

Dolby Digital is a digital surround sound system that gives you completely independent multi-channel audio. With 3 front channels (left, center, and right) and 2 surround stereo channels, Dolby Digital provides 5 full-range audio channels. With an additional channel especially for bass effects, called LFE (low-frequency effect), the system has a total of 5.1-channels (LFE is counted as 0.1-channel). By using 2-channel stereo for the surround channels, more accurate moving sound effects and surround sound environment are possible than with Dolby Surround. The wide dynamic range (from maximum to minimum volume) reproduced by the 5 full-range channels and the precise sound orientation generated using digital sound processing provide listeners with excitement and realism previously unheard of. With this unit, any sound environment from monaural up to a 5.1-channel configuration can be freely selected for your enjoyment.

■ Dolby Pro Logic II

Dolby Pro Logic II is an improved technique used to decode vast numbers of existing Dolby Surround software. This new technology enables a discrete 5-channel playback with 2 front left and right channels, 1 center channel, and 2 surround left and right channels (instead of only 1 surround channel for conventional Pro Logic technology). Music and Game modes are also available for 2-channel sources in addition to the Movie mode.

■ Dolby Surround

Dolby Surround uses a 4-channel analog recording system to reproduce realistic and dynamic sound effects: 2 front left and right channels (stereo), a center channel for dialog (monaural), and a surround channel for special sound effects (monaural). The surround channel reproduces sound within a narrow frequency range. Dolby Surround is widely used with nearly all video tapes and laser discs, and in many TV and cable broadcasts as well. The Dolby Pro Logic decoder built into this unit employs a digital signal processing system that automatically stabilizes the volume on each channel to enhance moving sound effects and directionality.

■ DTS Digital Surround

DTS digital surround was developed to replace the analog soundtracks of movies with a 6-channel digital sound track, and is now rapidly gaining popularity in movie theaters around the world. DTS, Inc. has developed a home theater system so that you can enjoy the depth of sound and natural spatial representation of DTS digital surround in your home. This system produces practically distortion-free 6-channel sound (technically, left, right, and center channels, 2 surround channels, plus an LFE 0.1-channel as a subwoofer, for a total of 5.1 channels). The unit incorporates a DTS-ES decoder that enables 6.1-channel reproduction by adding the surround back channel to existing 5.1-channel format.

■ DTS Neo:6

Neo:6 decodes the conventional 2-channel sources for 6-channel playback by the specific decoder. It enables playback with the full-range channels with higher separation just like digital discrete signal playback. Two modes are available: Music mode for playing music sources and Cinema mode for movies.

■ EUPHONY

Euphony is a revolutionary sound field reproduction system implemented with state-of-the-art sound technologies developed under the basic concept of enjoying beautiful sound. It can reproduce surround sound optimized without depending on the number of input channels, the number of speakers (two or more speakers) or the speaker's dimensions. In addition, it features steady center localization. It also can reproduce the surround sound for the headphones with natural sound and "out-of-head" localization so that the listener feels an expanded sound and will not tire, even when listening to music or a movie for long time.

■ HDMI

HDMI (High-Definition Multimedia Interface) is the first industry-supported, uncompressed, all-digital audio/video interface. Providing an interface between any source (such as a set-top box or AV receiver) and an audio/video monitor (such as a digital television), HDMI supports standard, enhanced, or high-definition video as well as multi-channel digital audio using a single cable. HDMI transmits all ATSC HDTV standards and supports 8-channel digital audio, with bandwidth to spare to accommodate future enhancements and requirements. When used in combination with HDCP (High-bandwidth Digital Content Protection), HDMI provides a secure audio/video interface that meets the security requirements of content providers and system operators. For further information on HDMI, visit the HDMI website at "<http://www.hdmi.org/>".

■ LFE 0.1-channel

This channel is for the reproduction of low bass signals. The frequency range for this channel is 20 Hz to 120 Hz. This channel is counted as 0.1 because it only enforces a low-frequency range compared to the full-range reproduction by the other 5/6 channels in Dolby Digital or DTS 5.1/6.1-channel systems.

■ Neural Surround

Neural Surround™ represents the latest advancement in surround technology and has been adopted by XM Satellite Radio for digital radio broadcast of surround recordings and live events in surround sound. Neural Surround™ employs psychoacoustic frequency domain processing which allows delivery of a more detailed sound stage with superior channel separation and localization of audio elements.

■ PCM (Linear PCM)

Linear PCM is a signal format under which an analog audio signal is digitized, recorded, and transmitted without using any compression. This is used as a method of recording CDs and DVD audio. The PCM system uses a technique for sampling the size of the analog signal per very small unit of time. Standing for pulse code modulation, the analog signal is encoded as pulses and then modulated for recording.

■ SRS TruBass

SRS TruBass is a psychoacoustic bass enhancement technology developed by SRS Labs, Inc. for speakers and headphone systems that delivers bass up to an octave below the physical capabilities of the speaker's driver. SRS TruBass technology takes advantage of a spontaneous tendency of the human ears to infer low-range audio data when presented with higher-frequency harmonic signals. As a result, our ears can hear the original low-range sound that the speaker system is incapable of producing.

Index

■ Numerics

3 Beam	55
5 Beam	54

■ A

AC power supply cable	29
Audio pin cable	20
AUTO SETUP (IntelliBeam)	35

■ B

Battery	30
BEAM MENU	74
Beam mode	54, 60, 61

■ C

Cable clamp	20
Cardboard microphone stand	37
CINEMA DSP	64

■ D

DEMO MODE	91
Demonstration DVD	6
Digital audio pin cable	20
DISPLAY MENU	83
Dolby Digital	56
Dolby Pro Logic	56
Dolby Pro Logic II	56
DTS	56
DTS Neo: 6	56
Dynamic range	79

■ E

EUPHONY	105
---------------	-----

■ F

FACTORY PRESET	94
Fastener	18
Front panel	7
Front panel display	8

■ H

HDMI	20
HDMI cable	20

■ I

IntelliBeam	35
IntelliBeam microphone	36

■ L

LFE 0.1-channel	106
-----------------------	-----

■ M

MANUAL SETUP	72
MEMORY	42
Movie program	64
Music program	64
My Beam	61

■ N

Night listening enhancer	67
--------------------------------	----

■ O

On-screen display (OSD)	32
Optical cable	20
OSD video pin cable	20

■ P

PCM	106
Power	31

■ R

Rear panel	9
Remote control	10
Remote control code	96
Remote control sensor	30

■ S

SET MENU	32
Sleep timer	68
Sound field program	63
Stereo plus 3 Beam	55
Surround mode	56
Surround sound	54
SOUND MENU	78
Sports program	64
Stereo sound	60
System parameter	88

■ T

Test tone	84
TruBass	79
TV macro	100
TV volume equal mode	67

■ V

Volume	47
Volume mode	67

Specifications

AMP SECTION

- Maximum Output Power (JEITA)
 - 2 W (1 kHz, 10% THD, 4 Ω) × 21
 - 20 W (100 Hz, 10% THD, 4 Ω) × 2

SPEAKER SECTION

- Small dia. speakers
 - 4 cm (1-9/16 in) cone magnetic shielding type × 21
- Woofers
 - 10 cm (3-15/16 in) cone magnetic shielding type × 2
- Input Jacks
 - TV/STB, AUX 1 AUDIO IN (1 V, 32 kΩ) 2 pairs (Analog)
 - TV/STB, AUX 1 OPTICAL DIGITAL IN 2 (Optical digital)
 - DVD, AUX 2 COAXIAL DIGITAL IN 2 (Coaxial digital)
 - AUX 1, DVD HDMI IN 2
 - AUX 3 1
- Output Jacks
 - SUBWOOFER OUT (1.5 V, less than 120 Hz) 1 (Subwoofer)
 - VIDEO OUT (1 V_{p-p}, 75 Ω) 1 (OSD)
 - HDMI OUT 1
- System Connector Jack
 - INTELLIBEAM MIC 1 (Microphone input)

FM SECTION

- Tuning Range
 - [U.S.A. and Canada models] 87.5 to 107.9 MHz
 - [Asia model] 87.5/87.50 to 108.0/108.00 MHz
 - [Other models] 87.50 to 108.00 MHz

GENERAL

- Power Supply
 - [U.S.A. and Canada models] AC 120 V, 60 Hz
 - [Australia model] AC 220–240 V, 50/60 Hz
 - [U.K. and Europe models] AC 220–240 V, 50/60 Hz
 - [Korea model] AC 220–240 V, 50/60 Hz
 - [General model] AC 110–120 V, 50/60 Hz
 - [Asia model] AC 220–240 V, 50/60 Hz
- Power Consumption 32 W
- Standby Power Consumption 0.5 W or less
- Dimensions (W x H x D) 800 × 155 × 152 mm
(31-1/2 x 6-3/32 x 5-31/32 in)
- Weight 11.5 kg (25 lbs 6 oz)

* Specifications are subject to change without notice.

HDMI interface of this unit is based on the following standard:

- HDCP (High-bandwidth Digital Content Protection System) licensed by Digital Content Protection, LLC.

List of remote control codes

TV		PROSCAN 231, 241, 251	VCR	PHONOLA 337
ADMIRAL 292, 293, 216		PROTON 297, 250, 260, 270	ADMIRAL 395	PILOT 396
AIWA 294, 276, 283, 284		QUASAR 234, 235	AIWA 396, 397, 398, 329	PIONEER 325
AKAI 295, 296		RADIO SHACK 299, 293, 297	AKAI 322, 323, 324	QUASAR 325, 328
ALBA 296		RCA 293, 297, 234, 256, 257, 258, 221	AUDIO DYNAMIC 392, 394	RCA/PROSCAN 325, 326, 328, 333, 335, 349, 358, 363, 397
AOC 297		RUNCO 220, 230, 271	BELL & HOWELL 393	REALISTIC 393, 397, 328, 336, 359, 362, 396, 363
BELL & HOWELL 292		SABA 223, 269, 265, 266	BLAUPUNKT 325, 326	SAMSUNG 354, 358, 363, 364, 365, 366
BESTAR 298		SAMPO 281, 297, 280	BROC SONIC 327	SANSUI 394
BLAUPUNKT 229, 222		SAMSUNG 297, 239, 248, 262, 275	BUSH 322	SANYO 393, 336, 367
BLUE SKY 298		SANYO 295, 233, 279, 272, 273, 274, 212	CANON 325, 328	SCHNEIDER 337
BRANDT 223		SCHNEIDER 296	CGM 396, 332	SCOTT 399, 335, 336, 348, 359, 354, 358, 352
BROC SONIC 297		SCOTT 297	CITIZEN 396	SELECO 322
BUSH 296		SHARP 292, 239, 232, 213, 208	CRAIG 396, 363	SHARP 395, 362, 382
BYD:SIGN 201, 202		SIEMENS 229	CURTHIS MATHIS 397, 328, 333	SIEMENS 393
CLATRONIC 298		SIGNATURE 216	DAEWOO 328, 334, 335	SIGNATURE 2000 395, 397
CRAIG 224		SIGNATURE 292	DBX 392, 394	SONY 368, 379, 372, 373, 374, 375
CROSLEX 225, 298		SONY 263, 214	DIMENSIA 333	SYLVANIA 397, 325, 326, 328
CURTIS MATHIS 297, 226		SYLVANIA 297, 225, 298	DYNATECH 397	SYMPHONIC 397
DAEWOO 297, 298, 224, 227, 228		SYMPHONIC 217, 218, 219	EMERSON 327, 334, 396, 397	TANDBERG 334
DAYTRON 239		TELEFUNKUN 269, 264, 265, 266	FISHER 393, 336	TANDY 397
DUAL 298		THOMSON 223, 266	FUNAI 397	TASHIRO 396
DWIN 293, 281		TOSHIBA 292, 226, 267, 215	GE 328, 333, 387	TATUNG 392, 394
EMERSON 297, 224, 239, 232		VIDECH 297, 242	GO VIDEO 321, 331, 341, 351, 363	TEAC 392, 394, 397
FURGUSON 223, 265, 266		WARDS 297, 239, 232, 216	GOODMANS 334, 337	TECHNICS 325, 328
FIRST LINE 298		YAMAHA 299, 292, 242, 285, 287, 253, 206	GRUNDIG 332, 338	TEKNIKA 396
FISHER 295, 233		YAMAHA 298	HITACHI 325, 333, 349, 342, 343	TELEFUNKUN 376, 377
FRABA 298		ZENITH 216, 261, 271	INSTANT REPLAY 325, 328	THOMAS 397
FUJITSU 289			ITT/NOKIA 393	THORN 393, 396
FUNAI 277, 278		DVD PLAYER	JC PENNY 392, 393, 394, 328, 333, 349, 396, 363	TOSHIBA 335, 389
GE 293, 297, 234, 235, 236		AIWA 648, 649	JVC 392, 394, 344, 345, 346, 347	TOTEVISION 363, 396
GOODMANS 296, 298, 223		APEX DIGITAL 652, 653, 654	KENDO 396	UNITECH 363
GRUNDIG 229, 238, 249		BYD:SIGN 678, 679	KENWOOD 392, 394, 396	UNIVERSUM 396, 327, 376
HITACHI 297, 239, 242, 243, 285, 206		DAEWOO 655	LG/GOLDSTAR 396, 388	VIDEOSONIC 363
ICE 296		DENON 623, 624, 682	LOEWE 396, 337	W.WHOUSE 396
IRRADIO 296		FUNAI 625	LUXOR 395	WARDS 395, 396, 336, 362, 397, 363
ITT/NOKIA 244, 245		HARMAN/KARDON 656, 657	LXI 393, 396, 397, 336, 349	YAMAHA 399, 392, 393, 394
JC PENNY 293, 297, 234, 237		HITACHI 626, 688, 689	MAGNAVOX 325, 326, 328	ZERITH 344, 361, 368, 371, 379, 396, 397
JVC 296, 246, 247, 286		JVC 627, 643, 692	MARANTZ 392, 394	
KENDO 298		KENWOOD 628	MARTA 396	CABLE TV TUNER
KTV 297, 239		KLH 658	MATSUI 396	ABC 739, 752, 753, 755, 758, 759, 762
LG/GOLDSTAR 297, 298, 239, 237		LG/GOLDSTAR 645, 663, 664	MEMOREX 328, 336, 396, 397	GENERAL INSTRUMENT 722, 786, 787, 788
LOEWE 298, 248, 207		MARANTZ 699, 659	MINOLTA 333, 349	HAMIN 723, 724, 725, 726, 727
LXI 293, 297, 225, 226, 233, 298		MITSUBISHI 629	MITSUBISHI 399, 344, 348, 359, 353, 352	HITACHI 722
MAGNAVOX 297, 225, 239, 298		ONKYO 632, 633, 634	MULTITECH 397, 348, 354	JEROLD 722, 728, 729, 732, 733, 734, 735, 736, 737
MARANTZ 298, 210		PANASONIC 623, 635, 668, 672, 682, 683, 684	NEC 392, 394, 344, 383	MAGNAVOX 738
MATSUI 295		PHILIPS 699, 647, 659	NOKIA 393, 395	MOTOROLA 748, 728
MEDION 203, 204, 298		PIONEER 636, 637, 638, 673, 674, 675, 685, 686, 687	NOKIA OCEANIC 395	OAK 739, 742, 743
MEMOREX 297, 216		RCA 639	OKANO 323	PANASONIC 744, 745, 746, 747, 783, 784
MITSUBISHI 299, 297, 259, 287		SAMSUNG 642	OLYMPIC 325, 328	PHILLIPS 763, 764, 765, 766, 767, 768
NAD 226, 255		SHARP 643, 692	ORION 327	PIONEER 748, 785, 747
NEC 297, 252, 282		SONY 644, 676, 677	PANASONIC 325, 328, 339, 355, 378, 384, 385, 386	RADIO SHACK 749
NOKIA 244, 245		SYLVANIA 662	PENTAX 333, 349	
NOKIA OCEANIC 245		SYMPHONIC 662	PHILCO 325, 328, 397	
NORDMENDE 265, 266		THOMSON 646	PHILLIPS 325, 326, 328, 337, 356, 357	
ONWA 296		TOSHIBA 634, 665, 666, 667		
PANASONIC 234, 235, 236, 253, 288, 211		YAMAHA 699, 622, 623, 647, 682		
PHILCO 297, 225, 239, 298		ZERITH 663, 664		
PHILIPS 298, 225, 205				
PIONEER 226, 235, 254, 255, 268				
PORTLAND 297, 256				
PROSCAN 293, 221				

RCA 744, 792, 793
SCIENTIFIC ATLANTA 752, 753, 754, 789
SONY 756, 757
TOCOM 755
UNIVERSAL 769, 772, 773,
774, 775
VIEWSTAR 764, 766, 776,
777, 778, 779, 782

SATELLITE TUNER

ECHOSTAR 822
GE 837, 838, 839
GENERAL INSTRUMENT 823
HITACHI 824
HUGHES 843, 844, 845, 846
JVC 822
MAGNAVOX 825
PANASONIC 826, 829
PHILLIPS 825, 843, 844,
845, 846, 847,
848, 849
PRIMESTAR 827
PROSCAN 837, 838, 839, 842
RADIO SHACK 828
RCA 837, 838, 839, 842
SAMSUNG 852
SKY+ 853
SKY HD 853
SONY 832, 835
TOSHIBA 833, 836
UNIDEN 825
ZENITH 834



© 2007 YAMAHA CORPORATION All rights reserved.

YAMAHA ELECTRONICS CORPORATION, USA 6660 ORANGETHORPE AVE., BUENA PARK, CALIF. 90620, U.S.A.
YAMAHA CANADA MUSIC LTD. 135 MILNER AVE., SCARBOROUGH, ONTARIO M1S 3R1, CANADA
YAMAHA ELECTRONIK EUROPA G.m.b.H. SIEMENSSTR. 22-34, 25462 RELINGEN BEI HAMBURG, GERMANY
YAMAHA ELECTRONIQUE FRANCE S.A. RUE AMBROISE CROIZAT BP70 CROISSY-BEAUBOURG 77312 MARNE-LA-VALLEE CEDEX02, FRANCE
YAMAHA ELECTRONICS (UK) LTD. YAMAHA HOUSE, 200 RICKMANSWORTH ROAD WATFORD, HERTS WD18 7GQ, ENGLAND
YAMAHA SCANDINAVIA A.B. J A WETTERGRENS GATA 1, BOX 30053, 400 43 VÄSTRA FRÖLUNDA, SWEDEN
YAMAHA MUSIC AUSTRALIA PTY, LTD. 17-33 MARKET ST., SOUTH MELBOURNE, 3205 VIC., AUSTRALIA

YAMAHA CORPORATION
Printed in Malaysia ◀ WK75380

YSP-3000

Digital Sound Projector™

Reference Guide for iPod™/XM Radio

Overview

This is the Reference Guide for Yamaha YSP-3000 Digital Sound Projector. This guide explains the connections and operations of iPod and XM Satellite Radio (U.S.A. and Canada models only). Operations in this guide use keys on the supplied remote control unless otherwise specified. For general information including the controls and functions of this unit, refer to the owner's manual.



The illustrations used in this Reference Guide are for U.S.A. and Canada models only.

iPod™

“iPod” is a trademark of Apple Inc., registered in the U.S. and other countries.



The XM name and related logos are registered trademarks of XM Satellite Radio Inc.



Neural Surround™ name and related logos are trademarks owned by Neural Audio Corporation.

Contents

Using iPod™	2
Connection.....	2
Controlling iPod™	2
XM™ Satellite Radio tuning (U.S.A. and Canada models only)	5
Connecting XM™ Mini-Tuner Home Dock	5
Activating XM™ Satellite Radio	6
Basic XM™ Satellite Radio operations	6
Presetting the XM™ Satellite Radio channels	9
Displaying the XM™ Satellite Radio information.....	10
Troubleshooting	11

Using iPod™

This unit has the DOCK terminal on the rear panel that allows you to connect the Yamaha iPod universal dock (such as YDS-10, sold separately). Station your iPod in the Yamaha iPod universal dock, and use the supplied remote control to operate your iPod.

Notes

- Only iPod (Click and Wheel), iPod nano, and iPod mini are supported.
- Some features may not be compatible depending on the model or the software version of your iPod.

Connection

Connect the Yamaha iPod universal dock to the DOCK terminal of this unit using a dedicated cable.

CAUTION

Do not connect this unit or other components to the main power until all connections between components are complete.

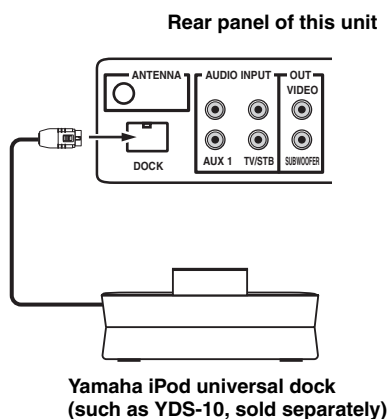

When your iPod and external component using the AUX 3 input jack are connected to this unit at the same time, and when the DOCK indicator is lit in the front panel display, iPod output takes priority.

Controlling iPod™

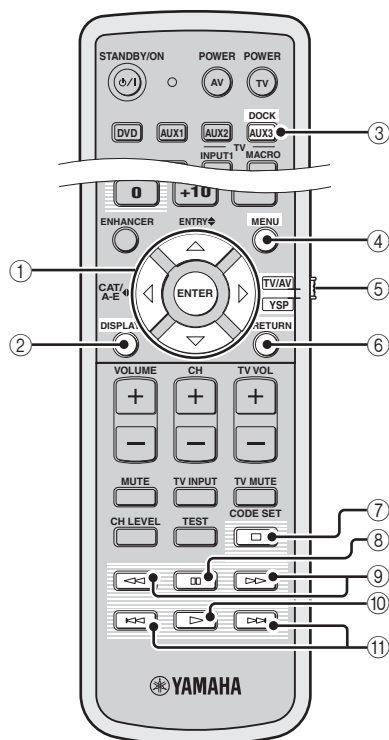

(U.S.A. and Canada models)

- ① Navigate through the iPod menu (Δ / ∇ / \leftarrow / \rightarrow) and starts playback (ENTER).
- ② Displays the OSD (on-screen menu) menu.
- ③ Selects AUX3/DOCK (U.S.A. and Canada models) or AUX3 (Australia model) as the input source.
- ④ Use to return to the previous iPod menu.
- ⑤ Sets the operation mode of this unit.
- ⑥ Use to return to the previous iPod menu.
- ⑦ Stops playback.
- ⑧ Pauses playback.
- ⑨ Searches forward/backward.
- ⑩ Starts playback.
- ⑪ Skips to the beginning of the current/previous/next track.



⑧ and ⑨ toggle between play and pause operations in the Simple Remote mode.



- For a complete list of status messages that appear in the front panel display and in the OSD, see the “iPod” section in “Troubleshooting” on page 11.
- While your iPod is stationed in the Yamaha iPod universal dock connected to the DOCK terminal of this unit, your iPod battery is automatically charged as long as this unit is turned on.

■ Controlling iPod in the Simple Remote mode

You can perform some basic operations such as play, pause, stop, backward/forward search, and track skip using the remote control without the aid of the OSD. Such basic operations can be performed also on your iPod.

1 Set the operation mode selector to TV/AV.

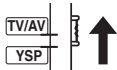

2 Press AUX3/DOCK (U.S.A. and Canada models) or AUX3 (Australia model), and set your iPod in the Yamaha iPod universal dock.

In the front panel display, “iPod connected” appears and the DOCK indicator lights up.

Lights up

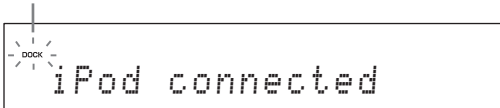

- You can view the photos or video clips stored on your iPod. However, you cannot view the OSD that appears only in the iPod screen.
- Use > and ◀ on the remote control interchangeably to toggle between play and pause operations.

Note

Information on the current song appears only in the iPod screen but not in the front panel display of this unit.

■ Controlling iPod in the Menu Browse mode

You can perform the advanced operations using the remote control with the aid of the OSD (see the owner’s manual for information on the OSD). In the OSD, you can browse the song list stored on your iPod. Further, you can change or adjust the settings on your iPod as desired. Such advanced operations cannot be performed on your iPod.

1 Set the operation mode selector to TV/AV.

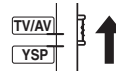

2 Press AUX3/DOCK (U.S.A. and Canada models) or AUX3 (Australia model), and set your iPod in the Yamaha iPod universal dock.

In the front panel display, “iPod connected” appears and the DOCK indicator lights up.

Lights up

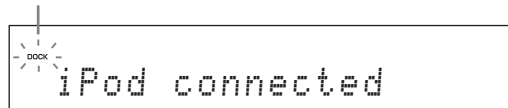

3 Press DISPLAY, and display the menu browse mode.

The OSD appears on your TV.



- 4 Press \triangle / ∇ and \leftarrow / \rightarrow to navigate through the iPod menu, and press ENTER to start playback of the selected song.**

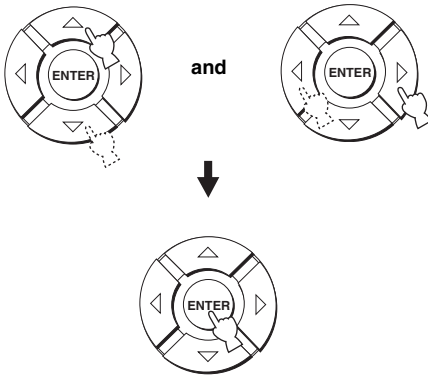

Choices: Playlists (playlists), Artists (artists), Albums (albums), Songs (songs), Genres (genres), Composers (composers), Settings (settings)

- Playlists > Songs
- Artists > Albums > Songs
- Albums > Songs
- Songs
- Genres > Artists > Albums > Songs
- Composers > Albums > Songs
- Settings > Shuffle, Repeat

Settings parameters:

Shuffle Shuffle

Use this function for random playback of songs or albums. When “Songs” or “Albums” is chosen, “S” appears in the top right corner while the songs or albums are being shuffled. Press ENTER repeatedly to toggle between the choices.

Choices: Off, Songs, Albums

- Select “Off” to deactivate this function.
- Select “Songs” for random playback of songs.
- Select “Albums” for random playback of albums.

Repeat Repeat

Use this function for repeated playback of a song or a sequence of songs. When “One” or “All” is chosen, “R” appears in the top right corner while a song or a sequence of songs are being repeated. Press ENTER repeatedly to toggle between the choices.

Choices: Off, One, All

- Select “Off” to deactivate this function.
- Select “One” for repeated playback of a song.
- Select “All” for repeated playback of a sequence of songs.



- Press RETURN or MENU to go back to the previous menu.
- The information on the current song also appears in the front panel display. You can set the front panel display mode: CONT. or ONCE. For details, see “SCROLL” (Front panel display scroll) in “F.DISPLAY SET” (Front panel display settings) in the owner’s manual (see page 83).
- You can set the interval for which the OSD screen is displayed after an operation. See “OSD DISPLAY TIME” (OSD display time) in “OSD SET” (OSD settings) in the owner’s manual (see page 83).

Notes

- The YAMAHA logo appears in the iPod screen in this mode.
- Undisplayable characters are shown as underscores “_” in the front panel display and OSD.
- You can change or adjust the “Settings” parameters only in the OSD.
- You cannot view the photos or video clips stored on your iPod in this mode. Use the Simple Remote mode to enjoy browsing the photos or video clips stored on your iPod.

■ An example of the information display during playback



- ① Track number/total tracks
- ② Name of the artist
- ③ Name of the album
- ④ Name of the song
- ⑤ Progress bar
- ⑥ Elapsed time
- ⑦ Shuffle and repeat icons
- ⑧ ► (playback), ■■ (pausing), ►► (search forward), and ◀◀ (search backward)
- ⑨ Remaining time

XM™ Satellite Radio tuning (U.S.A. and Canada models only)

■ About XM Satellite Radio

XM Satellite Radio offers an extraordinary variety of commercial-free music, plus the best in sports, news, talk, and entertainment. XM is broadcast in superior digital audio from coast to coast. From rock to reggae, from classical to hip hop, XM has something for every music fan. XM's dedication to playing the richest selection of music is matched by its passion for live sporting events, talk radio, up-to-the-minute news, stand-up comedy, children's programming, and much more.

XM READY Legal Disclaimer

Hardware and required monthly subscription sold separately. Other fees and taxes, including a one-time activation fee may apply. Subscription fee is consumer only. All fees and programming subject to change. Channels with frequent explicit language are indicated with an XL. Channel blocking is available for XM radio receivers by calling 1-800-XMRADIO (US residents) and 1-877-GET-XMSR (Canadian residents). For a full listing of the XM commercial-free channels and advertising-supported channels, visit lineup.xmradio.com (US residents) or www.xmradio.ca (Canadian residents). Subscriptions subject to Customer Agreement available at xmradio.com (US residents) and xmradio.ca (Canadian residents). Service only available in the 48 contiguous United States and Canada. ©2007 XM Satellite Radio Inc. All rights reserved. All other trademarks are the property of their respective owners.



This unit is equipped with the Neural Surround decoder that plays back the XM HD surround sound content of the XM Satellite Radio broadcasts in multi-channels, resulting in a full surround sound experience. See "Surround modes and recommended sources" in the owner's manual (see page 56).

Note

The XM Satellite Radio service is unavailable in Alaska and Hawaii.

Connecting XM™ Mini-Tuner Home Dock

Connect XM Mini-Tuner and Home Dock (each sold separately by XM Satellite Radio) to the XM jack on the rear panel of this unit. For information on your XM Mini-Tuner and Home Dock, see the operating instructions provided with XM Mini-Tuner Home Dock.

XM Mini-Tuner and Home Dock
(each sold separately)

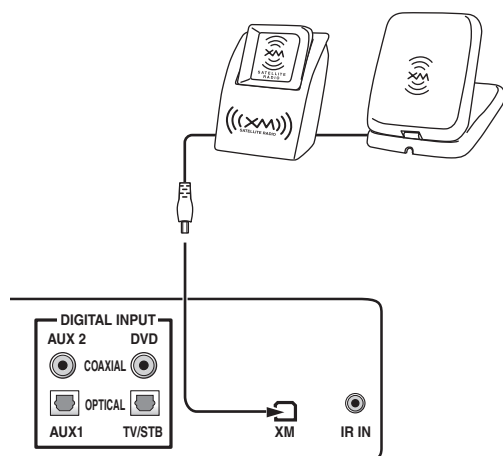

Rear panel of this unit



- To ensure optimal reception of the XM Satellite Radio signals, the antenna of Home Dock must be placed at or near a south-facing window with no obstacles in the path to the sky. You can mount it indoors or outdoors.
- Use the "XM ANTENNA LEVEL" parameter in "MANUAL SETUP" (see page 82 in the owner's manual) to display the XM Satellite Radio reception level (%) in the OSD. For the best reception, adjust the orientation of the connected indoor antenna of the Home Dock to obtain a value of 60% or more.

Note

If "CHECK ANTENNA" appears in the front panel display, Home Dock may not be connected properly to the XM jack on the rear panel of this unit.

Activating XM™ Satellite Radio

Once you have installed XM Mini-Tuner Home Dock, inserted XM Mini-Tuner, connected Home Dock to your XM READY home audio system, and installed the antenna, you are ready to subscribe and begin receiving XM programming. There are three places to find your eight-character XM Radio ID: on XM Mini-Tuner, on XM Mini-Tuner package, and on XM Channel 0 (see “All Channel Search mode” on page 7). Record the XM Radio ID in the following eight squares for reference.



Note

The XM Radio ID does not use the letters “I”, “O”, “S”, or “F”. Activate your XM Satellite Radio service in the U.S. online at <http://www.xmradio.com/> or call 1-800-XM-RADIO (1-800-967-2346). You will need a major credit card. XM will send a signal from the satellites to activate the full channel lineup. Activation normally takes 10 to 15 minutes, but during peak busy periods you may need to keep your XM READY home audio system on for up to an hour. When you can access the full channel lineup on your XM READY home audio system, you are done. For more information or to subscribe in Canada, visit XM on the Web at <http://www.xmradio.ca/> or call XM’s Listener Care at 1-877-GET-XMSR (1-877-438-9677).

Basic XM™ Satellite Radio operations

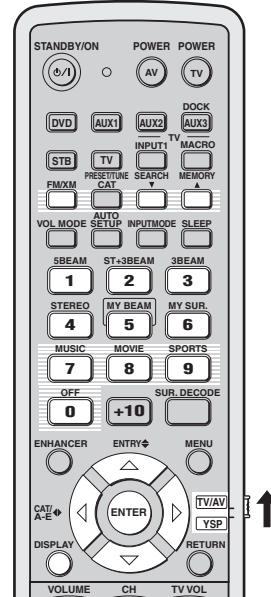

- 1 Set the operation mode selector to TV/AV.

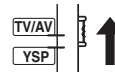

- 2 Press FM/XM repeatedly to select XM as the input source.

In the front panel display, the XM indicator lights up and the XM Satellite Radio information (channel number/channel name, channel category, and artist name/song or program title) for the currently selected channel appears.

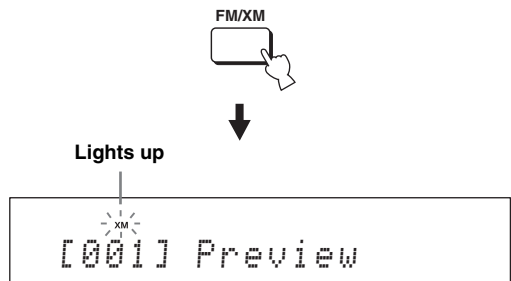

- You can also press INPUT on the front panel repeatedly to select XM as the input source.
- When XM is selected as the input source, this unit automatically recalls the previously chosen channel.

3 Search for a desired channel by using one of the four XM Satellite Radio search modes:

- To select a channel from all channels, see “All Channel Search mode” on this page.
- To select a channel by channel category, see “Category Search mode” on this page.
- To select a channel from the preset channels, see “Preset Search mode” on page 8.
- To select a channel by directly entering the channel number, see “Direct Number Access mode” on page 8.



- You can preset the XM Satellite Radio channels (see page 9).
- You can display the XM Satellite Radio information in the front panel display and/or in the OSD (see page 10).

■ All Channel Search mode

1 Press SEARCH repeatedly to select “ALL CH SEARCH”.

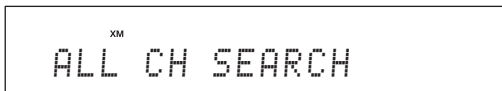

2 Press ENTRY (▲ / ▼) repeatedly to search for an XM channel within all channels.



- Hold down ENTRY (▲ / ▼) for quick search.
- To change the channel category, press CAT/A-E (◀ / ▶).
- Select channel “0” to display your XM Radio ID number.

■ Category Search mode

1 Press SEARCH repeatedly to select “CAT SEARCH”.



2 Press CAT/A-E (◀ / ▶) repeatedly to change the XM channel category.

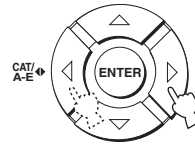

3 Press ENTRY (▲ / ▼) repeatedly to search for an XM channel within the selected channel category.

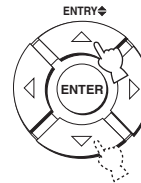

Hold down ENTRY (▲ / ▼) for quick search.

■ Preset Search mode

Prior to selecting a preset channel in the Preset Search mode, you must preset the XM channels. For details, see “Presetting the XM™ Satellite Radio channels” on page 9.

- 1 Press **SEARCH** repeatedly to select “PRESET SEARCH”.

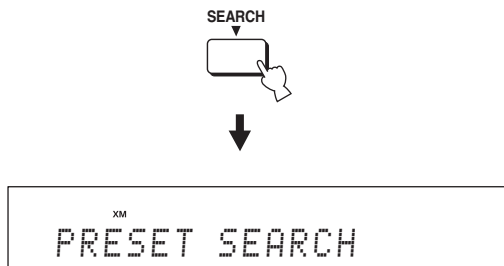

- 2 Press **CAT/A-E** (◀/▶) repeatedly to change the preset channel group (A to E).

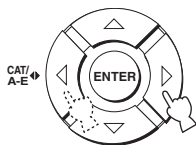

- 3 Press **ENTRY** (▲ / ▼) repeatedly to change the preset channel number (1 to 8).



You can also use the numeric buttons to directly input the preset channel number.

■ Direct Number Access mode

- 1 Press **SEARCH** repeatedly to select either “ALL CH SEARCH” or “CAT SEARCH”.

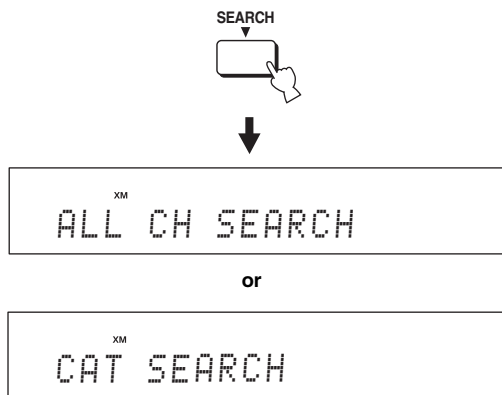

- 2 Press the numeric buttons (0 to 9) to enter the desired three-digit XM channel number.

For example, to enter the number 123, press the numeric buttons 1, 2, and 3.



The front panel display changes as follows:

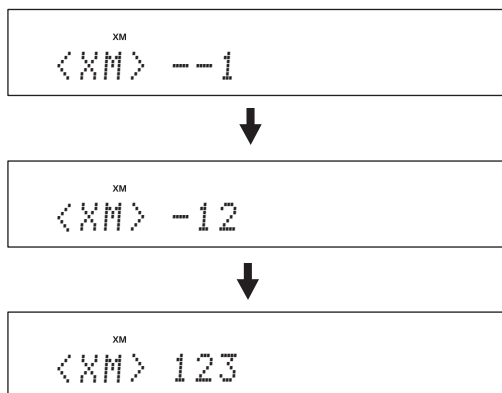

Notes

- To enter a one- or two-digit number, press the corresponding number button(s), and press ENTER to confirm the number. If you do not press ENTER, this unit automatically confirms the entered number after a few seconds.
- If you press a button other than the numeric buttons and ENTER during this operation, the Direct Number Access mode is canceled.

Presetting the XM™ Satellite Radio channels

You can use this feature to store up to 40 XM Satellite Radio channels (A1 to E8: 5 preset channel groups with 8 preset channel numbers each). You can then recall the preset channels easily by selecting the preset group and number as described in “Preset Search mode” on page 8.

1 Search for an XM channel that you want to preset.

See “Basic XM™ Satellite Radio operations” on page 6 for details.

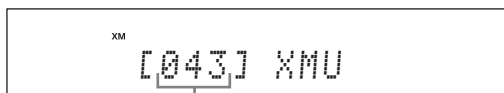

Currently selected channel number



The initial factory setting for all preset channels is “[001] Preview”.

2 Press MEMORY.

The MEMORY indicator flashes in the front panel display for about 10 seconds.



Note

Operate steps 3 to 5 while the MEMORY indicator is flashing.

3 Press CAT/A-E (◀/▶) repeatedly to select a preset group while the MEMORY indicator is flashing.

The selected preset group appears in the front panel display.

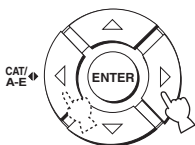

Flashing

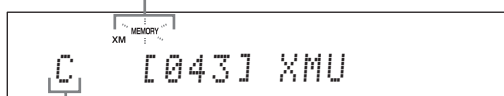

Currently selected preset group

4 Press ENTRY (▲ / ▼) repeatedly to select a preset number while the MEMORY indicator is flashing.

The selected preset number appears in the front panel display.



Flashing

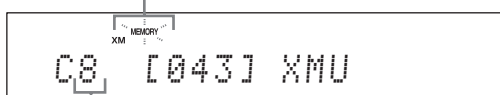

Currently selected preset number

5 Press MEMORY or ENTER to assign the preset group and number to the selected XM channel while the MEMORY indicator is flashing.

A colon (:) appears, and the MEMORY indicator turns off in the front panel display.

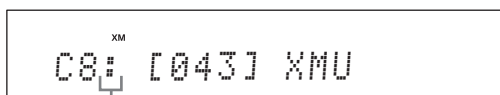
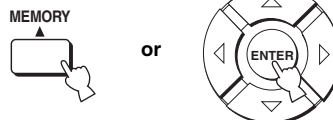

Colon (:)

Note

When you overwrite an existing preset channel, the previously stored XM channel information is cleared and updated.

Displaying the XM™ Satellite Radio information

You can display the XM Satellite Radio information (channel number/channel name, channel category, and artist name/song or program title) for the currently selected channel in the front panel display or in the OSD.

Note

If a status or error message appears in the front panel display or in the OSD, see the “XM Satellite Radio (U.S.A. and Canada models only)” in “Troubleshooting” on page 11.

■ Displaying the XM channel information in the front panel display

Press **DISPLAY** repeatedly to toggle between the following information displays.

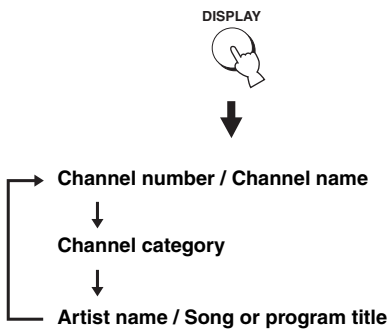

When the channel number / channel name is displayed:

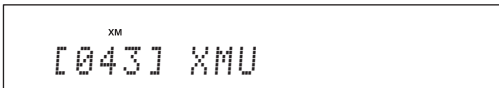

When the channel category is displayed:

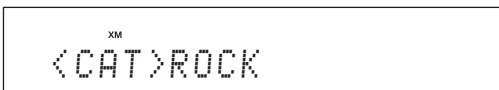

When the artist name / song title is displayed:

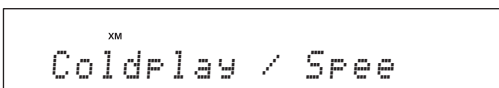

- You can set the front panel display mode: CONT. or ONCE. When ONCE is selected, the front panel display scrolls characters to the end once, after which the first 15 characters appear and stay. See “SCROLL” (Front panel display scroll) in “F.DISPLAY SET” (Front panel display settings) in the owner’s manual (page 83).
- Undisplayable characters are displayed as spaces.

■ Displaying the XM channel information in the OSD

Press **DISPLAY**.

The following screen is displayed in the OSD.

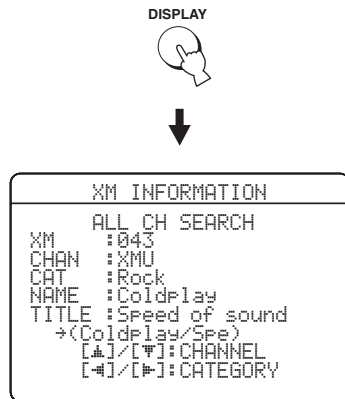

- To turn off the OSD, press **DISPLAY** again.
- You can set the interval for which the OSD screen is displayed after an operation. See “OSD DISPLAY TIME” (OSD display time) in “OSD SET” (OSD settings) in the owner’s manual (page 83).
- To hold the XM Satellite Radio OSD information, press **ENTER**. To unhold, press **ENTER** again.
- This unit can save up to two XM Satellite Radio OSD information screens for future reference. To view the previous OSD screens, press **RETURN** repeatedly while the current XM Satellite Radio OSD information screen is on hold.

Troubleshooting

Refer to the following charts when the status messages appear during your iPod or XM Satellite Radio operations on this unit. If you experience a problem that is not listed below, or if the instruction below does not help, set this unit to the standby mode, disconnect the power supply cable, and contact the nearest authorized Yamaha dealer or service center.

■ iPod

Note

In case of a transmission error with no status message appearing in the front panel display and in the OSD, check the connection between your iPod and this unit.

Status message	Cause	Remedy	See page
Loading...	This unit is in the middle of recognizing the connection with your iPod.		
	This unit is in the middle of acquiring the song lists from your iPod.		
Connect error	There is a problem with the signal path from your iPod to this unit.	Turn off this unit and reconnect the Yamaha iPod universal dock to the DOCK terminal of this unit.	2
		Try resetting your iPod.	—
Unknown iPod	Your iPod is not supported by this unit.	Only iPod (Click and Wheel), iPod nano, and iPod mini are supported.	—
iPod connected	The connection between your iPod and this unit is completed.		
Disconnected	Your iPod is removed from the Yamaha iPod universal dock.	Set your iPod back in the Yamaha iPod universal dock.	2
Unable to play	This unit cannot play back the files stored on your iPod.	Check the playability of the files stored on your iPod.	—
		Store other playable music files on your iPod.	—

■ XM Satellite Radio (U.S.A. and Canada models only)

Status message	Cause	Remedy	See page
CHECK ANTENNA	XM Mini-Tuner and Home Dock are not connected to the XM jack of this unit or not working properly.	Check XM Mini-Tuner and Home Dock connections and adjust the orientation for the best reception level.	5
UPDATING	The XM user encryption code is being updated.	Wait until the encryption code is updated.	—
NO SIGNAL	The signal is too weak.	Adjust the orientation of the indoor antenna of Home Dock for the best reception level.	5
LOADING	It takes longer than four seconds to decode audio or text data.	Wait until the decoding process is finished.	—
OFF AIR	The currently selected XM channel is not broadcasting signals.	Check the channel number again or select another XM channel.	—
<XM> - - -	The Channel Station ID (SID) is no longer available.		
- - - / - - -	No artist name or song title is available.		
<CAT> - - -	No channel is available for the selected category.	Select another channel category by pressing CAT/A-E \blacklozenge repeatedly.	7



© 2007 YAMAHA CORPORATION All rights reserved.

YAMAHA ELECTRONICS CORPORATION, USA 6660 ORANGETHORPE AVE., BUENA PARK, CALIF. 90620, U.S.A.
YAMAHA CANADA MUSIC LTD. 135 MILNER AVE., SCARBOROUGH, ONTARIO M1S 3R1, CANADA
YAMAHA ELECTRONIK EUROPA G.m.b.H. SIEMENSSTR. 22-34, 25462 RELLINGEN BEI HAMBURG, GERMANY
YAMAHA ELECTRONIQUE FRANCE S.A. RUE AMBROISE CROIZAT BP70 CROISSY-BEAUBOURG 77312 MARNE-LA-VALLEE CEDEX02, FRANCE
YAMAHA ELECTRONICS (UK) LTD. YAMAHA HOUSE, 200 RICKMANSWORTH ROAD WATFORD, HERTS WD18 7GQ, ENGLAND
YAMAHA SCANDINAVIA A.B. J A WETTERGRENS GATA 1, BOX 30053, 400 43 VÄSTRA FRÖLUNDA, SWEDEN
YAMAHA MUSIC AUSTRALIA PTY, LTD. 17-33 MARKET ST., SOUTH MELBOURNE, 3205 VIC., AUSTRALIA

YAMAHA CORPORATION
Printed in Malaysia ◀ WK75460



YSP-3000

QUICK REFERENCE GUIDE

Items used for connections and operations in this guide

- Audio pin cable (x1)
- OSD* video pin cable (x1)
- Optical cable (x1)
- Digital audio pin cable (x1)
- IntelliBeam microphone (x1)
- Cardboard microphone stand (x1)
- Demonstration DVD (x1)

*OSD: On-Screen Display

This quick reference guide explains steps to connect a TV and a DVD player to this unit and achieve the surround sound effects in a quick, easy manner. For detailed operation, refer to the Owner's Manual.

1 Installing this unit

Decide where to install this unit.

Install this unit where there are no objects such as furniture obstructing the path of sound beams. Otherwise, the desired surround sound effects may not be achieved. You may install this unit in parallel with the wall or in the corner.

Install this unit in the exact center of the wall when it is measured from the left and right corners.

An object, such as furniture

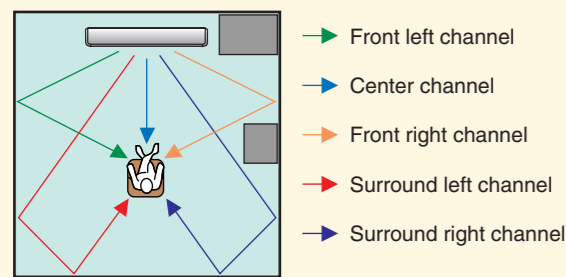

Install this unit in the corner at a 40° to 50° angle from the adjacent walls.

An object, such as furniture

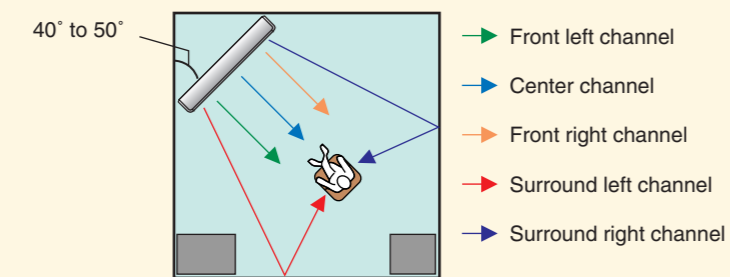

Install this unit using a rack, etc.

Depending on your installation environment, connections with external components (see "2 Connecting external components to this unit") can be done before installing this unit. We recommend that you temporarily place and arrange all components in order to decide which procedure must come first. In case you install this unit on top of a rack, etc., use the supplied fasteners to prevent an accidental fall of this unit. For further information on installation, see page 16 in the Owner's Manual.

The following is an example of installing this unit in a rack. To prevent this unit or the floor from being scratched, we recommend putting a piece of cloth on the floor in step 2.

- ① Place this unit in front of the rack.
- ② Place this unit upside down and connect this unit to your TV and DVD player.
- ③ Install this unit in the rack.
- ④ Installation is completed.



Hint

- To enjoy better surround effects, place this unit on the upper shelf to keep it away from the floor.
- You can also use the optional metal wall bracket (sold separately) to mount this unit on the wall. For details, refer to the instructions supplied with the metal wall bracket.

Note

Be careful not to leave scratches on this unit or the rack.

2 Connecting external components to this unit

Connecting external components such as a TV or DVD player to this unit.

Connect your TV or DVD player to this unit using appropriate cables as shown below. After all connections are complete, plug the power supply cable into the AC wall outlet. For further information on connecting other components, see pages 19 to 29 in the Owner's Manual.

Connection example 1

This connection example shows a way to connect external components such as a TV or DVD player to this unit by using the supplied cable. You can enjoy the multi-channel audio from the DVD player and the analog/digital audio from the TV. Use the video pin cable supplied with your DVD player to make a video connection between your DVD player and TV.

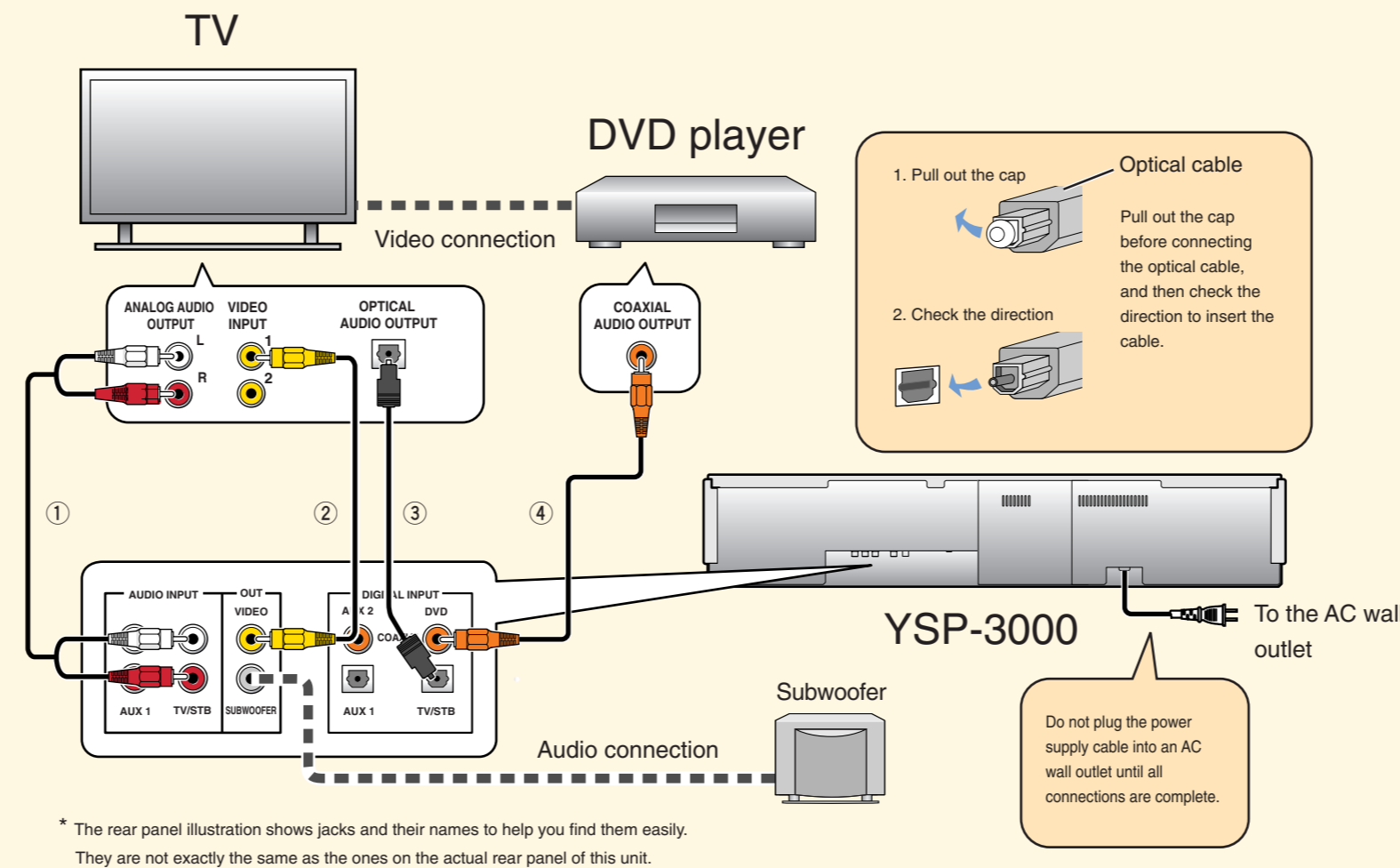

* The rear panel illustration shows jacks and their names to help you find them easily. They are not exactly the same as the ones on the actual rear panel of this unit.

Connect cables in the following order.

Supplied

- ① Audio pin cable (Outputs TV analog audio sounds from this unit)
- ② OSD video pin cable (Displays the YSP-3000 menu screen on the TV)
- ③ Optical cable (Outputs TV digital audio sounds from this unit)
- ④ Digital audio pin cable (Outputs DVD digital audio sounds from this unit)

Note

Check whether the digital audio output of your TV and DVD player is turned on.

If you have connected external components, follow the steps on the backside to start the AUTO SETUP procedure.

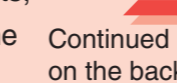

Connection example 2

This connection example shows a way to make the most of the capability of this unit. You can enjoy DVD audio and video with higher quality via the HDMI cable. In case your TV does not have a built-in digital satellite tuner, cable TV tuner, or digital airwave tuner, connect a digital satellite tuner, cable TV tuner, or digital airwave tuner via the HDMI cable. For details, see "Connections using HDMI cables" on page 21 in the Owner's manual.

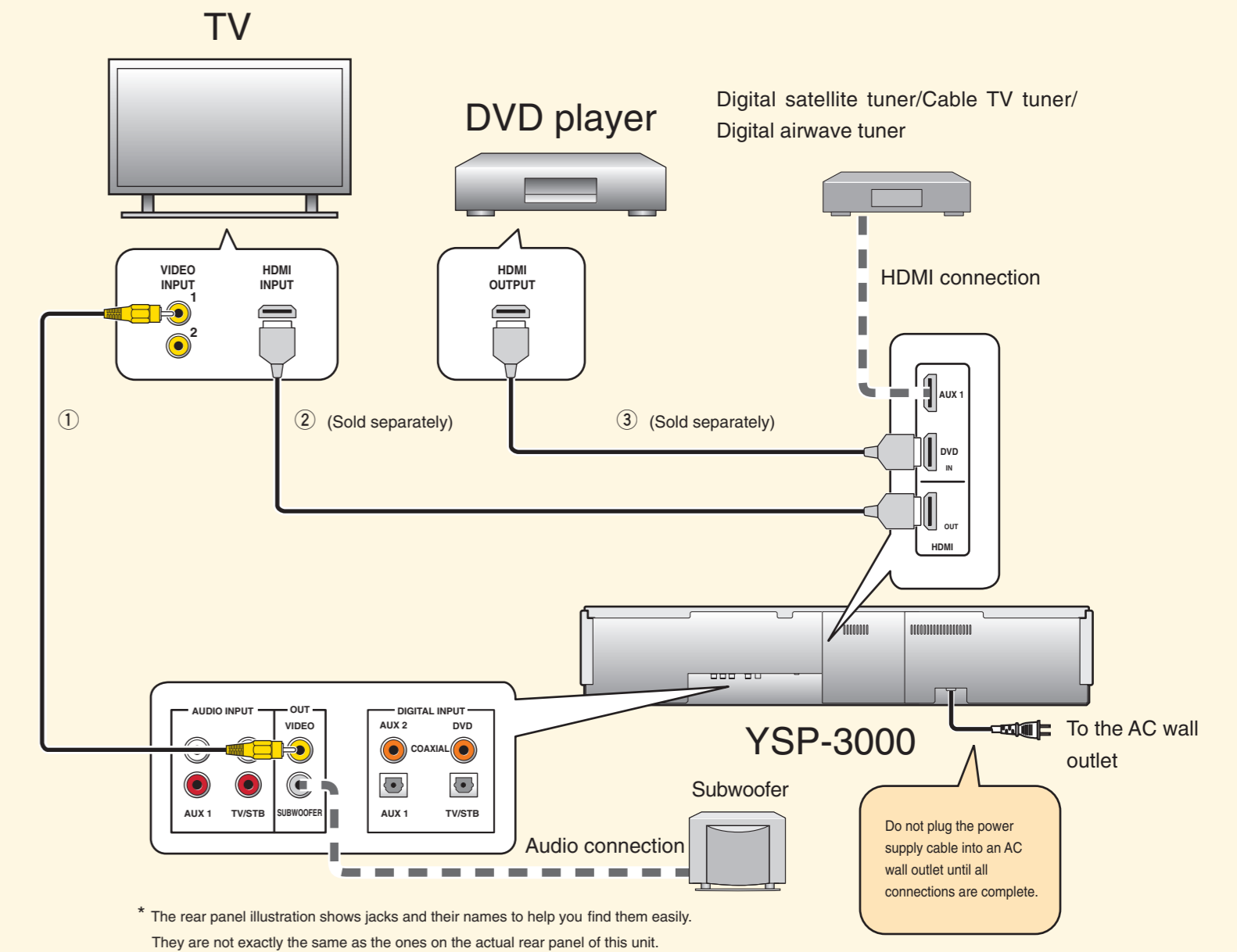

* The rear panel illustration shows jacks and their names to help you find them easily. They are not exactly the same as the ones on the actual rear panel of this unit.

Connect cables in the following order.

Supplied

- ① OSD video pin cable (Displays the YSP-3000 menu screen on the TV)

Sold separately

- ② HDMI cable (Displays the DVD digital video on the TV)
- ③ HDMI cable (Inputs DVD digital audio/video signals to this unit)

Hint

If you connect this unit to an HDMI control-compatible TV (except some models) via HDMI, you can use the remote control supplied with your TV to turn on or off the power, select the audio output component, and adjust the volume level of this unit.

Note

Check whether the digital audio output of your TV and DVD player is turned on.

If you have connected external components, follow the steps on the backside to start the AUTO SETUP procedure.

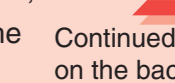

3 Carry out the AUTO SETUP (IntelliBeam)

Carry out the AUTO SETUP to adjust the settings that best match your listening environment

The IntelliBeam technology allows you to achieve sound adjustments that best match your listening environment. It is normal for loud test tones to be output during the AUTO SETUP procedure. Make sure that there are no children around in the listening room while the AUTO SETUP procedure is in progress.

1 Connect the supplied IntelliBeam microphone to the INTELLIBEAM MIC jack on the front panel.

You may want to use the supplied cardboard microphone stand for the AUTO SETUP. Assemble the stand and place the IntelliBeam microphone on top of it as shown below.

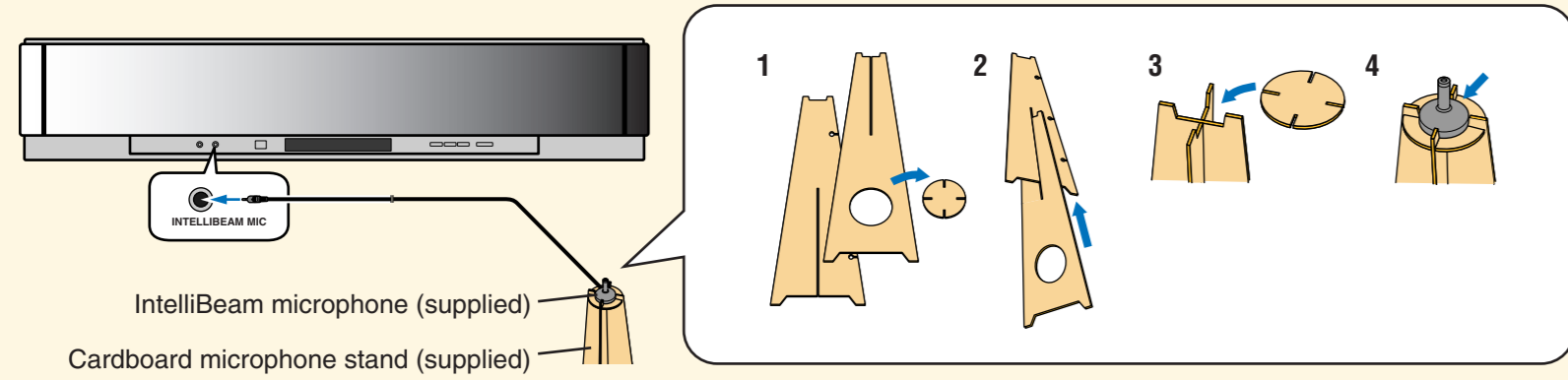

2 Set the IntelliBeam microphone at your normal listening position.

Use the supplied cardboard microphone stand or a tripod to place the IntelliBeam microphone at the same height as your ears would be when you are seated.

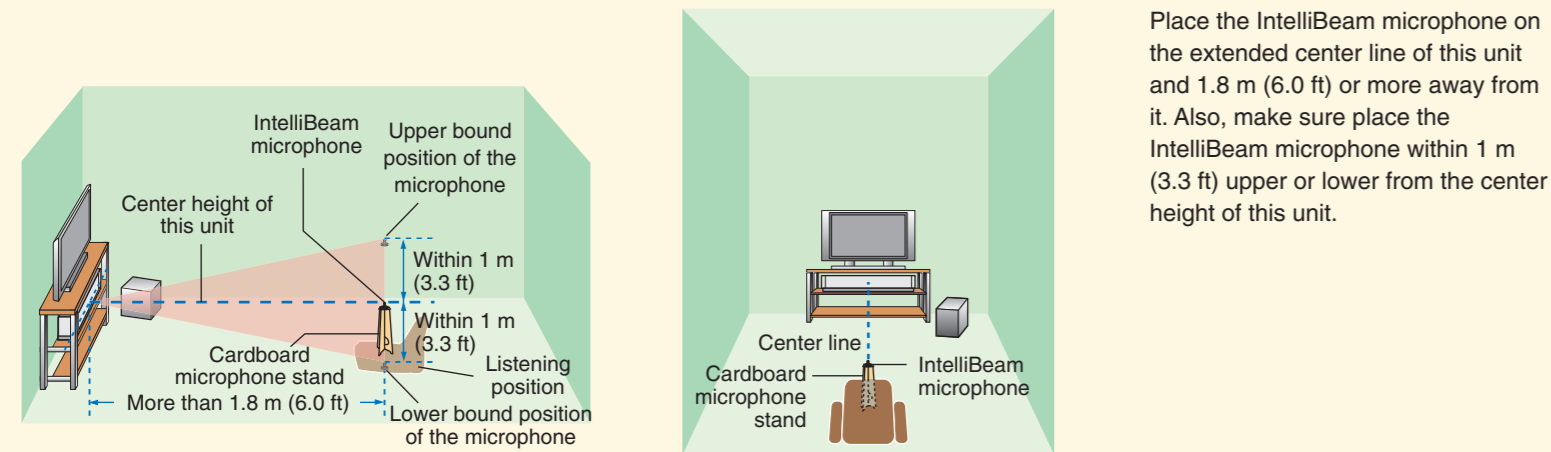

3 Press STANDBY/ON on the remote control.

The power of this unit turns on. Before operations, insert batteries into the remote control (see page 30 in the Owner's Manual). If necessary, adjust the volume level of this unit. If you have connected the subwoofer, set the volume and crossover/high cut frequency. Refer to the hint on page 36 in the Owner's Manual.

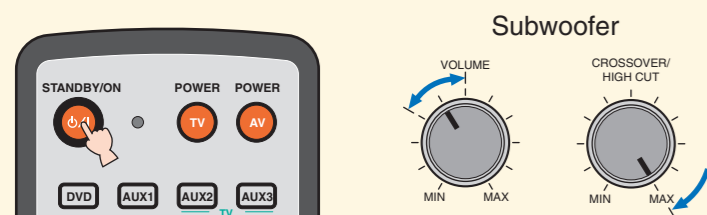

4 Turn on the power of your TV.

5 Select the appropriate video input on your TV.

"YSP-3000" appears on your TV. If the OSD video pin cable is connected to the video input 1 on the TV as shown in the connection example, switch the video input to "1".

6 Set the operation mode selector to YSP.

This unit switches to the YSP operation mode.

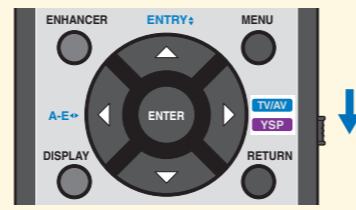

7 Press and hold AUTO SETUP for more than 2 seconds.

The menu screen appears on the TV. If the menu screen does not appear, check the OSD video pin cable (see the connection example on the front page).

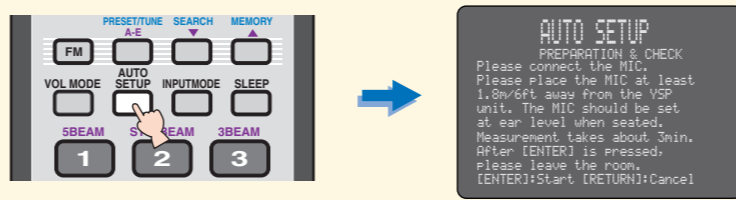

8 Check the following points.

About the IntelliBeam microphone

- Is the microphone placed on an imaginary center line drawn from this unit?
- Is the microphone placed within 1 m (3.3 ft) upper or lower from the center height of this unit?
- Is the microphone placed more than 1.8 m (6.0 ft) from the front of this unit?

About the room environment

- Is your listening room kept as quiet as possible?

9 Prepare to leave the room.

The best setting may not be done if you are in the room. Prepare to leave the room in 10 seconds after pressing ENTER in step 10.

Hint

- When leaving the room, bring this guide with you.
- Wait outside the room during the AUTO SETUP procedure.
- The AUTO SETUP procedure takes about 3 minutes.
- To cancel the AUTO SETUP procedure after it is started, press RETURN.

10 Press ENTER to start the AUTO SETUP procedure, and then leave the room within 10 seconds.

The following screen appears on the TV. Leave the room within 10 seconds before the AUTO SETUP procedure starts.

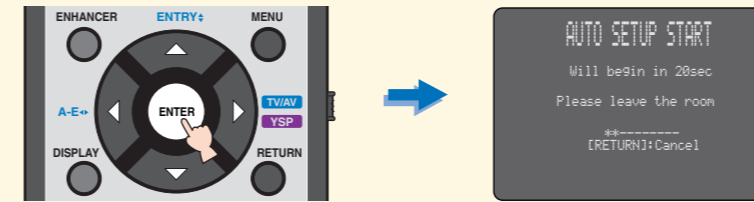

The setup screen automatically changes during the AUTO SETUP procedure.

When the AUTO SETUP procedure is completed, the following screen appears on the TV.

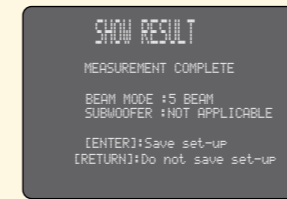

If "ENVIRONMENT CHECK (FAILED)" is displayed, see page 40 in the Owner's Manual and then run the procedure again.

Hint

- The result may differ depending on the environment.
- If any error occurs, the corresponding error message appears on the screen. In this case, see "Error messages for AUTO SETUP" on page 41 in the Owner's Manual and then follow the instructions. To start the AUTO SETUP procedure once again, press RETURN.

11 Press ENTER.

The following screen appears on the TV for 2 seconds and then the menu screen disappears from the TV.

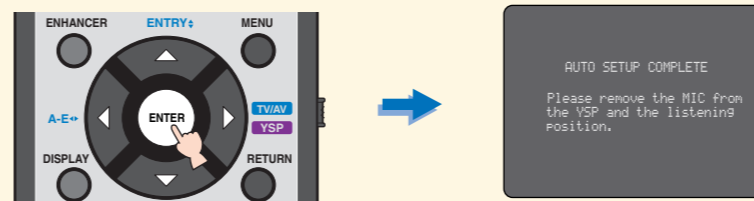

12 Disconnect the IntelliBeam microphone.

The AUTO SETUP has completed. Keep the IntelliBeam microphone in a safe place. The settings are automatically saved in the system memory.

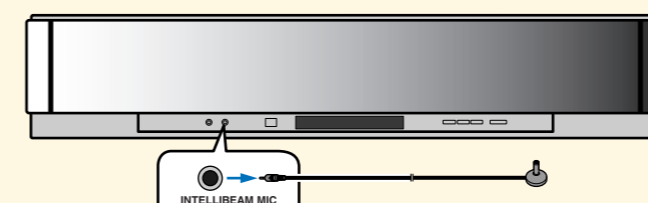

4 Enjoying surround sound

Enjoy TV or DVD digital audio in surround sound.

For instructions on how to operate or set your TV or DVD player, refer to the owner's manual supplied with each component.

Enjoying DVDs in surround sound

1 Select the DVD video input on your TV.

2 Set the operation mode selector to YSP.

This unit switches to the YSP operation mode.

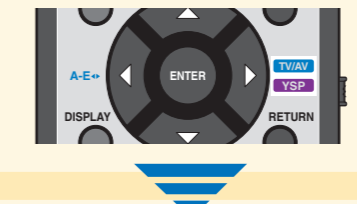

3 1) Press DVD on the remote control of this unit.

This unit switches to the DVD playback mode.

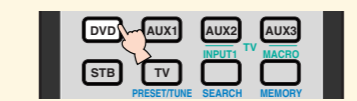

2) Play back the supplied demonstration DVD on the DVD player.

Enjoying TV in surround sound

1 Select the TV channel using the remote control supplied with your TV.

2 Set the operation mode selector to YSP.

This unit switches to the YSP operation mode.

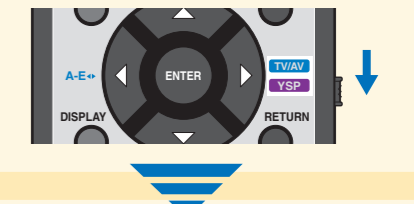

3 Press TV on the remote control of this unit.

This unit switches to the TV playback mode.

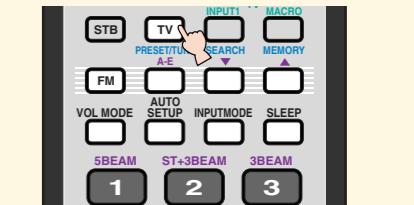

4 Check the digital signal being output at this unit.

The input channel indicators (see page 8 in the Owner's Manual) are lit in the front panel display, and they switch according to the channel composition of the corresponding input source. If the sound is output from your TV speakers, mute the volume on your TV. For details about digital audio input signals, see page 46 in the Owner's Manual.

Input channel indicators

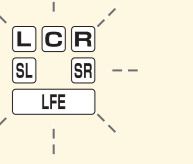

5 Press VOLUME +/- on the remote control to adjust the volume level of this unit.

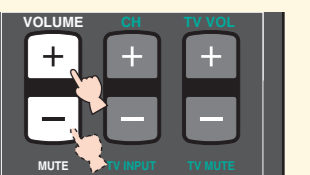

6 Press one of the beam mode buttons on the remote control to select the desired beam mode.

Select one of the six beam modes that best matches the current input source of this unit. For further information on the beam modes, see page 54 in the Owner's Manual.

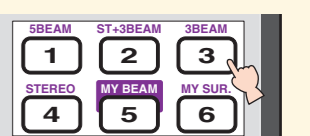

To fine-tune the listening environment parameters manually or make advanced settings for speaker positions, sound beams, etc., see "MANUAL SETUP" on page 72 in the Owner's Manual.