



DIGITAL KEYBOARD

PSR-E413

Owner's Manual



SPECIAL MESSAGE SECTION

This product utilizes batteries or an external power supply (adapter). DO NOT connect this product to any power supply or adapter other than one described in the manual, on the name plate, or specifically recommended by Yamaha.

WARNING: Do not place this product in a position where anyone could walk on, trip over, or roll anything over power or connecting cords of any kind. The use of an extension cord is not recommended! If you must use an extension cord, the minimum wire size for a 25' cord (or less) is 18 AWG. NOTE: The smaller the AWG number, the larger the current handling capacity. For longer extension cords, consult a local electrician.

This product should be used only with the components supplied or; a cart, rack, or stand that is recommended by Yamaha. If a cart, etc., is used, please observe all safety markings and instructions that accompany the accessory product.

SPECIFICATIONS SUBJECT TO CHANGE:

The information contained in this manual is believed to be correct at the time of printing. However, Yamaha reserves the right to change or modify any of the specifications without notice or obligation to update existing units.

This product, either alone or in combination with an amplifier and headphones or speaker/s, may be capable of producing sound levels that could cause permanent hearing loss. DO NOT operate for long periods of time at a high volume level or at a level that is uncomfortable. If you experience any hearing loss or ringing in the ears, you should consult an audiologist.

IMPORTANT: The louder the sound, the shorter the time period before damage occurs.

Some Yamaha products may have benches and / or accessory mounting fixtures that are either supplied with the product or as optional accessories. Some of these items are designed to be dealer assembled or installed. Please make sure that benches are stable and any optional fixtures (where applicable) are well secured BEFORE using. Benches supplied by Yamaha are designed for seating only. No other uses are recommended.

NOTICE:

Service charges incurred due to a lack of knowledge relating to how a function or effect works (when the unit is operating as designed) are not covered by the manufacturer's warranty, and are therefore the owners responsibility. Please study this manual carefully and consult your dealer before requesting service.

ENVIRONMENTAL ISSUES:

Yamaha strives to produce products that are both user safe and environmentally friendly. We sincerely believe that our products and the production methods used to produce them, meet these goals. In keeping with both the letter and the spirit of the law, we want you to be aware of the following:

Battery Notice:

This product MAY contain a small non-rechargeable battery which (if applicable) is soldered in place. The average life span of this type of battery is approximately five years. When replacement becomes necessary, contact a qualified service representative to perform the replacement.

This product may also use "household" type batteries. Some of these may be rechargeable. Make sure that the battery being charged is a rechargeable type and that the charger is intended for the battery being charged.

When installing batteries, do not mix batteries with new, or with batteries of a different type. Batteries MUST be installed correctly. Mismatches or incorrect installation may result in overheating and battery case rupture.

Warning:

Do not attempt to disassemble, or incinerate any battery. Keep all batteries away from children. Dispose of used batteries promptly and as regulated by the laws in your area. Note: Check with any retailer of household type batteries in your area for battery disposal information.

Disposal Notice:

Should this product become damaged beyond repair, or for some reason its useful life is considered to be at an end, please observe all local, state, and federal regulations that relate to the disposal of products that contain lead, batteries, plastics, etc. If your dealer is unable to assist you, please contact Yamaha directly.

NAME PLATE LOCATION:

The name plate is located on the bottom of the product. The model number, serial number, power requirements, etc., are located on this plate. You should record the model number, serial number, and the date of purchase in the spaces provided below and retain this manual as a permanent record of your purchase.

Model

Serial No.

Purchase Date

PLEASE KEEP THIS MANUAL

92-BP (bottom)

FCC INFORMATION (U.S.A.)

1. IMPORTANT NOTICE: DO NOT MODIFY THIS UNIT!

This product, when installed as indicated in the instructions contained in this manual, meets FCC requirements. Modifications not expressly approved by Yamaha may void your authority, granted by the FCC, to use the product.

2. IMPORTANT: When connecting this product to accessories and/or another product use only high quality shielded cables. Cable/s supplied with this product MUST be used. Follow all installation instructions. Failure to follow instructions could void your FCC authorization to use this product in the USA.

3. NOTE: This product has been tested and found to comply with the requirements listed in FCC Regulations, Part 15 for Class "B" digital devices. Compliance with these requirements provides a reasonable level of assurance that your use of this product in a residential environment will not result in harmful interference with other electronic devices. This equipment generates/uses radio frequencies and, if not installed and used according to the instructions found in the users manual, may cause interference harmful to the operation of other electronic devices. Compliance with FCC regulations does

not guarantee that interference will not occur in all installations. If this product is found to be the source of interference, which can be determined by turning the unit "OFF" and "ON", please try to eliminate the problem by using one of the following measures:

Relocate either this product or the device that is being affected by the interference.

Utilize power outlets that are on different branch (circuit breaker or fuse) circuits or install AC line filter/s.

In the case of radio or TV interference, relocate/reorient the antenna. If the antenna lead-in is 300 ohm ribbon lead, change the lead-in to co-axial type cable.

If these corrective measures do not produce satisfactory results, please contact the local retailer authorized to distribute this type of product. If you can not locate the appropriate retailer, please contact Yamaha Corporation of America, Electronic Service Division, 6600 Orangethorpe Ave, Buena Park, CA90620

The above statements apply ONLY to those products distributed by Yamaha Corporation of America or its subsidiaries.

* This applies only to products distributed by YAMAHA CORPORATION OF AMERICA.

(class B)

IMPORTANT NOTICE FOR THE UNITED KINGDOM Connecting the Plug and Cord

IMPORTANT. The wires in this mains lead are coloured in accordance with the following code:

BLUE : NEUTRAL
BROWN : LIVE

As the colours of the wires in the mains lead of this apparatus may not correspond with the coloured markings identifying the terminals in your plug proceed as follows:

The wire which is coloured BLUE must be connected to the terminal which is marked with the letter N or coloured BLACK.

The wire which is coloured BROWN must be connected to the terminal which is marked with the letter L or coloured RED.

Making sure that neither core is connected to the earth terminal of the three pin plug.

• This applies only to products distributed by Yamaha Music U.K. Ltd.

(2 wires)

COMPLIANCE INFORMATION STATEMENT (DECLARATION OF CONFORMITY PROCEDURE)

Responsible Party : Yamaha Corporation of America

Address : 6600 Orangethorpe Ave., Buena Park, Calif.
90620

Telephone : 714-522-9011

Type of Equipment : Digital Keyboard

Model Name : PSR-E413

This device complies with Part 15 of the FCC Rules.

Operation is subject to the following two conditions:

- 1) this device may not cause harmful interference, and
- 2) this device must accept any interference received including interference that may cause undesired operation.

See user manual instructions if interference to radio reception is suspected.

* This applies only to products distributed by YAMAHA CORPORATION OF AMERICA.

(FCC DoC)

OBSERVERA!

Apparaten kopplas inte ur växelströmskällan (nätet) så länge som den är ansluten till vägguttaget, även om själva apparaten har stängts av.

ADVARSEL: Netspændingen til dette apparat er IKKE afbrudt, så længe netledningen sidder i en stikkontakt, som er tændt — også selvom der er slukket på apparatets afbryder.

VAROITUS: Laitteen toisiopiiriin kytketty käyttökytkin ei irroita koko laitetta verkosta.

(standby)

Entsorgung leerer Batterien (nur innerhalb Deutschlands)

Leisten Sie einen Beitrag zum Umweltschutz. Verbrauchte Batterien oder Akkumulatoren dürfen nicht in den Hausmüll. Sie können bei einer Sammelstelle für Altbatterien bzw. Sondermüll abgegeben werden. Informieren Sie sich bei Ihrer Kommune.

(battery)

PRECAUTIONS

PLEASE READ CAREFULLY BEFORE PROCEEDING

* Please keep this manual in a safe place for future reference.



WARNING

Always follow the basic precautions listed below to avoid the possibility of serious injury or even death from electrical shock, short-circuiting, damages, fire or other hazards. These precautions include, but are not limited to, the following:

Power supply/AC power adaptor

- Only use the voltage specified as correct for the instrument. The required voltage is printed on the name plate of the instrument.
- Use the specified adaptor (PA-130 or an equivalent recommended by Yamaha) only. Using the wrong adaptor can result in damage to the instrument or overheating.
- Check the electric plug periodically and remove any dirt or dust which may have accumulated on it.
- Do not place the AC adaptor cord near heat sources such as heaters or radiators, and do not excessively bend or otherwise damage the cord, place heavy objects on it, or place it in a position where anyone could walk on, trip over, or roll anything over it.

Do not open

- Do not open the instrument or attempt to disassemble the internal parts or modify them in any way. The instrument contains no user-serviceable parts. If it should appear to be malfunctioning, discontinue use immediately and have it inspected by qualified Yamaha service personnel.

Water warning

- Do not expose the instrument to rain, use it near water or in damp or wet conditions, or place containers on it containing liquids which might spill into any openings. If any liquid such as water seeps into the instrument, turn off the power immediately and unplug the power cord from the AC outlet. Then have the instrument inspected by qualified Yamaha service personnel.
- Never insert or remove an electric plug with wet hands.

Fire warning

- Do not put burning items, such as candles, on the unit. A burning item may fall over and cause a fire.

If you notice any abnormality

- If the AC adaptor cord or plug becomes frayed or damaged, or if there is a sudden loss of sound during use of the instrument, or if any unusual smells or smoke should appear to be caused by it, immediately turn off the power switch, disconnect the adaptor plug from the outlet, and have the instrument inspected by qualified Yamaha service personnel.



CAUTION

Always follow the basic precautions listed below to avoid the possibility of physical injury to you or others, or damage to the instrument or other property. These precautions include, but are not limited to, the following:

Power supply/AC power adaptor

- When removing the electric plug from the instrument or an outlet, always hold the plug itself and not the cord.
- Unplug the AC power adaptor when not using the instrument, or during electrical storms.
- Do not connect the instrument to an electrical outlet using a multiple-connector. Doing so can result in lower sound quality, or possibly cause overheating in the outlet.

Battery

- Always make sure all batteries are inserted in conformity with the +/- polarity markings. Failure to do so might result in overheating, fire, or battery fluid leakage.
- Always replace all batteries at the same time. Do not use new batteries together with old ones. Also, do not mix battery types, such as alkaline batteries with manganese batteries, or batteries from different makers, or different types of batteries from the same maker, since this can cause overheating, fire, or battery fluid leakage.
- Do not dispose of batteries in fire.

- Do not attempt to recharge batteries that are not intended to be charged.
- When the batteries run out, or if the instrument is not to be used for a long time, remove the batteries from the instrument to prevent possible leakage of the battery fluid.
- Keep batteries away from children.
- If the batteries do leak, avoid contact with the leaked fluid. If the battery fluid should come in contact with your eyes, mouth, or skin, wash immediately with water and consult a doctor. Battery fluid is corrosive and may possibly cause loss of sight or chemical burns.

Location

- Do not expose the instrument to excessive dust or vibrations, or extreme cold or heat (such as in direct sunlight, near a heater, or in a car during the day) to prevent the possibility of panel disfiguration or damage to the internal components.
- Do not use the instrument in the vicinity of a TV, radio, stereo equipment, mobile phone, or other electric devices. Otherwise, the instrument, TV, or radio may generate noise.
- Do not place the instrument in an unstable position where it might accidentally fall over.

- Before moving the instrument, remove all connected adaptor and other cables.
- When setting up the product, make sure that the AC outlet you are using is easily accessible. If some trouble or malfunction occurs, immediately turn off the power switch and disconnect the plug from the outlet. Even when the power switch is turned off, electricity is still flowing to the product at the minimum level. When you are not using the product for a long time, make sure to unplug the power cord from the wall AC outlet.
- Use only the stand specified for the instrument. When attaching the stand or rack, use the provided screws only. Failure to do so could cause damage to the internal components or result in the instrument falling over.

Connections

- Before connecting the instrument to other electronic components, turn off the power for all components. Before turning the power on or off for all components, set all volume levels to minimum. Also, be sure to set the volumes of all components at their minimum levels and gradually raise the volume controls while playing the instrument to set the desired listening level.

Maintenance

- When cleaning the instrument, use a soft, dry cloth. Do not use paint thinners, solvents, cleaning fluids, or chemical-impregnated wiping cloths.

Handling caution

- Do not insert a finger or hand in any gaps on the instrument.
- Never insert or drop paper, metallic, or other objects into the gaps on the panel or keyboard. If this happens, turn off the power immediately and unplug the power cord from the AC outlet. Then have the instrument inspected by qualified Yamaha service personnel.
- Do not place vinyl, plastic or rubber objects on the instrument, since this might discolor the panel or keyboard.
- Do not rest your weight on, or place heavy objects on the instrument, and do not use excessive force on the buttons, switches or connectors.
- Do not use the instrument/device or headphones for a long period of time at a high or uncomfortable volume level, since this can cause permanent hearing loss. If you experience any hearing loss or ringing in the ears, consult a physician.

Saving data

Saving and backing up your data

- The panel settings and some other types of data are not retained in memory when you turn off the power to the instrument. Save data you want to keep to the Registration Memory (page 80.)
Saved data may be lost due to malfunction or incorrect operation. Save important data to an external device such as a computer (pages 92).

Yamaha cannot be held responsible for damage caused by improper use or modifications to the instrument, or data that is lost or destroyed.

Always turn the power off when the instrument is not in use.

When using a power adaptor, even when the power switch is in the "STANDBY" position, electricity is still flowing to the instrument at the minimum level. When you are not using the instrument for a long time, make sure you unplug the AC power adaptor from the wall AC outlet.

Make sure to discard used batteries according to local regulations.

The illustrations and LCD screens as shown in this manual are for instructional purposes only, and may appear somewhat different from those on your instrument.

● Trademarks

- Windows is a registered trademark of Microsoft® Corporation in the United States and other countries.
- The company names and product names in this manual are the trademarks or registered trademarks of their respective companies.

Copyright Notice

The following is the title, credits and copyright notices for the song pre-installed in this electronic keyboard:

Composition Title: Against All Odds

Composer's Name: Collins 0007403

Copyright Owner's Name: EMI MUSIC PUBLISHING LTD AND HIT & RUN MUSIC LTD

All Rights Reserved, Unauthorized copying, public performance and broadcasting are strictly prohibited.

This product incorporates and bundles computer programs and contents in which Yamaha owns copyrights or with respect to which it has license to use others' copyrights. Such copyrighted materials include, without limitation, all computer software, style files, MIDI files, WAVE data, musical scores and sound recordings. Any unauthorized use of such programs and contents outside of personal use is not permitted under relevant laws. Any violation of copyright has legal consequences. **DON'T MAKE, DISTRIBUTE OR USE ILLEGAL COPIES.**

Copying of the commercially available musical data including but not limited to MIDI data and/or audio data is strictly prohibited except for your personal use.

Logos



GM System Level 1

"GM System Level 1" is an addition to the MIDI standard which ensures that any GM-compatible music data can be accurately played by any GM-compatible tone generator, regardless of manufacturer. The GM mark is affixed to all software and hardware products that support GM System Level.



XGlite

As its name implies, "XGlite" is a simplified version of Yamaha's high-quality XG tone generation format. Naturally, you can play back any XG song data using an XGlite tone generator. However, keep in mind that some songs may play back differently compared to the original data, due to the reduced set of control parameters and effects.



USB

USB is an abbreviation for Universal Serial Bus. It is a serial interface for connecting a computer with peripheral Devices. It allows "hot swapping" (connecting peripheral devices while the power to the computer is on).



Stereo Sampled Piano

The instrument has a special Portable Grand Piano Voice—created by state-of-the-art stereo sampling technology and using Yamaha's sophisticated AWM (Advanced Wave memory) tone generation system.



Touch Response

The exceptionally natural Touch Response feature, with a convenient front panel on/off switch, gives you maximum expressive level control over the voices. It also works in conjunction with the Dynamic Filter, which dynamically adjusts the timbre or tone of a voice according to your playing strength—just a like a real musical instrument!



STYLE FILE

The Style File Format is Yamaha's original style file format which uses a unique conversion system to provide high-quality automatic accompaniment based on a wide range of chord types.

*Congratulations and thank you for purchasing
the Yamaha PSR-E413 Digital Keyboard!*

*Please read this owner's manual carefully before using the instrument
in order to take full advantage of its various features.*

*Make sure to keep this manual in a safe and handy place even after you finish reading,
and refer to it often when you need to better understand an operation or function.*

Included Accessories

The PSR-E413 package includes the following items. Please check that you have them all.

- Owner's Manual
- Music rest
- Accessory CD-ROM

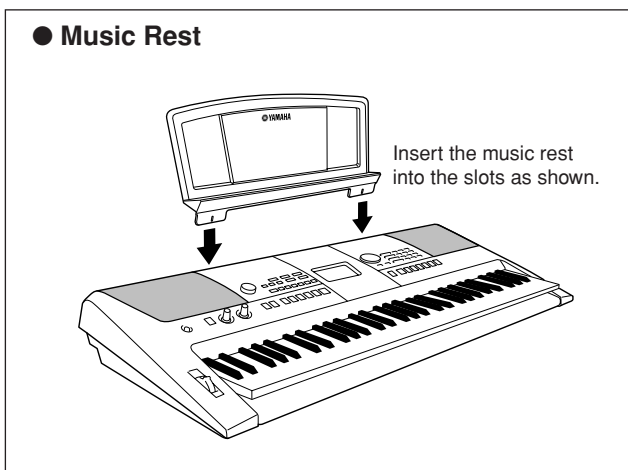



Special Features of the PSR-E413

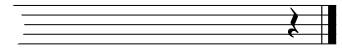

■ Creating New Sounds ▶ Page 18

By adjusting just two knobs you can add varying degrees of distortion, “sweetness,” or other characteristics to a sound to change it subtly or drastically. Parameters that can be assigned to the knobs include effect, filter, envelope generator and more. You can create new sounds in real time!

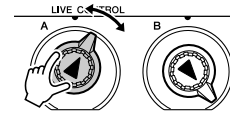

■ Arpeggio Function ▶ Page 14

Similar to the arpeggio functions provided on some synthesizers, this function automatically produces arpeggios (broken chords) when you simply play the appropriate notes on the keyboard. A variety of arpeggios can be produced by changing your fingering or the arpeggio type.



■ Performance assistant technology ▶ Page 23

Play along with a song on the instrument’s keyboard and produce a perfect performance every time ... even if you play wrong notes! All you have to do is play on the keyboard—alternately on the left- and right-hand ranges of the keyboard, for example—and you’ll sound like a pro as long as you play in time with the music.

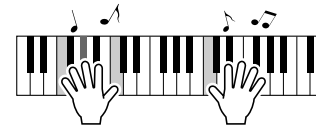

■ Play a Variety of Instrument Voices ▶ Page 28

The instrument voice that sounds when you play the keyboard can be changed to violin, flute, harp, or any of an extensive range of voices. You can change the mood of a song written for piano, for example, by using violin to play it instead. Experience a whole new world of musical variety.



■ Play Along with Styles ▶ Page 33

Want to play with full accompaniment? Try the auto-accompaniment Styles. The accompaniment styles provide the equivalent of a full backing band covering a wide variety of styles from waltzes to 8-beat to euro-trance ... and much more. Select a style that matches the music you want to play, or experiment with new styles to expand your musical horizons.



Contents

Copyright Notice	6
Logos	6
Included Accessories	7
Special Features of the PSR-E413	8
Setting Up	10
Power Requirements	10
Connecting Headphones (PHONES/OUTPUT Jack).....	11
Connecting a Footswitch (SUSTAIN Jack)	11
Connecting to a Computer (USB Terminal)	11
Turning the Power On.....	11
Panel Controls and Terminals	12
Front Panel	12
Rear Panel	13
Quick Guide	
Creating Arpeggios	14
Create Original Sounds	18
Assigning Effects to the Knobs	18
Using the Knobs.....	21
The Easy Way to Play Piano	23
Play with Both Hands	23
Change the Song Tempo.....	27
Try Playing a Variety of Instrument Voices	28
Select and Play a Voice—MAIN	28
Play Two Voices Simultaneously—DUAL.....	29
Play Different Voices with the Left and Right Hands —SPLIT	30
Play the Grand Piano Voice.....	31
Fun Sounds	32
Drum Kits	32
Sound Effects.....	32
Playing Styles	33
Select a Style Rhythm.....	33
Play Along with a Style	34
Playing Auto-accompaniment Chords.....	38
Using Songs	39
Select and Listen to a Song	39
Song Fast Forward, Fast Reverse, and Pause.....	40
Types of Songs	42
Select a Song For a Lesson	43
Lesson 1—Waiting	43
Lesson 2—Your Tempo	46
Lesson 3—Minus One	47
Practice Makes Perfect—Repeat and Learn.....	48
Play Using the Music Database	49
Change a Song's Style	50
Listen to the DEMO Song for Easy Song Arranger.....	50
Using the Easy Song Arranger	50
Record Your Own Performance	52
Recording Procedure	52
Song Clear—Deleting User Songs	55
Track Clear—Deleting a Specified Track from a User Song.....	55
Backup and Initialization	56
Backup	56
Initialization	56
Basic Operation and Displays	57
Basic Operation	57
Display Items	59

Reference

Adding Effects	60
Harmony.....	60
Adding Reverb	61
Adding Chorus	62
Handy Performance Features	63
The Metronome.....	63
Setting the Number of Beats per Measure, and the Length of Each Beat	64
Adjusting the Metronome Volume	64
Tap Start	65
Touch Response Sensitivity	65
Pitch Bend.....	66
Pitch Controls.....	66
Controlling Arpeggio Volume with Keyboard Dynamics.....	67
One Touch Setting	68
Adjusting the Harmony Volume.....	69
Select an EQ Setting for the Best Sound	69
Style (Auto-accompaniment) Functions	70
Pattern Variation (Sections)	70
Adjusting the Style Volume	72
Setting the Split Point.....	72
Play a Style with Chords but No Rhythm (Stop Accompaniment)	73
Loading Style Files.....	74
Chord Basics.....	75
Looking Up Chords Using the Chord Dictionary	77
Song Settings	78
Song Volume.....	78
A-B Repeat.....	78
Muting Independent Song Parts.....	79
Change the Melody Voice	79
Memorize Your Favorite Panel Settings	80
Saving to the Registration Memory	80
Recalling a Registration Memory	81
Setting the Sleep Mode	82
The Functions	83
Selecting and Setting Functions.....	83
Connecting to a Computer	86
What Is MIDI?	86
Connecting a Personal Computer	87
Transferring Performance Data to and from a Computer....	88
Remote Control of MIDI Devices.....	89
Initial Send	90
Transferring Data between the Computer and Instrument... 90	
Accessory CD-ROM Installation Guide	93
Important Notices about the CD-ROM	93
CD-ROM Contents	94
System Requirements.....	95
Software Installation.....	95
Appendix	
Troubleshooting.....	99
Scores	100
Voice List	106
Drum Kit List	110
Style List.....	112
Arpeggio List.....	113
Music Database List	114
Songs Provided On the Supplied CD-ROM	116
Effect Type List	117
MIDI Implementation Chart	118
MIDI Data Format	120
Specifications.....	123
Index.....	124



Setting Up

Be sure to do the following operations **BEFORE** turning on the power.

Power Requirements

Although the instrument will run either from an optional AC adaptor or batteries, Yamaha recommends use of an AC adaptor whenever possible. An AC adaptor is more environmentally friendly than batteries and does not deplete resources.

■ Using an AC Power Adaptor

- 1 Make sure that the [STANDBY/ON] switch of the instrument is set to STANDBY.

⚠ **WARNING**

- Use the specified adaptor (PA-130 or an equivalent recommended by Yamaha) only. The use of other adaptors may result in irreparable damage to both the adaptor and the instrument.

- 2 Connect the AC adaptor to the power supply jack.
- 3 Plug the AC adaptor into an AC outlet.

⚠ **CAUTION**

- Unplug the AC Power Adaptor when not using the instrument, or during electrical storms.

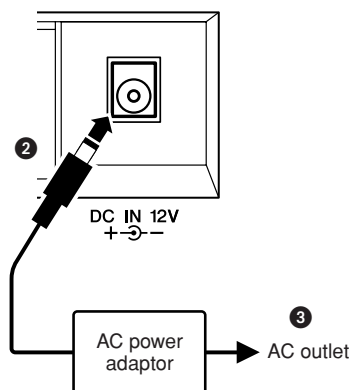

■ Using Batteries

- 1 Open the battery compartment cover located on the instrument's bottom panel.
- 2 Insert the six new batteries, being careful to follow the polarity markings on the inside of the compartment.
- 3 Replace the compartment cover, making sure that it locks firmly in place.

NOTE

- Connecting the AC power adaptor automatically supplies power from the adaptor and overrides battery power, even when batteries are installed.

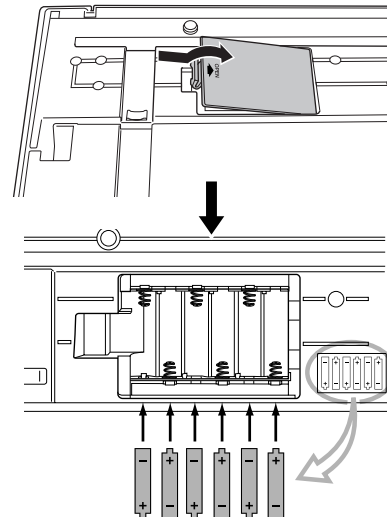

For battery operation the instrument requires six 1.5V "AA" size, LR6 or equivalent batteries. (Alkaline batteries are recommended.) When battery power becomes too low for proper operation, make sure to replace all batteries, following the precautions listed below. If necessary, also make sure to save all important User data (see page 56), since custom panel settings are lost when the batteries are removed.

⚠ **CAUTION**

- Use only manganese or alkaline batteries for this instrument. Other types of batteries (including rechargeable batteries) may exhibit a sudden drop in power when the batteries are low, possibly resulting in a loss of flash memory data.
- Be sure to install the batteries in the same direction, maintaining the correct polarity (as shown). Incorrect battery installation may result in heat, fire and/or leaking of corrosive chemicals.
- When the batteries run down, replace them with a complete set of six new batteries. NEVER mix old and new batteries. Do not use different kinds of batteries (e.g. alkaline and manganese) at the same time.
- If the instrument will not be used for an extended period of time, remove the batteries to prevent possible fluid leakage.
- Please use the power adaptor when transferring data to flash memory. Batteries (including rechargeable types) can be drained rapidly by this type of operation. If the batteries do become drained during a data transfer, both the data being transferred and the data currently in the transfer destination will be lost.

Make all necessary connections below **BEFORE** turning the power on.

Connecting Headphones (PHONES/OUTPUT Jack)

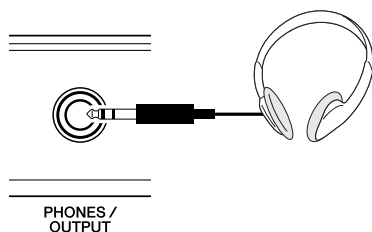

The PSR-E413 speakers are automatically shut off when a plug is inserted into this jack.

The PHONES/OUTPUT jack also functions as an external output. You can connect the PHONES/OUTPUT jack to a keyboard amplifier, stereo system, mixer, tape recorder, or other line-level audio device to send the instrument's output signal to that device.

WARNING

- Avoid listening with the headphones at high volume for long periods of time; doing so may not only result in ear fatigue, it may be damaging to your hearing.

CAUTION

- To prevent damage to the speakers, set the volume of the external devices at the minimum setting before connecting them. Failure to observe these cautions may result in electric shock or equipment damage. Also, be sure to set the volumes of all devices at their minimum levels and gradually raise the volume controls while playing the instrument to set the desired listening level.

Connecting a Footswitch (SUSTAIN Jack)

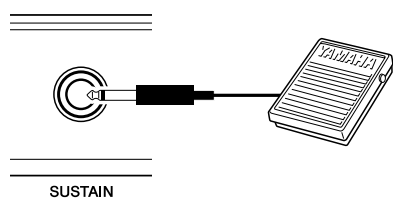

The sustain function lets you produce a natural sustain as you play by pressing a footswitch. Plug the Yamaha FC4 or FC5 footswitch into this jack and use it to switch sustain on and off.

NOTE

- Make sure that the footswitch plug is properly connected to the SUSTAIN jack before turning on the power.
- Do not press the footswitch while turning the power on. Doing this changes the recognized polarity of the footswitch, resulting in reversed footswitch operation.

Connecting to a Computer (USB Terminal)

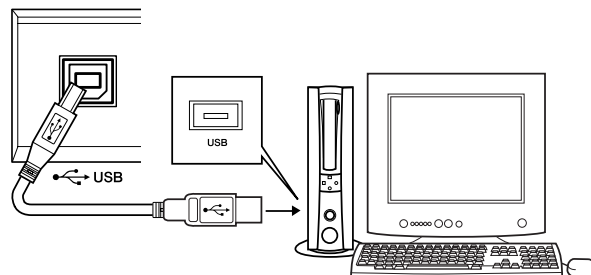

Connect the instrument's USB terminal to the USB terminal of a computer, and you can transfer performance data and song files between the two (page 87). To use the USB data-transfer features you'll need to do the following:

- First, make sure the **POWER** switch on the instrument is set to **OFF**, then use an **AB** type USB cable to connect the instrument to the computer. After making the connections, turn on the power of the instrument.
- Install the **USB-MIDI driver** on your computer.

Installation of the USB-MIDI driver is described on page 95.

NOTE

- Make sure to purchase a quality USB cable at a musical instrument store, computer store or electrical appliance store.

Turning the Power On

Turn down the volume by turning the [MASTER VOLUME] control to the left and press the [STANDBY/ON] switch to turn on the power. Press the [STANDBY/ON] switch again to turn the power OFF.

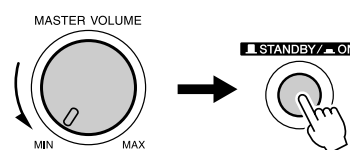

Backup data in the flash memory is loaded to the instrument when the power is turned on. If no backup data exists on flash memory, all instrument settings are restored to the initial factory defaults when the power is turned on.

CAUTION

- Even when the switch is in the "STANDBY" position, electricity is still flowing to the instrument at the minimum level. When you are not using the instrument for a long time, make sure you unplug the AC power adaptor from the wall AC outlet, and/or remove the batteries from the instrument.

CAUTION

- Never attempt to turn the power off when a "WRITING!" message is shown in the display. Doing so can damage the flash memory and result in data loss.



Panel Controls and Terminals

Front Panel

Song Category List
(page 41)

Style Category List
(page 112)

Display
(page 59)

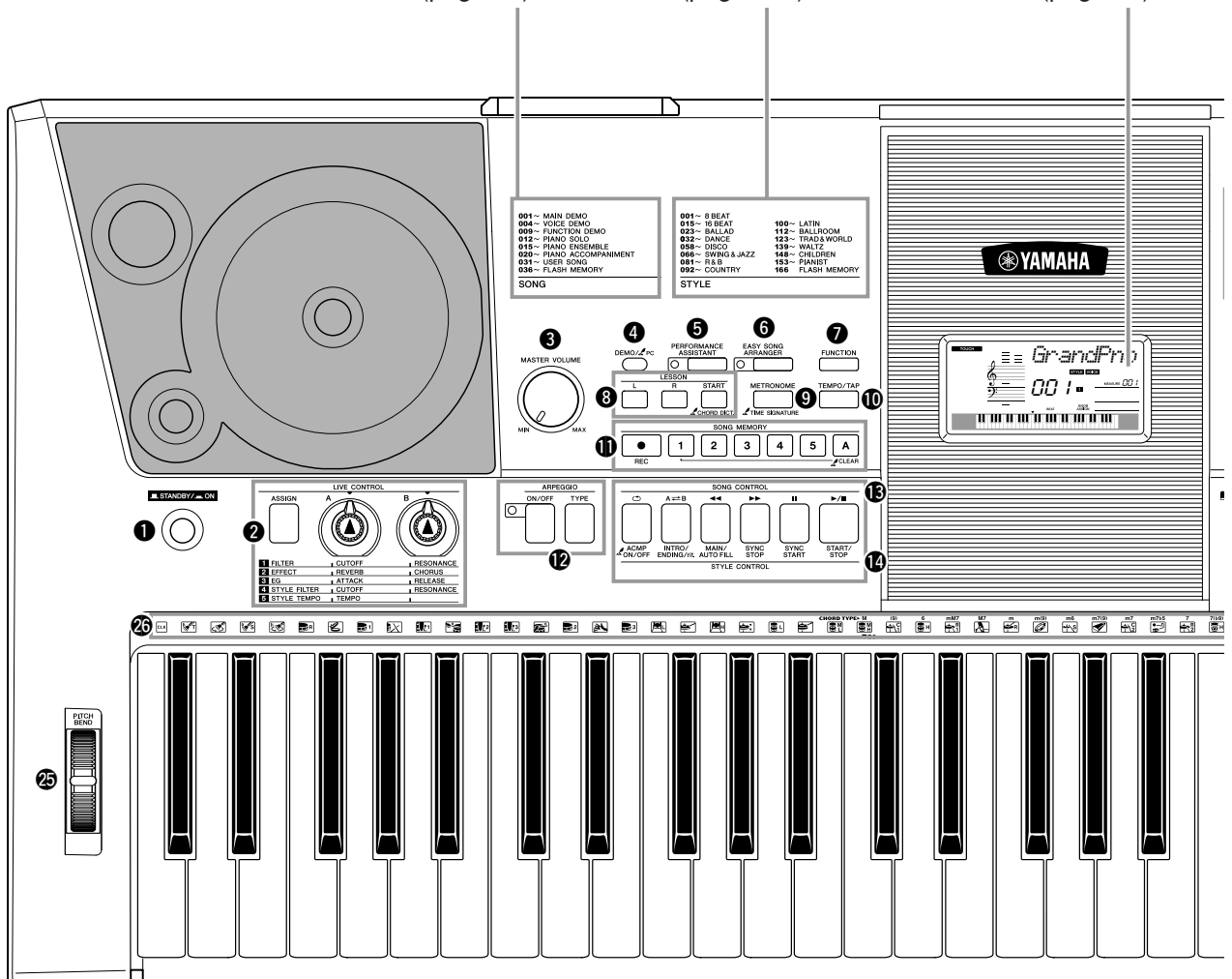

Front Panel

- ① [STANDBY/ON] switch page 11
- ② LIVE CONTROL
 - [ASSIGN] button page 18
 - [A] and [B] knobs page 21
- ③ [MASTER VOLUME] control.... pages 11, 57
- ④ [DEMO/PC] button page 40
- ⑤ [PERFORMANCE ASSISTANT] button page 23
- ⑥ [EASY SONG ARRANGER] button page 50
- ⑦ [FUNCTION] button page 83
- ⑧ LESSON
 - [L], [R] buttons..... page 44
 - [START] button page 44
- ⑨ [METRONOME] button page 63
- ⑩ [TEMPO/TAP] button page 27
- ⑪ SONG MEMORY
 - [REC], [1]–[5], [A] buttons..... page 52

⑫ ARPEGGIO

- [ON/OFF] button page 14
- [TYPE] button page 15

⑬ SONG CONTROL

- [↺] (REPEAT & LEARN) button... page 48
- [A↔B] (A-B REPEAT) button page 78
- [◀◀] (REW) button page 40
- [▶▶] (FF) button page 40
- [⏸] (PAUSE) button..... page 40
- [▶/■] (START/STOP) button....pages 40, 58

⑭ STYLE CONTROL

- [ACMP ON/OFF] button page 34
- [INTRO/ENDING/rit.] button..... page 71
- [MAIN/AUTO FILL] button..... page 71
- [SYNC STOP] button..... page 71
- [SYNC START] button page 70
- [START/STOP] buttonpages 33, 58

Music Database List (page 114) **Voice Category List** (page 106)

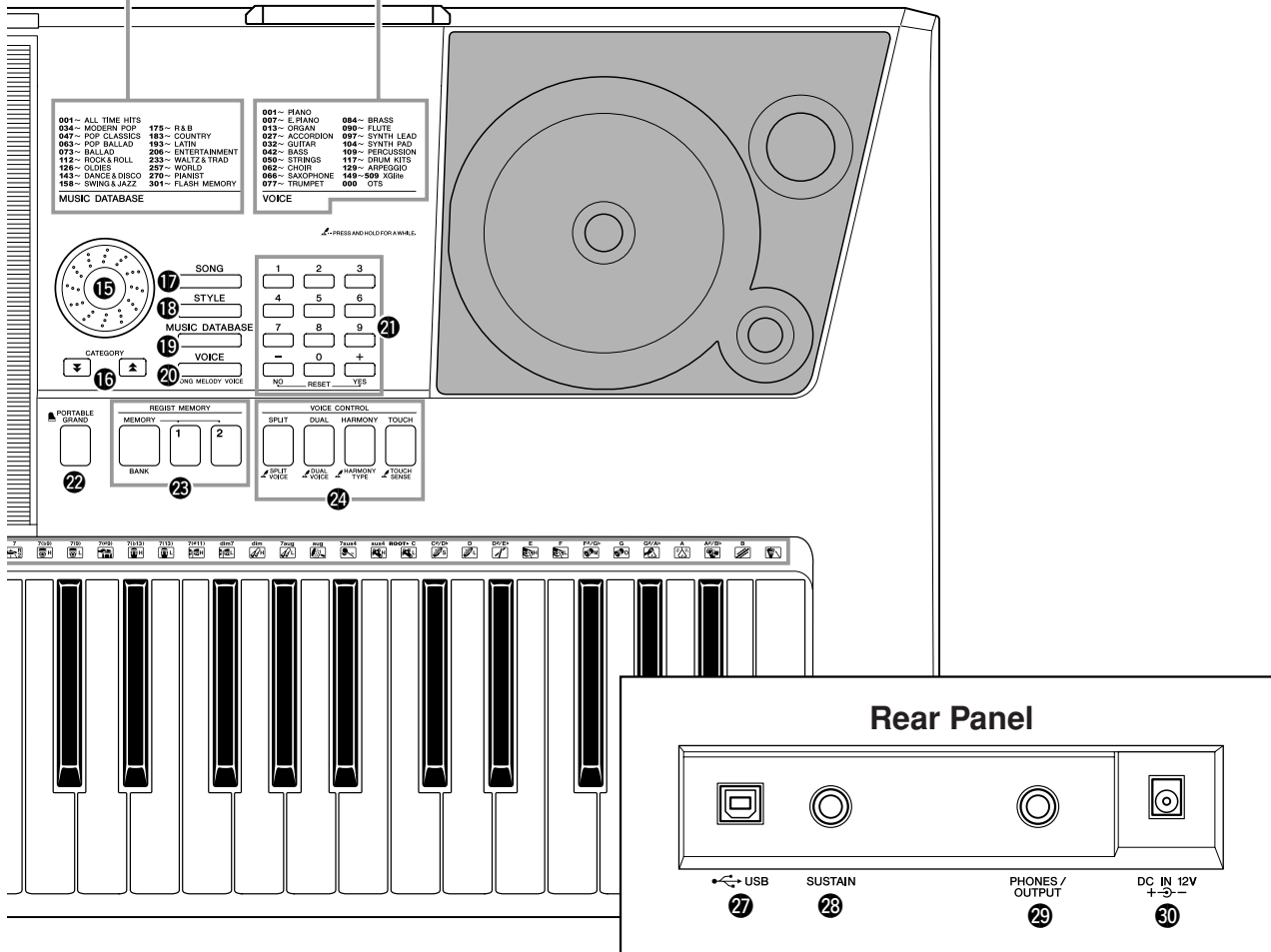

- 15 Dial pages 58, 83
- 16 CATEGORY [\blacktriangle] and [\blacktriangledown] buttons pages 58, 83
- 17 [SONG] button page 39
- 18 [STYLE] button page 33
- 19 [MUSIC DATABASE] button page 49
- 20 [VOICE] button page 28
- 21 Number buttons [0]–[9], [+] and [-] buttons pages 58, 83
- 22 [PORTABLE GRAND] button page 31
- 23 REGIST MEMORY [MEMORY/BANK], [1], [2] buttons .. page 80
- 24 VOICE CONTROL [SPLIT] button page 30 [DUAL] button page 29 [HARMONY] button page 60 [TOUCH] button page 65

- 25 PITCH BEND wheel page 66
- 26 Drum Kit page 32
The illustrations next to each key indicate the drum and percussion instruments assigned to the keys when “Standard Kit 1” is selected.

Rear Panel

- 27 USB terminalpages 11, 87
- 28 SUSTAIN jack page 11
- 29 PHONES/OUTPUT jack page 11
- 30 DC IN 12V jack page 10



Creating Arpeggios

The arpeggio function lets you create arpeggios (broken chords) by simply playing the required notes on the keyboard. For example, you could play the notes of a triad—the root, third, and fifth—and the arpeggio function will automatically create a variety of interesting arpeggio-type phrases. By changing the arpeggio type and the notes you play it is possible to create a wide range of patterns and phrases that can be used for music production as well as performance.

1 Press the ARPEGGIO [ON/OFF] button to turn the arpeggio function on.

The indicator lights when the Arpeggio function is on.

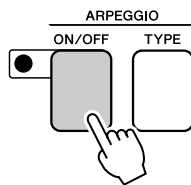

● Voices and the Arpeggio Function

This instrument lets you select a variety of “voices” that you can play via the keyboard. When you select a voice number between 129 and 148 the arpeggio function will automatically be engaged so you can start playing arpeggios immediately. The arpeggio function will automatically be turned off when you select any other voice.

NOTE

• See “Try Playing a Variety of Instrument Voices” on page 28.

If you want to use voices 129–148 for normal performance without the arpeggio function, press the ARPEGGIO [ON/OFF] button to turn the arpeggio function off after selecting the voice.

● Voices for which the arpeggio function is automatically turned on.

Voice No.	Voice Name	Voice No.	Voice Name
129	Concerto	139	ReggaeOrgan
130	Pizzicato	140	Harpeggio
131	Piano Ballad	141	SalsaPlano
132	Synth Sequence	142	AnalogSequence
133	Guitarist	143	Sawtooth
134	Pauls Bass	144	Piano Arpeggio
135	Trance Bass	145	Guitar Arpeggio
136	SynthChords	146	ClubBeat
137	Acid Bass	147	R&B Loop
138	Funky Clavi	148	ClubAdds

2 Select an arpeggio type.

The most suitable arpeggio type is automatically selected when you select a voice, but you can easily select any other arpeggio type.

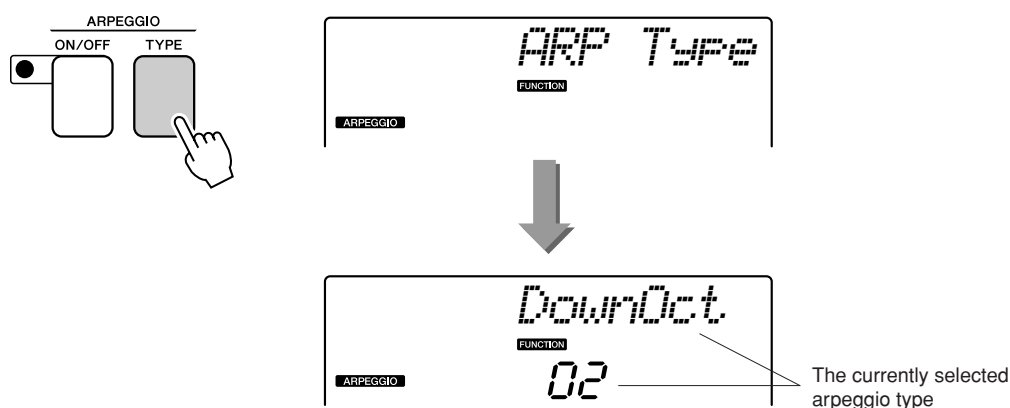

Press the ARPEGGIO [TYPE] button and the name of the current arpeggio type will appear in the display. Rotate the dial to select the desired arpeggio type. A list of the available arpeggio types is provided on page 113.

3 Play the keyboard.

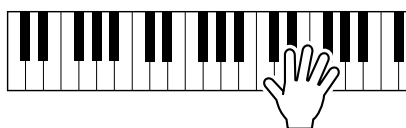

The sound of the arpeggio produced will change according to the number of notes you play and the area of the keyboard you play in. You can save the instrument's settings at this point and then recall them at any time you want to repeat your performance (page 80). You can also record your performance (page 52).

The arpeggio function applies only to the main and dual voices, and does not affect split voices. The arpeggio function cannot be used at the same time as the harmony function.

NOTE

- Make sure that you are not pressing any of the keyboard's keys while turning the arpeggio function on or off.

4 When you have finished playing with the arpeggio function, press the ARPEGGIO [ON/OFF] button to turn it off.

Create a Pop Tune

You can play a style and specify the style chords with your left hand while playing arpeggios with your right hand to create interesting sonic textures and backgrounds.

1 Select the keyboard voice (page 28).

For this example we'll use a grand piano voice, so press the [PORTABLE GRAND] button. This convenient voice selection method lets you instantly select a voice with a single button press.

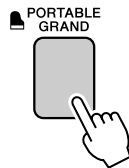

2 After turning the arpeggio function on, select an arpeggio type (steps 1 and 2 on the preceding page).

For this example select "02 DownOct". That completes preparation to use the arpeggio function.

3 Select the style you want to play along with the arpeggio function.

A "style" is an automatic accompaniment pattern. Press the [STYLE] button and the name of the currently selected style will appear in the display. Rotate the dial to select the desired style. For this example we'll use the "002 8BtModrn" (8 Beat Modern) style.

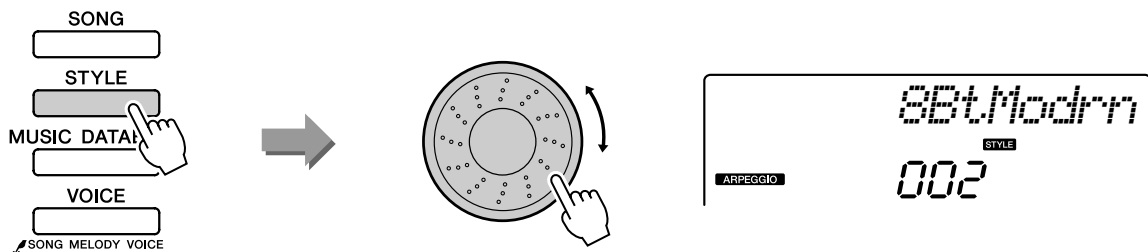

NOTE

• Refer to "Playing Styles" on page 33.

4 Press the [ACMP ON/OFF] button to turn auto accompaniment on.

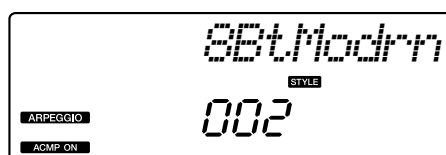
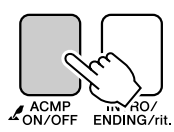

ACMP ON
The ACMP ON icon will appear.

When auto accompaniment is turned on, the left-hand section of the keyboard is used only for specifying accompaniment chords.

NOTE

• Refer to "When automatic accompaniment is on ..." on page 34.

5 Press the [START/STOP] button.

The rhythm accompaniment will start.

6 Begin playing.

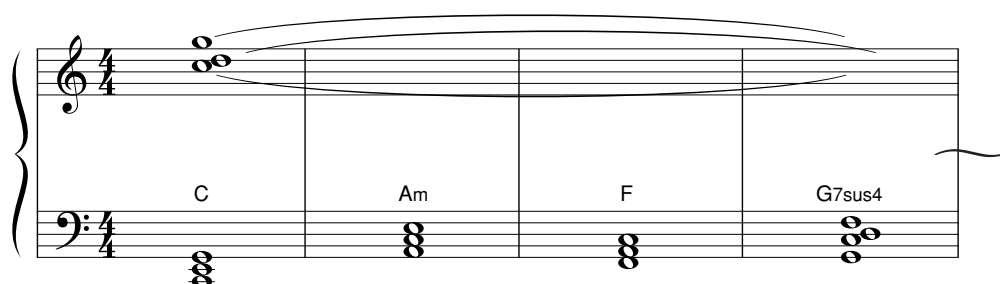

Listen carefully to the rhythm of the style, then play the notes shown in the score at the beginning of a measure. The style and arpeggio will begin playing together. The accompaniment will change accordingly each time you play a new left-hand chord. Of course you can also change your right-hand fingering to produce interesting changes. If you're not comfortable with right-hand playing yet, you could use the performance assistant technology feature described on page 23. When the performance assistant feature is on, playing any right-hand key will always produce musically appropriate notes!

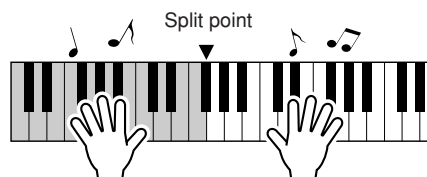

Whenever you're playing a style as well as a right-hand part, be sure that your left hand plays only to the left of the split point and your right hand plays only to the right of the split point. (page 30)



Create Original Sounds

The two knobs located in the lower left area of the panel can be used to add variations to the sound being played, transforming the sound in a variety of musical ways. Filter, envelope generator, and other effects can be assigned to the two knobs as required. In this section we'll explain how effects can be assigned to the knobs, and provide a few tips for their use.

Assigning Effects to the Knobs

Repeatedly press the [ASSIGN] button to sequentially select the five effect combinations provided: **1** → **2** → **3** → **4** → **5** → **1** → ... etc. The currently selected combination is shown in the display.

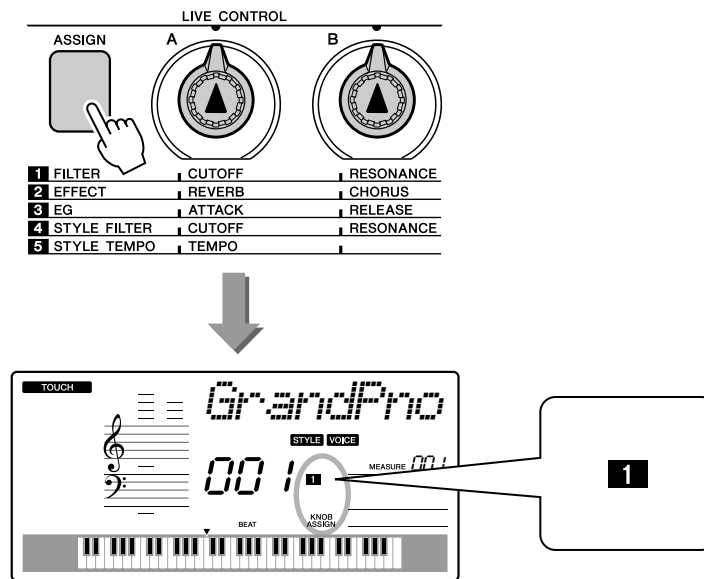

Number/Effect	Knob A	Knob B
1 Filter	Filter Cutoff	Filter Resonance
2 Effect	Reverb Send Level	Chorus Send Level
3 EG	Attack Time	Release Time
4 Style Filter	Filter Cutoff	Filter Resonance
5 Style Tempo	Tempo	-No Effect-

The assignable knob effects are pre-programmed in the pairs listed above. It is not possible to assign different effect combinations.

1–3 affect the main and dual voices only. Split voices will not be affected. Styles and songs will also not be affected.

4–5 affect styles only.

1 Filter

Filter effects shape sound by allowing only a specified range of frequencies to pass and/or by producing a resonance peak at the filter's "cutoff" frequency. Filter effects can be used to create a range of synthesizer-like sounds.

* Filter effects can sometimes cause distortion in the bass frequencies.

Some hints for using the filter effects are provided on page 22.

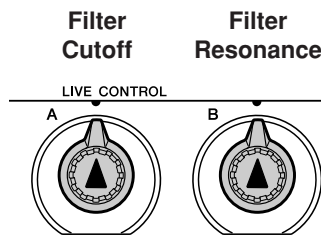

Knob A adjusts the filter's cutoff frequency, and therefore the brightness of the sound.

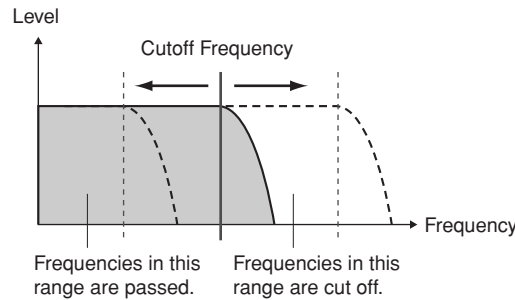

Knob B adjusts the amount of resonance applied at the filter's cutoff frequency. Increasing the resonance emphasizes the frequencies at the cutoff frequency, and thus "strengthens" the perceived effect of the filter.

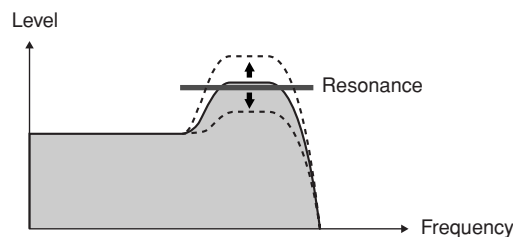

2 Effect

Reverb reproduces the acoustic ambience of a concert hall or club, while chorus produces a layered "multi-instrument" effect.

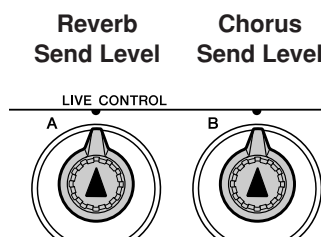

Knob A adjusts the depth of the reverb effect, and Knob B adjusts the depth of the chorus effect.

3 EG (Envelope Generator)

Envelope Generator effects determine how the level of the sound varies over time. You can make the attack faster for a more percussive sound or slower for a violin-like sound, for example. Or you can lengthen or shorten the sustain to most ideally match the music.

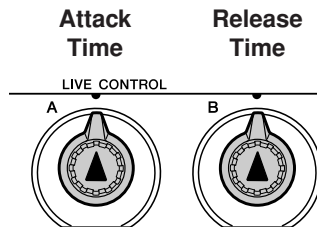

Knob A adjusts attack time (the amount of time it takes the sound to reach maximum level when a key is played).

Knob B adjusts release time (the amount of time it takes for the sound to decay to silence after a key is released).

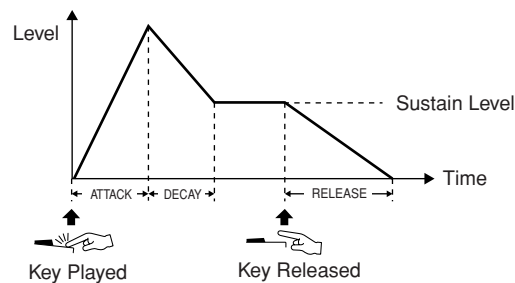

4 Style Filter

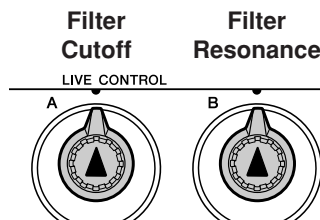

In this case the knobs apply the filter effect to the style being played. Knob A and Knob B have the same functions as for “1 Filter” described on the preceding page.

5 Style Tempo

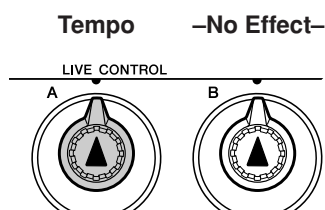

Knob A adjusts the tempo of the style and arpeggios. Rotating the knob clockwise increases the tempo while rotating it counterclockwise decreases the tempo. The knob’s center position produces the initial default tempo.

Using the Knobs

1 Select the voice you want to play on the keyboard.

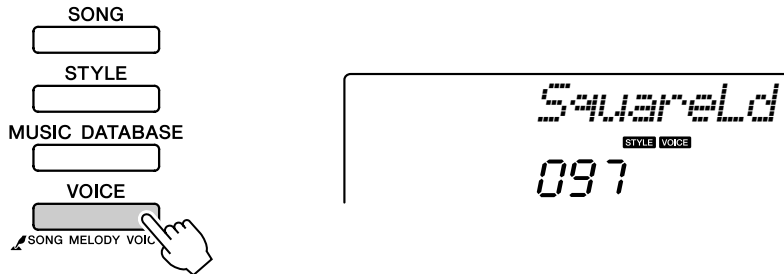

The name of the currently selected voice will appear in the display when you press the [VOICE] button. Use the dial to select the desired voice. For this example we want to use a synth-lead type voice, so select “97 SquareLd” (Square-wave Lead).

2 Press the [ASSIGN] button as many times as necessary to select “1 FILTER” (“1” will appear in the display).

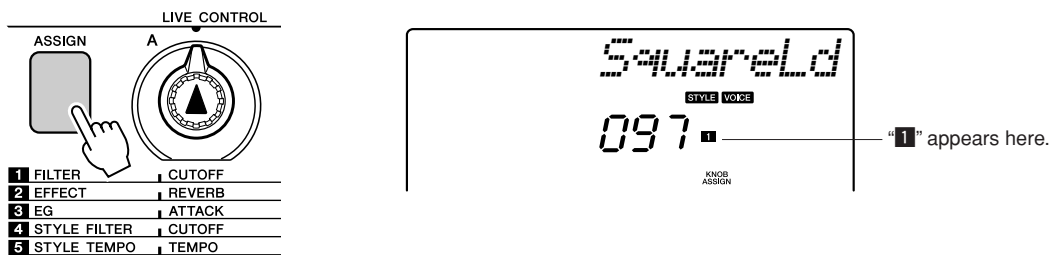

Knob A can now be used to adjust the filter cutoff frequency, and Knob B can be used to adjust the resonance.

3 Rotate Knob B to its maximum setting (all the way to the right).

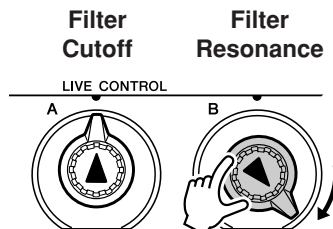

Rotating the knob to the right while the volume is set to a high level can result in distortion. If this occurs, reduce the volume level.

4 Play with the right hand while operating Knob A with the left hand.

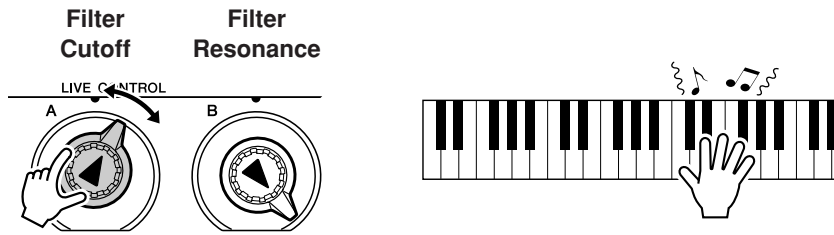

If you select a different keyboard voice the knobs will be reset and the ideal settings for the selected voice will be automatically recalled. In the same way, if the “**4** STYLE FILTER” effect is selected, the knobs will be reset if a different style is selected. If you create an original setting you like, it might be a good idea to save it in the instrument’s Registration Memory (page 80) so you can recall the same settings again at any time. You can also record performances using original sounds you’ve created (page 52).

The chart below lists some interesting ways to use the various effects that can be assigned to the knobs.

Changing the knob settings does not immediately change the sound. Newly assigned effects will only change the sound when the knobs are first operated after the new effect has been selected.

● Some Ideas for Using the Knobs

Number/Effect	Try This
1 FILTER	Select a synth-type lead or pad voice (page 106). Turn Knob B all the way up and operate Knob A while playing for some spacey, floating 1980’s effects.
2 EFFECT	Select a voice that sounds as though it already has reverb and chorus effects applied, and turn Knob A and Knob B all the way down to hear the “direct” sound of the voice. You can then turn the Knob A and Knob B settings up to add extra impact and richness to the voice.
3 EG	Select a piano voice, and turn Knob B all the way up and Knob A to about the 3 o’clock position. This should give you a majestic, organ-like sound. The attack time is quite long so play the keys and hold them to let the sound come in fully. Ideal for slow pieces.
4 STYLE FILTER	Select style 39, Euro Trance. Turn accompaniment on and start style playback (page 34). Set Knob B to about 3 o’clock, and Knob A to about 8 o’clock. The overall sound of the style should be a bit muffled, with the drums emphasized for solid rhythmic impact.
5 STYLE TEMPO	Play a style and/or arpeggio (page 14) and use Knob A to adjust the tempo.



The Easy Way to Play Piano

This instrument includes a performance assistant technology feature that lets you play along with a song and sound like a great pianist (even though you might be making lots of mistakes)! In fact, you can play any notes and still sound good!

So even if you can't play piano and can't read a note of music, you can have some musical fun. It's never too late to start learning!

Refer to page 25 for more information on using performance assistant technology to help you play.

Play with Both Hands

1 Press the [PERFORMANCE ASSISTANT] button.

The indicator lights when the performance assistant technology feature is on.



Press the [PERFORMANCE ASSISTANT] button to turn the function on or off.

2 Select a song.

Press the [SONG] button, and the song number and name will be displayed. You can use the dial or other selection controls to select a different song.

For this example try selecting the "010 AveMaria".

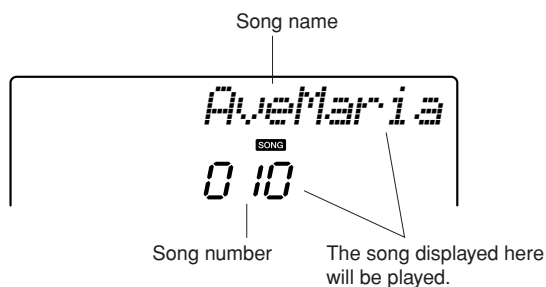
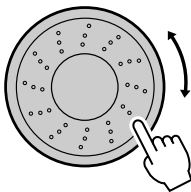
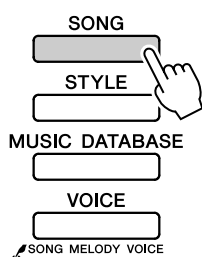

● What is a "Song"?

Of course you know the normal meaning of the word, but for this instrument the term "song" also refers to the data that makes up a piece of music. You can listen to the songs, use them for lessons, and use them with a range of other functions (page 39).

3 Press the [▶/■] (START/STOP) button.

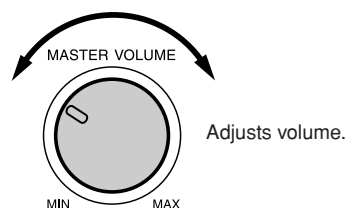
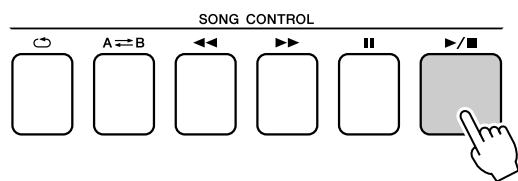

Song playback will begin.
The basic pattern will repeat. Listen to four measures while memorizing the basic pattern. It's your turn to play the part from the fifth measure.

4 Play on the keyboard.

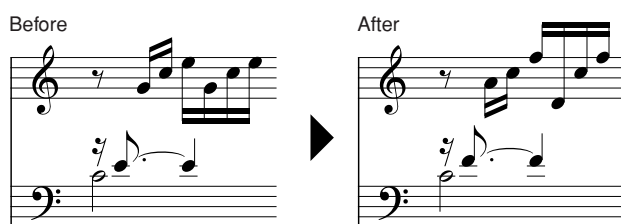
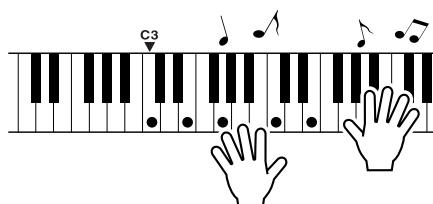

Play the score on the left along with the accompaniment using both hands. You can even play the same keys over and over: C, E, G, C, E, G, C, E. Performance assistant technology will make sure that the notes will come out as if they were played according to the score on the right. Keep playing, and performance assistant technology will continue to “correct” the notes that you play.

You can stop song playback at any time by pressing the [▶/■] (START/STOP) button.

5 Press the [PERFORMANCE ASSISTANT] button to turn the performance assistant technology feature off.

The complete score for Ave Maria is provided on page 102.

Use the Performance Assistant to Play Like a Pro!

To begin, try to feel the rhythm of the song. Then, with your hands spread as shown in the illustration, simply play the keyboard alternately with your left and right hands (any notes will do).

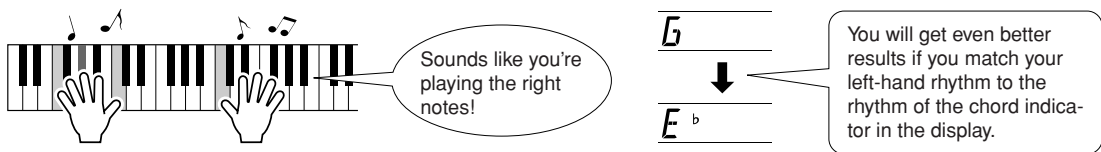

How does it sound? You'll get acceptable results no matter where you play thanks to performance assistant technology!

Next try the three playing methods illustrated below. Different ways of playing produce different results.

- Play with the left and right hands at the same timing—type 1.

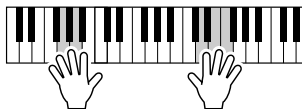

Play 3 notes at once with your right hand.

- Play with the left and right hands at the same timing—type 2.

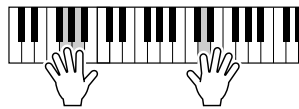

Play 1 note at a time with your right hand (for example: index finger → middle finger → ring finger).

- Play alternately with the left and right hands—type 3.

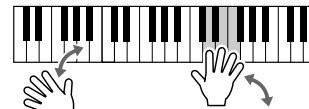

Play 3 notes at once with your right hand.

Once you get a feel for it, try playing chords with your left hand and a melody with your right ... or any other combination.

To use the performance assistant technology feature it is necessary to play a song that includes chord data, or a style with auto accompaniment on.

If a song includes the required data, the chords are shown on the right side of the display (page 59).

Next try playing the Chopin Nocturne.

- 1** The procedure is that same as that described for playing Ave Maria on pages 23–25. Select “011 Nocturne”.

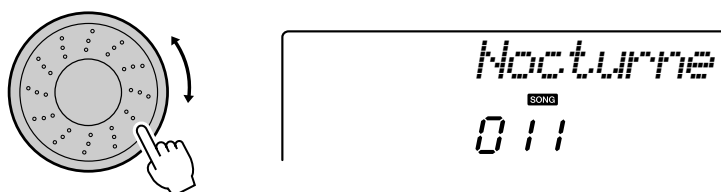

- 2** Listen to eight measures, then begin playing from the ninth measure.

Play the keys shown in the illustration. Keep playing F, A and C with your left hand and the correct notes will sound as the song proceeds. When you get used to playing the left hand part, refer to “The Easy Way to Play Piano” on page 23 and try adding the right-hand part.

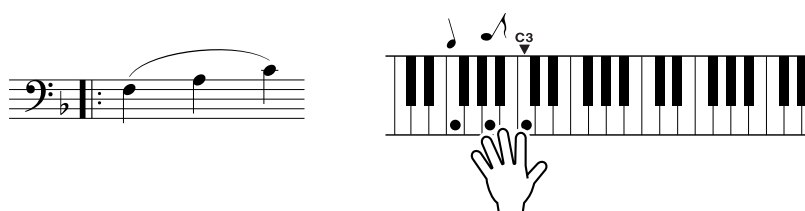

- 3** Press the [PERFORMANCE ASSISTANT] button to turn the performance assistant technology feature off.

The complete score for Nocturne is provided on page 104.

Change the Song Tempo

When using the performance assistant technology or in other situations in which the tempo of the song is too fast or too slow for you, you can change the tempo as required. Press the [TEMPO/TAP] button. The tempo display will appear and you can use the dial, the [+] and [-] buttons, or the [0] to [9] number buttons to set to tempo to anywhere from 011 and 280 quarter-note beats per minute.

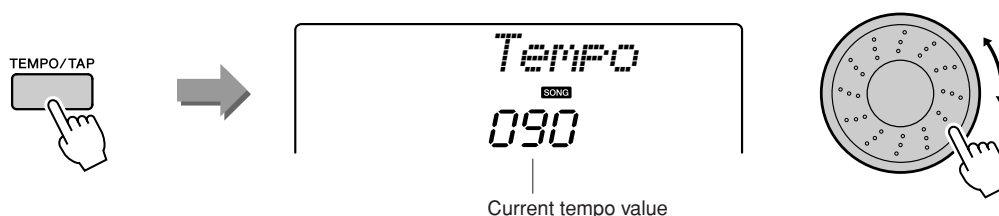

You can return to the original tempo by simultaneously pressing the [+] and [-] buttons.

● About the Beat Display

The arrow marks in the beat display flash in time with the rhythm of the song or style.

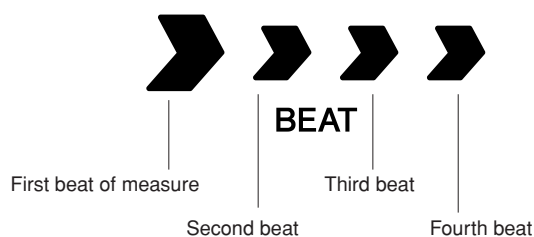



Try Playing a Variety of Instrument Voices

In addition to piano, organ, and other “standard” keyboard instruments, this instrument has a large range of voices that includes guitar, bass, strings, sax, trumpet, drums and percussion, sound effects ... a wide variety of musical sounds.

Select and Play a Voice—MAIN

This procedure selects the main voice you will play on the keyboard.

1 Press the [VOICE] button.

The voice number and name will be displayed.

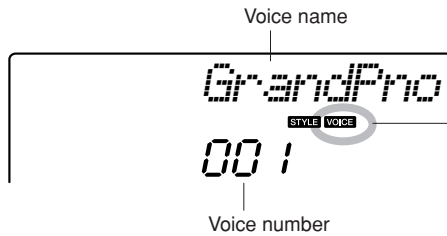
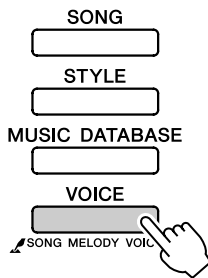

Appears when the Voice mode is engaged.

2 Select the voice you want to play.

While watching the displayed voice name rotate the dial. The available voices will be selected and displayed in sequence. The voice selected here becomes the main voice.

For this example select the “092 Flute” voice.

NOTE

- You can also select the voice using the CATEGORY [\blacktriangle] and [\blacktriangledown] buttons after pressing the [VOICE] button. (page 58)

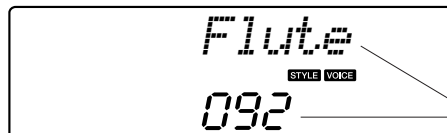
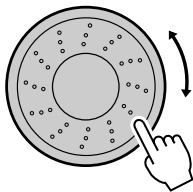

Select 092 Flute

3 Play the keyboard.

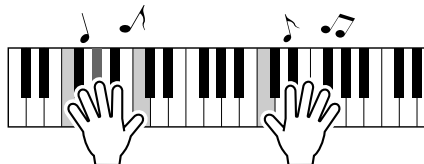

Try selecting and playing a variety of voices.

Play Two Voices Simultaneously—DUAL

You can select a second voice which will play in addition to the main voice when you play the keyboard. The second voice is known as the “dual” voice.

1 Press the [DUAL] button.

The [DUAL] button turns the dual voice on or off. When turned on the dual voice icon will appear in the display. The currently selected dual voice will sound in addition to the main voice when you play the keyboard.

NOTE

• The dual voice feature cannot be used during a song lesson (page 43).

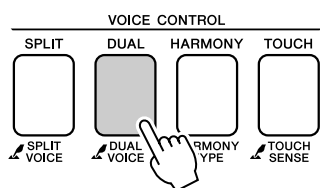

Dual voice icon

2 Press and hold the [DUAL] button for longer than a second.

“D.VOICE” appears in the display for a few seconds, then the currently selected dual voice will be displayed.

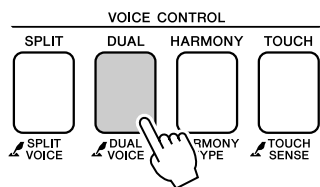

Hold for longer than a second

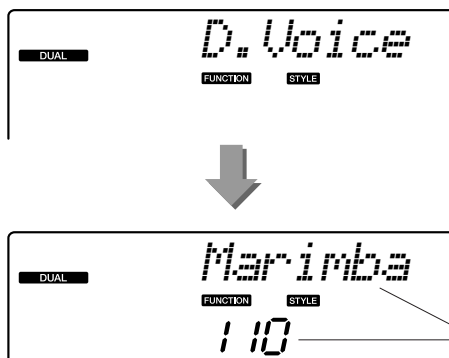

The currently selected dual voice

NOTE

• You can also select the Dual Voice display by pressing the [FUNCTION] button and then using the CATEGORY [▲] and [▼] buttons to select the “D.Voice” item.

3 Select the desired dual voice.

Watch the displayed dual voice and rotate the dial until the voice you want to use is selected. The voice selected here becomes the dual voice. For this example try selecting the “109 Vibraphone” voice.

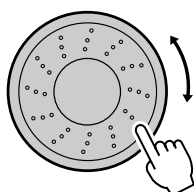

4 Play the keyboard.

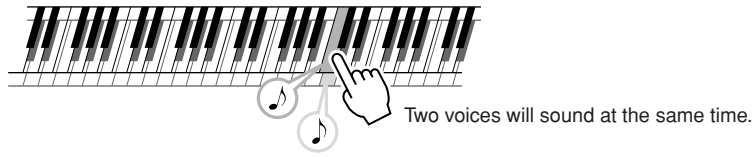

Try selecting and playing a range of dual voices.

Play Different Voices with the Left and Right Hands—SPLIT

In the split mode you can play different voices to the left and right of the keyboard “split point”. The main and dual voices can be played to the right of the split point, while the voice played to the left of the split point is known as the “split voice”. The split point setting can be changed as required (page 72).

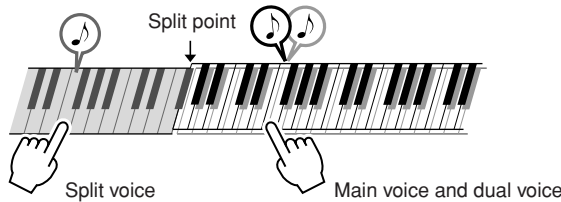

1 Press the [SPLIT] button.

The [SPLIT] button turns the split voice on or off. When turned on the split voice icon will appear in the display. The currently selected split voice will sound to the left of the keyboard split point.

NOTE

- The split voice feature cannot be used during a song lesson (page 43).

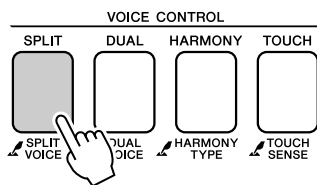

2 Press and hold the [SPLIT] button for longer than a second.

“S.VOICE” appears in the display for a few seconds, then the currently selected split voice will be displayed.

NOTE

- You can also select the Split Voice display by pressing the [FUNCTION] button and then using the CATEGORY [▲] and [▼] buttons to select the “S.Voice” item.

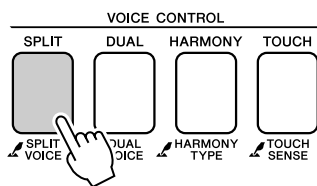

Hold for longer than a second

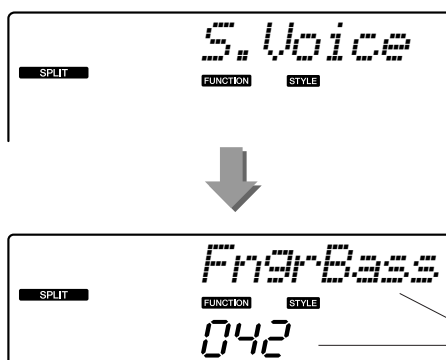

3 Select the desired split voice.

Watch the displayed split voice and rotate the dial until the voice you want to use is selected. The voice selected here becomes the split voice which will play to the left of the keyboard split point. For this example try selecting the “033 Folk Guitar” voice.

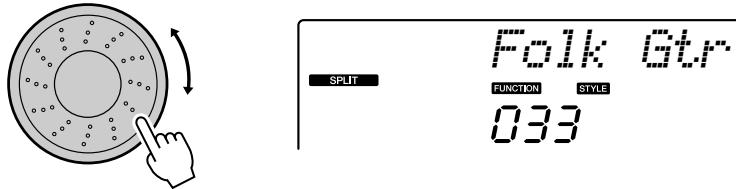

4 Play the keyboard.

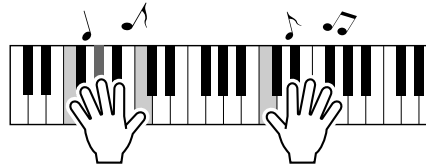

Try selecting and playing a range of split voices.

Play the Grand Piano Voice

When you just want to play piano, all you have to do is press one convenient button.

Press the [PORTABLE GRAND] button.

The “001 Grand Piano” voice will be selected.

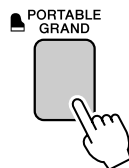

NOTE

- When you press the [PORTABLE GRAND] button all settings other than touch sensitivity are turned off. The dual and split voices will also be turned off, so only the Grand Piano voice will play over the entire keyboard.



Fun Sounds

This instrument includes a range of drum kits and unique sound effects you can use for entertainment. Laughter, babbling brooks, jet fly-bys, eerie effects, and much more. These sounds can be a great way to enhance the mood at parties.

Drum Kits

Drum kits are collections of drum and percussion instruments. When you select a violin or other normal instrument main voice, for example, all keys produce the sound of the same violin, only at different pitches. If you select a drum kit as the main voice, however, each key produces the sound of a different drum or percussion instrument.

◆ Drum Kit Selection Procedure → (refer to steps 1 and 2 on page 28)

- 1 Press the [VOICE] button.
- 2 Use the dial to select “117 Std.Kit1”.
- 3 Try out each key and enjoy the drum and percussion sounds!

Try out each key and enjoy the drum and percussion sounds! Don't forget the black keys! You'll hear a triangle, maracas, bongos, drums ... a comprehensive variety of drum and percussion sounds. For details on the instruments included in the drum kit voices (voice numbers 117 to 128), see the “Drum Kit List” on page 110.

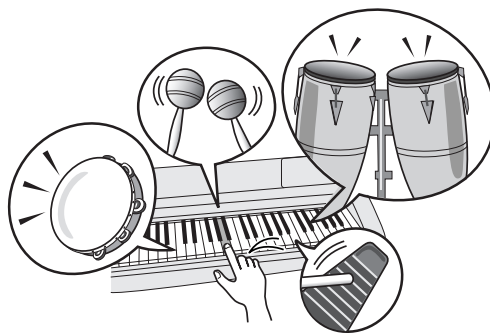

Sound Effects

The sound effects are included in the drum kit voice group (voice numbers 127 and 128). When either of these voices are selected you will be able to play a range of sound effects on the keyboard.

◆ Sound Effect Selection Procedure → (refer to steps 1 and 2 on page 28)

- 1 Press the [VOICE] button.
- 2 Use the dial to select “128 SFX Kit2”.
- 3 Try out each key and enjoy the sound effects!

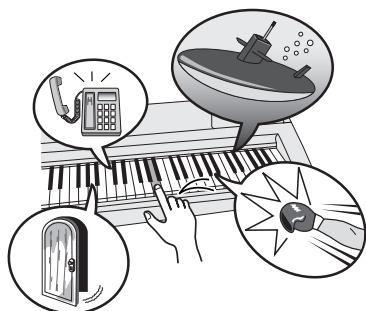

As you try out the various keys you'll hear the sound of a submarine, a telephone bell, a creaking door, laughter, and many other useful effects. “127 SFX Kit1” includes lightning, running water, dogs barking, and others. Some keys do not have assigned sound effects, and will therefore produce no sound. For details on the instruments included in the SFX kit voices, see “SFX Kit 1” and “SFX Kit 2” in the “Drum Kit List” on page 110.





Playing Styles

This instrument has an auto accompaniment feature that produces accompaniment (rhythm + bass + chords) in the style you choose to match chords you play with your left hand. You can select from 165 different styles covering a range of musical genres and time signatures (see page 112 for a complete list of the available styles). In this section we'll learn how to use the auto accompaniment features.

Select a Style Rhythm

Most styles includes a rhythm part. You can select from a wide variety of rhythmic types—rock, blues, Euro trance, and many, many more. Let's begin by listening to just the basic rhythm. The rhythm part is played using percussion instruments only.

1 Press the [STYLE] button.

The style number and name will appear in the display.

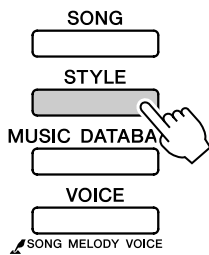

This icon appears when a style number and name is displayed.

2 Select a style.

Use the dial to select the style you want to use. A list of all the available styles is provided on page 112.

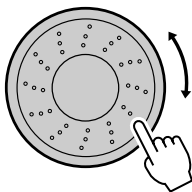

NOTE

• An external style file loaded into style number 166 can be selected and used in the same way as the internal styles. The style file must be loaded into style number 166 after transferring it to the instrument from a computer. For details, refer to the section "Loading Style Files" on page 74.

3 Press the [START/STOP] button.

The style rhythm will start playing. Press the [START/STOP] button a second time when you want to stop playback.

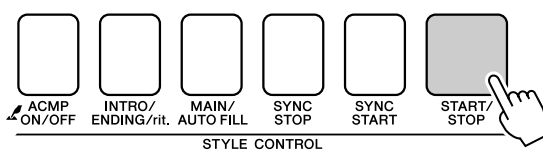

NOTE

• Style numbers 141, 153–165 have no rhythm part and therefore no rhythm will play if you use them for the above example. For these styles first turn auto accompaniment on as described on page 34, press the [START/STOP] button, and the accompaniment bass and chord parts will begin playing when you play a key to the left of the keyboard split point.

Play Along with a Style

You learned how to select a style rhythm on the preceding page.

Here we'll see how to add bass and chord accompaniment to the basic rhythm to produce a full, rich accompaniment that you can play along with.

1 Press the [STYLE] button and select the desired style.

2 Turn automatic accompaniment on.

Press the [ACMP ON/OFF] button.

Pressing this button a second time will turn automatic accompaniment off.

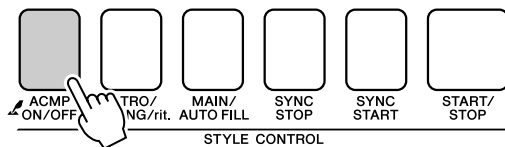

● **When automatic accompaniment is on ...**

The area of the keyboard to the left of the split point (54 : F#2) becomes the "auto accompaniment region" and is used only for specifying the accompaniment chords.

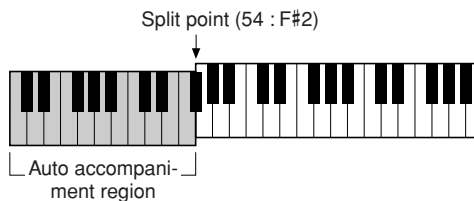

NOTE

- The keyboard split point can be changed as required: refer to page 72.

3 Turn sync start on.

Press the [SYNC START] button to turn the sync start function on.

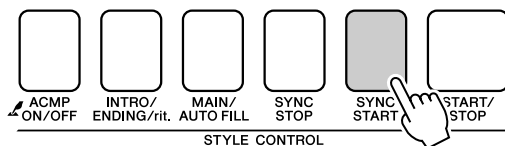

When sync start is on, the bass and chord accompaniment included in a style will start playing as soon as you play a note to left of the keyboard split point. Press the button a second time to turn the sync start function off.

4 Play a left-hand chord to start the style.

You can still “play” chords even if you don’t actually know any chords. This instrument will recognize even a single note as a chord. Try playing from one to three notes at the same time to the left of the split point. The accompaniment will change according to the left-hand notes you play.

Try this!

Scores for some chord progressions are provided on page 36. These examples should help you get a feel for what types of chord progressions sound good with the styles.

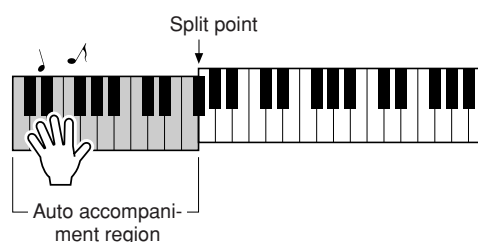

5 Play a variety of left-hand chords while playing a melody with your right hand.

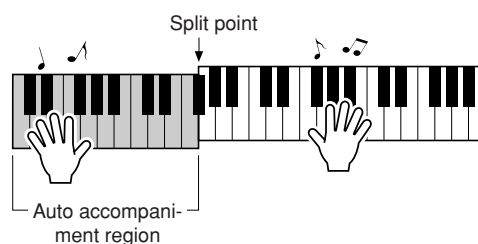

6 Press the [START/STOP] button to stop style playback when you’re done.

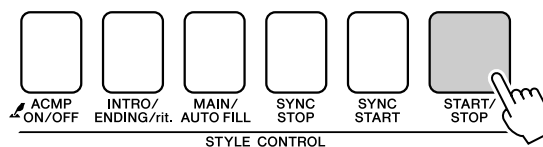

You can switch style “sections” to add variety to the accompaniment. Refer to “Pattern Variation (Sections)” on page 70.

Styles Are More Fun When You Understand Chords

Chords, created by playing multiple notes at the same time, are the basis for harmonic accompaniment. In this section we'll take a look at sequences of different chords played one after another, or "chord sequences." Since each chord has its own unique "color"—even if it's different fingerings of the same chord—the chords you choose to use in your chord progressions have a huge influence on the overall feel of the music you play.

On page 34 you learned how to play colorful accompaniments using styles. Chord progressions are vital to creating interesting accompaniments, and with a little chord know-how you should be able to take your accompaniments to a new level.

On these pages we'll introduce three easy-to-use chord progressions. Be sure to try them out with the instrument's accompaniment styles. The style will respond to the chord progression you play, effectively creating a complete song.

■ Playing the Chord Progressions

Play the scores with the left hand.

Before playing the scores follow steps 1 through 3 of "Play Along with a Style" on page 34.

* The scores provided here are not standard song scores, but rather simplified scores that indicate which notes to play to produce the chord progressions.

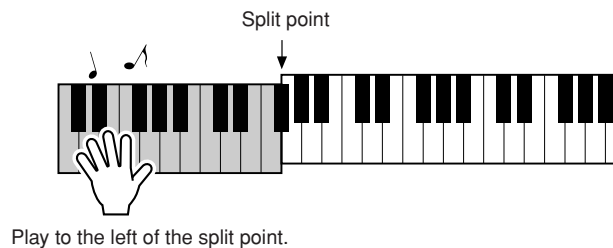

Recommended Style 039 Euro Trance

—Dance music with simple chords—

Press the [INTRO/ENDING/rit.] button.

This is a simple-but-effective chord progression. When you play through to the end of the score, start again from the beginning. When you're ready to stop playing press the [INTRO/ENDING/rit.] button and the auto accompaniment function will create a perfect ending.

Recommended Style **158 Piano Boogie**

—3-chord boogie-woogie—

Press the [INTRO/ENDING/rit.] button.

The first row shows a bass clef staff with a common time signature (C). It contains three measures: the first measure has a C chord, the second has an F chord, and the third has a C chord. A double bar line is placed after the second measure. Below each measure is a keyboard diagram showing the chord voicing. A box with an arrow points to the first measure, containing the text 'Press the [INTRO/ENDING/rit.] button.' The second row follows the same format but starts with a G chord in the first measure, followed by F and C chords in the subsequent measures. A box with an arrow points to the end of the second row, containing the text 'Press the [INTRO/ENDING/rit.] button.'

This progression provides varied harmonic backing with just three chords. When you get a feel for the progression in the score, try changing the order of the chords!

Recommended Style **101 Bossa Nova**

—Bossa nova with jazz-style chords—

Press the [INTRO/ENDING/rit.] button.

The first row shows a bass clef staff with a common time signature (C). It contains four measures with the following chords: Dm, G7, CM7, and FM7. A double bar line is placed after the second measure. Below each measure is a keyboard diagram showing the chord voicing. A box with an arrow points to the first measure, containing the text 'Press the [INTRO/ENDING/rit.] button.' The second row contains four measures with the following chords: Bm7^{b5}, E7, Am, and A7. A double bar line is placed after the second measure. Below each measure is a keyboard diagram showing the chord voicing.

This progression includes jazzy “two-five” (II-V) changes. Try playing it through several times. When you’re ready to stop playing press the [INTRO/ENDING/rit.] button.

Playing Auto-accompaniment Chords

There are two ways of playing auto-accompaniment chords:

- Easy Chords
- Standard Chords

The instrument will automatically recognize the different chord types. This function is called Multi Fingering.

Press the [ACMP ON/OFF] button to turn auto-accompaniment on (page 34). The keyboard to the left of the split point (default: 54/F#2) becomes the “accompaniment range”. Play the accompaniment chords in this area of the keyboard.

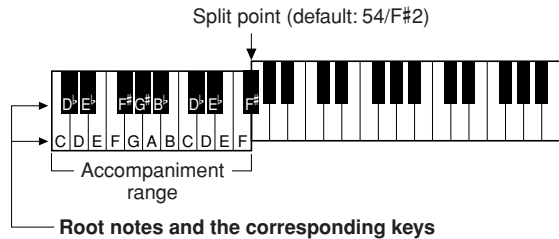

■ Easy Chords

This method lets you easily play chords in the accompaniment range of the keyboard using only one, two, or three fingers.

	<p>C</p> <ul style="list-style-type: none"> • To play a major chord Press the root note of the chord.
	<p>Cm</p> <ul style="list-style-type: none"> • To play a minor chord Press the root note together with the nearest black key to the left of it.
	<p>C7</p> <ul style="list-style-type: none"> • To play a seventh chord Press the root note together with the nearest white key to the left of it.
	<p>Cm7</p> <ul style="list-style-type: none"> • To play a minor seventh chord Press the root note together with the nearest white and black keys to the left of it (three keys altogether).

■ Standard Chords

This method lets you produce accompaniment by playing chords using normal fingerings in the accompaniment range of the keyboard.

● How to play Standard Chords [Example for “C” chords]

* Notes enclosed in parentheses () are optional; the chords will be recognized without them.



Using Songs

With this instrument the term “song” refers the data that makes up a piece of music. You can simply enjoy listening to the 30 internal songs, or use them with just about any of the many functions provided—the performance assistant technology feature, lessons, and more. The songs are organized by category. In this section we’ll learn how to select and play songs, and briefly describe the 30 songs provided.

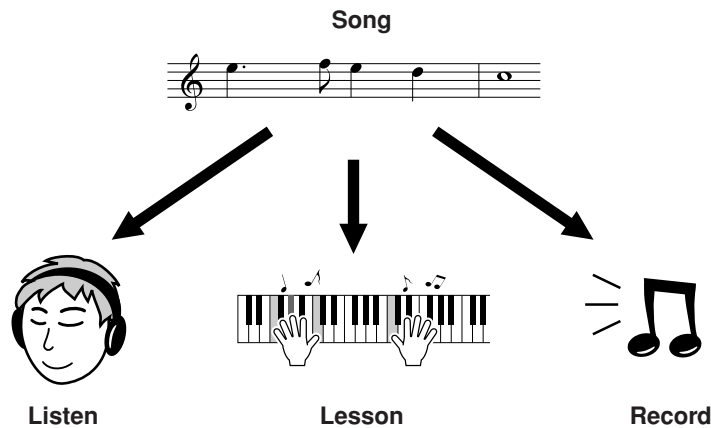

Select and Listen to a Song

1 Press the [SONG] button.

The song number and name will be displayed. You can use the dial to select a different song.

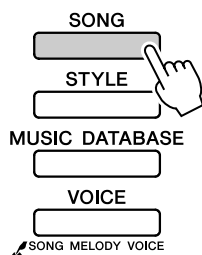

The currently selected song and number are displayed

2 Select a song.

Select a song after referring to the preset song category list on page 41. Use the dial to select the song you want to listen to.

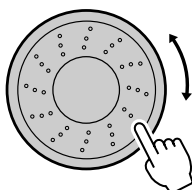

The song displayed here can be played

NOTE

- You can also play songs you have recorded yourself (User Songs) or songs that have been transferred to the instrument from a computer in the same way that you play the internal songs.

001–030	Built in Songs (see next page)
031–035	User Songs (Songs you record yourself).
036–	Songs transferred from a computer (pages 90–92)

3 Listen to the song.

Press the [▶/■] (START/STOP) button to begin playback of the selected song.

You can stop playback at any time by pressing the [▶/■] (START/STOP) button again.

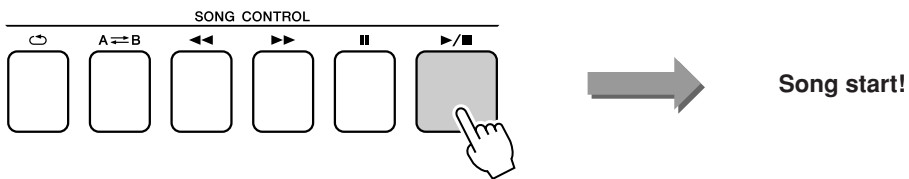

● Using the [DEMO/PC] button

Press the [DEMO/PC] button to play Songs 001–008 in sequence. Playback will continue repeatedly starting again from the first Song (001).

You can select a song by using the [-] and [+] buttons after pressing the [DEMO/PC] button.

You can stop playback at any time by pressing the [DEMO/PC] button.



Song Fast Forward, Fast Reverse, and Pause

These are just like the transport controls on a cassette deck or CD player, letting you fast forward [▶▶] (FF), rewind [◀◀] (REW) and pause [||] (PAUSE) playback of the song.

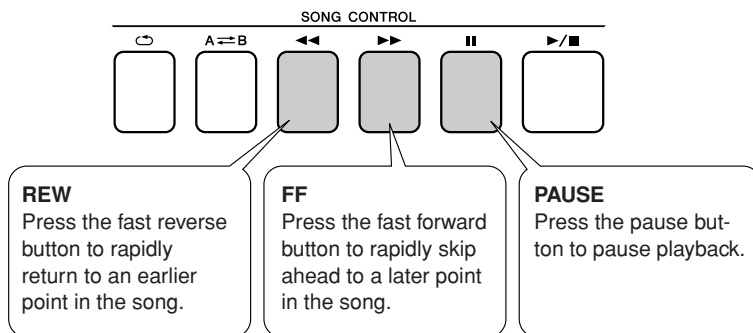

NOTE

- When an A-B repeat range is specified the fast reverse and forward function will only work within that range.

● Song List

These 30 songs include songs that effectively demonstrate the instrument's easy song arranger feature, songs that are ideally suited for use with the performance assistant technology feature, and more. The "Suggested Uses" column provides some ideas as to how the songs can most effectively be used.

Category	No.	Name	Suggested Uses
Main Demo	1 CHORD	Elements	The songs in this category have been created to give you an idea of the advanced capabilities of this instrument. They're great for listening, or for use with the performance assistant technology feature.
	2 CHORD	Jessica	
	3 CHORD	Chillin	
Voice Demo	4 CHORD	Grand Piano Demo	These songs features some of the instrument's many useful voices. They make maximum use of the characteristics of each voice, and might serve as inspiration for your own compositions.
	5 CHORD	Sweet! Tenor Sax Demo	
	6 CHORD	Cool! Rotor Organ Demo	
	7 CHORD	Cool! Galaxy Electric Piano Demo	
	8 CHORD	Modern Harp & Sweet! Soprano Demo	
Function Demo	9 CHORD	Hallelujah Chorus	Use these songs to experience some of the instrument's advanced features: song number 9 for the easy song arranger, and songs 10 and 11 for the performance assistant technology feature.
	10 CHORD	Ave Maria	
	11 CHORD	Nocturne op.9-2	
Piano Solo	12	For Elise	These piano solo pieces are ideally suited for use as lesson songs.
	13	Maple Leaf Rag	
	14	The Last Rose of Summer	
Piano Ensemble	15 CHORD	Amazing Grace	A selection of piano ensemble songs that are also well suited for use as lesson songs.
	16 CHORD	Die Lorelei	
	17	Piano Concerto No.21 2nd mov.	
	18 CHORD	Scarborough Fair	
	19 CHORD	Old Folks at Home	
Piano Accompaniment	20 CHORD	Ac Ballad (Against All Odds: Collins 0007403)	When you need to practice backing (accompaniment) patterns, these are the songs to do it with. This is ability you'll need if you're invited to play with a band. These songs allow you to practice backing parts one hand at a time, which can be the easiest way to master this important skill.
	21 CHORD	Ep Ballad	
	22 CHORD	Boogie Woogie	
	23 CHORD	Rock Piano	
	24 CHORD	Salsa	
	25 CHORD	Country Piano	
	26 CHORD	Gospel R&B	
	27 CHORD	Medium Swing	
	28 CHORD	Jazz Waltz	
	29 CHORD	Medium Bossa	
	30 CHORD	SlowRock	

CHORD : Includes chord data.

The scores for the internal songs—except for songs 1–11, and song 20 which is copyrighted, are provided in the Song Book on the CD-ROM. The scores for songs 9–11 are provided in this manual.

Some of the classic and/or traditional songs have been edited for length or for ease in learning, and may not be exactly the same as the original.

Types of Songs

The following three types of songs can be used by the PSR-E413.

- **Preset Songs (the 30 songs built into the instrument).....Song numbers 001–030.**
- **User Songs (recordings of your own performances)Song numbers 031–035.**
- **External song files (song data transferred from a computer*) ... Song numbers 036–.**

* The Accessory CD-ROM includes a selection of 70 MIDI songs. See page 91 for instructions on how to transfer the songs to the instrument.

The chart below shows the basic PSR-E413 processes flow for using the preset songs, user songs, and external song files—from storage to playback.

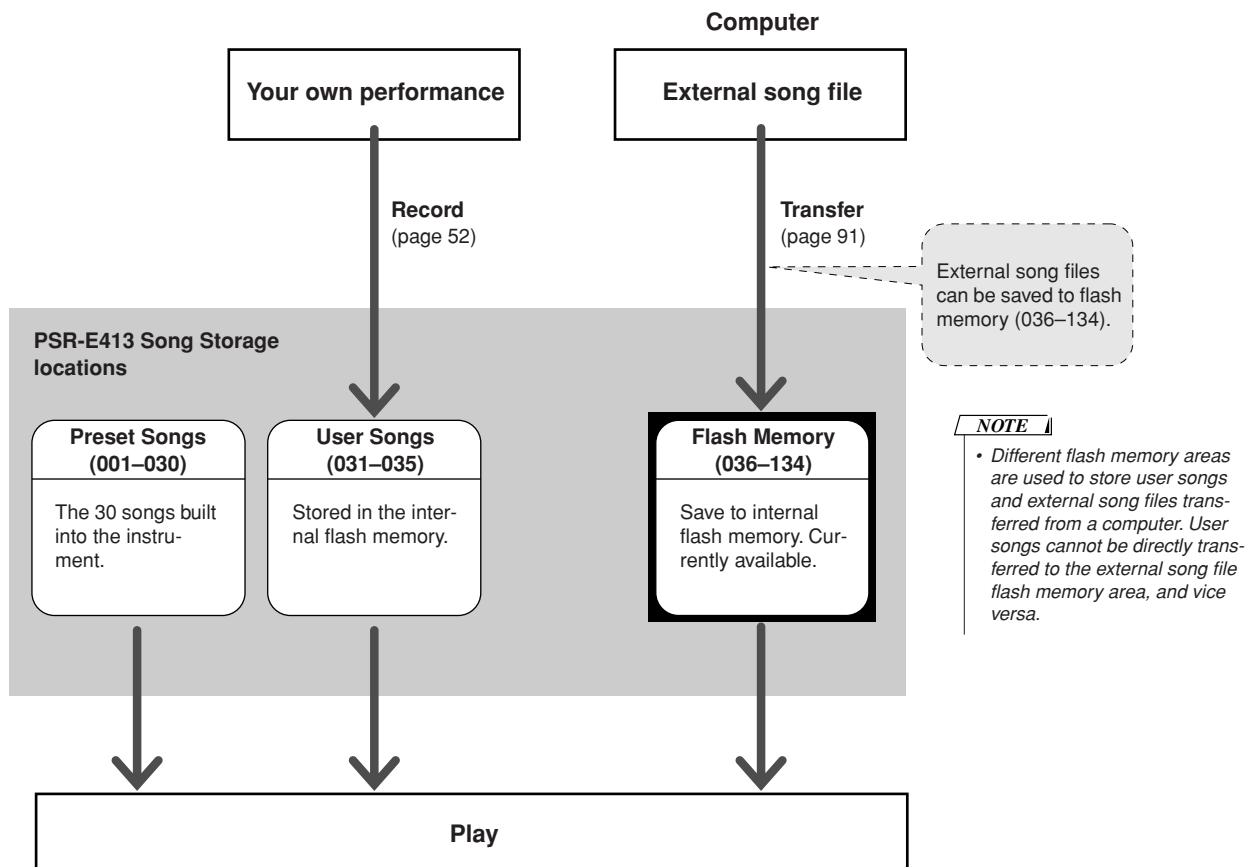



Select a Song For a Lesson

Yamaha Education Suite

You can select song you like and use it for a left-hand, right-hand, or both-hands lesson. You can also use songs (only SMF format 0) downloaded from the Internet and saved to flash memory. (pages 90–92) During the lesson you can play as slowly as you like, and you can even play wrong notes. Song playback will slow down to a speed you can handle. It's never too late to start learning!

Lesson Flow:

Select a song from the Piano Solo, Piano Ensemble category!

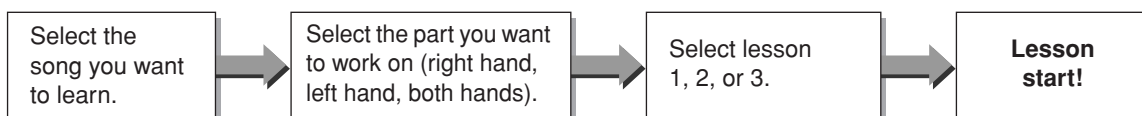

The practice methods:

- **Lesson 1** Learn to play the correct notes.
- **Lesson 2** Learn to play the correct notes with the correct timing.
- **Lesson 3** Learn to play the correct notes at the correct timing along with the song.

Lesson 1—Waiting

In this lesson, try playing the correct notes. Play the note shown in the display. The song will wait until you play the right note.

1 Select a song for your lesson.

Press the [SONG] button, and rotate the dial to select the song you want to use for your lesson. As listed on page 42 there are a variety of song types. For this example try selecting the “012 ForElise”.

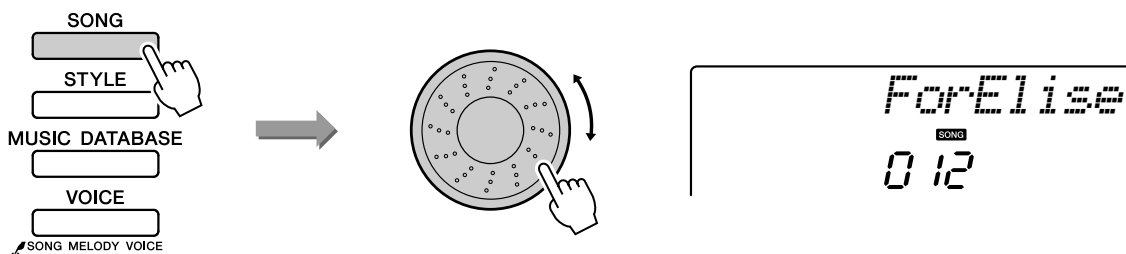

2 Select the part you want to practice.

Press the [R] button for a right-hand lesson, [L] button for a left-hand lesson, or press both the [R] and [L] buttons simultaneously for a both-hands lesson.

The currently selected part is shown in the display.



3 Start Lesson 1.

Press the LESSON [START] button to select Lesson 1. Each time the LESSON [START] button is pressed the lesson modes are selected in sequence: Lesson 1 → Lesson 2 → Lesson 3 → Off → Lesson 1 The currently selected mode is shown in the display.

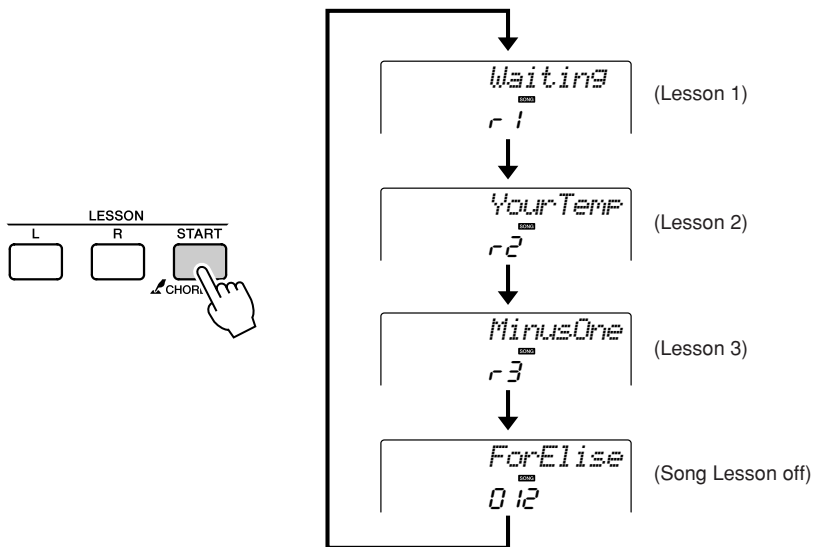

Song playback will begin automatically when you select Lesson 1.



Start the lesson!

Play the note shown in the display. When you play the correct note, the next note you need play is shown. The song will wait until you play the correct note.

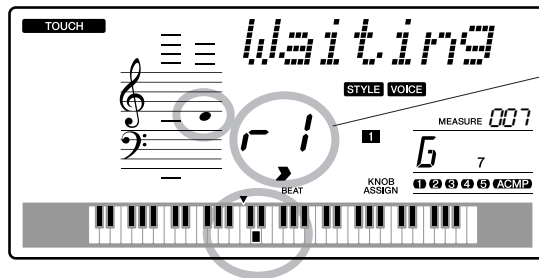

In this case "r 1" indicate that right-hand lesson 1 has been selected.

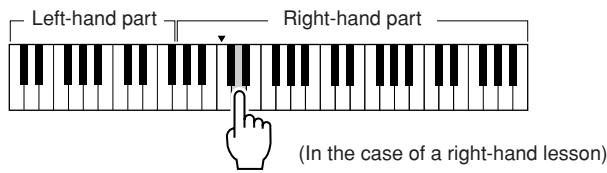

4 Stop the Lesson mode.

You can stop the Lesson mode at any time by pressing the [▶/■] (START/STOP) button.

Once you've mastered Lesson 1, move on to Lesson 2.

■ See How You've Done

- Excellent 
- Very Good 
- Good 
- OK 

When the lesson song has played all the way through your performance will be evaluated in 4 levels: OK, Good, Very Good, or Excellent. "Excellent!" is the highest evaluation.

After the evaluation display has appeared, the lesson will start again from the beginning.

NOTE

- The evaluation feature can be turned off via the FUNCTION Grade item (page 85).

Lesson 2—Your Tempo

Learn to play the correct notes with the correct timing. Song playback tempo will vary to match the speed you are playing at. The song will slow down when you play wrong notes, so you can learn at your own pace.

1 Select the song and part you want to practice (steps 1 and 2 on pages 43, 44).

2 Start Lesson 2.

Each time the LESSON [START] button is pressed the lesson modes are selected in sequence: Lesson 1 → Lesson 2 → Lesson 3 → Off → Lesson 1 ...

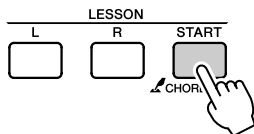

In this case “r 2” indicate that right-hand lesson 2 has been selected.

Song playback will begin automatically when Lesson 2 is selected.



Start the lesson!

Play the note shown in the display. Try to play the notes at the correct timing. As you learn to play the right notes at the right timing the tempo will increase until eventually you’ll be playing at the song’s original tempo.

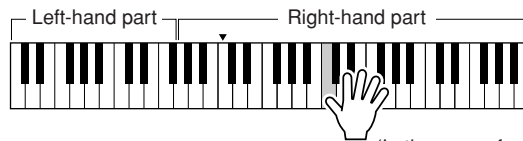

(In the case of a right-hand lesson)

3 Stop the Lesson mode.

You can stop the Lesson mode at any time by pressing the [▶/■] (START/STOP) button.

Once you’ve mastered Lesson 2, move on to Lesson 3.

Lesson 3—Minus One

Here's where you can perfect your technique.

The song will play at the normal tempo, minus the part you have chosen to play. Play along while listening to the song.

1 Select the song and part you want to practice (steps 1 and 2 on pages 43, 44).

2 Start Lesson 3.

Each time the LESSON [START] button is pressed the lesson modes are selected in sequence: Lesson 1 → Lesson 2 → Lesson 3 → Off → Lesson 1 ...

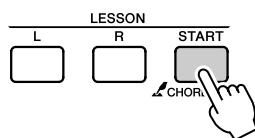

In this case "r-3" indicate that right-hand lesson 3 has been selected.

Song playback will begin automatically when Lesson 3 is selected.



Start the lesson!

Play the note shown in the display.

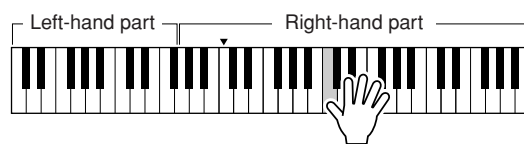

(In the case of a right-hand lesson)

3 Stop the Lesson mode.

You can stop the Lesson mode at any time by pressing the [▶/■] (START/STOP) button.

Practice Makes Perfect—Repeat and Learn

Use this feature when you want to start again just ahead of a section on which you made a mistake, or to repeatedly practice a section you find difficult.

Press the [↺] (REPEAT & LEARN) button during a lesson.

The song location will move back four measures from the point at which you pressed the button, and playback will begin after a one-measure count-in. Playback will continue up to the point at which you pressed the [↺] (REPEAT & LEARN) button, and then jump back four measures and begin again after a count-in. This process will repeat, so all you have to do is press the [↺] (REPEAT & LEARN) button when you make a mistake in order to repeat practice of that section until you get it right.

NOTE

- You can change the number of measures the Repeat and learn function jumps back by pressing a number button [1]–[9] during repeat playback.

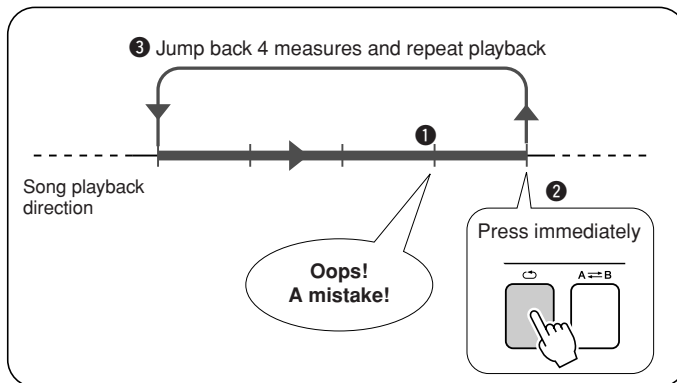
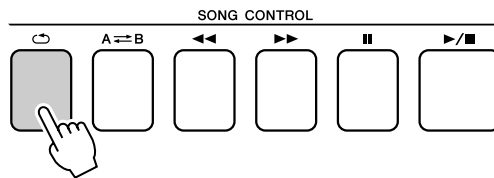



Play Using the Music Database

You want to play music in your favorite style, but you're not sure how to select the best voice and style for the type of music you want to play ... simply select the appropriate style from the Music Database. The panel settings will automatically be adjusted for the ideal combination of sounds and style!

1 Press the [MUSIC DATABASE] button.

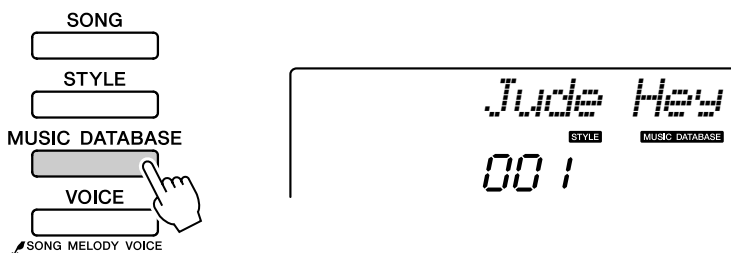

A Music Database name will appear in the display.

2 Select a Music Database.

Referring to the list on the panel or Music Database List on page 114 of the manual, use the dial to select a music database. Select one that matches the image of the song you intend to play. For this example select the "158 Patrol".

NOTE

• Music Database (MDB) files transferred from a computer can be selected and used in the same way as the internal Music Databases (MDB numbers 301-). File transfer instructions are provided on page 90.

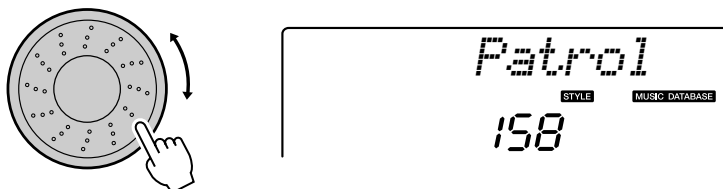

3 Play the chords with your left hand and melody with your right.

The jazz style will start playing when you play a left-hand chord to the left of the split point (page 30). Refer to page 38 for information about playing chords.

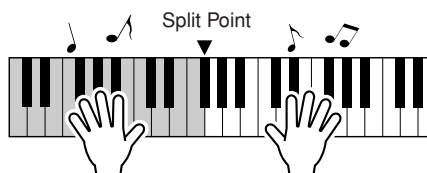

Press the [START/STOP] button to stop playback.



Change a Song's Style

In addition to each song's default style, you can select any other style to play the song with the Easy Song Arranger feature. This means that you can play a song that is normally a ballad, for example, as a bossa nova, as a hip-hop tune, etc. You can create totally different arrangements by changing the style with which a song is played. You can also change the song's melody voice and the keyboard voice for a complete change of image.

Listen to the DEMO Song for Easy Song Arranger

The "Hallelujah Chorus" in the preset songs lets you experience the Easy Song Arranger. Playing it.

Press the [SONG] button, then select a "009 Hallelujah Chorus" by using the dial. Press the [▶/■] (START/STOP) button to play it.

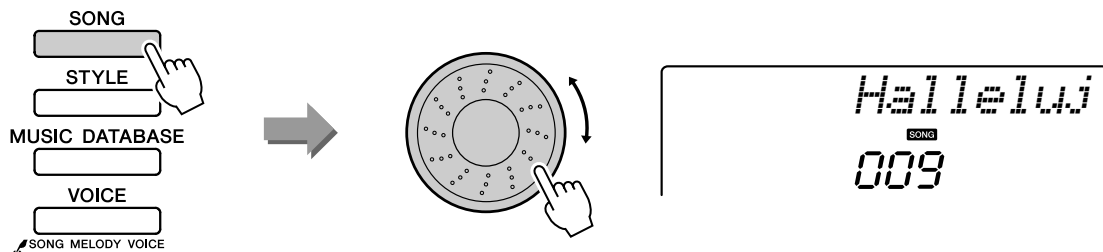

As the song progresses, you will see only the style changes while the song remains the same.

Keep in mind that you can enjoy using Easy Song Arranger with other songs as well—any songs that include chord data.

Using the Easy Song Arranger

1 Press the [EASY SONG ARRANGER] button.

The indicator lights when the Easy Song Arranger function is on.



You can use the [SONG] and [STYLE] buttons to select a song or style, respectively, while the Easy Song Arranger function is on.

2 Select a Song.

Press the [SONG] button, then select the song you want to arrange.

3 Listen to the song.

Press the [▶/■] (START/STOP) button to begin playback of the song. Move on to the next step while the song is playing.

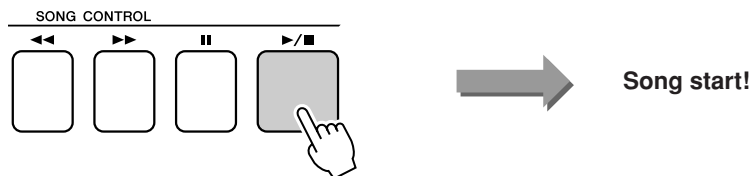

NOTE

• When playing song numbers 010, 011 and 020 to 030 while using the Easy Song Arranger, melody tracks will be automatically muted and no melody will sound. In order to hear the melody tracks you will need to press the SONG MEMORY buttons [3] to [5].

4 Select a style.

Press the [STYLE] button and then rotate the dial to hear how the song sounds with different styles. As you select different styles the song will remain the same while only the styles change. When you have selected a suitable style move on to the next step while the song is still playing.

NOTE

• Because the Easy Song Arranger uses song data you can't specify chords by playing in the accompaniment range of the keyboard. The [ACMP ON/OFF] button will not function.
 • If the time signature of the song and style are different, the time signature of the song will be used.

5 Select a voice you want to play as a song melody.

Press the [VOICE] button. The currently selected voice number and name will be displayed. Use the dial to select a different voice.

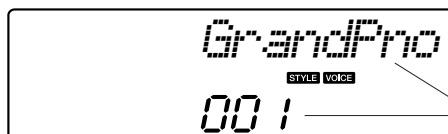
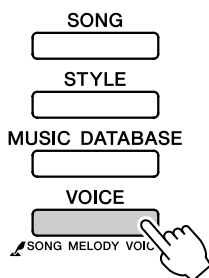

The currently selected voice number and name are displayed here.

6 Change the song's melody voice.

Press and hold the [VOICE] button for longer than a second. After SONG MELODY VOICE appears on the display the voice you selected in step 5 becomes the song's melody voice.

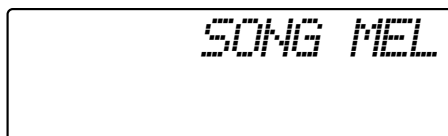
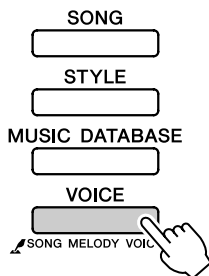

Hold for longer than a second

7 Press the [EASY SONG ARRANGER] button to turn the function off.

The indicator will go out.



Record Your Own Performance

You can record up to 5 of your own performances and save them as user songs 031 through 035. The recorded song can be played back on the instrument.

Recordable Data

You can record to a total of 6 tracks: 5 melody tracks and 1 style (chord) track. Each track can be recorded individually. To record your own performance, first use the SONG MEMORY [1]–[5] and [A] buttons to specify the track(s) you want to record on.

- **Melody Track [1]–[5]..... Record the melody parts.**
- **Style Track [A] Records the chord part.**

NOTE

• Up to approximately 10,000 notes can be recorded for the five user songs if you record only to the melody tracks. Up to approximately 5,500 chord changes can be recorded for the five user songs if you record only to the style track.

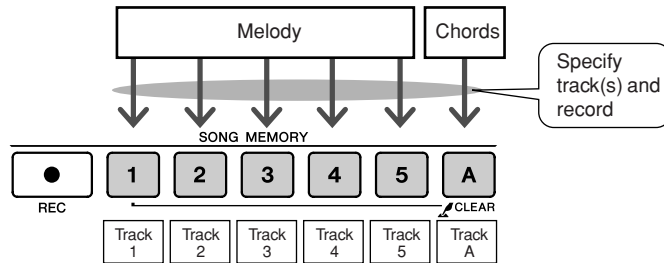

Track Mute

This instrument allows you to choose whether recorded tracks will play back while you are recording or playing back other tracks (page 79).

Recording Procedure

1 Press the [SONG] button, then use the dial to select the user song number (031–035) you want to record to.

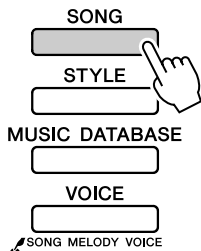

Rotate the dial to select a song number between 031 and 035.

2 Select the track(s) you want to record to and confirm your selection on the display.

◆ Record a Melody Track and the Accompaniment Track Together

Press the melody track button [1]–[5] you want to record to while holding the [REC] button.

Next, press the [A] button while holding the [REC] button.

The selected tracks will flash in the display.

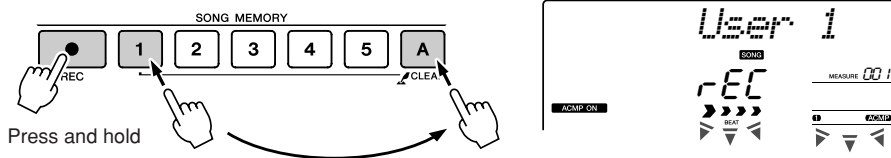

⚠ CAUTION

- If you record to a track that contains previously-recorded data the previous data will be overwritten and lost.

NOTE

- Style accompaniment is automatically turned on when you select the style track [A] for recording.
- Style accompaniment cannot be turned on or off while recording is in progress.
- If you use a split voice for recording, notes played to the left of the split point will not be recorded.

◆ Record a Melody track

Press the melody track button [1]–[5] you want to record to while holding the [REC] button.

The selected track will flash in the display.

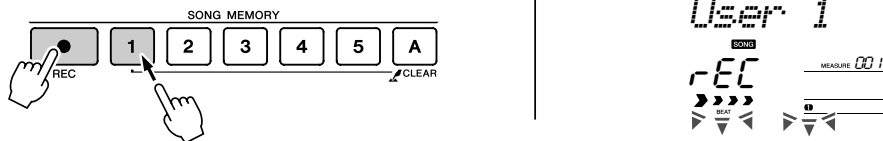

NOTE

- If style accompaniment is on and track [A] has not yet been recorded, the style track [A] will automatically be selected for recording when a melody track is selected. If you only want to record a melody track, be sure to turn the style track [A] off.

To cancel recording to a selected track, press that track button a second time. Style accompaniment cannot be turned on or off while recording is in progress.

3 Recording will start when you play on the keyboard.

You can also start recording by pressing the [▶/■] (START/STOP) button.

The current measure will be shown on the display during recording.

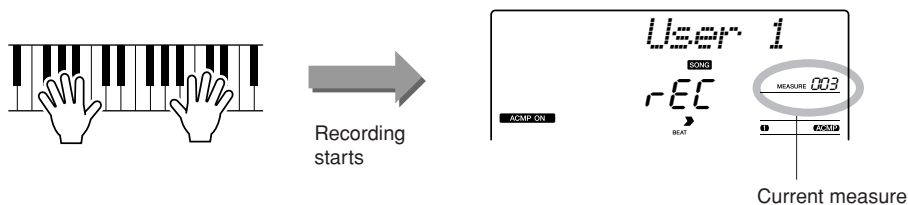

NOTE

- If the memory becomes full during recording a warning message will appear and recording will stop automatically. Use the song clear or track clear (page 55) function to delete unwanted data and make more room available for recording, then do the recording again.

4 Stop recording by pressing the [▶/■] (START/STOP) or [REC] button.

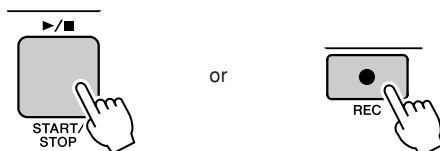

If you press the [INTRO/ENDING/rit.] button while recording the style track an appropriate ending pattern will play and then recording will stop. When recording stops the current measure number will return to 001 and the recorded track numbers in the display will light.

● **To Record Other Tracks**

Repeat steps 2 through 4 to record any of the remaining tracks.

By selecting an unrecorded track—SONG MEMORY buttons [1]–[5], [A]—you can record the new track while listening to previously recorded tracks (the playback tracks will appear in the display). You can also mute previously recorded tracks (the muted tracks will not appear in the display) while recording new tracks.

● **To Re-record a Track**

Simple select the track you want to re-record for recording in the normal way.

The new material will overwrite the previous data.

5 When the recording is done ...

◆ **To Play Back a User Song**

User songs are played back in the same way as regular songs (page 39).

- 1 Press the [SONG] button.
- 2 The current song number/name will be displayed—use the dial to select the user song (031–035) you want to play.
- 3 Press the [▶/■] (START/STOP) button to start playback.

● **Data Recording Limitations**

- The split voice cannot be recorded.
- The following data are recorded at the beginning of the track. Changes made during the song will not be recorded.
 - reverb type, chorus type, time signature, style number, style volume, tempo

Song Clear—Deleting User Songs

This function clears an entire user song (all tracks).

1 Press the [SONG] button, then select the user song (031–035) you want to clear.

2 Press and hold the SONG MEMORY [1] button for longer than a second while holding the SONG MEMORY [A] button.

A confirmation message will appear on the display.

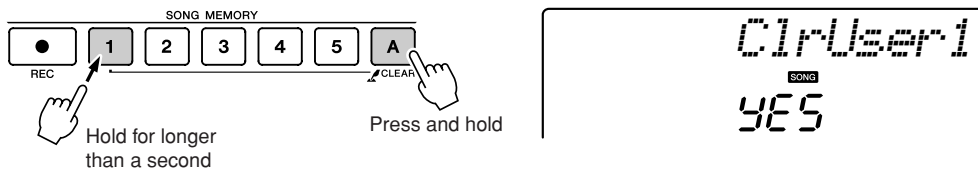

3 Press the [+] button.

A confirmation message will appear on the display.

You can cancel the clear operation by pressing the [-] button.

4 Press the [+] button to clear the song.

The clear-in-progress message will appear briefly on the display while the song is being cleared.

NOTE

• If you only want to clear a specific track from a user song use the Track Clear function.

NOTE

• To execute the Song Clear function press the [+] button. Press [-] to cancel the Song Clear operation.

Track Clear—Deleting a Specified Track from a User Song

This function lets you delete a specified track from a user song.

1 Press the [SONG] button, then select the user song (031–035) you want to clear.

2 Press and hold the SONG MEMORY track button ([1]–[5], [A]) corresponding to the track you want to clear for longer than a second.

A confirmation message will appear on the display.



3 Press the [+] button.

A confirmation message will appear on the display.

You can cancel the clear operation by pressing the [-] button.

4 Press the [+] button to clear the track.

The clear-in-progress message will appear briefly on the display while the track is being cleared.

NOTE

• To execute the Track Clear function press the [+] button. Press [-] to cancel the Track Clear operation.



Backup and Initialization

Backup

The following settings are always backed up, and are maintained even when the power is turned off. If you want to initialize the settings, use the Initialize operation as explained below.

● The Backup Parameters

- User Songs
- Style 166
- Touch Response on/off
- Registration Memory
- FUNCTION Settings: Tuning, Split Point, Touch Sensitivity, Style Volume, Song Volume, Metronome Volume, Grade, Demo Cancel, Master EQ type, Sleep

Initialization

This function erases all backup data in the instrument's flash memory and restores the initial default settings. The following initialization procedures are provided.

■ Backup Clear

To clear data backed up to the internal flash memory—panel user setting, registration memory, user songs, style file 166—turn the power on by pressing the [STANDBY/ON] switch while holding the highest white key on the keyboard. The backed up data will be erased and the default values restored.

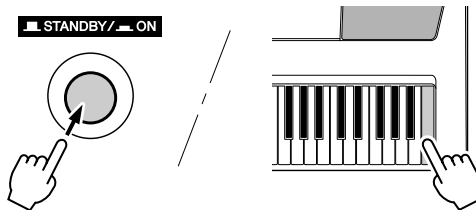

■ Flash Clear

To clear song, style and music database files that have been transferred to the internal flash memory from a computer, turn the power on by pressing the [STANDBY/ON] switch while simultaneously holding the highest white key on the keyboard and the three highest black keys.

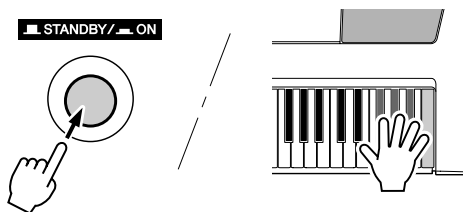

CAUTION

- When you execute the Flash Clear operation, data you have purchased will also be cleared. Be sure to save data you want to keep to a computer.



Basic Operation and Displays

Basic Operation

Overall PSR-E413 control is based on the following simple operations.

1 Press a button to select a basic function.

2 Use the dial to select an item or value.

3 Start a function.

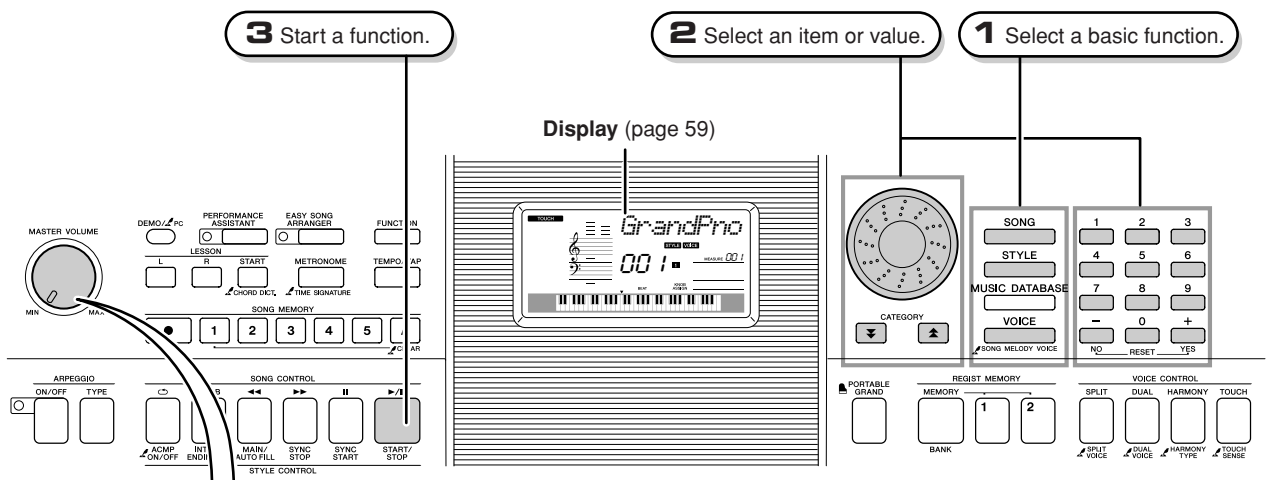

● Volume Adjustment

Adjusts the volume of the sound heard via the instrument's speakers or a pair of headphones plugged into the PHONES jack.

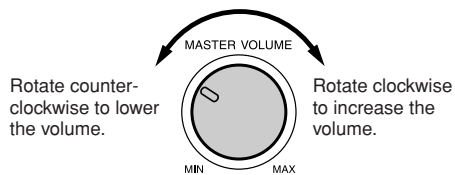



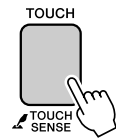

The "Press & Hold" Symbol

The "  " symbol that appears next to some buttons indicates that the button can be pressed and held for longer than a second to call up a related function. This provides convenient direct access to a range of functions.

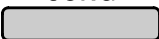

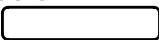
1 Press a button to select a basic function.

- SONG**  — Select a song you want to listen to or a song you want to use for a lesson.
- STYLE**  — Select an auto-accompaniment style.
- MUSIC DATABASE** 
- VOICE**  — Select a voice you want to play on the keyboard.
-  **SONG MELODY VOICE**

2 Use the dial to select an item or value.

When you select a basic function, the item corresponding to that function will be displayed. You can then use the dial or the number buttons [0]–[9] to select the desired item.



This portion of the display indicates the name and number of the currently selected song, voice and style. It also displays the name and current setting/value of other functions.

■ Changing Values.....

● Dial

Rotate the dial clockwise to increase the value of the selected item, or counter-clockwise to decrease its value. Rotate the dial continuously to continuously increase or decrease the value.

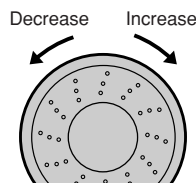

● [+] and [-] Buttons

Press the [+] button briefly to increment the value by 1, or press the [-] button briefly to decrement the value by 1. Press and hold either button to continuously increment or decrement the value in the corresponding direction.

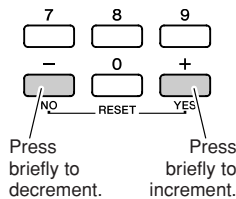

● Number Buttons [0]–[9]

The number buttons can be used to directly enter a song number or parameter value. Hundreds or tens digits that are “0” can be omitted (see below).

Example: Song number “003” can be entered in three ways.

- [0] → [0] → [3]
- [0] → [3]
 (“003” will appear on the display after a brief delay)
- [3]
 (“003” will appear on the display after a brief delay)

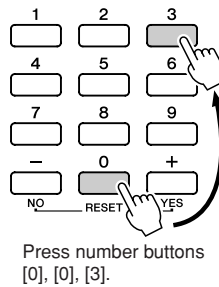

● CATEGORY [▲] and [▼] buttons

When selecting a song, style, or voice, you can use these buttons to jump to the first item in the next or previous category.

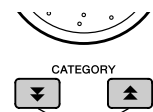

The CATEGORY [▲] and [▼] buttons are useful for selecting categorized items, as in the example below.

Jump to the first item in the next or previous category.

Example: VOICE SELECT

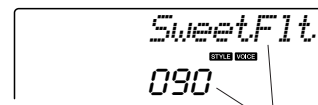

The first voice in the selected category is selected.

In a display in which a category appears, selection is easy if you first use the CATEGORY [▲] and [▼] buttons to select the category containing the desired item, then use the dial or [+] and [-] buttons to select the item. This can be particularly handy when you have to select from a large number of voices.

In most procedures described throughout this owner's manual the dial is recommended for selection simply because it is the easiest and most intuitive selection method. Please note however, that most items or values that can be selected using the dial can also be selected using the [+] and [-] buttons.

3 Start a function.



This is the [START/STOP] button.

Press the [START/STOP] button after pressing the [SONG] or [STYLE] button to start playback of the selected song or style (rhythm).

Display Items

The display shows all of the current basic settings: song, style, voice. It also includes a range of indicators that show the on/off status of a range of functions.

Notation

Displays the melody and chord notes of a song when the Song Lesson function is in use, or the notes of chords you specify when the Dictionary function is in use. At other times the notes you play on the keyboard are displayed.



NOTE

- Any notes occurring below or above the staff are indicated by "8va" in the notation.
- For a few specific chords, not all notes may be shown in the notation section of the display. This is due to space limitations in the display.

BEAT number and MEASURE

Indicates the beat number in a measure during the Metronome function. Indicates the current measure during playback of a song or style, and the currently set Tempo value for the song or style. (see page 27)

MEASURE 001

Chord Display

Indicates the name of the chord currently being played back, or the name of the chord being played on the keyboard.

F

Song Track Display

Information related to the song tracks is shown here. (see page 52, 79)

1 2 3 4 5 ACMP

TOUCH

Indicates that Touch response is turned on. (see page 65)

TOUCH

HARMONY

Indicates that Harmony is turned on. (see page 60)

HARMONY

DUAL

Indicates that the Dual voice is turned on. (see page 29)

DUAL

SPLIT

Indicates that the Split voice is turned on. (see page 30)

SPLIT

ARPEGGIO

Indicates that the Arpeggio is turned on. (see page 14)

ARPEGGIO

Performance assistant technology

Indicates that performance assistant technology is turned on. (see page 23)

P. A. T.

ACMP ON

Indicates that Accompaniment is turned on. (see page 34)

ACMP ON

SYNC STOP

Indicates that SYNC STOP is turned on. (see page 71)

SYNC STOP

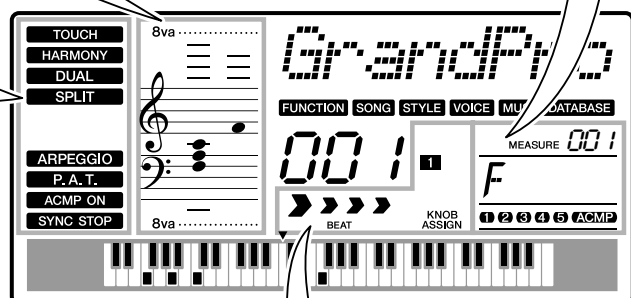

Beat Display

Indicates the current style or song beat with flashing arrows. (see page 27)



Knob Assign Display

This display allows you to visually confirm parameters assigned to the knobs. (see page 18)

1

KNOB ASSIGN

Adding Effects

Harmony

This feature adds harmony notes to the main voice.

1 Press the [HARMONY] button to turn Harmony feature on.

To turn Harmony off, press the [HARMONY] button again.

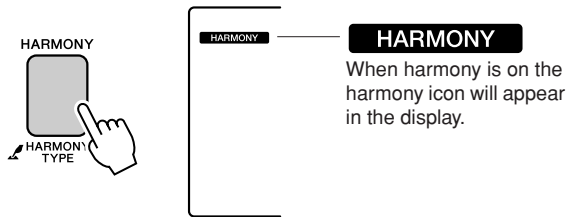

When you press the [HARMONY] button to turn this feature on, the appropriate harmony type for the currently selected main voice is automatically selected.

2 Press and hold the [HARMONY] button for longer than a second so that the Harmony Type item appears.

"HarmType" appears in the display for a few seconds, and the currently selected harmony type will be displayed. Use the dial to select a different harmony type.

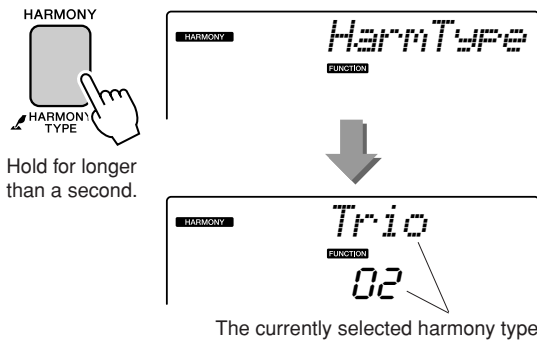

3 Use the dial to select a harmony type.

Refer to the Effect Type List on page 117 for information about the available harmony types. Try playing the keyboard with the harmony function. The effect and operation of each Harmony Type is different—refer to the below section "How to sound each Harmony Type" as well as the Effect Type List for details.

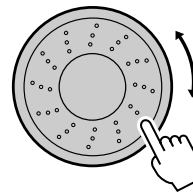

NOTE

- The harmony notes can be added only to the Main Voice, not to Dual or Split Voices.
- The keys left of the Split Point of the keyboard produce no harmony notes when the auto accompaniment is on (ACMP ON is lit).

● How to sound each Harmony Type

- Harmony type 01 to 05



Press the right-hand keys while playing chords in the auto accompaniment range of the keyboard when the Auto Accompaniment is on (page 34).

- Harmony type 06 to 12 (Trill)

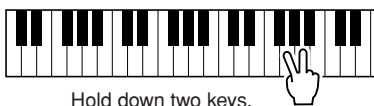

Hold down two keys.

- Harmony type 13 to 19 (Tremolo)



Keep holding down the keys.

- Harmony type 20 to 26 (Echo)

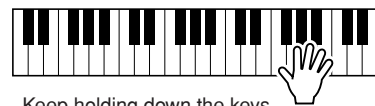

Keep holding down the keys.

You can adjust the Harmony Volume in the Function Settings (page 69).

Adding Reverb

Reverb lets you play with a rich concert hall type ambience. When you select a style or song the optimum reverb type for the voice used is automatically selected. If you want to select a different reverb type, use the procedure described below.

1 Press the [FUNCTION] button.

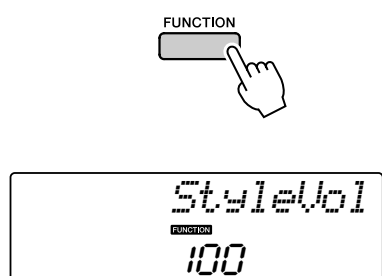

2 Use the CATEGORY [▲] and [▼] buttons to select the Reverb Type item.

“Reverb” appears in the display for a few seconds, and the currently selected reverb type will be displayed.

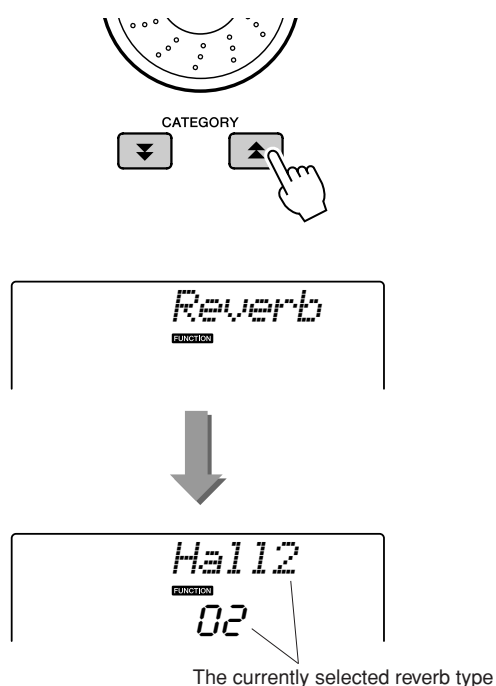

3 Use the dial to select a reverb type.

You can check how the selected reverb type sounds by playing on the keyboard.

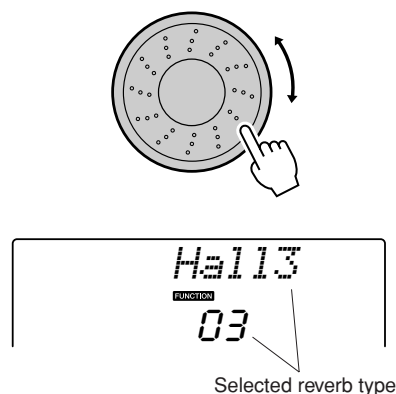

Refer to the Effect Type List on page 117 for information about the available reverb types.

● Adjusting the Reverb Send Level

You can individually adjust the amount of reverb that is applied to the main, dual, and split voices. (See page 84).

Adding Chorus

The chorus effect creates a thick sound that is similar to many of the same voices being played in unison. When you select a style or song the optimum chorus type for the voice used is automatically selected. If you want to select a different chorus type, use the procedure described below.

1 Press the [FUNCTION] button.

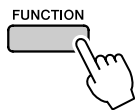

2 Use the CATEGORY [▲] and [▼] buttons to select the Chorus Type item.

“Chorus” appears in the display for a few seconds, and the currently selected chorus type will be displayed.

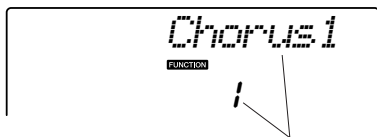
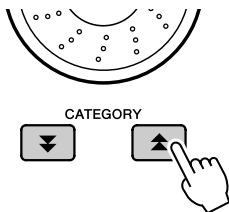

The currently selected chorus type

3 Use the dial to select a chorus type.

You can check how the selected chorus type sounds by playing on the keyboard.

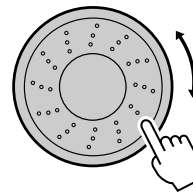

Selected chorus type

Refer to the Effect Type List on page 117 for information about the available chorus types.

● Adjusting the Chorus Send Level

You can individually adjust the amount of chorus that is applied to the main, dual, and split voices. (See page 84).

Handy Performance Features

The Metronome

The instrument includes a metronome with adjustable tempo and time signature. Use it to set the tempo that is most comfortable for you.

■ Start the metronome

Turn the metronome on and start it by pressing the [METRONOME] button.

To stop the metronome, press the [METRONOME] button again.

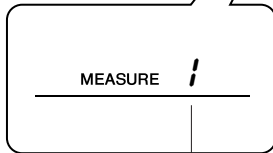
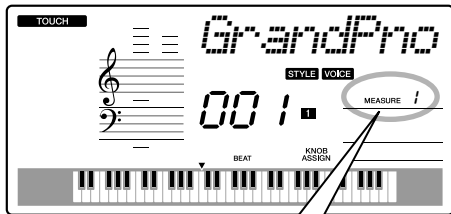
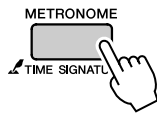

Indicates the beat number in the measure

■ Adjusting the Metronome Tempo

1 Press the [TEMPO/TAP] button to call up the tempo setting.

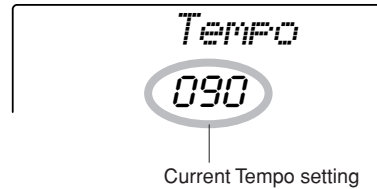
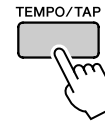

2 Use the dial to select a tempo from 11 to 280.

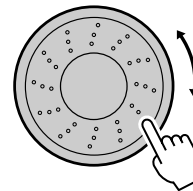

Setting the Number of Beats per Measure, and the Length of Each Beat

In this example we'll set up a 5/8 time signature.

- 1 Press and hold the [METRONOME] button for longer than a second to select the number of beats per measure function "TimesigN".

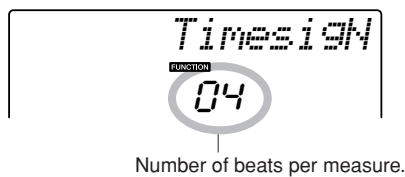
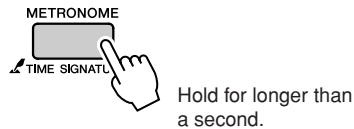

- 2 Use the dial to select the number of beats per measure.

A chime will sound on the first beat of each measure while the other beats will click. All beats will simply click with no chime at the beginning of each measure if you set this parameter to "00".

The available range is from 0 through 60. Select 5 for this example.

NOTE

The metronome time signature will synchronize to a style or song that is playing, so these parameters cannot be changed while a style or song is playing.

- 3 Press the CATEGORY [▲] and [▼] buttons as many times as necessary to select the beat length function "TimesigD".

The currently selected beat length will be displayed.

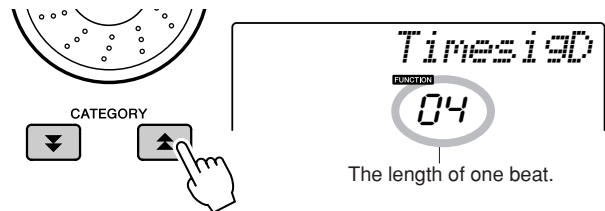

- 4 Use the dial to select the beat length.

Select the required length for each beat: 2, 4, 8, or 16 (half note, quarter note, eighth note, or 16th note). Select 8 for this example.

Adjusting the Metronome Volume

- 1 Press the [FUNCTION] button.

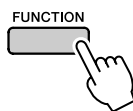

- 2 Use the CATEGORY [▲] and [▼] buttons to select the Metronome Volume item.

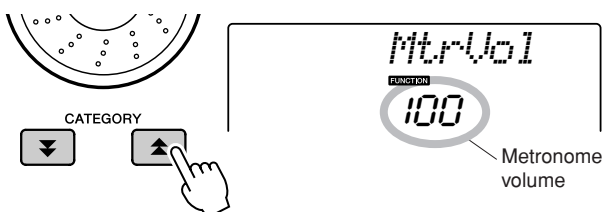

- 3 Use the dial to set the metronome volume as required.

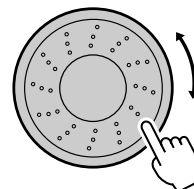

Tap Start

You can supply a count-in at any tempo you like to start playback. Simply tap the [TEMPO/TAP] button at any tempo—4 times for time signatures in 4, and 3 times for time signatures in 3—and the selected style/song will begin playing at the tapped tempo.



Touch Response Sensitivity

When touch response is on you can adjust the keyboard's sensitivity to dynamics in three steps.

1 Press the [TOUCH] button to turn touch response on.

The touch response icon will appear in the display when touch response is on (page 59).

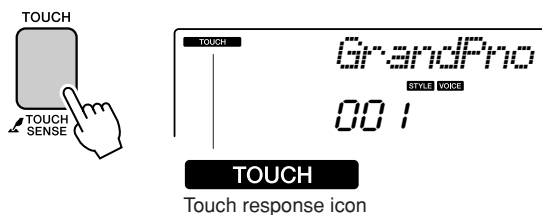

2 Press and hold the [TOUCH] button for longer than a second so that the Touch Sensitivity item appears.

"TouchSns" appears in the display for a few seconds, and the currently selected touch sensitivity will be displayed.

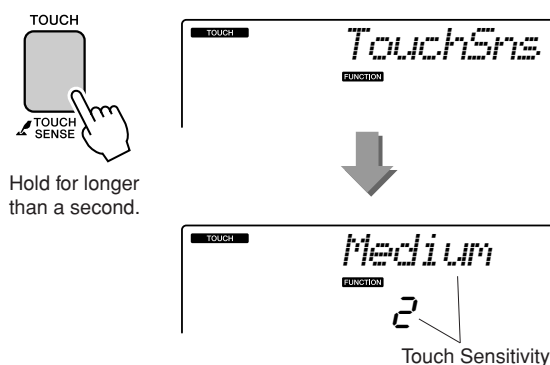

3 Use the dial in response to keyboard dynamics to select a touch sensitivity setting between 1 and 3. Higher values produce greater (easier) volume variation in response to keyboard dynamics—i.e. greater sensitivity.

NOTE

- The initial default touch sensitivity setting is "2".

Pitch Bend

The pitch bend wheel can be used to add smooth pitch variations to notes you play on the keyboard. Roll the wheel upward to raise the pitch, or downward to lower the pitch. If you use this feature with a voice such as the “040 Overdriven” guitar voice, you can produce remarkably realistic string-bending effects.

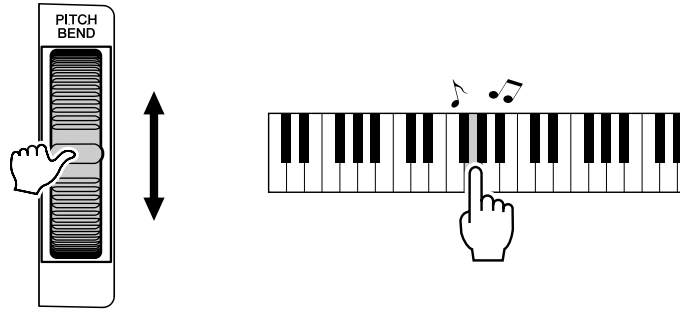

Pitch Controls

◆ Large Pitch Changes (Transpose)

The overall pitch of the instrument can be shifted up or down by a maximum of 1 octave in semitone increments.

1 Press the [FUNCTION] button.

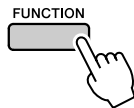

2 Use the CATEGORY [▲] and [▼] buttons to select the Transpose item.

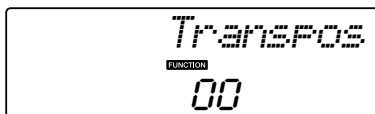

3 Use the dial to set the transpose value between -12 and +12 as required.

NOTE

• The pitch of Drum Kits voices cannot be changed.

◆ Small Pitch Changes (Tuning)

The overall tuning of the instrument can be shifted up or down by a maximum of 100 cents in 1-cent increments (100 cents = 1 semitone).

1 Press the [FUNCTION] button.

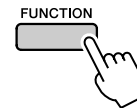

2 Use the CATEGORY [▲] and [▼] buttons to select the Tuning item.



3 Use the dial to set the tuning value between -100 and +100 as required.

NOTE

• The pitch of Drum Kits voices cannot be changed.

Controlling Arpeggio Volume with Keyboard Dynamics

1 Press the [FUNCTION] button.

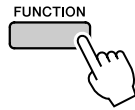

2 Press the CATEGORY [\blacktriangle] and [\blacktriangledown] buttons as many times as necessary to select the arpeggio velocity function "ARP Velo".

"ARP Velo" will be shown in the display for a few seconds, then the currently selected arpeggio velocity setting will appear.

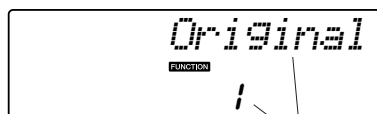
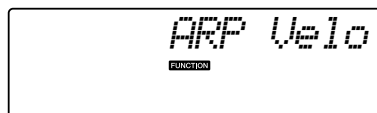
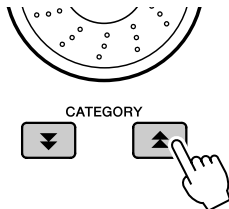

The currently selected arpeggio velocity.

3 Use the dial to select "2 Thru".

When "1 Original" is selected the arpeggio volume is the same regardless of changes in keyboard velocity.

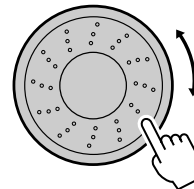

One Touch Setting

Sometimes selecting the ideal voice to play with a song or style can be confusing. The One Touch Setting feature automatically selects a well-balanced voice for you when you select a style or song. Simply select voice number “000” to activate this feature.

- 1** Select voice number “000” (steps 1 to 2 on page 28).

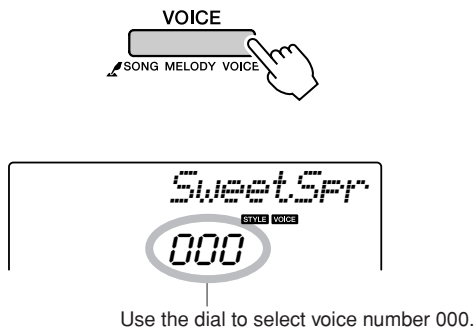

- 2** Select and play back any song (steps 1 to 3 on page 39).

- 3** Play the keyboard and remember the sound of the voice.

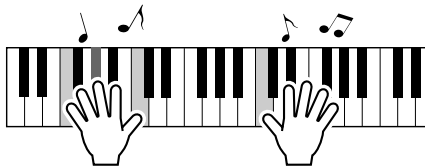

If you have stopped playback at some point during this procedure press the [▶/■] (START/STOP) button to start playback again.

- 4** Use the dial to change songs, then play the keyboard and listen to the voice.

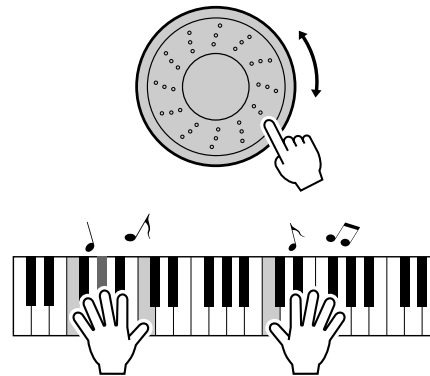

You should hear a different keyboard voice than you played in step 3. Press the [VOICE] button after changing songs to see the name of the voice being used.

Adjusting the Harmony Volume

1 Press the [FUNCTION] button.

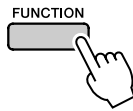

2 Use the CATEGORY [▲] and [▼] buttons to select the Harmony Volume item.

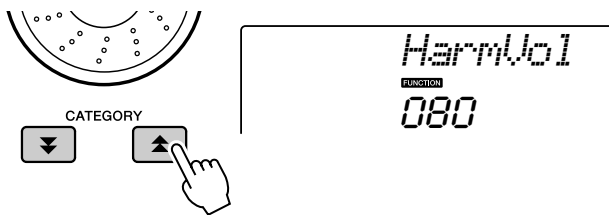

3 Use the dial to set the harmony volume between 000 and 127.

Select an EQ Setting for the Best Sound

Five different master equalizer (EQ) settings are provided to give you the best possible sound when listening through different reproduction systems—the instrument's internal speakers, headphones, or an external speaker system.

1 Press the [FUNCTION] button.

The currently selected function will appear in the display.

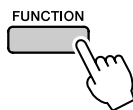

2 Press the CATEGORY [▲] and [▼] buttons as many times as necessary to select the master EQ type function "MasterEQ".

"MasterEQ" will be shown in the display for a few seconds, then the currently selected EQ type will appear.

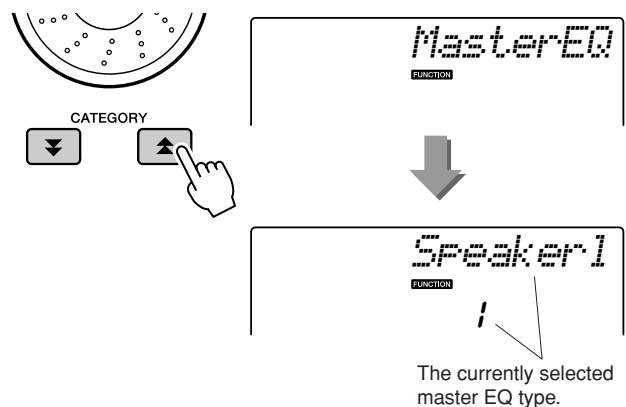

3 Use the dial to select the desired Master EQ setting.

Five settings are available: 1–5. Settings 1 and 2 are best for listening via the instrument's built-in speakers, setting 3 is for headphones, and settings 4 and 5 are ideal for listening via external speakers.

Style (Auto-accompaniment) Functions

Basic operation of the Style (auto-accompaniment) feature is described on page 33 of the Quick Guide.

Here are some other ways you can play the styles, the style volume adjustment procedure, how you can play chords using the styles, and more.

Pattern Variation (Sections)

The PSR-E413 features a wide variety of style “sections” that allow you to vary the arrangement of the accompaniment to match the song you are playing.

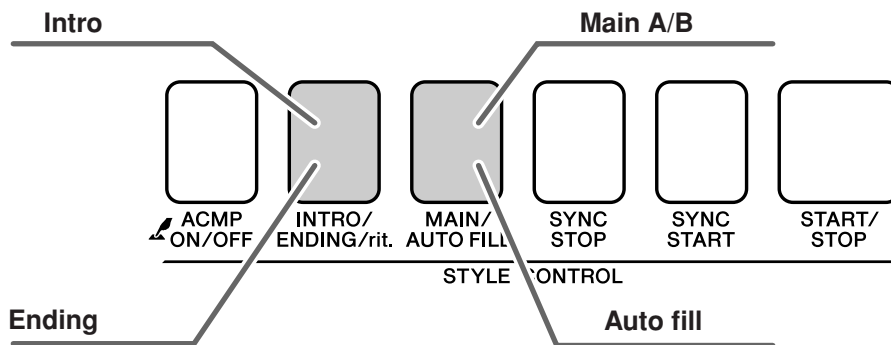

● INTRO section

This is used for the beginning of the Song. When the intro finishes playing, accompaniment shifts to the main section. The length of the intro (in measures) differs depending on the selected Style.

● MAIN section

This is used for playing the main part of the Song. It plays a main accompaniment pattern, and repeats indefinitely until another section’s button is pressed. There are two variations on the basic pattern (A and B), and the Style playback sound changes harmonically based on the chords you play with your left hand.

● Fill-in section

This is automatically added before changing to section A or B.

● ENDING section

This is used for the ending of the Song. When the ending is finished, the auto accompaniment stops automatically. The length of the ending (in measures) differs depending on the selected Style.

1 Press the [STYLE] button and then select a style.

2 Press the [ACMP ON/OFF] button to turn auto accompaniment on.

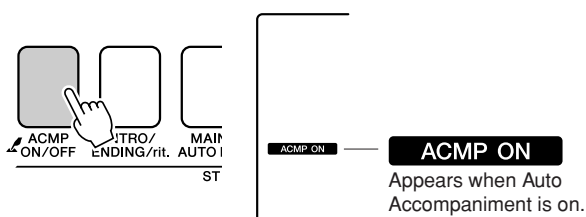

3 Press the [SYNC START] button to turn synchro start on.

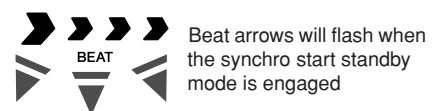
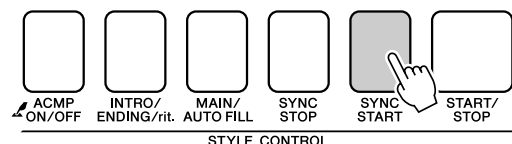

● Synchro Start

When the synchro start standby mode is engaged, style playback will begin as soon as you play a chord in the accompaniment range of the keyboard. You can disengage the synchro-start standby mode by pressing the [SYNC START] button again.

4 Press the [MAIN/AUTO FILL] button.

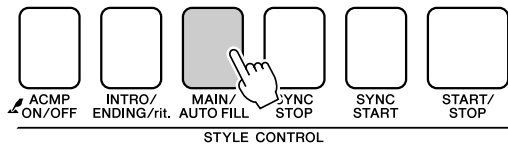

The name of the selected section—MAIN A or MAIN B—will be displayed.

5 Press the [INTRO/ENDING/rit.] button.

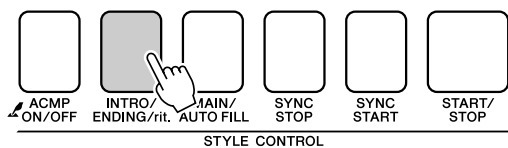

You're now ready to play the intro.

6 As soon as you play a chord with your left hand, the Intro of the selected Style starts.

For this example, play a C major chord (as shown below). For information on how to enter chords, see “Playing Auto-accompaniment Chords” on page 38.

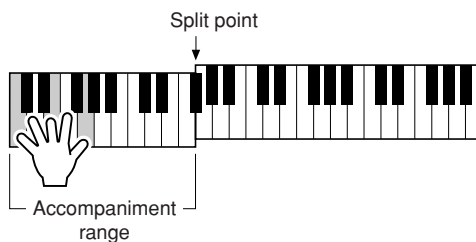

7 Press the [MAIN/AUTO FILL] button.

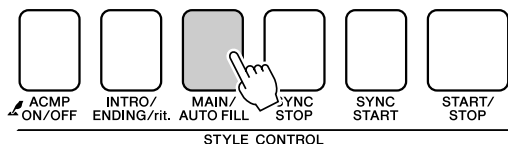

When the fill-in is finished, it leads smoothly into the selected main section A/B.

8 Press the [INTRO/ENDING/rit.] button.

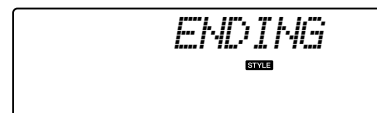
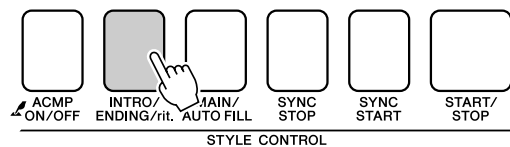

This switches to the ending section. When the ending is finished, the auto accompaniment stops automatically. You can have the ending gradually slow down (ritardando) by pressing the [INTRO/ENDING/rit.] button again while the ending is playing back.

● **Synchro Stop**

When this function is selected the accompaniment style will only play while you are playing chords in the accompaniment range of the keyboard. Style playback will stop when you release the keys. To turn the function on, press the [SYNC STOP] button.

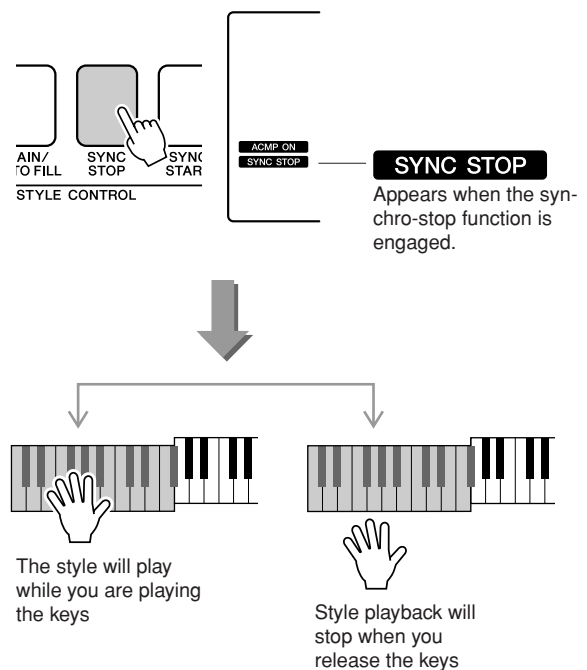

Adjusting the Style Volume

Press the [STYLE] button to engage the style function.

1 Press the [FUNCTION] button.

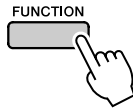

2 Use the CATEGORY [▲] and [▼] buttons to select the Style Volume item.

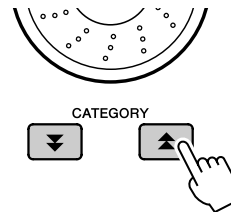

3 Use the dial to set the style volume between 000 and 127.

Setting the Split Point

The initial default split point is key number 54 (the F#2 key), but you can change it to another key using the procedure described below.

1 Press the [STYLE] button.

2 Press and hold the [ACMP ON/OFF] for longer than a second so that the Split point item appears.

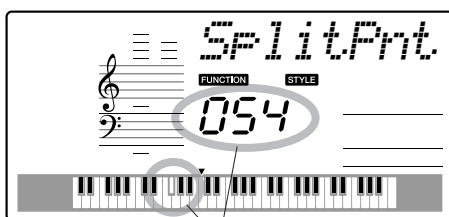
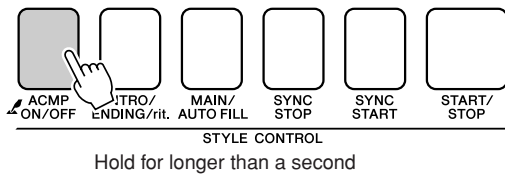

Split point

3 Use the dial to set the split point to any key from 000 through 127.

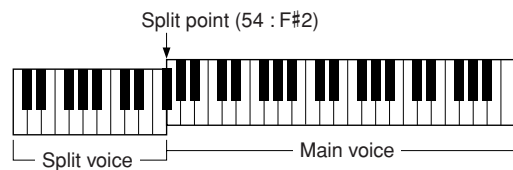

NOTE

- When you change the split point the auto-accompaniment split point also changes.
- The split point cannot be changed during a song lesson.

NOTE

- You can also access the Split Point item by pressing the [FUNCTION] button and using the CATEGORY [▲] and [▼] buttons to locate the item (page 83).

Play a Style with Chords but No Rhythm (Stop Accompaniment)

When auto accompaniment is on (the ACMP ON icon is showing) and Synchro Start is off, you can play chords in the left-hand accompaniment range of the keyboard while the style is stopped and still hear the accompaniment chords. This is “Stop Accompaniment”, and any of the chord fingerings recognized by the instrument can be used (page 38).

Press the [STYLE] button to engage the style function, then press the [ACMP ON/OFF] button to turn the auto accompaniment on.

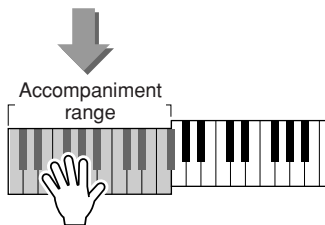
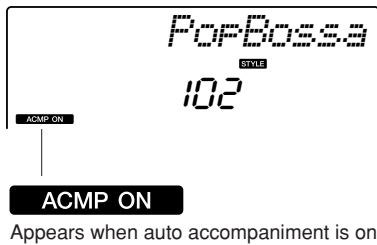
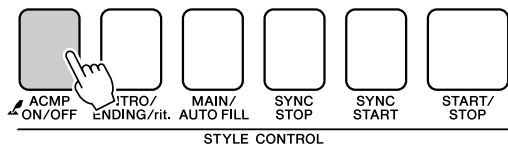

Loading Style Files

This instrument features 165 internal styles, but other styles, such as those provided on the CD-ROM and others that can be obtained from the internet (only styles with the “.sty” suffix), can be loaded into style number 166 and used in the same way as the internal styles.

In order to use the style file load function, the file must already have been transferred from the computer to the instrument. The procedure for transferring files from a computer to the instrument is described on page 90 (“Transferring Data between the Computer and Instrument”).

The procedure described below loads a style file that has already been transferred from a computer to the instrument into style number 166.

1 Press the [FUNCTION] button.

The currently selected function will appear in the display.

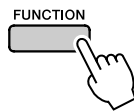

2 Press the CATEGORY [▲] and [▼] buttons as many times as necessary to select the style file load function “Sff Load”.

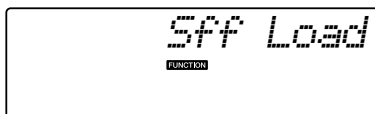
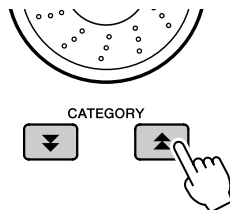

After about 2 seconds the name of a loadable style file will appear in the display.

If multiple loadable style files have been transferred to the instrument, you can use the dial or the [+] and [-] buttons to select the other files in sequence.

3 Execute the load operation.

With the name of the style file you want to load shown in the display, press the number [0] button.

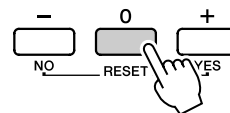

4 A confirmation message for the load operation will appear. Press the [+ / YES] button to actually load the file.

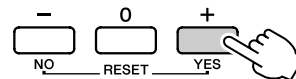

Chord Basics

Two or more notes played together constitute a “chord”.

The most basic chord type is the “triad” consisting of three notes: the root, third, and fifth degrees of the corresponding scale. A C major triad, for example, is made up of the notes C (the root), E (the third note of the C major scale), and G (the fifth note of the C major scale).

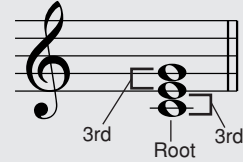

In the C major triad shown above, the lowest note is the “root” of the chord (this is the chord’s “root position” ... using other chord notes for the lowest note results in “inversions”). The root is the central sound of the chord, which supports and anchors the other chord notes.

The distance (interval) between adjacent notes of a triad in root position is either a major or minor third.

Major third—four half steps (semitones)

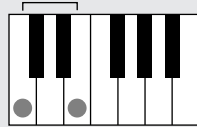

Minor third—three half steps (semitones)

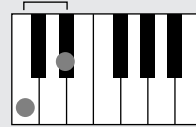

The lowest interval in our root-position triad (between the root and the third) determines whether the triad is a major or minor chord, and we can shift the highest note up or down by a semitone to produce two additional chords, as shown below.

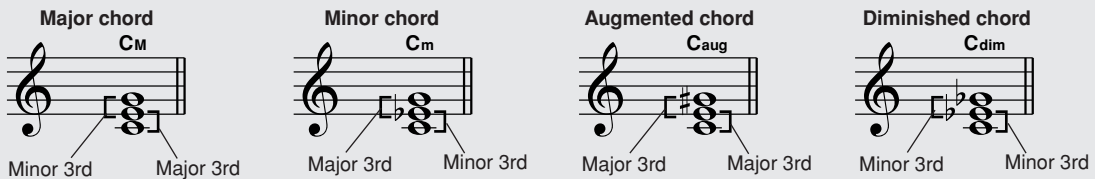

The basic characteristics of the chord sound remain intact even if we change the order of the notes to create different inversions. Successive chords in a chord progression can be smoothly connected, for example, by choosing the appropriate inversions (or chord “voicings”).

● Reading Chord Names

Chord names tell you just about everything you need to know about a chord (other than the inversion/voicing). The chord name tells you what the root of the chord is, whether it is a major, minor, or diminished chord, whether it requires a major or flatted seventh, what alterations or tensions it uses ... all at a glance.

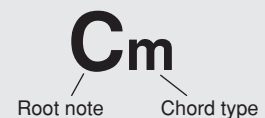

● Some Chord Types (These are just some of the “Standard” chord types recognized by the PSR-E413.)

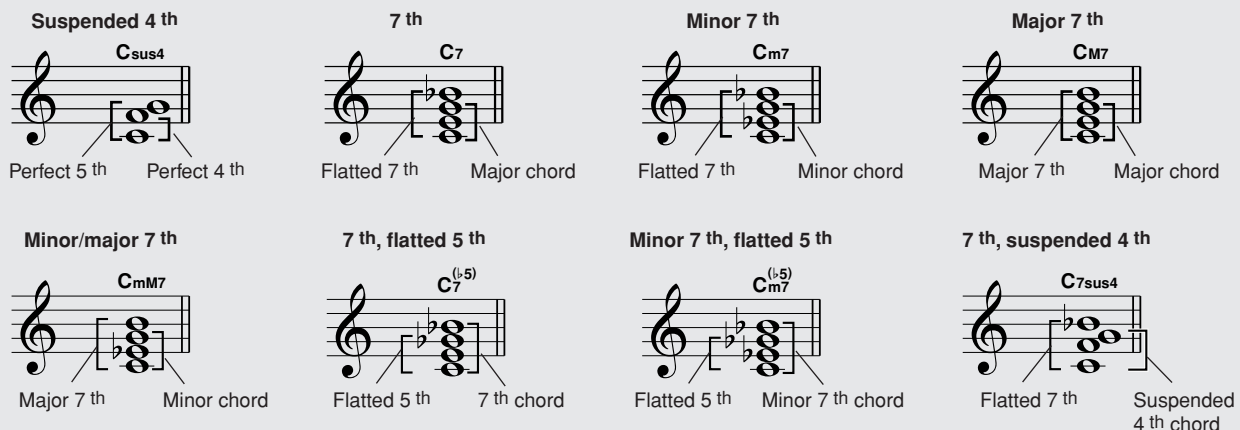

■ Recognized Standard Chords.....

All chords in the chart are “C-root” chords.

Chord Name/[Abbreviation]	Normal Voicing	Chord (C)	Display
Major [M]	1 - 3 - 5	C	C
Add ninth [(9)]	1 - 2 - 3 - 5	C ⁽⁹⁾	C(9)
Sixth [6]	1 - (3) - 5 - 6	C ₆	C6
Sixth ninth [6(9)]	1 - 2 - 3 - (5) - 6	C ₆ ⁽⁹⁾	C6(9) *
Major seventh [M7]	1 - 3 - (5) - 7 or 1 - (3) - 5 - 7	C _{M7}	CM7
Major seventh ninth [M7(9)]	1 - 2 - 3 - (5) - 7	C _{M7} ⁽⁹⁾	CM7(9) *
Major seventh add sharp eleventh [M7(#11)]	1 - (2) - 3 - #4 - 5 - 7 or 1 - 2 - 3 - #4 - (5) - 7	C _{M7} ^(#11)	CM7(#11) *
Flatted fifth [(b5)]	1 - 3 - b5	C ^(b5)	C ^{b5} *
Major seventh flatted fifth [M7b5]	1 - 3 - b5 - 7	C _{M7} ^(b5)	CM7 ^{b5} *
Suspended fourth [sus4]	1 - 4 - 5	C _{sus4}	Csus4
Augmented [aug]	1 - 3 - #5	C _{aug}	Caug
Major seventh augmented [M7aug]	1 - (3) - #5 - 7	C _{M7aug}	CM7aug *
Minor [m]	1 - b3 - 5	C _m	Cm
Minor add ninth [m(9)]	1 - 2 - b3 - 5	C _m ⁽⁹⁾	Cm(9)
Minor sixth [m6]	1 - b3 - 5 - 6	C _{m6}	Cm6
Minor seventh [m7]	1 - b3 - (5) - b7	C _{m7}	Cm7
Minor seventh ninth [m7(9)]	1 - 2 - b3 - (5) - b7	C _{m7} ⁽⁹⁾	Cm7(9)
Minor seventh add eleventh [m7(11)]	1 - (2) - b3 - 4 - 5 - (b7)	C _{m7} ⁽¹¹⁾	Cm7(11) *
Minor major seventh [mM7]	1 - b3 - (5) - 7	C _{mM7}	CmM7
Minor major seventh ninth [mM7(9)]	1 - 2 - b3 - (5) - 7	C _{mM7} ⁽⁹⁾	CmM7(9) *
Minor seventh flatted fifth [m7b5]	1 - b3 - b5 - b7	C _{m7} ^(b5)	Cm7 ^{b5}
Minor major seventh flatted fifth [mM7b5]	1 - b3 - b5 - 7	C _{mM7} ^(b5)	CmM7 ^{b5} *
Diminished [dim]	1 - b3 - b5	C _{dim}	Cdim
Diminished seventh [dim7]	1 - b3 - b5 - 6	C _{dim7}	Cdim7
Seventh [7]	1 - 3 - (5) - b7 or 1 - (3) - 5 - b7	C ₇	C7
Seventh flatted ninth [7(b9)]	1 - b2 - 3 - (5) - b7	C ₇ ^(b9)	C7(b9)
Seventh add flatted thirteenth [7(b13)]	1 - 3 - 5 - b6 - b7	C ₇ ^(b13)	C7(b13)
Seventh ninth [7(9)]	1 - 2 - 3 - (5) - b7	C ₇ ⁽⁹⁾	C7(9)
Seventh add sharp eleventh [7(#11)]	1 - (2) - 3 - #4 - 5 - b7 or 1 - 2 - 3 - #4 - (5) - b7	C ₇ ^(#11)	C7(#11)
Seventh add thirteenth [7(13)]	1 - 3 - (5) - 6 - b7	C ₇ ⁽¹³⁾	C7(13)
Seventh sharp ninth [7(#9)]	1 - #2 - 3 - (5) - b7	C ₇ ^(#9)	C7(#9)
Seventh flatted fifth [7b5]	1 - 3 - b5 - b7	C _{7b5}	C7 ^{b5} *
Seventh augmented [7aug]	1 - 3 - #5 - b7	C _{7aug}	C7aug
Seventh suspended fourth [7sus4]	1 - 4 - (5) - b7	C _{7sus4}	C7sus4
Suspended second [sus2]	1 - 2 - 5	C _{sus2}	C *

* These chords are not shown in the Dictionary function.

NOTE

- Notes in parentheses can be omitted.
- Playing two same root keys in the adjacent octaves produces accompaniment based only on the root.
- A perfect fifth (1+5) produces accompaniment based only on the root and fifth which can be used with both major and minor chords.
- The chord fingerings listed are all in “root” position, but other inversions can be used—with the following exceptions: m7, m7^{b5}, 6, m6, sus4, aug, dim7, 7^{b5}, 6(9), sus2.

NOTE

- Inversion of the 7sus4 and m7(11) chords are not recognized if the notes shown in parentheses are omitted.
- The auto accompaniment will sometimes not change when related chords are played in sequence (e.g. some minor chords followed by the minor seventh).
- Two-note fingerings will produce a chord based on the previously played chord.

Looking Up Chords Using the Chord Dictionary

The Dictionary function is essentially a built-in “chord book” that shows you the individual notes of chords. It is ideal when you know the name of a certain chord and want to quickly learn how to play it.

- 1 Press and hold the LESSON [START] button for longer than a second.

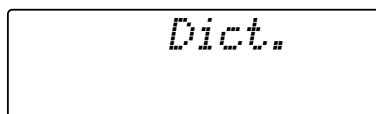
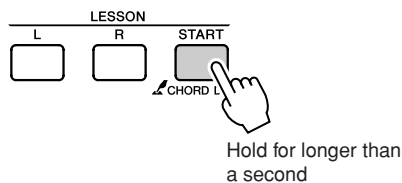

- 2 As an example, we'll learn how to play a GM7 (G major seventh) chord. Press the “G” key in the section of the keyboard labeled “ROOT”. (The note doesn't sound.) The root note you set is shown in the display.

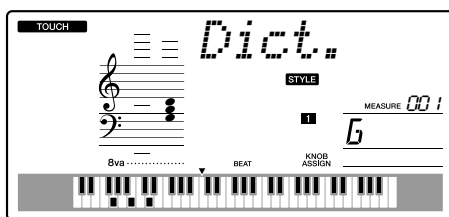
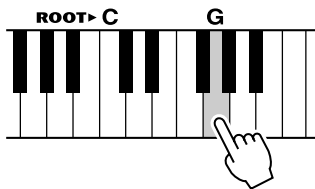

- 3 Press the “M7” (major seventh) key in the section of the keyboard labeled “CHORD TYPE”. (The note doesn't sound.) The notes you should play for the specified chord (root note and chord type) are shown in the display, both as notation and in the keyboard diagram.

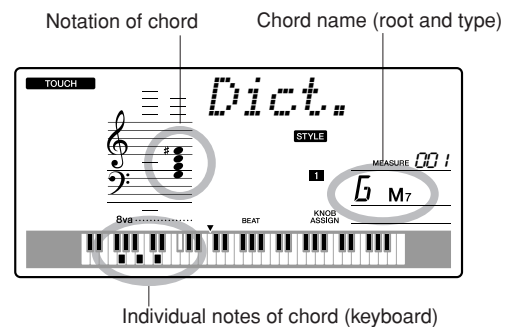
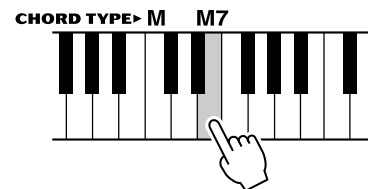

To call up possible inversions of the chord, press the [+]/[-] buttons.

NOTE

- About major chords: Simple major chords are usually indicated only by the root note. For example, “C” refers to C major. However, when specifying major chords here, make sure to select “M” (major) after pressing the root note.

- 4 Try playing a chord in the auto accompaniment section of the keyboard, checking the indications in the display. When you've played the chord properly, a bell sound signals your success and the chord name in the display flash.

Song Settings

Song Volume

1 Press the [FUNCTION] button.

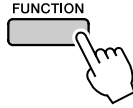

2 Use the CATEGORY [▲] and [▼] buttons to select the Song Volume item.

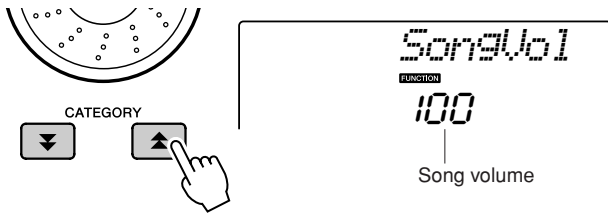

3 Use the dial to set the song volume between 000 and 127.

NOTE

• Song volume can be adjusted while a song is selected.

A-B Repeat

You can specify a section of a song—"A" is the start point and "B" is the end point—for repeat playback.



1 Play the song (page 39) and press the [A⇌B] (A-B REPEAT) button at the beginning of the section you want to repeat (the "A" point).

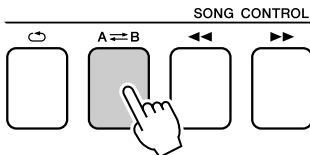

2 Press the [A⇌B] (A-B REPEAT) button a second time at the end of the section you want to repeat (the "B" point).

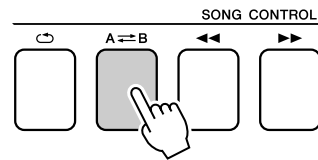

3 The specified A-B section of the song will now play repeatedly.

You can stop repeat playback at any time by pressing the [A⇌B] (A-B REPEAT) button.

NOTE

- The repeat start and end points can be specified in one-measure increments.
- The current measure number is shown in the display during playback.
- If you want to set the start point "A" at the very beginning of the song press the [A⇌B] (A-B REPEAT) button before starting playback of the song.

Muting Independent Song Parts

Each “track” of a song plays a different part of the song—melody, percussion, accompaniment, etc. You can mute individual tracks and play the muted part on the keyboard yourself, or simply mute tracks other than the ones you want to listen to. To mute a track, press the appropriate track button (TRACK [1]–[5], [A]) button. Press the same button a second time to disengage track muting.

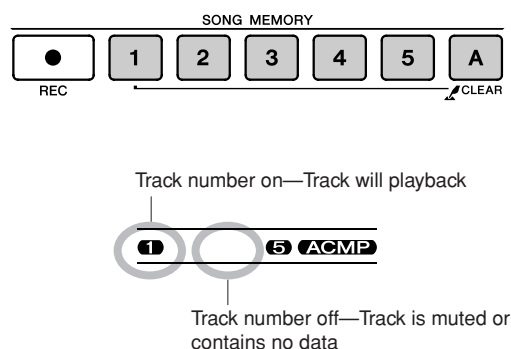

Change the Melody Voice

You can change a song’s melody voice to any other voice you prefer.

NOTE

- You cannot change the melody voice of a user song.

- Select the song and play it.
- Rotate the dial to select the voice you want to listen to after pressing the [VOICE] button.



- Press the [VOICE] button for longer than a second. “SONG MELODY VOICE” appears in the display for a few seconds, indicating that the voice selected in step #2 has replaced the song’s original melody voice.

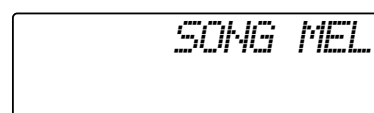

Memorize Your Favorite Panel Settings

This instrument has a Registration Memory feature that lets you save your favorite settings for easy recall whenever they're needed. Up to 16 complete setups can be saved (8 banks of two setups each).

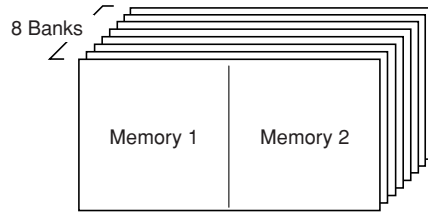

Up to 16 presets (eight banks of two each) can be memorized.

Saving to the Registration Memory

- 1 Set the panel controls as required—select a voice, accompaniment style, etc.
- 2 Press the [MEMORY/BANK] button. A bank number will appear in the display when you release the button.

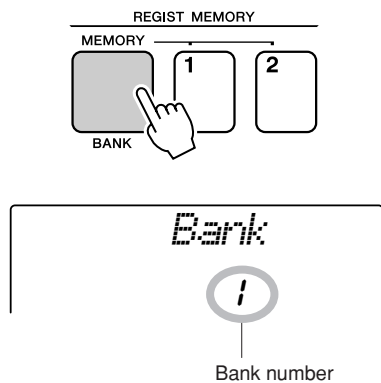

- 3 Use the dial or the [1]–[8] number buttons to select a bank number from 1 to 8.

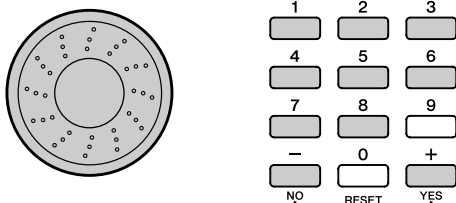

NOTE

• Data cannot be saved to the registration memory during song playback.

- 4 Press the REGIST MEMORY [1] or [2] button while holding the [MEMORY/BANK] button to store the current panel settings to the specified registration memory.

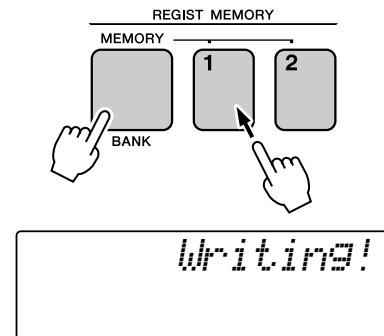

NOTE

• If you select a Registration Memory number that already contains data, the previous data is deleted and overwritten by the new data.

CAUTION

• Do not turn off the power while saving settings to the registration memory, otherwise the data may be damaged or lost.

Recalling a Registration Memory

- 1 Press the [MEMORY/BANK] button. A bank number will appear in the display when you release the button.

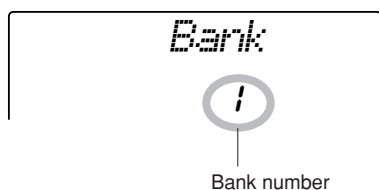
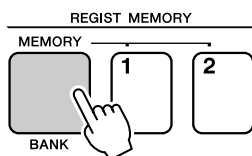

- 2 Use the dial or the [1]–[8] number buttons to select bank you want to recall.

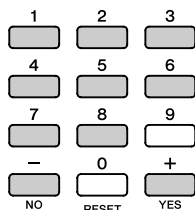
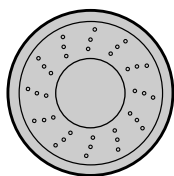

- 3 Press the REGIST MEMORY button, [1] or [2], containing the settings you want to recall. The recalled REGIST MEMORY number appears in the display for a few seconds. The panel controls will be instantly set accordingly.

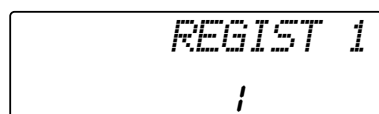
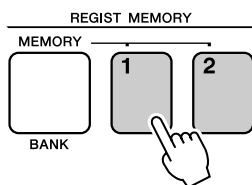

● Settings That Can be Saved to the Registration Memory

• Style settings*

Style number, Auto Accompaniment ON/OFF, Split Point, Style settings (Main A/B), Style Volume, Tempo

• Voice settings

Main Voice setting (Voice number, Volume, Octave, Pan, Reverb Send Level, Attack Time, Release Time, Filter Cutoff, Filter Resonance, Chorus Send Level), Dual Voice settings (Dual ON/OFF, Voice number, Volume, Octave, Pan, Reverb Send Level, Chorus Send Level, Attack Time, Release Time, Filter Cutoff, Filter Resonance), Split Voice settings (Split ON/OFF, Voice number, Volume, Octave, Pan, Reverb Send Level, Chorus Send Level)

• Effect settings

Reverb Type, Chorus Type

• Arpeggio settings

Arpeggio Type, Arpeggio ON/OFF

• Harmony settings

Harmony ON/OFF, Harmony Type, Harmony Volume

• Other settings

Transpose, Pitch Bend Range, Knob Assign

* Style settings are not available for Registration Memory when using the Song features.

Setting the Sleep Mode

This instrument has a Sleep Mode function that allows it to automatically go into a low-power “sleep” mode if not operated for specified period of time. In Sleep Mode all panel indicators and the display backlight are off to conserve power. The Sleep Mode function is initially disabled (OFF) by default.

1 Press the [FUNCTION] button.

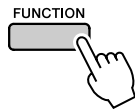

2 Use the CATEGORY [▲] and [▼] buttons to select the SLEEP item.

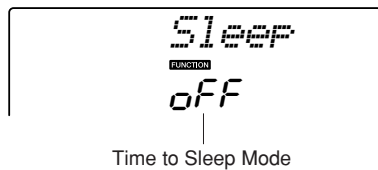
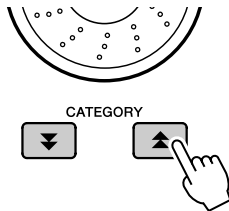

3 Rotate the dial to set the desired time until Sleep Mode begins (3–20 minutes).

The time can be set in one-minute increments. Select OFF to disable Sleep Mode (the instrument will not go to sleep). The instrument will wake from Sleep Mode as soon as a panel control is operated, a key is pressed, or a MIDI command is received.

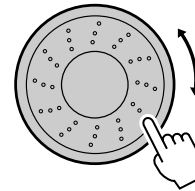

The Functions

The “Functions” provide access to a range of detailed instrument parameters for tuning, setting the split point, and adjusting the voices and effects. Take a look at the function list starting on the opposite page.

When you locate a function you want to set up, simply select the function’s display name (shown to the right of the function name in the list) and adjust as required.

Selecting and Setting Functions

1 Find the function you want to set in the list that begins on page 84.

2 Press the [FUNCTION] button.

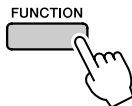

3 Select a function.

Press the CATEGORY [\blacktriangle] and [\blacktriangledown] buttons as many times as necessary until the function’s display name appears in the display.

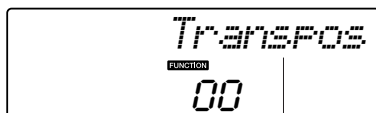
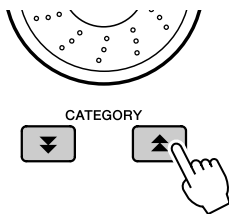

The selected function.

4 Use the dial, the [+] and [-] buttons, or the [0]–[9] number buttons to set the selected function as required.

The [+] and [-] buttons are used to make ON/OFF type settings: [+] = ON, [-] = OFF. In some cases the [+] button will initiate execution of the selected function, and the [-] will cancel the selection.

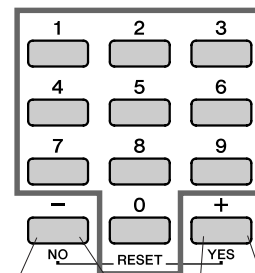
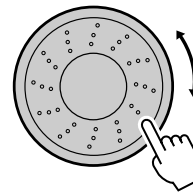

Direct numeric entry.

- Decrement value by 1.
- OFF
- Cancel

- Increment value by 1.
- ON
- Execute

Press simultaneously to recall the default setting.

Some Function settings are stored in memory as soon as they are changed. See “The Backup Parameters” on page 56 for information on the function settings that are stored on the instrument.

To restore all initial factor default settings perform the “Backup Clear” procedure described in the “Initialization” section on page 56.

● Function Setting List

Setting	Item title	Range/Settings	Description
Style Volume	<i>StyleVol</i>	000–127	Determines the volume of the Style.
Song Volume	<i>SongVol</i>	000–127	Determines the volume of the Song.
Transpose	<i>Transpos</i>	-12–12	Determines the pitch of the instrument by semitone increments.
Tuning	<i>Tuning</i>	-100–100	Sets the pitch of the instrument's sound in 1-cent increments.
Pitch Bend Range	<i>PBRange</i>	01–12	Sets the pitch bend range in semitone increments.
Split Point	<i>SplitPnt</i>	000–127 (C-2–G8)	Determines the highest key for the Split voice and sets the Split “point”—in other words, the key that separates the Split (lower) and Main (upper) voices. The Split Point setting and Accompaniment Split Point setting are automatically set to the same value.
Touch Sensitivity	<i>TouchSns</i>	1(Soft), 2(Medium), 3(Hard)	When Touch Response is on, this determines the sensitivity of the feature.
Main Voice Volume	<i>M. Volume</i>	000–127	Determines the volume of the Main voice.
Main Voice Octave	<i>M. Octave</i>	-2–+2	Determines the octave range for the Main voice.
Main Voice Pan	<i>M. Pan</i>	000 (left)– 64 (center)– 127 (right)	Determines the pan position of the Main voice in the stereo image. The value “0” results in the sound being panned full left; the value “127” results in the sound being panned full right.
Main Voice Reverb Level	<i>M. Reverb</i>	000–127	Determines how much of the Main voice's signal is sent to the Reverb effect.
Main Voice Chorus Level	<i>M. Chorus</i>	000–127	Determines how much of the Main voice's signal is sent to the Chorus effect.
Main Voice Attack Time	<i>M. Attack</i>	000–127	Sets the Main voice attack time.
Main Voice Release Time	<i>M. Releas</i>	000–127	Sets the Main voice release time.
Main Voice Filter Cutoff	<i>M. Cutoff</i>	000–127	Sets the Main voice filter cutoff frequency.
Main Voice Filter Resonance	<i>M. Reso.</i>	000–127	Sets the Main voice filter resonance.
Dual Voice	<i>D. Voice</i>	001–509	Selects the Dual voice.
Dual Voice Volume	<i>D. Volume</i>	000–127	Determines the volume of the Dual voice.
Dual Voice Octave	<i>D. Octave</i>	-2–+2	Determines the octave range for the Dual voice.
Dual Voice Pan	<i>D. Pan</i>	000 (left)– 64 (center)– 127 (right)	Determines the pan position of the Dual voice in the stereo image. The value “0” results in the sound being panned full left; the value “127” results in the sound being panned full right.
Dual Voice Reverb Level	<i>D. Reverb</i>	000–127	Determines how much of the Dual voice's signal is sent to the Reverb effect.
Dual Voice Chorus Level	<i>D. Chorus</i>	000–127	Determines how much of the Dual voice's signal is sent to the Chorus effect.
Dual Voice Attack Time	<i>D. Attack</i>	000–127	Sets the Dual voice attack time.
Dual Voice Release Time	<i>D. Releas</i>	000–127	Sets the Dual voice release time.
Dual Voice Filter Cutoff	<i>D. Cutoff</i>	000–127	Sets the Dual voice filter cutoff frequency.
Dual Voice Filter Resonance	<i>D. Reso.</i>	000–127	Sets the Dual voice filter resonance.
Split Voice	<i>S. Voice</i>	001–509	Selects the Split voice.
Split Voice Volume	<i>S. Volume</i>	000–127	Determines the volume of the Split voice.
Split Voice Octave	<i>S. Octave</i>	-2–+2	Determines the octave range for the Split voice.
Split Voice Pan	<i>S. Pan</i>	000 (left)– 64 (center)– 127 (right)	Determines the pan position of the Split voice in the stereo image. The value “0” results in the sound being panned full left; the value “127” results in the sound being panned full right.
Split Voice Reverb Level	<i>S. Reverb</i>	000–127	Determines how much of the Split voice's signal is sent to the Reverb effect.
Split Voice Chorus Level	<i>S. Chorus</i>	000–127	Determines how much of the Split voice's signal is sent to the Chorus effect.

Setting	Item title	Range/Settings	Description
Reverb Type	<i>Reverb</i>	01–10	Determines the Reverb type, including off (10). (See the list on page 117)
Chorus Type	<i>Chorus</i>	01–05	Determines the Chorus type, including off (05). (See the list on page 117)
Master EQ Type	<i>MasterEQ</i>	Speaker1, Speaker2, Headphone, Line Out1, Line Out2	Sets the equalizer applied to the speaker output for optimum sound in different listening situations.
Harmony Type	<i>HarmType</i>	01–26	Determines the Harmony type. (See the list on page 117)
Harmony Volume	<i>HarmVol</i>	000–127	Determines the volume of the Harmony effect.
Arpeggio Type	<i>ARP Type</i>	01–100	Determines the Arpeggio type. (See the list on page 14)
Arpeggio Velocity	<i>ARP Velo</i>	1 (Original), 2 (Thru)	Sets the velocity mode for arpeggio playback.
Style File Load	<i>Sff Load</i>	001–nnn	Loads a Style file.
PC mode	<i>PC mode</i>	PC1/PC2/OFF	Optimizes the MIDI settings when you connect to a computer (page 89).
Local On/Off	<i>Local</i>	ON/OFF	Determines whether the instrument's keyboard controls the internal tone generator (ON) or not (OFF). (page 88)
External Clock	<i>ExtClock</i>	ON/OFF	Determines whether the instrument synchronizes to the internal clock (OFF) or an external clock (ON). (page 88)
Keyboard Out	<i>KbdOut</i>	ON/OFF	Determines whether keyboard performance data of the instrument is transmitted (ON) or not (OFF).
Style Out	<i>StyleOut</i>	ON/OFF	Determines whether Style data is transmitted (ON) via USB or not (OFF) during Style playback.
Song Out	<i>SongOut</i>	ON/OFF	Determines whether User Song is transmitted (ON) via USB or not (OFF) during Song playback.
Initial Send	<i>InitSend</i>	YES/NO	Lets you send the data of the panel settings to a computer. Press [+] to send, or press [-] to cancel.
Time Signature Numerator	<i>Timesign</i>	00–60	Determines the time signature of the Metronome.
Time Signature Denominator	<i>TimesignD</i>	Half note, Quarter note, Eighth note, Sixteenth note	Sets the length of each metronome beat.
Metronome Volume	<i>MtrVol</i>	000–127	Determines the volume of the Metronome.
Lesson Track (R)	<i>R-Part</i>	GuideTrack 1–16	Determines the guide track number for your right hand lesson. The setting is only effective for songs in SMF format 0 transferred from a computer.
Lesson Track (L)	<i>L-Part</i>	GuideTrack 1–16	Determines the guide track number for your left hand lesson. The setting is only effective for songs in SMF format 0 transferred from a computer.
Grade	<i>Grade</i>	ON/OFF	Determines whether the Grade function is on or off.
Demo Cancel	<i>D-Cancel</i>	ON/OFF	Determines whether Demo cancel is enabled or not. When this is set to ON, the Demo Song will not play, even if the [DEMO/PC] button is pressed.
Sleep	<i>Sleep</i>	3–20, OFF	Sets the amount of time before the instrument will go into Sleep Mode.

* All these settings can be conveniently reset to their initial default values by pressing the [+] and [-] buttons simultaneously. (The exception to this is Initial Send, which is an operation, not a setting.)

Connecting to a Computer

Nearly all of the electronic musical instruments made today—particularly synthesizers, sequencers and computer music related devices—use MIDI. MIDI is a worldwide standard that allows these devices to send and receive performance and setting data. Naturally, this instrument lets you save or send your keyboard performance as MIDI data, as well as the songs, styles and panel settings.

The potential MIDI holds for your live performances and music creation/production is enormous—simply by connecting this instrument to a computer and transmitting MIDI data. In this section, you'll learn the basics of MIDI and the specific MIDI functions provided by this instrument.

What Is MIDI?

No doubt you have heard the terms “acoustic instrument” and “digital instrument”. In the world today, these are the two main categories of instruments. Let's consider a grand piano and a classical guitar as representative acoustic instruments. They are easy to understand. With the piano, you strike a key, and a hammer inside hits some strings and plays a note. With the guitar, you directly pluck a string and the note sounds. But how does a digital instrument go about playing a note?

● Acoustic guitar note production

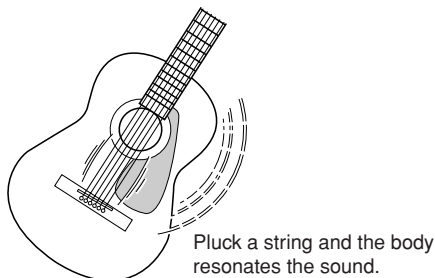

● Digital instrument note production

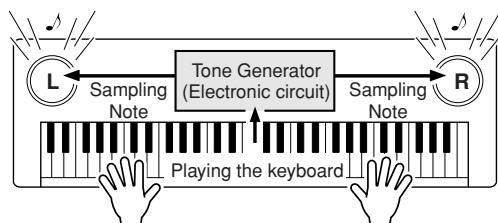

Based on playing information from the keyboard, a sampling note stored in the tone generator is played through the speakers.

As shown in the illustration above, in an electronic instrument the sampling note (previously recorded note) stored in the tone generator section (electronic circuit) is played based on information received from the keyboard. So then what is the information from the keyboard that becomes the basis for note production?

For example, let's say you play a “C” quarter note using the grand piano sound on the instrument. Unlike an acoustic instrument that puts out a resonated note, the electronic instrument puts out information from the keyboard such as “with what voice”, “with which key”, “about how strong”, “when was it pressed”, and “when was it released”. Then each piece of information is changed into a number value and sent to the tone generator. Using these numbers as a basis, the tone generator plays the stored sampling note.

Example of Keyboard Information

Voice number (with what voice)	1 (grand piano)
Note number (with which key)	60 (C3)
Note on (when was it pressed) and note off (when was it released)	Timing expressed numerically (quarter note)
Velocity (about how strong)	120 (strong)

Your keyboard performance and all panel operations of this instrument are processed as MIDI data. The songs, auto accompaniment (styles), and User songs are also made up of MIDI data. MIDI is an acronym that stands for Musical Instrument Digital Interface and it allows different musical instruments and devices to instantly communicate with each other, via digital data. The MIDI standard is used all over the world and was designed to transmit performance data between electronic musical instruments (or computers). Thanks to MIDI, you can control one instrument from another and transmit performance data between the devices-taking your creative and performance potential to even higher levels.

MIDI messages can be divided into two groups: Channel messages and System messages.

● Channel Messages

This instrument is capable of handling 16 MIDI channels simultaneously—meaning it can play up to sixteen different instruments at the same time. Channel messages transmit information such as Note ON/OFF, Program Change, for each of the 16 channels.

Message Name	Instrument Operation/Panel Setting
Note ON/OFF	Performance data of the keyboard (contains note number and velocity data)
Program Change	Instrument selection (including bank select MSB/LSB, if necessary)
Control Change	Instrument settings (volume, pan, etc.)

● System Messages

This is data that is used in common by the entire MIDI system. System messages include messages like Exclusive Messages that transmit data unique to each instrument manufacturer and Realtime Messages that control the MIDI device.

Message Name	Instrument Operation/Panel Setting
Exclusive Message	Reverb/chorus settings, etc.
Realtime Messages	Start/stop operation

Connecting a Personal Computer

The following functions become available when this instrument is connected to a computer.

- Performance data can be transferred between the instrument and the computer (page 88).
- Files can be transferred between the instrument and the computer (page 90).

The connection procedure is as follows:

1 Install the USB-MIDI driver on your computer.

The USB-MIDI driver is included on the CD-ROM. Installation of the USB-MIDI driver is described on page 93.

2 Connect the USB terminal of the computer to the USB terminal on the instrument using an AB type USB cable (USB cable sold separately).

The supplied CD-ROM also includes a Musicsoft Downloader application that allows you to transfer song files from your computer to the instrument's flash memory. For instructions about how to install Musicsoft Downloader and how to transfer song files, see page 91.

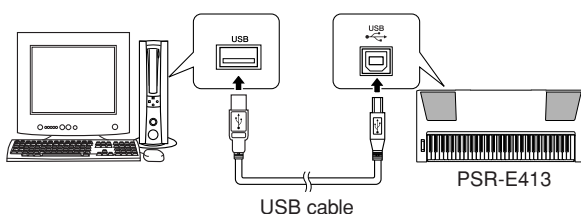

■ Precautions when using the USB terminal

When connecting the computer to the USB terminal, make sure to observe the following points. Failing to do so risks freezing the computer and corrupting or losing the data. If the computer or the instrument freezes, restart the application software or the computer OS, or turn the power to the instrument off then on again.

⚠ CAUTION

- Use an AB type USB cable of less than about 3 meters.
- Before connecting the computer to the USB terminal, exit from any power-saving mode of the computer (such as suspended, sleep, standby).
- Before turning on the power to the instrument, connect the computer to the USB terminal.
- Execute the following before turning the power to the instrument on/off or plugging/unplugging the USB cable to/from the USB terminal.
 - Quit any open application software on the computer.
 - Make sure that data is not being transmitted from the instrument. (Data is transmitted whenever you play on the keyboard or play back a song, etc.)
- While the computer is connected to the instrument, you should wait for six seconds or more between these operations: (1) when turning the power of the instrument off then on again, or (2) when alternately connecting/disconnecting the USB cable.

Transferring Performance Data to and from a Computer

By connecting the instrument to a computer, the instrument's performance data can be used on the computer, and performance data from the computer can be played on the instrument.

- When the instrument is connected with computer, it transmits/receives performance data.

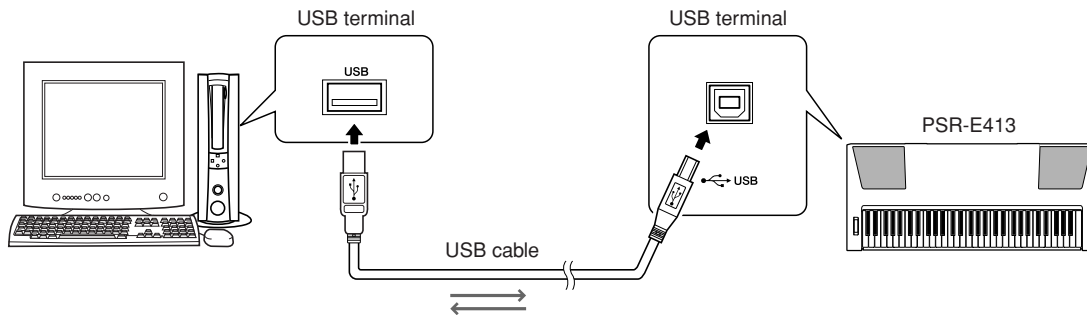

MIDI settings

These settings pertain to performance data transmission and reception.

Item	Range/Settings	Description
Local	ON/OFF	Local control determines whether or not notes played on the instrument are sounded by its internal tone generator system: the internal tone generator is active when local control is on, and inactive when local control is off.
External Clock	ON/OFF	These settings determine whether the instrument is synchronized to its own internal clock (OFF), or to a clock signal from an external device (ON).
Keyboard Out	ON/OFF	These settings determine whether keyboard performance data of the instrument is transmitted (ON) or not (OFF).
Style Out	ON/OFF	These settings determine whether Style data is transmitted (ON) or not (OFF) during Style playback.
Song Out	ON/OFF	These settings determine whether User Song is transmitted (ON) or not (OFF) during Song playback.

CAUTION

• If you can't get any sound out of the instrument, this may be the most likely cause.

CAUTION

• If External Clock is ON and no clock signal is being received from an external device, the song, style, and metronome functions will not start.

1 Press the [FUNCTION] button.

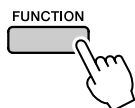

2 Use the CATEGORY [▲] and [▼] buttons to select the item you want to change its value.

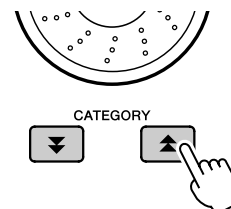

3 Use the dial to select ON or OFF.

■ PC Mode

A number of MIDI settings need to be made when you want to transfer performance data between the computer and the instrument. The PC Mode item can conveniently make multiple settings for you in one operation. Three settings are available: PC1, PC2, and OFF.

This setting is not necessary when transferring song or backup files between the computer and the instrument.

* Set the PC mode to PC2 when using Digital Music Notebook.

	PC1	PC2*	OFF
Local	OFF	OFF	ON
External Clock	ON	OFF	OFF
Song Out	OFF	OFF	OFF
Style Out	OFF	OFF	OFF
Keyboard Out	OFF	ON	ON

1 Press and hold the [DEMO/PC] button for longer than a second so that the PC Mode item appears.

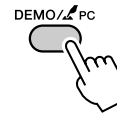

2 Use the dial to select PC1, PC2, or OFF.

NOTE

- When the PC2 setting is selected the instrument's style, song, demo, song recording, and lesson features cannot be used.

NOTE

- You can also access the PC Mode item by first pressing the [FUNCTION] button and then using the CATEGORY [▲] and [▼] buttons to locate it (page 83).

Remote Control of MIDI Devices

You can also use this instrument as a remote control device for the Digital Music Notebook application on your computer (via the USB connection)—controlling playback, stop and transport functions from the panel.

■ Remote control keys

To use the remote control functions, simultaneously hold down the lowest two keys on the keyboard (C1 and C#1) and press the appropriate key (shown below).

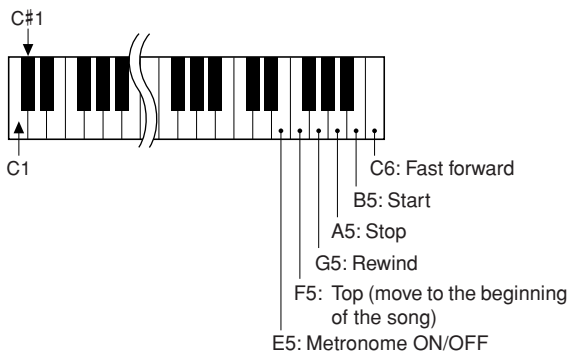

NOTE

- Remote control of MIDI devices will function independently of the PC2 mode.

Initial Send

This function lets you send the panel setup data to a computer. Before you record performance data to a sequencer application running on your computer, it is a good idea to first send and record the panel setup data before the actual performance data.

1 Press the [FUNCTION] button.

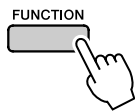

2 Use the CATEGORY [▲] and [▼] buttons to select the Initial Send item.

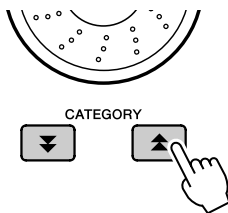

3 Press [+ / YES] to send, or press [- / NO] to cancel.

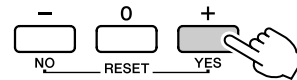

Transferring Data between the Computer and Instrument

Songs, styles, or Music Database files residing on a computer or the supplied CD-ROM, can be transferred to the instrument. Backup files can also be transferred from the instrument to the computer and back.

In order to transfer files between your computer and the instrument you will need to install the Musicsoft Downloader application and the USB-MIDI Driver included on the Accessory CD-ROM on your computer. Refer to the Accessory CD-ROM Installation Guide on page 93 for installation details.

● **Data that can be transferred from a computer to this instrument.**

- Data Capacity: 373 KB
256 files total for the Song, Style and Music Database.
- Data Format
Song: (.mid) SMF format 0/1
Style: (.sty)
Music Database: (.mfd)
Backup File: 08PK61.bup

● **What is SMF (Standard MIDI File)?**

The SMF (Standard MIDI File) format is one of the most common and widely compatible sequence formats used for storing sequence data. There are two variations: Format 0 and Format 1. A large number of MIDI devices are compatible with SMF Format 0, and most commercially available MIDI sequence data is provided in SMF Format 0.

■ **With the Musicsoft Downloader You Can.**

- Transfer files from the computer to the instrument's flash memory.

⇒ **refer to the procedure described on page 91.**

The procedure for transferring songs included on the Accessory CD-ROM from your computer to the instrument is given as an example.

- Backup files can be transferred from the instrument to a computer and back.

⇒ refer to the procedure described on page 92.

Use the Musicsoft Downloader application with Internet Explorer 5.5 or higher.

■ Use Musicsoft Downloader To Transfer Songs From the Accessory CD-ROM To the Instrument's flash memory.....

NOTE

- If a song or style is being played, stop playback before proceeding.

- 1 Install the Musicsoft Downloader and USB-MIDI driver to your computer, then connect the computer and the instrument (page 95).

- 2 Insert the included CD-ROM into the CD-ROM drive.

A start window will appear automatically.

- 3 Double-click the Musicsoft Downloader shortcut icon that is created on the desktop.

This will launch the Musicsoft Downloader application and the main window will appear.

NOTE

- The instrument cannot be operated while the Musicsoft Downloader is running.

- 4 Click the "Add File" button and the Add File window will appear.

- 5 Click the button to the right of "Look in" and select the CD-ROM drive from the drop-down menu that appears. Double-click the "SampleData" Folder on the window. Select the file from the "SongData" Folder you want to transfer to the instrument, and click "Open".

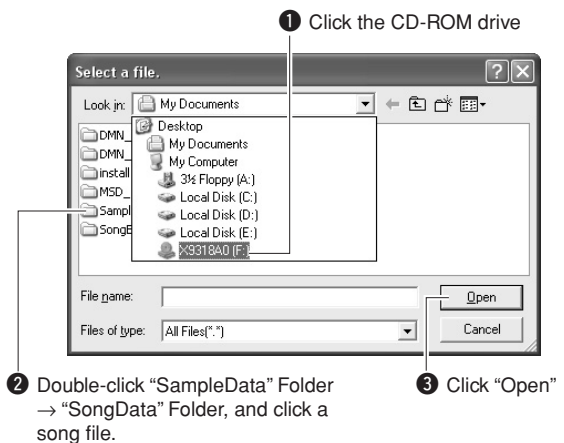

At this point you can select a Style or Music Database file on the computer or CD-ROM and transfer it to the instrument in the same way as a song file.

6 A copy of the selected MIDI song file will appear in the "List of files stored temporarily" at the top of the window.

The memory medium will also be displayed at the bottom of the window to specify the destination for the transfer. Click the "Electronic Musical Instruments", and then "Flash memory."

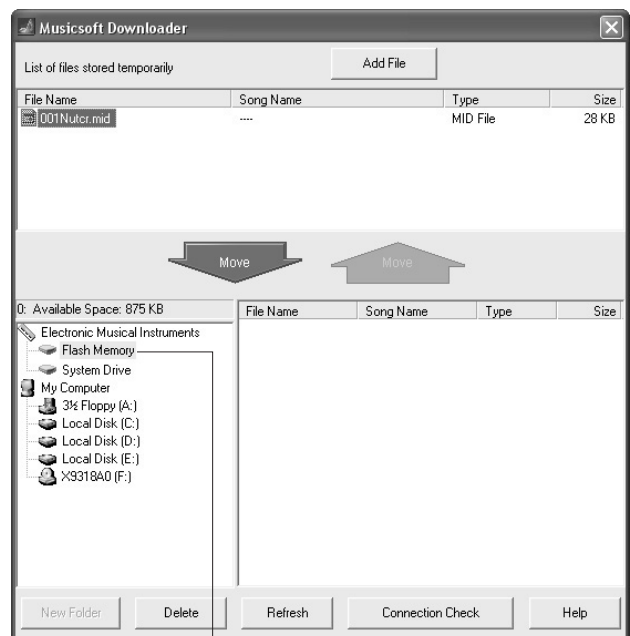

7 After selecting the file in the “List of files stored temporarily”, click the downward [Move] button and a confirmation message will appear. Click [OK] and the song will be transferred from the “List of files stored temporarily” to the instrument’s memory.

8 Close the window to end the Musicsoft Downloader.

NOTE

• End the Musicsoft Downloader to playback the file transferred from your computer.

9 To playback a song stored in flash memory, press the [SONG] button. Use the dial to select the song you want to play, then press the [▶/■] (START/STOP) button to start playback.

CAUTION

• Do not unplug the USB cable during a data transfer. Not only will the data not be transferred and saved, but operation of the memory media may become unstable and its contents may disappear completely when the power is turned on or off.

CAUTION

• Store data can be lost due to equipment malfunction or improper operation. For safety we recommend that you keep a copy of all important data stored on your computer.
• We recommend that you use a power adaptor rather than batteries when transferring data. The data can be corrupted if the batteries fail during the transfer.

● To Use transferred Songs For Lessons...

In order to use songs (only SMF format 0) transferred from a computer for lessons it is necessary to specify which channels are to be played back as the right-hand and left-hand parts.

- 1** Press the [SONG] button and select the song (036–) residing in flash memory for which you want to set the guide track.
- 2** Press the [FUNCTION] button.
- 3** Use the CATEGORY [▲] and [▼] buttons to select the R-Part or L-Part item.
- 4** Use the dial to select the channel you want to play back as the specified right- or left-hand part.

We recommend that you select channel 1 for the right-hand part and channel 2 for the left-hand part.

■ Transfer a backup file from the instrument to a computer...

You can use the Musicsoft Downloader to transfer “Backup Files” containing backup data (page 56), including the five User Songs stored on the instrument, to a computer. If you click “Electronic Musical Instruments” in the Musicsoft Downloader display, and then “System Drive”, a file named “08PK61.bup” will appear in the lower right corner of the Musicsoft Downloader display. This is the backup file. For details about how to transmit backup file using the Musicsoft Downloader application, refer to the Online help “Transferring Data Between the Computer and Instrument (for unprotected data)” in the application.

NOTE

• Preset Song data cannot be transmitted from the instrument.

CAUTION

• The backup data, including the five User Songs is transmitted/received as a single file. As a result, all backup data will be overwritten every time you transmit or receive. Keep this in mind when transferring data.

CAUTION

• Do not rename the backup file on the computer. If you do so, it will not be recognized when transferred to the instrument.



Accessory CD-ROM Installation Guide

SPECIAL NOTICES

- The software and this manual are the exclusive copyrights of Yamaha Corporation.
- Use of the software and this manual is governed by the license agreement which the purchaser fully agrees to upon breaking the seal of the software packaging. (Please read carefully the Software Licensing Agreement at the end of this manual before installing the application.)
- Copying of the software or reproduction of this manual in whole or in part by any means is expressly forbidden without the written consent of the manufacturer.
- Yamaha makes no representations or warranties with regard to the use of the software and documentation and cannot be held responsible for the results of the use of this manual and the software.
- This disk containing the software is not meant for use with an audio/visual system (CD player, DVD player, etc.). Do not attempt to use the disk on equipment other than a computer.
- Future upgrades of application and system software and any changes in specifications and functions will be announced separately.
- The screen displays as illustrated in this manual are for instructional purposes, and may appear somewhat different from the screens which appear on your computer.

Important Notices about the CD-ROM

● Data Types

This CD-ROM includes application software. Please refer to page 95 for software installation instructions.

CAUTION

- *Do not attempt to play this CD-ROM on any playback device other than a computer. The resulting high-volume noise may cause hearing damage or damage to the playback device.*

● Operating System (OS)

The applications in this CD-ROM are provided in versions for Windows operating systems.

CD-ROM Contents



Folder Name		Application / Data Name	Contents
①	MSD_	Musicsoft Downloader	This application can be used to download MIDI song data from the Internet and transfer it from the computer to the instrument's memory.
②	DMN_	Digital Music Notebook	Digital Music Notebook is a combination music learning program and online service that makes it easy and fun to practice and master your favorite songs. You can use the convenient and powerful Digital Music Notebook functions with the demo song after installing Digital Music Notebook.
	DMN_FlashDemo	Digital Music Notebook Flash Demo	Full motion demo software which introduces all features of the Digital Music Notebook.
③	SongBook	Song Book	Includes score data for the 30 internal songs provided on the instrument as well as 70 MIDI songs provided on the CD-ROM. The exceptions are songs 1–11, 16, 20 and song 30 which is copyrighted. The scores for songs 9–11 are provided in this manual beginning on page 100.
④	USBdrv2k_	USB-MIDI Driver (Windows 2000/XP)	This driver software is necessary to connect MIDI devices to your computer via USB.
	USBdrvVista_	USB-MIDI Driver (Windows Vista/XP x64)	
	SampleData	SongData	MIDI 70 songs
		StyleData	5 style files
		MDB	5 music database files
			These songs, styles, or music database can be transferred to the instrument and played or used with the instrument functions.

In order to view PDF scores, you will need to install Adobe Reader in your computer. You can download the Adobe Reader. Please check the following URL: <http://www.adobe.com/>

■ Using the CD-ROM

Please read the Software License Agreement on page 121 before opening the CD-ROM package.

1 Check the system requirements to make sure that the software will run on your computer.

2 Insert the included CD-ROM into the CD-ROM drive.

The start window should appear automatically.

3 Install the USB-MIDI driver to the computer.

Refer to “Installing the USB-MIDI Driver” on page 95 for installation and setup instructions.

4 Connect the instrument to the computer.

The connection procedure is described on page 87.

5 Install the software.

Musicsoft Downloader:

See page 97.

6 Launch the software.

For further software operation refer to the online help supplied with the software.

Refer to the “Troubleshooting” on page 98 when you have trouble with installing the driver.

System Requirements

Application/Data	OS	CPU	Memory	Hard Disk	Display
Musicsoft Downloader	Windows 2000/XP Home Edition/XP Professional/Vista * Only 32-bit is supported.	233 MHz or higher; Intel® Pentium®/Celeron® Processor family (500 MHz or higher is recommended)	64 MB or more (256 MB or more is recommended)	at least 128 MB of free space (at least 512 MB of free space is recommended)	800 x 600 HighColor (16-bit)
USB Driver for Windows 2000/XP	Windows 2000/XP Home Edition/XP Professional	166 MHz or higher; Intel® Pentium®/Celeron® Processor family	32 MB or more (64 MB or more is recommended)	at least 3 MB of free space	—
USB Driver for Windows Vista/XP x64	Windows Vista/XP Professional x64 Edition	800 MHz or higher; Intel® Pentium® /Celeron® Processor family or Intel® 64 compatible processor	512 MB or more	at least 3 MB of free space	—
Digital Music Notebook	Windows XP Home/ Professional Edition, Service Pack 1a (SP1a) more/Windows Vista * Only 32-bit is supported.	400 MHz or higher processor clock speed (Intel® Pentium®/Celeron® Processor family, or compatible processor recommended)	128 MB or more (256 MB or more is recommended)	at least 150 MB of free space	1024 x 768 HighColor (16-bit)
Digital Music Notebook (Requirements for playing content with video included.)	Windows 2000/XP Home Edition/XP Professional/Vista * Only 32-bit is supported.	1 GHz or higher; Intel® Pentium®/Celeron® Processor family (1.4 GHz or more is recommended)	256 MB or more		

Software Installation

● Uninstall (Removing the Software)

Installed software can be removed from your computer as follows:
From the Windows Start menu select Start → Settings → Control panel → Add or Remove Applications → Install and Uninstall. Select the item you want to remove and click [Add or Remove]. Follow the on-screen instructions to remove the selected software.

NOTE

• The actual names of the menu items and buttons will depend on the OS version you are using.

■ Installing the USB-MIDI Driver....

In order to be able to communicate with and use MIDI devices connected to your computer, the appropriate driver software must be properly installed on your computer.
The USB-MIDI driver allows sequence software and similar applications on your computer to transmit and receive MIDI data to and from MIDI devices via a USB cable.

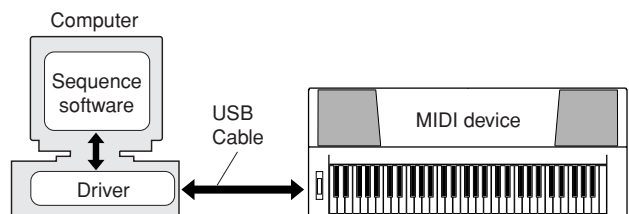

- Windows 2000 installation → page 96.
- Windows XP installation → page 96.
- Windows Vista installation → page 97

Check the drive name of the CD-ROM drive you will be using (D:, E:, Q: etc.) The drive name is displayed beside the CD-ROM icon in your “My Computer” folder. The root directory of the CD-ROM drive will be D:\, E:\, or Q:\, respectively.

Installing the driver on Windows 2000

- 1** Start the computer and use the “Administrator” account to log on to Windows 2000.
- 2** Select [My Computer] → [Control Panel] → [System] → [Hardware] → [Driver Signing] → [File Signature Verification], and check the radio button to the left of “Ignore—Install all files, regardless of file signature” and click [OK].
- 3** Insert the supplied CD-ROM into the CD-ROM drive. A start window will appear automatically.
- 4** First, make sure the POWER switch on the MIDI device is set to OFF, then use a USB cable to connect the MIDI device to the computer. After making the connections, turn on the power of the MIDI device. The system automatically launches the Found New Hardware Wizard. Click [Next]. (Some computers may take a while to display the Wizard window.)
Otherwise, refer to “Troubleshooting” in the “Accessory CD-ROM Installation Guide” section of the Owner’s Manual.
- 5** Select the radio button for “Search for a suitable driver for my device [recommended]”, then click [Next].
- 6** Check the “CD-ROM drives” check box, deselect all other check boxes, then click [Next].

NOTE

• If the system prompts you to insert the Windows CD-ROM during detection of the drivers, point to the “USBdrv2k_” folder (e.g., D:\USBdrv2k_) and continue the installation.

- 7** Deselect the “Install one of the other drivers”, then click [Next].

NOTE

• If the Wizard panel informs you that “The software you are about to install does not contain a Microsoft digital signature”, click [Yes].

- 8** When the installation is complete, the Wizard displays “Completing the Found New Hardware Wizard”.
Click [Finish]. (Some computers may take a while to display the Wizard window.)
- 9** Restart the computer.
The USB-MIDI driver installation is complete.

Installing the driver on Windows XP

- 1** Start the computer and use the “Administrator” account to log on to Windows XP.
- 2** Select [Start] → [Control Panel]. If the control panel appears as “Pick a category”, click “Switch to Classic View” in the upper left of the window. All control panels and icons will be displayed.
- 3** Go to [System] → [Hardware] → [Driver Signing Options] and check the radio button to the left of “Ignore” and click [OK].
- 4** Click the [OK] button to close System Properties, and then click “X” in the upper right of the window to close the Control Panel.
- 5** Insert the supplied CD-ROM into the CD-ROM drive. A start window will appear automatically.
- 6** First, make sure the POWER switch on the MIDI device is set to OFF, then use a USB cable to connect the MIDI device to the computer. After making the connections, turn on the power of the MIDI device. The system launches the Found New Hardware Wizard automatically. Otherwise, refer to “Troubleshooting” in the “Accessory CD-ROM Installation Guide” section of the Owner’s Manual. If the system displays “Found New Hardware” in the lower right corner, wait until Wizard window is displayed. (Some computers may take a while to display the window.)
If the Wizard window prompts you to specify whether or not to connect to Windows Update, select the radio button for “No, not this time”, then click [Next].

- 7** Select the radio button for “Install the software automatically (recommended)”, then click [Next].

NOTE

• If during the installation the system displays “...has not passed Windows Logo testing to verify its compatibility with Windows XP”, click [Continue Anyway].

- 8** When the installation is complete, the Wizard displays “Completing the Found New Hardware Wizard”.
Click [Finish]. (Some computers may take a while to display the Wizard window.)
- 9** Restart the computer.
If the system displays “Found New Hardware” in the lower right corner, wait until the Wizard window is displayed. (Some computers may take a while to display the Wizard window.)

The USB-MIDI driver installation is complete.

NOTE

- This Wizard window will not appear when using Windows XP Professional x64 Edition. There is no need to restart the computer.

10 When using Windows XP Professional x64 Edition, the Support Module must be installed.

After installing the USB-MIDI drivers for all the connected USB devices, select “My Computer” from the Start menu. Right-click the CD-ROM icon and select “Open” from the pop-up menu. Select “USBdrvVista_” → “XPx64SupportModule” → “Setup.exe” and launch “Setup.exe.” Follow the onscreen directions.

NOTE

- Once the Support Module is installed, this step is not necessary, even if you’ve connected a new USB device or updated the USB-MIDI driver.

Installing the driver in Windows Vista

- 1 Start the computer and use the “Administrator” account to log on to Windows Vista.
- 2 Insert the included CD-ROM into the CD-ROM drive. A start window will appear automatically.
- 3 First, make sure the POWER switch on the MIDI device is set to OFF, then use a USB cable to connect the MIDI device to the computer. After making the connections, turn on the power of the MIDI device. The system automatically launches the “Found New Hardware” window. Click “Locate and install driver software (recommended)”.

Otherwise, refer to “Troubleshooting” in the “Accessory CD-ROM Installation Guide” section of the Owner’s Manual. (Some computers may take a while to display the window.)

NOTE

- If the “User Account Control” window appears, click [Continue].

- 4 If a message allowing Windows to search online for driver software appears, click “Don’t search online.”
- 5 If a message prompting you to insert the disk that came with your device appears, click [Next].

The system starts the installation.

NOTE

- If the “Windows Security” window appears, confirm this software is authored by Yamaha Corporation then click [Install].

- 6 When the installation is complete, the system displays the message “The software for this device has been successfully installed.” Click [Close].

(Some computers may take a while to display the window.)

The USB-MIDI driver installation is complete.

■ Installing the Musicsoft Downloader and Digital Music Notebook Applications...

IMPORTANT

- You will need to log on with administrator (root) privileges in order to install Musicsoft Downloader on a computer running Windows 2000, XP or Vista.
- You will need to log on with administrator (root) privileges in order to install Digital Music Notebook on a computer running Windows XP or Vista.

IMPORTANT

- When installing the Digital Music Notebook, make sure that Internet Explorer 6.0 (with SP1) or higher is installed to your computer.

IMPORTANT

- Credit card settlement is required to purchase Digital Music Notebook content. Credit card processing may not be possible for some areas, so please check with your local authorities to make sure that your credit card can be used.

NOTE

- Use of the DMN (Digital Music Notebook) is governed by the SIBEL-IUSSCORCH LICENSE AGREEMENT, which the purchaser fully agrees to when using the application. Please read carefully the AGREEMENT at the end of this manual before using the application.

- 1 Insert the Accessory CD-ROM into your computer’s CD-ROM drive. The start window will appear automatically showing software applications.

NOTE

- If the start window does not appear automatically, double click your “My Computer” folder to open it. Right-click the CD-ROM icon and select “Open” from the pop-up menu. Double click “Start.exe” and proceed to step 2, below.

- 2 Click [Musicsoft Downloader] or [Digital Music Notebook].
- 3 Click the [install] button, and follow the on-screen instructions to install the software.

For Digital Music Notebook operating instructions see the help menu: launch the Digital Music Notebook application and click “Help”.

For Musicsoft Downloader operating instructions see the Help menu: launch the Musicsoft Downloader application and click “Help”.

- * You can obtain the latest version of the Musicsoft Downloader at the following Internet URL.
<http://music.yamaha.com/download/>

IMPORTANT

- Only Musicsoft Downloader can be used to transfer files between this instrument and a computer. No other file transfer application can be used.

■ Troubleshooting

The driver cannot be installed.

- **Is the USB cable connected correctly?**
Check the USB cable connection. Disconnect the USB cable, then connect it again.
- **Is the USB function enabled on your computer?**
When you connect the instrument to the computer for the first time, if the “Add New Hardware Wizard” does not appear, the USB function on the computer may be disabled. Perform the following steps.

1 Select [Control Panel]* → [System] → [Hardware] → [Device Manager] (for Windows 2000/XP), or select [Control Panel] → [Device Manager] (for Windows Vista).

* Classic View only in Windows XP.

2 Make sure that no “!” or “x” marks appear at “Universal serial bus controller” or “USB Root Hub”. If you see an “!” or “x” mark, the USB controller is disabled.

- **Is any unknown device registered?**
If driver installation fails, the instrument will be marked as an “Unknown device”, and you will not be able to install the driver. Delete the “Unknown device” by following the steps below.

1 Select [Control Panel]* → [System] → [Hardware] → [Device Manager] (for Windows 2000/XP), or select [Control Panel] → [Device Manager] (for Windows Vista).

* Classic View only in Windows XP.

- 2** Look for “Other devices” in the menu “View devices by type”.
- 3** If you find “Other devices”, double-click it to extend the tree to look for “Unknown device”. If one appears, select it and click the [Remove] button.
- 4** Remove the USB cable from the instrument, and make the connection again.
- 5** Install the driver again.

- Windows 2000 users..... see page 96
- Windows XP users..... see page 96
- Windows Vista users see page 97

When controlling the instrument from your computer via USB, the instrument does not operate correctly or no sound is heard.

- Did you install the driver? (page 95)
- Is the USB cable connected correctly?
- Are the volume settings of the instrument, playback device, and application program set to the appropriate levels?
- Have you selected an appropriate port in the sequence software?

- **Are you using the latest USB-MIDI driver? The latest driver can be downloaded from the following web site.**

<http://music.yamaha.com/download/>

Playback response is delayed.

- Does your computer satisfy the system requirements?
- Is any other application or device driver running?

Cannot suspend or resume the computer correctly.

- **Do not suspend the computer while the MIDI application is running.**
You may not be able to suspend/resume normally, depending on the particular environment (USB Host Controller, etc.). Even so, simply disconnecting and connecting the USB cable will allow you to use the instrument functions again.

How can I remove the driver?

[Windows 2000/XP/Vista]

- 1** Start the computer and use the “Administrator” account to log on Windows.
Close all applications and windows that are open.
- 2** Insert the included CD-ROM into the CD-ROM drive.
- 3** Select “My Computer” from the Start menu.
- 4** Right-click the CD-ROM icon and select “Open” from the pop-up menu.
- 5** Select “USBdrvVista_” or “USBdrv2k_” folder → “uninstall” folder → “uninstall.exe” file and launch “uninstall.exe.” file.

Follow the on-screen instructions to uninstall the driver.

NOTE

- When using a 64-bit OS, click “uninstall_x64.exe.” from “USBdrvVista_” folder.

NOTE

- If the “User Account Control” window appears, click [Continue].

- 6** A message asking you to restart your computer in order to complete the uninstall procedure will appear.

Driver removal will be complete when you have restarted your computer.



Troubleshooting

Problem	Possible Cause and Solution
When the instrument is turned on or off, a popping sound is temporarily produced.	This is normal and indicates that the instrument is receiving electrical power.
When using a mobile phone, noise is produced.	Using a mobile phone in close proximity to the instrument may produce interference. To prevent this, turn off the mobile phone or use it further away from the instrument.
There is no sound even when the keyboard is played or when a song or style is being played back.	Check that nothing is connected to the PHONES/OUTPUT jack on the rear panel. When a set of headphones is plugged into this jack, no sound is output. Check the Local Control on/off. (See page 88.)
Playing keys in the right hand area of the keyboard does not produce any sound.	When using the Dictionary function (page 77), the keys in the right hand area are used only for entering the chord root and type.
<ul style="list-style-type: none"> • The volume is too soft. • The sound quality is poor. • The rhythm stops unexpectedly or will not play. • The recorded data of the song, etc. does not play correctly. • The LCD display suddenly goes dark, and all panel settings are reset. 	The batteries are low or dead. Replace all six batteries with completely new ones, or use the optional AC adaptor.
The style or song does not play back when the [START/STOP] button is pressed.	Is External Clock set to ON? Make sure External Clock is set to OFF; refer to "External Clock" on page 88.
The style does not sound properly.	Make sure that the Style Volume (page 84) is set to an appropriate level.
	Is the split point set at an appropriate key for the chords you are playing? Set the split point at an appropriate key (page 72). Is the "ACMP ON" indicator showing in the display? If it is not showing press the [ACMP ON/OFF] button so that it does show.
No rhythm accompaniment plays when the [START/STOP] button is pressed after selecting style number 141 or a style between 153 and 165 (Pianist).	This is not a malfunction. Style number 141 and style numbers 153–165 (Pianist) have no rhythm parts, so no rhythm will play. The other parts will begin playing when you play a chord in the accompaniment range of the keyboard if style playback is turned on.
Not all of the voices seem to sound, or the sound seems to be cut off.	The instrument is polyphonic up to a maximum of 32 notes. If the Dual voice or Split voice is being used and a style or song is playing back at the same time, some notes/sounds may be omitted (or "stolen") from the accompaniment or song.
Some notes don't sound when playing multiple notes simultaneously on the keyboard, or some notes don't sound when playing arpeggios.	You have exceeded 32 simultaneous notes, which is the maximum polyphony (the maximum number of notes that can be played simultaneously) of the instrument. The instrument will play normally as long as no more than 32 notes are being played at once, both on the keyboard and by any automatic playback functions.
The footswitch (for sustain) seems to produce the opposite effect. For example, pressing the footswitch cuts off the sound and releasing it sustains the sounds.	The polarity of the footswitch is reversed. Make sure that the footswitch plug is properly connected to the SUSTAIN jack before turning on the power.
The sound of the voice changes from note to note.	This is normal. The AWM tone generation method uses multiple recordings (samples) of an instrument across the range of the keyboard; thus, the actual sound of the voice may be slightly different from note to note.
The wrong notes sound when the keyboard is played.	Perhaps the performance assistant technology is turned on. Press the [PERFORMANCE ASSISTANT] button to turn it off.
The ACMP ON indicator does not appear when the [ACMP ON/OFF] button is pressed.	Is the [STYLE] button lit? Always press the [STYLE] button first when you are going to use any style-related function.
There is no harmony sound.	The harmony effects (01–26) behave differently according to their type. Types 01–05 function when style playback is on, chords are played in the accompaniment range of the keyboard, and a melody is played in the right-hand range. Types 06–26 will function whether style playback is on or off. For types 06 = 12 you need to play two notes at the same time.



Scores

This demo is an example of how the Easy Song Arranger can be used to change styles throughout a piece.

Song No. 9

♩ = 123

(Function Demo for Easy Song Arranger)

Hallelujah Chorus

Intro **A** D G/D D

Melody

Style Progression <Clubdance> **Main** **Fill** 1st time **Main** 2nd time <Hard Rock> **Main**

D G/D D G/D D G/D D A7 D A D/A A

5/23

Fill **Main**

Fill **Main**

A D/A A D/A A D/A A D A/C# E7/B A **B**A A/G

9/27

Fill <Disco Philly> **Main**

Fill <Rumba Flamenco> **Main**

D/F# Bm7 E7sus4 E7 A D/A A D/A A D/A A D/A A

13/31

Fill <Bluegrass> **Main** **Fill**

17/35

D D/C G/B Em7 A7sus4 A7 D G/D D G/D D

Main

<Tango> Main Fill Main

21/39

G/D D G/D D C^D_{8va} G/D D D G/D D

Fill

<Dream Dance> Main

42

G/D D G/D D A7 D D

(8va)

10

Fill Ending

This score is provided with the intent that the pitch will be corrected by the performance assistant technology feature. If you play the “Play These Notes” part using the performance assistant technology feature, the part will be corrected and played so that it matches the backing part.

Song No. 10

♩ = 61

(Function Demo for performance assistant technology)

Ave Maria

Melody

Play These Notes

P.A.T. Chord Symbols

These Notes Will Sound

Turn **P.A.T.** ON
Type = CHORD

5

Your Turn.

Repeatedly Play the Same Key.

C + Dm7/C + G7/B + C

9

Am/C + D7/C + G/B + CM7/B

13

Am7 + D7 + G

This score is provided with the intent that the pitch will be corrected by the performance assistant technology feature. If you play the “Play These Notes” part using the performance assistant technology feature, the part will be corrected and played so that it matches the backing part.

Song No. 11

♩ = 108

(Function Demo for performance assistant technology)

Nocturne op.9-2

Turn **(P.A.T.)** ON
Type = CHORD
2nd time only

Melody

Play These Notes

P.A.T. Chord Symbols

These Left-hand Notes Will Sound

9/25

You Can Even Play the Same Keys!

F + B^bm/F + F + Am/E + D7

14/30

D7 + Am^b5/G + Gm + C7 + A7/C[#]

19/35

Dm Bdim7 C7sus4 C7

23

1. 2.

F F F F F

42

rit.

F F F F F



Voice List

■ Maximum Polyphony.....

The instrument has 32-note maximum polyphony. This means that it can play a maximum of up to 32 notes at once, regardless of what functions are used. Auto accompaniment uses a number of the available notes, so when auto accompaniment is used the total number of available notes for playing on the keyboard is correspondingly reduced. The same applies to the Split Voice and Song functions. If the maximum polyphony is exceeded, earlier played notes will be cut off and the most recent notes have priority (last note priority).

NOTE

- The Voice List includes MIDI program change numbers for each voice. Use these program change numbers when playing the instrument via MIDI from an external device.
- Program change numbers are often specified as numbers "0-127." Since this list uses a "1-128" numbering system, in such cases it is necessary to subtract 1 from the transmitted program change numbers to select the appropriate sound: e.g. to select No. 2 in the list, transmit program change number 1.
- Some voices may sound continuously or have a long decay after the notes have been released while the sustain pedal (footswitch) is held.

● Panel Voice List

Voice No.	Bank Select		MIDI Program Change# (1-128)	Voice Name
	MSB (0-127)	LSB (0-127)		
PIANO				
1	0	112	1	Grand Piano
2	0	112	2	Bright Piano
3	0	112	7	Harpichord
4	0	112	4	Honky-tonk Piano
5	0	112	3	MIDI Grand Piano
6	0	113	3	CP 80
E.PIANO				
7	0	114	5	Cool! Galaxy Electric Piano
8	0	113	6	Hyper Tines
9	0	112	5	Funky Electric Piano
10	0	112	6	DX Modern Electric Piano
11	0	114	6	Venus Electric Piano
12	0	112	8	Clavi
ORGAN				
13	0	118	19	Cool! Organ
14	0	117	19	Cool! Rotor Organ
15	0	112	17	Jazz Organ 1
16	0	113	17	Jazz Organ 2
17	0	112	19	Rock Organ
18	0	114	19	Purple Organ
19	0	112	18	Click Organ
20	0	116	17	Bright Organ
21	0	127	19	Theater Organ
22	0	121	20	16'+2' Organ
23	0	120	20	16'+4' Organ
24	0	113	20	Chapel Organ
25	0	112	20	Church Organ
26	0	112	21	Reed Organ
ACCORDION				
27	0	112	22	Musette Accordion
28	0	113	22	Traditional Accordion
29	0	113	24	Bandoneon
30	0	113	23	Modern Harp
31	0	112	23	Harmonica
GUITAR				
32	0	112	25	Classical Guitar
33	0	112	26	Folk Guitar
34	0	112	27	Jazz Guitar
35	0	117	28	60's Clean Guitar
36	0	113	26	12Strings Guitar
37	0	112	28	Clean Guitar
38	0	113	27	Octave Guitar
39	0	112	29	Muted Guitar
40	0	112	30	Overdriven Guitar
41	0	112	31	Distortion Guitar
BASS				
42	0	112	34	Finger Bass
43	0	112	33	Acoustic Bass
44	0	112	35	Pick Bass
45	0	112	36	Fretless Bass
46	0	112	37	Slap Bass
47	0	112	39	Synth Bass
48	0	113	39	Hi-Q Bass
49	0	113	40	Dance Bass

Voice No.	Bank Select		MIDI Program Change# (1-128)	Voice Name
	MSB (0-127)	LSB (0-127)		
STRINGS				
50	0	112	49	String Ensemble
51	0	112	50	Chamber Strings
52	0	113	50	Slow Strings
53	0	112	45	Tremolo Strings
54	0	112	51	Synth Strings
55	0	112	46	Pizzicato Strings
56	0	112	41	Violin
57	0	112	43	Cello
58	0	112	44	Contrabass
59	0	112	47	Harp
60	0	112	106	Banjo
61	0	112	56	Orchestra Hit
CHOIR				
62	0	112	53	Choir
63	0	113	53	Vocal Ensemble
64	0	112	55	Air Choir
65	0	112	54	Vox Humana
SAXOPHONE				
66	0	117	67	Sweet! Tenor Sax
67	0	113	65	Sweet! Soprano Sax
68	0	112	67	Tenor Sax
69	0	112	66	Alto Sax
70	0	112	65	Soprano Sax
71	0	112	68	Baritone Sax
72	0	114	67	Breathy Tenor Sax
73	0	112	72	Clarinet
74	0	112	69	Oboe
75	0	112	70	English Horn
76	0	112	71	Bassoon
TRUMPET				
77	0	115	57	Sweet! Trumpet
78	0	112	57	Trumpet
79	0	112	58	Trombone
80	0	113	58	Trombone Section
81	0	112	60	Muted Trumpet
82	0	112	61	French Horn
83	0	112	59	Tuba
BRASS				
84	0	112	62	Brass Section
85	0	113	62	Big Band Brass
86	0	113	63	80's Brass
87	0	119	62	Mellow Horns
88	0	114	63	Techno Brass
89	0	112	63	Synth Brass
FLUTE				
90	0	114	74	Sweet! Flute
91	0	113	76	Sweet! Pan Flute
92	0	112	74	Flute
93	0	112	73	Piccolo
94	0	112	76	Pan Flute
95	0	112	75	Recorder
96	0	112	80	Ocarina
SYNTH LEAD				
97	0	112	81	Square Lead
98	0	112	82	Sawtooth Lead

Voice No.	Bank Select		MIDI Program Change# (1-128)	Voice Name
	MSB (0-127)	LSB (0-127)		
99	0	115	82	Analogon
100	0	119	82	Fargo
101	0	112	99	Star Dust
102	0	112	86	Voice Lead
103	0	112	101	Brightness
SYNTH PAD				
104	0	112	92	Xenon Pad
105	0	112	95	Equinox
106	0	112	89	Fantasia
107	0	113	90	Dark Moon
108	0	113	101	Bell Pad
PERCUSSION				
109	0	112	12	Vibraphone
110	0	112	13	Marimba
111	0	112	14	Xylophone
112	0	112	115	Steel Drums
113	0	112	9	Celesta
114	0	112	11	Music Box
115	0	112	15	Tubular Bells
116	0	112	48	Timpani
DRUM KITS				
117	127	0	1	Standard Kit 1
118	127	0	2	Standard Kit 2
119	127	0	9	Room Kit
120	127	0	17	Rock Kit
121	127	0	25	Electronic Kit
122	127	0	26	Analog Kit
123	127	0	113	Dance Kit
124	127	0	33	Jazz Kit
125	127	0	41	Brush Kit
126	127	0	49	Symphony Kit
127	126	0	1	SFX Kit 1
128	126	0	2	SFX Kit 2
ARPEGGIO				
129	0	112	49	Concerto
130	0	112	46	Pizzicato
131	0	112	1	Piano Ballad
132	0	96	82	Synth Sequence
133	0	117	28	Guitarist
134	0	112	37	Pauls Bass
135	0	113	39	Trance Bass
136	0	6	82	SynthChords
137	0	113	39	Acid Bass
138	0	112	8	Funky Clavi
139	0	112	18	ReggaeOrgan
140	0	112	47	Harpeggio
141	0	112	2	SalsaPiano
142	0	115	82	AnalogSequence
143	0	6	82	Sawtooth
144	0	112	1	Piano Arpeggio
145	0	112	25	Guitar Arpeggio
146	127	0	113	ClubBeat
147	127	0	1	R&B Loop
148	127	0	113	ClubAdds

● XGlite Voice/XGlite Optional Voice* List

Voice No.	Bank Select		MIDI Program Change# (1-128)	Voice Name
	MSB (0-127)	LSB (0-127)		
PIANO				
149	0	0	1	Grand Piano
150	0	1	1	Grand Piano KSP
151	0	40	1	Piano Strings
152	0	41	1	Dream
153	0	0	2	Bright Piano
154	0	1	2	Bright Piano KSP
155	0	0	3	Electric Grand Piano
156	0	1	3	Electric Grand Piano KSP
157	0	32	3	Detuned CP80
158	0	0	4	Honky-tonk Piano
159	0	1	4	Honky-tonk Piano KSP
160	0	0	5	Electric Piano 1

Voice No.	Bank Select		MIDI Program Change# (1-128)	Voice Name
	MSB (0-127)	LSB (0-127)		
161	0	1	5	Electric Piano 1 KSP
162	0	32	5	Chorus Electric Piano 1
163	0	0	6	Electric Piano 2
164	0	1	6	Electric Piano 2 KSP
*165	0	32	6	Chorus Electric Piano 2
166	0	41	6	DX + Analog Electric Piano
167	0	0	7	Harpsichord
168	0	1	7	Harpsichord KSP
169	0	35	7	Harpsichord 2
170	0	0	8	Clavi
171	0	1	8	Clavi KSP
CHROMATIC				
172	0	0	9	Celesta
173	0	0	10	Glockenspiel
174	0	0	11	Music Box
175	0	64	11	Orgel
176	0	0	12	Vibraphone
177	0	1	12	Vibraphone KSP
178	0	0	13	Marimba
179	0	1	13	Marimba KSP
180	0	64	13	Sine Marimba
181	0	97	13	Balimba
182	0	98	13	Log Drums
183	0	0	14	Xylophone
184	0	0	15	Tubular Bells
185	0	96	15	Church Bells
186	0	97	15	Carillon
187	0	0	16	Dulcimer
188	0	35	16	Dulcimer 2
189	0	96	16	Cimbalom
190	0	97	16	Santur
ORGAN				
191	0	0	17	Drawbar Organ
192	0	32	17	Detuned Drawbar Organ
193	0	33	17	60's Drawbar Organ 1
194	0	34	17	60's Drawbar Organ 2
195	0	35	17	70's Drawbar Organ 1
196	0	37	17	60's Drawbar Organ 3
197	0	40	17	16+2'2/3
198	0	64	17	Organ Bass
199	0	65	17	70's Drawbar Organ 2
200	0	66	17	Cheezy Organ
201	0	67	17	Drawbar Organ 2
202	0	0	18	Percussive Organ
203	0	24	18	70's Percussive Organ
204	0	32	18	Detuned Percussive Organ
205	0	33	18	Light Organ
206	0	37	18	Percussive Organ 2
207	0	0	19	Rock Organ
208	0	64	19	Rotary Organ
209	0	65	19	Slow Rotary
210	0	66	19	Fast Rotary
211	0	0	20	Church Organ
212	0	32	20	Church Organ 3
213	0	35	20	Church Organ 2
214	0	40	20	Notre Dame
215	0	64	20	Organ Flute
216	0	65	20	Tremolo Organ Flute
217	0	0	21	Reed Organ
218	0	40	21	Puff Organ
219	0	0	22	Accordion
220	0	0	23	Harmonica
221	0	32	23	Harmonica 2
222	0	0	24	Tango Accordion
223	0	64	24	Tango Accordion 2
GUITAR				
224	0	0	25	Nylon Guitar
225	0	43	25	Velocity Guitar Harmonics
226	0	96	25	Ukulele
227	0	0	26	Steel Guitar
228	0	35	26	12-string Guitar
229	0	40	26	Nylon & Steel Guitar
230	0	41	26	Steel Guitar with Body Sound
231	0	96	26	Mandolin

Voice List

Voice No.	Bank Select		MIDI Program Change# (1-128)	Voice Name
	MSB (0-127)	LSB (0-127)		
232	0	0	27	Jazz Guitar
233	0	32	27	Jazz Amp
234	0	0	28	Clean Guitar
235	0	32	28	Chorus Guitar
236	0	0	29	Muted Guitar
237	0	40	29	Funk Guitar
238	0	41	29	Muted Steel Guitar
239	0	45	29	Jazz Man
240	0	0	30	Overdriven Guitar
241	0	43	30	Guitar Pinch
242	0	0	31	Distortion Guitar
243	0	40	31	Feedback Guitar
244	0	41	31	Feedback Guitar 2
245	0	0	32	Guitar Harmonics
246	0	65	32	Guitar Feedback
247	0	66	32	Guitar Harmonics 2
BASS				
248	0	0	33	Acoustic Bass
249	0	40	33	Jazz Rhythm
250	0	45	33	Velocity Crossfade Upright Bass
251	0	0	34	Finger Bass
252	0	18	34	Finger Dark
253	0	40	34	Bass & Distorted Electric Guitar
254	0	43	34	Finger Slap Bass
255	0	45	34	Finger Bass 2
256	0	65	34	Modulated Bass
257	0	0	35	Pick Bass
258	0	28	35	Muted Pick Bass
259	0	0	36	Fretless Bass
260	0	32	36	Fretless Bass 2
261	0	33	36	Fretless Bass 3
262	0	34	36	Fretless Bass 4
263	0	0	37	Slap Bass 1
264	0	32	37	Punch Thumb Bass
265	0	0	38	Slap Bass 2
266	0	43	38	Velocity Switch Slap
267	0	0	39	Synth Bass 1
268	0	40	39	Techno Synth Bass
269	0	0	40	Synth Bass 2
270	0	6	40	Mellow Synth Bass
271	0	12	40	Sequenced Bass
272	0	18	40	Click Synth Bass
273	0	19	40	Synth Bass 2 Dark
*274	0	40	40	Modular Synth Bass
275	0	41	40	DX Bass
STRINGS				
276	0	0	41	Violin
277	0	8	41	Slow Violin
278	0	0	42	Viola
279	0	0	43	Cello
280	0	0	44	Contrabass
281	0	0	45	Tremolo Strings
282	0	8	45	Slow Tremolo Strings
283	0	40	45	Suspense Strings
284	0	0	46	Pizzicato Strings
285	0	0	47	Orchestral Harp
286	0	40	47	Yang Chin
287	0	0	48	Timpani
ENSEMBLE				
288	0	0	49	Strings 1
289	0	3	49	Stereo Strings
290	0	8	49	Slow Strings
291	0	35	49	60's Strings
292	0	40	49	Orchestra
293	0	41	49	Orchestra 2
294	0	42	49	Tremolo Orchestra
295	0	45	49	Velocity Strings
296	0	0	50	Strings 2
297	0	3	50	Stereo Slow Strings
298	0	8	50	Legato Strings
299	0	40	50	Warm Strings
300	0	41	50	Kingdom
301	0	0	51	Synth Strings 1

Voice No.	Bank Select		MIDI Program Change# (1-128)	Voice Name
	MSB (0-127)	LSB (0-127)		
302	0	0	52	Synth Strings 2
303	0	0	53	Choir Aahs
304	0	3	53	Stereo Choir
305	0	32	53	Mellow Choir
306	0	40	53	Choir Strings
307	0	0	54	Voice Oohs
308	0	0	55	Synth Voice
309	0	40	55	Synth Voice 2
310	0	41	55	Choral
311	0	64	55	Analog Voice
312	0	0	56	Orchestra Hit
313	0	35	56	Orchestra Hit 2
314	0	64	56	Impact
BRASS				
315	0	0	57	Trumpet
316	0	32	57	Warm Trumpet
317	0	0	58	Trombone
318	0	18	58	Trombone 2
319	0	0	59	Tuba
320	0	0	60	Muted Trumpet
321	0	0	61	French Horn
322	0	6	61	French Horn Solo
323	0	32	61	French Horn 2
324	0	37	61	Horn Orchestra
325	0	0	62	Brass Section
326	0	35	62	Trumpet & Trombone Section
327	0	0	63	Synth Brass 1
328	0	20	63	Resonant Synth Brass
329	0	0	64	Synth Brass 2
330	0	18	64	Soft Brass
331	0	41	64	Choir Brass
REED				
332	0	0	65	Soprano Sax
333	0	0	66	Alto Sax
334	0	40	66	Sax Section
335	0	0	67	Tenor Sax
336	0	40	67	Breathy Tenor Sax
337	0	0	68	Baritone Sax
338	0	0	69	Oboe
339	0	0	70	English Horn
340	0	0	71	Bassoon
341	0	0	72	Clarinet
PIPE				
342	0	0	73	Piccolo
343	0	0	74	Flute
344	0	0	75	Recorder
345	0	0	76	Pan Flute
346	0	0	77	Blown Bottle
347	0	0	78	Shakuhachi
348	0	0	79	Whistle
349	0	0	80	Ocarina
SYNTH LEAD				
350	0	0	81	Square Lead
351	0	6	81	Square Lead 2
352	0	8	81	LM Square
353	0	18	81	Hollow
354	0	19	81	Shroud
355	0	64	81	Mellow
356	0	65	81	Solo Sine
357	0	66	81	Sine Lead
358	0	0	82	Sawtooth Lead
359	0	6	82	Sawtooth Lead 2
360	0	8	82	Thick Sawtooth
361	0	18	82	Dynamic Sawtooth
362	0	19	82	Digital Sawtooth
363	0	20	82	Big Lead
364	0	96	82	Sequenced Analog
365	0	0	83	Calliope Lead
366	0	65	83	Pure Lead
367	0	0	84	Chiff Lead
368	0	0	85	Charang Lead
369	0	64	85	Distorted Lead
370	0	0	86	Voice Lead

Voice No.	Bank Select		MIDI Program Change# (1-128)	Voice Name
	MSB (0-127)	LSB (0-127)		
371	0	0	87	Fifths Lead
372	0	35	87	Big Five
373	0	0	88	Bass & Lead
374	0	16	88	Big & Low
375	0	64	88	Fat & Perky
376	0	65	88	Soft Whirl
SYNTH PAD				
377	0	0	89	New Age Pad
378	0	64	89	Fantasy
379	0	0	90	Warm Pad
380	0	0	91	Poly Synth Pad
381	0	0	92	Choir Pad
382	0	66	92	Itopia
383	0	0	93	Bowed Pad
384	0	0	94	Metallic Pad
385	0	0	95	Halo Pad
386	0	0	96	Sweep Pad
SYNTH EFFECTS				
387	0	0	97	Rain
388	0	65	97	African Wind
389	0	66	97	Carib
390	0	0	98	Sound Track
391	0	27	98	Prologue
392	0	0	99	Crystal
393	0	12	99	Synth Drum Comp
394	0	14	99	Popcorn
395	0	18	99	Tiny Bells
396	0	35	99	Round Glockenspiel
397	0	40	99	Glockenspiel Chimes
398	0	41	99	Clear Bells
399	0	42	99	Chorus Bells
400	0	65	99	Soft Crystal
401	0	70	99	Air Bells
402	0	71	99	Bell Harp
403	0	72	99	Gamelimba
404	0	0	100	Atmosphere
405	0	18	100	Warm Atmosphere
406	0	19	100	Hollow Release
407	0	40	100	Nylon Electric Piano
408	0	64	100	Nylon Harp
409	0	65	100	Harp Vox
410	0	66	100	Atmosphere Pad
411	0	0	101	Brightness
412	0	0	102	Goblins
413	0	64	102	Goblins Synth
414	0	65	102	Creeper
415	0	67	102	Ritual
416	0	68	102	To Heaven
417	0	70	102	Night
418	0	71	102	Glisten
419	0	96	102	Bell Choir
420	0	0	103	Echoes
421	0	0	104	Sci-Fi
WORLD				
422	0	0	105	Sitar
423	0	32	105	Detuned Sitar
424	0	35	105	Sitar 2
425	0	97	105	Tamboura
426	0	0	106	Banjo
427	0	28	106	Muted Banjo
428	0	96	106	Rabab
429	0	97	106	Gopichant
430	0	98	106	Oud
431	0	0	107	Shamisen
432	0	0	108	Koto
433	0	96	108	Taisho-kin
434	0	97	108	Kanoon
435	0	0	109	Kalimba
436	0	0	110	Bagpipe
437	0	0	111	Fiddle
438	0	0	112	Shanai
PERCUSSIVE				
439	0	0	113	Tinkle Bell

Voice No.	Bank Select		MIDI Program Change# (1-128)	Voice Name
	MSB (0-127)	LSB (0-127)		
440	0	96	113	Bonang
441	0	97	113	Altair
442	0	98	113	Gamelan Gongs
443	0	99	113	Stereo Gamelan Gongs
444	0	100	113	Rama Cymbal
445	0	0	114	Agogo
446	0	0	115	Steel Drums
447	0	97	115	Glass Percussion
448	0	98	115	Thai Bells
449	0	0	116	Woodblock
450	0	96	116	Castanets
451	0	0	117	Taiko Drum
452	0	96	117	Gran Cassa
453	0	0	118	Melodic Tom
454	0	64	118	Melodic Tom 2
455	0	65	118	Real Tom
456	0	66	118	Rock Tom
457	0	0	119	Synth Drum
458	0	64	119	Analog Tom
459	0	65	119	Electronic Percussion
460	0	0	120	Reverse Cymbal
SOUND EFFECTS				
461	0	0	121	Fret Noise
462	0	0	122	Breath Noise
463	0	0	123	Seashore
464	0	0	124	Bird Tweet
465	0	0	125	Telephone Ring
466	0	0	126	Helicopter
467	0	0	127	Applause
468	0	0	128	Gunshot
469	64	0	1	Cutting Noise
470	64	0	2	Cutting Noise 2
471	64	0	4	String Slap
472	64	0	17	Flute Key Click
473	64	0	33	Shower
474	64	0	34	Thunder
475	64	0	35	Wind
476	64	0	36	Stream
477	64	0	37	Bubble
478	64	0	38	Feed
479	64	0	49	Dog
480	64	0	50	Horse
481	64	0	51	Bird Tweet 2
482	64	0	56	Maou
483	64	0	65	Phone Call
484	64	0	66	Door Squeak
485	64	0	67	Door Slam
486	64	0	68	Scratch Cut
487	64	0	69	Scratch Split
488	64	0	70	Wind Chime
489	64	0	71	Telephone Ring 2
490	64	0	81	Car Engine Ignition
491	64	0	82	Car Tires Squeal
492	64	0	83	Car Passing
493	64	0	84	Car Crash
494	64	0	85	Siren
495	64	0	86	Train
496	64	0	87	Jet Plane
497	64	0	88	Starship
498	64	0	89	Burst
499	64	0	90	Roller Coaster
500	64	0	91	Submarine
501	64	0	97	Laugh
502	64	0	98	Scream
503	64	0	99	Punch
504	64	0	100	Heartbeat
505	64	0	101	Footsteps
506	64	0	113	Machine Gun
507	64	0	114	Laser Gun
508	64	0	115	Explosion
509	64	0	116	Firework

The voice number with an asterisk (*) is XGlite optional voice.



Drum Kit List

- “ ” indicates that the drum sound is the same as “Standard Kit 1”.
- Each percussion voice uses one note.
- The MIDI Note # and Note are actually one octave lower than keyboard Note # and Note. For example, in “117: Standard Kit 1”, the “Seq Click H” (Note# 36/Note C1) corresponds to (Note# 24/Note C0).
- Key Off: Keys marked “O” stop sounding the instant they are released.
- Voices with the same Alternate Note Number (*1 ... 4) cannot be played simultaneously. (They are designed to be played alternately with each other.)

	Voice No.						117	118	119	120	121	122						
	MSB (0-127) / LSB (0-127) / PC (1-128)												127/000/001	127/000/002	127/000/009	127/000/017	127/000/025	127/000/026
	Keyboard		MIDI		Key Off	Alternate assign							Standard Kit 1	Standard Kit 2	Room Kit	Rock Kit	Electronic Kit	Analog Kit
Note#	Note	Note#	Note															
	25	C# 0	13	C# -1		3	Surdo Mute											
	26	D 0	14	D -1		3	Surdo Open											
	27	D# 0	15	D# -1			Hi Q											
	28	E 0	16	E -1			Whip Slap											
	29	F 0	17	F -1		4	Scratch H											
	30	F# 0	18	F# -1		4	Scratch L											
	31	G 0	19	G -1			Finger Snap											
	32	G# 0	20	G# -1			Click Noise											
	33	A 0	21	A -1			Metronome Click											
	34	A# 0	22	A# -1			Metronome Bell											
	35	B 0	23	B -1			Seq Click L											
	36	C 1	24	C 0			Seq Click H											
	37	C# 1	25	C# 0			Brush Tap											
	38	D 1	26	D 0	O		Brush Swirl											
	39	D# 1	27	D# 0			Brush Slap											
	40	E 1	28	E 0	O		Brush Tap Swirl				Reverse Cymbal	Reverse Cymbal						
	41	F 1	29	F 0	O		Snare Roll	Snare Roll 2										
	42	F# 1	30	F# 0			Castanet				Hi Q 2	Hi Q 2						
	43	G 1	31	G 0			Snare Soft	Snare Soft 2		Snare Noisy	Snare Snappy Electro	Snare Noisy 4						
	44	G# 1	32	G# 0			Sticks											
	45	A 1	33	A 0			Kick Soft			Kick Tight 2	Kick 3	Kick Tight 2						
	46	A# 1	34	A# 0			Open Rim Shot	Open Rim Shot H Short										
	47	B 1	35	B 0			Kick Tight	Kick Tight Short		Kick 2	Kick Gate	Kick Analog Short						
	48	C 2	36	C 1			Kick	Kick Short		Kick Gate	Kick Gate Heavy	Kick Analog						
	49	C# 2	37	C# 1			Side Stick					Side Stick Analog						
	50	D 2	38	D 1			Snare	Snare Short	Snare Snappy	Snare Rock	Snare Noisy 2	Snare Analog						
	51	D# 2	39	D# 1			Hand Clap											
	52	E 2	40	E 1			Snare Tight	Snare Tight H	Snare Tight Snappy	Snare Rock Rim	Snare Noisy 3	Snare Analog 2						
	53	F 2	41	F 1			Floor Tom L		Tom Room 1	Tom Rock 1	Tom Electro 1	Tom Analog 1						
	54	F# 2	42	F# 1		1	Hi-Hat Closed					Hi-Hat Closed Analog						
	55	G 2	43	G 1			Floor Tom H		Tom Room 2	Tom Rock 2	Tom Electro 2	Tom Analog 2						
	56	G# 2	44	G# 1		1	Hi-Hat Pedal					Hi-Hat Closed Analog 2						
	57	A 2	45	A 1			Low Tom		Tom Room 3	Tom Rock 3	Tom Electro 3	Tom Analog 3						
	58	A# 2	46	A# 1		1	Hi-Hat Open					Hi-Hat Open Analog						
	59	B 2	47	B 1			Mid Tom L		Tom Room 4	Tom Rock 4	Tom Electro 4	Tom Analog 4						
	60	C 3	48	C 2			Mid Tom H		Tom Room 5	Tom Rock 5	Tom Electro 5	Tom Analog 5						
	61	C# 3	49	C# 2			Crash Cymbal 1					Crash Analog						
	62	D 3	50	D 2			High Tom		Tom Room 6	Tom Rock 6	Tom Electro 6	Tom Analog 6						
	63	D# 3	51	D# 2			Ride Cymbal 1											
	64	E 3	52	E 2			Chinese Cymbal											
	65	F 3	53	F 2			Ride Cymbal Cup											
	66	F# 3	54	F# 2			Tambourine											
	67	G 3	55	G 2			Splash Cymbal											
	68	G# 3	56	G# 2			Cowbell					Cowbell Analog						
	69	A 3	57	A 2			Crash Cymbal 2											
	70	A# 3	58	A# 2			VibraSlap											
	71	B 3	59	B 2			Ride Cymbal 2											
	72	C 4	60	C 3			Bongo H											
	73	C# 4	61	C# 3			Bongo L											
	74	D 4	62	D 3			Conga H Mute					Conga Analog H						
	75	D# 4	63	D# 3			Conga H Open					Conga Analog M						
	76	E 4	64	E 3			Conga L					Conga Analog L						
	77	F 4	65	F 3			Timbale H											
	78	F# 4	66	F# 3			Timbale L											
	79	G 4	67	G 3			Agogo H											
	80	G# 4	68	G# 3			Agogo L											
	81	A 4	69	A 3			Cabasa											
	82	A# 4	70	A# 3			Maracas					Maracas 2						
	83	B 4	71	B 3	O		Samba Whistle H											
	84	C 5	72	C 4	O		Samba Whistle L											
	85	C# 5	73	C# 4			Guiro Short											
	86	D 5	74	D 4	O		Guiro Long											
	87	D# 5	75	D# 4			Claves					Claves 2						
	88	E 5	76	E 4			Wood Block H											
	89	F 5	77	F 4			Wood Block L											
	90	F# 5	78	F# 4			Cuica Mute			Scratch H 2		Scratch H 2						
	91	G 5	79	G 4			Cuica Open			Scratch L 2		Scratch L 3						
	92	G# 5	80	G# 4		2	Triangle Mute											
	93	A 5	81	A 4		2	Triangle Open											
	94	A# 5	82	A# 4			Shaker											
	95	B 5	83	B 4			Jingle Bells											
	96	C 6	84	C 5			Bell Tree											
	97	C# 6	85	C# 5														
	98	D 6	86	D 5														
	99	D# 6	87	D# 5														
	100	E 6	88	E 5														
	101	F 6	89	F 5														
	102	F# 6	90	F# 5														
	103	G 6	91	G 5														



Style List

Style No.	Style Name
8BEAT	
1	BritRock
2	8BtModrn
3	Cool 8Bt
4	60sGtPop
5	8BtAdria
6	60s8Beat
7	BblgumPp
8	BritPpSw
9	8Beat
10	Off Beat
11	60s Rock
12	HardRock
13	RockShfl
14	8Bt Rock
16BEAT	
15	16Beat
16	PopShf 1
17	PopShf 2
18	Gtr Pop
19	16Bt Up
20	KoolShfl
21	JazzRock
22	HH Light
BALLAD	
23	PianoBld
24	LoveSong
25	68Modern
26	68SlowRk
27	68OrcBld
28	OrganBld
29	Pop Bld
30	16Bld 1
31	16Bld 2
DANCE	
32	ClubBeat
33	Electron
34	FunkyHse
35	ChartR&B
36	MellowHH
37	SoulR&B
38	Chillout
39	EuTrance
40	Ibiza
41	DreamDnc
42	NewHipHp
43	Pop R&B
44	TrancPop
45	ChartPop
46	HouseMsk
47	Swing H
48	TcnPolis
49	Clubdanc
50	Club Ltn
51	Garage 1
52	Garage 2
53	TcnParty
54	UK Pop
55	HHGroove
56	Hip Shfl
57	HipHopPp

Style No.	Style Name
DISCO	
58	ModDisco
59	70sDsc 1
60	70sDsc 2
61	LatinDsc
62	DscPhily
63	SatNight
64	DscChoco
65	DscHands
SWING&JAZZ	
66	BB Fast
67	BBMedium
68	BBBallad
69	BB Shfl
70	AcidJazz
71	JazzClub
72	Swing 1
73	Swing 2
74	OrchSwng
75	FiveFour
76	Jazz Bld
77	Dixie
78	Ragtime
79	AfroCubn
80	Charlstn
R&B	
81	Soul
82	DetPop 1
83	60s R&R
84	6/8 Soul
85	ModrnR&B
86	CroTwist
87	Rck&Roll
88	DetPop 2
89	Boogie 1
90	Boogie 2
91	6/8Blues
COUNTRY	
92	Cntry8Bt
93	CntryPop
94	CntrySwg
95	CntryBld
96	Cntry2/4
97	CowboyBg
98	CntryShf
99	Blgrass
LATIN	
100	BrzSamba
101	Bossa
102	PopBossa
103	Tijuana
104	DscLatin
105	Mambo
106	Salsa
107	Beguine
108	GtrRumba
109	Flamenco
110	RmbIsInd
111	Reggae

Style No.	Style Name
BALLROOM	
112	VienWltz
113	EngWaltz
114	Slowfox
115	Foxtrot
116	Quickstp
117	Tango
118	Pasodobl
119	Samba
120	ChaCha
121	Rumba
122	Jive
TRAD & WORLD	
123	USMarch
124	6/8March
125	GerMarch
126	PolkaPop
127	OberPlka
128	Trntella
129	Showtune
130	Xmas Swg
131	XmasWltz
132	Reel
133	Hawaiian
134	Indi Pop
135	Bhangra
136	Garba
137	Goa Pop
138	Bhajan
WALTZ	
139	ItalyWlz
140	MriacWlz
141	Serenade
142	SwingWlz
143	Jz Wlz 1
144	Jz Wlz 2
145	CntryWlz
146	OberWltz
147	Musette
CHILDREN	
148	Learn2/4
149	Learn4/4
150	Learn6/8
151	Fun 3/4
152	Fun 4/4
PIANIST	
153	Stride
154	PnoBlS 1
155	PnoBlS 2
156	Pno Rag
157	Pno R&R
158	PnoBoogi
159	PnoJzWlz
160	PnoJzBld
161	Arpeggio
162	Musical
163	SlowRock
164	8Pno Bld
165	PnoSwing



Arpeggio List

Arpeggio No.	Arpeggio Name	Arpeggio No.	Arpeggio Name
1	UpOct	51	GuitChd2
2	DownOct	52	GuitChd3
3	UpDnOct	53	GuitArp
4	SynArp1	54	FngrPck1
5	SynArp2	55	FngrPck2
6	SynArp3	56	CleanGt
7	SynArp4	57	Slowfl
8	SyncEcho	58	Samba1
9	PulsLine	59	Samba2
10	StepLine	60	Harp1
11	Random	61	Harp2
12	Down&Up	62	FngrBass
13	SuperArp	63	CooFunk
14	AcidLine	64	SlapBass
15	TekEcho	65	AcidBas1
16	VelGruv	66	AcidBas2
17	Trance1	67	FunkyBs
18	Trance2	68	ComboJaz
19	SynChrd1	69	TranceBs
20	SynChrd2	70	LatinBs
21	Hybrid1	71	PercArp
22	Hybrid2	72	Strings1
23	Hybrid3	73	Strings2
24	Hybrid4	74	Strings3
25	PfArp1	75	StrngDwn
26	PfArp2	76	StrngUp
27	PfArp3	77	Orchestr
28	PnClub1	78	Pizz1
29	PnClub2	79	Pizz2
30	PfBallad	80	Perc1
31	PfChd8th	81	Perc2
32	EPArp	82	R&B
33	PfShfl	83	Funk1
34	PfRock	84	Funk2
35	Clavi1	85	HipHop
36	Clavi2	86	Trance
37	ChordUp	87	Dream
38	ChdDance	88	2 Step
39	Salsa1	89	Ibiza1
40	Salsa2	90	ClubHs1
41	Reggae1	91	ClubHs2
42	Reggae2	92	EuroTek
43	Reggae3	93	House
44	6/8R&B	94	Ibiza2
45	Gospel	95	Ibiza3
46	BlldEP	96	Garage
47	Strum1	97	African
48	Strum2	98	Tamb
49	Pickin	99	Latin
50	GuitChd1	100	Arabic



Music Database List

MDB No.	MDB Name
ALL TIME HITS	
1	Jude Hey
2	New UK
3	MyLoving
4	All OK
5	Buttercp
6	JustCall
7	CheepChp
8	Daddy's
9	Dance?
10	GetBack
11	GtrWheel
12	HighTide
13	IWasBorn
14	Sailing
15	BluJeans
16	Holiday
17	Imagine
18	LoveMe
19	LetItBld
20	LdyMdon
21	YelowSub
22	Marriage
23	MovinOut
24	My Shell
25	NowNever
26	DoLoveMe
27	TcktRide
28	SeeClear
29	Masachus
30	Hard Day
31	USA Pie
32	Norway
33	YesterBd
MODERN POP	
34	Watches
35	SoundMPH
36	Hold Us
37	Unfound
38	NeedSome
39	PrtMlvr
40	MoonShdw
41	NikitSng
42	Sure of
43	Off Day
44	Tell Her
45	GirlsMne
46	NeedLove
POP CLASSICS	
47	Standing
48	RainLaff
49	Sunshine
50	ForNamdo
51	ThankFor
52	ManPiano
53	CoinLane
54	LovesYou
55	Tmbourin
56	Alone
57	GldField
58	Raindrop
59	SultanSw
60	Life'sWk
61	TopWorld

MDB No.	MDB Name
62	WatchGrI
POP BALLAD	
63	WnderLnd
64	CanIStop
65	EvryTime
66	IvoryAnd
67	TheWorld
68	LovWoman
69	Dolannes
70	Madigan
71	Paradise
72	Whisper
BALLAD	
73	AllOdds
74	AtonalFl
75	Hero
76	Woman
77	RunToYou
78	LoveOfAl
79	CndleWnd
80	Cavatina
81	Cherish
82	ToLoveMe
83	YouKnow
84	Evrythng
85	EyesOfBl
86	Hello
87	BeThere
88	FlyAway
89	LoveYou
90	NeverLet
91	JustOnce
92	IfYouGo
93	SavingAl
94	InTheDrk
95	LovePwr
96	Vision
97	Beautifl
98	AllAlone
99	Opposite
100	BeHonest
101	SayYou
102	SayNthng
103	Stranger
104	OneDay
105	TheBayou
106	ThisSong
107	Distance
108	ThisWay
109	LoveGone
110	Inspiring
111	TrueColr
ROCK & ROLL	
112	ShakenUp
113	Beethovn
114	HurryLov
115	BeCruel
116	Jumping
117	Countdwn
118	SuePeggy
119	Champion
120	Jailhous
121	BlueShoe
122	Rockin24

MDB No.	MDB Name
123	Shouting
124	Rock&Rll
125	HonkyTnk
OLDIES	
126	Daydream
127	Sumertme
128	Diana's
129	Uptown
130	Apache
131	IGottIt
132	Tonight
133	MyPillow
134	NoRain
135	FlnalDance
136	Slpnlion
137	Ghetto
138	LipsLcky
139	PrettyWm
140	TikiGtr
141	TurnThre
142	Sherry
DANCE & DISCO	
143	Babylon
144	Goodbye
145	Catch22
146	DISCO
147	Survival
148	TheNavy
149	DontHide
150	Celebrat
151	LondonRU
152	10,2 Sun
153	ShakeYou
154	Believe
155	BoySumer
156	I'mSexy
157	StuffHot
SWING & JAZZ	
158	Patrol
159	Charles
160	GiveLove
161	Rhythm
162	LOVE
163	LeroyBad
164	Caraban
165	Misbehav
166	Safari
167	Smiling
168	SoWhatIs
169	TimeGone
170	TasteHny
171	Sandman
172	Tunisian
173	TwoFoot
174	MyBaby
R&B	
175	AsPlayed
176	BabyGro
177	Highwy66
178	SweetCHI
179	JustU&Me
180	ManLoves
181	OurLove
182	Wish I

MDB No.	MDB Name
COUNTRY	
183	OnTheRd
184	Breathe
185	InMyMind
186	ContryHw
187	GreenGrs
188	EverNeed
189	Lonesone
190	Lucille
191	HomeRng
192	Tennesse
LATIN	
193	Bananabt
194	DanceMng
195	DntWorry
196	Jamaica
197	FleaSpa
198	I'mPola
199	MamboJm
200	OneNote
201	PasoCani
202	SayNoMor
203	Beguine
204	Tijuana
205	Picture
ENTERTAINMENT	
206	OnTheHil
207	Barnacle
208	Califrag
209	DadClock
210	DanceLd
211	DnceFire
212	BigCntry
213	Cabaret
214	OdeToJoy
215	Mi-Re-Do
216	MyPrince
217	Necessary
218	NoBuiz
219	NoisyOld
220	Sleigh
221	RockBasy
222	Magnifiq
223	Magnfcnt
224	SilentNt
225	Nabucco
226	Standing
227	SummerPl
228	Christms
229	Favorite
230	Tubbie
231	Turkish
232	12OClock
WALTZ & TRADITIONAL	
233	Blk&Whte
234	CanCan
235	Charmain
236	Musicbox
237	Clementn
238	Doodah!
239	Dreamer
240	EnterRag
241	Birthday
242	MaryLamb

MDB No.	MDB Name
243	Donald's
244	MoonWlz
245	MoulinHt
246	Sunshine
247	PieceOf
248	GreenSlv
249	TakeFour
250	TexRose
251	ThePolka
252	Scarboro
253	Edelweis
254	AroundWd
255	Whatever
256	Yankee's
WORLD	
257	Hawaii
258	D'amor
259	EiCondor
260	GoodbyRm
261	ILandOn
262	ItalyBel
263	Cucarumb
264	Puntuali
265	Cielito
266	ItalySun
267	SantaLuc
268	Trumpetr
269	VanMass
PIANIST	
270	ItalySun
271	BeGood
272	Birdland
273	BlueRose
274	Chaie's
275	Highwy66
276	Leaves
277	Miload
278	Cabaret
279	Wonderfl
280	Imagine
281	LtleStar
282	MapleRag
283	Mi-Re-Do
284	NoBuiz
285	OhBlah
286	Charades
287	Sally's
288	Nabucco
289	SunnyStr
290	MistyFln
291	LdnBridg
292	GrndClck
293	Importnc
294	Snowman
295	Favorite
296	SongForU
297	SugerSpn
298	ThisWay
299	WenSmile
300	ZipperD



Songs Provided On the Supplied CD-ROM

File Name	Song Name	Composer
001Nutcr.mid	Danse des Mirlitons from "The Nutcracker"	P.I. Tchaikovsky
002Orphe.mid	"Orphée aux Enfers" Overture	J. Offenbach
003Slavo.mid	Slavonic Dances op.72-2	A. Dvořák
004Prima.mid	La Primavera (from Le Quattro Stagioni)	A. Vivaldi
005Medit.mid	Méditation (Thaïs)	J. Massenet
006Guill.mid	Guillaume Tell	G. Rossini
007Fruhl.mid	Frühlingslied	F. Mendelssohn
008Ungar.mid	Ungarische Tänze Nr.5	J. Brahms
009Fruhl.mid	Frühlingsstimmen	J. Strauss II
010Dolly.mid	Dolly's Dreaming and Awakening	T.Oesten
011Cande.mid	La Candeur	J.F.Burgmüller
012Arabe.mid	Arabesque	J.F.Burgmüller
013Pasto.mid	Pastorale	J.F.Burgmüller
014Petit.mid	Petite Réunion	J.F.Burgmüller
015Innoc.mid	Innocence	J.F.Burgmüller
016Progr.mid	Progrès	J.F.Burgmüller
017Taren.mid	Tarentelle	J.F.Burgmüller
018Cheva.mid	La Chevaleresque	J.F.Burgmüller
019Etude.mid	Etude op.10-3 "Chanson de l'adieu"	F.Chopin
020Marci.mid	Marcia alla Turca	L.v. Beethoven
021Turki.mid	Turkish March	W.A. Mozart
022Valse.mid	Valse op.64-1 "Petit Chien"	F.Chopin
023Menue.mid	Menuett	L. Boccherini
024Momen.mid	Moments Musicaux op.94-3	F. Schubert
025Enter.mid	The Entertainer	S. Joplin
026Prelu.mid	Prelude (Wohltemperierte Klavier 1-1)	J.S. Bach
027Violl.mid	La Violette	L.Streabbog
028Angel.mid	Angels Serenade	Traditional
029Saraf.mid	Krasnyj Sarafan	Traditional
030Ameri.mid	America the Beautiful	S.A. Ward
031Brown.mid	Little Brown Jug	Traditional
032Lomon.mid	Loch Lomond	Traditional
033Bonni.mid	My Bonnie	Traditional
034Londo.mid	Londonderry Air	Traditional
035Banjo.mid	Ring de Banjo	S.C. Foster
036Vogle.mid	Wenn ich ein Vöglein wär ?	Traditional
037Lorel.mid	Die Lorelei	F. Silcher
038Funic.mid	Funiculi Funicula	L. Denza
039Turke.mid	Turkey in the Straw	Traditional
040Camp.mid	Camptown Races	S.C. Foster
041Jingl.mid	Jingle Bells	J.S. Pierpont
042Muss.mid	Muss i denn	F. Silcher
043Liebe.mid	Liebesträume Nr.3	F. Liszt
044Jesu.mid	Jesu, Joy Of Man's Desiring	J.S. Bach
045Joy.mid	Ode to Joy	L.v. Beethoven
046Pearl.mid	Pearl Fisher	G. Bizet
047Gavot.mid	Gavotte	F.J. Gossec
048Seren.mid	Serenade/Haydn	F.J. Haydn
049Menue.mid	Menuett BWV. Anh.114	J.S. Bach
050Canon.mid	Canon in D	J. Pachelbel
051Vogel.mid	Der Vogelfänger Bin Ich Ja "Die zauberflöte"	W.A. Mozart
052Piano.mid	Piano Sonata No.14 op.27-2 "Mondschein"	L.v. Beethoven
053Surpr.mid	The "Surprise" Symphony No.94	F.J. Haydn
054WildR.mid	To a Wild Rose	E.A. MacDowell
055Chans.mid	Chanson du Toreador	G. Bizet
056Babbi.mid	O Mio Babbino Caro	G. Puccini
057RowRo.mid	Row Row Row Your Boat (DUET)	Traditional
058Smoky.mid	On Top of Old Smoky (DUET)	Traditional
059WeWis.mid	We Wish You A Merry Christmas (DUET)	Traditional
060ImMai.mid	Im Mai (DUET)	Traditional
061Chris.mid	O Christmas Tree (DUET)	Traditional
062MaryH.mid	Mary Had a Little Lamb (DUET)	Traditional
063TenLi.mid	Ten Little Indians (DUET)	S. Winner
064PopGo.mid	Pop Goes The Weasel (DUET)	Traditional
065Twink.mid	Twinkle Twinkle Little Star (DUET)	Traditional
066Close.mid	Close Your Hands, Open Your Hands (DUET)	J.J. Rousseau
067Cucko.mid	The Cuckoo (DUET)	Traditional
068Augus.mid	O du lieber Augustin (DUET)	Traditional
069Londo.mid	London Bridge (DUET)	Traditional
070Three.mid	Three Blind Mice (DUET)	Traditional

The easy song arranger can only be used with songs that include chord data.



Effect Type List

● Harmony Types

No.	Harmony Type	Description	
01	Duet	Harmony types 01–05 are pitch-based and add one-, two- or three-note harmonies to the single-note melody played in the right hand. These types sound when chords are played in the auto accompaniment range of the keyboard. These Harmony types will also work when playing songs that contain chord data.	
02	Trio		
03	Block		
04	Country		
05	Octave		
06	Trill 1/4 note		<p>Types 6–26 are rhythm-based effects and add embellishments or delayed repeats in time with the auto accompaniment. These types sound whether the auto accompaniment is on or not; however, the actual speed of the effect depends on the Tempo setting (page 27). The individual note values in each type let you synchronize the effect precisely to the rhythm. Triplet settings are also available: 1/6 = quarter-note triplets, 1/12 = eighth-note triplets, 1/24 = sixteenth-note triplets.</p> <ul style="list-style-type: none"> • The Trill effect Types (06–12) create two-note trills (alternating notes) when two notes are held. • The Tremolo effect Types (13–19) repeat all held notes (up to four). • The Echo effect Types (20–26) create delayed repeats of each note played.
07	Trill 1/6 note		
08	Trill 1/8 note		
09	Trill 1/12 note		
10	Trill 1/16 note		
11	Trill 1/24 note		
12	Trill 1/32 note		
13	Tremolo 1/4 note		
14	Tremolo 1/6 note		
15	Tremolo 1/8 note		
16	Tremolo 1/12 note		
17	Tremolo 1/16 note		
18	Tremolo 1/24 note		
19	Tremolo 1/32 note		
20	Echo 1/4 note		
21	Echo 1/6 note		
22	Echo 1/8 note		
23	Echo 1/12 note		
24	Echo 1/16 note		
25	Echo 1/24 note		
26	Echo 1/32 note		

● Reverb Types

No.	Reverb Type	Description
01–03	Hall 1–3	Concert hall reverb.
04–05	Room 1–2	Small room reverb.
06–07	Stage 1–2	Reverb for solo instruments.
08–09	Plate 1–2	Simulated steel plate reverb.
10	Off	No effect.

● Chorus Types

No.	Chorus Type	Description
01–02	Chorus 1–2	Conventional chorus program with rich, warm chorusing.
03–04	Flanger 1–2	Pronounced three-phase modulation with a slight metallic sound.
05	Off	No effect.



MIDI Implementation Chart

YAMAHA
Model PSR-E413 MIDI Implementation Chart
Date:10-OCT-2007
Version : 1.0

Function...	Transmitted	Recognized	Remarks
Basic Channel Default Changed	1 - 16 x	1 - 16 x	
Mode Default Messages Altered	3 x *****	3 x x	
Note Number : True voice	0 - 127 *****	0 - 127 0 - 127	
Velocity Note ON Note OFF	0 9nH, v=1-127 x 9nH, v=0	0 9nH, v=1-127 x	
After Touch Key's Ch's	x x	x x	
Pitch Bend	0 0-24 semi	0 0-24 semi	
Control Change	0, 32 1, 11, 84 6, 38 7, 10 64 71-74 91, 93 96-97 100-101	0 x 0 0 0 0 0 0 x 0	Bank Select Data Entry Sustain Sound Controller Effect Depth RPN Inc, Dec RPN LSB, MSB

Prog Change : True #	o 0 - 127 *****	o 0 - 127
System Exclusive	o	o
: Song Pos.	x	x
: Song Sel.	x	x
: Tune	x	x
System : Clock	o	o
Real Time: Commands	o	o
Aux :All Sound OFF	x	o (120, 126, 127)
:Reset All Cntrl	x	o (121)
:Local ON/OFF	x	o (122)
:All Notes OFF	x	o (123-125)
Mes- :Active Sense	o	o
sages:Reset	x	x

*1 Refer to #2 on page 120.

Mode 1 : OMNI ON , POLY
Mode 3 : OMNI OFF, POLY

Mode 2 : OMNI ON , MONO
Mode 4 : OMNI OFF, MONO

o : Yes
x : No



MIDI Data Format

NOTE:

1 By default (factory settings) the instrument ordinarily functions as a 16-channel multi-timbral tone generator, and incoming data does not affect the panel voices or panel settings. However, the MIDI messages listed below do affect the panel voices, auto accompaniment, and songs.

- MIDI Master Tuning
- System exclusive messages for changing the Reverb Type and Chorus Type.

2 Messages for these control change numbers cannot be transmitted from the instrument itself. However, they may be transmitted when playing the accompaniment, song or using the Harmony effect.

3 Exclusive

<GM System ON> F0H, 7EH, 7FH, 09H, 01H, F7H

- This message automatically restores all default settings for the instrument, with the exception of MIDI Master Tuning.

<MIDI Master Volume> F0H, 7FH, 7FH, 04H, 01H, II, mm, F7H

- This message allows the volume of all channels to be changed simultaneously (Universal System Exclusive).
- The values of "mm" is used for MIDI Master Volume. (Values for "II" are ignored.)

<MIDI Master Tuning> F0H, 43H, 1nH, 27H, 30H, 00H, 00H, mm, II, cc, F7H

- This message simultaneously changes the tuning value of all channels.
- The values of "mm" and "II" are used for MIDI Master Tuning.
- The default value of "mm" and "II" are 08H and 00H, respectively. Any values can be used for "n" and "cc".

<Reverb Type> F0H, 43H, 1nH, 4CH, 02H, 01H, 00H, mmH, IIH, F7H

- mm : Reverb Type MSB
 - II : Reverb Type LSB
- Refer to the Effect Map (page 120) for details.

<Chorus Type> F0H, 43H, 1nH, 4CH, 02H, 01H, 20H, mmH, IIH, F7H

- mm : Chorus Type MSB
 - II : Chorus Type LSB
- Refer to the Effect Map (page 120) for details.

4 When the accompaniment is started, an FAH message is transmitted. When accompaniment is stopped, an FCH message is transmitted. When the clock is set to External, both FAH (accompaniment start) and FCH (accompaniment stop) are recognized.

5 Local ON/OFF

<Local ON> Bn, 7A, 7F
 <Local OFF> Bn, 7A, 00
 Value for "n" is ignored.

Effect map

- * When a Type LSB value is received that corresponds to no effect type, a value corresponding to the effect type (coming the closest to the specified value) is automatically set.
- * The numbers in parentheses in front of the Effect Type names correspond to the number indicated in the display.

REVERB

TYPE MSB	TYPE LSB									
	00	01	02	08	16	17	18	19	20	
000	No Effect									
001	(01)Hall1				(02)Hall2	(03)Hall3				
002	Room					(04)Room1		(05)Room2		
003	Stage				(06)Stage1	(07)Stage2				
004	Plate				(08)Plate1	(09)Plate2				
005...127	No Effect									

CHORUS

TYPE MSB	TYPE LSB									
	00	01	02	08	16	17	18	19	20	
000...063	No Effect									
064	Thru									
065	Chorus		(02)Chorus2							
066	Celeste					(01)Chorus1				
067	Flanger			(03)Flanger1		(04)Flanger2				
068...127	No Effect									

ATTENTION

SOFTWARE LICENSE AGREEMENT

PLEASE READ THIS SOFTWARE LICENSE AGREEMENT (“AGREEMENT”) CAREFULLY BEFORE USING THIS SOFTWARE. YOU ARE ONLY PERMITTED TO USE THIS SOFTWARE PURSUANT TO THE TERMS AND CONDITIONS OF THIS AGREEMENT. THIS AGREEMENT IS BETWEEN YOU (AS AN INDIVIDUAL OR LEGAL ENTITY) AND YAMAHA CORPORATION (“YAMAHA”).

BY BREAKING THE SEAL OF THIS PACKAGE YOU ARE AGREEING TO BE BOUND BY THE TERMS OF THIS LICENSE. IF YOU DO NOT AGREE WITH THE TERMS, DO NOT INSTALL, COPY, OR OTHERWISE USE THIS SOFTWARE.

1. GRANT OF LICENSE AND COPYRIGHT

Yamaha hereby grants you the right to use one copy of the software program(s) and data (“SOFTWARE”) accompanying this Agreement. The term SOFTWARE shall encompass any updates to the accompanying software and data. The SOFTWARE is owned by Yamaha and/or Yamaha’s licensor(s), and is protected by relevant copyright laws and all applicable treaty provisions. While you are entitled to claim ownership of the data created with the use of SOFTWARE, the SOFTWARE will continue to be protected under relevant copyrights.

- **You may** use the SOFTWARE on a **single computer**.
- **You may** make one copy of the SOFTWARE in machine-readable form for backup purposes only, if the SOFTWARE is on media where such backup copy is permitted. On the backup copy, you must reproduce Yamaha’s copyright notice and any other proprietary legends that were on the original copy of the SOFTWARE.
- **You may** permanently transfer to a third party all your rights in the SOFTWARE, provided that you do not retain any copies and the recipient reads and agrees to the terms of this Agreement.

2. RESTRICTIONS

- **You may not** engage in reverse engineering, disassembly, decompilation or otherwise deriving a source code form of the SOFTWARE by any method whatsoever.
- **You may not** reproduce, modify, change, rent, lease, or distribute the SOFTWARE in whole or in part, or create derivative works of the SOFTWARE.
- **You may not** electronically transmit the SOFTWARE from one computer to another or share the SOFTWARE in a network with other computers.
- **You may not** use the SOFTWARE to distribute illegal data or data that violates public policy.
- **You may not** initiate services based on the use of the SOFTWARE without permission by Yamaha Corporation.

Copyrighted data, including but not limited to MIDI data for songs, obtained by means of the SOFTWARE, are subject to the following restrictions which you must observe.

- Data received by means of the SOFTWARE may not be used for any commercial purposes without permission of the copyright owner.
- Data received by means of the SOFTWARE may not be duplicated, transferred, or distributed, or played back or performed for listeners in public without permission of the copyright owner.
- The encryption of data received by means of the SOFTWARE may not be removed nor may the electronic watermark be modified without permission of the copyright owner.

3. TERMINATION

This Agreement becomes effective on the day that you receive the SOFTWARE and remains effective until terminated. If any copyright law or provisions of this Agreement is violated, the Agreement shall terminate automatically and immediately without notice from Yamaha. Upon such termination, you must immediately destroy the licensed SOFTWARE, any accompanying written documents and all copies thereof.

4. LIMITED WARRANTY ON MEDIA

As to SOFTWARE sold on tangible media, Yamaha warrants that the tangible media on which the SOFTWARE is recorded will be free from defects in materials and workmanship under normal use for a period of fourteen (14) days from the date of receipt, as evidenced by a copy of the receipt. Yamaha’s entire liability and your exclusive remedy will be replacement of the defective media if it is returned to Yamaha or an authorized Yamaha dealer within fourteen days with a copy of the receipt. Yamaha is not responsible for replacing media damaged by accident, abuse or misapplication. TO THE FULLEST EXTENT PERMITTED BY LAW, YAMAHA EXPRESSLY DISCLAIMS ANY IMPLIED WARRANTIES ON THE TANGIBLE MEDIA, INCLUDING THE IMPLIED WARRANTIES OF MERCHANTABILITY AND FITNESS FOR A PARTICULAR PURPOSE.

5. DISCLAIMER OF WARRANTY ON SOFTWARE

You expressly acknowledge and agree that use of the SOFTWARE is at your sole risk. The SOFTWARE and related documentation are provided “AS IS” and without warranty of any kind. NOTWITHSTANDING ANY OTHER PROVISION OF THIS AGREEMENT, YAMAHA EXPRESSLY DISCLAIMS ALL WARRANTIES AS TO THE SOFTWARE, EXPRESS, AND IMPLIED, INCLUDING BUT NOT LIMITED TO THE IMPLIED WARRANTIES OF MERCHANTABILITY, FITNESS FOR A PARTICULAR PURPOSE AND NON-INFRINGEMENT OF THIRD PARTY RIGHTS. SPECIFICALLY, BUT WITHOUT LIMITING THE FOREGOING, YAMAHA DOES NOT WARRANT THAT THE SOFTWARE WILL MEET YOUR REQUIREMENTS, THAT THE OPERATION OF THE SOFTWARE WILL BE UNINTERRUPTED OR ERROR-FREE, OR THAT DEFECTS IN THE SOFTWARE WILL BE CORRECTED.

6. LIMITATION OF LIABILITY

YAMAHA’S ENTIRE OBLIGATION HEREUNDER SHALL BE TO PERMIT USE OF THE SOFTWARE UNDER THE TERMS HEREOF. IN NO EVENT SHALL YAMAHA BE LIABLE TO YOU OR ANY OTHER PERSON FOR ANY DAMAGES, INCLUDING, WITHOUT LIMITATION, ANY DIRECT, INDIRECT, INCIDENTAL OR CONSEQUENTIAL DAMAGES, EXPENSES, LOST PROFITS, LOST DATA OR OTHER DAMAGES ARISING OUT OF THE USE, MISUSE OR INABILITY TO USE THE SOFTWARE, EVEN IF YAMAHA OR AN AUTHORIZED DEALER HAS BEEN ADVISED OF THE POSSIBILITY OF SUCH DAMAGES. In no event shall Yamaha’s total liability to you for all damages, losses and causes of action (whether in contract, tort or otherwise) exceed the amount paid for the SOFTWARE.

7. THIRD PARTY SOFTWARE

Third party software and data (“THIRD PARTY SOFTWARE”) may be attached to the SOFTWARE. If, in the written materials or the electronic data accompanying the Software, Yamaha identifies any software and data as THIRD PARTY SOFTWARE, you acknowledge and agree that you must abide by the provisions of any Agreement provided with the THIRD PARTY SOFTWARE and that the party providing the THIRD PARTY SOFTWARE is responsible for any warranty or liability related to or arising from the THIRD PARTY SOFTWARE. Yamaha is not responsible in any way for the THIRD PARTY SOFTWARE or your use thereof.

- Yamaha provides no express warranties as to the THIRD PARTY SOFTWARE. IN ADDITION, YAMAHA EXPRESSLY DISCLAIMS ALL IMPLIED WARRANTIES, INCLUDING BUT NOT LIMITED TO THE IMPLIED WARRANTIES OF MERCHANTABILITY AND FITNESS FOR A PARTICULAR PURPOSE, as to the THIRD PARTY SOFTWARE.
- Yamaha shall not provide you with any service or maintenance as to the THIRD PARTY SOFTWARE.
- Yamaha is not liable to you or any other person for any damages, including, without limitation, any direct, indirect, incidental or consequential damages, expenses, lost profits, lost data or other damages arising out of the use, misuse or inability to use the THIRD PARTY SOFTWARE.

8. GENERAL

This Agreement shall be interpreted according to and governed by Japanese law without reference to principles of conflict of laws. Any dispute or procedure shall be heard before the Tokyo District Court in Japan. If for any reason a court of competent jurisdiction finds any portion of this Agreement to be unenforceable, the remainder of this Agreement shall continue in full force and effect.

9. COMPLETE AGREEMENT

This Agreement constitutes the entire agreement between the parties with respect to use of the SOFTWARE and any accompanying written materials and supersedes all prior or contemporaneous understandings or agreements, written or oral, regarding the subject matter of this Agreement. No amendment or revision of this Agreement will be binding unless in writing and signed by a fully authorized representative of Yamaha.

SIBELIUS SCORCH LICENSE AGREEMENT

By installing and/or using this Product you (an individual or legal entity) agree with the Licensor to be bound by the terms of this License which will govern your use of the Product. If you do not accept these terms, do not install or use this Product.

The Product is copyright © 1987-2007 Sibelius Software, a division of Avid Technology, Inc, and its licensors.

1. Definitions

In this License the following words and expressions have the following meanings:

“License”: this agreement between you and the Licensor and, if permitted by the context, the conditional license granted to you in this agreement.

“Licensor”: Avid Technology, Inc., of Avid Technology Park, One Park West, Tewksbury, MA 01876 USA, through its division Sibelius Software, of 20-23 City North, Fonthill Road, London N4 3HF, UK

“Product”: the Software and the Documentation.

“Software”: the Sibelius Scorch web browser plug-in, Opus, Helsinki, Inkpen2 and Reprise font families, any other programs or files supplied by the Licensor which are included in or with the Sibelius Scorch installer, and the Sibelius Scorch installer.

“Documentation”: any documentation in any form relating to the Software supplied to you with the Software or by the Licensor.

2. License

- 2.1 The Licensor grants to you a non-exclusive non-transferable license to use this Software in accordance with the Documentation on any number of computers. Title to the Product is not transferred to you. Ownership of the Product remains vested in the Licensor and its licensors, subject to the rights granted to you under this License. All other rights are reserved.
- 2.2 You may make one printout for your own use of any part of the Documentation provided in electronic form. You shall not make or permit any third party to make any further copies of any part of the Product whether in eye or machine-readable form.
- 2.3 You shall not, and shall not cause or permit any third party to,
 - (1) translate, enhance, modify, alter or adapt the Product or any part of it for any purpose (including without limitation for the purpose of error correction);
 - (2) create derivative works based on the Product, or cause the whole or any part of the Product to be combined with or incorporated into any other program, file or product, for any purpose; or
 - (3) use the Software to create files in any format (other than temporary files created and required by your computer’s operating system or web browser), including without limitation screen capture files, files generated from the Software’s playback, graphics files and print files, for any purpose, except for creating MIDI files (if permitted by the Software) for private non-commercial use.
- 2.4 You shall not, and shall not cause or permit any third party to, decompile, decode, disassemble or reverse engineer the Software in whole or in part for any purpose.
- 2.5 You shall not, and shall not cause any third party to, translate, convert, decode or reverse engineer any file capable of being read by any copy or version of the Software or any data transmitted to or from any copy or version of the Software, in whole or in part for any purpose.
- 2.6 The Product or any part of it must not be used to infringe any right of copyright or right of privacy, publicity or personality or any other right whatsoever of any other person or entity.

3. Copyright

- 3.1 You acknowledge that copyright in the Product as a whole and in the components of the Product as between you and the Licensor belongs to the Licensor or its licensors and is protected by copyright laws, national and international, and all other applicable laws.

4. Disclaimer of Liability

- 4.1 In consideration of the fact that the Product is licensed hereunder free of charge, (a) the Licensor disclaims any and all warranties with respect to the Product, whether expressed or implied, including without limitation any warranties that the Product is free from defects, will perform in accordance with the Documentation, is merchantable, or is fit for any particular purpose, and (b) the Licensor shall not have or incur any liability to you for any loss, cost, expense or claim (including without limitation any liability for loss or corruption of data and loss of profits, revenue or goodwill and any type of special, indirect or consequential loss) that may arise out of or in connection with your installation and use of the Product.

5. Termination

- 5.1 This License shall terminate automatically upon your destruction of the Product. In addition, the Licensor may elect to terminate this License in the event of a material breach by you of any condition of this License or of any of your representations, warranties, covenants or obligations hereunder. Upon notification of such termination by the Licensor, you will immediately delete the Software from your computer and destroy the Documentation.

6. Miscellaneous

- 6.1 No failure to exercise and no delay in exercising on the part of the Licensor of any right, power or privilege arising hereunder shall operate as a waiver thereof, nor shall any single or partial exercise of any right, power or privilege preclude any other or further exercise thereof or the exercise of any other right, power or privilege. The rights and remedies of the Licensor in connection herewith are not exclusive of any rights or remedies provided by law.
- 6.2 You may not distribute, loan, lease, sub-license, rent or otherwise transfer the Product to any third party.
- 6.3 You agree to the use of your personal data in accordance with the Licensor’s privacy policy (available from the Licensor or on www.sibelius.com), which may change from time to time.
- 6.4 This License is intended by the parties hereto to be a final expression of their agreement with respect to the subject matter hereof and a complete and exclusive statement of the terms of such agreement. This License supercedes any and all prior understandings, whether written or oral, between you and the Licensor relating to the subject matter hereof.
- 6.5 (This section only applies if you are resident in the European Union:) This License shall be construed and governed by the laws of England, and both parties agree to submit to the exclusive jurisdiction of the English courts.
- 6.6 (This section only applies if you are not resident in the European Union:) This License shall be construed and enforced in accordance with and governed by the laws of the State of California. Any suit, action or proceeding arising out of or in any way related or connected to this License shall be brought and maintained only in the United States District Court for the Northern District of California, sitting in the City of San Francisco. Each party irrevocably submits to the jurisdiction of such federal court over any such suit, action or proceeding. Each party knowingly, voluntarily and irrevocably waives trial by jury in any suit, action or proceeding (including any counterclaim), whether at law or in equity, arising out of or in any way related or connected to this License or the subject matter hereof.

(License v5.0 (DMN), 30 July 2007)



Specifications

Keyboards

- 61 standard-size keys (C1–C6), with Touch Response.

Display

- LCD display (backlit)

Setup

- STANDBY/ON
- MASTER VOLUME: MIN–MAX

Panel Controls

- VOICE CONTROL: [SPLIT], [DUAL], [HARMONY], [TOUCH]
- LIVE CONTROL: [ASSIGN]
- STYLE CONTROL: [ACMP ON/OFF], [INTRO/ENDING/rit.], [MAIN/AUTO FILL], [SYNC STOP], [SYNC START], [START/STOP]
- SONG CONTROL: [↻] (REPEAT & LEARN), [A ↔ B] (A-B REPEAT), [◀◀] (REW), [▶▶] (FF), [⏏] (PAUSE), [▶/■] (START/STOP)
- REGIST MEMORY: [MEMORY/BANK], [1], [2]
- SONG MEMORY: [REC], [1]-[5], [A]
- LESSON: [START], [L], [R]
- ARPEGGIO: [ON/OFF], [TYPE]
- [DEMO/PC], [PERFORMANCE ASSISTANT], [FUNCTION], [MUSIC DATABASE], [METRONOME], [PORTABLE GRAND], [SONG], [EASY SONG ARRANGER], [STYLE], [VOICE], Dial, CATEGORY [▲]/[▼], [0]-[9], [+]/[-], [TEMPO/TAP]

Realtime Control

- Pitch Bend Wheel
- Nobs A, B
A: Cutoff, Reverb, Attack, Style Cutoff, Style Tempo
B: Resonance, Chorus, Release, Style Resonance

Voice

- 116 panel voices + 12 drum/SFX kits + 361 XGlite voices + 20 arpeggio voices
- Polyphony: 32
- DUAL
- SPLIT

Style

- 165 Preset Styles + External files
- Style Control: ACMP ON/OFF, SYNC STOP, SYNC START, START/STOP, INTRO/ENDING/rit., MAIN/AUTO FILL
- Fingering: Multi Finger
- Style Volume

Music Database

- 300 + External files

Education Feature

- Dictionary
- Lesson 1–3, Repeat & Learn

Registration Memory

- 8 banks x 2 types

Function

- VOLUME: Style Volume, Song Volume
- OVERALL: Tuning, Transpose, Split Point, Touch Sensitivity, Pitch Bend Range
- MAIN VOICE: Volume, Octave, Pan, Reverb Level, Chorus Level, Attack Time, Release Time, Filter Cutoff, Filter Resonance
- DUAL VOICE: Voice, Volume, Octave, Pan, Reverb Level, Chorus Level, Attack Time, Release Time, Filter Cutoff, Filter Resonance
- SPLIT VOICE: Voice, Volume, Octave, Pan, Reverb Level, Chorus Level, Attack Time, Release Time, Filter Cutoff, Filter Resonance
- EFFECT: Reverb Type, Chorus Type, Master EQ Type
- HARMONY: Harmony Type, Harmony Volume
- ARPEGGIO: Arpeggio Type, Arpeggio Velocity
- SFF Load: Style File Load
- PC: PC Mode
- MIDI: Local On/Off, External Clock, Initial Send, Keyboard Out, Style Out, Song Out
- METRONOME: Time Signature Numerator, Time Signature Denominator, Metronome Volume
- LESSON: Lesson Track (R), Lesson Track (L)
- UTILITY: Grade, Demo Cancel, Sleep

Effects

- Reverb: 9 types
- Chorus: 4 types
- Harmony: 26 types
- Arpeggio: 100 types

Song

- 30 Preset Songs + 5 User Songs + Accessory CD-ROM Songs (70)
- Song Clear, Track Clear
- Song Volume
- Song Control: REPEAT & LEARN, A-B REPEAT, PAUSE, REW, FF, START/STOP

Performance assistant technology

Recording

- Song
User Song: 5 Songs
Recording Tracks: 1, 2, 3, 4, 5, STYLE

MIDI

- Local On/Off
- Initial Send
- External Clock
- Keyboard Out
- Style Out
- Song Out

Auxiliary jacks

- PHONES/OUTPUT, DC IN 12V, USB, SUSTAIN

Amplifier

- 2.5W + 2.5W

Speakers

- 12cm x 2 + 3cm x 2

Power Consumption

- 10W

Power Supply

- Adaptor: PA-130 or an equivalent recommended by Yamaha
- Batteries: Six "AA" size, LR6 or equivalent batteries

Dimensions (W x D x H)

- 952 x 388 x 146 mm (37-1/2" x 15-1/4" x 5-3/4")

Weight

- 7.0kg (15 lbs. 7 oz.) (not including batteries)

Supplied Accessories

- Music Rest
- Accessory CD-ROM
- Owner's Manual

Optional Accessories

- AC Power Adaptor: PA-130 or an equivalent recommended by Yamaha
- Footswitch: FC4/FC5
- Keyboard Stand: L-2C/L-2L
- Headphones: HPE-150

* Specifications and descriptions in this owner's manual are for information purposes only. Yamaha Corp. reserves the right to change or modify products or specifications at any time without prior notice. Since specifications, equipment or options may not be the same in every locale, please check with your Yamaha dealer.



Index

Panel controls and terminals

+, -	13, 58
	57
(REPEAT & LEARN)	12, 48
(A-B REPEAT)	12, 78
(REW)	12, 40
(FF)	12, 40
(PAUSE)	12, 40
(START/STOP)	12, 58
0-9	13, 58
ACMP ON/OFF	12, 34
ARPEGGIO ON/OFF	12, 14
ARPEGGIO TYPE	12, 15
ASSIGN	12, 18
CATEGORY [] and []	13, 58
DC IN 12V	10, 13
DEMO/PC	12, 40
Dial	13, 58
DUAL	13, 29
EASY SONG ARRANGER	12, 50
FUNCTION	12, 83
HARMONY	13, 60
INTRO/ENDING/rit.	12, 71
KNOB A, B	12, 18
LESSON L, R	12, 44
LESSON START	12, 44
MAIN/AUTO FILL	12, 71
MASTER VOLUME	12, 24
MEMORY/BANK, 1, 2	13, 80
METRONOME	12, 63
MUSIC DATABASE	13, 49
PERFORMANCE ASSISTANT	12, 23
PHONES/OUTPUT	11, 13
PITCH BEND wheel	13, 66
PORTABLE GRAND	13, 31
REC, 1-5, A	12, 52
REGIST MEMORY	13, 80
SONG	13, 39
SONG MEMORY	12, 52
SPLIT	13, 30
STANDBY/ON	11-12
STYLE	13, 33
SUSTAIN	11, 13
SYNC START	12, 70
SYNC STOP	12, 71
TEMPO/TAP	12, 27
TOUCH	13, 65
USB	13, 87
VOICE	13, 28

Alphabetical order

A	
A-B Repeat	78
Accessories	7
ACMP	34
Arpeggio	14
Arpeggio List	113
Arpeggio Type	15
Arpeggio Velocity	67
Attack	20
Auto Accompaniment Range	34
Auto-Accompaniment	34
AWM	6
B	
Backup	56
C	
CD-ROM	93
Channel Message	87
Chord	36, 38, 75-76
Chord Dictionary	77
CHORD ROOT	77
CHORD TYPE	77
Chorus	19, 62
Chorus Type	62, 117
Computer	87
Cutoff	19
D	
Default Setting	83
Delete (Song Track)	55
Delete (User Song)	55
Demo	40
Demo Cancel	85
Display	59
Drum Kit	32
Drum Kit List	110
Dual Voice	29
Dual Voice Chorus Level	84
Dual Voice Octave	84
Dual Voice Pan	84
Dual Voice Reverb Level	84
Dual Voice Volume	84
E	
Easy Chords	38
Easy Song Arranger	50
Effect Map	120
Effect Type List	117
External Song	42
F	
Filter	19
Filter (Style)	20
Flash Memory	42
Foot Switch	11
Function	83-84
G	
Grade	45
H	
Harmony	60
Harmony Type	60
Harmony Volume	69
Headphones	11
I	
Initial Send	85, 90
Initialization	56
K	
Keyboard Out	88
L	
Lesson	43
Load SFF	74
Local	88
L-Part	92
M	
Main Voice	28
Main Voice Chorus Level	84
Main Voice Octave	84
Main Voice Pan	84
Main Voice Reverb Level	84
Main Voice Volume	84
Master EQ Type	69
Measure	59
Melody Voice	51, 79
Metronome	63
MIDI	86
MIDI Data Format	120
MIDI Implementation Chart	118
Music Database	49
Music Database List	114
Music Rest	7
Mute	79
N	
Notation	59
O	
One Touch Setting	68

P

PC Mode	89
Performance assistant technology	23
Pitch Bend Range	84
Power Adaptor	10
Preset Song	39, 41-42

R

Recording	52
Registration Memory	80
Release	20
Remote control	89
Repeat	48
Resonance	19
Reverb	19, 61
Reverb Type	117
R-Part	92

S

Save (Backup File)	92
Save (Panel Setting)	80
Score	100-105
Sleep	82
SMF (Standard MIDI File)	90
Software Licensing Agreement	121
Song	39
Song Clear	55
Song List	41, 116
Song Memory	52
Song Out	88
Song Volume	78
Specifications	123
Split Point	30, 72
Split Voice	30
Split Voice Chorus Level	84
Split Voice Octave	84
Split Voice Pan	84
Split Voice Reverb Level	84
Split Voice Volume	84
Standard Chords	38
Style	33-37, 70
Style File	74
Style List	112
Style Out	88
Style Tempo	20
Style Volume	72
Sustain (Footswitch)	11
Synchro Start	34, 36, 70
Synchro Stop	71
System Message	87

T

Tempo	27
Time Denominator	64
Time Numerator	64
Time Signature	63

Touch Response	65
Touch Sensitivity	65
Track	52-55
Track Clear	55
Transfer	90-92
Transpose	66
Troubleshooting (Installation)	98
Troubleshooting (Instrument)	99
Tuning	66

U

USB	87
USB-MIDI Driver	96-97
User Song	52

V

Voice	28
Voice List	106

X

XGlite	6
--------------	---

Limited Warranty

90 DAYS LABOR

1 YEAR PARTS

Yamaha Corporation of America, hereafter referred to as Yamaha, warrants to the original consumer of a product included in the categories listed below, that the product will be free of defects in materials and/or workmanship for the periods indicated. This warranty is applicable to all models included in the following series of products:

PSR SERIES OF DIGITAL KEYBOARD

If during the first 90 days that immediately follows the purchase date, your new Yamaha product covered by this warranty is found to have a defect in material and/or workmanship, Yamaha and/or its authorized representative will repair such defect without charge for parts or labor.

If parts should be required after this 90 day period but within the one year period that immediately follows the purchase date, Yamaha will, subject to the terms of this warranty, supply these parts without charge. However, charges for labor, and/or any miscellaneous expenses incurred are the consumers responsibility. Yamaha reserves the right to utilize reconditioned parts in repairing these products and/or to use reconditioned units as warranty replacements.

THIS WARRANTY IS THE ONLY EXPRESS WARRANTY WHICH YAMAHA MAKES IN CONNECTION WITH THESE PRODUCTS. ANY IMPLIED WARRANTY APPLICABLE TO THE PRODUCT, INCLUDING THE WARRANTY OF MERCHANT ABILITY IS LIMITED TO THE DURATION OF THE EXPRESS WARRANTY. YAMAHA EXCLUDES AND SHALL NOT BE LIABLE IN ANY EVENT FOR INCIDENTAL OR CONSEQUENTIAL DAMAGES.

Some states do not allow limitations that relate to implied warranties and/or the exclusion of incidental or consequential damages. Therefore, these limitations and exclusions may not apply to you.

This warranty gives you specific legal rights. You may also have other rights which vary from state to state.

CONSUMERS RESPONSIBILITIES

If warranty service should be required, it is necessary that the consumer assume certain responsibilities:

1. Contact the Customer Service Department of the retailer selling the product, or any retail outlet authorized by Yamaha to sell the product for assistance. You may also contact Yamaha directly at the address provided below.
2. Deliver the unit to be serviced under warranty to: the retailer selling the product, an authorized service center, or to Yamaha with an explanation of the problem. Please be prepared to provide proof purchase date (sales receipt, credit card copy, etc.) when requesting service and/or parts under warranty.
3. Shipping and/or insurance costs are the consumers responsibility.* Units shipped for service should be packed securely.

*Repaired units will be returned PREPAID if warranty service is required within the first 90 days.

IMPORTANT: Do NOT ship anything to ANY location without prior authorization. A Return Authorization (RA) will be issued that has a tracking number assigned that will expedite the servicing of your unit and provide a tracking system if needed.

4. Your owners manual contains important safety and operating instructions. It is your responsibility to be aware of the contents of this manual and to follow all safety precautions.

EXCLUSIONS

This warranty does not apply to units whose trade name, trademark, and/or ID numbers have been altered, defaced, exchanged removed, or to failures and/or damages that may occur as a result of:

1. Neglect, abuse, abnormal strain, modification or exposure to extremes in temperature or humidity.
2. Improper repair or maintenance by any person who is not a service representative of a retail outlet authorized by Yamaha to sell the product, an authorized service center, or an authorized service representative of Yamaha.
3. This warranty is applicable only to units sold by retailers authorized by Yamaha to sell these products in the U.S.A., the District of Columbia, and Puerto Rico. This warranty is not applicable in other possessions or territories of the U.S.A. or in any other country.

Please record the model and serial number of the product you have purchased in the spaces provided below.

Model _____ Serial # _____ Sales Slip # _____

Purchased from _____ Date _____
(Retailer)

YAMAHA CORPORATION OF AMERICA
Electronic Service Division
6600 Orangethorpe Avenue
Buena Park, CA 90620

KEEP THIS DOCUMENT FOR YOUR RECORDS. DO NOT MAIL!

For details of products, please contact your nearest Yamaha representative or the authorized distributor listed below.

Pour plus de détails sur les produits, veuillez-vous adresser à Yamaha ou au distributeur le plus proche de vous figurant dans la liste suivante.

Die Einzelheiten zu Produkten sind bei Ihrer unten aufgeführten Niederlassung und bei Yamaha Vertragshändlern in den jeweiligen Bestimmungsländern erhältlich.

Para detalles sobre productos, contacte su tienda Yamaha más cercana o el distribuidor autorizado que se lista debajo.

NORTH AMERICA

CANADA

Yamaha Canada Music Ltd.
135 Milner Avenue, Scarborough, Ontario,
M1S 3R1, Canada
Tel: 416-298-1311

U.S.A.

Yamaha Corporation of America
6600 Orangethorpe Ave., Buena Park, Calif. 90620,
U.S.A.
Tel: 714-522-9011

CENTRAL & SOUTH AMERICA

MEXICO

Yamaha de México S.A. de C.V.
Calz. Javier Rojo Gómez #1149,
Col. Guadalupe del Moral
C.P. 09300, México, D.F., México
Tel: 55-5804-0600

BRAZIL

Yamaha Musical do Brasil Ltda.
Rua Joaquim Floriano, 913 - 4º andar, Itaim Bibi,
CEP 04534-013 Sao Paulo, SP. BRAZIL
Tel: 011-3704-1377

ARGENTINA

Yamaha Music Latin America, S.A.
Sucursal de Argentina
Viamonte 1145 Piso 2-B 1053,
Buenos Aires, Argentina
Tel: 1-4371-7021

PANAMA AND OTHER LATIN AMERICAN COUNTRIES/ CARIBBEAN COUNTRIES

Yamaha Music Latin America, S.A.
Torre Banco General, Piso 7, Urbanización Marbella,
Calle 47 y Aquilino de la Guardia,
Ciudad de Panamá, Panamá
Tel: +507-269-5311

EUROPE

THE UNITED KINGDOM

Yamaha Music U.K. Ltd.
Sherbourne Drive, Tilbrook, Milton Keynes,
MK7 8BL, England
Tel: 01908-366700

IRELAND

Danfay Ltd.
61D, Sallynoggin Road, Dun Laoghaire, Co. Dublin
Tel: 01-2859177

GERMANY

Yamaha Music Central Europe GmbH
Siemensstraße 22-34, 25462 Rellingen, Germany
Tel: 04101-3030

SWITZERLAND/LIECHTENSTEIN

Yamaha Music Central Europe GmbH,
Branch Switzerland
Seefeldstrasse 94, 8008 Zürich, Switzerland
Tel: 01-383 3990

AUSTRIA

Yamaha Music Central Europe GmbH,
Branch Austria
Schleiergasse 20, A-1100 Wien, Austria
Tel: 01-60203900

CZECH REPUBLIC/SLOVAKIA/ HUNGARY/SLOVENIA

Yamaha Music Central Europe GmbH,
Branch Austria, CEE Department
Schleiergasse 20, A-1100 Wien, Austria
Tel: 01-602039025

POLAND

Yamaha Music Central Europe GmbH
Sp.z o.o. Oddział w Polsce
ul. 17 Stycznia 56, PL-02-146 Warszawa, Poland
Tel: 022-868-07-57

THE NETHERLANDS/ BELGIUM/LUXEMBOURG

Yamaha Music Central Europe GmbH,
Branch Benelux
Clarissenhof 5-b, 4133 AB Vianen, The Netherlands
Tel: 0347-358 040

FRANCE

Yamaha Musique France
BP 70-77312 Marne-la-Vallée Cedex 2, France
Tel: 01-64-61-4000

ITALY

Yamaha Musica Italia S.P.A.
Viale Italia 88, 20020 Lainate (Milano), Italy
Tel: 02-935-771

SPAIN/PORTUGAL

Yamaha Música Ibérica, S.A.
Ctra. de la Coruna km. 17, 200, 28230
Las Rozas (Madrid), Spain
Tel: 91-639-8888

GREECE

Philippos Nakas S.A. The Music House
147 Skiathou Street, 112-55 Athens, Greece
Tel: 01-228 2160

SWEDEN

Yamaha Scandinavia AB
J. A. Wettergrens Gata 1, Box 30053
S-400 43 Göteborg, Sweden
Tel: 031 89 34 00

DENMARK

YS Copenhagen Liaison Office
Generatorvej 6A, DK-2730 Herlev, Denmark
Tel: 44 92 49 00

FINLAND

F-Musiikki Oy
Kluuvikatu 6, P.O. Box 260,
SF-00101 Helsinki, Finland
Tel: 09 618511

NORWAY

Norsk filial av Yamaha Scandinavia AB
Grini Næringspark 1, N-1345 Østerås, Norway
Tel: 67 16 77 70

ICELAND

Skifan HF
Skeifan 17 P.O. Box 8120, IS-128 Reykjavik, Iceland
Tel: 525 5000

RUSSIA

Yamaha Music (Russia)
Office 4015, entrance 2, 21/5 Kuznetskii
Most street, Moscow, 107996, Russia
Tel: 495 626 0660

OTHER EUROPEAN COUNTRIES

Yamaha Music Central Europe GmbH
Siemensstraße 22-34, 25462 Rellingen, Germany
Tel: +49-4101-3030

AFRICA

Yamaha Corporation,
Asia-Pacific Music Marketing Group
Nakazawa-cho 10-1, Naka-ku, Hamamatsu,
Japan 430-8650
Tel: +81-53-460-2312

MIDDLE EAST

TURKEY/CYPRUS

Yamaha Music Central Europe GmbH
Siemensstraße 22-34, 25462 Rellingen, Germany
Tel: 04101-3030

OTHER COUNTRIES

Yamaha Music Gulf FZE
LOB 16-513, P.O.Box 17328, Jubel Ali,
Dubai, United Arab Emirates
Tel: +971-4-881-5868

ASIA

THE PEOPLE'S REPUBLIC OF CHINA

Yamaha Music & Electronics (China) Co.,Ltd.
25/F., United Plaza, 1468 Nanjing Road (West),
Jingan, Shanghai, China
Tel: 021-6247-2211

HONG KONG

Tom Lee Music Co., Ltd.
11/F., Silvercord Tower 1, 30 Canton Road,
Tsimshatsui, Kowloon, Hong Kong
Tel: 2737-7688

INDONESIA

PT. Yamaha Music Indonesia (Distributor)
PT. Nusantik
Gedung Yamaha Music Center, Jalan Jend. Gatot
Subroto Kav. 4, Jakarta 12930, Indonesia
Tel: 21-520-2577

KOREA

Yamaha Music Korea Ltd.
8F, 9F, Dongsung Bldg. 158-9 Samsung-Dong,
Kangnam-Gu, Seoul, Korea
Tel: 080-004-0022

MALAYSIA

Yamaha Music Malaysia, Sdn., Bhd.
Lot 8, Jalan Perbandaran, 47301 Kelana Jaya,
Petaling Jaya, Selangor, Malaysia
Tel: 3-78030900

PHILIPPINES

Yupangco Music Corporation
339 Gil J. Puyat Avenue, P.O. Box 885 MCPO,
Makati, Metro Manila, Philippines
Tel: 819-7551

SINGAPORE

Yamaha Music Asia Pte., Ltd.
#03-11 A-Z Building
140 Paya Lebar Road, Singapore 409015
Tel: 747-4374

TAIWAN

Yamaha KHS Music Co., Ltd.
3F, #6, Sec.2, Nan Jing E. Rd. Taipei.
Taiwan 104, R.O.C.
Tel: 02-2511-8688

THAILAND

Siam Music Yamaha Co., Ltd.
891/1 Siam Motors Building, 15-16 floor
Rama 1 road, Wangmai, Pathumwan
Bangkok 10330, Thailand
Tel: 02-215-2626

OTHER ASIAN COUNTRIES

Yamaha Corporation,
Asia-Pacific Music Marketing Group
Nakazawa-cho 10-1, Naka-ku, Hamamatsu,
Japan 430-8650
Tel: +81-53-460-2317

OCEANIA

AUSTRALIA

Yamaha Music Australia Pty. Ltd.
Level 1, 99 Queensbridge Street, Southbank,
Victoria 3006, Australia
Tel: 3-9693-5111

NEW ZEALAND

Music Houses of N.Z. Ltd.
146/148 Captain Springs Road, Te Papapa,
Auckland, New Zealand
Tel: 9-634-0099

COUNTRIES AND TRUST TERRITORIES IN PACIFIC OCEAN

Yamaha Corporation,
Asia-Pacific Music Marketing Group
Nakazawa-cho 10-1, Naka-ku, Hamamatsu,
Japan 430-8650
Tel: +81-53-460-2312

HEAD OFFICE Yamaha Corporation, Pro Audio & Digital Musical Instrument Division
Nakazawa-cho 10-1, Naka-ku, Hamamatsu, Japan 430-8650
Tel: +81-53-460-3273



Yamaha Home Keyboards Home Page (English Only)
<http://music.yamaha.com/homekeyboard>
Yamaha Manual Library
<http://www.yamaha.co.jp/manual/>

U.R.G., Pro Audio & Digital Musical Instrument Division, Yamaha Corporation
© 2007 Yamaha Corporation

WM17300 XXXPOXXX.X-01A0
Printed in China