

# YAMAHA MusicCAST<sup>2</sup>

## MCX-RC100 / MCX-A300 / MCX-P200

### GETTING STARTED

This guide explains the basic way to build a WiFi network between your MusicCAST2 products and WiFi router and enjoy digital music distribution via the WiFi network. Complete description of MusicCAST2 products is available on our website. To access the MusicCAST2 website, please enter the following URL on your browser.

**MusicCAST2 website:**  
[www.yamaha.com/musiccast](http://www.yamaha.com/musiccast)

#### Network to build in this guide

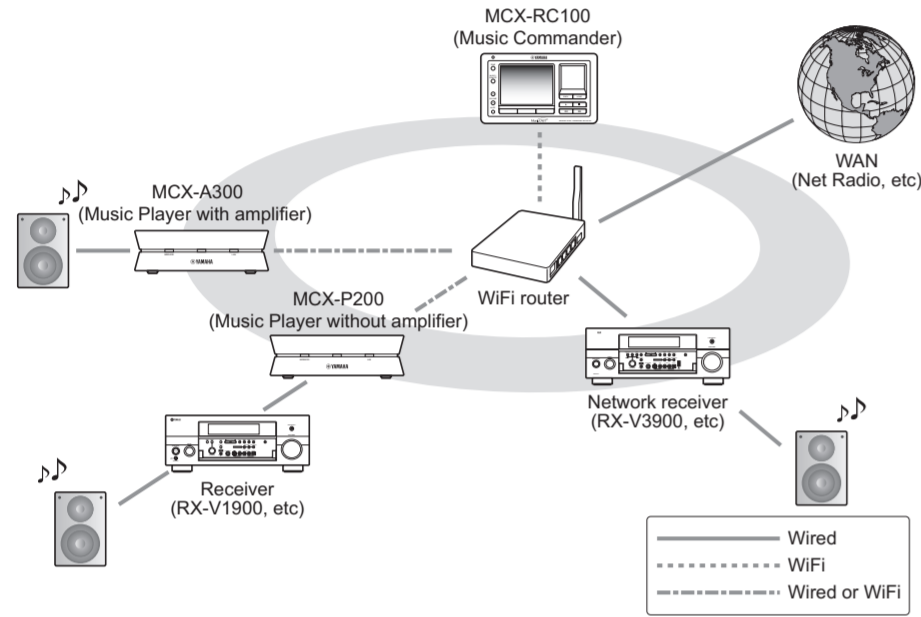

- This guide assumes that you have an Internet connection and your WiFi router is being connected to the Internet.
- This guide is printed prior to production. Design and specifications are subject to change in part as a result of improvements, etc.

## 1 Preparation

### Charging the Music Commander (MCX-RC100)

First, charge the Music Commander (MCX-RC100) as shown below. It takes about 135 minutes to fully charge the built-in battery.

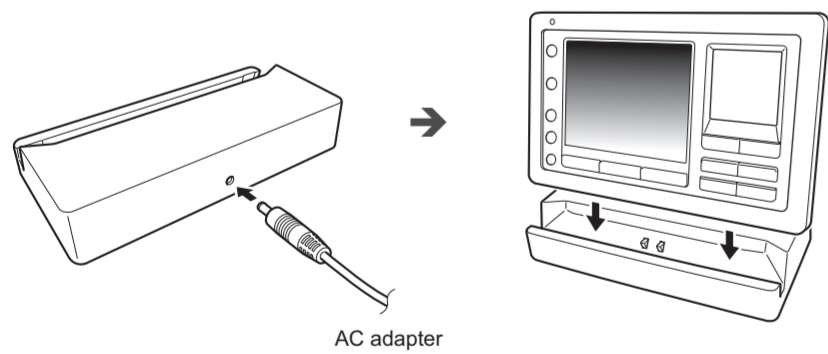

The Music Commander automatically turns on by charge. If not, press and hold the control pad for more than two seconds to turn it on.

### How to use the Music Commander's control pad

- To move the selection from side to side or up and down
- To move the page up and down

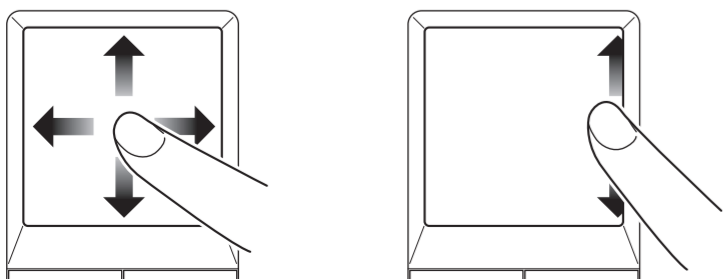

- To enter the highlighted menu or confirm the selection

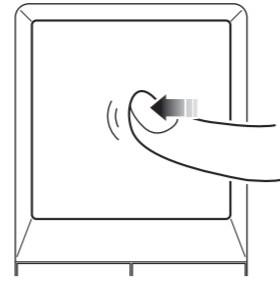

Press the control pad until you hear click sound. It does not react to a touch.

## 2 Cable connections

### For MCX-A300

- 1 Connect front right and left speakers to the SPEAKERS (L/R) terminals using speaker cables.
- 2 If desired, connect a subwoofer to the SUBWOOFER OUT jack using a subwoofer (pin-jack) cable.
- 3 Plug the supplied AC adapter into the adapter connector, connect the power cable to the AC adapter, and then plug into an AC wall outlet.

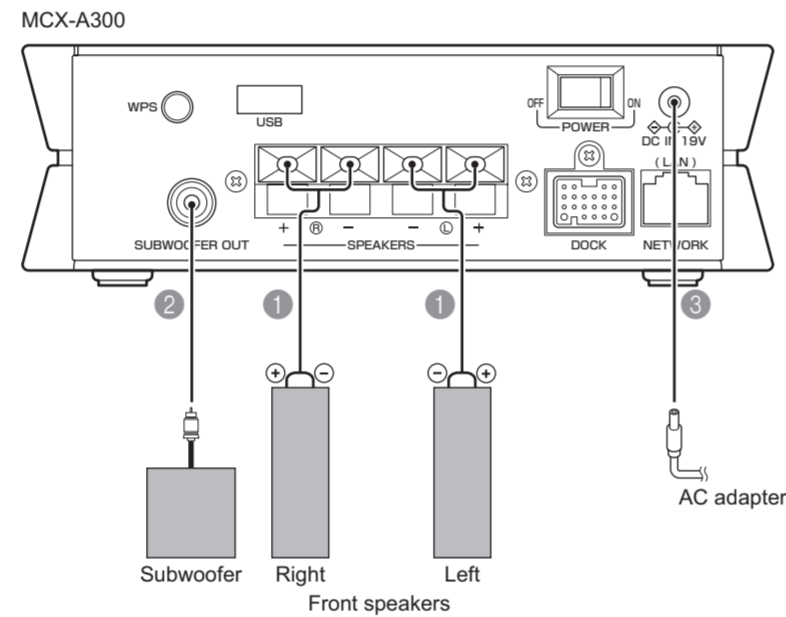

### For MCX-P200

- 1 Plug an analog audio cable into the AUDIO (L/R) jacks.
- 2 Plug the other end of the analog audio cable into analog input jacks available on your receiver (RX-V1900, etc).
- 3 If desired, connect a subwoofer to the SUBWOOFER jack using a subwoofer (pin-jack) cable.
- 4 Plug the supplied AC adapter into the adapter connector, connect the power cable to the AC adapter, and then plug into an AC wall outlet.

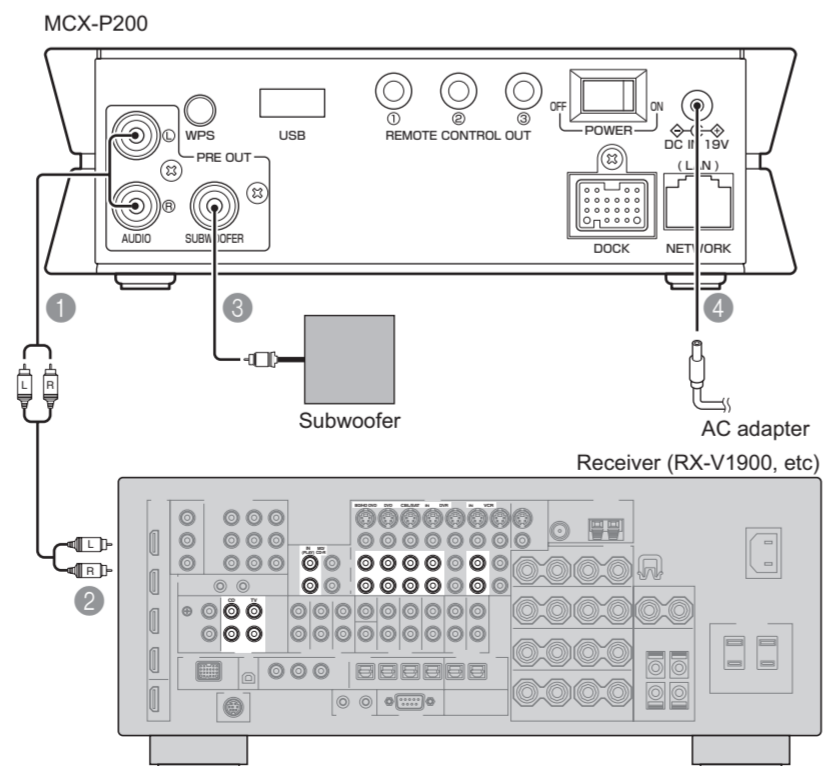

- By using the supplied IR flasher, you can control the receiver connected to the MCX-P200 with the Music Commander. For details, refer to the online manual at the MusicCAST2 website.
- For information on other connections for your receiver, refer to the manual supplied with it.

### For a network receiver (RX-V3900, etc)

- 1 Connect your network receiver to a LAN port of the WiFi router using a network cable (CAT-5 or higher straight cable).
- 2 Plug the supplied power cable into the AC inlet and then plug into an AC wall outlet.

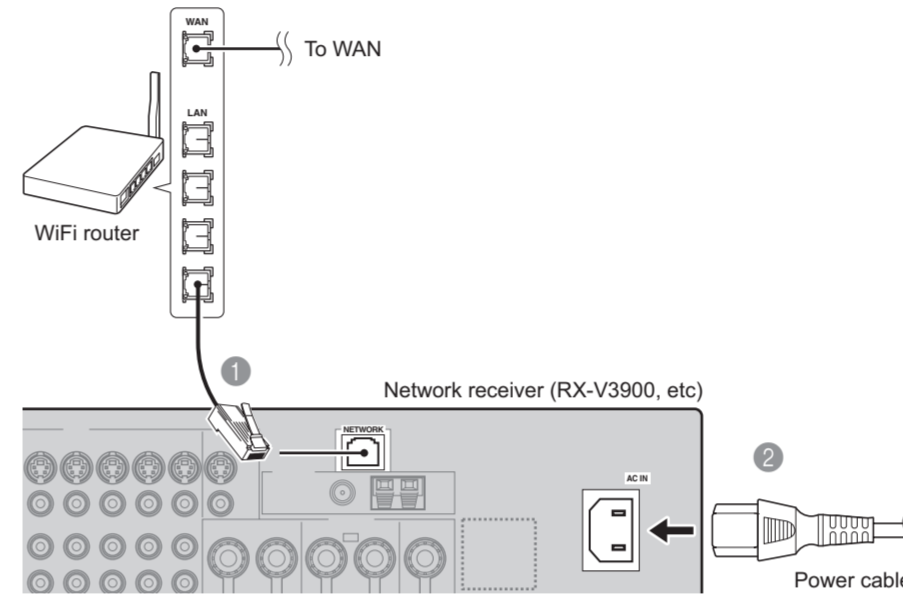

For information on other connections for your network receiver, refer to the manual supplied with it.

## 3 WiFi settings

If your WiFi router supports WPS, you can simply establish a wireless connection between this WiFi router and the MusicCAST2 system using WPS. To activate the Music Players, press and hold the WPS setup button more than one second. For complete details, refer to the online manual at the MusicCAST2 website and WiFi router manual.

1. Make sure that your WiFi router is turned on.
2. Music Commander: → Setup

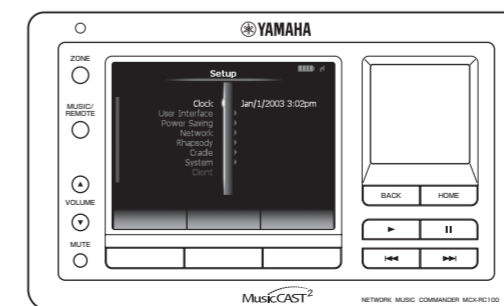
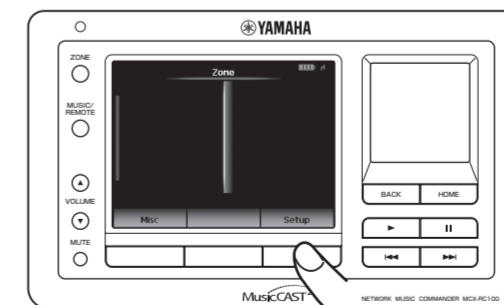
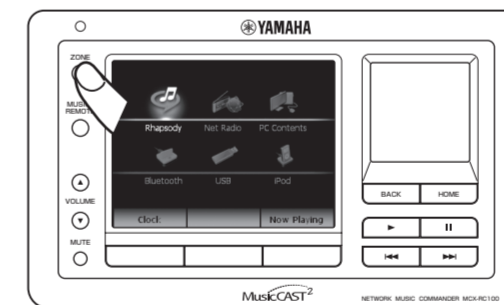

3. [Network] – [Setup] – [Wireless LAN] – [Easy Setup]

Use the control pad to select [Network] and enter the "Network" menu as shown below. In the same way, select [Setup] – [Wireless LAN] – [Easy Setup].

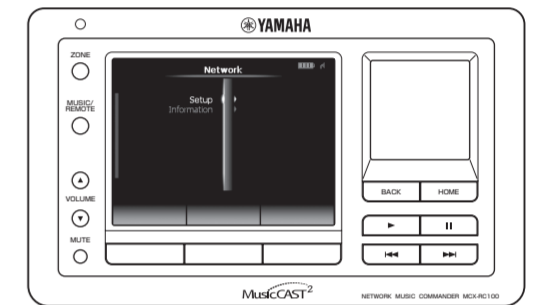
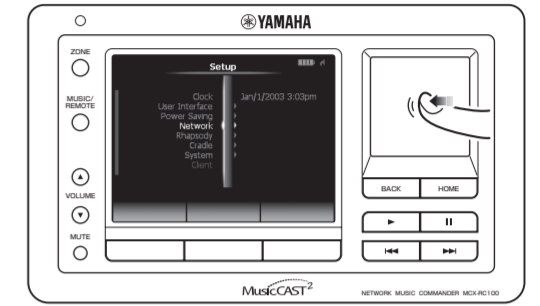
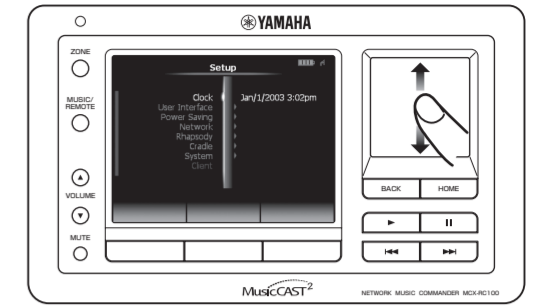

4. Select a WiFi router to use for the WiFi connection.

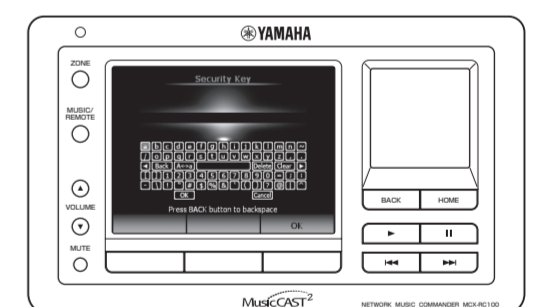
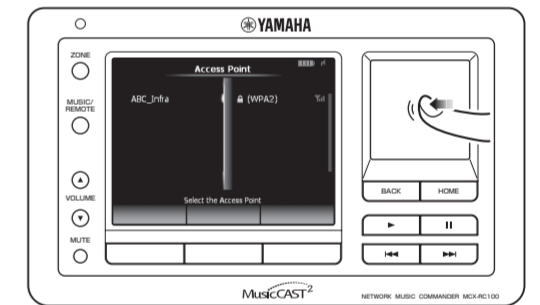

(continued on the back side)

(continued from the front side)

5.  Enter the security key used by the selected WiFi router and then select "OK".

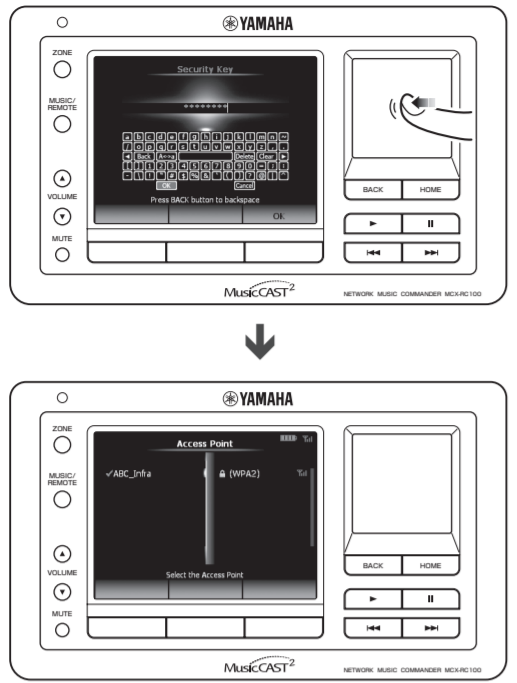

Now the Music Commander is connected to your WiFi router.

6. Make sure that no network cable is connected to the Music Player (MCX-A300 or MCX-P200).

 If you want to make a wired connection between the Music Player and WiFi router, use a network cable to connect them and then turn on the Music Player. In this case, you can skip the following steps.

7. Music Commander: 

8. Music Player: While holding down MUTE, turn on the Music Player.

Keep holding down MUTE until the WIRELESS LED lights in amber.

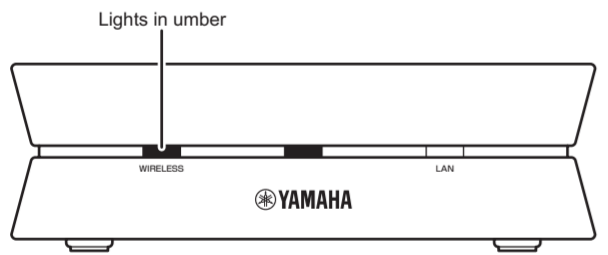
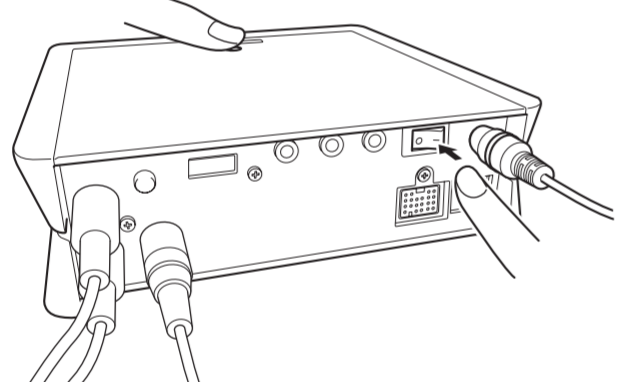

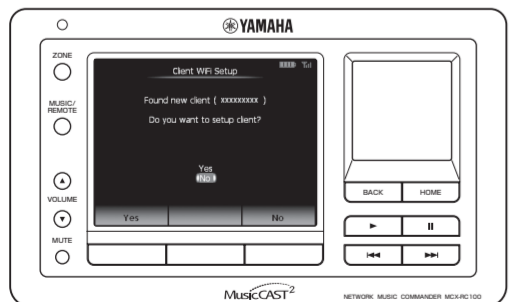

The "Client WiFi Setup" screen appears on the Music Commander. It may take one or two minutes to detect the Music Player depending on your network environment. If the display turns off during this process, press ZONE to turn it on.

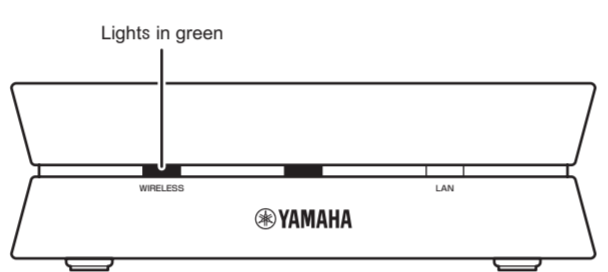
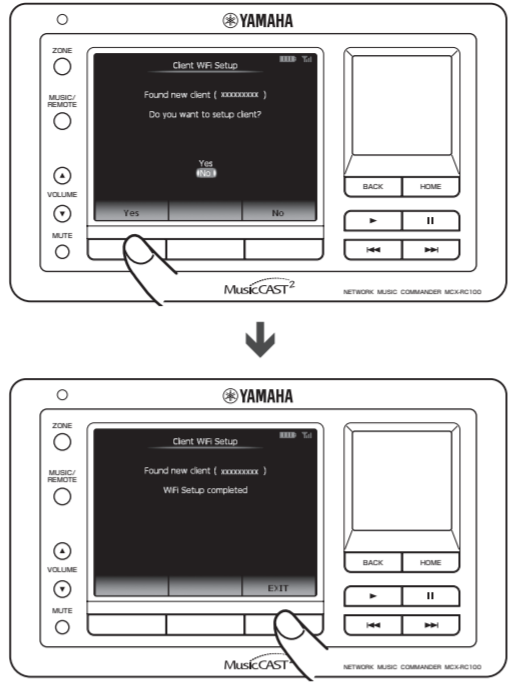

 Perform step 9 within three minutes. If it failed, your Music Player will exit the WiFi setup process. In this case, turn off the Music Player and then perform step 8 again.

9. Music Commander:  → 



 If "WiFi Setup uncompleted" appears, turn off the Music Player and then perform from step 8 again.

Now the Music Player is connected to your WiFi router.

## 4 Playback





Now you are ready to enjoy digital music distribution. As a system test, follow the procedure below to start to listen to Internet Radio stations using your MusicCAST2 products or Yamaha network receiver (RX-V3900, etc) connected to your WiFi router. This unit uses the vTuner Internet Radio station database service particularly customized for this unit.

 To output audio source at your receiver, you need to prepare the receiver for playback (turning on power, selecting input source, etc). For details, refer to the manual supplied with it.

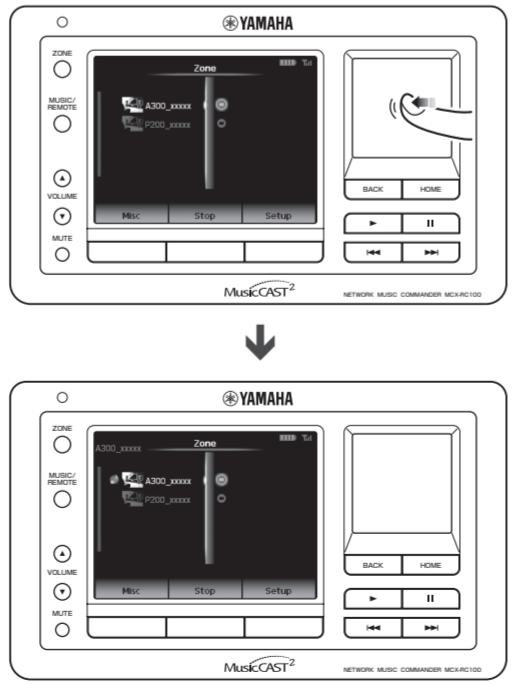
1. Music Commander: 

2.  Select the device (zone) to which audio source is delivered.

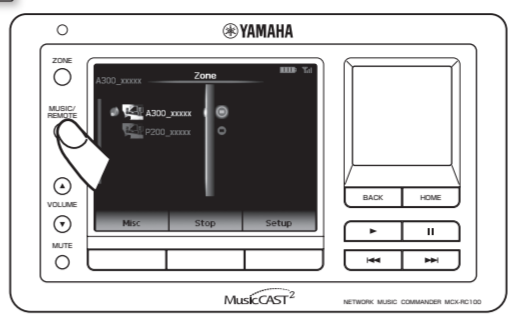
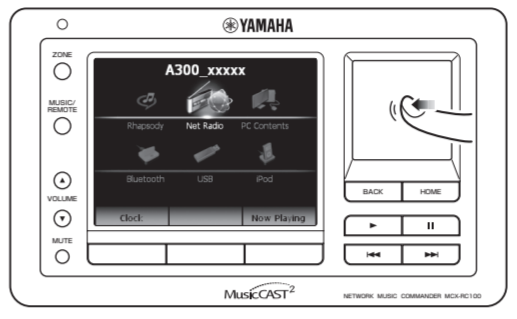

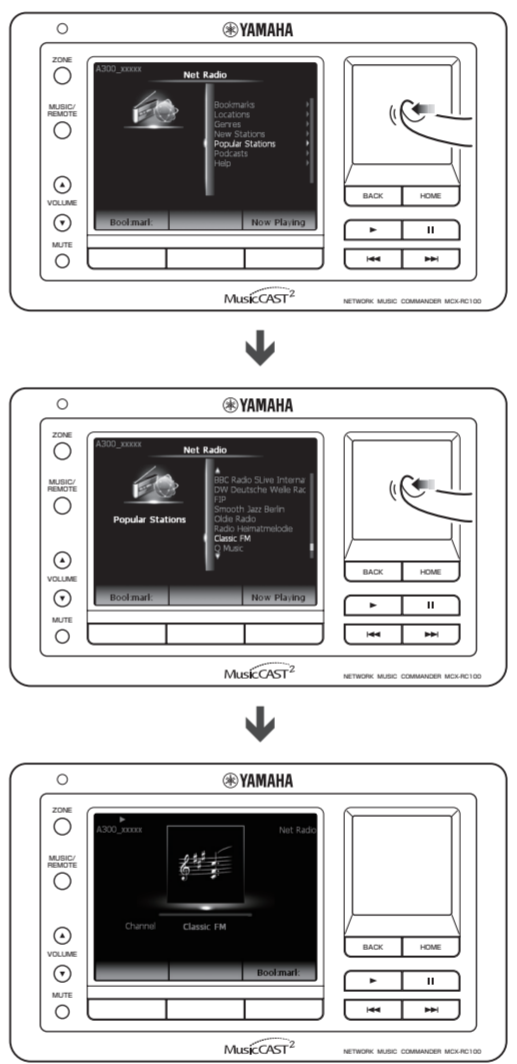

3.  →  **[Net Radio]**
- 
- 
4.  Select an Internet Radio station you want to listen to.





5. If playback starts, use the playback control keys to operate desired functions.

 Start playback

 Pause (stop) playback

 Adjust the volume level

 Turn on/off the audio mute

 Playback control operations always work on the playback on the device (zone) selected in the "Zone" screen (shown in step 2).

### Playback screen

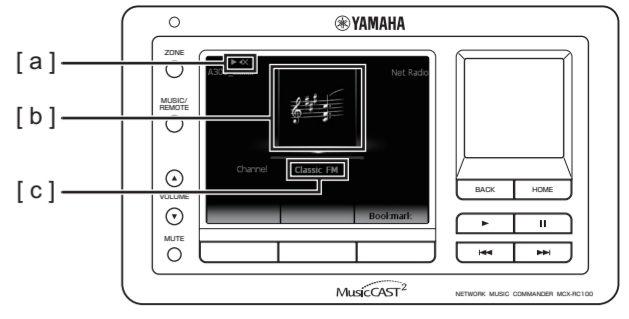

[ a ] Playback status (▶: Play, ◀X: Mute)  
[ b ] Station logo (if available)  
[ c ] Station name

6.  (to the previous menu screen)

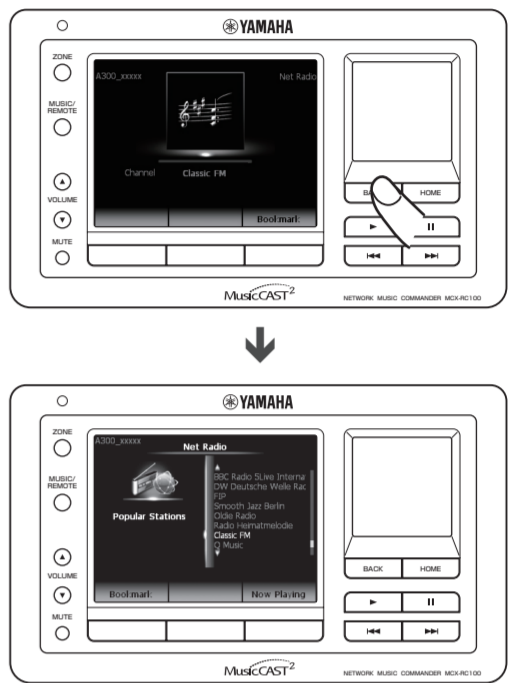

7.  (to the top menu screen)

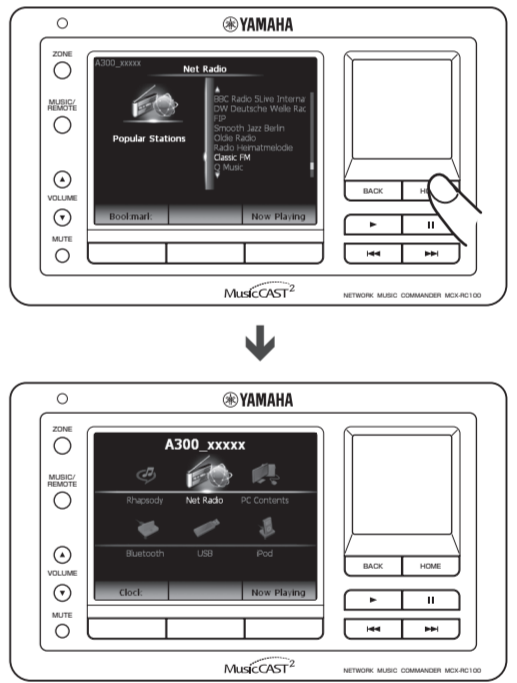

### In case you need to turn off the Music Commander

1. Music Commander:  → 

2.  **[Power Saving] - [Power Off] - [Yes]**

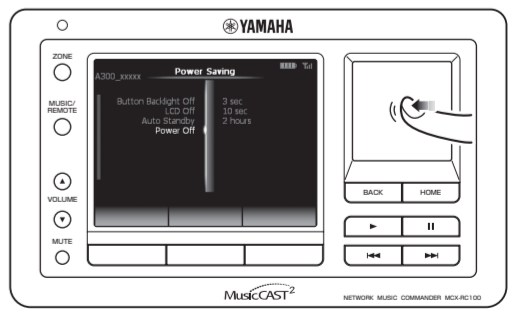

 To turn on the Music Commander, press and hold the control pad for more than two seconds.