

RX-V1

Natural Sound AV Receiver
Ampli-Tuner Audio-Video

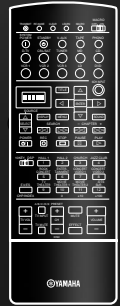

*OWNER'S MANUAL
MODE D'EMPLOI*

SAFETY INSTRUCTIONS

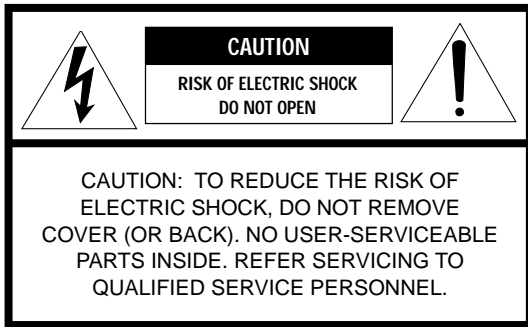

• Explanation of Graphical Symbols

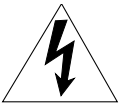

The lightning flash with arrowhead symbol, within an equilateral triangle, is intended to alert you to the presence of uninsulated "dangerous voltage" within the product's enclosure that may be of sufficient magnitude to constitute a risk of electric shock to persons.



The exclamation point within an equilateral triangle is intended to alert you to the presence of important operating and maintenance (servicing) instructions in the literature accompanying the appliance.

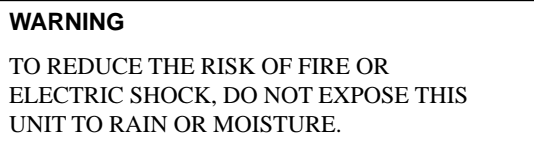

- 1 Read Instructions – All the safety and operating instructions should be read before the unit is operated.
- 2 Retain Instructions – The safety and operating instructions should be retained for future reference.
- 3 Heed Warnings – All warnings on the unit and in the operating instructions should be adhered to.
- 4 Follow Instructions – All operating and other instructions should be followed.
- 5 Water and Moisture – The unit should not be used near water – for example, near a bathtub, washbowl, kitchen sink, laundry tub, in a wet basement, or near a swimming pool, etc.
- 6 Carts and Stands – The unit should be used only with a cart or stand that is recommended by the manufacturer.
- 6A A unit and cart combination should be moved with care. Quick stops, excessive force, and uneven surfaces may cause the unit and cart combination to overturn.
- 7 Wall or Ceiling Mounting – The unit should be mounted to a wall or ceiling only as recommended by the manufacturer.



- 8 Ventilation – The unit should be situated so that its location or position does not interfere with its proper ventilation. For example, the unit should not be situated on a bed, sofa, rug, or similar surface, that may block the ventilation openings; or placed in a built-in installation, such as a bookcase or cabinet that may impede the flow of air through the ventilation openings.
- 9 Heat – The unit should be situated away from heat sources such as radiators, stoves, or other appliances that produce heat.
- 10 Power Sources – The unit should be connected to a power supply only of the type described in the operating instructions or as marked on the unit.
- 11 Power-Cord Protection – Power-supply cords should be routed so that they are not likely to be walked on or pinched by items placed upon or against them, paying particular attention to cords at plugs, convenience receptacles, and the point where they exit from the unit.
- 12 Cleaning – The unit should be cleaned only as recommended by the manufacturer.
- 13 Nonuse Periods – The power cord of the unit should be unplugged from the outlet when left unused for a long period of time.
- 14 Object and Liquid Entry – Care should be taken so that objects do not fall into and liquids are not spilled into the inside of the unit.
- 15 Damage Requiring Service – The unit should be serviced by qualified service personnel when:
 - A. The power-supply cord or the plug has been damaged; or
 - B. Objects have fallen, or liquid has been spilled into the unit; or
 - C. The unit has been exposed to rain; or
 - D. The unit does not appear to operate normally or exhibits a marked change in performance; or
 - E. The unit has been dropped, or the cabinet damaged.
- 16 Servicing – The user should not attempt to service the unit beyond those means described in the operating instructions. All other servicing should be referred to qualified service personnel.
- 17 Power Lines – An outdoor antenna should be located away from power lines.
- 18 Grounding or Polarization – Precautions should be taken so that the grounding or polarization is not defeated.

19 For US customers only:

Outdoor Antenna Grounding – If an outside antenna is connected to this unit, be sure the antenna system is grounded so as to provide some protection against voltage surges and built-up static charges. Article 810 of the National Electrical Code, ANSI/NFPA 70, provides information with regard to proper grounding of the mast and supporting structure, grounding of the lead-in wire to an antenna discharge unit, size of grounding conductors, location of antenna discharge unit, connection to grounding electrodes, and requirements for the grounding electrode.

Note to CATV system installer:

This reminder is provided to call the CATV system installer's attention to Article 820-40 of the NEC that provides guidelines for proper grounding and, in particular, specifies that the cable ground shall be connected to the grounding system of the building, as close to the point of cable entry as practical.

EXAMPLE OF ANTENNA GROUNDING

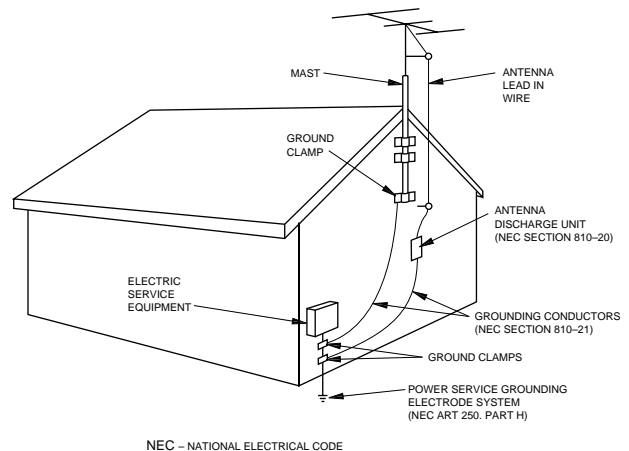

FCC INFORMATION (for US customers only)

1. IMPORTANT NOTICE : DO NOT MODIFY THIS UNIT!

This product, when installed as indicated in the instructions contained in this manual, meets FCC requirements. Modifications not expressly approved by Yamaha may void your authority, granted by the FCC, to use the product.

2. IMPORTANT : When connecting this product to accessories and/or another product use only high quality shielded cables. Cable/s supplied with this product MUST be used. Follow all installation instructions. Failure to follow instructions could void your FCC authorization to use this product in the USA.

3. NOTE : This product has been tested and found to comply with the requirements listed in FCC Regulations, Part 15 for Class "B" digital devices. Compliance with these requirements provides a reasonable level of assurance that your use of this product in a residential environment will not result in harmful interference with other electronic devices.

This equipment generates/uses radio frequencies and, if not installed and used according to the instructions found in the users manual, may cause interference harmful to the operation of other electronic devices.

Compliance with FCC regulations does not guarantee that interference will not occur in all installations. If this product is found to be the source of interference, which can be determined by turning the unit "OFF" and "ON", please try to eliminate the problem by using one of the following measures:

Relocate either this product or the device that is being affected by the interference.

Utilize power outlets that are on different branch (circuit breaker or fuse) circuits or install AC line filter/s.

In the case of radio or TV interference, relocate/reorient the antenna. If the antenna lead-in is 300 ohm ribbon lead, change the lead-in to coaxial type cable.

If these corrective measures do not produce satisfactory results, please contact the local retailer authorized to distribute this type of product. If you can not locate the appropriate retailer, please contact Yamaha Electronics Corp., U.S.A. 6660 Orangethorpe Ave, Buena Park, CA 90620.

The above statements apply ONLY to those products distributed by Yamaha Corporation of America or its subsidiaries.

We Want You Listening For A Lifetime

YAMAHA and the Electronic Industries Association's Consumer Electronics Group want you to get the most out of your equipment by playing it at a safe level. One that lets the sound come through loud and clear without annoying blaring or distortion – and, most importantly, without affecting your sensitive hearing.

Since hearing damage from loud sounds is often undetectable until it is too late, YAMAHA and the Electronic Industries Association's Consumer Electronics Group recommend you to avoid prolonged exposure from excessive volume levels.



CAUTION: READ THIS BEFORE OPERATING YOUR UNIT.

1. To assure the finest performance, please read this manual carefully. Keep it in a safe place for future reference.
2. Install this unit in a cool, dry, clean place – away from windows, heat sources, sources of excessive vibration, dust, moisture and cold. Avoid sources of humming (transformers, motors). To prevent fire or electrical shock, do not expose the unit to rain or water.
3. Never open the cabinet. If something drops into the set, contact your dealer.
4. Do not use force on switches, controls or connection wires. When moving the unit, first disconnect the power plug and the wires connected to other equipment. Never pull the wires themselves.
5. The openings on the cover assure proper ventilation of the unit. If these openings are obstructed, the temperature inside the unit will rise rapidly. Therefore, avoid placing objects against these openings, and install the unit in a well-ventilated area to prevent fire and damage.
6. The voltage used must be the same as that specified on this unit. Using this unit with a higher voltage than specified is dangerous and may result in fire or other accidents. YAMAHA will not be held responsible for any damage resulting from the use of this unit with a voltage other than that specified.
7. Digital signals generated by this unit may interfere with other equipment such as tuners, receivers and TVs. Move this unit farther away from such equipment if interference is observed.
8. Do not attempt to clean the unit with chemical solvents; this might damage the finish. Use a clean, dry cloth.
9. Be sure to read the “Troubleshooting” section regarding common operating errors before concluding that the unit is faulty.
10. When not planning to use this unit for a long period of time (e.g., a vacation), disconnect the AC power plug from the wall outlet.
11. To prevent lightning damage, disconnect the AC power plug and disconnect the antenna cable when there is an electrical storm.
12. Grounding or polarization – Precautions should be taken so that the grounding or polarization of the unit is not defeated.
13. AC outlet
Do not connect audio equipment to the AC outlet on the rear panel if that equipment requires more power than the outlet is rated to provide.

This unit is not disconnected from the AC power source as long as it is connected to the wall outlet, even if this unit itself is turned off. This state is called the standby mode. In this state, this unit is designed to consume a very small quantity of power.

IMPORTANT

Please record the serial number of this unit in the space below.

MODEL:

Serial No.:

The serial number is located on the rear of the unit.

Retain this Owner’s Manual in a safe place for future reference.

FOR CANADIAN CUSTOMERS

To prevent electric shock, match wide blade of plug to wide slot and fully insert.

This Class B digital apparatus complies with Canadian ICES-003.



Manufactured under license from Dolby Laboratories. “Dolby”, “AC-3”, “Pro Logic”, “Surround EX” and the double-D symbol are trademarks of Dolby Laboratories.

Confidential Unpublished Works. © 1992-1997 Dolby Laboratories, Inc. All rights reserved.



Manufactured under license from Digital Theater Systems, Inc. US Pat. No. 5,451,942 and other world-wide patents issued and pending. “DTS”, “DTS Digital Surround” and “DTS ES” are trademarks of Digital Theater Systems, Inc. Copyright 1996 Digital Theater Systems, Inc. All Rights Reserved.

Contents

<i>Introduction</i>	2
Features	3
Getting Started	5
Controls and Functions	6
<i>Preparations</i>	12
Speaker System Configurations	13
Speaker Placement	14
Hookups	15
On-Screen Displays (OSD)	26
Speaker Settings	27
Speaker Output Levels	27
<i>Basic Operation</i>	30
Basic Playback	31
AM/FM Tuner	35
Basic Recording	39
<i>Advanced Operation</i>	40
SET MENU Items	41
Remote Control Features	54
Adjusting the Levels of the Effect Speakers	67
Setting the Sleep Timer	67
ZONE 2	68
<i>Additional Information</i>	70
Digital Sound Field Processing (DSP)	71
Hi-Fi DSP-Sound Field Program	72
CINEMA-DSP	73
CINEMA-DSP Sound Field Program	75
Sound Field Program Parameter Editing	77
Digital Sound Field Parameter Descriptions	78
<i>Appendix</i>	82
Troubleshooting	83
Reference Chart for the INPUT and OUTPUT Jacks	87
CINEMA - EQ Frequency Characteristics	87
Specifications	88

Introduction

Features

3

Introduction	3
Dolby Digital and Dolby Digital Surround EX	3
DTS and DTS ES	3
Comparing Surround Technologies	3
Digital Sound Fields (DSP)	4
Multi-function remote control	4
Various Input and Output Jacks	4
Built-in 8-channel power amplifier	4
Custom installation facility	4

Getting Started

5

Checking the Package Contents	5
Installing Batteries in the Remote Control	5
Using the Remote Control	5

Controls and Functions

6

Front Panel	6
Opening and Closing the Front Panel Door	7
Remote Control	8
Front Panel Display	10
Rear Panel	11

Introduction

Welcome to the exciting world of digital home entertainment. The RX-V1 is the most complete and advanced AV receiver available. Though some of the more advanced features of this unit may not be familiar to you, they are easy to use. Incorporated state-of-the-art technology such as Dolby Digital and DTS can bring the same audio experience to your home as they have brought to feature films in quality theaters around the world. To make the listening experience even more enjoyable, the RX-V1 includes a number of exclusive, digitally created listening environments known as digital sound fields. Choosing a sound field program is like transporting yourself to such venues as an outdoor arena, an European church, or a cozy jazz club. Take some time now to read more about these features and enjoy the new experiences the RX-V1 brings to your home theater.

Dolby Digital and Dolby Digital Surround EX

The RX-V1 is equipped with a Dolby Digital decoder which reproduces industry standard Dolby Digital surround sound for a cinematic audio experience in your home. Dolby Digital is a 5.1 channel format because it uses five discrete channels (left and right Main channels, Center channel, and left and right Rear channels) and a special low frequency channel (that is used only enough to merit the "0.1" channel rating) to create incredibly realistic 360° surround effects. Recently, Dolby Digital Surround EX was introduced in movie theaters as an advanced surround technology. The addition of a Rear Center channel makes front-to-back transitions more realistic. You can enjoy the newest Dolby Digital Surround EX software with the CINEMA DSP programs in the RX-V1 such as Dolby Digital/Matrix 6.1.

DTS and DTS ES

The RX-V1 is also equipped with a DTS decoder, which uses a 5.1 channel system to create a full surround sound environment. It was developed as a way to replace the analog soundtracks of movies with six channels of digital sound. In comparison with Dolby Digital, DTS uses less compression to store the sound information. The newly presented DTS ES system reproduces digital sound similar to Dolby Digital Surround EX. The use of the Rear Center speaker along with the existing 5.1 channel speakers provides a fully immersive cinematic audio experience.

Comparing Surround Technologies

To enjoy dynamic feature film sound at home, you should have the appropriate sound reproduction system for your home theater. The traditional standard for home surround systems was called Dolby Surround and consisted of four channels (left and right Main channels, a Center channel, and a Surround channel for effects). The new home theater standard is Dolby Digital and consists of 5.1 channels (left and right Main channels, a Center channel, left and right Rear channels, and an LFE (low frequency effect) channel). The newer DTS surround technology also makes use of a 5.1 channel system. The 6.1 channel system which adds a Rear Center channel to the 5.1 channel configuration is the latest advancement in surround sound technology, and is employed by Dolby Digital Surround EX and DTS ES.

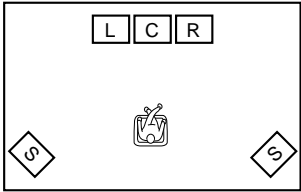
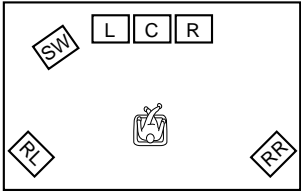
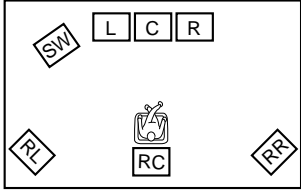
			
	Dolby Surround (Pro Logic)	Dolby Digital and DTS	Dolby Digital Surround EX and DTS ES
Reproduction Channel System	4 channels Left (L) and right (R) Main, Center (C), and Surround (S) channels	5.1 channels Left (L) and right (R) Main, Center (C), left and right Rear (RL and RR), and Subwoofer (SW) channels	6.1 channels Left (L) and right (R) Main, Center (C), left and right Rear (RL and RR), Rear Center (RC), and Subwoofer (SW) channels

Digital Sound Fields (DSP)

Technological advances in sound reproduction over the last 30 years have enhanced the listening experience with improved clarity, precision, and power. However, something has been missing: the atmosphere and acoustic ambience of the public venue. Our Yamaha engineers have extensively researched the nature of sound acoustics and the way sound reflects inside a room. We sent these engineers to famous theaters and concert halls around the world to measure the acoustics of those venues with sophisticated microphones. The data they collected is used to recreate these environments in digital sound fields. Some of these digital sound fields have been created using data measured at the original venue; others have been created from combinations of data to form unique environments for specific purposes. Some have been designed especially for music, and others especially for movies. Of course, this only solves half of the problem. Because these engineers have no way of knowing the acoustics of your entertainment room, we have made it possible for you to adjust the various parameters of this data to tailor each virtual venue to your taste. You can use these sound fields to enhance any source and in combination with any of the following surround sound technologies.

CINEMA-DSP: Dolby Digital + DSP and DTS + DSP

The Dolby Digital system and DTS system show their full capability in large movie theaters, because feature film soundtracks are designed to be reproduced in such environments. It is difficult to recreate a sound environment similar to a movie theater in your entertainment room because of the room size, wall materials, and the number of speakers in your entertainment system. Yamaha DSP technology makes it possible for you to enjoy nearly the same sound experience as that of a large movie theater in your entertainment room by compensating for lack of presence and dynamics in your entertainment room with Yamaha's original digital sound fields combined with Dolby Digital or DTS soundtracks.

Virtual CINEMA DSP and HP CINEMA DSP

Yamaha developed the Virtual CINEMA DSP algorithm which allows you to experience the virtual sound fields without surround speakers. This makes it possible for the RX-V1 to produce a full surround sound catering to the number of speakers you have. The RX-V1 also has an HP (Headphones) CINEMA DSP algorithm which is achieved by the crosstalk processing applying the precise Head Related Transfer Function. You can therefore enjoy listening to the CINEMA DSP soundfields on headphones.

Multi-function remote control

The remote control can operate other audio-video components once you program the remote control using the manufacturer code and Learn feature.

Various Input and Output Jacks

The RX-V1 has various output jacks for audio and video signals as well as a digital recording output jack. Many input jacks are also available for connection to multiple audio-video sources. All the video inputs and outputs have S-video jacks in addition to standard composite video jacks for improved video picture quality. Component video input and output jacks are also available to deliver the excellent video signals from DVD players and other high quality video sources. The coaxial and optical digital signal jacks (provided for direct transmission of digital signals) automatically detect Dolby Digital, DTS, and PCM signals. A demodulator circuit is built into the Dolby Digital RF input so you can connect it directly to the Dolby Digital RF signal output on your LD player. Additionally, there are six audio inputs for discrete multichannel reproduction from an external decoder.

The RX-V1 also comes with a monaural subwoofer jack and split subwoofer jacks which can reproduce delicate but powerful low frequency effects.

Built-in 8-channel power amplifier

Main: 110 W + 110 W (8 Ω) RMS Output Power, 0.015% THD, 20-20,000 Hz

Center: 110 W (8 Ω) RMS Output Power, 0.015% THD, 20-20,000 Hz

Rear: 110 W + 110 W (8 Ω) RMS Output Power, 0.015% THD, 20-20,000 Hz

Front: 35 W + 35 W (8 Ω) RMS Output Power, 0.05% THD, 1 kHz

Rear Center: 110 W (8 Ω) RMS Output Power, 0.015% THD, 20-20,000 Hz

Custom installation facility

You can make up a multi-room audio-video system with this unit. With this feature, you can set this unit to reproduce separate input sources in the main room and in a second (ZONE 2) room using the supplied remote control in the second room.

Checking the Package Contents

Check your package to make sure it has the following items.

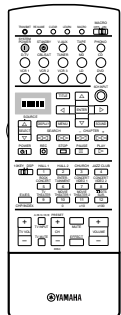

Remote Control

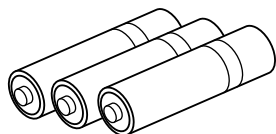

Alkaline Batteries (3) (LR6)

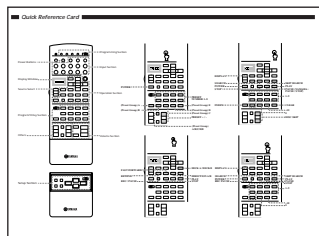

Quick Reference Guide

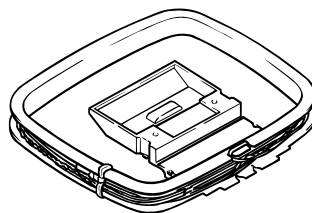

AM Loop Antenna

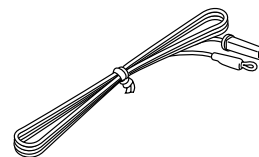

FM Antenna



Antenna Adapter
(U.S.A. and Canada Models only)

Installing Batteries in the Remote Control

Insert the batteries in the correct direction by aligning the + and – marks on the batteries with the polarity illustrations (+ and –) inside the battery compartment.

Change the batteries periodically. Do not use old batteries together with new ones.

Do not use different types of batteries (such as alkaline and manganese batteries) together. Read the packaging carefully as these different types of batteries may have the same shape and color.

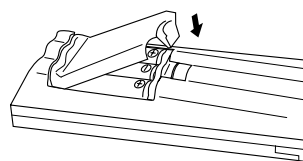
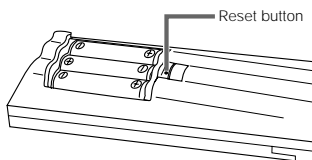
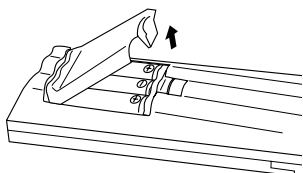

About Changing Batteries

As the batteries wear out, the operating range of the remote control decreases and the **TRANSMIT** indicator does not flash or its light becomes dim. When you notice any of these conditions, change all of the batteries.

Notes:

- If the remote control is without batteries for more than 20 minutes, or if worn out batteries remain in the unit, the contents of the memory may be cleared. If the memory is cleared, insert new batteries and reprogram any functions that may have been cleared.
- After you insert new batteries, be sure to push **RESET** in the battery compartment using a ball point pen or similar object before using the remote control. (This does not clear the contents of the memory.)

Using the Remote Control

The remote control transmits a directional infrared beam. Be sure to aim the remote control directly at the remote control sensor on the main unit during operation. When the sensor is covered or there is a large object between the remote control and the main unit, the sensor cannot receive signals. The sensor may not be able to receive signals properly when it is exposed to direct sunlight or a strong artificial light (such as a fluorescent or strobe light). In this case, change the direction of the light or reposition the main unit to avoid direct lighting.

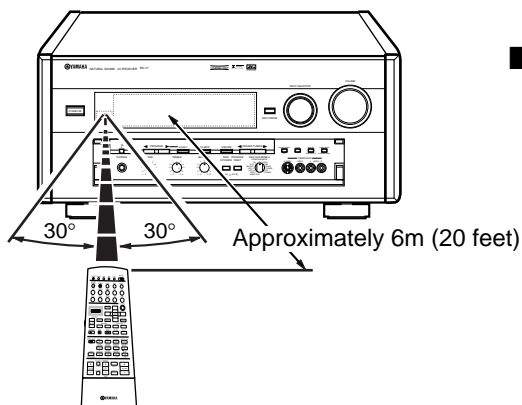

About handling the remote control

Handle the remote control with care.

Do not spill water or other liquids on the remote control.

Do not drop the remote control.

Do not leave or store the remote control in the following types of conditions:

- high humidity or temperature such as near a heater, stove or bath; or
- dusty places; or
- in places subject to extremely low temperatures.

Front Panel

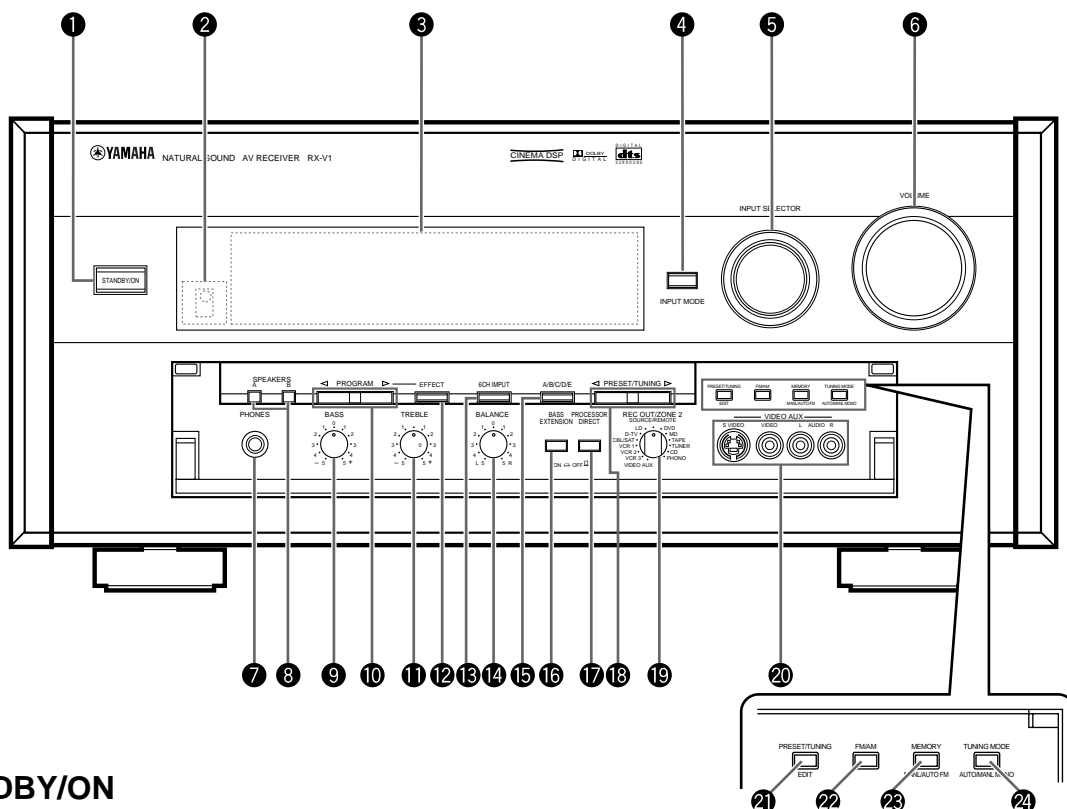

1 STANDBY/ON

Turns this unit on (On mode) and off (Standby mode). When you turn on this unit, you will hear a click and there will be a four to five to second delay before this unit can reproduce sound.

In Standby mode, this unit consumes a small amount of power so it can respond to the remote control.

2 Remote Control Sensor

Receives signals from the remote control.

3 Front Panel Display

Shows information about the operational status of this unit (see page 10).

4 INPUT MODE

Selects the mode of input for sources that output two or more types of signals to this unit (see page 33).

You cannot control the input mode when you select **6CH INPUT** as the input source.

5 INPUT SELECTOR

Selects the input source (**DVD, LD, D-TV, CBL/SAT, VCR 1, VCR 2, VCR 3, V-AUX, PHONO, CD, TUNER, TAPE, MD**) you want to listen to or watch.

6 VOLUME

Controls the output level of all audio channels. This does not affect the REC OUT level.

7 PHONES

Outputs audio signals for private listening using headphones. When you connect headphones, no signals are output to the **PREOUT** jacks or the speakers.

8 SPEAKERS A/B

When pushed in (ON), these buttons turn on the set of Main speakers connected to the **A** and/or **B** terminals on the rear panel.

9 BASS

Adjusts the low frequency response for the left and right Main speaker channels.

Turn the control to the right to increase the low frequency response and turn the control to the left to decrease the low frequency response.

If you increase or decrease the low frequency sound to an extreme level, the tonal quality from the Center, Front Effect, Rear Center, and Rear speakers may not match that of the left and right Main speakers.

10 PROGRAM </>

Selects the sound field program (see page 34). Selecting a sound field program turns on the effect.

11 TREBLE

Adjusts the high frequency response for the left and right main channels.

Turn the control to the right to increase the high frequency response and turn the control to the left to decrease the high frequency response.

If you increase or decrease the high frequency sound to an extreme level, the tonal quality from the Center, Front Effect, Rear Center, and Rear speakers may not match that of the left and right Main speakers.

12 EFFECT

Switches the effect speakers (Center, Front Effect, Rear and Rear Center) on and off. If you turn off the output of these speakers using **EFFECT**, all DTS and Dolby Digital audio signals are directed to the Main left and right channels except for the LFE channel.

When DTS or Dolby Digital signals are mixed, the left and right Main channel signal levels may not match.

13 6CH INPUT

Switches between 6CH INPUT mode and normal input modes. 6CH INPUT mode takes priority over the source selected with **INPUT SELECTOR**.

You cannot use DSP sound field programs while using an external decoder.

14 BALANCE

Controls the balance of the sound levels coming from the right and left Main speaker(s). Setting this control to the center position “0” is appropriate for most situations.

15 A/B/C/D/E

Selects one of the five preset station groups.

16 BASS EXTENSION ON/OFF

When pushed in (ON), this feature boosts the bass frequency of the left and right main channels by +6 dB (60 Hz) while maintaining overall tonal balance. This boost is useful if you do not use a subwoofer.

However, this boost may not be noticeable if the main speakers are set to “SMALL” and the bass output mode is set to “SW.”

17 PROCESSOR DIRECT ON/OFF

When pushed in (ON), **BASS**, **TREBLE**, **BALANCE**, and **BASS EXTENSION** are bypassed, eliminating any alteration of the original signal.

18 PRESET/TUNING ◀ / ▶

Selects preset stations when the colon “:” appears next to the band indication in the display, and selects the tuning frequency when the colon “:” does not appear.

19 REC OUT/ZONE2

Selects the source you want to direct to the audio/video recorder and **ZONE 2** outputs independent of the source you are listening to in the main room. When set to the **SOURCE/REMOTE** position, the input source is directed to all outputs.

20 VIDEO AUX

Inputs audio and video signals from a portable external source such as a video camera. To reproduce source signals from these jacks, select **V-AUX** as the input source. To direct this source to the **VCR 1** output jacks, select **VIDEO AUX** using **REC OUT/ZONE 2**.

21 PRESET/TUNING (EDIT)

Switches the function of **PRESET/TUNING** ◀ / ▶ (the colon “:” turns on or off).

This button is also used to exchange the places of two preset stations with each other.

22 FM/AM

Switches the reception band between FM and AM.

23 MEMORY (MAN’L/AUTO FM)

Enters a station into memory. See “Manually presetting stations” on page 36 for details. Hold down this button for more than three seconds to start automatic preset tuning. See “Automatically presetting stations” on page 37 for details.

24 TUNING MODE (AUTO/MAN’L MONO)

Switches the tuning mode between automatic and manual. To select the automatic tuning mode, press this button so that the **AUTO TUNING** indicator appears in the front panel display (the **STEREO** indicator also appears if receiving a stereo broadcast). To select the manual tuning mode, press this button so that the **AUTO TUNING** indicator does not appear.

Opening and Closing the Front Panel Door

When you are not operating the controls behind the front panel door, close the door.

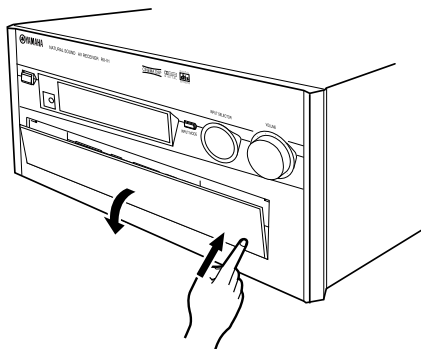

Remote Control

Power Buttons

Turn the power on and off. Press **SYSTEM POWER** to turn on the power and **STANDBY** to turn off (Standby mode) the power to the main unit.

Display Window

Shows the source component that you select to control.

Source Select

Selects the source component without switching the input.

Program/10-Key Section

Functions as the numeric buttons or DSP program group buttons.

Others

Functions vary depending on your components that are set up with the manufacturer code.

Setup Section

Sets speaker output levels, SET MENU, DSP parameters, etc.

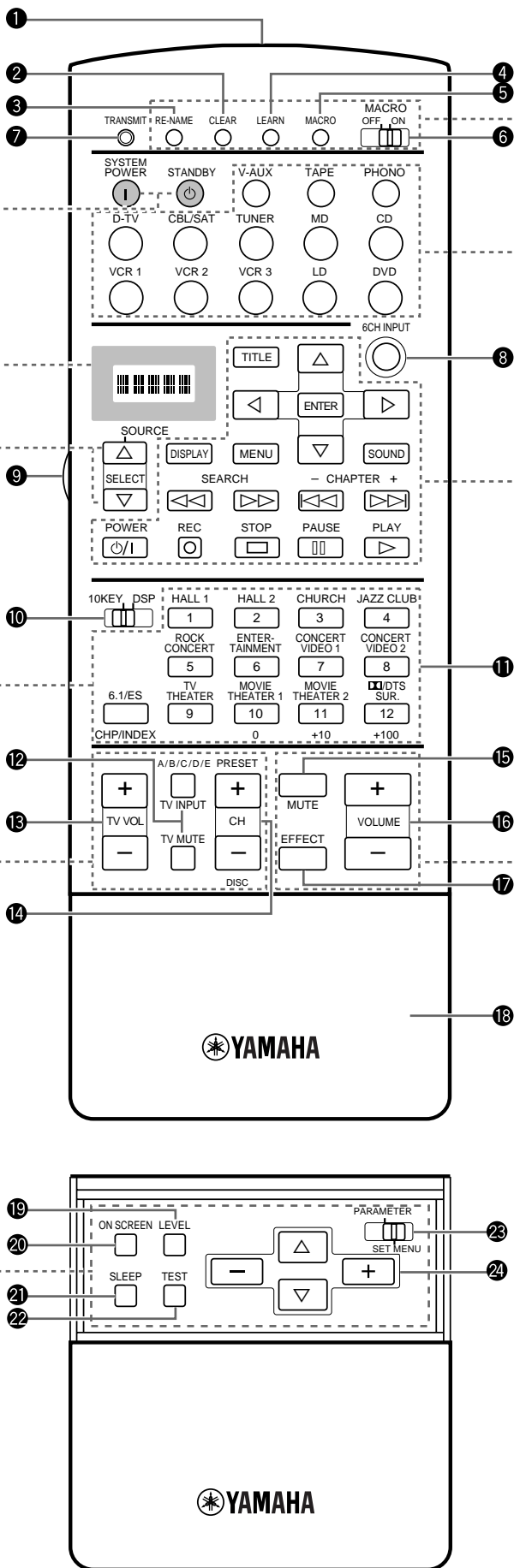

Programming Section

Provides a selection of programming types you can utilize to conveniently operate your other components.

Input Section

Selects the input source. Press an input button repeatedly to select the input mode.

Operation Section

Provides functions such as play, stop, skip, etc. for operating your other components.

Volume Section

Controls the volume.

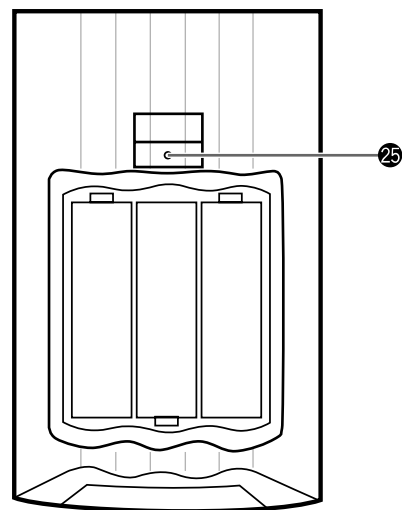

1 Infrared window

Outputs infrared control signals. Aim this window at the component you want to operate.

2 CLEAR

Used for clearing functions acquired using the Learn and Rename features, programmed macros, and preset manufacturer codes (see pages 65, 66).

3 RE-NAME

Used for changing the source name in the display window (see page 65).

4 LEARN

Used for setting up the manufacturer code or programming the functions of other remote controls (see pages 61, 62).

5 MACRO

Used to program a series of operations onto a single button (see page 63).

6 MACRO ON/OFF

Turns the macro function on and off.

7 TRANSMIT

Flashes while the remote control is sending signals.

8 6CH INPUT

Switches to the 6CH INPUT mode when using an external decoder.

9 LIGHT

Turns the light on or off.

When you press this button once, the light turns on for about ten seconds. Press again to turn off the light.

10 10KEY/DSP

Selects the numeric button (10KEY) mode or DSP mode. You can use the 13 buttons to select numbers or DSP programs directly according to the position of this switch.

11 DSP program group/Numeric buttons

Select DSP programs or numbers according to the position of 10KEY/DSP. (Press a button repeatedly to select a DSP program within that group.)

12 A/B/C/D/E

Selects one of the five preset station groups.

TV operation buttons

TV INPUT switches between TV and VCR mode.

TV MUTE mutes the TV sound.

13 TV VOL +/-

Increases or decreases the TV volume level.

14 +/-

PRESET +/- selects a preset station.

CH +/- selects the next or previous channel.

DISC +/- skips to the next or previous disc.

15 MUTE

Mutes the sound. Press again to restore audio output at the previous volume level.

16 VOLUME +/-

Increases or decreases the volume level.

17 EFFECT

Switches the effect speakers (center, front, rear, and rear center) on and off. If the output of these speakers is switched off, all DTS and Dolby Digital audio signals are directed to the main left and right channels except for the LFE channel.

18 Cover

Slides down to show the setup buttons.

19 LEVEL

Selects the effect speaker channels (center, front, rear and subwoofer) so you can adjust their level independently. Press this button repeatedly to select the effect speaker channel you want to adjust, then use + or - to adjust the level.

20 ON SCREEN

Selects the On-Screen Display mode for your video monitor.

21 SLEEP Timer

Sets the Sleep Timer. Press repeatedly to set the amount of time before the main unit is automatically turned off.

22 TEST

Selects the test mode (see page 27).

23 PARAMETER/SET MENU

Selects the PARAMETER mode or SET MENU mode.

You can use the cursor $\Delta / \nabla / + / -$ buttons to adjust DSP program parameter values or SET MENU items according to the position of this switch.

24 Cursor buttons $\Delta / \nabla / + / -$

Selects and adjusts DSP program parameters and SET MENU items according to the position of **PARAMETER/SET MENU**.

25 RESET

Press this button after you exchange batteries or when the remote control stops working properly. (Pressing **RESET** does not clear acquired functions.)

Front Panel Display

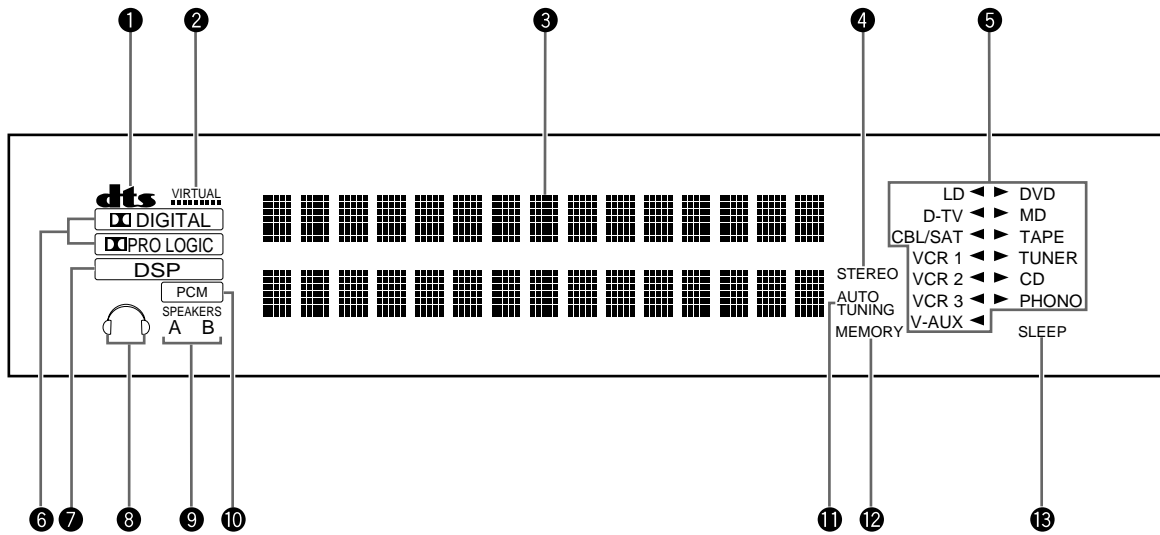

1 DTS indicator

Lights up when the built-in DTS decoder is on.

2 VIRTUAL indicator

Lights up when using Virtual Cinema DSP (See page 34.)

3 Multi-information display

Shows the current DSP program and other information when adjusting or changing settings.

4 STEREO indicator

Lights up when the AUTO TUNING indicator is on and the unit is receiving a strong signal for an FM stereo broadcast.

5 Input source indicator

Shows the current input source with the arrow-shaped cursor.

6 DIGITAL and PRO LOGIC indicators

Light up according to the type of Dolby signals this unit is reproducing.

“DIGITAL” lights up when the built-in Dolby Digital decoder is on.

“PRO LOGIC” lights up when the built-in Dolby Pro Logic Decoder is on.

7 DSP indicator

Lights up when you select a digital sound field program.

8 Headphones indicator

Lights up when headphones are connected.

9 SPEAKERS A/B indicator

Lights up according to which set of main speakers are selected. Both indicators light up when both sets of speakers are selected.

10 PCM indicator

Lights up when this unit is reproducing PCM (Pulse Code Modulation) digital audio signals.

11 AUTO TUNING indicator

Shows that the Tuner is in automatic tuning mode.

12 MEMORY indicator

Flashes to show a station can be saved.

13 SLEEP indicator

Lights up while the Sleep Timer is on.

Rear Panel

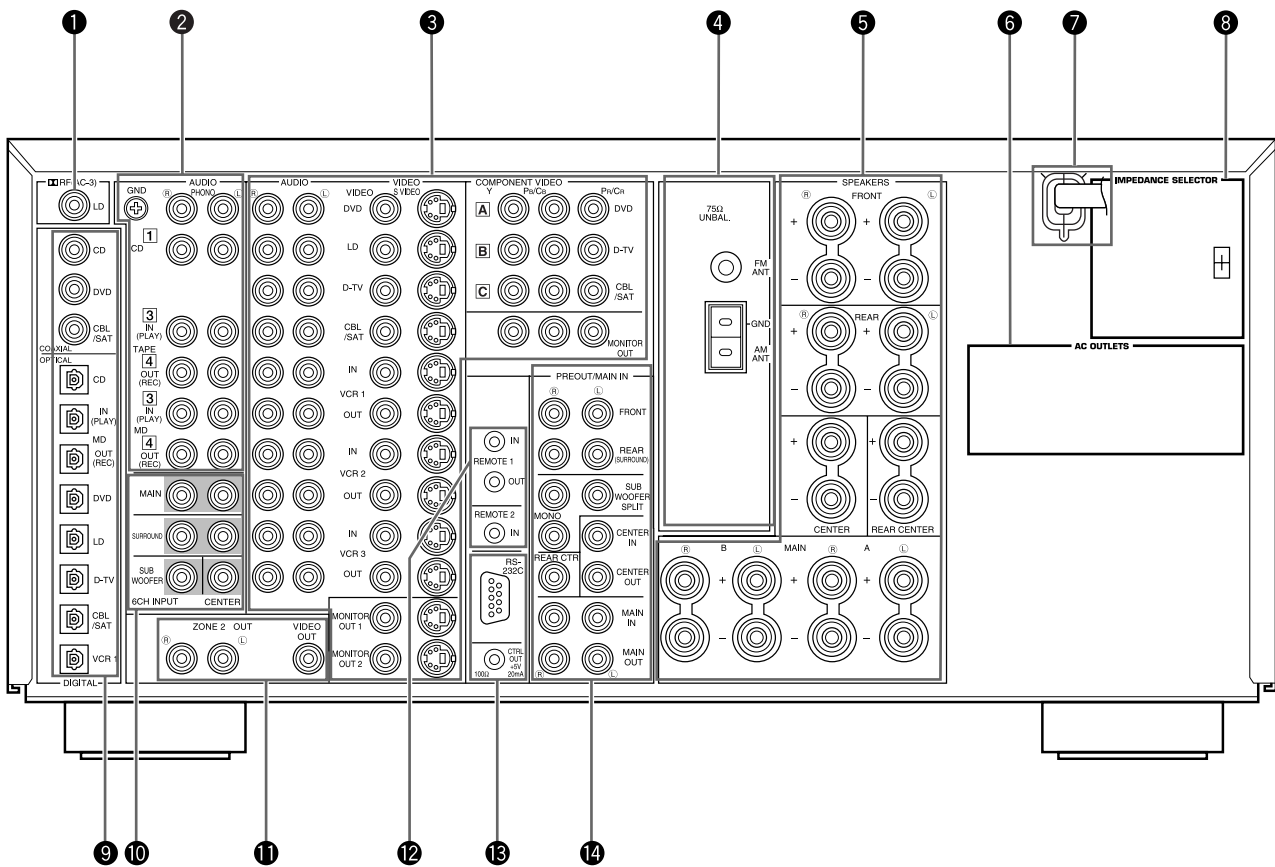

- 1** **RF (AC-3) input jack**
Connect to the RF output terminal of your LD player.
- 2** **Audio equipment jacks**
Refer to page 16 for hookup information.
- 3** **Video equipment jacks**
Refer to page 18 for hookup information.
- 4** **Antenna input terminals**
Refer to page 25 for hookup information.
- 5** **Speaker terminals**
Refer to page 20 for hookup information.
- 6** **AC OUTLETS**
Use these outlets to supply power to your other audio/video equipment.
- 7** **AC power cord**
Connect to a power outlet.
- 8** **IMPEDANCE SELECTOR**
Use this switch to match the amplifier output to your speaker impedance. Turn off the power before you change the setting of this switch (see page 22).
- 9** **DIGITAL OPTICAL/COAXIAL jacks**
Refer to page 15 for detailed information.
- 10** **6CH INPUT jacks**
Refer to page 24 for hookup information.
- 11** **ZONE 2 OUT/VIDEO OUT jacks**
Refer to page 68 for hookup information.
- 12** **REMOTE 1 IN/OUT/REMOTE 2 IN jacks**
Refer to page 68 for hookup information.
- 13** **RS232C/CTRL OUT +5V terminals**
These are control expansion terminals for commercial use. Consult your dealer for details.
- 14** **PRE OUT/MAIN IN jacks**
Refer to page 23 for hookup information.

Preparations

<i>Speaker System Configurations</i>	13
Eight or Seven Speaker Configuration –Full Cinema DSP–	13
Six Speaker Configuration –Hi Fi DSP–	13
Five Speaker Configuration –Standard 5.1 Channel–	13
Four Speaker Configuration –Minimum Requirement–	13
<i>Speaker Placement</i>	14
Placing the Main Speakers	14
Placing the Center Speaker	14
Placing the Front Effect, Rear and Rear Center Speakers	14
When You Use a Projection Screen	14
Placing the Subwoofers	14
<i>Hookups</i>	15
Connecting to Digital Jacks	15
About the Video Jacks	15
About the  RF (AC-3) Signal Input Jack	15
Connecting Audio Components	16
Connecting Video Components	18
Connecting Speakers	20
Connecting External Amplifiers	23
Connecting an External Decoder	24
Connecting Power Supply Cords	24
Connecting the Antennas	25
<i>On-Screen Displays (OSD)</i>	26
OSD Modes	26
Selecting the OSD Mode	26
<i>Speaker Settings</i>	27
Before You Begin	27
<i>Speaker Output Levels</i>	27
Dolby Surround Test	28
DSP Test	29

The most complete speaker configuration consists of eight speakers: the left and right Main speakers, a Center speaker, the left and right Rear speakers, the left and right Front Effect speakers, and a Rear Center speaker. If you do not use eight speakers, you can direct the signals for speakers that are not in your system to other speakers in your configuration. A Subwoofer can be used with any of these configurations to produce a fuller sound.

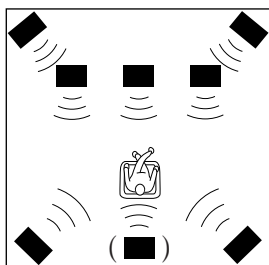
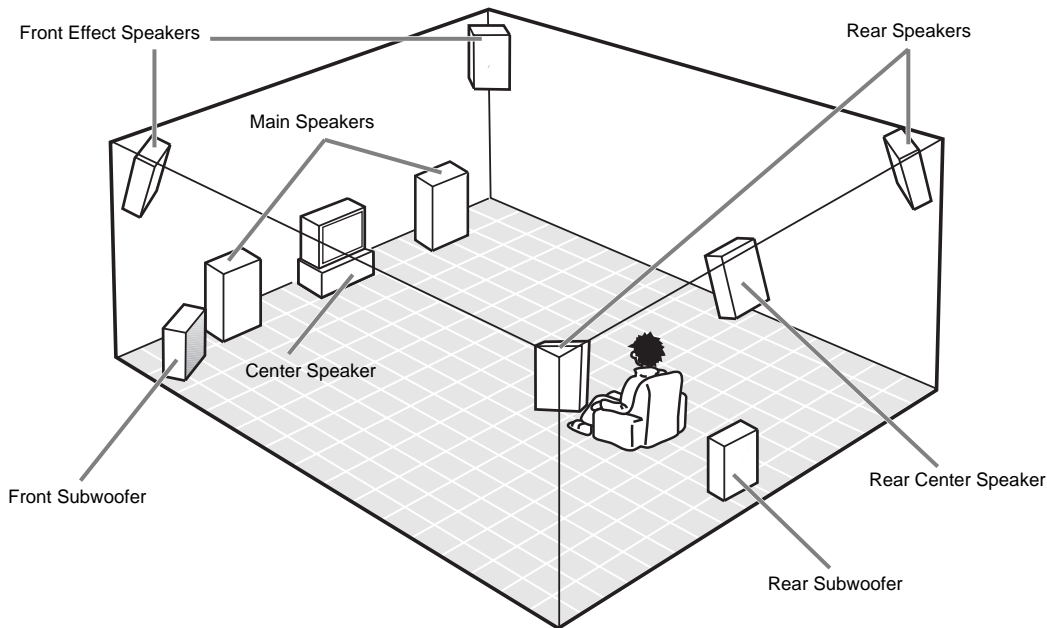

■ Eight or Seven Speaker Configuration –Full Cinema DSP–

When you reproduce feature film software, this configuration fully expresses the powerful and realistic sound qualities of 70 mm multitrack audio. The dialogue is positioned as if it were coming from directly on the screen, the sound effect is positioned slightly behind the screen, and the soundtrack music is positioned even further behind the screen to express the width and depth of the overall presentation. This configuration makes the most of this unit's capability.

The Rear Center speaker is useful for playback of Dolby Digital Surround EX or DTS ES.

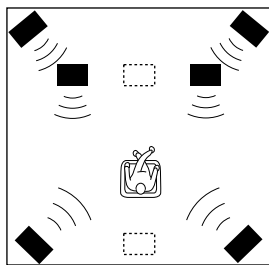

■ Six Speaker Configuration –Hi Fi DSP–

This configuration is used the most for audio playback with HiFi DSP. It does not position the dialogue sound as well as a seven or eight speaker configuration. However, it creates a dynamic DSP (Digital Sound Field Processor) sound field which adds depth to the sound.

For this speaker configuration, change SET MENU item 1A. CENTER SP to "NONE" and 1D. REAR CT SP to "NONE" (see page 41).

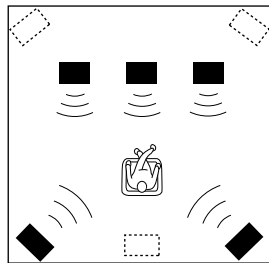

■ Five Speaker Configuration –Standard 5.1 Channel–

This configuration does not express the height of the sound field as well as the seven or eight speaker configuration. However, it positions the dialogue sound as coming directly from the screen.

For this speaker configuration, change SET MENU item 1F. FRNT EFCT SP to "NONE" and 1D. REAR CT SP to "NONE" (see page 41).

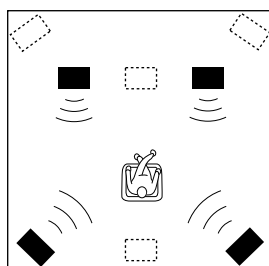

■ Four Speaker Configuration –Minimum Requirement–

In this configuration, the Center speaker signals and Front Effect speaker signals are directed to the left and right Main speakers.

For this speaker configuration, change SET MENU item 1A. CENTER SP to "NONE," item 1F. FRNT EFCT SP to "NONE," and item 1D. REAR CT SP to "NONE" (see page 41).

Where you place your speakers has a tremendous effect on how well your system sounds.



■ Placing the Main Speakers

Place the left and right Main speakers an equal distance from the main listening position.

If you have a TV or video monitor in your system, the distance of each speaker from each side of the TV or video monitor should be the same.



■ Placing the Center Speaker

If you have a TV or video monitor in your system, align the front face of the Center speaker with the front face of the monitor. Place the speaker as close to the monitor as possible, such as directly over or under the monitor. If you place the speaker under the monitor, the Front Effect speakers can adjust the height of the sound to correspond with the action on the screen (depending on the listener's position). If you have a projection screen in your system, place the Center speaker under the screen. Be sure to align the speaker with the center of the screen.

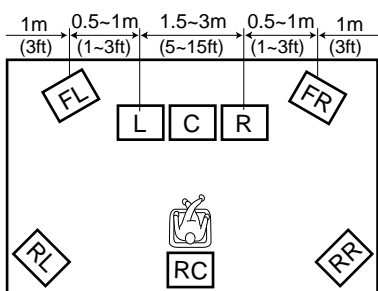

■ Placing the Front Effect, Rear and Rear Center Speakers

These speakers should be placed about 0.5~1m (1~3 feet) outside the Main speakers and in the front of the room. They should be turned toward the main listening position. Place the Rear speakers in the back of the room so they face the main listening position. The Rear speakers can be placed farther apart than the Front Effect speakers. The Front Effect and Rear speakers should be placed about 1.8m (6 feet) above the floor.

Once you begin listening to programs, continue to adjust the speaker placement until you obtain a balanced sound from the Main speakers and the Front Effect and Rear speakers.

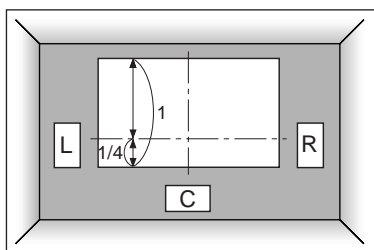

■ When You Use a Projection Screen

Place the speakers as shown in the illustration.

The Main speakers should be placed about one-quarter of the way up from the bottom of the screen.

Place the Center speaker in the center and directly under the screen. The Center speaker provides precise dialogue localization.

When you use a projection screen with your system, the Front Effect speakers provide better effect quality. The CINEMA-DSP sound field programs (see page 34) raise the sound from the Center speaker upward and provide natural sound corresponding with the video images.

■ Placing the Subwoofers

Place the Front Subwoofer near the Main speakers. Turn it slightly toward the center of the room to reduce wall reflections.

If you use a Rear Subwoofer, place it behind the main listening position. The placement of the Rear Subwoofer is not critical because of the ultralow frequencies of the sound being reproduced.

By adding a high quality Subwoofer to the speaker configurations shown on pages 21 and 22, you can enjoy more powerful and realistic movie effects, even if your Main speakers are large.

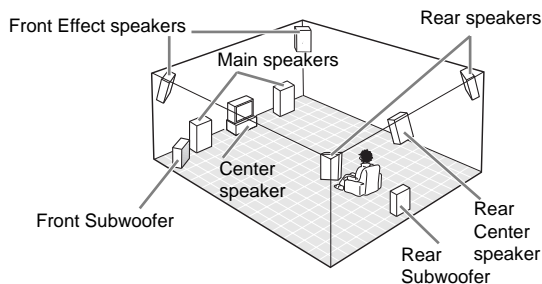

Note:

- If you use different brands of speakers (with different tonal qualities) in your configuration, the tone of a moving human voice and other types of sound may not shift smoothly. We recommend that you use speakers from the same manufacturer or speakers with the same tonal quality.

You can also adjust the output levels and equalization of your effect speakers using the SET MENU (see page 41).

If you are using small speakers, the addition of a Subwoofer will reinforce the sound effects of movies (see page 21).

Connecting to Digital Jacks

The RX-V1 has digital jacks for direct transmission of digital signals through either coaxial or fiber optic cables. You can use the digital jacks to input PCM, DTS and Dolby Digital bitstreams. When you connect components to both the **COAXIAL** and **OPTICAL** jacks (for CD, DVD, and CBL/SAT) priority is given to the input signals from the **COAXIAL** jack. All digital input jacks are acceptable for 96 kHz/24 bit digital signals.



■ About the Dust Protection Cap

Pull out the cap from the optical jack before you connect the fiber optic cable. Do not discard the cap. When you are not using the optical jack, be sure to put the cap back in place. This cap protects the jack from dust.

About the Video Jacks

There are three types of video jacks. Video signals input through the **VIDEO** jacks are the conventional composite video signals. Video signals input through the **S VIDEO** jacks are separated into luminance (**Y**) and color (**C**) video signals. The S-video signals achieve high quality color reproduction.

Video signals input through the **COMPONENT VIDEO** jacks are separated into luminance (**Y**) and color difference (**Pb/Cb**, **Pr/Cr**) video signals. The jacks are also separated into three for each signal. The description of the component video jacks may be different depending on the component (e.g. Y, Cb, Cr / Y, Pb, Pr / Y, B-Y, R-Y/ etc.). Component video signals provide the best quality in picture reproduction.

Composite **VIDEO** terminal



S VIDEO terminal



COMPONENT VIDEO terminals

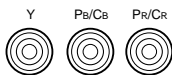





Note:

- Each type of video jack works independently. Signals input through the composite video, S-video, and component jacks are output through the corresponding composite video, S-video, and component jacks respectively.

Caution:

- Use a commercially available S-video cable when connecting to the **S VIDEO** jacks, and commercially available video cables when connecting to the **COMPONENT VIDEO** jacks.
- When you are using the **COMPONENT VIDEO** jacks, check the details in the owner's manual that came with the component being connected.

About the RF (AC-3) Signal Input Jack

If your LD player has an  RF (AC-3) signal output jack, connect it to the  RF (**AC-3**) input jack on this unit. If  RF (AC-3) and analog signals are input at the same time, priority is given to the RF signals. When you want to reproduce  RF (AC-3) signals, set the input mode to "D.D. RF" using **INPUT MODE**.



Note:

-  RF (AC-3) signals cannot be output using the **REC OUT** selector. When you record sound or images from an LD player, be sure to connect the player to either the **DIGITAL OPTICAL** or analog **AUDIO** jacks.

Caution:

- Even if you connect an LD player with an  RF (AC-3) output jack to this unit, you cannot reproduce Dolby Digital sound from all LD discs. You must playback an LD disc encoded with Dolby Digital signals in order to take advantage of the Dolby Digital sound.

Connecting Audio Components

Before you connect any components, disconnect the power supply to all the components you plan to connect including the RX-V1 and determine which jacks are for the left and right channels and for input and output.

When you connect other YAMAHA audio equipment (such as a CD player or changer, MD deck, or tape deck, connect to terminals with the same number labels. Yamaha applies this labelling system to all its products.

In the hookup illustrations on the following pages:

- ➔ indicates signal direction,
- [C]— indicates coaxial cables,
- [L]— indicates left side analog cables,
- [R]— indicates right side analog cables,
- [O]— indicates optical cables; and,
- [S]— indicates S-video cables.

After you finish all hookups, check them again to make sure they are correct.

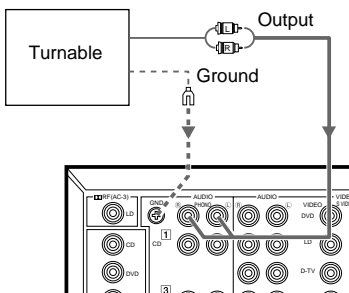

■ Connecting a Turntable

- 1 Connect the left and right signal output cords to the **PHONO** (L) and (R) jacks.

Note:

- These jacks are for connecting a turntable with an MM or high output MC cartridge. If you have a turntable with a low output MC cartridge, use an inline boosting transformer or MC-head amplifier when connecting to these jacks.

Caution:

- The GND terminal does not electrically ground the turntable. It simply reduces noise in the signal. In some cases, you may hear less noise if you do not connect to the GND terminal.

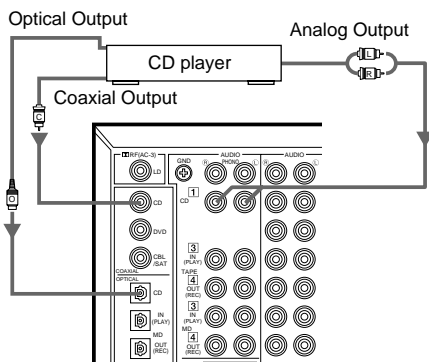

■ Connecting a CD Player

- 1 Connect the left and right analog signal output jacks on your CD player to the **CD** (L) and (R) jacks.

Notes:

- The **COAXIAL CD** and **OPTICAL CD** jacks are available for a CD player which has coaxial or optical digital outputs.
- When you connect a CD player to both the **COAXIAL CD** and **OPTICAL CD** jacks, priority is given to the input signals from the **COAXIAL CD** jack.
- The **OPTICAL** jacks on this unit conform to the EIA standard. If you use a fiber optic cable that does not conform to this standard, the RX-V1 may not function properly.

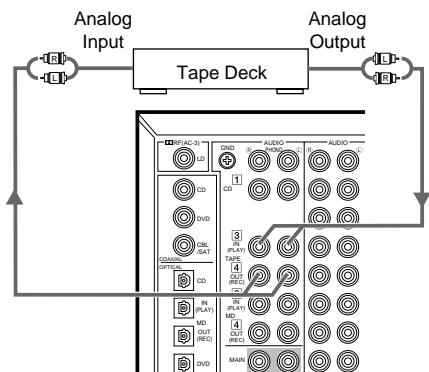

■ Connecting a Tape Deck

- 1 Connect the left and right signal output jacks on your tape deck to the **TAPE 3 (PLAY)** L and R jacks.
- 2 Connect the left and right signal input jacks on your tape deck to the **TAPE 4 (REC)** L and R jacks.

Notes:

- You can monitor audio recordings if you connect a three-head tape deck to the **TAPE 3 (PLAY)** jacks.
- When you connect a tape deck to the RX-V1, keep the deck's power on while using the RX-V1. If the power is off, the RX-V1 may distort the sound from other equipment.
- When you record from source equipment connected to the RX-V1 while the RX-V1's power is off, the recorded sound may be distorted. To avoid this problem, turn on the RX-V1.

■ Connecting an MD or DAT Deck

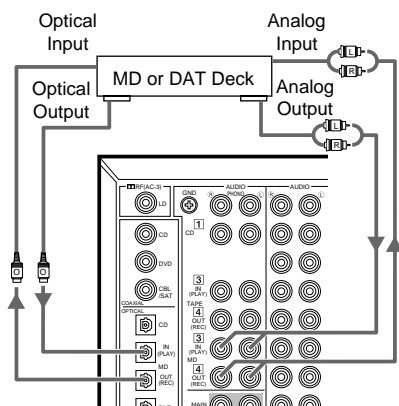

- 1 Connect the left and right analog signal output jacks on your MD or DAT deck to the **MD 3 (PLAY)** L and R jacks.
- 2 Connect the left and right analog signal input jacks on your MD or DAT deck to the **MD 4 (REC)** L and R jacks.
- 3 Connect the optical digital signal output jack on your MD or DAT deck to the **OPTICAL MD (PLAY)** jack.
- 4 Connect the optical digital signal input jack on your MD or DAT deck to the **OPTICAL MD (REC)** jack.

Note:

- When you connect your MD or DAT deck to both the analog and digital input and output jacks, priority is given to the digital signals.

Connecting Video Components

Before you connect any components, disconnect the power supply to all the components you plan to connect including the RX-V1 and determine which jacks are for the left and right channels and for input and output. After you finish all hookups, check them again to make sure they are correct.

Note:

- If you make S-video connections to this unit, it is not necessary to make composite video connections. If both types of connections are made, this unit gives priority to the S-video signal.

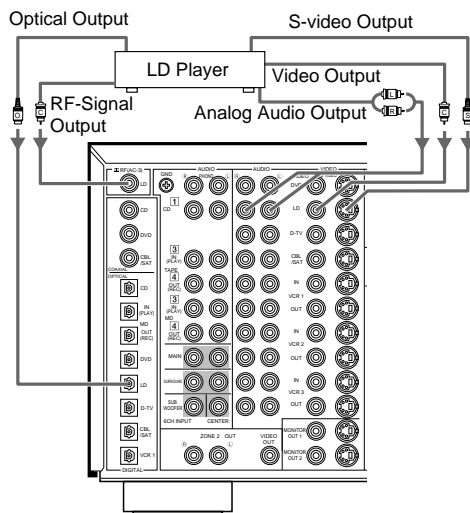

Connecting an LD Player

- 1 Connect the left and right audio signal output jacks on your LD player to the **LD L** and **LD R** jacks.

If your LD player has an RF signal or optical digital signal outputs, you can connect them to this unit.

Connect the RF signal output jack on your LD player to the **RF (AC-3) LD** jack.

Connect the optical digital signal output jack on your LD player to the **OPTICAL LD** jack.

- 2 Connect the composite video signal output jack on your LD player to the **LD VIDEO** jack.

If your LD player has an S-video output, you can connect it to this unit. Connect the S-video signal output jack on your LD player to the **LD S VIDEO** jack.

Connecting a TV or Digital TV

- 1 Connect the left and right analog signal output jacks on your TV to the **D-TV L** and **D-TV R** jacks.

If your TV has an optical digital signal output, you can connect it to this unit.

Connect the optical digital signal output jack on your TV to the **OPTICAL D-TV** jack.

- 2 Connect the composite video signal output jack on your TV to the **D-TV VIDEO** jack.

If your TV has an S-video output or component video output, you can connect it to this unit.

Connect the S-video signal output jack on your TV to the **D-TV S VIDEO** jack or connect the component signal output jacks on your TV to the **D-TV COMPONENT VIDEO** jacks.

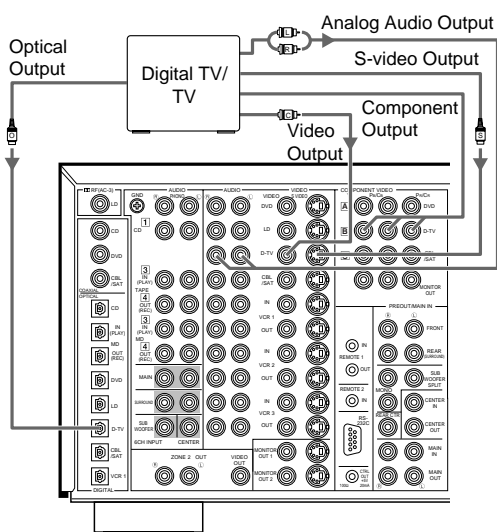

Connecting a Satellite Tuner or Cable TV Tuner (Set Top Box)

- 1 Connect the left and right audio signal output jacks on your tuner to the **CBL/SAT L** and **CBL/SAT R** jacks.

If your tuner has coaxial or optical digital signal outputs, you can connect them to this unit.

Connect the coaxial digital signal output jack on your tuner to the **COAXIAL CBL/SAT** jack.

Connect the optical digital signal output jack on your tuner to the **OPTICAL CBL/SAT** jack.

- 2 Connect the composite video signal output jack on your tuner to the **CBL/SAT VIDEO** jack.

If your tuner has an S-video or component video output, you can connect it to this unit. Connect the S-video signal output jack on your tuner to the **CBL/SAT S VIDEO** jack or connect the component signal output jacks on your tuner to the **CBL/SAT COMPONENT VIDEO** jacks.

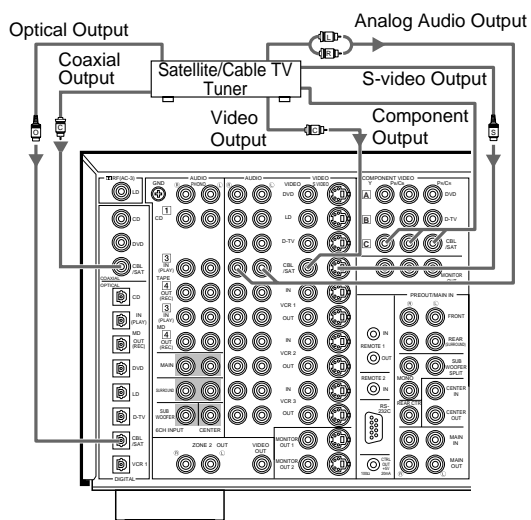

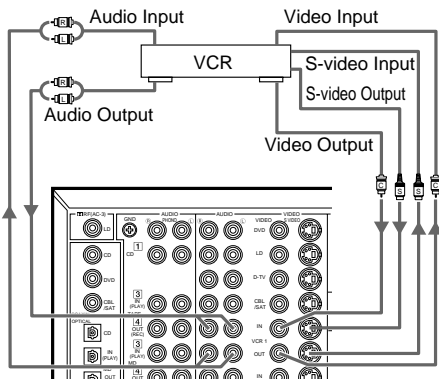

■ Connecting a VCR

- 1 Connect the left and right audio signal output jacks on your VCR to the **VCR 1 IN** (L) and (R) jacks.
 - 2 Connect the left and right audio signal input jacks on your VCR to the **VCR 1 OUT** (L) and (R) jacks.
 - 3 Connect the composite video signal output jack on your VCR to the **VCR 1 VIDEO IN** jack.
- If your VCR has an S-video input, you can connect it to this unit. Connect the S-video signal output jack on your VCR to the **VCR 1 IN S VIDEO** jack.
- 4 Connect the composite video signal input jack on your VCR to the **VCR 1 VIDEO OUT** jack.

If your VCR has an S-video input, you can connect it to this unit. Connect the S-video signal input jack on your VCR to the **VCR 1 OUT S VIDEO** jack.

Notes:

- You can connect other VCRs to the RX-V1 using the **VCR 2** and **VCR 3** jacks.
- If your VCR has an optical digital signal output jack, connect it to the **OPTICAL VCR 1** jack of this unit.

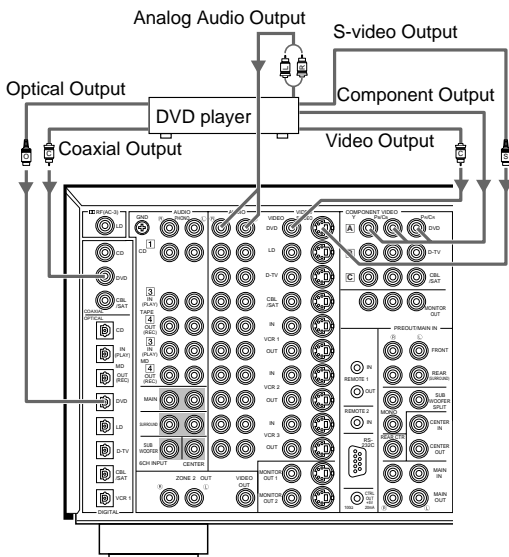

■ Connecting a DVD Player

- 1 Connect the left and right analog signal output jacks on your DVD player to the **DVD** (L) and (R) jacks.
- If your DVD player has coaxial or optical digital outputs, you can connect one or both of them to this unit. Connect the coaxial digital signal output jack on your DVD player to the **COAXIAL DVD** jack. Connect the optical digital signal output jack on your DVD player to the **OPTICAL DVD** jack.
- 2 Connect the composite video signal output jack on your DVD player to the **DVD VIDEO** jack.
- If your DVD player has an S-video output or component video output, you can connect it to this unit. Connect the S-video signal output jack on your DVD player to the **DVD S-VIDEO** jack or connect the component signal output jacks on your DVD player to the **DVD COMPONENT VIDEO** jacks.

■ Connecting a Video Monitor

- 1 Connect the composite video signal input jack on your monitor to **MONITOR OUT 1 VIDEO** jack.
- If your video monitor has an S-video input, you can connect it to this unit. Connect the S-video signal input jack on your video monitor to the **MONITOR OUT 1 S-VIDEO** jack.
- If your video monitor has component video signal inputs, you can connect them to the **COMPONENT VIDEO MONITOR OUT** jacks.

Note:

- You can connect another monitor to this unit using the **MONITOR OUT 2** jacks.

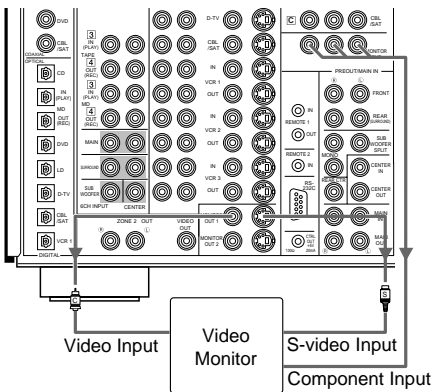

Connecting Speakers

This section explains how to connect speakers to the RX-V1. After you finish connecting your speakers, use the SET MENU to change the signal output settings according to the number and size of the speakers in your configuration.

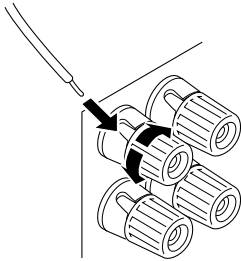

BANANA PLUG

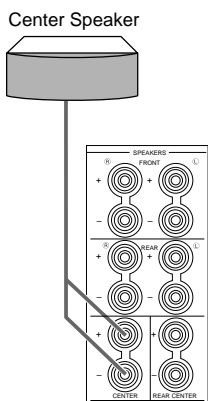
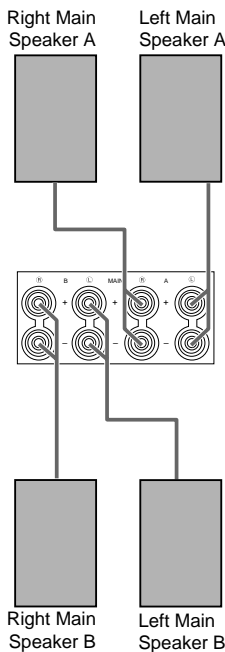
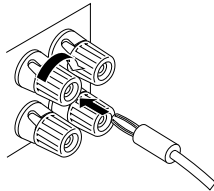

Using Speaker Cords

A speaker cord is actually a pair of insulated cables running side by side. One of the cables is colored or shaped differently, perhaps with a stripe, groove or ridge. To make sure you always connect speakers with the correct polarity, determine the difference between the cables of your speaker cord, make a note of which cable you plan to use for which polarity (+ and -), and always connect the speaker cords consistently.

- 1 Strip off 9 mm (3/8 in.) of an inch of insulation from the ends of the cables.
- 2 Twist the exposed wires of the cable together to prevent short circuits.
- 3 Loosen the terminal knob by turning it counterclockwise.
- 4 Insert only the exposed portion of the cable into the slot in the side of the terminal, and tighten the terminal knob.

Note:

- If your speaker cords have banana plugs, tighten the terminal knob and insert the plug into the end of the terminal.

Caution:

- Connect the speaker cords with care to avoid creating a short circuit. If you turn on the power and there is a short circuit, this unit may be damaged even though the protection circuit automatically shuts off the power.

Connecting the Main Speakers

Before connecting any speaker cords, identify which terminals are for the right and left channels and also the + and - polarities. If you connect speakers with the wrong polarity (+ to -), the RX-V1 will not reproduce clear sound.

- Connect the + and - terminals of your right and left Main speakers to the **L** and **R MAIN +** and - terminals on this unit.

Connecting the Center Speaker

- Connect the + terminal of your Center speaker to the **CENTER +** terminal and the - terminal of your Center speaker to the **CENTER -** terminal.

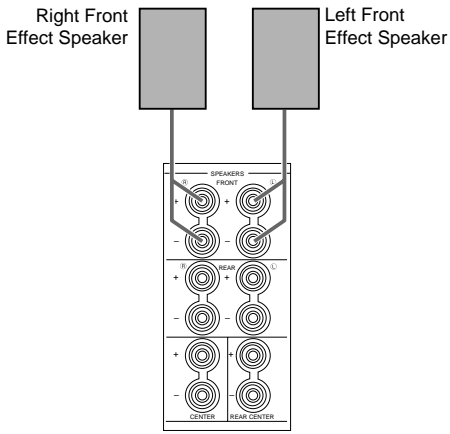

■ Connecting the Front Effect Speakers

- 1 Connect the **+** and **-** terminals of your right and left Front Effect speakers to the **Ⓐ** and **Ⓑ** **FRONT +** and **-** terminals on this unit.

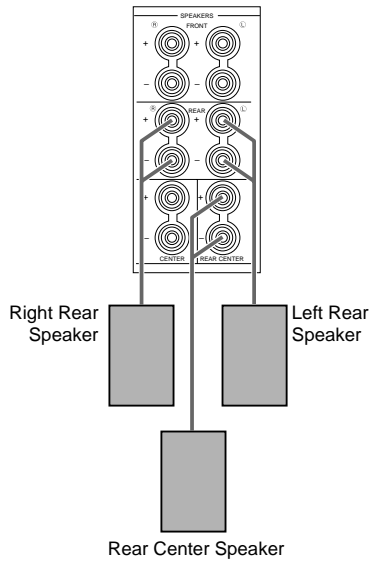

■ Connecting the Rear and Rear Center Speakers

- 1 Connect the **+** and **-** terminals of your right and left Rear speakers to the **Ⓐ** and **Ⓑ** **REAR +** and **-** terminals on this unit.
- 2 Connect the **+** terminal of your Rear Center speaker to the **REAR CENTER +** terminal and the **-** terminal of your Rear Center speaker to **REAR CENTER -** terminal.

Subwoofer system

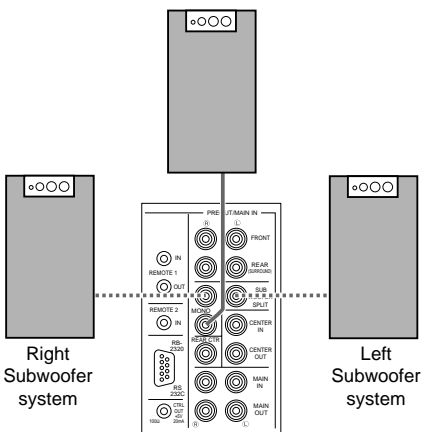

■ Connecting a Front Subwoofer

- 1 Connect the signal input jack on your subwoofer to the **PRE OUT/MAIN IN SUBWOOFER MONO** jack.

By connecting two Subwoofers to the **SUBWOOFER SPLIT** jacks, this unit can reproduce subtle directional changes in the low frequency sounds. When you use two Subwoofers, connect both of them to the **SUBWOOFER SPLIT** jacks using pin plugs.

Caution:

- The **SUBWOOFER** jacks (output) have a built-in high cut-off filter (90 Hz). When using a powered subwoofer, set the high cut-off frequency to "MAX" on your Subwoofer.

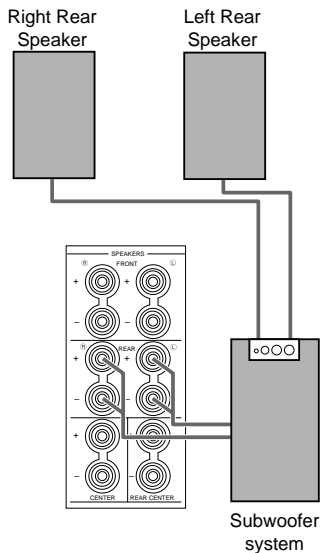

■ Connecting a Rear Subwoofer

By using both Front and Rear Subwoofers, the CINEMA-DSP sound field programs can produce realistic movie effects with powerful, dynamic sound. To take advantage of this dynamic sound, be sure to set the 1C. REAR L/R SP item in the SET MENU to "LARGE" (see page 41), and connect your Rear speakers and Subwoofer as shown below.

- 1 Connect the right + input terminal on your Subwoofer to the **REAR** **R** + terminal, and the right - input terminal on your Subwoofer to the **REAR** **R** - terminal with speaker cords.
- 2 Connect the left + input terminal on your Subwoofer to the **REAR** **L** + terminal, and the left - input terminal on your Subwoofer to the **REAR** **L** - terminal with speaker cords.
- 3 Connect your Rear speakers to the output terminals on the Rear Subwoofer.

Be sure to connect the Rear speakers to the Subwoofer with the correct polarity.

Note:

- Adjust the speaker volume for the Subwoofer with the controls on the Subwoofers, not on the RX-V1.

WARNING

Do not change the **IMPEDANCE SELECTOR** switch setting while the power to this unit is on, otherwise this unit may be damaged.

IF THIS UNIT FAILS TO TURN ON WHEN THE STANDBY/ON SWITCH IS PRESSED:

The **IMPEDANCE SELECTOR** switch may not be set to either end. If so, set the switch to either end when this unit is in the standby mode.

■ Impedance Selector switch

Select the position whose requirements your speaker system meets.

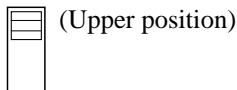

Front Effect:

The impedance of each speaker must be 6Ω or higher.

Rear: The impedance of each speaker must be 4Ω or higher.

Rear Center:

The impedance of the speaker must be 4Ω or higher.

Center: The impedance of the speaker must be 4Ω or higher.

Main: If you use one pair of main speakers, the impedance of each speaker must be 4Ω or higher.

If you use two pairs of main speakers, the impedance of each speaker must be 8Ω or higher.

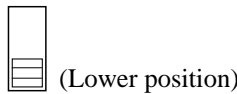

Front Effect:

The impedance of each speaker must be 8Ω or higher.

Rear: The impedance of each speaker must be 8Ω or higher.

Rear Center:

The impedance of the speaker must be 8Ω or higher.

Center: The impedance of the speaker must be 8Ω or higher.

Main: <Except Canada model>

If you use one pair of main speakers, the impedance of each speaker must be 8Ω or higher.

If you use two pairs of main speakers, the impedance of each speaker must be 16Ω or higher.

<For Canada model only>

The impedance of each speaker must be 8Ω or higher.

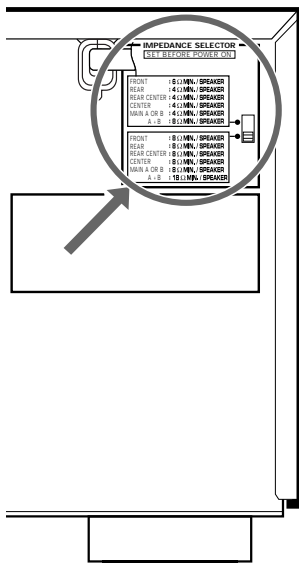

Connecting External Amplifiers

If you want to increase the power output to the speakers, or want to use another amplifier, connect an external amplifier to the **PRE OUT/MAIN IN** terminals as follows.

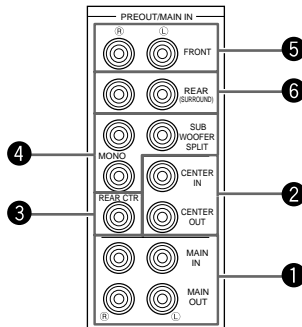

1 MAIN jacks

MAIN OUT jack Main channel line output jacks.
The signals output through these jacks are affected by **BASS, TREBLE, BALANCE,** and **BASS EXTENSION** settings.

MAIN IN jacks Line input to the RX-V1 Main channel amplifiers.

2 CENTER jacks

CENTER OUT jack . Center channel line output jacks.
CENTER IN jack Line input to the RX-V1 Center channel amplifier.

3 REAR CT jack

Rear Center channel line output jack.

4 SUBWOOFER jacks

Subwoofers reinforce very low frequencies.
MONO Main, Center and Rear channel frequencies below 90 Hz are output through this jack. You can also direct DTS and Dolby Digital LFE signals to this output.

SPLIT The **SPLIT** jacks output stereo separation for the Main and Rear channels and a split mono signal for the Center and LFE channels.

Adjust the volume level of the subwoofer with the control on the subwoofer. Subwoofer volume cannot be adjusted from this unit. Depending on the settings in SET MENU items 1. SPEAKER SET, 3A. LFE LEVEL and 4A. LFE LEVEL, some signals may not be output from the **SUBWOOFER** jacks.

5 FRONT

Front Effect channel line output jacks.

6 REAR (SURROUND)

Rear channel line output jacks.

Note:

- When RCA pin plugs are connected to the **PRE OUT/MAIN IN** output jacks for output to external amplifiers, the corresponding internal amplifiers will be muted.

Connecting an External Decoder

The RX-V1 is equipped with six additional input jacks (left and right MAIN, CENTER, left and right SURROUND and SUBWOOFER) for discrete multi-channel input from an external decoder, sound processor, or pre-amplifier.

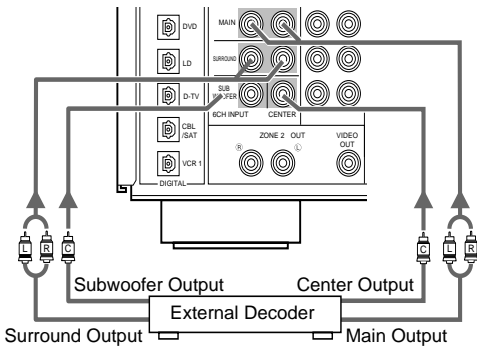

- Connect the output jacks on your external decoder to the **6CH INPUT** jacks.

Be sure to match the left and right outputs to the left and right input jacks for the main and surround channels.

To listen to the sound from your external decoder, press **6CH INPUT** on this unit or the remote control.

Note:

- When you select **6CH INPUT** as the input source, this unit automatically turns off the digital sound field processor, and you cannot listen to DSP programs.

Preparations

Connecting Power Supply Cords

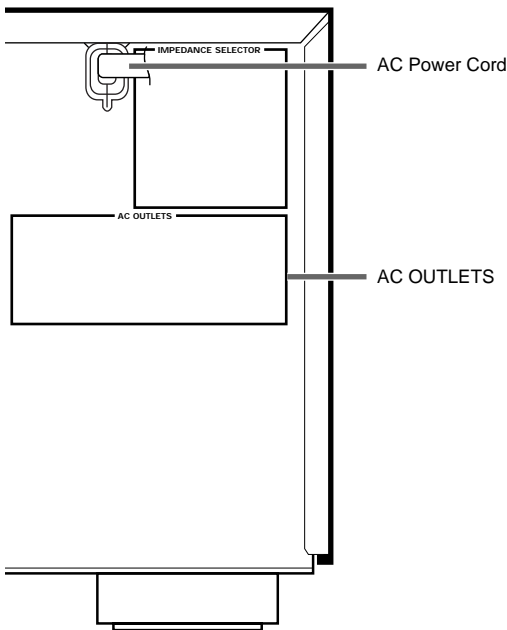

■ Connecting the AC Power Cord

After completing all connections, plug the AC power cord into a convenient AC outlet.

■ AC OUTLETS

Use these to connect the power cords from your other components to this unit. The power to the switched outlets is controlled by this unit's **STANDBY/ON** (**SYSTEM POWER ON** or **STANDBY** on the remote). These outlets will supply power to any connected unit whenever this unit is turned on. The maximum power (total power consumption of components) that can be connected to **AC OUTLETS** is 100 W (U.S.A. and Canada model) or 120 W (Australia model).

Connecting the Antennas

Both AM and FM indoor antennas are included with this unit. These antennas should provide sufficient signal strength in most situations. However, a properly installed outdoor antenna provides clearer reception. If you experience poor reception quality using the indoor antennas, an outdoor antenna may improve the reception.

Connect each antenna as shown below.

Indoor FM antenna (included)

■ Connecting the indoor FM antenna

Connect the included indoor antenna to the **75Ω UNBAL. FM ANT** terminal.

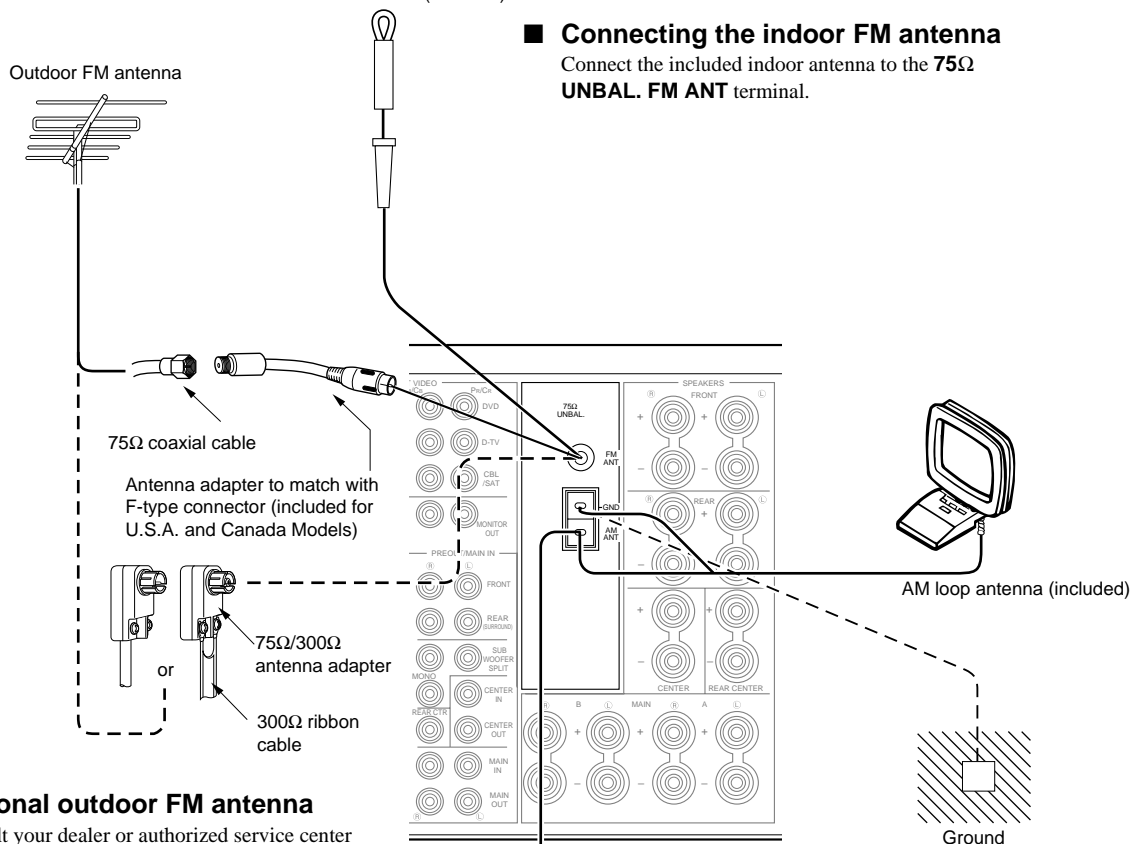

■ Optional outdoor FM antenna

Consult your dealer or authorized service center about the best method of selecting and erecting an outdoor FM antenna.

■ Optional outdoor AM antenna

If this unit is in a steel building or at a great distance from the transmitter, it may be necessary to install an outdoor AM antenna.

■ Connecting the AM loop antenna

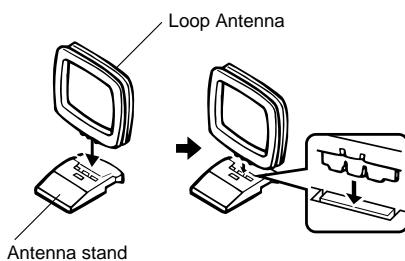
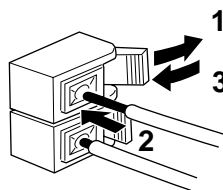

- 1 Press the tab to unlock the terminal hole.
- 2 Insert the AM loop antenna lead wires to the **AM ANT** and **GND** terminals.
- 3 Lift the tab to its original position to lock the lead wires.
Lightly pull on the lead wires to confirm a good connection.
- 4 Attach the loop antenna to the antenna stand.
- 5 Orient the AM loop antenna so that the best reception is obtained.

Notes:

- The AM loop antenna should be placed away from this unit. The antenna may be hung on a wall.
- The AM loop antenna should remain connected, even if an outdoor AM antenna is connected to this unit.
- To minimize the influence of automobile ignition noise, locate the antenna as far from heavy traffic as possible.
- Keep the ribbon cable or coaxial cable as short as possible.
Do not bundle or roll up excess cable.
- The antenna should be at least 1.8m (6 feet) from reinforced concrete walls and metallic structures.

On-Screen Displays (OSD)

You can display the operation information for this unit on a video monitor. If you display the SET MENU and DSP sound field program parameter settings on a screen, it is much easier to see the available options and parameters than it is by reading this information on the front panel display.

If a video source is being reproduced, the OSD is superimposed over the image.

If a video source is not being reproduced (or the power of the source equipment is off), the OSD is shown on a blue background.

OSD Modes

You can change the amount of information the OSD shows.

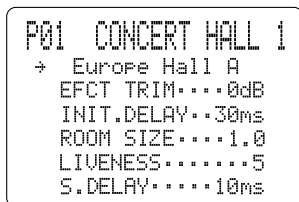

Full Display



Short Display

Full Display This mode always shows the sound field program parameter settings on the video monitor (see page 77).

Short Display This mode briefly shows the same contents as the front panel display at the bottom of the screen, then disappears.

Display Off This mode briefly shows the "DISPLAY OFF" message at the bottom of the screen, then disappears. Afterwards, no changes to operations appear on the screen except those of the **ON SCREEN**.

Notes:

- When you choose the Full Display mode, **INPUT SELECTOR**, **VOLUME** and some other types of operation information are displayed at the bottom of the screen in the same format as the front panel display.
- The OSD signal is not output through the **REC OUT** Selector, and will not be recorded with any video signal.
- The SET MENU, TEST DOLBY SUR and TEST DSP appear regardless of the OSD mode.

Selecting the OSD Mode

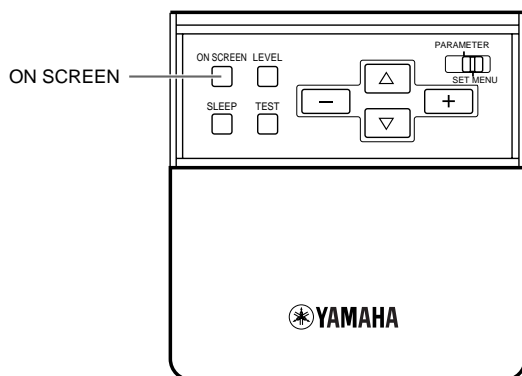

1 When you turn on the power, the video monitor and front panel display shows the level of the main volume for a few seconds and then switches to show the current sound field program.

2 Press **ON SCREEN** on the remote control repeatedly to change the display mode.

The OSD mode changes in the following order: Full Display, Short Display, and Display Off.

Caution:

- If you choose a video input source that has equipment connected to both the **S VIDEO IN** and composite **VIDEO IN** jacks, and both the **S VIDEO OUT** and composite **VIDEO OUT** jacks are connected to a video monitor, the video signal is output to both the **S VIDEO OUT** and **VIDEO OUT** jacks. However, the OSD is carried only on the S-video signal. If no video signal is input, the OSD is carried on both the S-video and composite video signals.
- If your video monitor is connected only to the **COMPONENT VIDEO** terminals of this unit, the OSD is not shown. Make sure to connect your video monitor to the **COMPONENT VIDEO** terminal and either **VIDEO** or **S VIDEO** terminals if you would like to see the OSD.
- Playing back video software that has an anti-copy signal or video signals with a lot of noise may produce unstable images.

Speaker Settings

The RX-V1 has seven SPEAKER SET items in the SET MENU that you must set according to the number of speakers in your configuration and their size. The following table summarizes these SPEAKER SET items, and shows the initial settings as well as other possible settings. If the initial settings are not appropriate for your speaker configuration, change the settings in the SET MENU (see page 41).

Summary of SPEAKER SET items 1A through 1G.

Item	Description	Initial Setting
1A. CENTER SP	Selects the Center channel output mode according to the size of the Center speaker. The possible settings are LRG (large), SML (small) and NONE.	LRG
1B. MAIN SP	Selects the Main channel output mode according to the size of the Main speakers. The possible settings are LARGE and SMALL.	LARGE
1C. REAR L/R SP	Selects the Rear channel output mode according to the size of the Rear speakers. The possible settings are LRG (large), SML (small) and NONE.	LRG
1D. REAR CT SP	Selects the Rear center channel output according to the size of the Rear Center speaker. The possible settings are LRG (large), SML (small) and NONE.	LRG
1E. LFE/BASS OUT	Selects a speaker for the LFE/Bass signal output. The possible settings are SW (subwoofer), MAIN, and BOTH.	BOTH
1F. FRNT EFCT SP	Selects the Front Effect signal output mode for the Front Effect signals. The possible settings are YES and NONE.	YES
1G. MAIN LEVEL	Selects the output level for the Main channel signal. The possible settings are Normal and -10 dB.	Normal

Speaker Output Levels

This section explains how to set the speaker output levels using the test tone generator. The Dolby Surround test is for balancing the output levels of the six speakers required for surround sound systems. The DSP test is for balancing the Front Effect speakers with the Main speakers for the DSP sound field programs.

Before You Begin

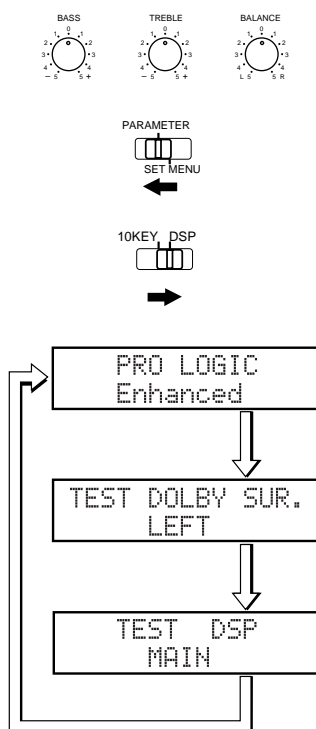

- 1 Set **BASS**, **TREBLE** and **BALANCE** on the front panel to “0” (the center position) and turn off **BASS EXTENSION**.
- 2 Sit in the main listening position and set **PARAMETER/SET MENU** on the remote control to **PARAMETER**.
- 3 Set **10KEY/DSP** on the remote control to **DSP** and press **10KEY / DTS SUR**.
- 4 Press **TEST** on the remote control once or twice to select the test you want.
 - Select “TEST DOLBY SUR.” to match the output levels of the Center, Rear Center and left and right Rear speakers to the left and right Main speakers.
 - Select “TEST DSP” to match the output levels of the Front Effect speakers to the Main speakers.

Dolby Surround Test

Use the Dolby Surround Test to balance the output levels of speakers required for surround sound systems.

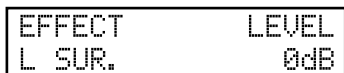
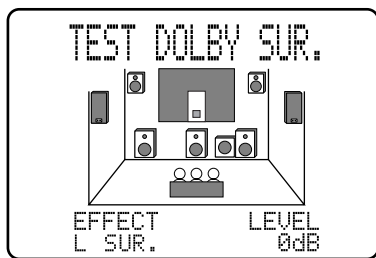
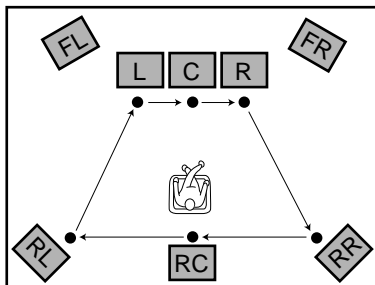
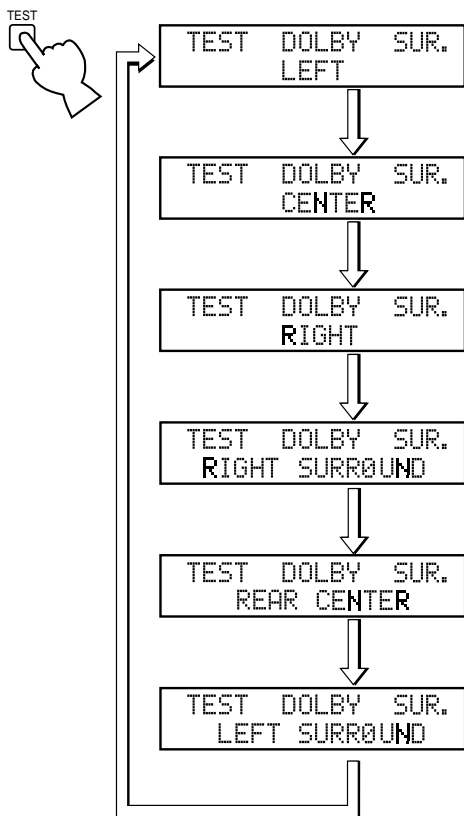

- 1 Press **TEST** on the remote control so “TEST DOLBY SUR.” appears on the video monitor and front panel display.

- 2 Adjust **VOLUME +/-** so you can hear the test tone.

- The test tone is produced from the left Main speaker, Center speaker, right Main speaker, right Rear speaker, Rear Center speaker and left Rear speaker in order. The tone is produced for 2.5 seconds each time.
- You can stop the sequence temporarily by pressing Δ or ∇ .

- 3 Adjust the output level of the effect speakers using the cursor **-** or **+** buttons on the remote control so the output level coming from each speaker is the same.

- You can increase the output levels of the effect channels (left Rear, right Rear, Rear Center and Center) to +10 dB. If the output level of the Center, Rear, and Rear Center speakers is lower than that from the Main speakers even after you have increased the sound volume level of the Center, Rear, and Rear Center speakers up to +10 dB, set the 1G. MAIN LEVEL item in the SET MENU to “-10dB.” Setting the 1G. MAIN LEVEL item to this setting decreases the Main speaker volume level to about one-third the normal level. After you set the 1G. MAIN LEVEL item in the SET MENU to “-10dB,” adjust the levels for the Center, Rear, and Rear Center speakers again.

- 4 When you finish adjusting the output level of the Center, Rear, and Rear Center speakers, press **TEST** repeatedly until the current DSP program appears.

Note:

- The tonal quality of the speakers can be adjusted using the 7. CENTER GEQ, 8. REAR CT GEQ, and 9. CINEMA EQ items in the SET MENU (see page 49~50).

DSP Test

Adjust the output level of the Front Effect speakers while this unit is reproducing a DSP sound field program. If you do not use Front Effect speakers, set the 1F. FRNT EFCT SP item in the SET MENU to “NONE” (see page 41), and the DSP Front Effect signals will be mixed with the Main channel signals.

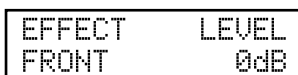
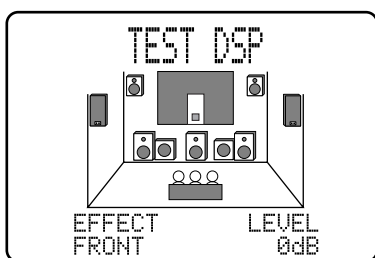
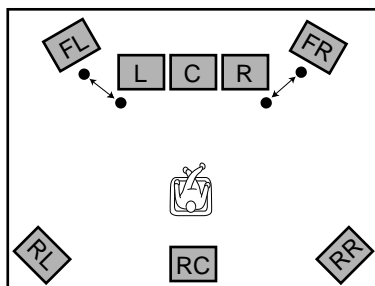

1 Press **TEST** repeatedly until “TEST DSP” appears on the video monitor and front panel display.

2 Adjust **VOLUME** so you can hear the test tone.

- The test tone is produced alternately from the Front Effect speakers and Main speakers. The tone is produced for 2.5 seconds each time.

3 Adjust the output level of the Front Effect speakers using **+** and **-** so the output level coming from the Front Effect speakers is the same as that of the Main speakers.

- The test tone is automatically produced from the Front Effect speakers while you are adjusting the level.

4 When you finish adjusting the output level of the Front Effect speakers, press **TEST** repeatedly until the current DSP program appears.

Notes:

- If you cannot hear the test tone, set **VOLUME**, turn off the power, and check the speaker cords and hookups.
- The test tone can be reproduced separately from the left and right Front Effect speakers. This is useful when you want to check the hookups to these speakers. Press **△** to reproduce the test tone from the left speaker, and press **▽** to reproduce the tone from the right speaker. (The OSD shows which speaker is reproducing the tone.)
- You cannot adjust the output level of the left and right Front Effect speakers separately.
- You can stop the test tone’s alternation temporarily by pressing **△** or **▽**.
- The tonal quality of the speakers can be adjusted using the 7. CENTER GEQ, 8. REAR CT GEQ, and 9. CINEMA EQ items in the SET MENU (see page 49-50).
- If the sound volume of the Front Effect speakers is lower than that of the Main speakers, even after you have increased the output level up to +10 dB, set the 1G. MAIN LEVEL item in the SET MENU to “-10dB.” Setting the 1G. MAIN LEVEL item to “-10dB” decreases the Main speaker output level to about one-third of the normal level. After you set the 1G. MAIN LEVEL item in the SET MENU to “-10dB,” repeat the TEST DOLBY SUR. procedure on the previous page.

Basic Operation

Basic Playback 31

Power Control	31
Selecting a Source	32
Input Modes and Indications	33
Selecting a Sound Field Program	34

AM/FM Tuner 35

Manual Tuning	35
Automatic Tuning	35
Presetting Stations	36
Tuning to Preset Stations	38
Exchanging Preset Stations	38

Basic Recording 39

Preparations	39
--------------------	----

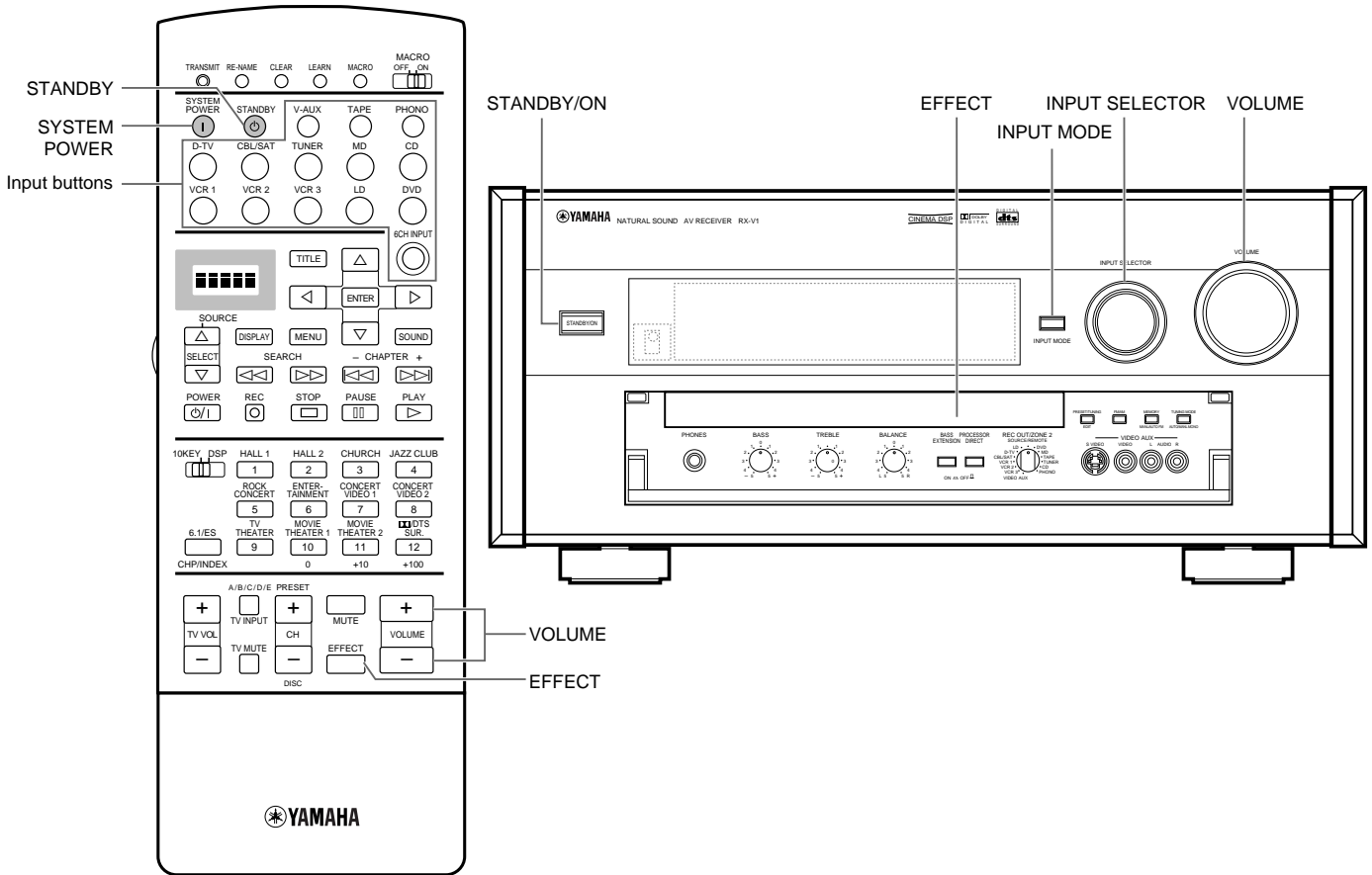

Power Control

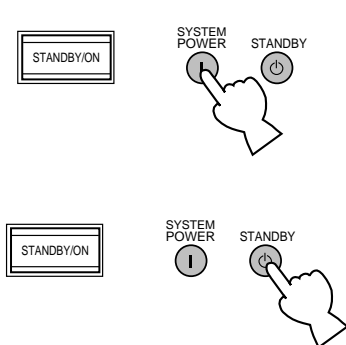

1 Press **STANDBY/ON** (or **SYSTEM POWER** on the remote control) to turn on the power.

- The front panel (and the monitor screen) shows the level of the volume for a few seconds and then switches to show the current sound field program.

2 Press **STANDBY/ON** (or **STANDBY** on the remote control) to turn off the power.

Note:

- This unit stores its current operational status in memory before the power is turned off. By connecting a commercially available timer to this unit, you can easily playback or record a source at any time you wish.

Selecting a Source

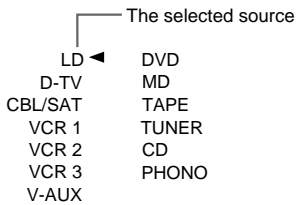
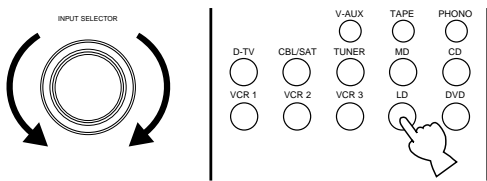

- 1 Select the source using **INPUT SELECTOR**, or press one of the input buttons on the remote control.
 - The current source is indicated on the front panel display with an arrow.
 - The current source name and input mode appear on the front panel display and the video monitor for a few seconds.

Select this source:

To reproduce the signal from this equipment.

DVD	DVD player
LD	LD player
D-TV	Digital TV or TV
CBL/SAT	Cable TV or Satellite tuner
VCR 1	Video deck 1
VCR 2	Video deck 2
VCR 3	Video deck 3
V-AUX	Other A/V equipment
PHONO	Turntable
CD	CD player
TUNER	AM/FM tuner
TAPE	TAPE deck
MD	MD recorder

- 2 Start playback (or select a broadcast station) on the source equipment.
 - Refer to the operation instructions for the equipment.
- 3 Adjust **VOLUME** (or **VOLUME +/-** on the remote control).

Caution:

- If the power of the equipment connected to the **VCR 1**, **VCR 2**, **VCR 3**, **TAPE**, and **MD OUT** jacks is turned off, reproduced sound may be distorted or the volume may be lowered. In these cases, turn on the equipment.

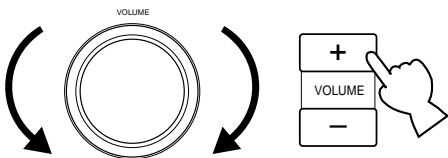

■ BGV (Back Ground Video) Function

The BGV (Back Ground Video) function allows you to combine a video signal from a video source with a sound signal from an audio source. (For example, you can listen to classical music while you are watching a video.)

Using the remote control, select a source from the video group, then select a source from the audio group. Use the input buttons on the remote control to make your selections. The BGV function does not work if you select the sources using **INPUT SELECTOR** on the front panel.

Input Modes and Indications

The RX-V1 comes with various input jacks. If your external component is connected to more than one type of input jack, you can set the priority of the input signal. Press **INPUT MODE** on the front panel or an input button (press it repeatedly) on the remote control to display or change the input mode.

● **AUTO**

AUTO:DOLBY DGTL

AUTO:DTS

AUTO:PCM

AUTO:ANALOG

AUTO:---

AUTO: This mode is automatically selected when you turn on the power of this unit. In this mode, the input signal is automatically selected in the following order.

- 1) Dolby Digital or DTS encoded signals
- 2) Digital (PCM) signals
- 3) Analog signals

DTS: In this mode, only digital input signals encoded with DTS are selected even if other signals are input at the same time.

ANALOG: In this mode, only analog input signals are selected even if digital signals are input at the same time.

● **Dolby Digital RF**

D.D. RF

D.D. RF:---

<When LD is selected as the input source>
 AUTO: In this mode, this unit automatically selects the signal in the following order.

- 1) Dolby Digital RF encoded signals
- 2) DTS encoded signals
- 3) Digital (PCM) signals
- 4) Analog signals

D.D. RF: This unit only selects Dolby Digital RF encoded signals.

DTS: This unit only selects DTS encoded signals.

DGTL: This unit only selects digital (PCM) signals input through the **OPTICAL** jacks.

ANALOG: This unit only selects signals input through the **ANALOG** jacks. This unit will not select Dolby Digital RF or DTS signals.

● **DTS**

DTS

DTS:---

● **DIGITAL**

DGTL:DOLBY DGTL

DGTL:DTS

DGTL:PCM

DGTL:---

● **ANALOG**

ANALOG

ANALOG:---

Notes:

- For CD, DVD, and CBL/SAT sources, if digital signals are input from both the **OPTICAL** and **COAXIAL** terminals, the digital signal from the **COAXIAL** terminal is selected.
- When the "AUTO" mode is selected, the RX-V1 automatically determines the type of signal. If the RX-V1 detects a DTS or Dolby Digital signal, the decoder automatically switches to the appropriate setting and reproduces 5.1 channel sound.
- When you use functions such as pause, search, or disc change while playing a disc encoded with DTS signals, the DTS indicator flashes until the next playback starts.
- If you play a disc encoded with DTS signals and the input mode is set to "ANALOG", this unit reproduces the noise of an unprocessed DTS signal. When you want to play a DTS source, be sure to connect the source to a digital input jack and set the input mode to "AUTO" or "DTS."
- If you switch the input mode to "ANALOG" while playing a disc encoded with DTS signals, this unit reproduces no sound.
- For LD software that does not contain a digital soundtrack, connect the LD player to the analog jacks and set the input mode to "AUTO" or "ANALOG."
- The input mode resets to "AUTO" after you turn off the power. When the current input source is D-TV, CBL/SAT, and VCR 1, the input mode resets to the one set using the 15. INPUT MODE item in the SET MENU after you turn off the power (see page 52).
- If the LD player is transmitting signals in a non-standard method, the RX-V1 cannot detect the DTS or Dolby Digital signal. In this case, the decoder automatically switches to PCM or analog.
- Some audio/video equipment, such as LD players, output different audio signals through their analog and digital jacks. Change the input mode as necessary.

Selecting a Sound Field Program

You can enhance your listening experience by selecting a DSP sound field program. The 24 DSP sound field programs are divided into 12 DSP program groups. For details about each program, see pages 71~76.

- 1 Set **10KEY/DSP** to **DSP**.
- 2 Press one of the DSP program group buttons (or **PROGRAM** ◀ or ▶ on the main unit) repeatedly until the DSP program you want appears in the front panel display.

- For example, to select “Live Concert,” press **HALL 2** repeatedly. You can also select sound field programs within the current group by setting **PARAMETER/SET MENU** to the **PARAMETER** position and pressing the cursor **+** or **-** button.

Notes:

- If a DTS or Dolby Digital signal is input when the input mode is set to “AUTO”, the sound field program automatically switches to the appropriate decoding program.
- Choose a sound field program based on your listening preference, not on the name of the program. The acoustics of your listening room affect the sound field program. Minimize the sound reflections in your room to maximize the effect created by the program.
- When you select an input source, the main unit automatically selects the last sound field program used with that source.
- When you turn off the main unit, the current source and sound field program are memorized and are automatically selected when you turn on the power again.
- When high rate 96kHz sampling 24 bit digital signals are output from source equipment, the DSP sound field cannot operate on the source sounds. In this case, the sounds are reproduced as normal 2-channel stereo.

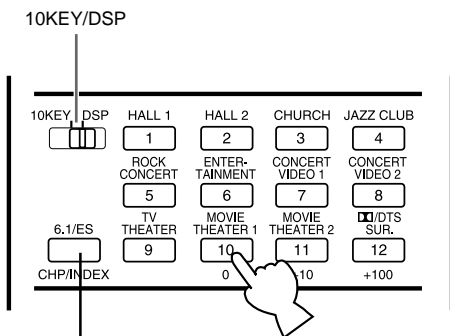

6.1/ES

If you want to utilize the Rear Center speaker with a 5.1 channel program source, press **6.1/ES**. However, note that to achieve the proper effect with the rear center channel, Dolby Digital Surround EX or DTS ES software should be used.

Hi-Fi DSP Programs

1	2	Church	Jazz Club	Rock Concert	Entertainment
Europe Hall A	U.S.A. Hall D	Tokyo	Village Gate	Roxy Theatre	Disco
Europe Hall B	Europe Hall E	Freiburg	Village Vanguard	Warehouse Loft	Party
Europe Hall C	Live Concert	Royaumont	The Bottom Line	Arena	Game/Amusement

CINEMA-DSP Programs

Concert Video 1	Concert Video 2	TV Theater	Movie Theater 1	Movie Theater 2	DTS SURROUND
Pop/Rock DJ	Classical/Opera Pavilion	Mono Movie Variety/Sports	Spectacle Sci-Fi	Adventure General	Normal/Matrix 6.1/ES Enhanced/6.1/ES

Virtual CINEMA DSP and HP CINEMA DSP

You can experience the virtual CINEMA DSP sound field by setting the 1C. REAR L/R SP item in the SET MENU to “NONE.” The sound field processing is changed to the Virtual CINEMA DSP mode according to the selected sound field program. Virtual CINEMA DSP is performed using the Main speakers. You can also listen to HP (Headphone) CINEMA DSP by connecting your headphones to the **PHONES** jack while the DSP sound fields are on.

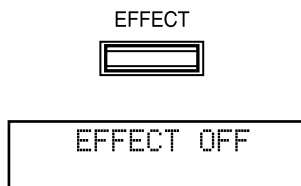

Normal Stereo Reproduction

For normal stereo reproduction, press **EFFECT** to turn off the effect.

Notes:

- When you turn off the effect, no sound is reproduced from the Front Effect, Center, Rear, and Rear Center speakers.
- If you turn off the effect while DTS or Dolby Digital signals are being reproduced, the dynamic range of the signal is automatically compressed.
- The sound volume may be extremely reduced when you turn off the effect or if you change SET MENU item 3B. D-RANGE to MIN. In this case turn on the effect.

Automatic tuning is effective when the radio signals are strong and have no interference. However, manual tuning is best for weaker signals that have some interference.

Manual Tuning

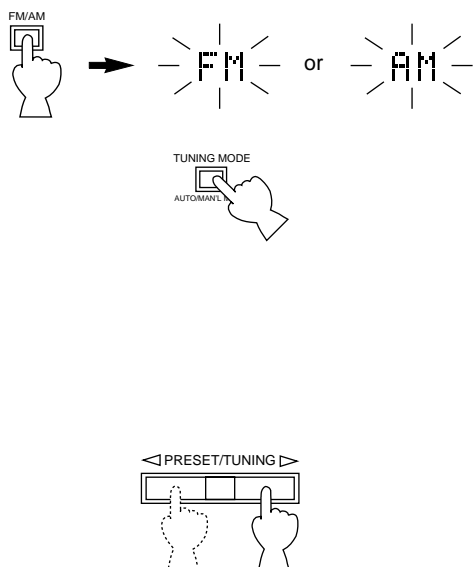

- 1 Select “TUNER” as the input source.

You can use **INPUT SELECTOR** on the main unit or the input button on the remote control.

- 2 Press **AM/FM** to select the reception band.

“FM” or “AM” appears in the display.

- 3 Press **TUNING MODE (AUTO/MAN'L MONO)** so that the “AUTO TUNING” indicator goes off in the display.

If the colon (:) appears in the display next to the AM or FM indicator, press **PRESET/TUNING (EDIT)** to turn it off.

Turn this indicator off.



- 4 Press **PRESET/TUNING** ◀ or ▶ to tune to the desired station manually.

Hold down the button to continue the tuning search.

Note:

- Manually selecting an FM station will automatically change the reception to monaural to increase the signal quality.

Automatic Tuning

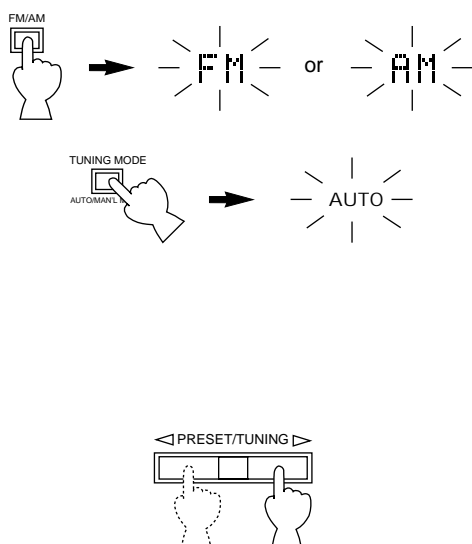

- 1 Select “TUNER” as the input source.

You can use **INPUT SELECTOR** on the main unit or the input button on the remote control.

- 2 Press **AM/FM** to select the reception band.

“FM” or “AM” appears in the display.

- 3 Press **TUNING MODE (AUTO/MAN'L MONO)** so that the “AUTO TUNING” indicator appears in the display.

If the colon (:) appears in the display next to the AM or FM indicator, press **PRESET/TUNING (EDIT)** to turn it off.

Turn this indicator off.

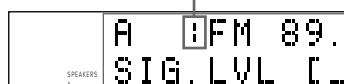

- 4 Press **PRESET/TUNING** ◀ or ▶ once to begin auto tuning.

Press ▶ to tune to a higher frequency, or press ◀ to tune to a lower frequency. Press the same button again if the tuning search stops short of the correct station.

Use manual tuning if the tuning search does not stop at the correct station because the signals are weak.

Presetting Stations

Manually presetting stations

This unit can store up to 40 stations (8 stations x 5 groups). Using this feature, you can easily tune to any preset station by selecting the preset station number (see page 38).

- 1 Tune to a station.

See the previous page for tuning instructions.

- 2 Press **MEMORY (MAN'L/AUTO FM)**.

The MEMORY indicator flashes for about five seconds.

- 3 Press **A/B/C/D/E** repeatedly to select a preset station group (A to E).

The group letter appears on the display.

Note:

- You must select a preset station group before the MEMORY indicator stops flashing (about five seconds).

- 4 Press **PRESET/TUNING** ◁ or ▷ to select a preset station number (1 to 8).

Press ▷ to select a higher preset station number.

Press ◁ to select a lower preset station number.

Note:

- You must select a preset station group before the MEMORY indicator goes off (about five seconds).

- 5 Press **MEMORY (MAN'L/AUTO FM)**.

The station band and frequency appear in the display with the preset group and number you selected.

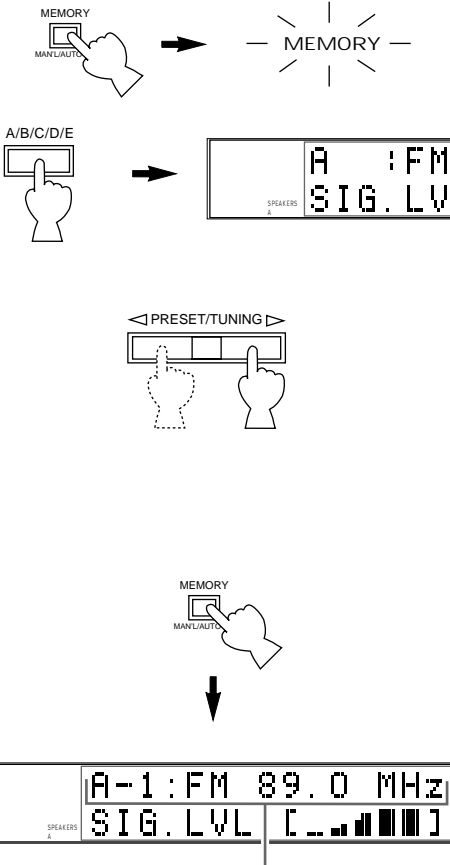

Shows the displayed station has been programmed to A-1.

- 6 Repeat steps 1 through 5 to store other stations.

You can store up to 40 stations (A1~A8, B1~B8, C1~C8, D1~D8, and E1~E8).

Notes:

- The memory back-up circuit prevents the stored data from being lost even if this unit is set to standby mode, the power cord is disconnected from the AC outlet, or power service is temporarily cut due to power failure. However, if the power is cut for more than one week, the memory may be deleted.
- Any stored station data existing at a preset number is cleared when you store a new station at that preset number.
- The reception mode (stereo or monaural) is stored along with the station frequency.

■ Automatically presetting stations

You can use the automatic preset tuning feature to store FM stations. With this function, the unit automatically tunes to FM stations with strong signals, then stores up to 40 of those stations in order.

- 1 Tune to the FM station from which you want automatic presetting to begin.

See page 35 for tuning instructions.

- 2 Press and hold **MEMORY** for more than 3 seconds.

The preset number and MEMORY and AUTO TUNING indicators flash. Then, after about five seconds, automatic preset tuning begins.

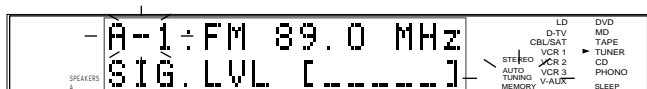
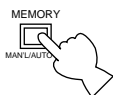

Automatic Preset Tuning Options

Before Automatic Preset Tuning begins (within about five seconds), you can set the preset number from which the unit will store FM stations and the direction in which the unit will scan for stations.

- Press **A/B/C/D/E** and **PRESET/TUNING** $\triangleleft/\triangleright$ to select the preset number where the first station will be stored. The unit will stop storing stations if it reaches preset number E8.
- Turn off **PRESET/TUNING (EDIT)** (“ : ” is off) and press **PRESET/TUNING** \triangleleft to scan for lower frequency stations or **PRESET/TUNING** \triangleright to scan for higher frequency stations. If you do not press either button before Automatic Preset Tuning begins, the unit will scan for higher frequency stations.

When Automatic Preset Tuning is complete, the display shows the frequency of the last preset station.

Notes:

- You can replace a preset station with another FM or AM station manually by simply following the procedure of the section “Manually presetting stations” on page 36.
- If the number of received stations does not reach to E8, the search finishes automatically after searching all frequencies.
- With this function, only FM stations with sufficient signal strength are stored automatically. If the station you want to program is weak in signal strength, tune to it in monaural mode manually, then program it by following the procedure in “Manually presetting stations” on page 36.

Tuning to Preset Stations

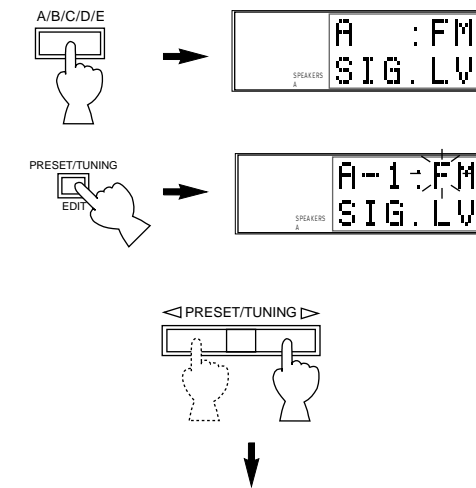

- 1 Press **A/B/C/D/E** to select the preset station group.
The preset group letter appears in the display and changes each time you press **A/B/C/D/E**.
- 2 Press **PRESET/TUNING (EDIT)** so that the colon (:) appears next to the AM or FM indicator.
“:” must appear in the display to recall preset stations. If necessary, press **PRESET/TUNING (EDIT)** again.
- 3 Press **PRESET/TUNING** ◀ or ▶ to select a preset station number (1 to 8).
The preset group and number appear in the display along with the station band, frequency, and signal strength information.



Exchanging Preset Stations

You can exchange the stations stored on two preset numbers. The example below describes the procedure for exchanging the stored stations at preset numbers E1 and A5.

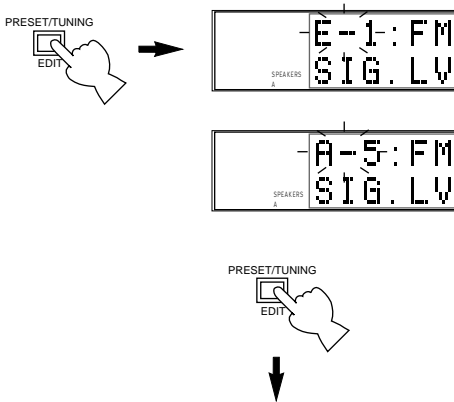

- 1 Tune to the E1 preset station number.
See above for “Tuning to Preset Stations.”
- 2 Press and hold **PRESET/TUNING (EDIT)** for more than 3 seconds.
“E-1” flashes in the display.
- 3 Tune to the A5 preset station number.
See above for “Tuning to Preset Stations.”
A-5 flashes in the display.
- 4 Press **PRESET/TUNING (EDIT)** again.
The stations stored at the two preset locations are exchanged.

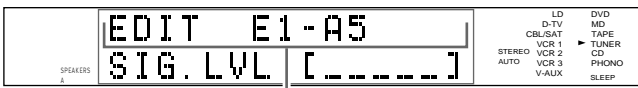

Shows the exchange of stations is completed.

REC OUT/ZONE 2 allows you to record one source while viewing and/or listening to another source.

Preparations

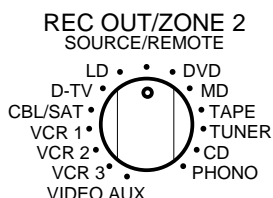
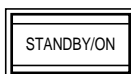

- 1 Turn on the power to the RX-V1 and all connected equipment.
- 2 Select the source equipment you want to record using **REC OUT/ZONE 2**.
 - To record the current source, set **REC OUT/ZONE 2** to **SOURCE/REMOTE**.
 - To record a source that you do not want to reproduce, set **REC OUT/ZONE 2** to the source you want to record.
- 3 Start playback (or select a broadcast station) on the source equipment.
- 4 Start recording on the recording equipment.
 - If you want to listen to another source, and **REC OUT/ZONE 2** is not set to **SOURCE/REMOTE**, select the source you want to reproduce with **INPUT SELECTOR** and adjust the volume.

Notes:

- Do a test recording before you start an actual recording.
- When this unit's power is off, you cannot record between other equipment connected to this unit.
- Operating **BASS** and **TREBLE**, **BASS EXTENSION**, **BALANCE**, **VOLUME**, and DSP programs do not affect the recorded signal.

Caution:

- The RF (AC-3) input signal cannot be output using **REC OUT/ZONE 2**.

■ Special considerations when recording DTS software

The DTS signal is a digital bitstream. Attempting to digitally record the DTS bitstream will result in noise being recorded. Therefore, if you want to use this unit to record sources that have DTS signals recorded on them, the following considerations need to be made.

For DTS encoded LDs, DVDs, and CDs:

Only 2-channel analog audio signals may be recorded as follows:

Laser Discs:

Set your Laser Disc player's left and right outputs to the analog soundtrack.

DVDs:

Use the disc menu to set the DVD player's mixed 2-channel left and right audio outputs to the PCM or Dolby Digital soundtrack.

Compact Discs:

The DTS signal recorded on CDs can only be output as a digital bitstream, and therefore cannot be recorded.

Advanced Operation

SET MENU Items

41

Operating the SET MENU	42
1. SPEAKER SET (1A. CENTER SP to 1G. MAIN LEVEL)	43
2. LOW FREQ. TEST	46
3. DOLBY D. SET (Dolby Digital Set)	47
4. DTS SET	48
5. SP DELAY TIME	48
6. AUDIO DELAY	48
7. CENTER GEQ (Center Graphic Equalizer)	49
8. REAR CT GEQ (Rear Center Graphic Equalizer)	49
9. CINEMA EQ	50
10. HP TONE CTRL (Headphone Tone Control)	51
11. PARAMETER INI (Parameter Initialization)	51
12. 6.1/ES AUTO	51
13. MEMORY GUARD	52
14. CMPNT-V INPT (Component Video Input)	52
15. INPUT MODE	52
16. INPUT RENAME	53
17. DIMMER	53
18. ZONE 2 SET	53

Remote Control Features

54

Using the Remote Control	54
Each Component Control Area	56
Operating a Tuner (TUNER Area)	56
Operating a Tape Deck (TAPE Area)	56
Operating a CD Player (CD Area)	57
Operating an MD Recorder (MD Area)	57
Operating an LD Player (LD Area)	58
Operating a DVD Player (DVD Area)	58
Operating a VCR (VCR1/VCR2/VCR3 Area)	59
Operating a TV or Digital TV (D-TV Area)	59
Operating a Cable or Satellite TV Tuner (CBSAT Area)	60
Free area (OPTN and PHONO Areas)	60
Setting the Manufacturer Code in the Remote Control	61
Programming a New Remote Control Function	62
Using the Macro Feature	63
Changing the Source Name in the Display Window	65
Clearing a Learned Function or Macro	65
Clearing Learned Functions, Macros, Renamed Displays, and Manufacturer Setups	66

Adjusting the Levels of the Effect Speakers

67

Setting the Sleep Timer

67

ZONE 2

68

Connections	68
Remote Control in ZONE 2	69

SET MENU Items

The SET MENU consists of eighteen items including the Speaker Set, Center Graphic Equalizer and Parameter Initialization features. Choose the appropriate item and adjust or select the values as necessary.

Notes:

- You can adjust the items in the SET MENU while reproducing a source.
- We recommend that you adjust the items in the SET MENU while using a video monitor. It is easier to see the video monitor screen than it is to see the front panel display on this unit while adjusting SET MENU items.

Items	Descriptions	Setting (Bold as default)	Page
1. SPEAKER SET 1A. CENTER SP 1B. MAIN SP 1C. REAR L/R SP 1D. REAR CT SP 1E. LFE/BASS OUT 1F. FRNT EFCT SP 1G. MAIN LEVEL	Selects the output mode suitable for your Center speaker. Selects the output mode suitable for your Main speakers. Selects the output mode suitable for your Rear speakers. Selects the output mode suitable for your Rear Center speaker. Selects the speakers for your LFE/BASS signal output. Selects the output mode for your Front Effect speakers. Selects the output level for your main channels.	LRG / SML / NONE LARGE / SMALL LRG / SML / NONE LRG / SML / NONE SW / MAIN / BOTH YES / NONE Normal / -10 dB	43 43 43 44 44 45 45
2. LOW FREQ. TEST	Matches the Subwoofer level with the level of the other speakers.	TEST TONE: OFF / ON OUTPUT: MAIN L/R, MAIN L, CENTER, MAIN R, R SUR.(REAR R), REAR CT, L SUR.(REAR L), SUBWOOFER, FRONT FREQ.: 35 Hz-250 Hz	46
3. DOLBY D. SET 3A. LFE LEVEL 3B. D-RANGE	Adjusts the output level of the LFE channel for Dolby Digital signals. Adjusts the dynamic range for Dolby Digital signals.	SPEAKER: -20 dB to 0 dB HEADPHONE: -20 dB to 0 dB SP(SPEAKER): MAX / STD / MIN HP(HEADPHONE): MAX / STD / MIN	47
4. DTS SET 4A. LFE LEVEL	Adjusts the output level of the LFE channel for DTS signals.	SPEAKER: -10 dB to +10 dB (0 dB) HEADPHONE: -10 dB to +10 dB (0 dB)	48
5. SP DELAY TIME	Adjusts the delay time for Center and Rear Center speakers.	CENTER: 0 ms to 5 ms REAR CNTR: 0 ms to 30 ms (3 ms)	48
6. AUDIO DELAY	Adjusts the delay time for all channels.	0 ms to 99 ms	48
7. CENTER GEQ	Matches the Center speaker tonal quality with the Main speakers.	5-band: -6 dB to +6 dB (0 dB)	49
8. REAR CT GEQ	Controls the tonal quality of the Rear Center speaker.	5-band: -6 dB to +6 dB (0 dB)	49
9. CINEMA EQ 9A. L, C, R EQ 9B. FRNT EFCT EQ 9C. REAR L/R EQ 9D. REAR CT EQ	Adjusts the tonal balance of the Main and Center speakers, Front Effect speakers, Rear speakers and Rear Center speaker separately.	LCR, FRNT EFCT, REAR L/R, REAR CT: OFF / ON HIGH-FREQ: 1 kHz to 12.7 kHz GAIN: -9 dB to +6 dB (-3 dB or 0 dB) PEQ-FREQ: 1 kHz to 12.7 kHz (8 kHz or 12.7 kHz) GAIN: -9 dB to +6 dB (-3 dB or -4 dB)	50
10. HP TONE CTRL	Adjusts the tonal balance of the headphones.	BASS, TRBL: -6 dB to +3 dB (0 dB)	51
11. PARAMETER INI	Initializes the parameters of a group of DSP programs.	1 to 12	51
12. 6.1/ES AUTO	Selects the AUTO mode of Dolby Digital Matrix 6.1 and DTS ES decoding.	ON / OFF	51
13. MEMORY GUARD	Locks DSP program parameters and other SET MENU settings.	OFF / ON	52
14. CMPNT-V INPT	Selects the equipment to be connected to the component video inputs A, B or C.	A: DVD B: D-TV C: CBL/SAT	52
15. INPUT MODE	Selects the initial input mode of the sources connected to D-TV, CBL/SAT and VCR 1.	D-TV: AUTO / LAST CBL/SAT: AUTO / LAST VCR1: AUTO / LAST	52
16. INPUT RENAME	Changes the name of the inputs.	Up to eight characters.	53
17. DIMMER	Adjusts the brightness of the front panel display.	-4 to 0	53
18. ZONE 2 SET	Selects the mode of Zone 2.	CTRL IN : MODE 1 / MODE 2 ZONE 2 OUT: FIX (fixed) / VAR.(variable)	53

Operating the SET MENU

This section describes how to adjust items in the SET MENU using the remote control.

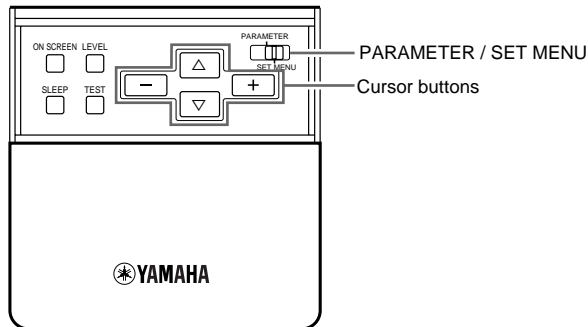

General procedure for adjusting items

Some items require extra steps to change to the desired setting.

- 1 Set **PARAMETER/SET MENU** to **SET MENU**.



- 2 Press Δ or ∇ repeatedly to select an item, then press $+$ or $-$ to change the setting of that item.

- The last item you adjusted appears on the front panel display (or in the SET MENU OSD if you are using a video monitor).

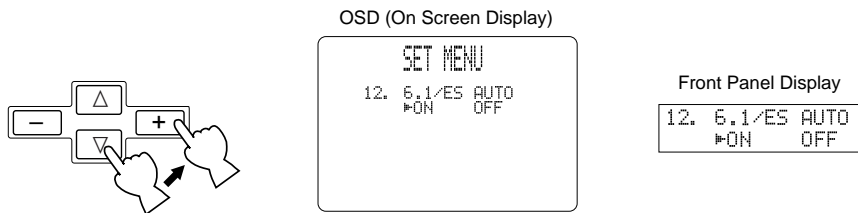

- If “Press +/- Key!” appears on the display, press $+$ or $-$ to select that item, then press Δ or ∇ to select a sub item, then press $+$ or $-$ to change the setting of that item.

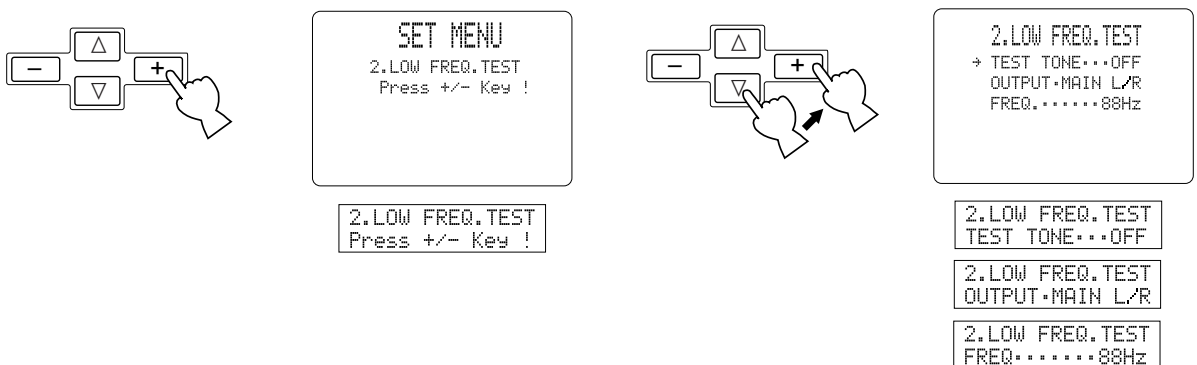

- 3 Press Δ or ∇ repeatedly or a DSP program button to exit the SET MENU.

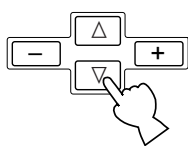

or

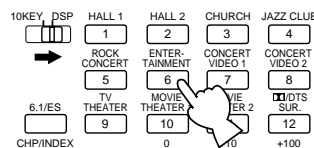

1. SPEAKER SET (1A. CENTER SP to 1G. MAIN LEVEL)

Use this feature to select suitable output modes for your speaker configuration. You must set the output mode when you use a subwoofer.

1A. CENTER SP (Center Speaker Mode)

By adding a Center speaker to your speaker configuration, the RX-V1 can provide good dialogue localization for many listeners and superior synchronization of sound and images. The OSD shows a large, small or no center speaker depending on how you set this item. The initial setting is "LRG".

- Select the "LRG" (Large) setting if you have a large Center speaker. The entire range of Center channel signals is sent to the Center speaker.
- Select the "SML" (Small) setting if you have a small Center speaker. Center channel low frequency signals of 90 Hz and below are directed to the speakers selected with the 1E. LFE/BASS OUT item (see page 44).
- Select the "NONE" setting if you do not have a Center speaker. All of the Center channel signals are directed to the left and right Main speakers. The "NONE" position provides good dialogue localization for the person sitting in the main listening position.

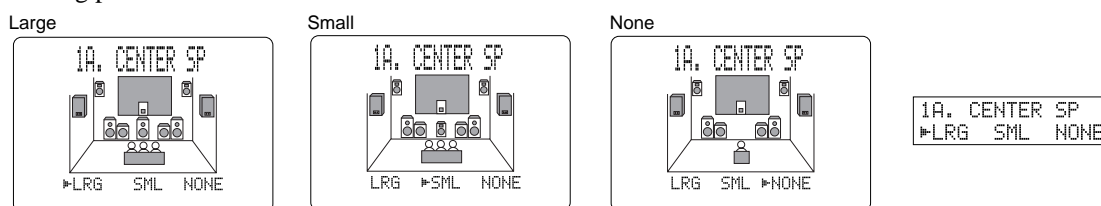

1B. MAIN SP (Main Speaker Mode)

The display shows small or large Main speakers depending on how you set this item. The initial setting is "LARGE".

- Select the "LARGE" setting if you have large Main speakers. The entire range of left and right Main channel signals is directed to the left and right Main speakers.
- Select the "SMALL" setting if you have small Main speakers. The Main channel low frequency signals of 90 Hz and below are directed to the speakers selected with the 1E. LFE/BASS OUT item (see page 44).

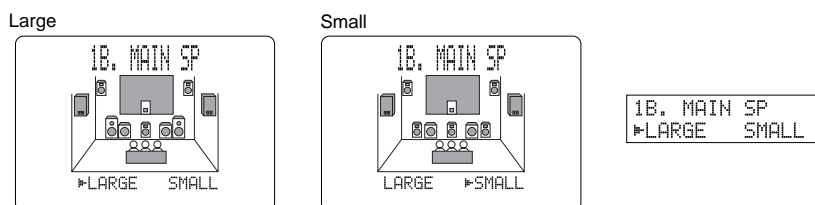

Note:

- When you select the "MAIN" setting for the 1E. LFE/BASS OUT item, the Main channel low frequency signals of 90 Hz and below are directed to the Main speakers even if you select the "SMALL" setting for the Main speaker mode. In this case, the OSD shows large Main speakers.

1C. REAR L/R SP (Rear Speaker Mode)

The OSD shows large, small or no Rear speakers depending on how you set this item. The initial setting is "LRG".

- Select the "LRG" setting if you have large left and right Rear speakers or if you use a Rear Subwoofer (see page 22). The entire range of Rear channel signals is sent to the left and right Rear speakers.
- Select the "SML" setting if you have small left and right Rear speakers. Rear channel low frequency signals of 90 Hz and below are directed to the speakers selected with the 1E. LFE/BASS OUT item (see page 44).
- Select the "NONE" setting if you do not have Rear speakers.
 - In this case, Rear Center speaker will automatically be set to "NONE" and the 1D. REAR CT SP item will be skipped.

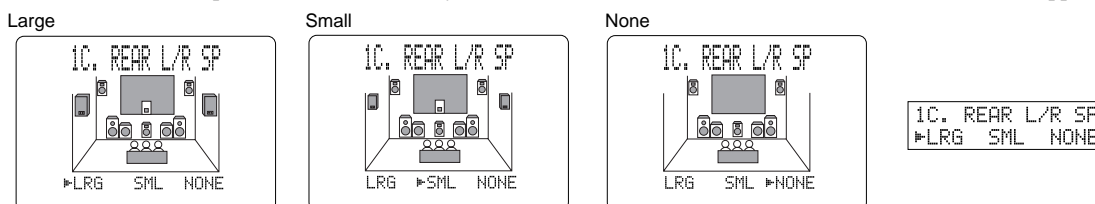

■ 1D. REAR CT SP (Rear Center Speaker Mode)

By adding a Rear Center speaker to your speaker configuration, the RX-V1 can provide more realistic front-to-back and back-to-front transitions. The initial setting is “LRG”.

- Select the “LRG” setting if you have a large Rear Center speaker. The entire range of Rear Center channel signals is sent to the Rear Center speakers.
- Select the “SML” (small) setting if you have a small Rear Center speaker. Rear Center channel low frequency signals of 90 Hz and below are distributed to speakers selected with the 1E. LFE/BASS OUT item.
- Select the “NONE” setting if you do not have a Rear Center speaker.

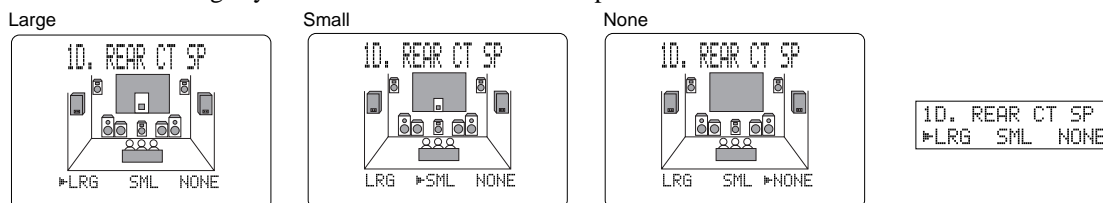

■ 1E. LFE/BASS OUT (Bass Out Mode)

LFE signals carry low frequency effects when this unit decodes DTS or Dolby Digital signals. Low frequency signals are defined as 90 Hz and below. The initial setting is “BOTH”.

- Select the “SW” (Subwoofer) setting if you use a Subwoofer. The LFE signals are directed to the Subwoofer.
- Select the “MAIN” setting if you do not use a Subwoofer. The LFE signals are directed to the Main speakers.
- Select the “BOTH” setting if you use a Subwoofer and you want to mix the Main channel low frequency sound signals with the LFE signals.

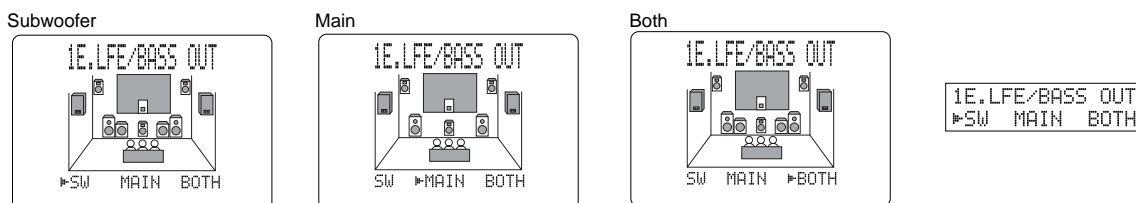

Note:

- The low frequency signals of 90Hz and below from all Main, Center, Rear and Rear Center channels are directed to the LFE channel when you select the small speaker setting in items 1A, 1B, 1C and 1D.

1F. FRNT EFCT SP (Front Effect Speaker Mode)

The RX-V1 uses Front Effect speakers to localize the virtual sound sources of the sound field programs. If you do not use Front Effect speakers, you can direct the Front Effect signals to the Main speakers.

The OSD shows small or no Front Effect speakers depending on how you set this item. The initial setting is “YES”.

- Select the “YES” setting if you use Front Effect speakers.
- Select the “NONE” setting if you do not use Front Effect speakers. The Front Effect signals are mixed with the Main channels.

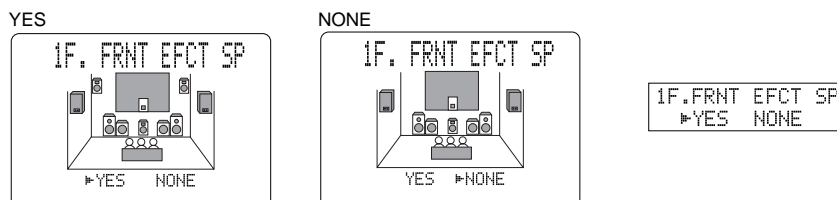

1G. MAIN LEVEL

Change this setting if you cannot match the sound volume of the Front, Rear, and Center speakers with the Main speakers because of the unusually high efficiency performance of the Main speakers. The initial setting is “Normal”.

- Select the “Normal” setting if you can match the volume of your effect speakers with the volume of your Main speakers using the Dolby Surround Test (page 28).
- Select the “-10dB” setting if you cannot match the volume of your effect speakers with the volume of your Main speakers using the Dolby Surround Test (page 28).

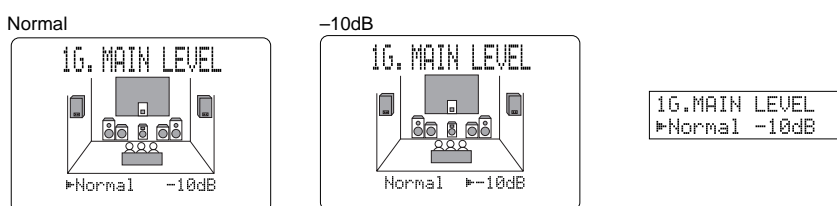

Note:

- When this unit decodes 96 kHz sampling/24 bit digital signals or **6CH INPUT** is on, level adjustments in items 1A~1F are not possible.

2. LOW FREQ. TEST

Use this feature to adjust the Subwoofer volume so it matches the volume of the other speakers in your configuration. Change the setting using the remote control while sitting in the main listening position.

- 1 Press **+** or **-** to set the TEST TONE to “ON”, and adjust the volume using **VOLUME +** so you can hear the tone.
- 2 Press **∇** repeatedly to go to OUTPUT and press **+** or **-** to select the speaker you want to compare with the Subwoofer.
 - If “SUBWOOFER” is selected, test tones above 90 Hz will not be output from the Subwoofer. The test tone will not necessarily be output from the selected speakers. The output mode of the test tone depends on the settings of the 1. SPEAKER SET items in the SET MENU.
- 3 Press **∇** repeatedly to go to FREQ. and press **+** or **-** to select the frequency you want to use.

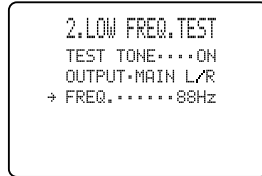
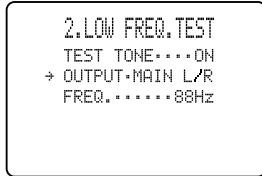
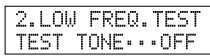
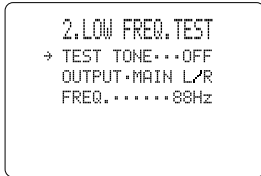

- 4 Adjust the Subwoofer volume using the controls on the Subwoofer so it matches the volume of the speaker you are comparing it to.

Notes:

- Do not turn up the **VOLUME** too high.
- If no test tone is heard, turn off the power and make sure all the necessary hookups are correct.

■ About the Test Tone

The test tone is produced by the tone generator.

The tone generator produces a narrow band noise centered at a specified frequency by the band pass filter.

You can change the center frequency from 35 Hz through 250 Hz in one-sixth octave steps.

You can use the test tone not only for adjusting the subwoofer level, but also for checking the low frequency characteristics of your listening room. Low frequency sounds are especially affected by the listener’s position, speaker placement, subwoofer polarity and other conditions.

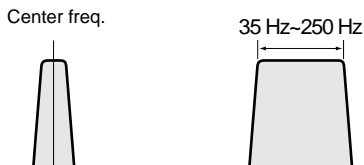
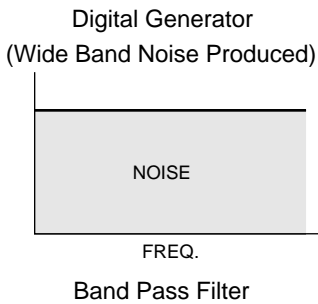

3. DOLBY D. SET (Dolby Digital Set)

3A. LFE LEVEL

Use this feature to adjust the output level of the LFE (low frequency effect) channel when playing back Dolby Digital encoded software. This setting is effective only when this unit decodes Dolby Digital signals. The LFE signal carries the low frequency special effect sound which is only added to certain scenes.

- You can adjust the levels from 0 dB to -20 dB.
- Adjust the LFE levels according to the capacity of your subwoofer or headphones.

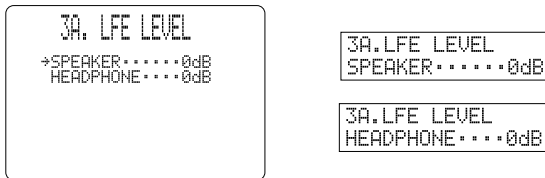

3B. D-RANGE (Dynamic Range)

Use this feature to adjust the dynamic range. This setting is effective only when this unit decodes Dolby Digital signals.

- Select the “MAX” setting for feature films.
- Select the “STD” (Standard) setting for general use.
- Select the “MIN” setting for listening to sources at extremely low volume levels.

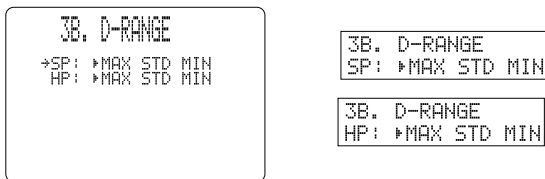

Note:

- When D-RANGE is set to “MIN”, sound output may be faint because some Dolby Digital software is not compatible with the minimum level dynamic range.

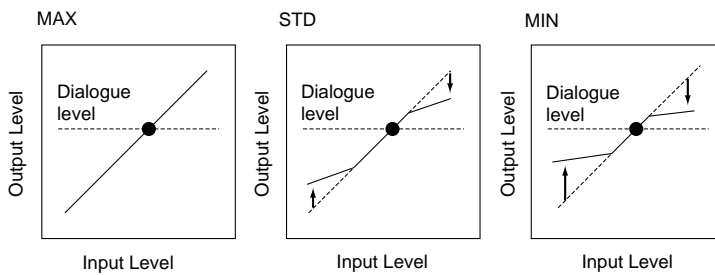

4. DTS SET

4A. LFE LEVEL

Use this feature to adjust the output level of the LFE (low frequency effect) channel when playing back DTS encoded software. This setting is effective only when this unit decodes DTS signals. The LFE signal carries the low frequency special effect sound which is only added to certain scenes.

- You can adjust the levels from -10 dB to +10 dB.
 - Adjust the LFE level according to the capacity of your subwoofer or headphones.

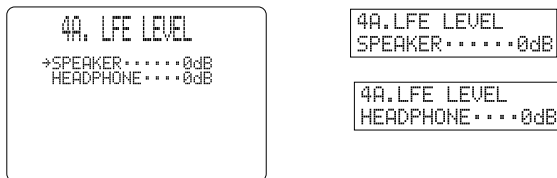

5. SP DELAY TIME

Use this feature to adjust the delay of the Center and the Rear Center channel sounds. This feature works when this unit decodes DTS or Dolby Digital signals. Ideally, the Center speaker and the Rear Center speaker should be the same distance from the main listening position as the left and right Main speakers. However, in most home situations, the Center speaker or the Rear Center speaker is placed in line with the Main speakers or the Rear speakers. By delaying the sound from the Center speaker and the Rear Center speaker, the apparent distance from the Center speaker and the Rear Center speaker to the main listening position can be adjusted to make it seem the same as the distance between the left and right Main speaker, and the left and right Rear speakers to the listening position. Adjusting the delay time for the Center speaker is especially important for giving depth to the dialogue.

- You can adjust the delay time from 0 ms to 5 ms for the Center speaker and from 0 ms to 30 ms for the Rear Center speaker.
 - Increasing the delay 1 ms simulates moving the speakers about 30 cm (one foot) farther away from the listening position.

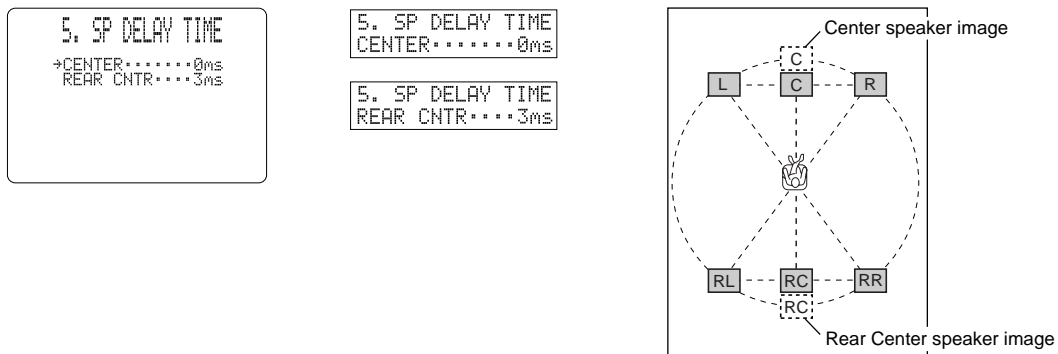

6. AUDIO DELAY

Use this feature to adjust the delay time of all channel sounds, when this unit decodes DTS or Dolby Digital signals. Adjusting AUDIO DELAY is especially important for matching the sounds to screen pictures. Initial settings is "0ms".

- You can adjust the delay time from 0ms to 99ms.

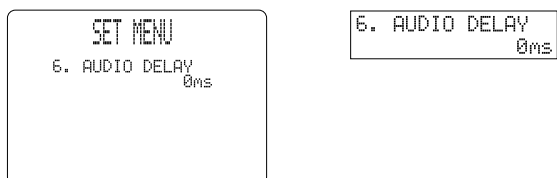

7. CENTER GEO (Center Graphic Equalizer)

Use this feature to adjust the built-in five band graphic equalizer so the Center speaker tone matches that of the left and right Main speakers. You can select the 100 Hz, 300 Hz, 1 kHz, 3 kHz, or 10 kHz frequencies.

- 1 Use ∇ to select a higher frequency and Δ to select a lower frequency.
- 2 Press $+$ or $-$ to adjust the level of that frequency.

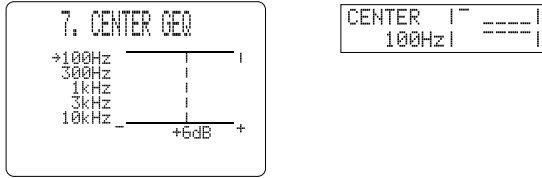

Note:

- You can monitor the Center speaker sound while adjusting this item using the Dolby Surround test tone generator. Press **TEST** before starting the procedure above. "TEST DOLBY SUR." appears, and the test tone starts alternating among the speakers. Once you begin the procedure above, the test tone remains at the Center speaker and you can hear how the sound changes as you adjust the various frequency levels. To turn off the test tone generator, press **TEST** repeatedly until the current DSP program appears (see page 28).

8. REAR CT GEO (Rear Center Graphic Equalizer)

Use this feature to adjust the built-in five band graphic equalizer so the Rear Center speaker tone matches that of the left and right Main speakers.

- 1 Use ∇ to select a higher frequency and Δ to select a lower frequency.
- 2 Press $+$ or $-$ to adjust the level of that frequency.

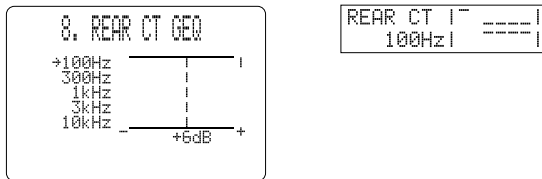

9. CINEMA EQ

Use this feature to match the tonal quality of four groups of speakers: the Main and Center speaker group, the Front Effect speakers group, the Rear speakers group, and the Rear Center speaker group. CINEMA-EQ consists of a high-shelving equalizer (HIGH) and a parametric equalizer (PEQ). The high-shelving equalizer changes high frequency characteristics, and the parametric equalizer boosts or cuts any selected frequency. The equalizer can be used for a variety of purposes, such as adjusting the tonal quality of differing types of speakers, adjusting the tonal quality in different installation environments, or adjusting the source sound to your liking.

The CINEMA EQ characteristic charts below show the value of the CINEMA EQ factory settings for each speaker group for general listening conditions.

▲ L.C.R. Preset Value

HIGH : FRQ 12.7 kHz GAIN -3 dB
PEQ : FRQ 12.7 kHz GAIN -4 dB

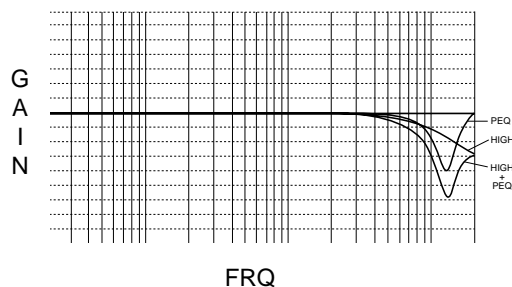

▲ FRONT and REAR Preset Value

HIGH : FRQ 12.7 kHz GAIN 0dB
PEQ : FRQ 8.0 kHz GAIN -3dB

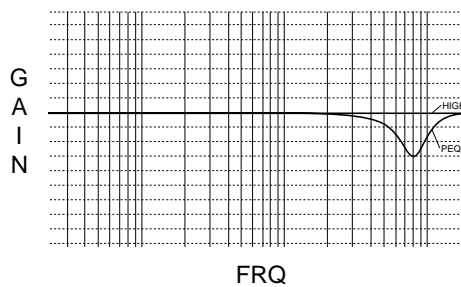

If you want to change the characteristics, follow the procedure below to adjust the frequency and gain for the high-shelving equalizer (HIGH) and parametric equalizer (PEQ). For the more detailed characteristics in different settings, see “CINEMA-EQ Frequency Characteristics” on page 87.

- 1 Press ∇ or Δ repeatedly to select one of the speaker groups and press $+$ to select “ON”.
- 2 Press ∇ or Δ repeatedly to select one of the following parameters, then press $+$ or $-$ to change the setting of that parameter.

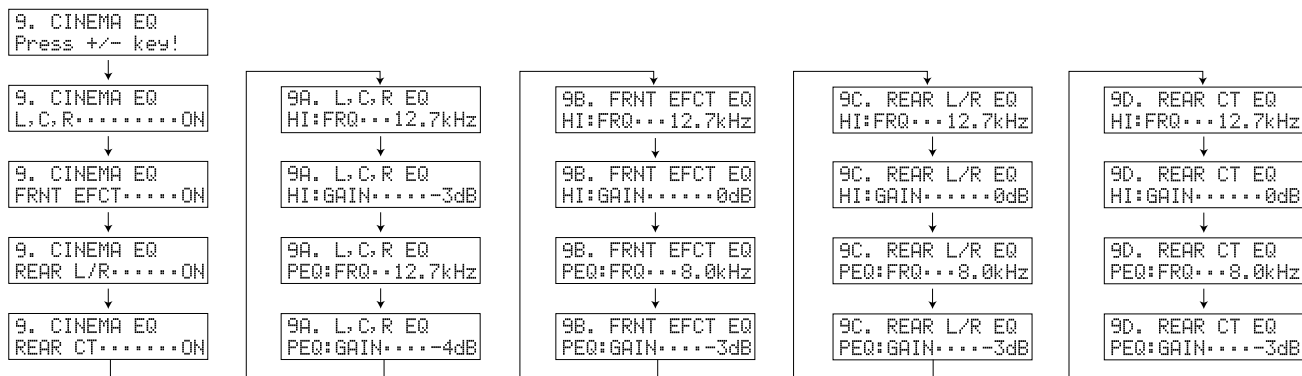
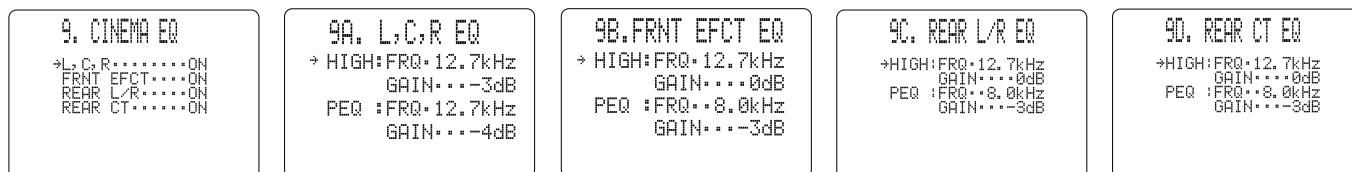

- Each time you press ∇ , the parameter changes on the front panel display as shown above. Press the cursor Δ to go in the reverse order.

Notes:

- When the 1F. FRNT EFCT SP item is set to “NONE”, the Front Effect signals are output from the Main speakers.
- CINEMA-EQ does not work when you press **EFFECT** to turn off the effect.

10. HP TONE CTRL (Headphone Tone Control)

Use this feature to adjust the level of bass and treble when you use your headphones. The initial Setting is 0 dB for both bass and treble. This does not effect to the 96 kHz sampling digital signal.

- Select BASS or TRBL and press + or – to change each level. You can adjust the level from –6 dB to +3 dB.

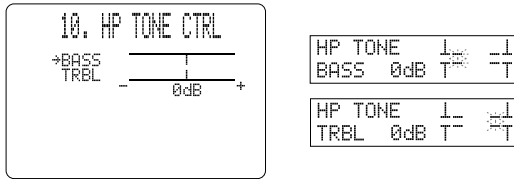

11. PARAMETER INI (Parameter Initialization)

Use this feature to initialize the parameters for each DSP program within a DSP program group. When you initialize a DSP program group, all of the parameter values within that group revert to their initial settings.

- Press the DSP program group button on the remote control for the DSP program you want to initialize.
 - All of the DSP programs within the selected program group are initialized.
- Repeat this step to initialize other DSP program groups.

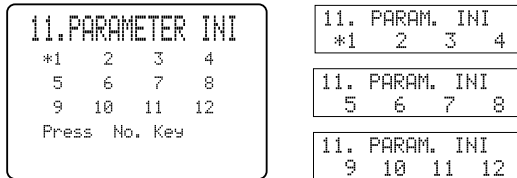

Notes:

- The asterisk (*) mark next to a DSP program group number indicates that you have changed the parameter values in one or more DSP programs within that group.
- The parameter values of the DSP programs do not change if you initialize a program group that does not have the asterisk (*) mark.
- When the MEMORY GUARD function is set to “ON” (see page 52), you cannot initialize any program groups.
- You cannot initialize the individual DSP programs within a group separately.

Caution:

- Once you initialize a DSP program group, you cannot have this unit revert the parameter values back to the previous settings automatically.

12. 6.1/ES AUTO

Use this feature to switch the DOLBY Digital Matrix 6.1 and DTS ES AUTO mode on or off.

- Select “ON” to allow the main unit to automatically turn on the Dolby Digital Matrix 6.1 or DTS ES decoder when the software with identification signal is detected.
- Select “OFF” if you want to control the mode manually by pressing **6.1/ES** on the remote.

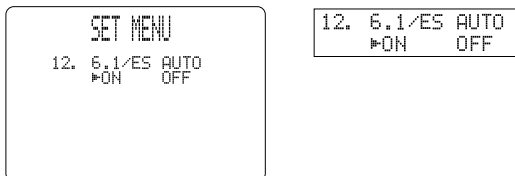

13. MEMORY GUARD

Use this feature to prevent accidental changes to DSP program parameter values and other settings on this unit.

- Select “ON” to use MEMORY GUARD to protect the following features:
 - DSP program parameters
 - All SET MENU items
 - Front, Rear Center speaker and Subwoofer levels
 - The On-Screen Display mode

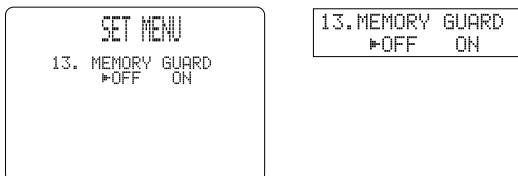

Notes:

- When MEMORY GUARD is “ON”, you cannot use any of the test modes.
- When MEMORY GUARD is “ON”, you cannot select any other SET MENU item.

14. CMPNT-V INPUT (Component Video Input)

Use this feature to designate the input for each **COMPONENT VIDEO** terminal, **A**, **B**, and **C**. The initial settings are as written on the rear panel. (Terminal **A** is for DVD, terminal **B** is for D-TV, and terminal **C** is for CBL/SAT.)

- 1 Select [A], [B], or [C] according to which terminal your equipment is connected to by pressing Δ or ∇ .
- 2 Select the video input for your equipment by pressing $+$ or $-$.
 - You cannot select the same input once you have already selected it.

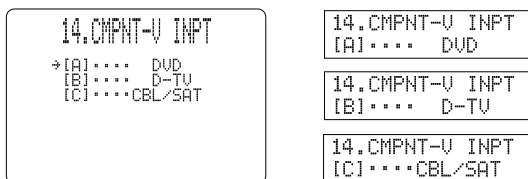

15. INPUT MODE

Use this feature to designate the input mode for sources connected to **D-TV**, **CBL/SAT** and **VCR 1** input jacks when you turn on this unit.

- Select “AUTO” to allow this unit to automatically detect the type of input signal and select the appropriate input mode.
- Select “LAST” to set this unit to automatically select the last input mode used for that source.

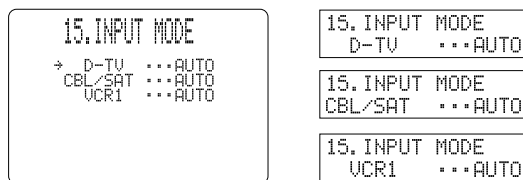

16. INPUT RENAME

Use this feature to change the name of the input which appears on the OSD or the front panel display.

- 1 Select the input you want to change the name of by pressing an input button (or using **INPUT SELECTOR**).
- 2 Press **+** or **-** to place the **^** under the space or the character you want to edit.
- 3 Press **△** or **▽** to select the character you want to use and **+** or **-** to move to the next one.
 - Press **▽** to change the character in the following order, or press **△** to go in the reverse order.
A~Z, a space, 0~9, a space, a~z, a space, #, *, +, and so on.
 - Follow the procedure above to rename other inputs.
- 4 Press **+** or **-** repeatedly to exit the INPUT RENAME mode.

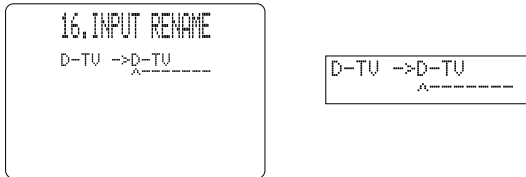

17. DIMMER

- You can adjust the brightness of the front panel display from -4 to 0.

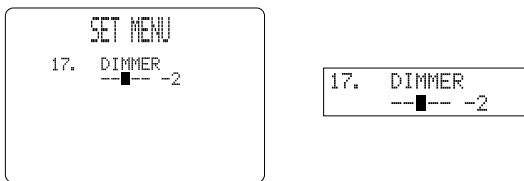

18. ZONE 2 SET

Select ZONE2 OUT to change the setting of the ZONE 2 output volume.

- Selecting “VAR.” allows you to control the volume output to ZONE 2 with the remote control.
- Select “FIX” when you don’t want to change the volume of output to ZONE 2 with the remote control.

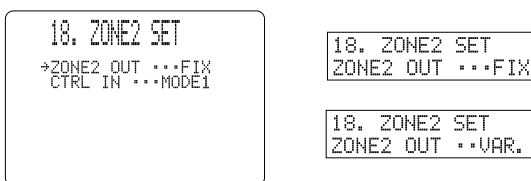

Use CTRL IN to change the setting of the REMOTE 1 IN and REMOTE 2 IN jacks.

- Selecting “MODE 1” allows you to control this unit using the tuner preset buttons on the remote control.
- Selecting “MODE 2” disables control of this unit using the tuner preset buttons on the remote control.

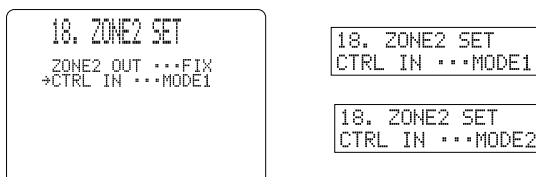

Remote Control Features

The remote control can operate the main unit as well as other Yamaha audio and video components. To control the components of other manufacturers (or some Yamaha), you must set up the remote control with the manufacturer's codes. This remote control also has a sophisticated Learn feature that allows it to acquire functions from the remote controls of other components in your system (or other household appliances) equipped with infrared remote control receivers. The Macro feature allows you to program a series of operations in sequence onto a single button, or use the factory preset macros to operate other Yamaha components. These features make it possible for you to reduce the number of remote control units in your entertainment room.

Notes:

- For operating distance of the remote control and notes about batteries, refer to page 5.
- For the name and function of each part and button, refer to pages 8 and 9.
- If the memory in the remote control becomes full, no further learning is possible even if there are still some programmable buttons available.

Using the Remote Control

<Main Unit Control Area>

The main unit control area is the shaded area shown below. It is for controlling the RX-V1. You can use functions within this area no matter which Component Control Area is selected.

<Component Control Area>

The component control area is the shaded area shown below. Each component has different functions for operation buttons in the component control area. The component, which was chosen by pressing an input button, can be controlled and the display window shows the corresponding name of the input.

Advanced Operation

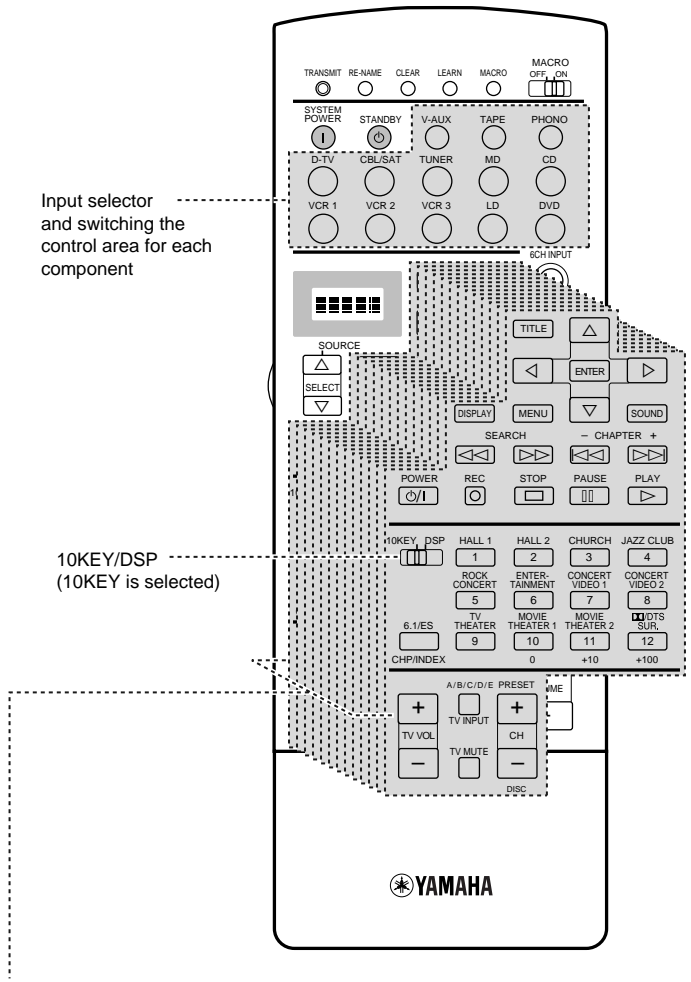
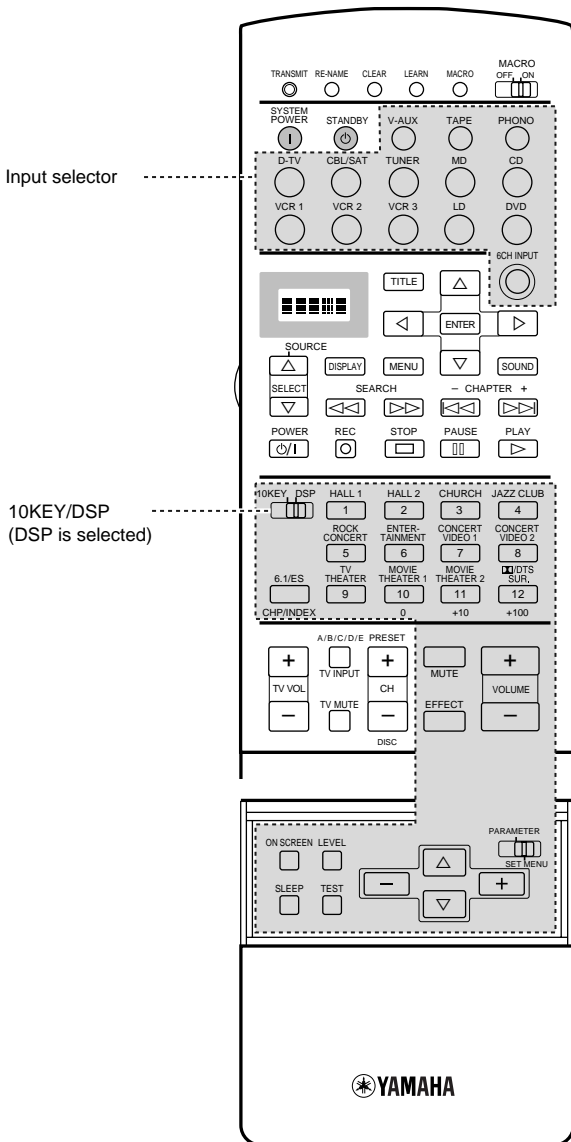

There are 14 component control areas. You can setup the manufacturer code and program other remote control functions in each area (Cannot setup the manufacturer code in the OPTN area). See pages 61 and 62.

■ SOURCE SELECT

You can control another component independently from the input you selected by pressing an input button.

- 1 Press **SELECT** Δ or ∇ to choose a component and set the remote control to be used for it.
- 2 The display window will show one of the following: **V-AUX**, **TAPE**, **PHONO**, **D-TV** (digital and regular TV), **CBSAT** (Cable TV/Satellite TV), **TUNER**, **MD**, **CD**, **VCR 1**, **VCR 2**, **VCR 3**, **LD**, **DVD**, **Zone2**, **OPTN** (Option).

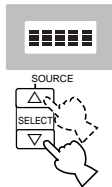

■ About Zone2

When you make up a second audio-video room with this unit's Zone2 system, you might want to use this remote control. Selecting **Zone2** sets the remote control to be in the **Zone2** mode. See page 69 for details.

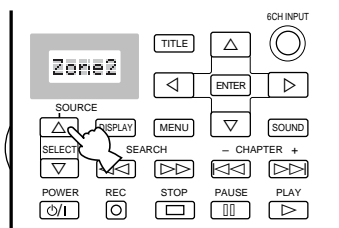

Pressing Δ selects **Zone2** first.

■ About OPTN

OPTN is an extra component control area to be programmed with other remote control functions. (You cannot setup the manufacturer code in this area.) See page 60 for the programmable area.

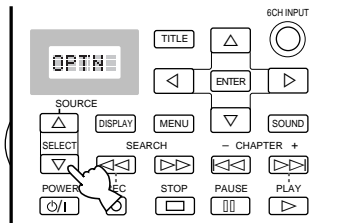

Pressing ∇ selects **OPTN** first.

■ Light up function

The buttons which are active and the display window light up for 10 seconds after pressing **LIGHT**.

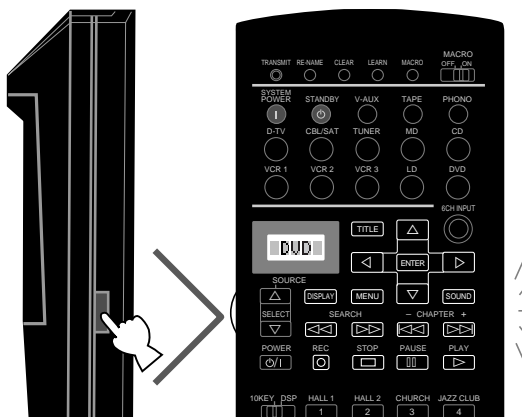

Each Component Control Area

The general operational buttons are shown for each area. Some of them may not function depending on the equipment you have.

■ Operating a Tuner (TUNER Area)

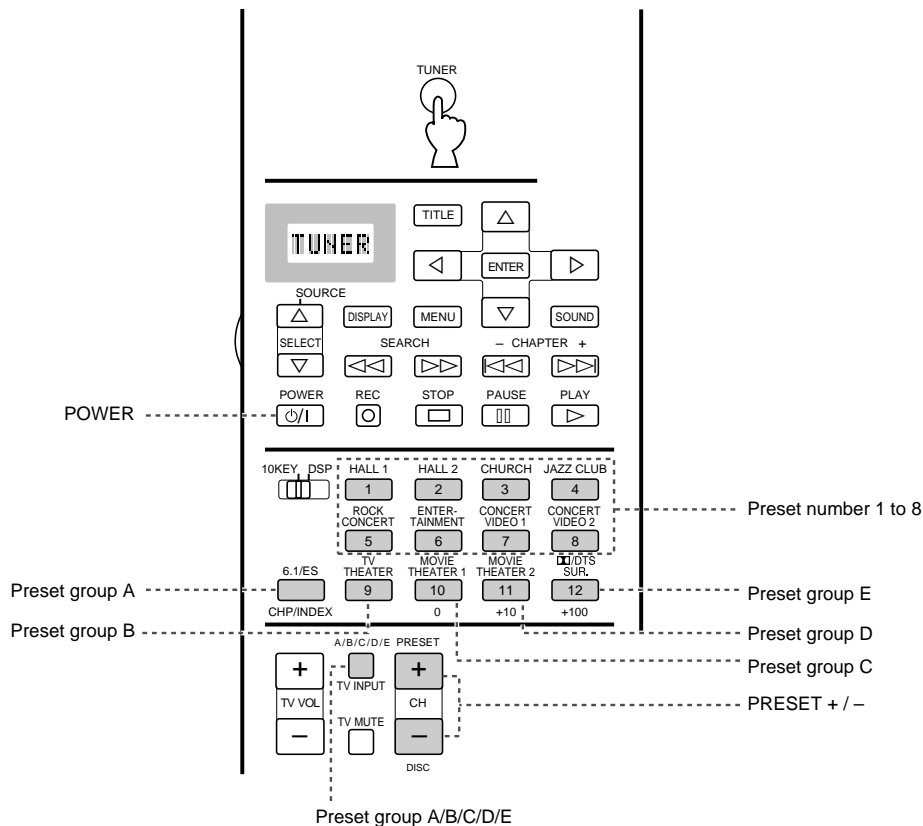

■ Operating a Tape Deck (TAPE Area)

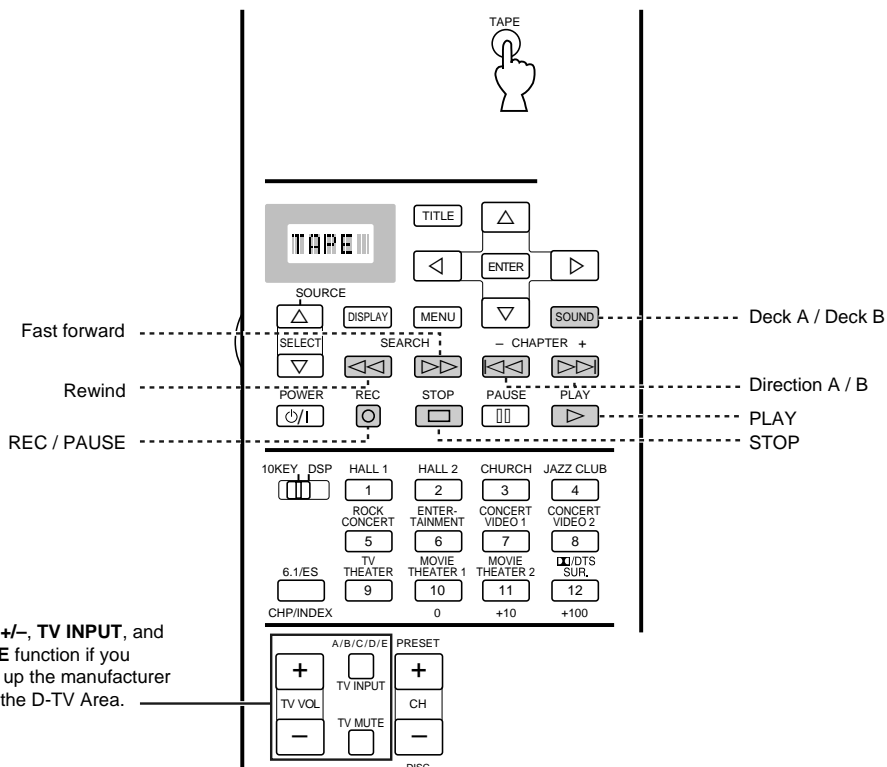

■ Operating a CD Player (CD Area)

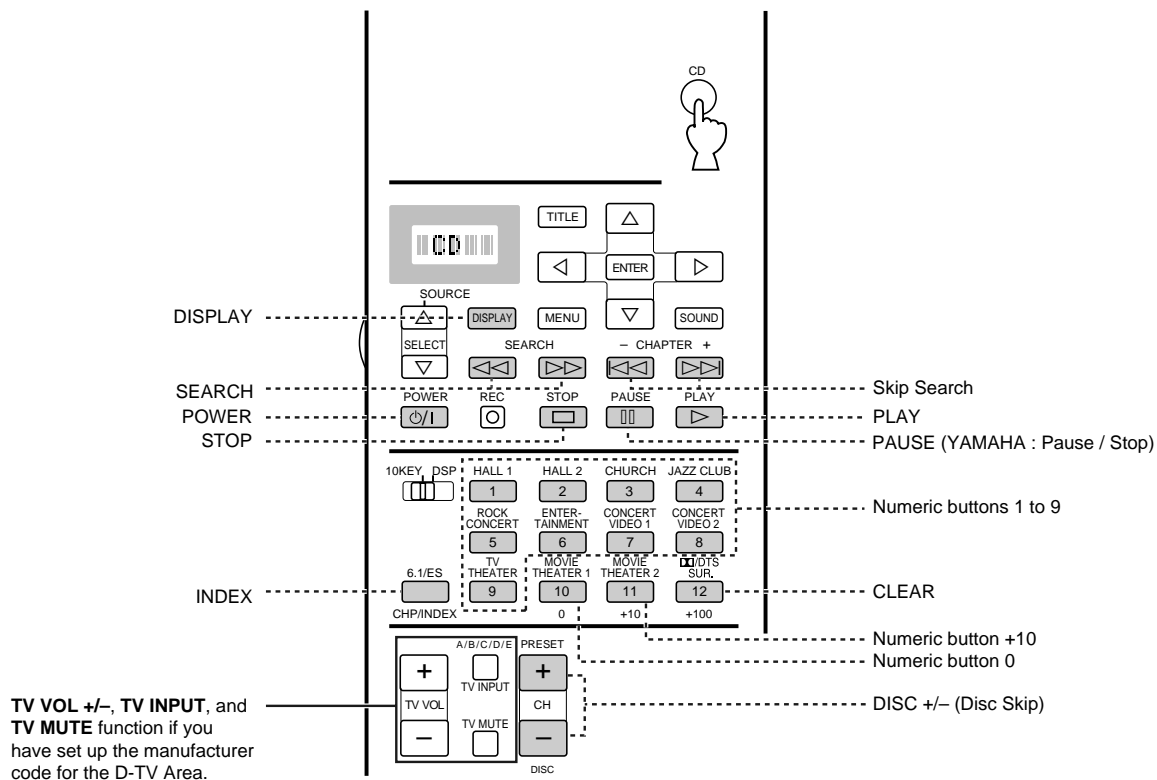

■ Operating an MD Recorder (MD Area)

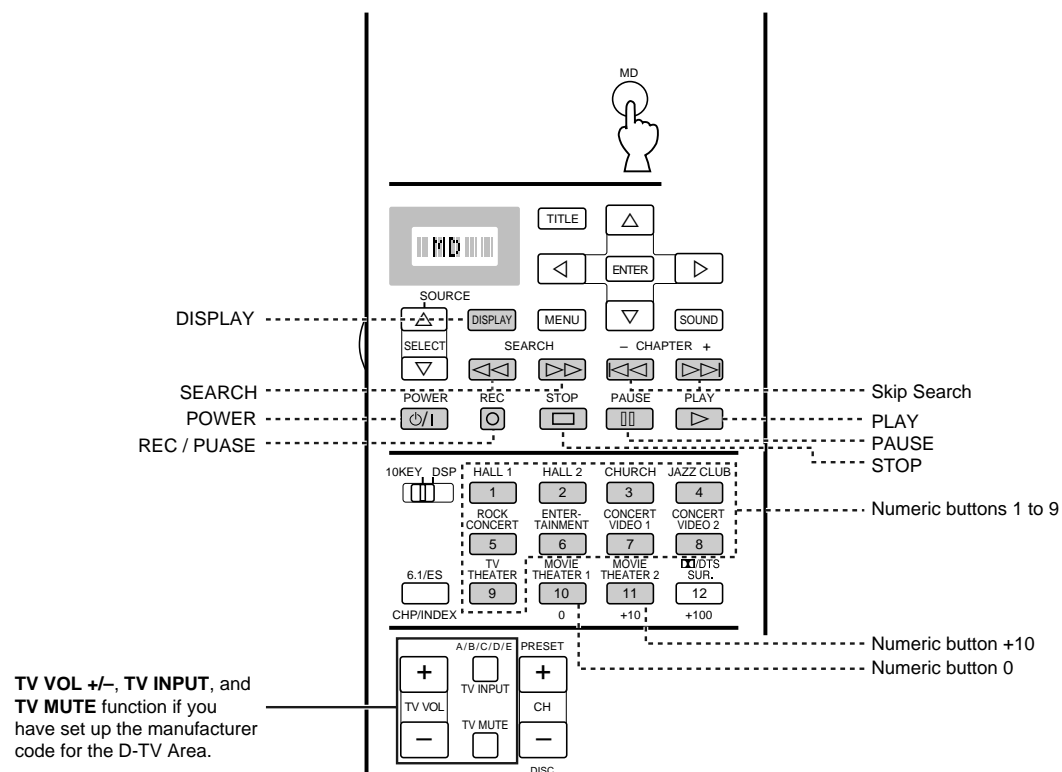

Operating an LD Player (LD Area)

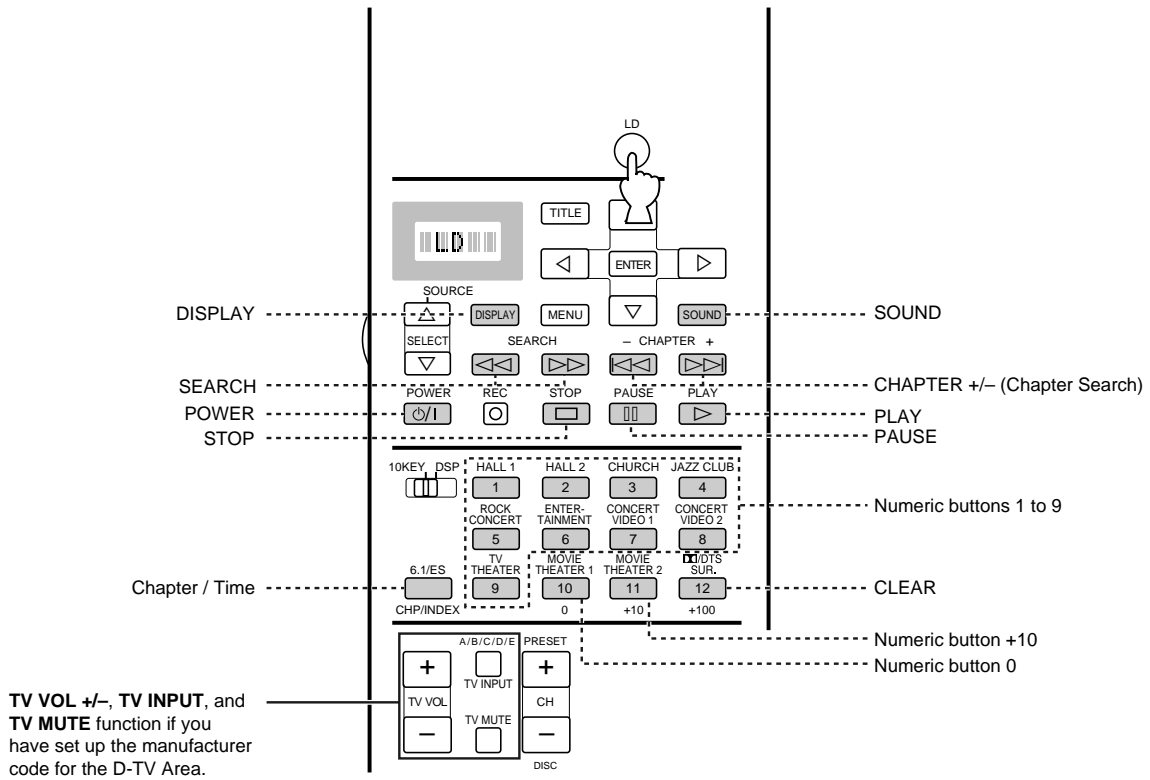

Operating a DVD Player (DVD Area)

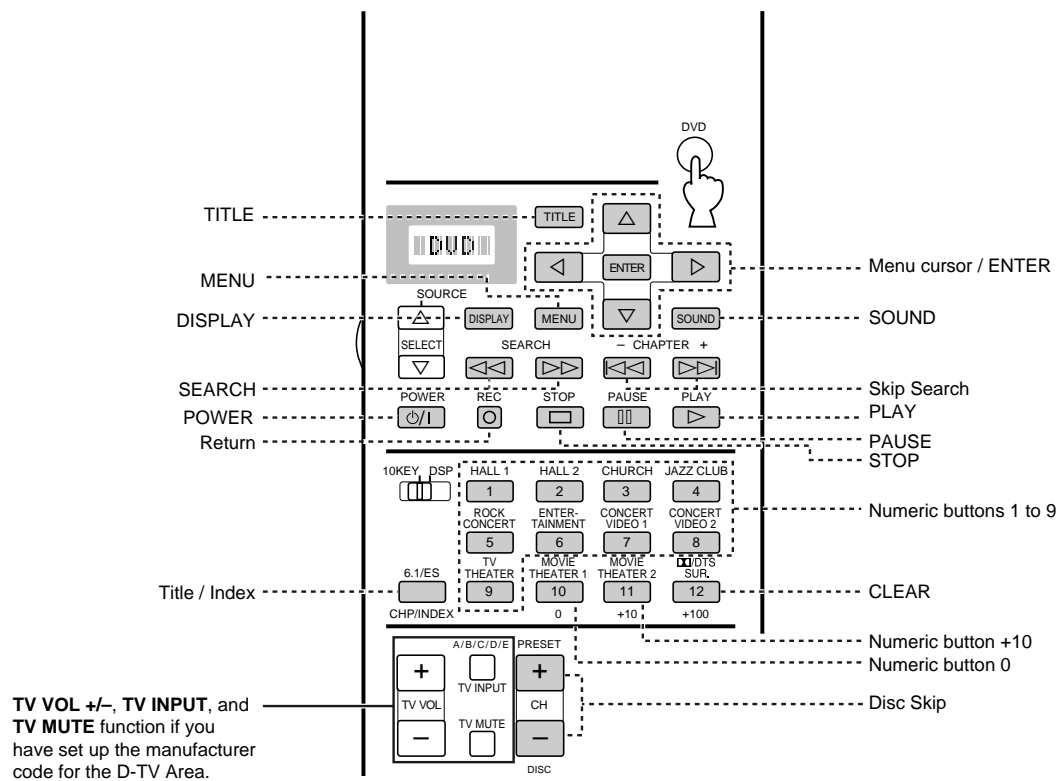

■ Operating a VCR (VCR 1 / VCR 2 / VCR 3 Area)

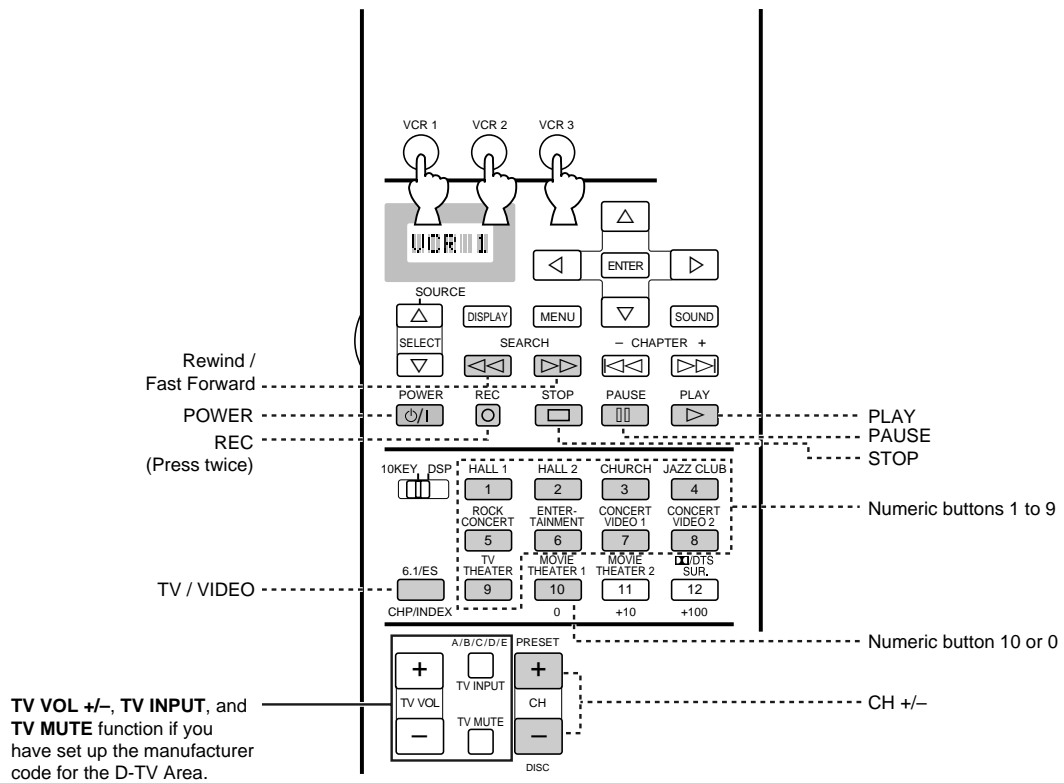

■ Operating a TV or Digital TV (D-TV Area)

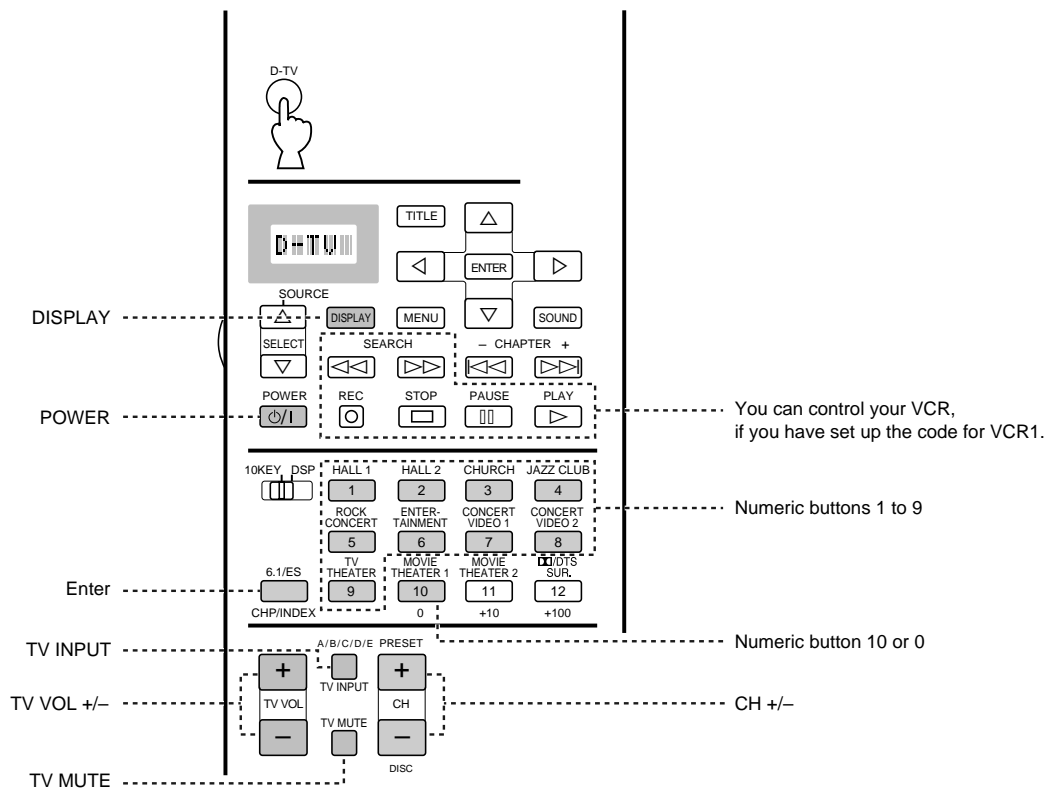

Operating a Cable or Satellite TV Tuner (CBSAT Area)

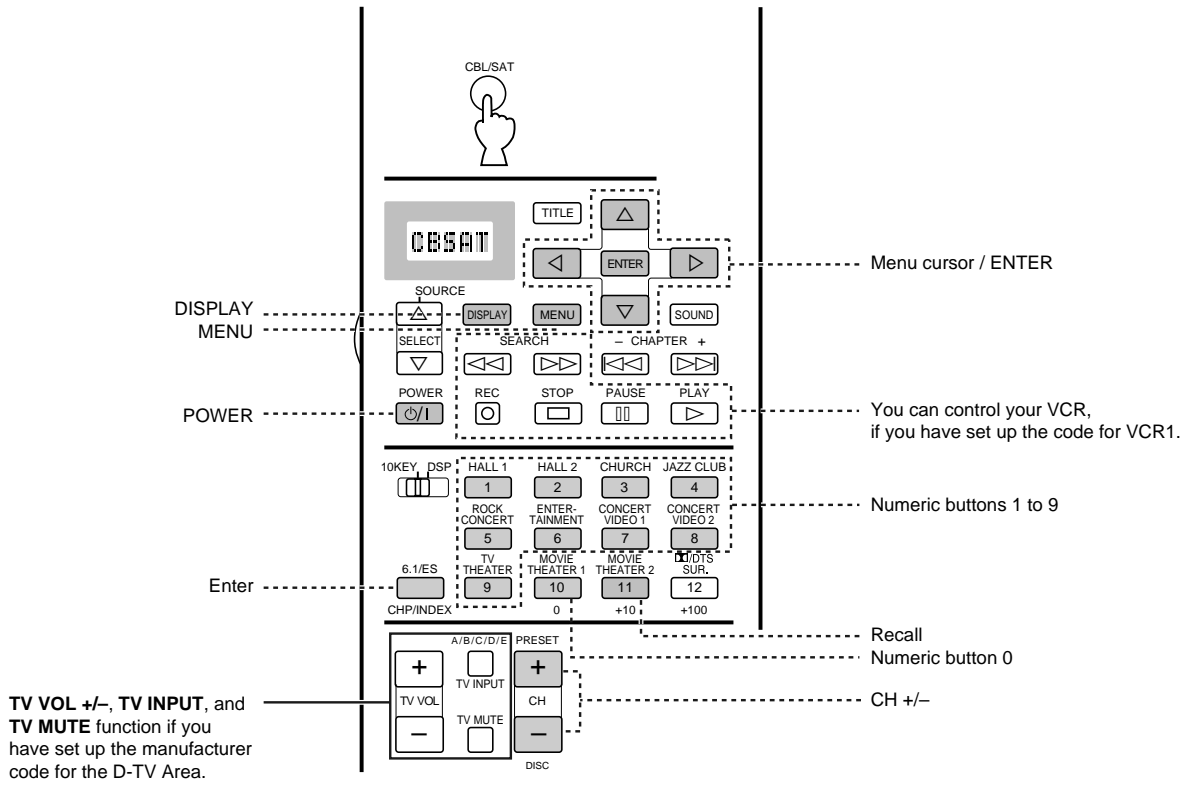

Free Area (OPTN and PHONO Areas)

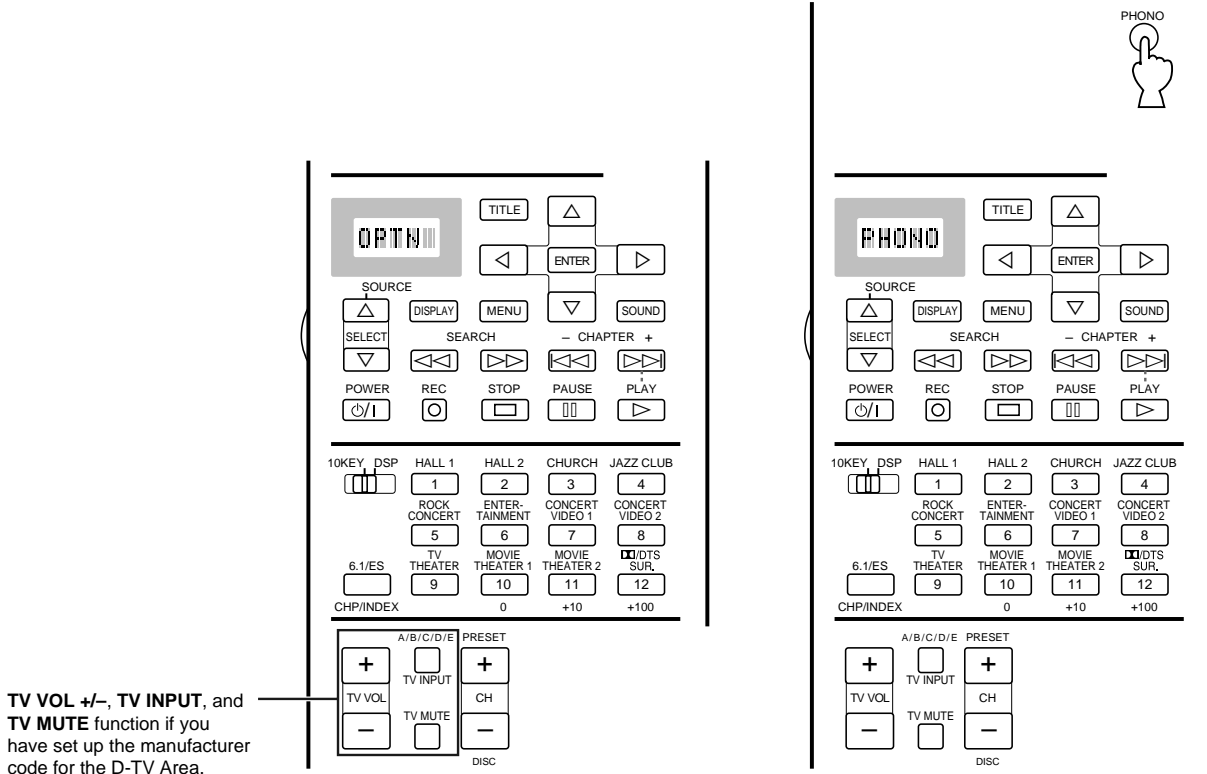

Setting the Manufacturer Code in the Remote Control

You can control other components by setting a manufacturer code. A code can be set up in each component control area except for the OPTN area. The Yamaha code is factory preset for DVD, LD, CD, MD, TUNER, and TAPE (Yamaha for LD, and Yamaha1 for others). There is no factory preset code on VCR1/2/3, D-TV, CBSAT, V-AUX, and PHONO.

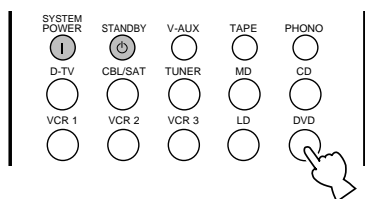

- 1 Select the source component you want to preset by using the input buttons.



- 2 Press and hold **LEARN** for about three seconds using a ballpoint pen or similar object.



- 3 Use Δ/∇ to select the name of your component's manufacturer.



• You will find the names of most audio-video manufacturers worldwide in alphabetical order on the display window.

- 4 Press **POWER** (or any other button) on the remote control while pointing it at the component to check if you have set up the code correctly. If the component cannot be controlled by the remote control, try entering another code for the same manufacturer.

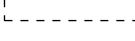
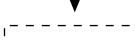
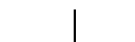

- 5 Press **LEARN** to confirm the preset.
 - If you want to preset another code for another component immediately, press **ENTER** and repeat steps 1 to 4.

Note:

- If you have already programmed a remote control function to a button, the function takes priority over the set up manufacturer code's function.

■ Controlling a different component from the source component (input) you selected

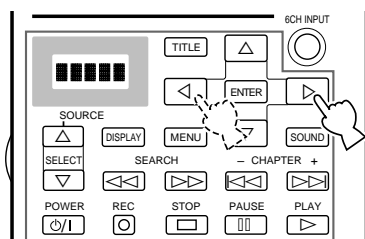

- 1 Repeat steps 1 and 2 of the procedure in "Setting the Manufacturer Code in the Remote Control".

- 2 Select a Library (component category) by using \triangle/∇ .

- There are 12 Libraries to set up a manufacturer code; L:TV, L:CAB (CABLE), L:DBS, L:SAT, L:VCR, L:DVD, L:LD, L:CD, L:MD, L:TAP (TAPE), L:TUN (TUNER), *L:AMP. *L:AMP has three codes; YPC, DSP, and NO. "YPC" should be selected to operate the RX-V1. "DSP" is for operating Yamaha DSP amplifiers other than the RX-V1. "NO" is to clear the main unit control area functions.

- 3 Repeat steps 3 and 4 of the procedure in "Setting the Manufacturer Code in the Remote Control".

Note:

- "ERROR" appears in the display window in the following conditions: when pressing a button other than the cursor and **ENTER**; when pressing more than one button at once; and when one of **MACRO ON/OFF**, **10KEY/DSP**, **PARAMETER/SET MENU** is switched to another position.

Programming a New Remote Control Function

If you desire to program functions not included in the basic operations covered by the manufacturer code, or a manufacturer code is not available, the following procedure needs to be performed. The possible programming area is the same as a component control area, so buttons are programmable independently for each source component area. It is also possible to program in the main unit control area. (Refer to page 54 for details on component control area and main unit control area.)

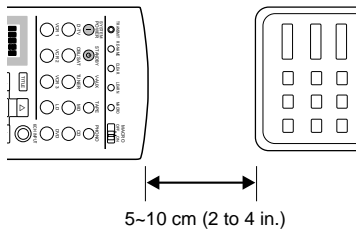

5~10 cm (2 to 4 in.)



- 1 Place this remote control and the other remote control about 5 to 10 cm (2 to 4 in.) apart on a flat surface so that their infrared transmitters are aimed at each other.
- 2 Select a source component.

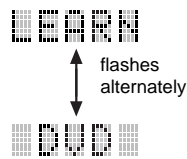

- 3 Press **LEARN** using a ball point pen or similar object.

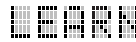
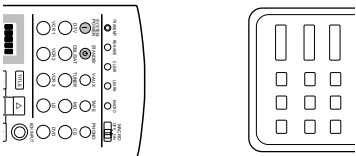

- 4 Press and release the button where you want the new function to be programmed.

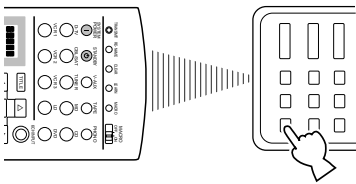

- 5 Press and hold the button on the other remote control that has the function you want to program into this remote control until "OK" appears in the display window.
 - "NG" appears in display window when programming is not done correctly.



- 6 Repeat Steps 4 and 5 to program additional functions.
- 7 Press **LEARN** again to exit the Learn mode.

Notes:

- If you do not press any button within 30 seconds, the learning process is canceled.
- This remote control transmits infrared rays. If the other remote control also uses infrared rays, this remote control can learn most of the other remote control's functions. However, you may not be able to program some special signals or extremely long transmissions. (Refer to the operation instructions for the other remote control.) When the memory is full, "FULL" appears in the display window, and this remote control cannot acquire any more functions. Clear unnecessary programmed functions to allow the unit to acquire new functions.
- Even if the batteries in the other remote control have enough power to transmit signals for operation, they may not have enough power to transmit signals to this remote control.
- When the remote controls are either too close together or too far apart, you may not be able to program this remote control.
- Direct sunlight interferes with infrared rays.
- "ERROR" appears in the display window in the following conditions: when pressing more than one button at once; and when **MACRO ON/OFF** is switched to another position.

Using the Macro Feature

The Macro feature makes it possible to perform a series of operations by pressing just one button. For example, when you want to play a CD, normally you would turn on the components, select the CD input, and press the play button to start playback. Using the Macro feature, you can perform all those operations by simply pressing the CD macro button. The macro buttons (the input buttons and **SYSTEM POWER ON/STANDBY**) are factory preset with macro programs. You can also program your own macros (see page 64).

Press a Macro button



Automatically transmits signals of each button sequentially



Macro button
TAPE
MD
LD
DVD
VCR 1
VCR 2
VCR 3
TUNER
V-AUX
PHONO
D-TV
CBL/SAT
SYSTEM POWER
STANDBY



First →	Second →	Third
	TAPE	PLAY (TAPE Area)
	MD	PLAY (MD Area)
	LD	PLAY (LD Area)
	DVD	PLAY (DVD Area)
	VCR 1	PLAY (VCR1 Area)
	VCR 2	PLAY (VCR2 Area)
	VCR 3	PLAY (VCR3 Area)
SYSTEM POWER (*1)	TUNER	_____
	V-AUX	_____
	PHONO	_____
	D-TV	_____
	CBL/SAT	_____
	POWER (D-TV Area) (*2)	_____
STANDBY	_____	_____

*1 In order to turn on some Yamaha components connected to this unit, connect those components to **AC OUTLETS** on the rear panel.

*2 If the macro you select includes power on/off functions, the equipment may turn off if it is already on when you press the macro button. For example, if your TV is on and you press the **SYSTEM POWER** macro button, the TV turns off.

Note:

- Make sure you set up the manufacturer code (See page 61) or program a function using the Learn feature (See page 62) to the remote control for your component, or the factory preset macros do not work.

■ Operating the Macro Feature

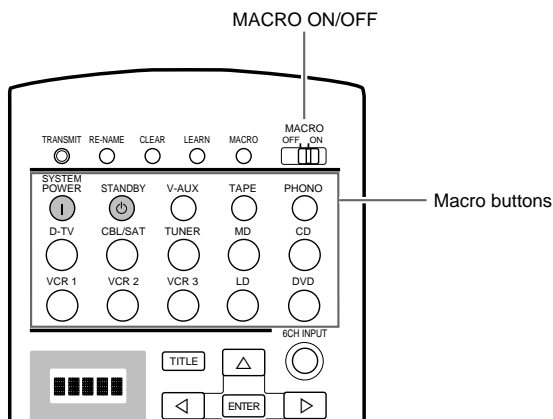

- 1 Set **MACRO ON/OFF** to **ON**.
- 2 Press a Macro button.

Notes:

- When you are finished using the Macro feature, set **MACRO ON/OFF** to **OFF**.
- While the main unit is carrying out a macro program, the main unit does not receive any other button's function until the macro is complete (the **TRANSMIT** indicator stops flashing).
- Continue to aim the remote control at the equipment the macro is operating until the macro program is complete.

■ Programming a Macro

You can use the Macro feature to transmit many remote control commands by pressing a single button.

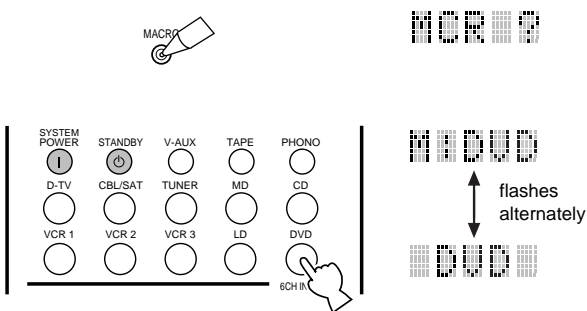

- 1 Press **MACRO** using a ball point pen or similar object.
- If you do not initiate the procedure within 30 seconds, the macro programming process is canceled.

- 2 Press the macro button on which you want to program the Macro.

- If you want to change the source component, use **SOURCE SELECT** Δ/∇ or input buttons. When you use input buttons, input is selected as a Macro step, whereas **SOURCE SELECT** Δ/∇ only changes the component.
- The display window shows the button you chose for programming the macro and the component name in alternation.

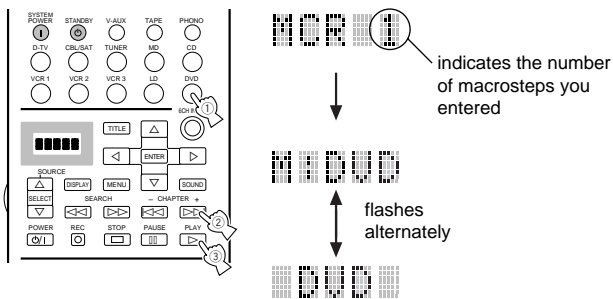

- 3 Press the buttons of the functions that you want to include in the macro sequence in order.

- You can set up to 10 Macro steps (10 functions).

- (ex)
- 1 MCR 1 : DVD input
 - 2 MCR 2 : DVD $\triangleright\triangleright$
 - 3 MCR 3 : DVD \triangleright

- 4 Press **MACRO** again when the sequence you want to program is complete.

- After you set 10 steps, "FULL" is displayed.

Notes:

- "NG" appears in the display window when programming is not done correctly.
- "ERROR" appears in the display window in the following conditions: when pressing more than one button at once; and when **MACRO ON/OFF** is switched to another position.

Changing the Source Name in the Display Window

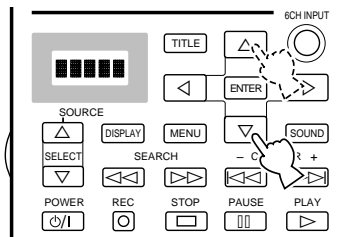
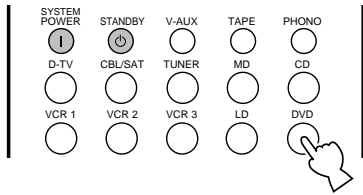

1 Select the source component you want to rename by using the input buttons.



2 Press **RE-NAME** using a ballpoint pen or similar object.



3 Use the cursor buttons Δ/∇ to select a character.

- Pressing ∇ changes the character in the following order: A~Z, a~z, 0~9, space, -(hyphen).

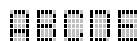

4 Use the cursor buttons $\triangleleft/\triangleright$ to enter a character or move to the next cursor position.



5 Press **RE-NAME** to confirm renaming.

- If you want to rename another source component immediately, press **ENTER** and repeat steps 1, 3 and 4.

Clearing a Learned Function or Macro

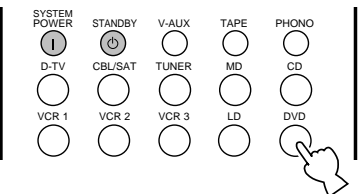

or



CLEAR While pressing

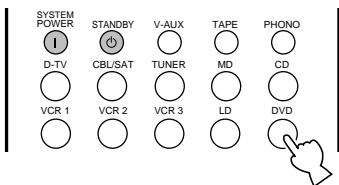

or



1 Select the source component that you want to clear on the window by using input buttons.



2 Press **LEARN** if you want to clear a learned function, or press **MACRO** to clear a programmed macro, using a ball point pen or similar object.

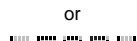

flashes alternately



3 Press and hold **CLEAR** using a ball point pen or similar object, and at the same time press the button from which you want to clear the learned function or macro for about 3 seconds.

- "C:NG" appears in the display window if the operation is unsuccessful. Should this occur, try doing step 3 again.

You can clear other learned functions and macros at this time by continuing to hold down **CLEAR** and pressing the other buttons on which those learned functions or macros are programmed.



flashes alternately



4 Press **LEARN** again to confirm clearing a learned function, or press **MACRO** again to confirm clearing a programmed macro.

- Once you clear a learned function or macro from a button, the button reverts to its factory preset function or macro.

Clearing Learned Functions, Macros, Renamed Displays, and Manufacturer Setups



0000

1 Press **CLEAR** using a ballpoint pen or similar object.

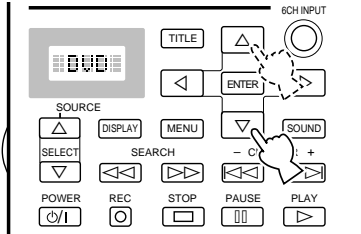

For example, when DVD is selected as the source component.

2 Press Δ/∇ to select the clear mode. The mode is shown in the window in the following order:

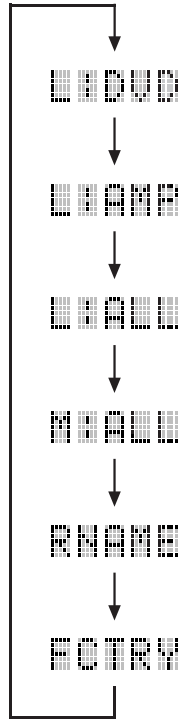

(L: name of a component) Clears all learning functions of the component.

Clears all learning functions of the main unit control area (see page 54).

Clears all learning functions.

Clears all macros.

Clears all renamed displays in the display window.

Clears all programmed functions including manufacturer code presets. This returns to the factory presets.



0000

3 Press and hold **CLEAR** again for about 3 seconds.

- “C:NG” appears in the display window if the operation is unsuccessful.

0000



0000

4 Press **CLEAR** to confirm clearing.

- Once you clear a learned function or macro from a button, the button reverts to its factory preset function or macro.

Notes:

- If the remote control is without batteries for more than twenty minutes, or if worn out batteries remain in the unit, the contents of the memory may be cleared. When the memory is cleared, insert new batteries and program any acquired functions that may have been cleared.
- “ERROR” appears in the display window for the following conditions: when pressing a button other than the cursor and **ENTER**; when pressing more than one button at once; and when one of **MACRO ON/OFF**, **10KEY/DSP**, **PARAMETER/SET MENU** is switched to another position.

Adjusting the Levels of the Effect Speakers

You can adjust the volume level of each effect speaker (Center, Right Rear, Rear Center, Left Rear, Front Effect, and Subwoofer) while listening to a music source.

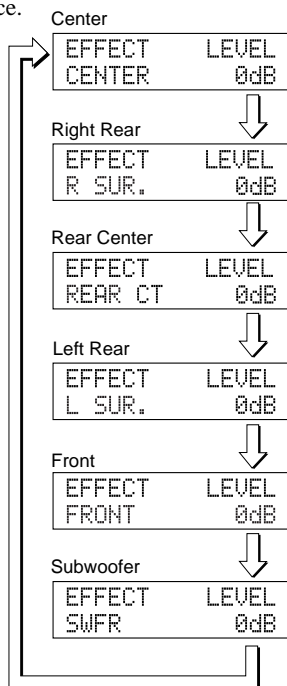
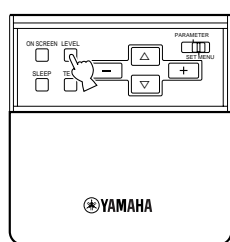

- 1 Set **PARAMETER/SET MENU** to **PARAMETER**.
- 2 Press **LEVEL** to select the speaker(s) you want to adjust.

Each time you press this button the selected speaker changes and appears in the front panel display only as follows: Center, Right Rear, Rear Center, Left Rear, Front Effect Speakers, and Subwoofer

- 3 Adjust the speaker volume level using the **+** or **-** on the remote control.

You can adjust the Center, Right Rear, Rear Center, Left Rear, Front Effect Speakers from +10 dB to -10 dB.

You can adjust the Subwoofer from 0 dB down to -20 dB.

Notes:

- You cannot adjust the left and right speakers independently.
- When you adjust the speaker level using **LEVEL**, the settings you made using the Dolby Surround Test and DSP Test change.
- When **PARAMETER/SET MENU** is set to **SET MENU**, you cannot adjust the speaker level using **LEVEL**. However, each time you press **LEVEL** the current level setting of each speaker appears. Select the speaker level you want to check using **Δ** or **∇**.

Setting the Sleep Timer

Use this feature to automatically turn off the main unit after the amount of time you set. The Sleep Timer is useful when you plan to fall asleep while the main unit is reproducing or recording a source. The Sleep Timer also automatically turns off external components connected to **AC OUTLETS**. The Sleep Timer can only be set using the remote control.

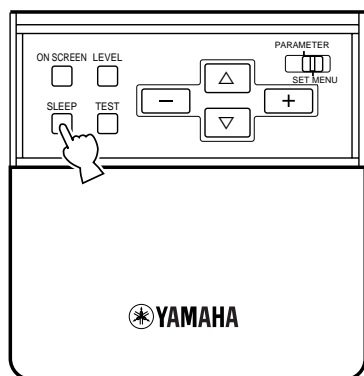

To set the Sleep Timer

- 1 Select a source using **INPUT SELECTOR** and start playback (or select a broadcast station) on the source component.
- 2 Press **SLEEP** repeatedly to set the amount of time before the main unit automatically turns off.

Each time you press **SLEEP**, the front panel display changes as shown below. After a few seconds the display returns to the previous indication.

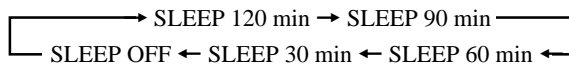

To cancel the Sleep Timer

- 1 Press **SLEEP** repeatedly until "SLEEP OFF" appears in the front panel display.

After a few seconds, the display returns to the previous indication.

Note:

- The Sleep Timer setting can also be canceled by turning off the main unit using **STANDBY** on the remote control (or **STANDBY/ON** on the front panel) or disconnecting the AC Power Cord from the AC outlet.

You can make up a multi-room audio-video system with this unit. With this feature, you can set this unit to reproduce separate input sources in the main room and second (Zone 2) room using the supplied remote control in the second room.

ONLY ANALOG SIGNALS ARE SENT TO THE SECOND ROOM. FOR ANY SOURCE YOU WISH TO LISTEN TO IN THE SECOND ROOM, YOU MUST CONNECT THE ANALOG OUTPUT FROM THE SOURCE TO THE CORRESPONDING ANALOG INPUT ON THIS UNIT.

Connections

To use the multi-room functions of this unit, you need the following additional equipment:

- An infrared signal receiver in the second room
- An infrared emitter in the main room
This emitter transmits the infrared signals from the remote control in the second room to the main room (for example, to a CD player or LD player).
- An amplifier and speakers for the second room
- A video monitor for the second room

Notes:

- Since there are so many ways to connect and use this unit in a multi-room installation, we recommend that you consult with a custom installation specialist for the Zone 2 connections which will best meet your requirements.
- Some Yamaha models are able to connect directly to the **REMOTE 1 OUT** jacks of this unit. If you own these products, you may not need to use an infrared emitter. Up to six Yamaha components can be connected as shown.

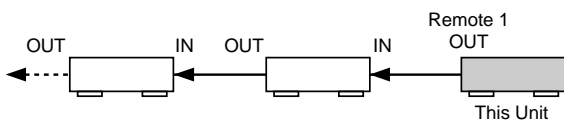

■ A sample of system configuration and connections

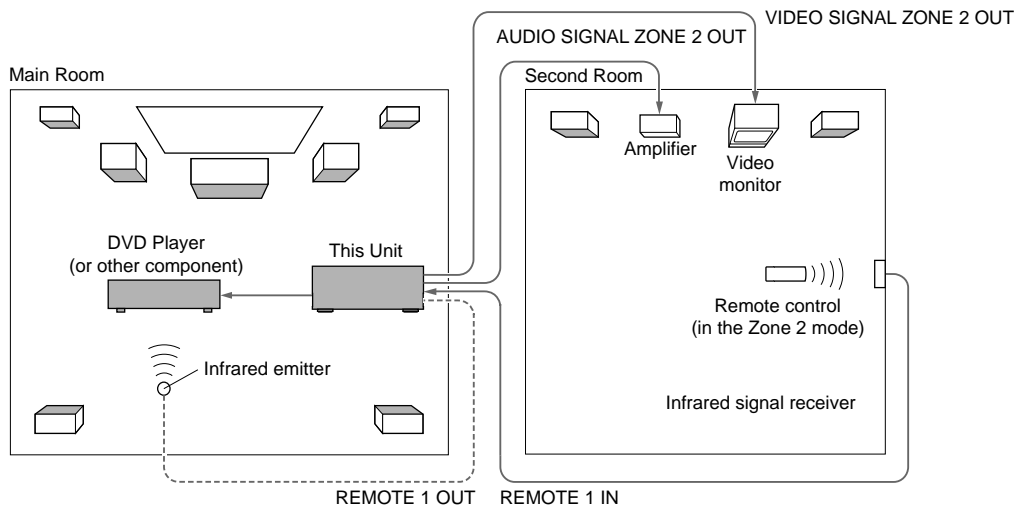

■ Special considerations when using DTS software

The DTS signal is a digital bitstream. Therefore, if you attempt to send the DTS signal to Zone 2, you will only be able to hear the digital noise sound that could damage your loudspeakers.

Due to this characteristic of DTS encoded discs, the following considerations and adjustments need to be made.

For DTS encoded LDs or DVDs

Only 2-channel audio signals may be sent to Zone 2, as follows:

- Laser disc – Set your Laser Disc player's left and right outputs to the analog sound track.
- DVD disc – Use the disc menu to set the DVD player's mixed 2-channel left and right audio outputs to PCM or Dolby Digital.

For DTS encoded compact discs

DO NOT USE the Zone 2 feature with DTS encoded compact discs.

Remote Control in ZONE 2

In the second (Zone 2) room, the supplied remote control can be used as the Zone 2 remote control. You can select the input source and control the component which is located in the main room directly from the second room regardless of the listening condition in the main room.

- 1 Press **SOURCE SELECT** Δ to display **ZONE2** in the display window.

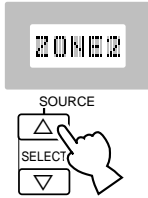

- 2 Use the input buttons to select the input source you want to listen to.

- The display window shows “2: name of selected input” if the remote control is in the Zone 2 mode.

- 3 You can control the component using the Component Control Area buttons.

Note:

- **VOLUME + / -** can be used to adjust the volume if you set the SET MENU item 18. ZONE2 SET, ZONE2 OUT to “VAR.” (see page 53).

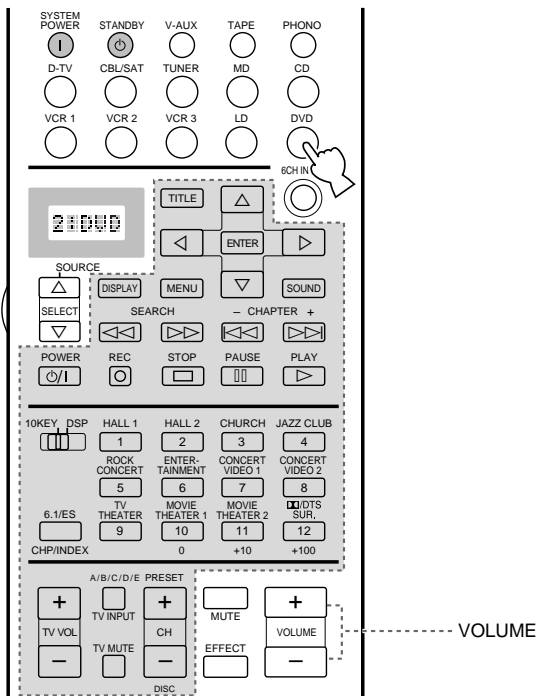

Additional Information

Digital Sound Field Processing (DSP) 71

Understanding Sound Fields	71
Recreating a Sound Field	71
E/R (Early Reflection)	71
4ch REV. (Four Channel Reverberation).....	71
Illustration of the Virtual Sound Sources and Echo Patterns	71

Hi-Fi DSP-Sound Field Program 72

Program Group 1 : Concert Hall 1	72
Program Group 2 : Concert Hall 2	72
Program Group 3 : Church	72
Program Group 4 : Jazz Club	72
Program Group 5 : Rock Concert	72
Program Group 6 : Entertainment	72

CINEMA-DSP 73

The Sound Design of CINEMA-DSP Sound Field Programs	73
Sound Field Images of the CINEMA-DSP Programs	73
Movie Theater Programs	74

CINEMA-DSP Sound Field Program 75

Program Group 7 : Concert Video 1	76
Program Group 8 : Concert Video 2	76
Program Group 9 : TV Theater	76
Program Group 10 : Movie Theater 1	76
Program Group 11 : Movie Theater 2	76
Program Group 12 : Dolby/DTS Surround	76

Sound Field Program Parameter Editing 77

Changing Parameter Settings	77
Resetting a Parameter to the Factory Preset Value	77

Digital Sound Field Parameter Descriptions 78

EFCT TRIM (Effect Trim)	78
INIT. DLY (Initial Delay)	78
P. INIT. DLY (Presence Initial Delay)	78
RC. INIT. DLY (Rear Center Initial Delay)	78
S. INIT. DLY (Surround Initial Delay)	78
S. DLY (Surround Delay)	79
ROOM SIZE	79
RC. ROOM SIZE (Rear Center Room Size)	80
S. ROOM SIZE (Surround Room Size)	80
LIVENESS	80
S. LIVENESS (Surround Liveness)	80
RC LIVENESS (Rear Center Liveness)	80
REV. TIME (Reverberation Time)	81
REV. DELAY (Reverberation Delay)	81
REV. LEVEL (Reverberation Level)	81

Understanding Sound Fields

A sound field is defined as the “characteristic sound reflections of a particular space.” In concert halls and other music venues, we hear early reflections and reverberations as well as the direct sound produced by the artist(s). The variations in the early reflections and other reverberations among the different music venues is what gives each venue its special and recognizable sound quality.

Yamaha sent teams of sound engineers all around the world to measure the sound reflections of famous concert halls and music venues, and collect detailed sound field information such as the direction, strength, range, and delay time of those reflections. Then we stored this enormous amount of data in the ROM chips of the RX-V1.



Recreating a Sound Field

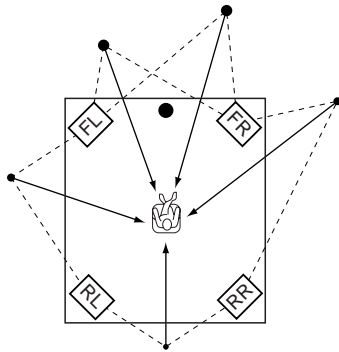

Recreating the sound field of a concert hall or an opera house requires localizing the virtual sound sources in your listening room. The traditional stereo system that uses only two speakers is not capable of recreating a realistic sound field. Yamaha’s DSP requires four effect speakers to recreate sound fields based on the measured sound field data. The processor controls the strength and delay time of the signals output from the four effect speakers to localize the virtual sound sources in a full circle around the listener.

The DSP sound field programs can be classified in two types based on the sound field processing method: programs that use early reflections only and programs that use both early reflections and reverberation.

E/R (Early Reflection)

Each sound field is distinguished by the structure of the reflected sound. The increased processing capability of DSP technology enables Yamaha engineers to incorporate even minute reflections with long delay times into the sound field data.

4ch REV. (Four Channel Reverberation)

This type of program consists of early reflections and high quality digital reverberation processing. Reverberation is the most important element for recreating the sound field of a church. To recreate a realistic spatial sound image from reverberation data, Yamaha has adapted the four-channel-output reverberation technology.

Illustration of the Virtual Sound Sources and Echo Patterns

The virtual sound sources and echo patterns for the DSP sound field programs are shown below. The illustration of the virtual sound sources shows early reflection sound only and the illustration of the echo patterns shows both reflected sound and reverberation.

Virtual Sound Sources

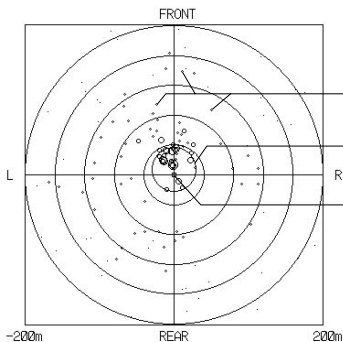

The center of these circles represent the virtual sound source.
The size of the circle indicates the strength of the virtual sound source.

The direct sound source

The listening position

Echo Patterns

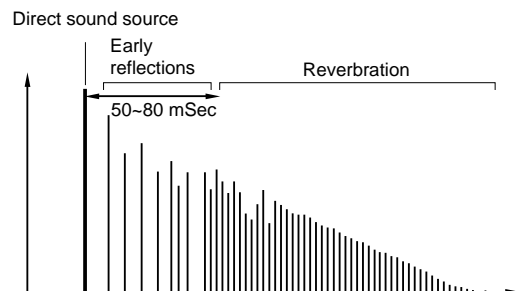

Program Group 1 : Concert Hall 1

■ Europe Hall A

This is a large fan-shaped concert hall in Munich which has approximately 2500 seats. Almost the whole interior is made of wood. There is relatively little reflection from the walls, and sound spreads finely and beautifully.

■ Europe Hall B

This is a large shoe-box type concert hall with less than 2400 seats located in Frankfurt. This hall has a very solid, powerful sound. The listener's virtual seat is in the center-right section on the first floor.

■ Europe Hall C

A classic shoe-box type concert hall with approximately 1700 seats. Pillars and ornate carvings create extremely complex reflections which produce a very full, rich sound.

Program Group 2 : Concert Hall 2

■ U.S.A. Hall D

This is a large 2600 seat concert hall in the United States which features a fairly traditional European design. The interior is relatively simple, in the American style. The middle and high frequencies are richly and beautifully reinforced.

■ Europe Hall E

This is a large 2200 seat shoe-box type concert hall in Amsterdam. It has a circular stage with seats located behind the stage.

■ Live Concert

A large round concert hall with a rich surround effect. Pronounced reflections from all directions emphasize the extension of sounds. The sound field has a great deal of presence, and your virtual seat is near the center, close to the stage.

Program Group 3 : Church

■ Tokyo

The acoustic environment of an ordinary church with moderate reverberations. The reverberation lasts 2.5 seconds. This is ideal for reproducing church organ and choral music.

■ Freiburg

This program recreates the acoustic environment of a big church located in south Germany. The reverberation delay is very long while the early reflections are smaller than with other sound field programs.

■ Royaumont

This program features the sound field created by the refectory (dining hall) of a beautiful medieval Gothic monastery located in Royaumont on the outskirts of Paris.

Program Group 4 : Jazz Club

■ Village Gate

This is the sound field at a jazz club in New York. It is in a basement and has a relatively spacious floor area. The listener's virtual seat is at the center left of the hall.

■ Village Vanguard

A traditional jazz club in New York, located on 7th Avenue. This room has a low ceiling, and the "stage" is located in a corner. This program creates an intimate "close-to-the music" feel.

■ The Bottom Line

This is the sound field at stage front in "The Bottom Line", a famous New York jazz club. The floor can seat 300 people to the left and right in a sound field offering a real and vibrant sound.

Program Group 5 : Rock Concert

■ Roxy Theatre

The ideal program for lively, dynamic rock music. The data for this program was recorded at LA's "hottest" rock club. The listener's virtual seat is at the center-left of the hall.

■ Warehouse Loft

This program simulates a space enclosed by concrete. An energetic sound field is created with relatively clear reflections from the walls.

■ Arena

A classic shoe-box type concert hall. This program gives you long delays between direct sounds and effect sounds, with the extraordinarily spacious feel of a large arena.

Program Group 6 : Entertainment

■ Disco

This program recreates the acoustic environment of a lively disco in the heart of a big city. The sound is dense and highly concentrated. It is also characterized by a high-energy, "immediate" sound.

■ Party

This is a sound field suitable for background music at parties where you can hear the sound directly from the rear as well, thus realizing music enjoyment over a wide area.

■ Game/Amusement

This program adds a deep and spatial feeling to video game sounds and is also suitable for karaoke.

The Sound Design of CINEMA-DSP Sound Field Programs

Filmmakers intend the dialog to be located right on the screen, the effect sound a little farther back, the music spread even farther back, and the surround sound around the listener. Of course, all of these sounds must be synchronized with the images on the screen. CINEMA-DSP is an upgraded version of YAMAHA DSP specially designed for movie soundtracks. CINEMA-DSP integrates the DTS, Dolby Digital, and Dolby Pro Logic surround sound technologies with YAMAHA DSP sound field programs to provide the surround sound field. It recreates the most complete movie sound design in your audio room. In CINEMA-DSP sound field programs, Yamaha's exclusive DSP processing is added to the front left, center, and right channels, so the listener can enjoy realistic dialogue, depth of sound, smooth transition between sound sources, and a surround sound field that goes beyond the screen. When a DTS or Dolby Digital signal is detected, the CINEMA-DSP sound field processor automatically chooses the most suitable sound field program for that signal.

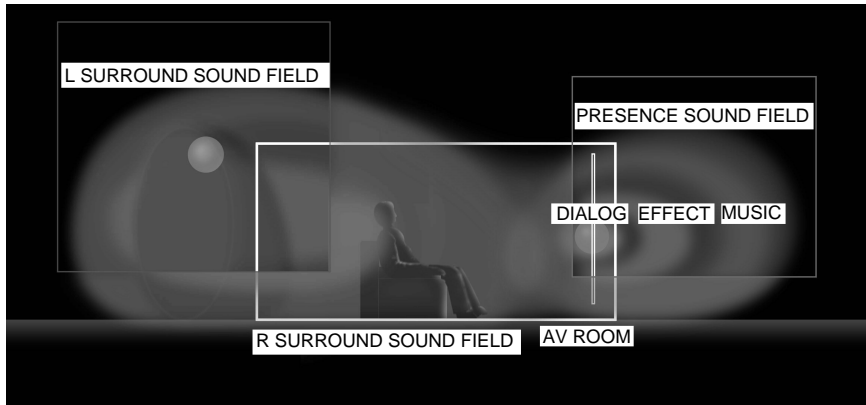

Sound Field Images of the CINEMA-DSP Programs

Each CINEMA-DSP program has its own type of sound field processing block. The sound field data, including the presence and surround sound fields, are based on actual measured data. The presence and surround sound fields can be expressed in the distribution of virtual sound sources and echo patterns. However, as these two types of sound fields are processed with complex elements such as energy balance and mixing signal ratios, they are expressed as a sound field based on auditory perception.

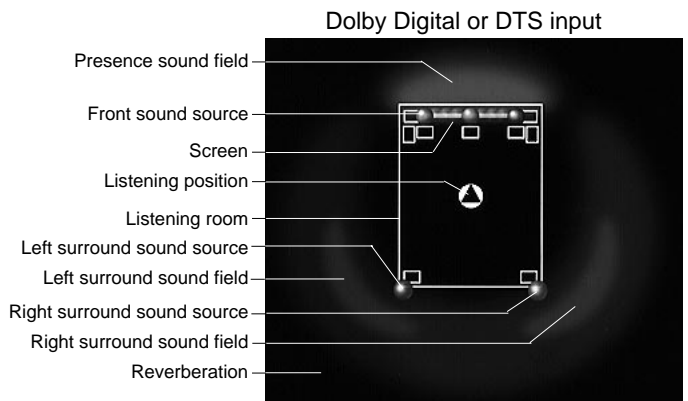
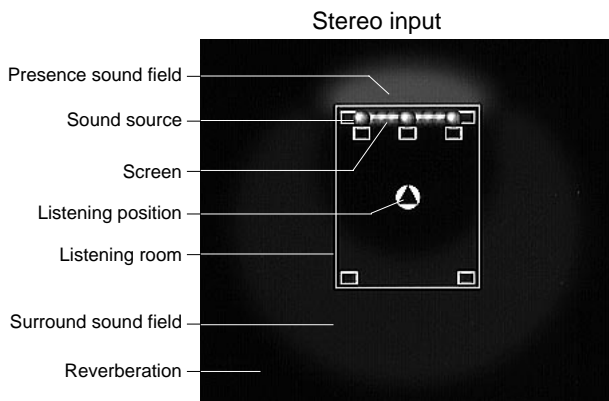

Movie Theater Programs

Most movie software has four-channel (left, center, right and surround) sound information encoded using Dolby Surround matrix processing and stored on the left and right tracks. These signals are processed by the Dolby Pro Logic decoder. The Movie Theater Programs are designed to recreate the spaciousness and delicate nuances of sound that tend to be lost in the encoding and decoding processes.

The six-channel soundtracks found on 70 mm film produce precise sound field localization and rich, deep sound without using matrix processing. The RX-V1's Movie Theater 70 mm Programs provide the same quality of sound and sound localization that six-channel soundtracks do. The built-in Dolby Digital decoder brings the professional quality sound designed for movie theaters, into your home. With the RX-V1's Movie Theater program, you can recreate a dynamic sound that gives you the feeling of being at a public theater in your living room using the Dolby Digital technology.

■ Dolby Pro Logic + DSP Sound Field Effect

These programs express an immense sound field and a large surround effect. They also give depth to the sound from the Main Speakers to recreate the realistic sound of a Dolby Stereo theater.

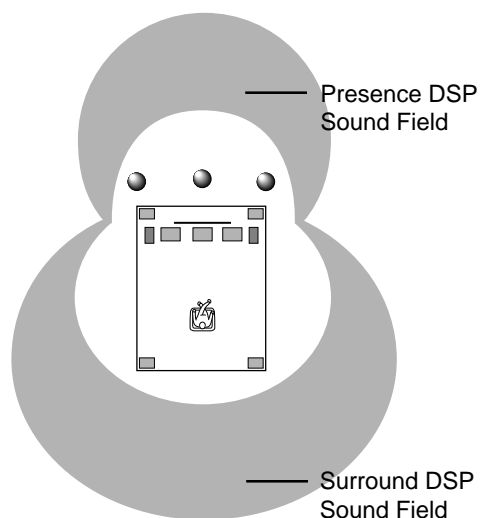

■ Dolby Digital/DTS + DSP Sound Field Effect

These programs use Yamaha's tri-field DSP process on each of the Dolby Digital signals for the front, left surround, and right surround channels. This processing enables the RX-V1 to reproduce the immense sound field and surround expression of a Dolby Digital equipped movie theater without sacrificing the clear separation of all channels.

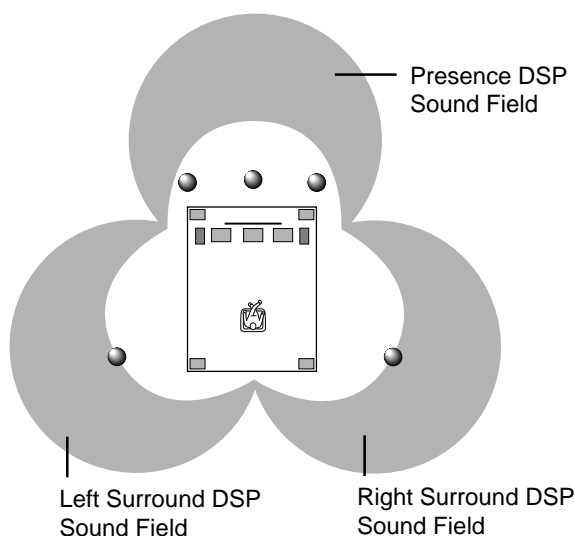

■ Dolby Digital Matrix 6.1/DTS ES + DSP Sound Field Effect

These programs provide you the maximum experience of the spacious surround effects since an extra Rear Center DSP sound field created from the Rear Center channel is added.

According to the input signal format, the RX-V1 automatically chooses the appropriate decoder and DSP sound field pattern.

Table of Program Names for Each Input Format

Input		Stereo (2ch)	DOLBY DIGITAL (5.1ch)	DTS (5.1ch)	DOLBY DIGITAL (6.1ch)*	DTS ES (6.1ch)*
7	CONCERT VIDEO 1	Pop/Rock	-----	-----	-----	-----
		DJ	-----	-----	-----	-----
8	CONCERT VIDEO 2	Classical/Opera	-----	-----	-----	-----
		Pavilion	-----	-----	-----	-----
9	TV THEATER	Mono Movie	-----	-----	-----	-----
		Variety/Sports	-----	-----	-----	-----
10	MOVIE THEATER 1	70 mm Spectacle	DGTL Spectacle	DTS Spectacle	Spectacle 6.1	Spectacle ES
		70 mm Sci-Fi	DGTL Sci-Fi	DTS Sci-Fi	Sci-Fi 6.1	Sci-Fi ES
11	MOVIE THEATER 2	70 mm Adventure	DGTL Adventure	DTS Adventure	Adventure 6.1	Adventure ES
		70 mm General	DGTL General	DTS General	General 6.1	General ES
12	PRO LOGIC	Normal	-----	-----	-----	-----
		Enhanced	-----	-----	-----	-----
	DOLBY DIGITAL	-----	Normal	-----	Matrix 6.1	-----
		-----	Enhanced	-----	Enhanced 6.1	-----
	DTS DIGITAL SUR	-----	-----	Normal	-----	ES
		-----	-----	Enhanced	-----	Enhanced ES

* The Matrix decoder is ON.

■ Program Groups 7~9

These are sound field programs for the audio-video sources.

■ Program Groups 10~12

Ideal for reproducing a movie program which is encoded with Dolby Surround, Dolby Digital, or DTS. When the newest movie program encoded with Dolby Digital Surround EX or DTS ES is input, you can enjoy the full 6.1 channel reproduction using the internal Matrix decoder.

PRO LOGIC functions when the input signal is analog or PCM audio, or encoded with Dolby Digital in two channels.

DOLBY DIGITAL functions when the input signal is encoded with Dolby Digital in more than two channels.

DTS DIGITAL SUR functions when the input signal is encoded with DTS.

Note:

- No sound will be output from the Main speakers when a monaural source is played with sound field Program Groups 7~12.

Program Group 7 : Concert Video 1

■ Pop/Rock

This program produces an enthusiastic atmosphere and lets you feel as if you are at an actual jazz or rock concert.

■ DJ

The sound field makes the voice of a disc jockey sound clearer.

Program Group 8 : Concert Video 2

■ Classical/Opera

This program provides excellent vocal depth and overall clarity by restraining excessive reverberation.

The surround sound field is relatively moderate but it reproduces beautiful sound using data collected from a concert hall.

■ Pavilion

This program reproduces vocals clearly, letting you feel the spaciousness of a pavilion. Reverberation, which is somewhat delayed, reproduces the live acoustics unique to a pavilion, and helps to make concert scenes more exciting.

Program Group 9 : TV Theater

■ Mono Movie

This program is provided for reproducing monaural video sources (such as old movies). The program produces the optimum reverberation to create sound depth using only the presence sound field.

■ Variety/Sports

Though the presence sound field is relatively narrow, the surround sound field employs the sound environment of a large concert hall. With this program, you can enjoy watching various TV programs such as news, variety shows, music programs or sports programs.

Program Group 10 : Movie Theater 1

■ Spectacle

This program creates the extremely wide sound field of a 70 mm movie theater. It precisely reproduces the source sound in detail, making both the video and the sound fields incredibly real. This program is ideal for any kind of Dolby Surround video source (especially large-scale movie productions).

■ Sci-Fi

This program clearly reproduces the broad and expansive cinematic space from the soundtracks of the latest science fiction films.

Program Group 11 : Movie Theater 2

■ Adventure

This program is ideal for precisely reproducing the sound design of the newest 70 mm and multichannel soundtrack films. The sound field is made to be similar to that of the newest movie theaters, so the reverberations of the sound field itself are restrained as much as possible.

■ General

This program is for reproducing sounds from 70 mm and multichannel soundtrack films, and is characterized by a soft and extensive sound field. The presence sound field is relatively narrow. It spatially spreads all around and toward the screen, restraining the effect of conversations without losing clarity.

Program Group 12 : Dolby/DTS Surround

■ Normal/Matrix 6.1/ES

The built-in decoder precisely reproduces sounds and sound effects from sources. The highly efficient decoding process improves crosstalk and channel separation and makes sound positioning smoother and more precise.

In this program, no DSP effect is applied.

■ Enhanced/6.1/ES

This program ideally simulates the multiple surround speaker systems of 35 mm film theaters. The Dolby Surround decoding and the digital sound field processing create precise effects without altering the original sound orientation. The surround effects produced by this sound field wrap around the viewer naturally from the back to the left and right and toward the screen.

You can enjoy good quality sound with the pre-set parameters. Although you do not have to change the initial settings, you can change some of the parameters to better suit the input source or your listening room.

Changing Parameter Settings

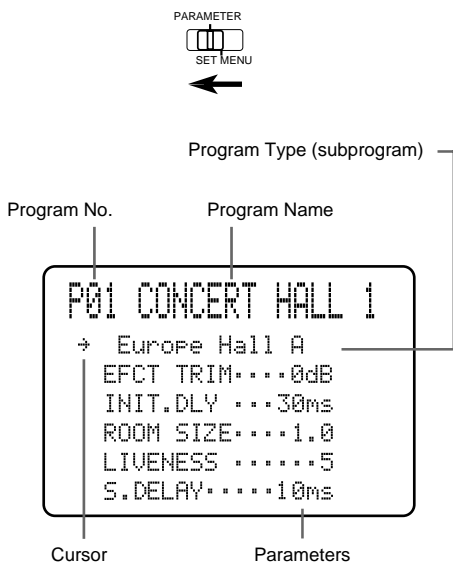

Example of the CONCERT HALL 1

- 1 Set **PARAMETER/SET MENU** to **PARAMETER** on the remote control.
- 2 Turn on your video monitor and press **ON SCREEN** to select the full display.
- 3 Select the sound field program you want to adjust.
- 4 Press ∇ or \triangle to select the parameter.
- 5 Press **+** or **-** to change the parameter value.

When you set the parameter to a value other than the factory preset value, an asterisk mark appears by the parameter name on the monitor screen.

- 6 Repeat steps 3 through 5 above as necessary to change other program parameters.

Resetting a Parameter to the Factory Preset Value

■ To reset some of the parameters to the factory preset values

Select the parameter you want to reset. Then, press and hold **+** or **-** until the value stops at the factory preset value temporarily. (The asterisk mark by the parameter name disappears on the video monitor.)

■ To reset all of the parameters back to the factory preset values

Use the **SET MENU** to reset all of the parameter values of all DSP programs within the selected group to the factory preset values (see page 51). This operation resets all of the parameter values of all DSP programs within that group to the factory preset values.

Notes:

- The available parameters may be displayed on more than one OSD page for some of the programs. To scroll through pages, press ∇ or \triangle .
- When "MEMORY GUARD!" appears on the screen, the Memory Guard function is on, and you cannot change parameter values. Turn off the Memory Guard function using the **SET MENU** (see page 52).

Digital Sound Field Parameter Descriptions

You can adjust the values of certain digital sound field parameters so the sound fields are recreated accurately in your listening room. Not all of the following parameters are found in every program.

EFCT TRIM (Effect Trim)

Function This parameter adjusts the level of all the effect sounds within a narrow range.

Control Range -3 dB - +3 dB

Description Depending on the acoustics of your listening room, you may want to increase or decrease the effect level relative to the direct sound.

INIT. DLY (Initial Delay)

Function This parameter changes the apparent distance from the source sound by adjusting the delay between the direct sound and the first reflection heard by the listener.

Control Range 1 - 99 milliseconds

Description The smaller the value, the closer the sound source seems to the listener. The larger the value, the farther the apparent distance seems. For a small room, this parameter would be set to a small value, for a large room, set it to a large value.

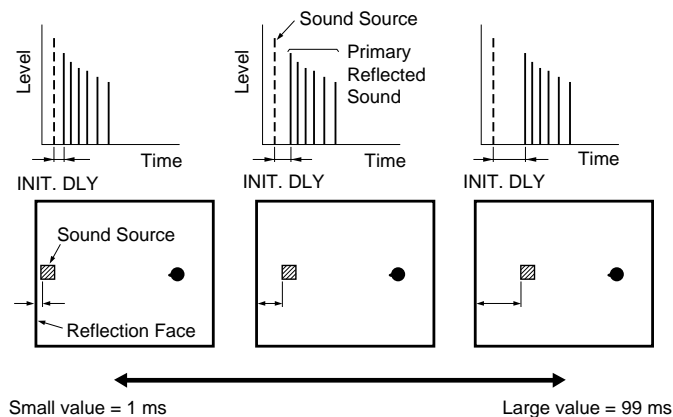

P. INIT. DLY (Presence Initial Delay)

Function This parameter adjusts the delay between the direct sound and the first reflection in the presence sound field.

Control Range 1 - 99 milliseconds

Description The larger the value, the later the first reflection begins.

RC. INIT. DLY (Rear Center Initial Delay)

Function This parameter adjusts the delay between the direct sound and the first reflection in the rear center sound field.

Control Range 1 - 49 milliseconds

Description The larger the value, the later the first reflection begins.

S. INIT. DLY (Surround Initial Delay)

Function This parameter adjusts the delay between the direct sound and the first reflection on the surround side of the sound field. You can only adjust this parameter when at least two front channels and two rear channels are used.

Control Range 1 - 49 milliseconds

Description The larger the value, the later the first reflection begins. You can only adjust this parameter for the Dolby Digital and DTS signals.

S. DLY (Surround Delay)

Function This parameter adjusts the delay between the direct sound and the first reflection in the surround sound field.
 Control Range 0 - 49 milliseconds (The range depends on the signal format.)
 Description When Dolby Digital signals are decoded: the larger the parameter, the later the surround sound source begins.
 When a non-Dolby Digital program is decoded: the larger the parameter, the later the surround sound field begins.
 No surround sound source is produced.

Dolby Digital or DTS Input

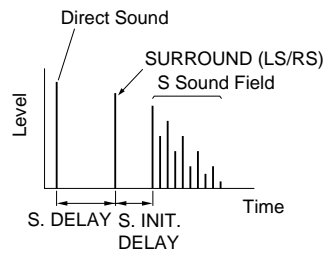

Others

The surround sound field is not reproduced.

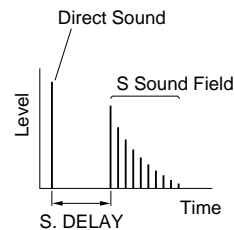

ROOM SIZE

Function This parameter adjusts the apparent size of the surround sound field. The larger the value, the larger the surround sound field becomes.
 Control Range 0.1 - 2.0
 Description As the sound is repeatedly reflected around a room, the larger the hall is, the longer the time between the original reflected sound and the subsequent reflections. By controlling the time between the reflected sounds, you can change the apparent size of the virtual venue. Changing this parameter from one to two, doubles the apparent length of the room.

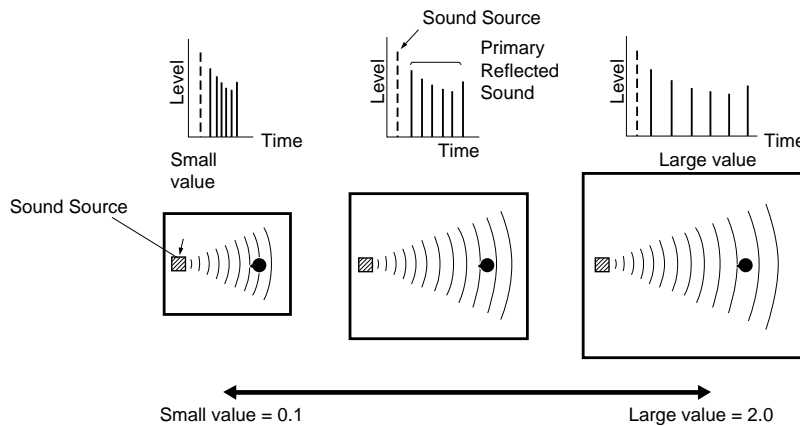

RC. ROOM SIZE (Rear Center Room Size)

Function This parameter adjusts the apparent size of the rear center sound field.
 Control Range 0.1 - 2.0
 Description The larger the value, the more reflective the presence sound field walls become.

S. ROOM SIZE (Surround Room Size)

Function This parameter adjusts the apparent size of the surround sound field.
 Control Range 0.1 - 2.0
 Description The larger the value, the larger the surround sound field becomes.

LIVENESS

Function This parameter adjusts the reflectivity of the virtual walls in the hall by changing the rate at which the early reflections decay.
 Control Range 0 - 10
 Description The early reflections of a sound source decay much faster in a room with acoustically absorbent wall surfaces than in one which has highly reflective surfaces. A room with acoustically absorbent surfaces is referred to as “dead,” while a room with highly reflective surfaces is referred to as “live.” The LIVENESS parameter lets you adjust the early reflection decay rate, and thus the “liveness” of the room.

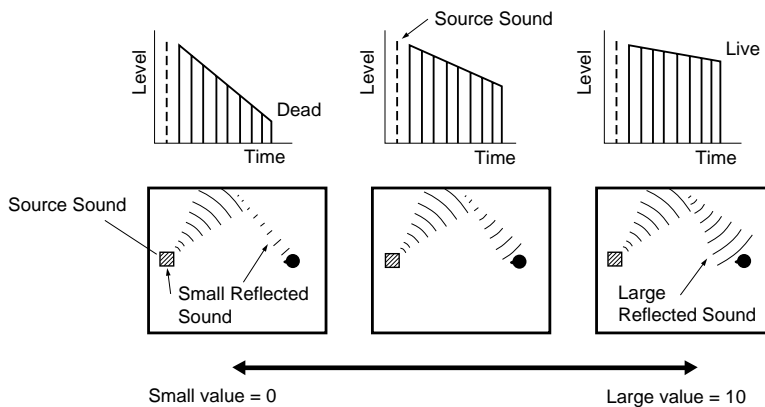

S. LIVENESS (Surround Liveness)

Function This parameter adjusts the apparent reflectivity of the virtual walls in the surround sound field.
 Control Range 0 - 10
 Description The larger the value, the more reflective the surround sound field walls become.

RC. LIVENESS (Rear Center Liveness)

Function This parameter adjusts the apparent reflectivity of the virtual wall in the rear center sound field.
 Control Range 0 - 10
 Description The larger the value, the more reflective the surround sound field walls become.

REV. TIME (Reverberation Time)

Function This parameter adjusts the amount of time it takes for the dense, subsequent reverberation sound to decay by 60 dB (at 1 kHz). This changes the apparent size of the acoustic environment over an extremely wide range.

Control Range 1.0 - 5.0 seconds

Description Set a longer reverberation time for “dead” sources and listening room environments and a shorter time for “live” sources and listening room environments.

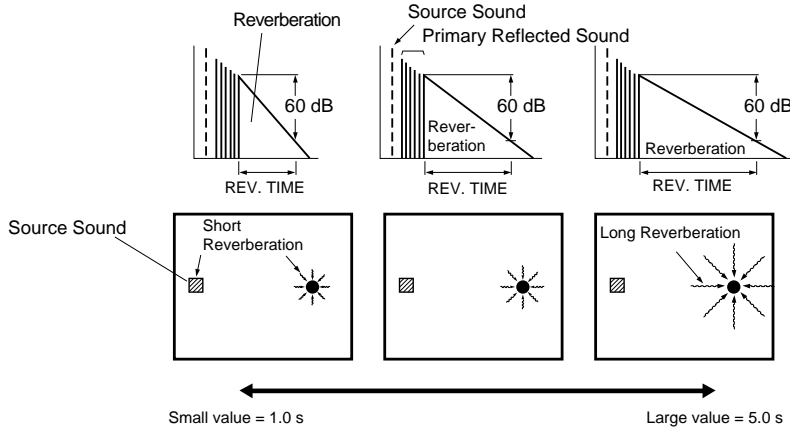

REV. DELAY (Reverberation Delay)

Function This parameter adjusts the time difference between the beginning of the direct sound and the beginning of the reverberation sound.

Control Range 0 - 250 milliseconds

Description The larger the value, the later the reverberation sound begins. A later reverberation sound makes you feel like you are in a larger acoustic environment.

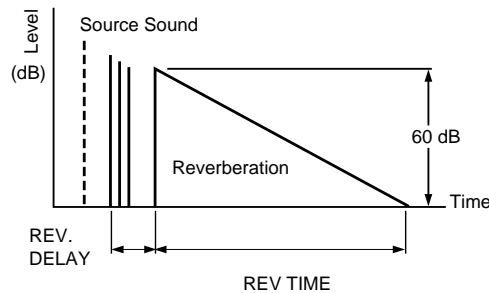

REV. LEVEL (Reverberation Level)

Function This parameter adjusts the volume of the reverberation sound.

Control Range 0 - 100%

Description The larger the value, the stronger the reverberation becomes.

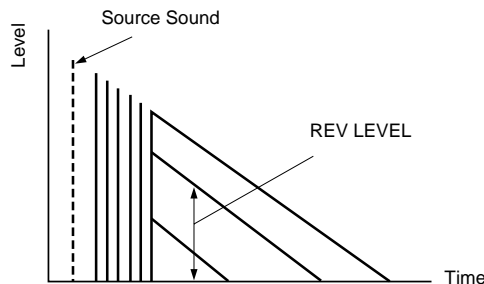

Appendix

Troubleshooting 83

Reference Chart for the INPUT and OUTPUT Jacks 87

CINEMA - EQ Frequency Characteristics 87

Specifications 88

Refer to the chart below when the RX-V1 does not function properly. If the problem you are experiencing is not listed below or if the instruction below does not help, turn the power off, disconnect the power cord, and contact your dealer or the nearest Yamaha Audio Products Service Department.

After this unit is exposed to strong external electric shock (such as lightning and large static electricity) or you mishandle the operation of this unit, it may not function properly. In these cases, turn the power off, unplug the power cord, plug it back in after 30 seconds, and start operating.

General

Problem	Possible Cause	What to Do
The unit fails to turn on when STANDBY/ON is pressed, or returns to standby mode suddenly soon after the power is turned on.	The power cord is not plugged in or is not completely inserted.	Plug in the power cord securely (see page 24).
	IMPEDANCE SELECTOR on the rear panel is not set correctly.	Set the switch completely to either position (depending on your speakers) while this unit is in standby mode (see page 22).
	The protection circuitry has been activated.	Make sure all speaker wire connections on this unit and on all speakers are secure and that the wire for each connection does not touch anything other than its respective connection.
Hum	There is a faulty cable connection.	Connect the audio plugs securely. If the problem persists, the cords may be defective.
	No connection from the turntable to the GND terminal.	Connect the grounding cord of your turntable to the GND terminal of this unit (see page 16).
No Sound or no picture	The volume is turned down.	Turn up the volume.
	Faulty or incorrect input or output connection.	Connect the equipment correctly. If the problem persists, the cords may be defective.
	Incorrect input source.	Select the appropriate input source with INPUT SELECTOR .
	This unit is set to DTS input mode.	Press INPUT MODE to select another input mode
	Digital signals other than PCM audio, Dolby Digital, or DTS encoded signals are input to this unit by playing a CD-ROM, etc.	Play a source whose signals this unit can reproduce.
No picture	The source equipment is connected to this unit using an S-video cable, but there is no S-video connection between this unit and your video monitor.	Connect this unit's S VIDEO MONITOR OUT terminal to the TV's S-video input terminal or disconnect the S-video cable from the source equipment.
No sound is coming from one side.	There is a faulty cable connection.	Connect all cables securely. If the problem persists, the cords may be defective.
	BALANCE is turned all the way to one side.	Adjust BALANCE .
The volume level cannot be increased very much when adjusting VOLUME .	MUTE is on.	Turn VOLUME to minimum, press MUTE to restore audio, and adjust the volume again.
	The equipment connected to the TAPE/MD OUT jacks of this unit is turned off.	Turn on the power to the equipment.
The sound suddenly goes off.	The protection circuitry has been activated because of short circuit etc.	Reset the protection circuitry by turning the unit off and on.
	The SLEEP timer came on.	Cancel the SLEEP timer function.

Troubleshooting

Problem	Possible Cause	What to Do
No sound is coming from the Effect speakers.	The effect is off.	Press EFFECT to turn on the effect sound.
	A Dolby Surround or DTS decoding sound field program is being used with material not encoded with Dolby Surround or DTS.	Select another sound field program.
No sound is coming from the Front Effect speakers.	PRO LOGIC/Normal, DOLBY DIGITAL/Normal or DTS DIGITAL SUR./Normal of DSP program 12 is selected.	Select another sound field program.
	The front level is turned to minimum.	Adjust the Front Effect speaker level (see page 67).
	The 1F. FRNT EFCT item in the SET MENU is set to "NONE".	Select "YES" (see page 45).
No sound is coming from the Center speaker.	The 1A. CENTER SP item in the SET MENU is set to "NONE".	Select the appropriate mode for your Center speaker (see page 43).
	One of the Hi-Fi DSP sound field programs (1 to 6) is selected.	Select another sound field program.
	The input signals of a source encoded with Dolby Digital or DTS do not include center channel signals.	Refer to the instructions for the source currently playing.
No sound is coming from the Rear Effect speakers.	The right and left Rear speaker levels are set to minimum.	Increase the right and left Rear speaker levels (see page 67).
	A monaural source is played with sound field program 12.	Select another sound field program.
No sound is coming from the Subwoofer.	The 1E. LFE/BASS OUT item in the SET MENU is set to "MAIN" when a Dolby Digital or DTS encoded software is played.	Select "SW" or "BOTH" (see page 44).
	The 1E. LFE/BASS OUT item in the SET MENU is set to "SW" or "MAIN" when a 2-channel encoded software is played.	Select "BOTH" (see page 44).
Poor bass reproduction.	The 1E. LFE/BASS OUT item in the SET MENU is set to "SW" or "BOTH" and your system does not include a subwoofer.	Select "MAIN" (see page 44).
	The output mode selection for each channel (MAIN, CENTER or REAR) in the SET MENU does not match your speaker configuration.	Select the appropriate output mode for each channel based on the size of the speakers in your configuration (see pages 43 through 44).
The volume level cannot be increased, or sound is distorted.	The power to the equipment connected to the REC OUT jacks of this unit is off.	Turn on the power to the equipment.
DSP parameters and some other settings on this unit cannot be changed.	The 13. MEMORY GUARD item in the SET MENU is set to "ON".	Select "OFF" (see page 52).
This unit does not operate properly.	The internal microcomputer has been frozen by an external electric shock (such as lightning or excessive static electricity) or by a power supply with low voltage.	Disconnect the AC power cord from the outlet, then plug it in again after about one minute.

Problem	Possible Cause	What to Do
A source cannot be recorded by a tape deck or VCR connected to this unit.	The source unit is connected to this unit using digital jacks only.	Make additional connections to the analog jacks (see pages 16 through 19).
CHECK SP WIRES!" appears on the display.	Speaker cables are short circuited.	Make sure all speaker cables are connected correctly.
There is noise from a nearby TV or tuner.	This unit is too close to the affected equipment.	Move this unit farther away from the affected equipment.
The sound is degraded when listening with the headphones connected to the CD player or cassette deck that are connected to this unit.	The power to this unit is off.	Turn on the power to this unit.
"INPUT DATA ERROR" appears on the display and no sound is heard.	A non-standard source is played back, or the equipment playing back the source is not operating correctly.	Check the source, or turn off the source equipment, then turn it on again.

Tuner

Problem	Possible Cause	What to Do
FM	FM stereo reception is noisy.	Because of the characteristics of FM stereo broadcasts, this is limited to cases where the transmitter is too far away or the antenna input is poor. Check the antenna connections. Try using a high quality directional FM antenna. Set TUNING MODE to the manual tuning mode.
	There is distortion and clear reception cannot be obtained even with a good FM antenna.	There is multipath interference. Adjust the antenna orientation to eliminate multipath interference.
	A desired station cannot be tuned in with the automatic tuning method.	The station is too weak. Use the manual tuning method. Use a high quality directional FM antenna.
	Previously preset stations can no longer be tuned in using preset tuning.	This unit has been unplugged for a long period. Repeat the presetting procedure (see page 36).
AM	A desired station cannot be tuned in with the automatic tuning method.	Weak signal or loose antenna connections. Tighten the AM loop antenna connections and adjust the antenna's orientation for best reception. Use the manual tuning method.
	There are continuous crackling and hissing noises.	Noises result from lightning, fluorescent lamps, motors, thermostats and other electrical equipment. Use an outdoor antenna and a ground wire. This will help somewhat but it is difficult to eliminate all the noises.
	There are buzzing and whining noises (especially in the evening).	A television set is being used nearby. Relocate this unit away from the TV.

Remote Control

Problem	Possible Cause	What to Do
The remote control does not work.	The batteries are dead.	Replace the batteries with new ones and press RESET (see page 5).
	The internal microcomputer has "frozen".	Press RESET on the remote control (see page 5).
The remote control does not function properly.	Wrong distance or angle.	The remote control will function within a maximum range of 6 m (20 feet), no more than 30 degrees off-axis from the front panel (see page 5).
	Direct sunlight or lighting (such as an inverter type of fluorescent lamp) is striking the remote control sensor of this unit.	Change the position of this unit.
	The internal microcomputer has "frozen".	Press RESET on the remote control (see page 5).
The remote control does not "learn" new functions. (The TRANSMIT indicator does not light up or flash.)	The batteries of this remote control and/or the other remote control are too weak.	Replace the batteries (and press RESET on the remote control) (see page 5).
	The distance between the two remote controls is too far or near.	Place the remote controls at the proper distance (see page 62).
	The signal coding or modulation of the other remote control is not compatible with this remote control.	Learning is not possible.
	Memory capacity is full.	Further learning is not possible without deleting unnecessary new functions (see page 66).
	The internal microcomputer has "frozen".	Press RESET on the remote control (see page 5).
Continuous functions such as volume are learned, but operate only for a moment before stopping.	The learning process is incomplete.	Be sure to press and hold the function button on the other remote control until TRANSMIT begins flashing slowly.

Reference Chart for the INPUT and OUTPUT Jacks

SIGNAL	AUDIO						VIDEO					
	ANALOG		DIGITAL				COMPOSITE		S-VIDEO		COMPONENT	
	IN	OUT	COAXIAL		OPTICAL		IN	OUT	IN	OUT	IN	OUT
IN			OUT	IN	OUT							
PHONO	○											
CD	○											
TUNER												
TAPE	○	○										
MD	○	○										
DVD	○											
LD	○											
D-TV	○											
CBL/SAT	○											
VCR 1, 2, 3	○	○										
V-AUX	○											
6 CH INPUT	○											
SUBWOOFER		○ ⁺³										
ZONE 2 OUT		○										
MONITOR OUT												
SPEAKER OUT		○ ⁺⁴										
HEADPHONES		○										

*1 This input can be changed to another video input by using the SET MENU. *2 Only for VCR 1
 *3 SPLIT L,R, and MONO outputs *4 MAIN L,R, CENTER, FRONT L,R, REAR L,R, and REAR CENTER total 8 channels

CINEMA - EQ Frequency Characteristics

Cinema EQ is a digital equalizer that lets you independently adjust the sound quality of each speaker.

■ **HIGH (High Shelving Filter):** Adjusts high frequency response smoothly. There are 16 responses affecting frequencies in the 1 to 12.7 kHz range, while gain is adjusted between +6 and -9 dB.

■ **PEQ (Parametric Equalizer):** Allows smooth boost and cut at an arbitrary frequency range. The center frequency can be in the 1 to 12.7 kHz range, with gain between +6 and -9 dB.

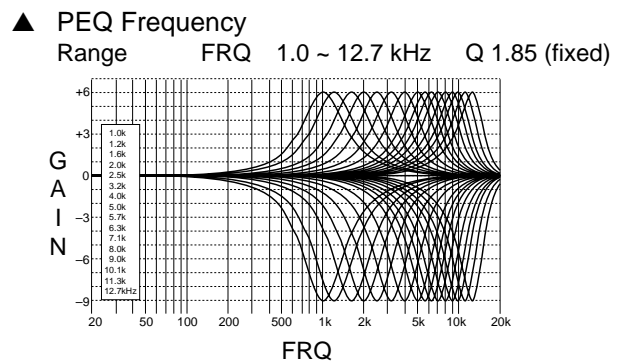
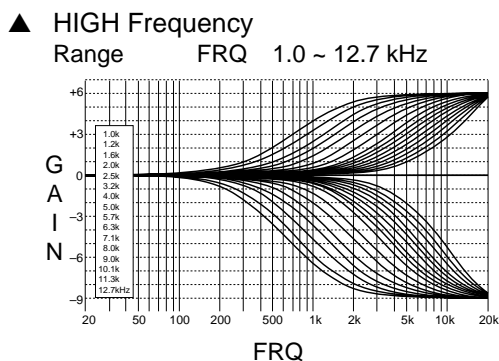
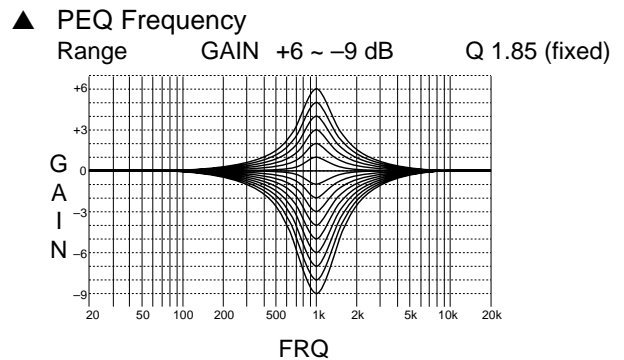
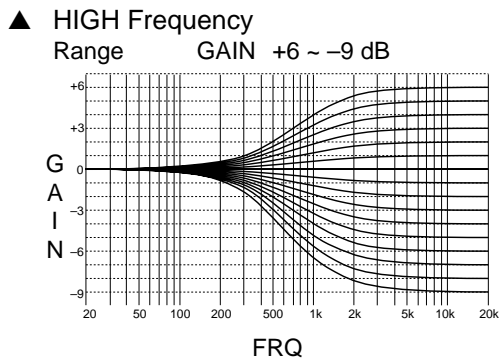

Audio Section

Minimum RMS Output Power per Channel	
MAIN L/R, CENTER, REAR L/R/C	
(20 Hz to 20 kHz, 0.015% THD, 8 ohms)	110 W
FRONT L/R (1 kHz, 0.05% THD, 8 ohms)	35 W
Dynamic Power (IHF)	
MAIN L/R (8/6/4/2 ohms)	150/180/240/340 W
Dynamic Headroom	
MAIN L/R (8 ohms)	1.3 dB
Power Band Width	
MAIN L/R (55 W, 0.04% THD, 8 ohms)	
-----	10 Hz to 50 kHz
Damping Factor	
MAIN L/R (20 Hz to 20 kHz, 8 ohms)	200 or more
Input Sensitivity/Impedance (110 W/8 ohms)	
CD, etc.	150 mV/47k-ohms
PHONO MM	2.5 mV/47k-ohms
MAIN IN	1 V/47k-ohms
Output Level/Impedance	
REC OUT	150 mV/600 ohms
MAIN OUT	1 V/1.2 k-ohms
SUBWOOFER [SPLIT L/R]	2 V/1.2 k-ohms
[MONO]	4 V/1.2 k-ohms
PHONES Output	150 mV/100 ohms
Frequency Response (10 Hz to 100 kHz)	
CD, etc. to MAIN L/R SP. OUT	-3 dB
Total Harmonic Distortion (20 Hz to 20 kHz)	
CD, etc. to MAIN OUT (1 V)	0.005% or less
MAIN IN to SP OUT (55 W/8 ohms)	0.005% or less
Signal to Noise Ratio (IHF-A network)	
(Input shorted, EFFECT off)	96 dB or more
Residual Noise (IHF-A network)	
MAIN L/R SP. OUT	150 μ V or less
Channel Separation (Vol -30 dB, 5.1 k-ohms terminated)	
1 kHz/10 kHz	70 dB/60 dB or more
Tone Control (MAIN L/R)	
Bass Boost/Cut	\pm 10 dB (50 Hz)
Treble Boost/Cut	\pm 10 dB (20 kHz)
Bass Extension	+6 dB (60 Hz)

Video Section

Video Signal Type	NTSC
[Australia model]	PAL
Composite Video Signal Level	1 Vp-p/75 ohms
S-Video Signal Level	
Y	1 Vp-p/75 ohms
C	0.286 Vp-p/75 ohms
Component Video Signal Level	
Y	1 Vp-p/75 ohms
PB/CB, PR/CR	0.7 Vp-p/75 ohms
Maximum Input Level	1.5 Vp-p
Signal to Noise Ratio	50 dB or more
Frequency Response	
(MONITOR OUT)	5 Hz to 10 MHz, -3 dB

FM Section

Tuning Range	87.5 to 107.9 MHz
[Australia model]	87.5 to 108.0 MHz
50 dB Quieting Sensitivity (IHF, 75 ohms, 100% mod., 1 kHz)	
Mono	1.6 μ V (15.3 dBf)
Stereo	23 μ V (38.5 dBf)
Usable Sensitivity (75 ohms) [Australia model only]	
DIN, Mono (S/N 26 dB)	0.9 μ V
DIN, Stereo (S/N 46 dB)	28 μ V
Signal-to-Noise Ratio	
(IHF) Mono/Stereo	81 dB/75 dB
[Australia model]	
(DIN Weighted, 40 kHz Dev.) Mono/Stereo	
-----	75 dB/69 dB
Harmonic Distortion (1 kHz)	
Mono/Stereo	0.1/0.2%
Stereo Separation (1 kHz)	48 dB
Frequency Response	
20 Hz to 15 kHz	0 \pm 1 dB

AM Section

Tuning Range	530 to 1,710 kHz
[Australia model]	531 to 1,611 kHz
Usable Sensitivity	300 μ V/m
Signal-to-Noise Ratio	52 dB

General

Power Supply	AC 120 V, 50/60 Hz
[Australia model]	AC 240 V, 50 Hz
Power Consumption	550 W
AC Outlets (Total 120 W maximum)	3 (Switched)
[Australia model] (100 W maximum)	1 (Switched)
Dimensions (W x H x D)	471 x 211 x 473 mm
	(18-1/2" x 8-1/4" x 18-5/8")
Weight	28 kg (61 lbs 11oz)
Accessories	Remote control
	Alkaline batteries
	Quick reference guide
	AM loop antenna
	Indoor FM antenna
	Antenna adapter (Except for Australia model)

*Specifications are subject to change without notice.



YAMAHA ELECTRONICS CORPORATION, USA 6660 ORANGETHORPE AVE., BUENA PARK, CALIF. 90620, U.S.A.
YAMAHA CANADA MUSIC LTD. 135 MILNER AVE., SCARBOROUGH, ONTARIO M1S 3R1, CANADA
YAMAHA ELECTRONIK EUROPA G.m.b.H. SIEMENSSTR. 22-34, 25462 RELINGEN BEI HAMBURG, F.R. OF GERMANY
YAMAHA ELECTRONIQUE FRANCE S.A. RUE AMBROISE CROIZAT BP70 CROISSY-BEAUBOURG 77312 MARNE-LA-VALLEE CEDEX02, FRANCE
YAMAHA ELECTRONICS (UK) LTD. YAMAHA HOUSE, 200 RICKMANSWORTH ROAD WATFORD, HERTS WD1 7JS, ENGLAND
YAMAHA SCANDINAVIA A.B. J A WETTERGRENS GATA 1, BOX 30053, 400 43 VÄSTRA FRÖLUNDA, SWEDEN
YAMAHA MUSIC AUSTRALIA PTY, LTD. 17-33 MARKET ST., SOUTH MELBOURNE, 3205 VIC., AUSTRALIA

YAMAHA CORPORATION
Printed in Japan **UP** VIDEO V482920-1

Quick Reference Card

Remote Control

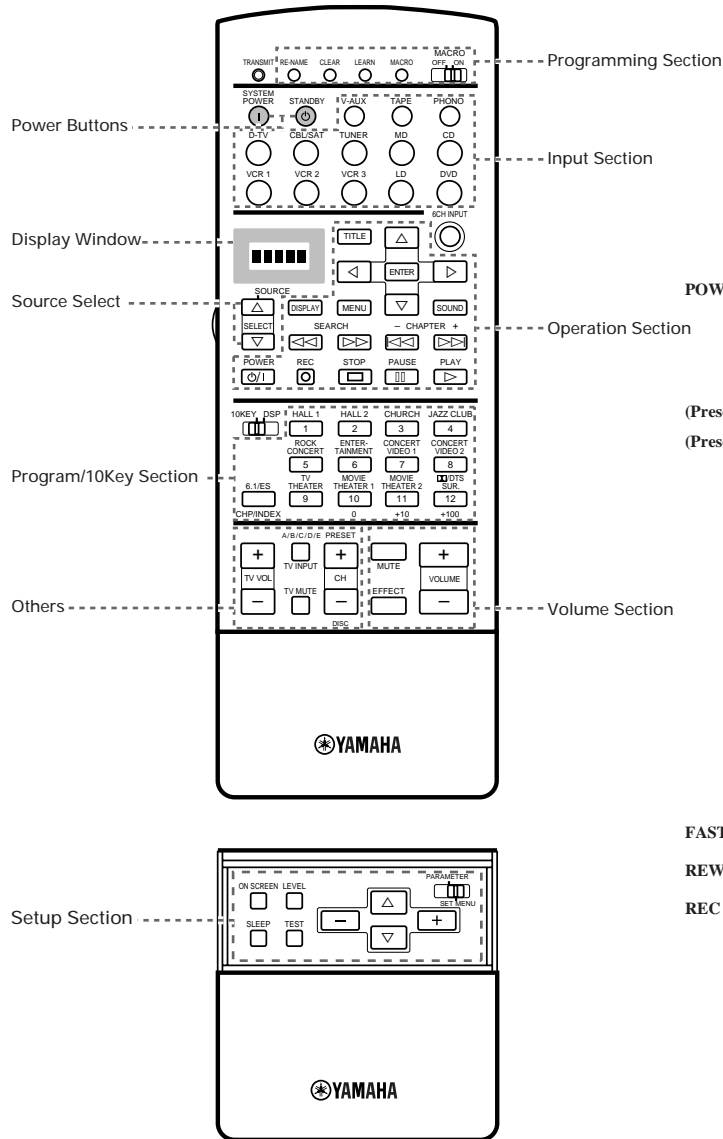

TUNER

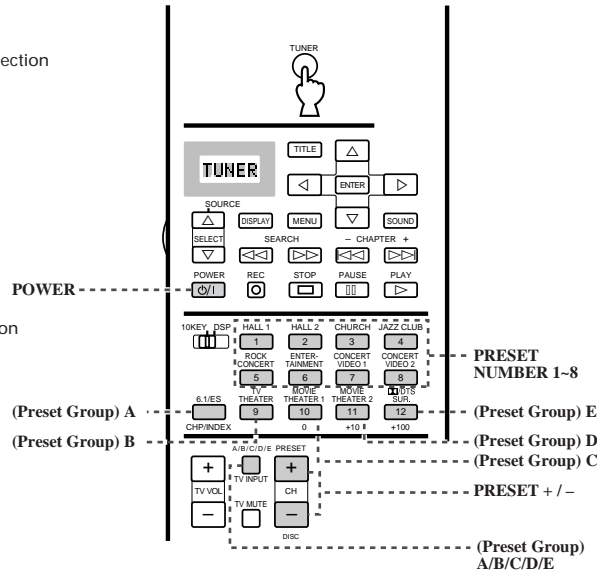

CD

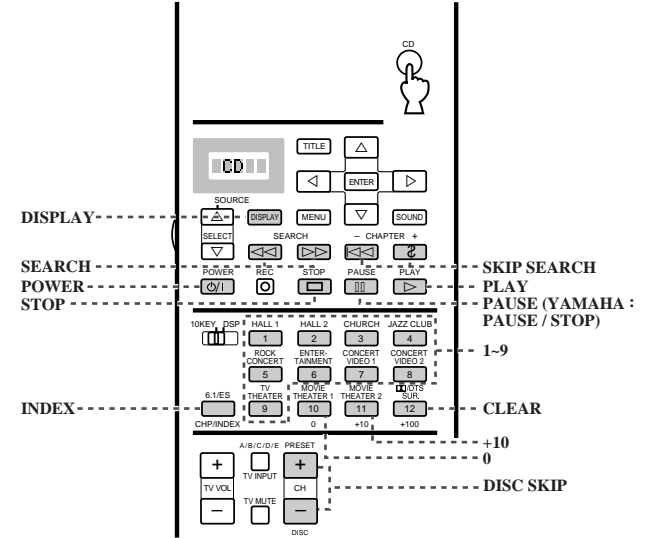

TAPE

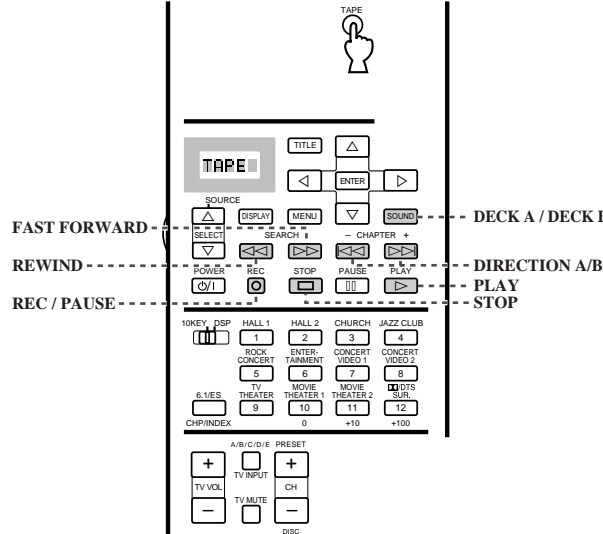

MD

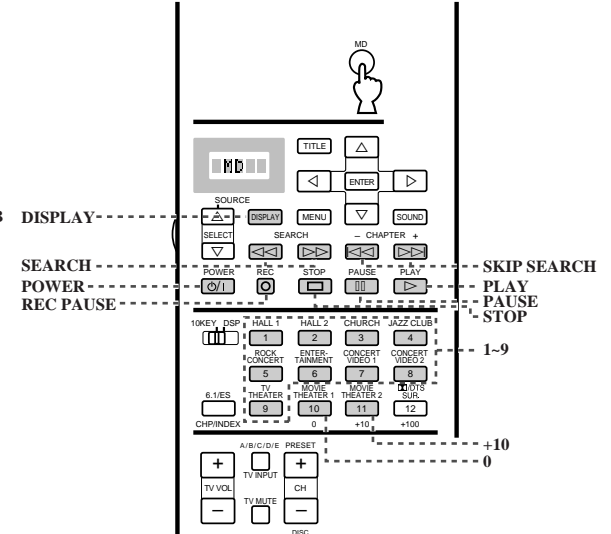

Quick Reference Card

LD

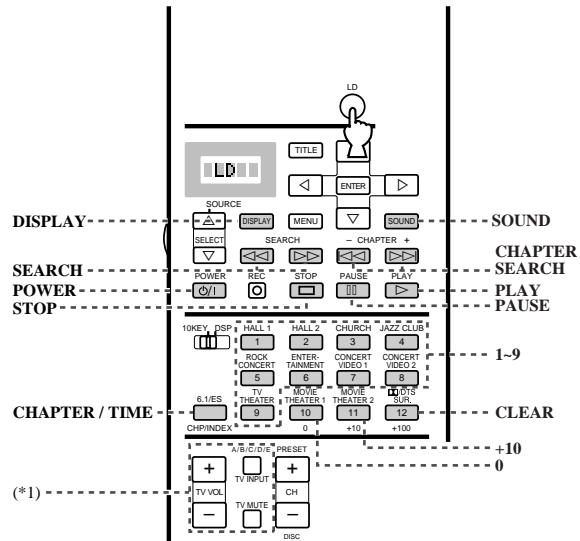

VCR 1/VCR 2/VCR 3

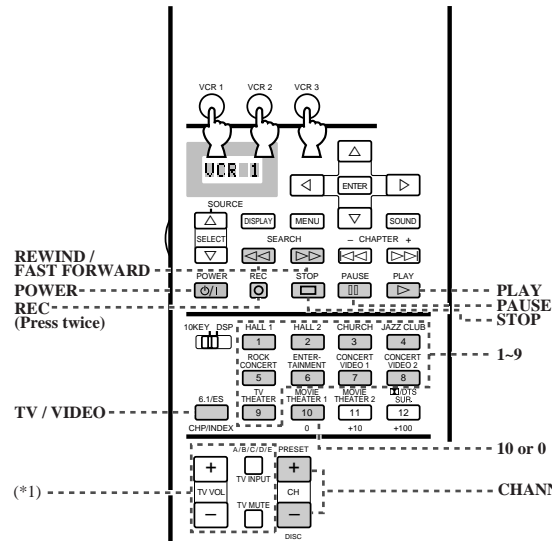

CBSAT

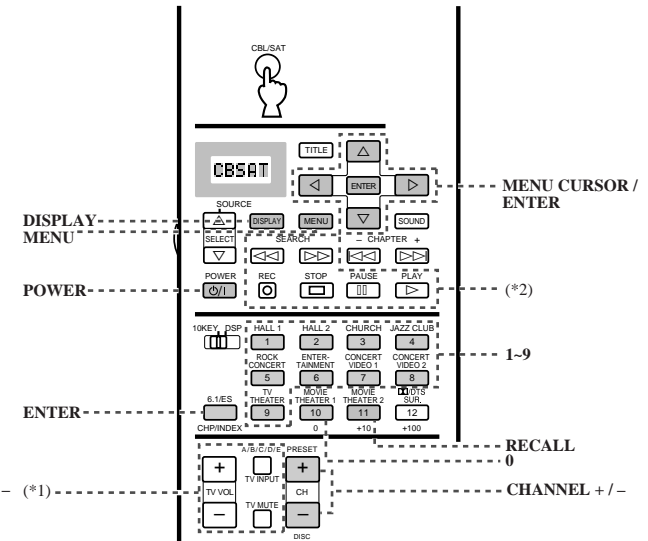

DVD

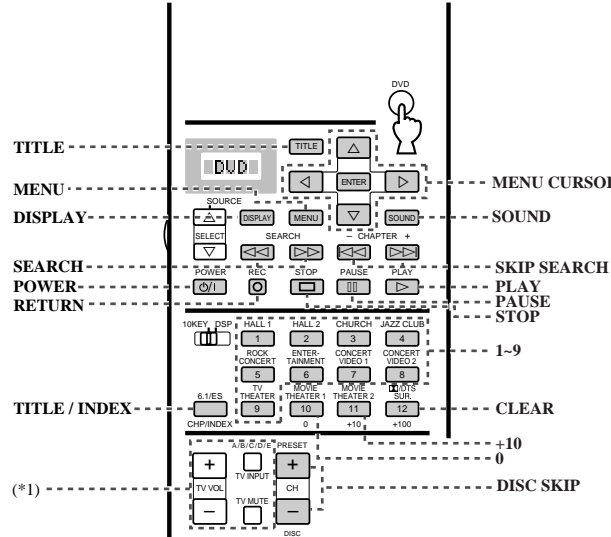

D-TV

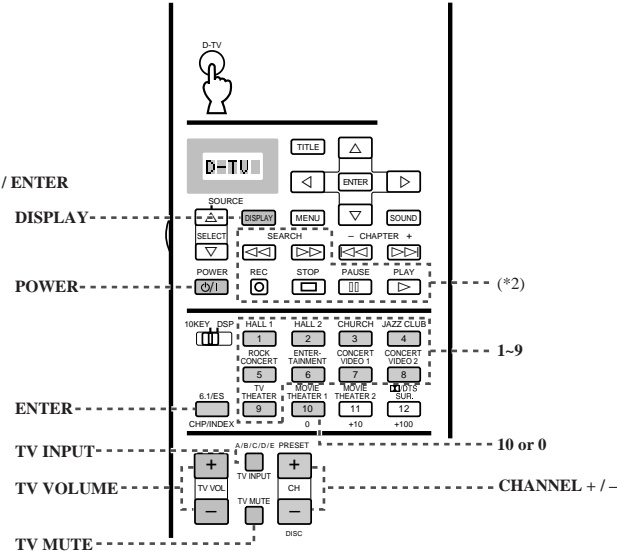

(*1) TV VOL, TV INPUT, TV MUTE function if you have setup the manufacturer code for the D-TV Area.

(*1) TV VOL, TV INPUT, TV MUTE fonctionnent si vous avez réglé le code du fabricant pour la zone D-TV.

(*1) TV VOL, TV INPUT und TV MUTE-Funktion, wenn Sie den Herstellercode für den D-TV-Bereich eingestellt haben.

(*1) TV VOL, TV INPUT och TV MUTE om du har programmerat tillverkarkoden för D-TV-området.

(*1) Funzioni TV VOL, TV INPUT, TV MUTE se avete impostato il codice del fabbricante per l'area D-TV.

(*1) Funciones TV VOL, TV INPUT y TV MUTE si ha preparado el código del fabricante para el área D-TV.

(*1) TV VOL, TV INPUT, TV MUTE functie als u de fabrikantencode voor de D-TV set heeft ingevoerd.

(*1) ƒp"G-z/w, g<D-TV ƒ] 'w Dƒa&&X; A&h-zƒiƒH-ƒƒCR; C

(*2) You can control your VCR if you have setup the code for VCR 1.

(*2) Vous pouvez commander votre magnéscope si vous avez réglé le code pour VCR 1.

(*2) Sie können Ihren Videorecorder steuern, wenn Sie den Code für VCR 1 eingestellt haben.

(*2) Du kan styra videon om du har programmerat tillverkarkoden för VCR 1.

(*2) Se si è impostato il codice per VCR 1, si può controllare il proprio VCR.

(*2) Podrá controlar su videograbadora si ha preparado el código para VCR 1.

(*2) U kunt uw eigen videorecorder bedienen als u de code voor VCR 1 heeft ingevoerd.

(*2) ƒp"G-z/w, g<VCR ƒ] 'w&&X; A&h-zƒiƒH-ƒƒCR; C