

CD-S2100

Compact Disc Player



A Living Tradition in Sound

A piano comes into this world through the perfect synergy of advanced technical skill and artistry. Such a piano can create sound that truly reflects the player's feelings.

The final stage in piano production is called "voicing". It is here that the instrument is given its soul.

A highly skilled expert concentrates his mind and sensitivity on the sound of each key, finely adjusting the dynamic feel of the hammers, bringing the tone and vibrancy of all 88 keys together perfectly; a truly stunning achievement.

It is a quality of sound that can only be determined by an astute, sensitive ear. We apply this very same concept to the manufacture of our audio products. The technician performs exhaustive listening tests and every component is considered, in order to finally achieve the ideal sound.

Yamaha's tradition of audio quality stretches back over 125 years, and continues to live on in all Yamaha products today.



Excellence in Audio Achievement

1920-
1960s

First HiFi System introduced in 1920

We introduced numerous HiFi components (turntables, FM/AM tuners, integrated amplifiers, preamplifiers, power amplifiers and speakers) in 1955 - 1965.

Natural Sound Speaker Series introduced in 1967

NS-20 Monitor Speaker



NS-20



CA-1000

1970s

CA-1000 Integrated Amplifier

Featuring A-Class operation, the CA-1000 set the standard for integrated amplifiers.

NS-690 Natural Sound Speaker



NS-690



NS-1000M

NS-1000M Monitor Speaker

A truly legendary speaker still revered by HiFi enthusiasts.

B-1 Power Amplifier

An innovative power amp that used vertical FETs in all stages.

C-2 Control Amplifier

Received top prize at the Milan International Music and HiFi Show.

NS-10M Studio Monitor Speaker

Became of the most popular studio monitors in the world.

A-1 Integrated Amplifier

PX-2 Turntable

Yamaha's first straight arm turntable.



B-1



C-2



PX-2



NS-10M



A-1

1980s

B-6 Power Amplifier

Pyramid-shaped power amplifier.

GT-2000/L Turntable

First CD Player (CD-1) introduced in 1983

B-2x Power Amplifier

MX-10000 Power Amplifier and CX-10000 Control Amplifier

Redefined the capabilities of separate components.

AX-1 Integrated Amplifier

B-6



B-2x



MX-10000



CX-10000



NP-S2000

1990s

GT-CD1 CD Player

MX-1 Power Amplifier and CX-1 Preamplifier

2000s

Soavo-1 and Soavo-2 Natural Sound Speaker Systems

A-S2000 Integrated Amplifier and CD-S2000 CD Player

2010s

NP-S2000 Network Player

A-S3000 Integrated Amplifier and CD-S3000 CD Player



Soavo-1



A-S3000



CD-S3000

CD-S2100

- ◆ *Full-stage balanced signal transmission beginning with the DAC achieves the ultimate in CD reproduction*
- ◆ *Independent power supplies with digital and analog completely separated*
- ◆ *Exclusive Yamaha loading mechanism and high precision CD drive*
- ◆ *Left-right symmetrical design with rigid, stable construction*
- ◆ *Pure Direct*
- ◆ *Super sound from Super Audio CDs*
- ◆ *Heavy feet with newly-developed antivibration spikes*
- ◆ *DSD playback via 192 kHz, 24-bit USB DAC*

■ Supplied accessories

Please check that you have received all of the following parts.

- Power cable
- Remote control
- Batteries (AAA, R03, UM-4) (×2)
- Stereo pin cable
- SAFETY BROCHURE

Contents

Controls and functions.....	6
Connections.....	18
Playback of music files stored on a PC.....	22
Specifications	26
Playable disc format.....	27
Troubleshooting.....	29

■ About this manual

- ✨ indicates a tip for your operation.
- Photographs and illustrations are for explanatory purposes, and may differ from the actual unit.
- Read the “SAFETY BROCHURE” before using this unit.

Controls and functions

In this chapter, you will learn the controls and functions of CD-S2100.



Controls and functions

■ Front panel (pages 6 to 9)

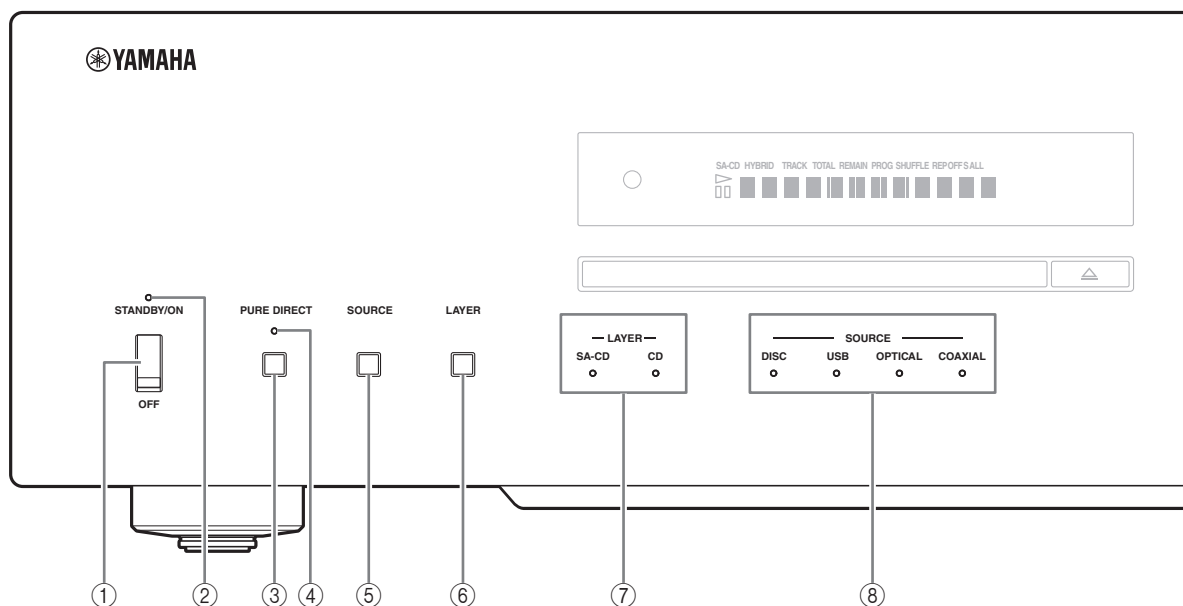

① STANDBY/ON, OFF switch

Turns on or off this unit.

STANDBY/ON (upper position): In this position, you can select STANDBY or ON, using the  CD key on the remote control.

OFF (lower position): The power of this unit is turned off.

Notes

- When you turn on this unit, it will take a few seconds before this unit can reproduce sound.
- If this unit is not operated for 30 minutes with no audio signal detected, it goes to STANDBY mode (page 14).
- If you disconnect the power cable from the AC outlet and connect it again when this unit is in STANDBY mode, the power of the unit is turned on (page 20). If the unit is not to be operated for a long time, set the STANDBY/ON, OFF switch to OFF.

② STANDBY/ON indicator

Lit brightly: Shows that the power of the unit is ON.

In this condition, you can switch the unit to STANDBY mode by pressing the  CD key on the remote control.

Lit dimly: Shows that the unit is in STANDBY mode.

In this condition, you can switch the unit on by pressing the  CD key on the remote control.

Off: Shows that the power of the unit is OFF. In this condition, you can turn the power on only by pressing the STANDBY/ON, OFF switch on the front panel.

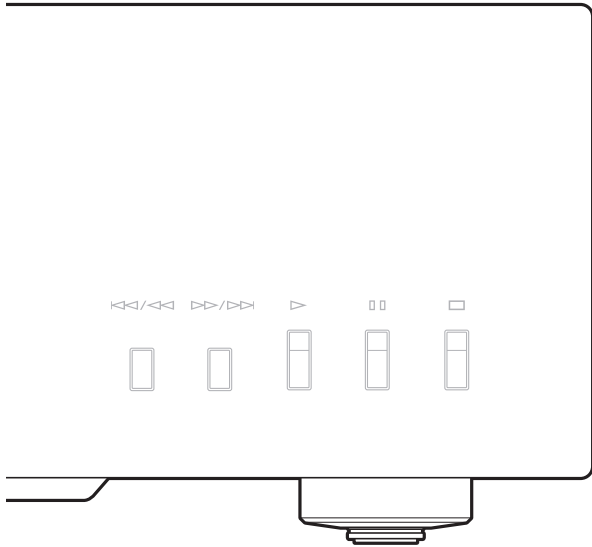

③ **PURE DIRECT key**

Allows you to enjoy high audio quality.



- Press this key again to turn off the PURE DIRECT mode.
- This setting is retained even if you turn off this unit.

Notes

When PURE DIRECT is on:

- The audio signals are output only from the BALANCED OUT jacks and the ANALOG OUT jacks.
- The front panel display will show only the minimum indicators and messages.

④ **PURE DIRECT indicator**

Lights when the PURE DIRECT mode is turned on.

⑤ **SOURCE key**

Selects the audio source to be played back. Each time you press this key, the audio source is switched.

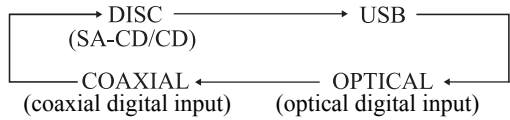

The audio source setting is retained even if you turn off this unit.

⑥ **LAYER key**

Switches the playback layer of a hybrid Super Audio CD between SA-CD and CD while playback is stopped (page 27).



This setting is retained even if you turn off this unit.

Note

When SA-CD layer is selected, audio signals are output only from the BALANCED OUT and ANALOG OUT jacks.

⑦ **LAYER indicators**

The indicator of the layer selected with the LAYER key lights.

⑧ **SOURCE indicators**

The indicator of the audio source selected with the SOURCE key lights.

Controls and functions

■ Front panel (pages 6 to 9)

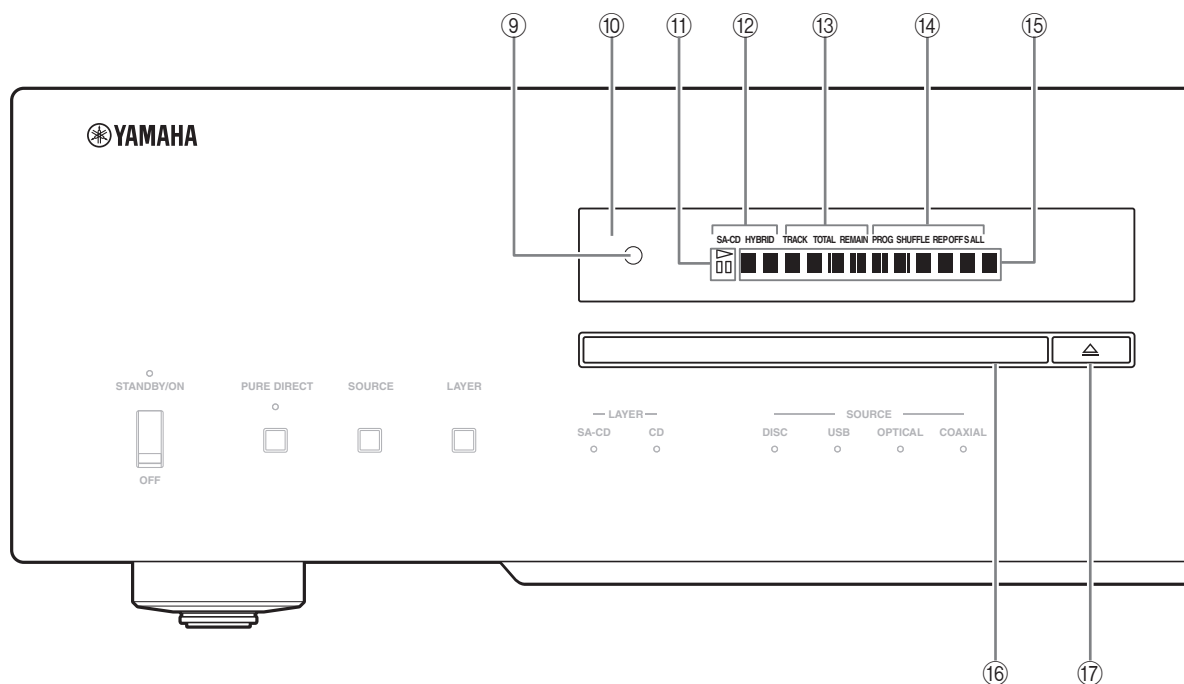

⑨ Remote control sensor

Receives signals from the remote control.

⑩ Display

The brightness can be adjusted with the DIMMER key on the remote control (page 12).

⑪ ▷ (playback) / ◻◻ (pause) indicator

Lights in the playback/pause mode.

⑫ Disc type indicator

Indicates the type (SA-CD/CD/HYBRID) of the disc in the disc tray.

⑬ Time display mode indicator

Indicates the time display mode of the display. Change the mode by pressing the DISPLAY key on the remote control (page 13).

TRACK: Elapsed time of the current track

TRACK REMAIN: Remaining time of the current track

TOTAL REMAIN: Total remaining time of the disc

⑭ Playback mode indicator

Indicates the current playback mode.

PROG: Program playback (page 14)

SHUFFLE: Shuffle playback (page 13)

REP OFF: Repeat playback off (page 12)

REP S : Single repeat playback (page 12)

REP ALL: All repeat playback (page 12)

⑮ Information display

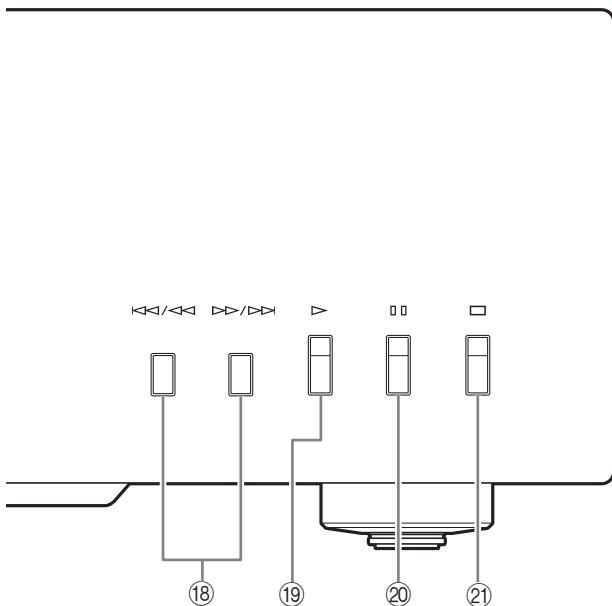

⑮ **Disc tray**

Loads a disc.

⑰ **△ (Open/Close) key**

Opens or closes the disc tray.



The disc tray also closes automatically when you press:

- the ▷ (Play) key on the front panel or on the remote control.
- the front edge of the disc tray gently.
- a numeric button on the remote control.

⑱ **⏮/⏪ (Skip/Search backward) key**

Press the key once to skip back to the beginning of the current track.

Press it twice to skip to the beginning of the previous track.

Press and hold it to search backward.

⏩/⏭ (Skip/Search forward) key

Press the key once to skip to the next track.

Press and hold it to search forward.

⑲ **▷ (Play) key**

Starts playback.

⑳ **⏸ (Pause) key**

Pauses playback. Press the ▷ or ⏸ key to resume playback.

㉑ **⏹ (Stop) key**

Stops playback.

See page 28 for more information on MP3/WMA playback.

Controls and functions

■ Rear panel

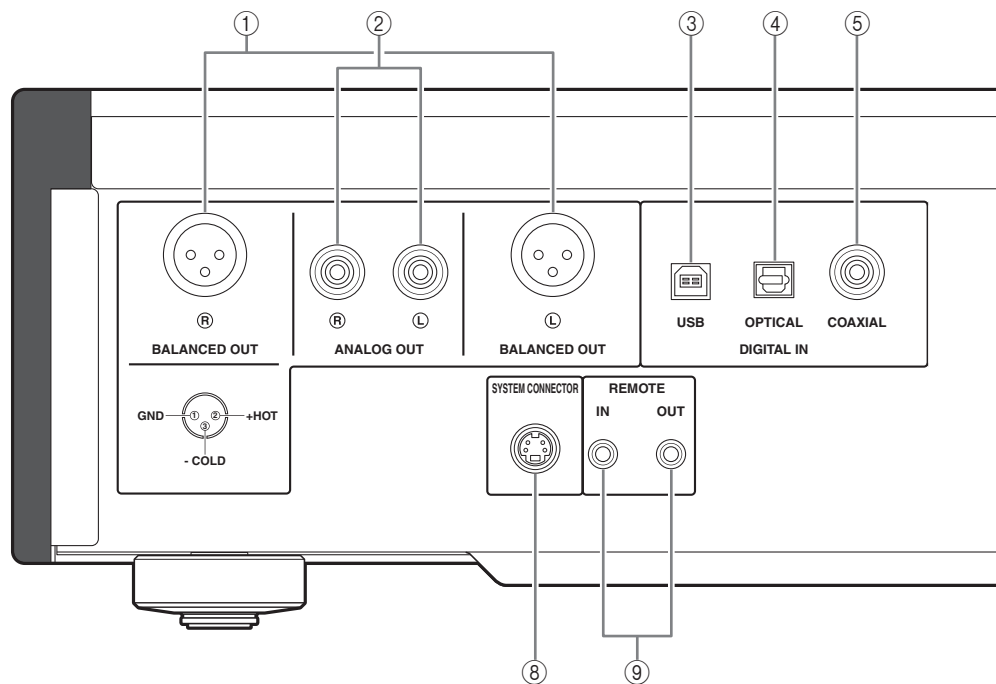

See page 18 for connection information.

- ① **BALANCED OUT jacks (male)**
- ② **ANALOG OUT jacks**
- ③ **DIGITAL IN USB jack (Type B)**
- ④ **DIGITAL IN OPTICAL jack**
- ⑤ **DIGITAL IN COAXIAL jack**
- ⑥ **DIGITAL OUT OPTICAL jack**
- ⑦ **DIGITAL OUT COAXIAL jack**

⑧ **SYSTEM CONNECTOR**

Use this connector to connect a product testing device for servicing.

⑨ **REMOTE IN/OUT jacks**

Use these jacks to connect an external component for remote operation.

For details on the connection, see page 21.

Note

While playing the SA-CD layer, the audio signals are output only from the BALANCED OUT and ANALOG OUT jacks.

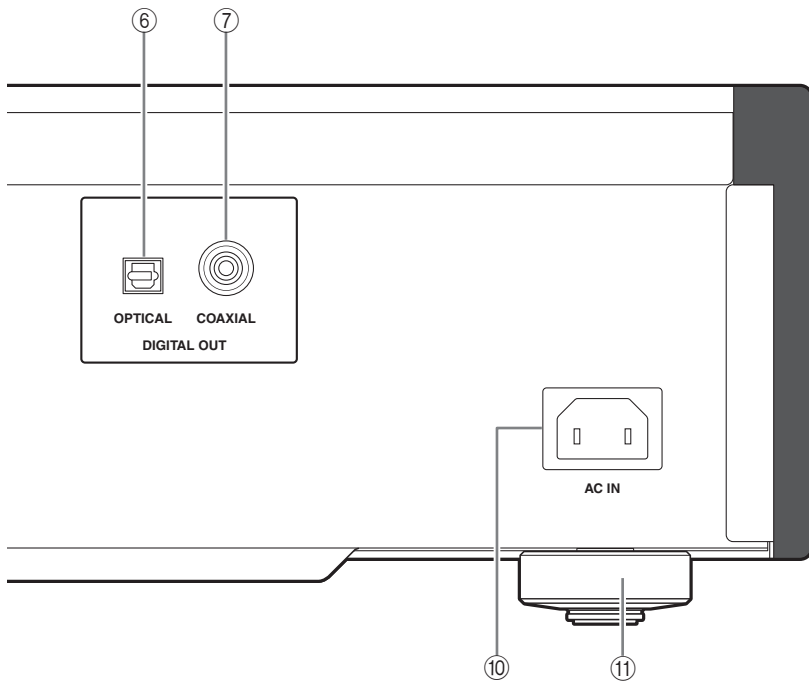

⑩ **AC IN inlet**

Use this inlet to plug in the supplied power cable. See page 20 for connection information.

⑪ **Foot**

The feet of this unit include built-in spikes. Using the spikes can reduce the effect of vibrations on the set. When using the spikes, remove the transport tape, then remove the magnet foot by pulling it.

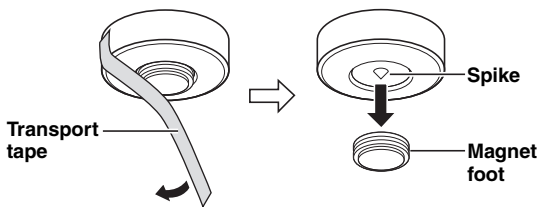

Caution

- Take care that the magnet foot is not accidentally swallowed by small children.
- When using the feet's built-in spikes, the spikes may scratch the shelf or floor on which this unit is installed. Use the magnet feet or appropriate supports when placing this unit on expensive furniture, etc.



If this unit is unstable, you can adjust the foot height by rotating it.

Controls and functions

■ Remote control

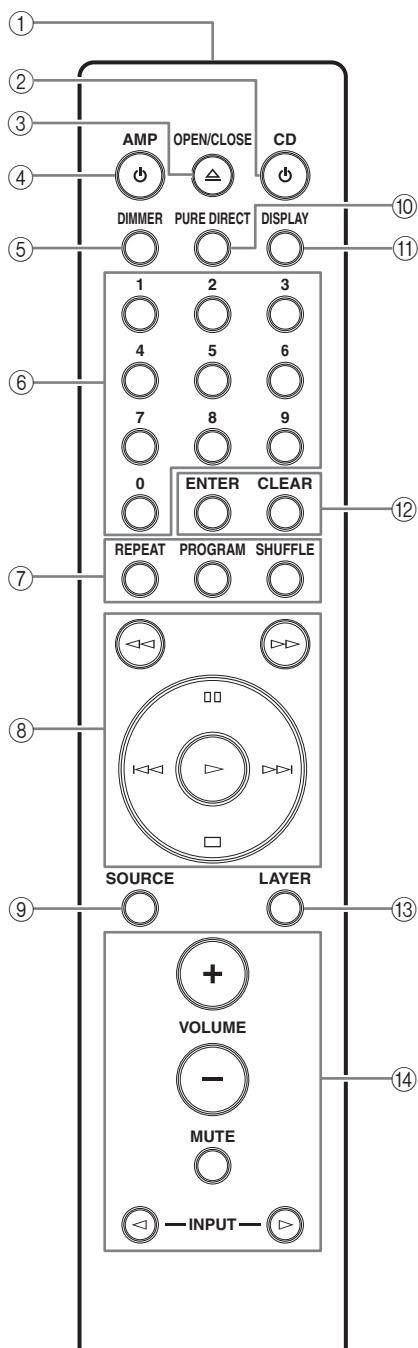

① Infrared signal transmitter

Sends infrared signals to this unit.

② **CD key**

Turns this unit ON or switches it to STANDBY mode. For details on STANDBY, see “Front panel” (page 6).

③ **△ OPEN/CLOSE key**

Opens or closes the disc tray.

④ **⏻ AMP key**

Turns the Yamaha amplifier ON or switches it to STANDBY mode.

Note

Some Yamaha amplifiers cannot be controlled with the **⏻ AMP key** of this remote control.

⑤ **DIMMER key**

Selects the brightness level for the front panel display. Each time you press the DIMMER key, the brightness level changes in the following order:

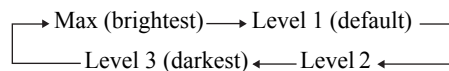

This setting is retained even if you turn off this unit.

⑥ **Numeric buttons**

Use to select a track directly.

Note

This operation is ineffective for MP3 or WMA discs.

⑦ **REPEAT key**

Repeats playback of a single track or all tracks. Each time you press the REPEAT key during playback, the repeat playback mode changes as follows:

REP OFF (repeat playback off):

Repeat playback is cancelled.

REP S (single repeat playback):

On reaching the end of the current track, playback repeats from the beginning of the current track.

REP ALL (all repeat playback):

On reaching the end of the last track, playback repeats from the beginning of the first track.

Note

This operation is ineffective for MP3 or WMA discs.

PROGRAM key

Turns on or off the program playback mode. See “Program playback” (page 14).

SHUFFLE key

Performs shuffle playback.

Notes

- This operation is ineffective for MP3 or WMA discs.
- The shuffle playback mode is cancelled when playback is stopped or the disc is ejected.

⑧ ◀◀ (Search backward) key

▶▶ (Search forward) key

Searches tracks backward/forward.

⏸ (Pause) key

Pauses playback. Press the ▶ or ⏸ key to resume playback.

▶ (Play) key

Starts playback.

⏮ (Skip backward) key

Press the key once to skip back to the beginning of the current track.

Press it twice to skip to the beginning of the previous track.

▶▶ (Skip forward) key

Press the key once to skip to the next track.

⏹ (Stop) key

Stops playback.

⑨ SOURCE key

Selects the audio source to be played back. Each time you press this key, the audio source is switched as shown below.

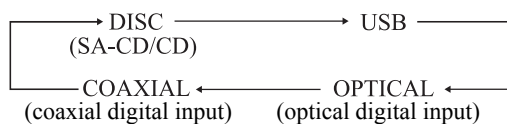

The audio source setting is retained even if you turn off this unit.

⑩ PURE DIRECT key

Allows you to enjoy high audio quality.



- Press this key again to turn off the PURE DIRECT mode.
- This setting is retained even if you turn off this unit.

Notes

When PURE DIRECT is on:

- The audio signals are output only from the BALANCED OUT jacks and the ANALOG OUT jacks.
- The front panel display will show only the minimum indicators and messages.

⑪ DISPLAY key

Switches the time display. Each time you press the DISPLAY key during playback, the time display changes as follows:

TRACK: Elapsed time of the current track

TRACK REMAIN: Remaining time of the current track

TOTAL REMAIN: Total remaining time of the disc

⑫ ENTER key

Confirms a track number entered when you are programming tracks.

CLEAR key

Erases the last programmed track when this unit is in the program editing mode. See “Program playback” (page 14).



To erase all programmed tracks, press the CLEAR key while programmed playback is stopped.

⑬ LAYER key

Switches the playback layer of a hybrid Super Audio CD between SA-CD and CD while playback is stopped (page 27).



This setting is retained even if you turn off this unit.

Note

When SA-CD layer is selected, audio signals are output only from the BALANCED OUT and ANALOG OUT jacks.

⑭ Yamaha amplifier operation keys

Operates the Yamaha amplifier.

Refer to the owner’s manual of your amplifier for details.

Note

Some Yamaha amplifiers cannot be controlled with the keys of this remote control.

See page 28 for more information on MP3/WMA playback.

Controls and functions

■ Program playback

In the program playback mode, you can play back tracks in a programmed sequence.

1 Press PROGRAM while playback is stopped.

This unit is set to the program editing mode.

2 Select a track by using the numeric buttons and press ENTER.

3 Repeat step 2 to program the next track.

You can program up to 24 tracks.

4 Press the ▷ (Play) key.

Playback starts from the beginning of the programmed sequence.

Notes

- This operation is ineffective for MP3 or WMA discs.
- The programmed tracks are erased in the following cases:
 - when the disc is ejected
 - when this unit is turned off or goes to STANDBY mode
 - when an audio source other than the disc is selected
 - when the playback layer of a hybrid Super Audio CD is switched between SA-CD and CD

■ Setting the AUTO POWER STANDBY function

The AUTO POWER STANDBY function can be set to ON or OFF. When set to ON, if the unit is not operated for 30 minutes with no audio signal detected, it automatically goes to STANDBY mode. When set to OFF, the unit does not go to STANDBY mode automatically.

1 Open the disc tray and remove any currently-loaded disc from the unit.

Skip step 1 to 3 if “NO DISC” appears on the information display.

2 Close the disc tray.

3 Press SOURCE to select “DISC” as the audio source.

“NO DISC” appears on the information display.

4 Press and hold the □ (Stop) key or ▷ (Play) key on the front panel for about 2 seconds to switch the setting.

□ (Stop) key: The AUTO POWER STANDBY function switches to ON, and “AutoSTBY ON” appears on the information display.

▷ (Play) key: The AUTO POWER STANDBY function switches to OFF, and “AutoSTBY OFF” appears on the information display.

Notes

- The default setting for the AUTO POWER STANDBY function is ON.
- This setting is retained even if you turn off this unit.

■ Setting the DPLL (Digital Phased Lock Loop) bandwidth

The audio DAC (ES9016) of this unit employs DPLL to generate accurate clock signals synchronized with the clock of the input digital audio signal. The 7-step DPLL bandwidth setting gives the unit tolerance for fluctuation of the clock of the input digital signal and adjustment of the accuracy of the operating clock in the DAC.

1 Press SOURCE to select the audio source to be played back.

The DPLL bandwidth can be set for each audio source, respectively.

2 Within 5 seconds after selecting the audio source, press ENTER.

The unit enters the setting mode, and the DPLL bandwidth currently set appears on the information display.

3 Select the DPLL bandwidth using the $\square\square$ (pause) key and the \square (stop) key.

Each time the $\square\square$ (pause) key is pressed, the bandwidth changes in the following order. If you press the \square (stop) key, it changes in reverse order.

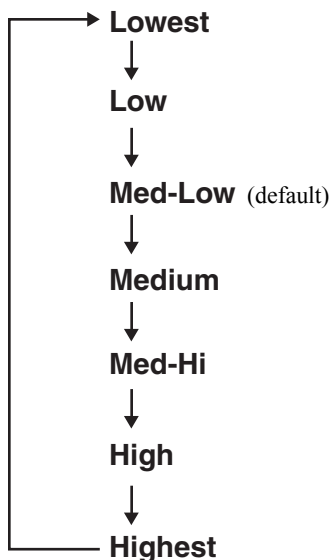

4 Press ENTER.

The setting value flashes for 3 seconds, then the unit resumes to normal mode.

To cancel the setting, press CLEAR.

Notes

- As the DPLL bandwidth setting value approaches “Lowest,” the accuracy of the operating clock in the DAC improves, but the unit may be susceptible to a change in the clock of the external component. The sound from such a component may more easily skips.
- As the DPLL bandwidth setting value approaches “Highest,” the accuracy of the operating clock in the DAC deteriorates, but the unit is far less susceptible to a change in the clock of the external component, and the sound from such a component hardly skips.

Controls and functions

■ Installing batteries in the remote control

- 1 Remove the battery compartment cover.
- 2 Insert the two batteries (AAA, R03, UM-4) according to the polarity markings (+ and -) on the inside of the battery compartment.

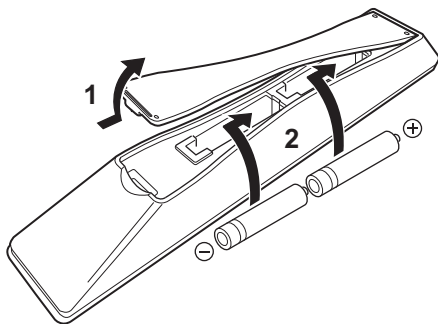

- 3 Reinstall the battery compartment cover.

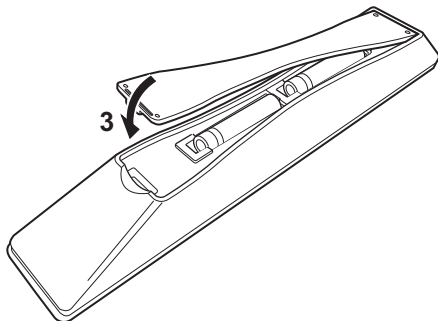

■ Operating range of the remote control

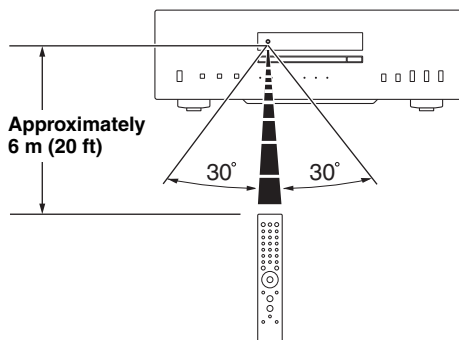

The remote control transmits a directional infrared beam. Be sure to aim the remote control directly at the remote control sensor on the front panel of this unit during operation.

Connections

In this section, you will make connections between CD-S2100 and your amplifier.



Connections

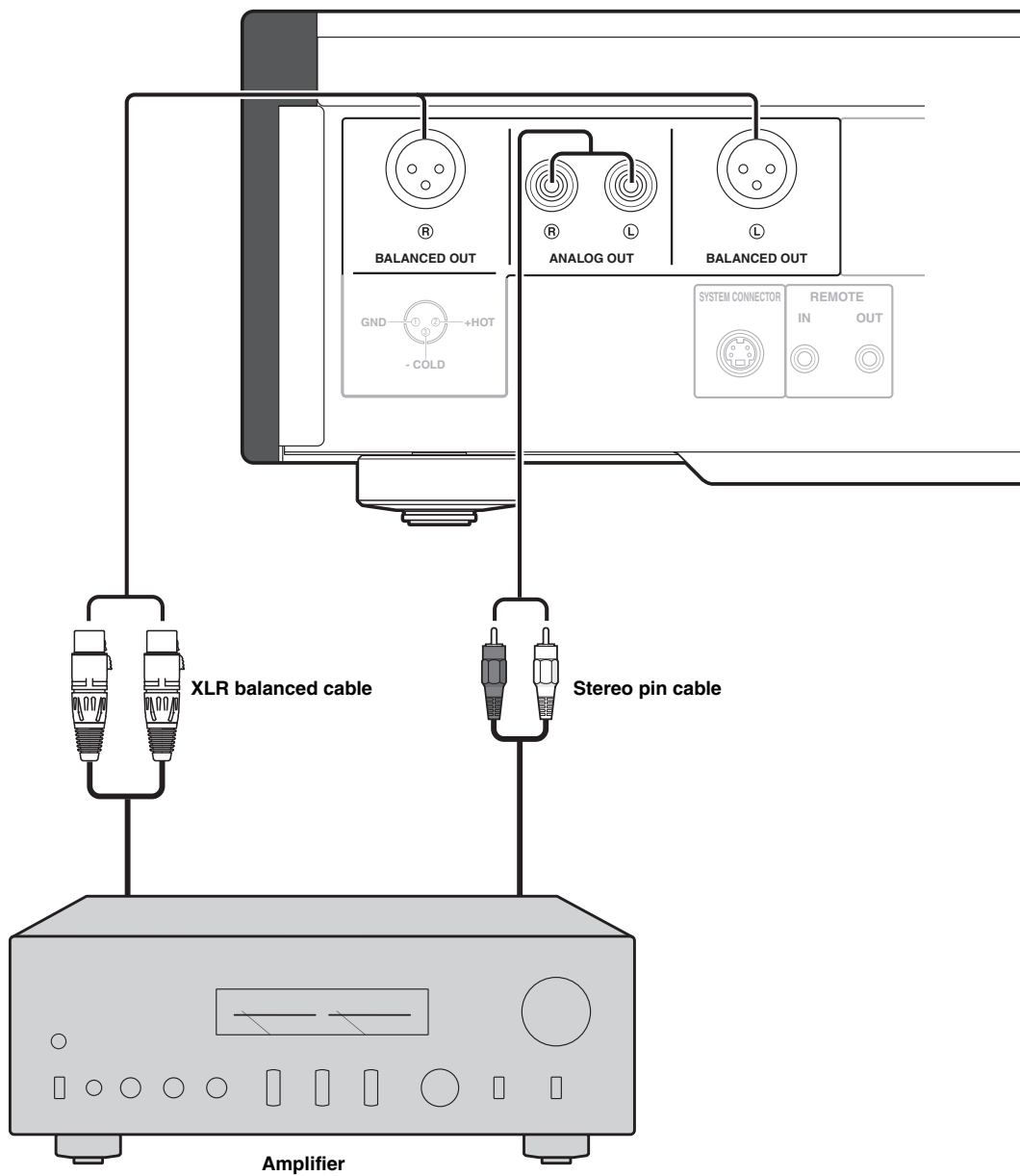

If your amplifier is equipped with XLR balanced input jacks, we recommend balanced connection for optimum audio performance.

When the SA-CD layer is played, the audio signals are output only from the BALANCED OUT and ANALOG OUT jacks.

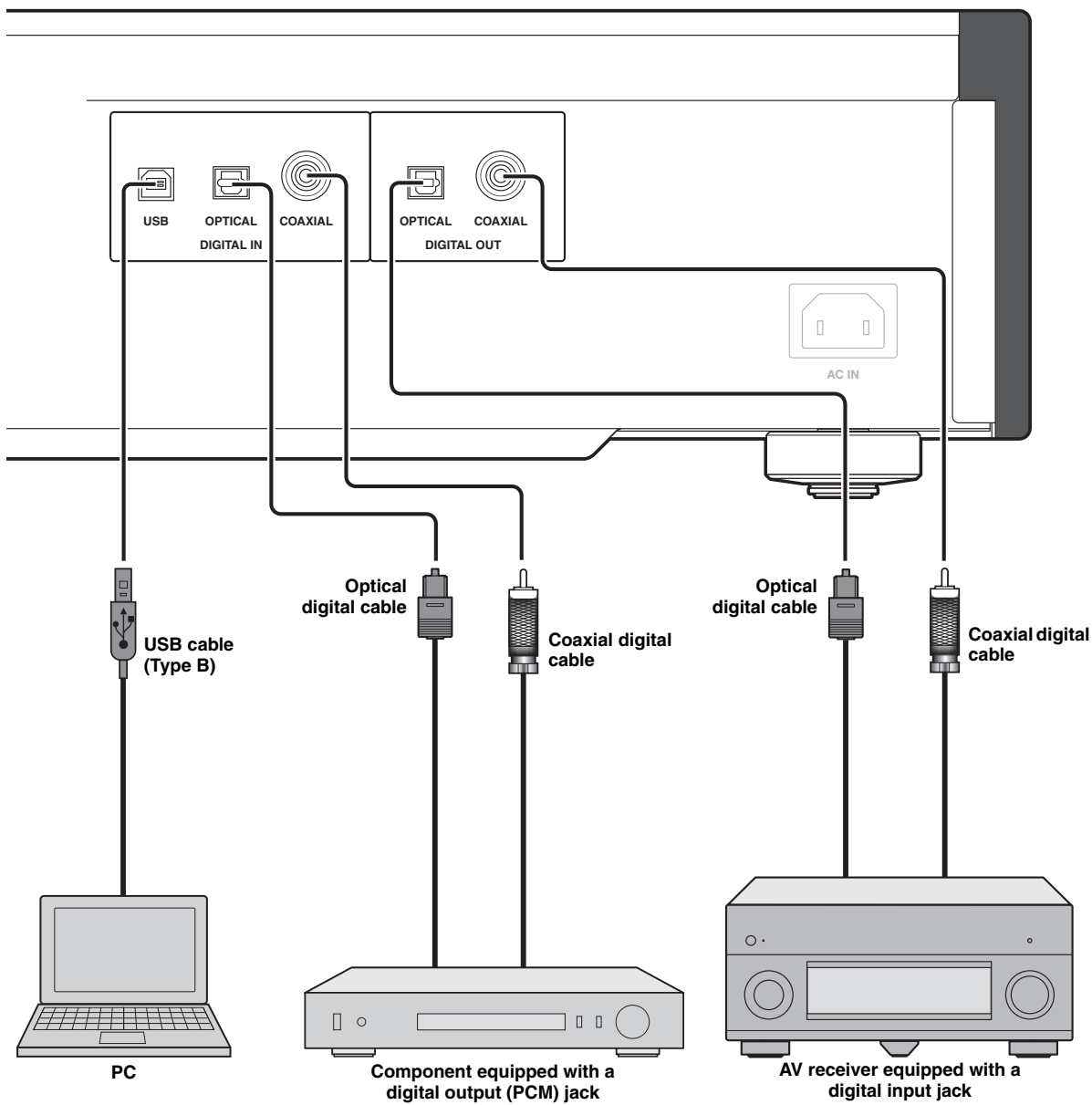

Note

Only PCM signals can be input to the DIGITAL IN (OPTICAL/COAXIAL) jacks of this unit. For details on the supported PCM signals, see page 26.

Connections

■ Connecting to the BALANCED OUT jacks

Connect your amplifier with the XLR balanced input jacks. The pin assignments for these jacks are shown below. Refer to the owner's manual supplied with your amplifier and verify that its XLR balanced input jacks are compatible with the pin assignments.

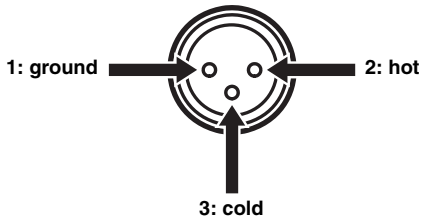

When connecting, be sure to match the pins and insert the connector of the "female" XLR balanced cable. When disconnecting, pull out the "female" XLR balanced cable while pressing down the latch lock on the plug.

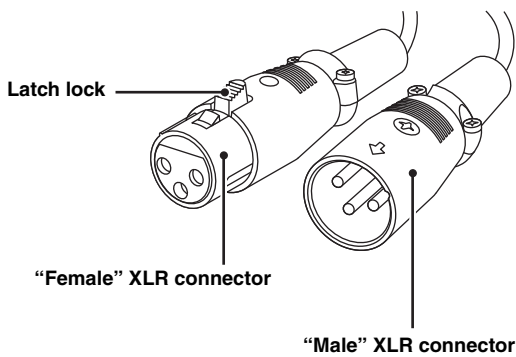

■ Connecting the power cable

Plug the power cable into the AC IN inlet when all connections are complete, and then plug in the power cable to the AC outlet.

Rear panel of CD-S2100

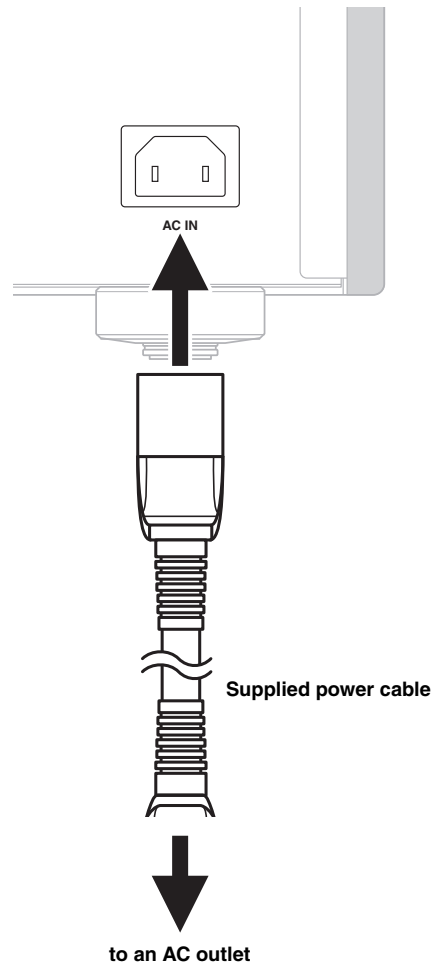

■ Operating this unit from another room

If you connect an infrared receiver and transmitter to the REMOTE IN/OUT jacks of this unit, you can operate the unit and/or external component using the supplied remote control located in another room.

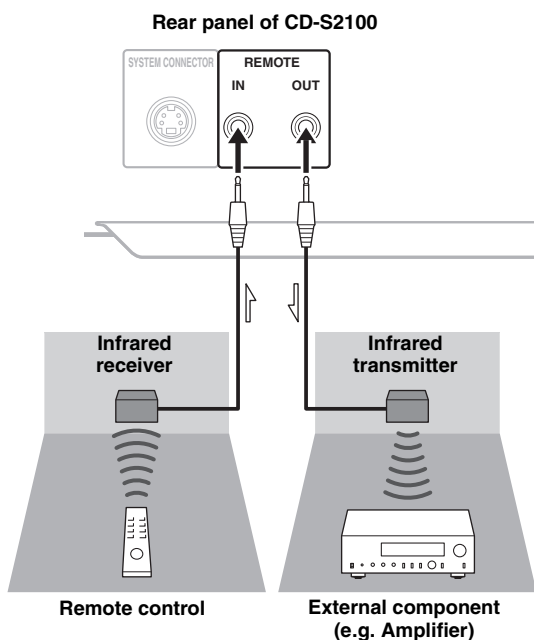

■ Remote connection between Yamaha components

When you have another Yamaha component supporting remote connection, as this unit does, an infrared transmitter is not necessary. You can transmit remote signals by connecting an infrared receiver and the REMOTE IN jack of the other component to the REMOTE IN/OUT jacks of this unit, using cables with monaural miniplugs.

Up to three Yamaha components (including this unit) can be connected.

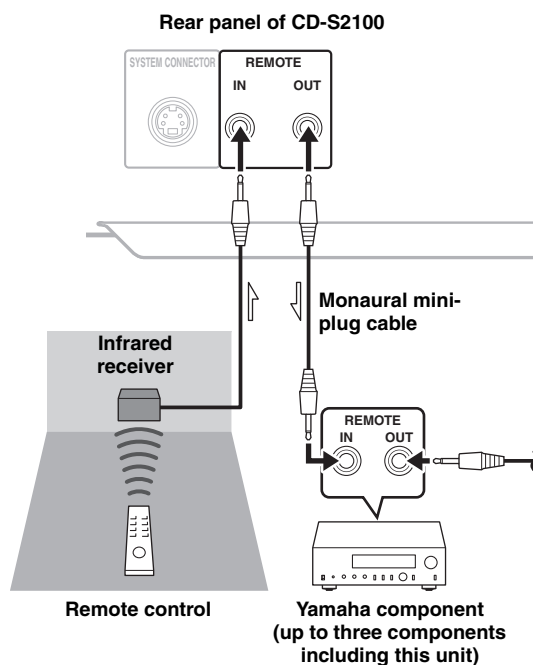

Playback of music files stored on a PC

When a PC is connected to the USB jack of this unit, the unit functions as a USB DAC, enabling music files stored on the PC to be played via an amplifier connected to the unit.

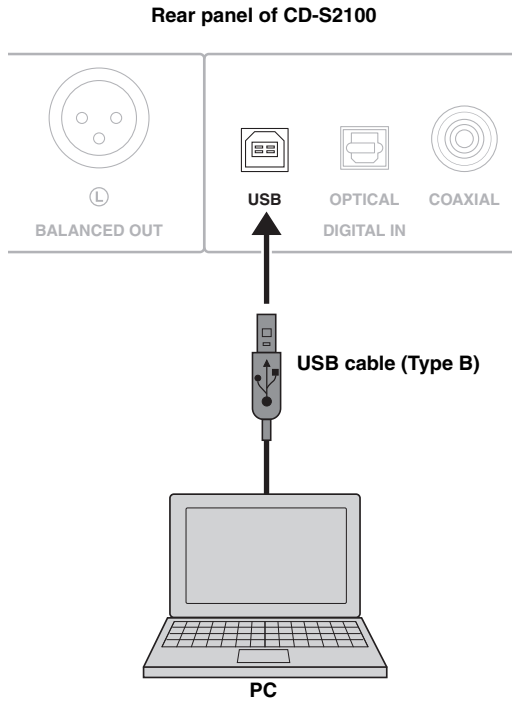

■ Supported operating systems

The USB connection with this unit is for PCs with the following operating systems:

Windows: Windows Vista (SP2, 32bit/64bit)/
Windows 7 (32bit/64bit)/
Windows 8 (32bit/64bit)

Mac: OS X 10.5.8/10.6.8/10.7.x/10.8.x

Notes

- Operations with other operating systems are not guaranteed.
- Operations may be disabled even with the above-mentioned operating systems, depending on the configuration or environment of the PC.
- Operations may not be executed correctly if the PC is connected to this unit before the driver is installed.

■ Installing the dedicated driver

Before connecting a PC to this unit, install the dedicated driver on the PC.

- 1 Access the following URL, download the dedicated “Yamaha Steinberg USB Driver,” then extract and execute the file.**

Website for downloading the exclusive driver
URL: <http://download.yamaha.com/>

- 2 Install the downloaded “Yamaha Steinberg USB Driver” on the PC.**

For details, refer to the Installation Guide supplied with the downloaded driver.

- 3 When installation is complete, quit all running applications.**

- 4 Set the audio output destination of the computer to “Yamaha CD Player.”**

With Windows OS:

Control Panel → Sound → [Playback] tab

With Mac OS:

System Preferences → Sound → [Output] tab

The setting may vary, depending on the operating system. For details, consult the manufacturer of your PC.



Transmittable sampling frequencies are as follows:
44.1 kHz/48 kHz/88.2 kHz/96 kHz/176.4 kHz/192 kHz

Notes

- Operations may not be executed correctly if the PC is connected to this unit before the driver is installed.
- When the driver is installed on a Windows XP computer, the operation speed of the computer may be reduced. In such a case, restart the computer.
- The “Yamaha Steinberg USB Driver” is subject to change without prior notice. For details and the latest information, refer to the download page for the driver.

■ Playing back music files stored on the PC

- 1** Connect the PC to this unit, using a USB cable.
- 2** Turn on the PC.
- 3** Turn this unit on by pressing the **STANDBY/ON, OFF** switch on the front panel.
- 4** Select “USB,” using the **SOURCE** key.
- 5** Set the audio output destination of the PC to “Yamaha CD Player.”

With Windows OS:

Control Panel → Sound → [Playback] tab

With Mac OS:

System Preferences → Sound → [Output] tab

The setting may vary, depending on the operating system. For details, consult the manufacturer of your PC.

- 6** Operate the PC to start playback of music files.

When the music signal is fed from the PC to the unit, the sampling frequency of the file being played is indicated on the display of the unit.

■ Adjusting the sound volume

To obtain higher sound quality, set the sound volume at the PC to the maximum, and gradually increase the volume at the amplifier from the minimum to your desired level.

Notes

- Do not disconnect the USB cable, turn off the unit, or change the input with the **SOURCE** key while playback on a PC connected via the USB cable is in progress. Doing so may cause a malfunction.
- To mute operation sounds of the PC during music playback, change the setting on the PC.
- If music files cannot be played correctly, restart the computer and perform the mentioned procedure again.
- The music files stored on a PC cannot be controlled from this unit or the remote control of this unit. Operate them on the PC.

Specifications

In this section, you will find technical specifications for CD-S2100.



Specifications

AUDIO SECTION

- Frequency Response (1 kHz, 0 dB)
 - SA-CD 2 Hz to 50 kHz (–3 dB)
 - CD 2 Hz to 20 kHz
- Playback Frequency Range 2 Hz to 96 kHz
- Harmonic Distortion (1 kHz, 0 dB)
 - SA-CD 0.002% or less
 - CD 0.002% or less
- Signal to Noise Ratio (IHF-A Network) (1 kHz, 0 dB)
 - SA-CD/CD 116 dB or more
- Dynamic Range (1 kHz, 0 dB)
 - SA-CD 110 dB or more
 - CD 100 dB or more
- Output Level (1 kHz, 0 dB)
 - SA-CD/CD 2.0 ± 0.3 V

LASER DIODE PROPERTIES

- Wavelength
 - SA-CD 655 nm
 - CD 790 nm
- Output Power
 - SA-CD 1.89 mW (max)
 - CD 1.36 mW (max)

INPUT/OUTPUT SECTION

- Digital Input (DIGITAL IN)
 - USB (Type B) × 1 USB 2.0 compliant
 - OPTICAL × 1
 - COAXIAL × 1
 - Support audio sample rate 44.1/48/88.2/96/176.4/192 kHz
 - Word depths 16 bit/24 bit
- Digital Output (DIGITAL OUT)
 - OPTICAL × 1
 - COAXIAL × 1
 - Support audio sample rate 44.1/48/88.2/96/176.4/192 kHz
 - Word depths 16 bit/24 bit
- Audio Output
 - ANALOG OUT Unbalanced × 2 ch (L/R)
 - BALANCED OUT Balanced × 2 ch (L/R)
- Remote Input/Output
 - REMOTE IN
 - REMOTE OUT
- System Connector
 - SYSTEM CONNECTOR

GENERAL

- Power Supply
 - [China, Korea, Asia, Australia, U.K. and Europe models]
..... AC 220 – 240 V, 50/60 Hz
 - [U.S.A., Canada and Taiwan models]
..... AC 110 – 120 V, 60 Hz
- Power Consumption 30 W
- Standby Power Consumption (reference data)
 - [U.S.A., Canada, Taiwan, China, Korea, Asia and Europe models] 0.3 W
 - [Australia and U.K. models] 0.4 W
- Dimensions (W × H × D) 435 × 137 × 438 mm
(17-1/8" × 5-3/8" × 17-1/4")
- Weight 15.6 kg (34.4 lbs)

* Specifications are subject to change without notice.

Taking care of this unit

Polish finish on the side panels

Use of Yamaha Unicon cloth (sold separately) is recommended. For heavy dirt, use Yamaha Piano Unicon (sold separately). For purchasing, contact your nearest authorized Yamaha dealer or service center.

Other finish

When you wipe this unit, do not use chemical solvents (alcohol, thinner, etc.), which might damage the finish. Use a clean, dry cloth. For heavy dirt, dampen a soft cloth in detergent diluted with water, wring it out, and clean this unit with the cloth.

■ Supported disc types

This unit is designed to play back compact discs bearing the marks shown below. Never attempt to load any other types of discs into this unit. This unit can also play back 8-cm (3-inch) compact discs.

Super Audio CD



SUPER AUDIO CD

Audio format based upon the current CD standards but includes a greater amount of information that provides higher quality sound. There are three types of discs: single layer, dual layer and hybrid discs. The hybrid disc can be played on existing CD players as well as Super Audio CD players since it contains both standard audio CD and Super Audio CD information.

Note

This unit does not show text data on the front panel display.

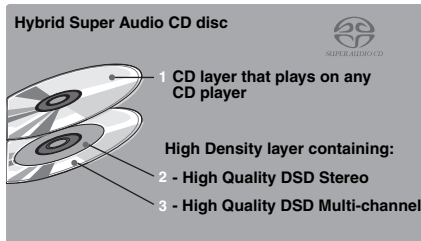
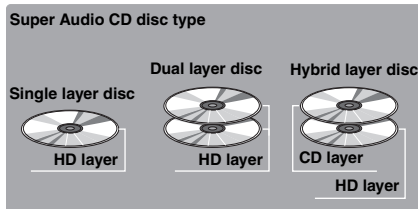

Compact discs (digital audio)



The most popular discs for commercially available audio CDs.

CD-R, CD-RW digital audio discs



Music CDs made by copying onto a CD-R or CD-RW (including MP3 or WMA format files).

Notes

- Be sure to use a CD-R or CD-RW disc made by a reliable manufacturer.
- Be sure to use a CD-R or CD-RW disc which has at least one of the following phrases on the disc or disc case.
 - FOR CONSUMER
 - FOR CONSUMER USE
 - FOR MUSIC USE ONLY
- Be sure to use a finalized CD-R or CD-RW disc.

CD-TEXT discs



The discs recorded with text data such as album titles, track titles, and artist names. These discs can be played back with ordinary CD players.

Note

This unit does not show text data on the front panel display.

NOTE:

This unit may not be able to play back some CD-RW discs or discs on which recording was not made correctly.

To prevent a malfunction of this unit:

- Do not use any nonstandard shaped disc (heart, etc.) available in the market as it might damage this unit.
- Do not use a disc with tape, seals, or paste on it. Such a disc may get stuck in this unit or cause damage to this unit.

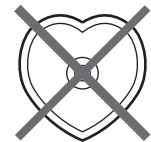

Playable disc format

■ About MP3 and WMA discs

You can play back MP3 and WMA files recorded on a CD-R or CD-RW with similar uses as a music CD.

MP3

MP3 (MPEG-1 Audio Layer-3) is a standard technology and format for compressing an audio sequence into a small-sized file. However, the original level of sound quality is preserved during playback.

Notes

- This unit plays back MP3 files in alphanumeric order.
- Up to 648 folders and files (combined) and up to 299 folders are recognized; however, some folders and files may not be recognized depending on their directory structure.
- Depending on recording conditions such as recording software settings, this unit may not be able to play back the disc or files in the order they were recorded.
- This unit is compatible with a sampling frequency of 44.1 kHz.
- This unit is compatible with a bitrate of 32, 40, 48, 56, 64, 80, 96, 112, 128, 160, 192, 224, 256, or 320 kbps. Variable bitrate is not supported.
- The disc must be ISO9660 compatible.
- The text data contained in the files are not displayed on this unit.

WMA

WMA (Windows Media Audio) is a Microsoft file format for encoding digital audio files similar to MP3 although WMA can compress files at a higher rate than MP3.

Notes

- This unit plays back WMA files in alphanumeric order.
- Up to 648 folders and files (combined) and up to 299 folders are recognized; however, some folders and files may not be recognized depending on their directory structure.
- This unit is compatible with a sampling frequency of 44.1 kHz.
- This unit is compatible with a bitrate of 48, 64, 80, 96, 128, 160, or 192 kbps. Variable bitrate is not supported.
- The disc must be ISO9660 compatible.
- Copyright-protected WMA files cannot be played back with this unit.
- The text data contained in the files are not displayed on this unit.

■ Handling compact discs

- Always handle a disc with care so that its surface is not scratched.



- Compact discs are rarely worn out during playback, but damage to the disc surface when the disc is being handled can adversely affect the disc playback.
- Be sure to use a felt-tip pen or similar writing tool when writing on the label side of a disc. Do not use a ball-point pen, pencil, or other hard-tipped writing tools as these may damage the disc and may adversely affect the disc playback.
- Do not warp discs.
- When a disc is not currently being used, remove it from this unit and store it in an appropriate case.
- When removing or storing a disc, be careful not to scratch the playing surface.
- Compact discs are not affected by small particles of dust or fingerprints on their playing surface, but even so they must be kept clean. Wipe the disc surface with a clean, dry cloth. Do not wipe the disc surface with a circular motion; wipe it straight outward from the center.

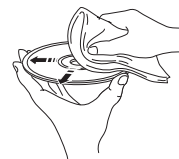

- Do not try to clean the disc surface with any type of disc cleaner, record spray, anti-static spray or liquid, or any other chemical-based liquid as such substances may irreparably damage the disc surface.
- Do not expose discs to direct sunlight, high temperature, or high humidity for a long period of time as these conditions may warp or otherwise damage the disc.

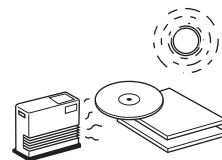

- To play back an 8-cm (3-inch) compact disc, place it in the inner recessed area of the disc tray. Do not put a normal 12-cm CD on top of an 8-cm CD.

Troubleshooting

Refer to the chart below if this unit does not function properly. If the problem you are experiencing is not listed below or if the instructions below do not help, turn off this unit, disconnect the power cable, and contact the nearest authorized Yamaha dealer or service center.

Problem	Cause	Remedy	See page
This unit fails to turn on.	The power cable is not connected nor completely connected.	Securely connect the power cable.	20
This unit automatically goes to STANDBY mode.	The automatic standby function is activated.	If the unit is not operated for 30 minutes with no audio signal detected, it automatically goes to STANDBY mode.	6
The disc tray does not close completely.	A foreign object is obstructing the tray.	Carefully check the disc tray and remove the foreign object.	—
Playback does not start.	The disc is damaged.	Check the disc carefully; replace it if necessary.	—
	There is moisture on the laser pickup.	Wait 20 to 30 minutes after switching the unit ON before trying to play back a disc.	—
	The disc is loaded upside down.	Reload the disc with the label side up.	—
	The disc is dirty.	Clean the disc.	28
	The MP3 or WMA formats are not compatible with this unit.	Replace the disc with a correctly recorded disc playable with this unit.	28
	The CD-RW (ReWritable) disc is not recorded correctly.	Replace the disc with a correctly recorded disc playable with this unit.	27
	The disc is a non-standard disc not playable with this unit.	Replace the disc with a correctly recorded disc playable with this unit.	27
Playback is delayed, or begins at the wrong place.	The disc may be scratched or damaged.	Check the disc carefully; replace it if necessary.	28
No sound.	Improper output cable connections.	Connect the cables properly. If the problem persists, the cables may be defective.	18
	Improper amplifier operation.	Set the amplifier controls to the correct input selection.	—
No playback sound from the component connected to the digital input jacks.	The unit is in PURE DIRECT mode.	Turn off PURE DIRECT mode.	7
	The Super Audio CD layer is being played.	Change the layer for playback.	7
Sound “skips.”	This unit is being subjected to vibrations or impacts.	Relocate this unit.	—
	The disc is dirty.	Clean the disc.	28
	The clock of the playback audio signal is fluctuated.	Change the DPLL bandwidth of the audio DAC (ES9016).	15
Sound “hums.”	Improper cable connections.	Securely connect the audio cables. If the problem persists, the cables may be defective.	18

Troubleshooting

Problem	Cause	Remedy	See page
Noise from a nearby tuner.	The tuner is too close to this unit.	Move the tuner and this unit farther apart.	—
Noise from inside of the disc tray.	The disc may be warped.	Replace the disc.	28
No sound from the component connected to the DIGITAL IN (OPTICAL or COAXIAL) jack.	The output audio source setting on the connected component is not “PCM.”	Only PCM audio sources can be played via the DIGITAL IN (OPTICAL/COAXIAL) jacks of this unit. Set the output audio source of the connected component to “PCM.”	—
The remote control does not work.	The batteries of the remote control are too weak.	Replace the batteries with new ones.	16
	Remote control is too far away or tilted too much.	Use within 6 m and 60° radius.	16
	Direct sunlight or lighting (of an inverter type fluorescent lamp etc.) is striking the remote control sensor of this unit.	Reposition this unit.	8

■ On USB connection

Problem	Cause	Remedy	See page
The connected PC does not recognize this unit.	The operating system of the PC is not supported.	Use a PC with an operation-guaranteed operating system.	22
	Improper USB cable connection	Connect the USB cable properly.	19, 22
	The output of the PC or application is muted.	Cancel the sound muting of the PC or application.	—
Noisy playback.	Another application is launched on the PC while a music file is being played.	If another application is launched while a music file is being played, sound may be momentarily lost or noise may be generated. Do not launch other applications during playback.	—
Music files cannot be played.	The music data are not properly reproduced, because this unit is connected to the PC or the input of this unit is switched to “USB” while the music application is running on the PC.	Connect this unit to the PC and set the input of the unit to “USB” in advance. Then launch the music application and start playback.	22, 23
	The dedicated “Yamaha Steinberg USB Driver” has not been installed correctly.	Install the “Yamaha Steinberg USB Driver” again, following the correct procedure.	22

■ Messages on the information display

Message	Status
NO DISC	No disc is set on the disc tray.
Check Cable	The dedicated “Yamaha Steinberg USB Driver” has not been installed correctly. Or, the audio output of the computer has not been set to “Yamaha CD Player.”
Check PC	The audio signal from the computer cannot be recognized.
Fs: ----kHz	No audio signal is recognized.

