

Congratulations

Thank you for purchasing the Yamaha BID Divided Pickup Unit.

The BID Divided Pickup Unit can pick up the vibrations produced by an electric bass guitar's strings, and transmit those signals to a Yamaha Guitar MIDI Converter (G50). When properly installed and adjusted it can convert almost any steel stringed bass guitar into a controller for a guitar synthesizer system. It can be used on normal 4-string basses as well as 5-string, and 6-string basses.

To get the most out of your BID, please read this owner's manual carefully, and follow the installation instructions within, in order to ensure proper operation. Also, keep this manual in a safe place for future reference.

■ Features

As well as any normal 4-string electric bass, the unit can also be used on 5-string, and 6-string basses. A number of installation options are provided to allow for different guitar shapes, use, and playing styles. Choose a method that best suits your bass and playing requirements.

Methods for Attaching the Divided Pickup:

Special Fittings (removable), double-sided adhesive tape, screw.

Methods for Attaching the Controller:

Velcro fastener, bracket, double-sided adhesive tape, screw.

- One touch operation allows you to switch between bass synthesizer sound and bass guitar sound. Also, the synthesizer's voice and bass guitar's signal can be output separately or together, offering a wide variety of sounds for added playing enjoyment.
- Of course, the bass synthesizer's volume can be controlled. But you can also control other functions like octave, parameter values, program changes (that are transmitted from the G50's memory), and G50's memory numbers (which can be changed by a value of +1/-1).

Contents

Precautions	2
Nomenclature & Functions	3
Parts List	4
Before You Install	5
Attaching the Divided Pickup	6
Attaching the Controller	11
Connections	13
G50 Settings	14
Controller & Switch	15
Getting the Most Out of Your B1D & G50	16
Troubleshooting	17
Specifications	18

Precautions !! PLEASE READ THIS BEFORE PROCEEDING !!

■ Location

Do not expose the B1D to the following conditions to avoid deformation, discoloration, or more serious damage.

- Direct sunlight (e.g. near a window).
- High temperatures (e.g. near a heat source, outside, or in a car during the daytime).
- Excessive humidity.
- Excessive dust.
- Strong vibration.

■ Connections

- When connecting the B1D to the Yamaha G50 Guitar MIDI Converter, be sure to use the specified multi-pin cable (supplied with the G50 Guitar MIDI Converter).
- Always connect the direct guitar cable (page 4), even if you don't intend to use the direct guitar sound. The direct guitar cable is essential for proper grounding, to minimize noise and prevent electric shock.
- Always unplug cables by gripping the plug firmly, **not** by pulling on the cable.
- Disconnect all cables before moving the instrument or any connected equipment.

■ Handling and Transport

- Never apply excessive force to the controls, connectors or other parts of the instrument.
- Physical shocks caused by dropping, bumping, or placing heavy objects on the instrument can result in scratches and more serious damage.
- Be careful not to damage the B1D controller when placing the guitar in a case or on a stand.

■ Cleaning

- Clean the unit with a dry soft cloth.
- A slightly damp cloth may be used to remove stubborn grime and dirt.
- Never use cleaners such as thinner.

■ Notes on Adhesive Tape

- Depending on the surface of the bass guitar the finish may peel off or be altered chemically when the pickup/controller is mounted using adhesive tape (double-sided). To make sure, it is recommended that you first try this method of attachment by applying some tape at a place on the guitar body which is not visible normally.
- If the pickup must be removed from the base guitar, always use a fresh layer of double-sided adhesive tape and/or cushion when reinstalling, as the adhesive properties of used tape/cushion are reduced drastically when peeled off the mating surface. Also, before attaching the adhesive tape or pickup, clean the mating surface thoroughly, as dust and grease may cause the pickup to come loose.

■ Service and Modification

- The B1D contains no user serviceable parts. Opening it or tampering with it in any way can lead to irreparable damage and possibly electric shock. Refer all servicing to qualified YAMAHA personnel.

Yamaha is not responsible for damage caused by improper installation, handling, or operation.

Nomenclature & Functions

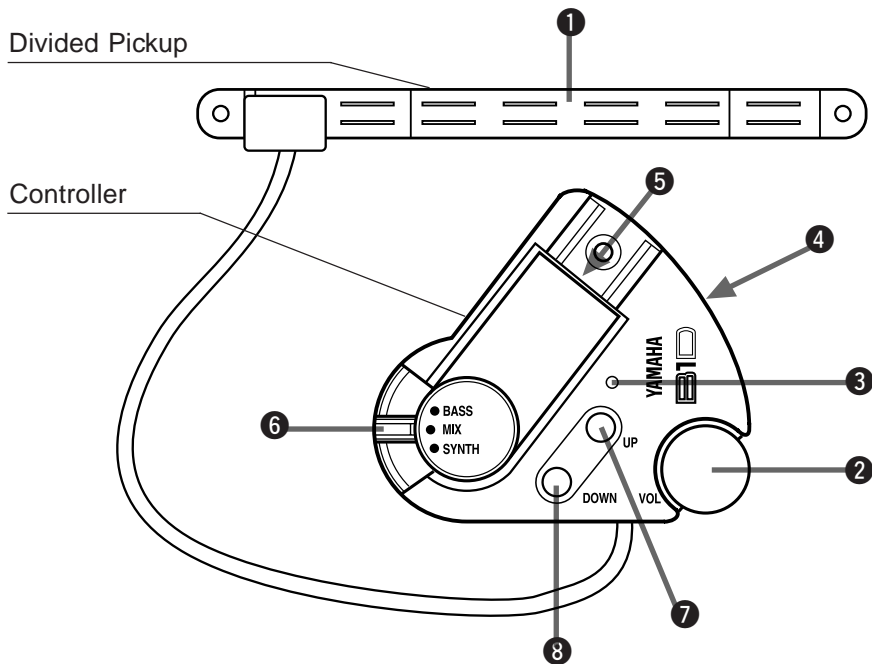

① Divided Pickup

This magnetic type pickup converts vibrations from the bass guitar's individual strings into an electrical signal.

The pickup is attached to the bass guitar's body.
→ page 6 "Attaching the Divided Pickup"

② Synth Volume Control

Controls the volume of the synthesizer.

* *Does not adjust the volume of the bass guitar.*

③ Power Indicator

The B1D is receiving power from the G50 Guitar MIDI Converter when this indicator is lit. The indicator lights when the B1D is properly connected to the G50 via the 13-pin cable.

④ Direct Bass Guitar Input Jack

This jack allows the B1D to receive the combined output from the bass guitar's normal pickups (bass guitar signal) from the guitar's output jack. Use the supplied direct bass guitar signal cable when making connections.

The bass guitar signal is output from the GUITAR DIRECT OUT jack of the G50 (→ pg. 13).

⑤ B1D Output Jack

The selected signal from the Output Selector is transmitted to the Guitar MIDI Converter via this jack.

⑥ Output Selector (BASS/MIX/SYNTH)

Selects the type of output to be delivered via the 13-pin cable connector to the Guitar MIDI Converter.

BASS: Only the direct bass sound (output from the electric bass pickup) will be heard.

SYNTH: Only the synthesizer sound (output from the divided pickup) will be heard.

MIX: Both the direct bass guitar signal and the synthesizer sounds will be heard.

⑦ UP Switch

⑧ DOWN Switch

According to settings in the Guitar MIDI Converter, these switches can be used to increase or decrease the values by 1 for program memory numbers, parameter values, program change numbers, octave shift values, etc.

→ Refer to the manual for your Guitar MIDI Converter for further information.

* G50 owner's manual: pg. 12

Parts List

Before you install the BID, please make sure you have all of the parts listed below.

● B1D Main Unit (Divided Pickup + Controller)

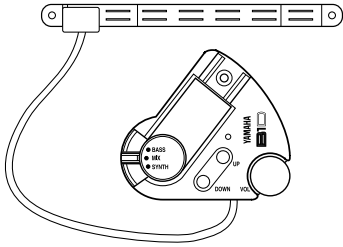

● Direct Bass Guitar Cable

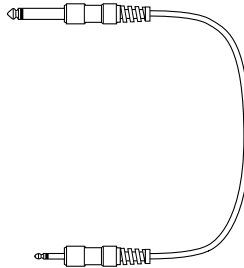

● Clearance Gauge 2 Pieces

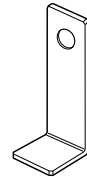

● Divided Pickup Attachment Parts

- Spacer A (Thickness: 1mm)
..... 10 Pieces



- Spacer B (Thickness: 0.3mm)
..... 12 Pieces



- Pickup Cushion
(Double-Sided Adhesive)
..... 8 Pieces



- Pickup Double-Sided Adhesive Tape
..... 16 Pieces



- Springs 2 Pieces

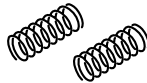

- Tapping Screws 3x25mm 2
Used to attach the pickup to the body.

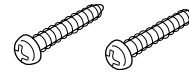

- Small Screws
3x6mm, with washer 2
Used to attach the pickup fittings to the
base plate.



- Small Screws
3x6, 3x8, 3x10, 3x12mm .. 2 each
Used to attach the pickup to the pickup
fittings.



- Plate Tapping Screws
3x10mm, 1 type 2 pieces
Used to attach the base plate to the bass
body.



- Base Plate (Right, Left) 1 Set

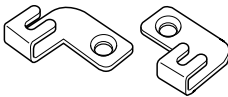

- Double-Sided Adhesive Tape for
Base Plate 8 Pieces

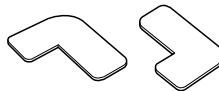

- Pickup Attachment Fittings
(Right, Left) 1 Set

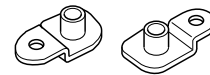

● Controller Attachment Parts

- Bracket 1

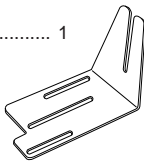

- Velcro Fastener 1

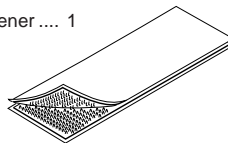

- Suction Cups 3 Pieces

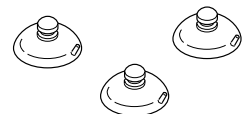

- Tapping Screw
3x16mm 1
Used to attach the controller to the
body.



- Controller Cushion
(Double Sided-Adhesive Tape)
..... 6 Pieces

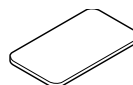

Before You Install

■ Installing on the Bass Guitar

Before you install the B1D on your bass guitar, carefully read the advice provided below. Select an installation method which is best suited to your bass guitar and playing requirements.

● The Bass Guitar

The B1D is a divided pickup designed for use with steel string electric basses. It can be used with 4-string as well as 5- and 6-string basses. If your bass guitar is one of the types listed below, the B1D will not function properly with it.

- 8-string basses or other non-standard string configurations other than 4-, 5-, and 6- string basses.
- Nylon string or other non-metallic string bass guitars.
- Basses with extremely wide or narrow string spacing. Any bass guitar that the strings will not properly fit over the magnetic pickup (→ refer to “Specifications” on pg. 18).
- Basses with extremely low string clearance. Depending upon the manner in which the pickup is attached, make sure that there is more than 10-13mm (0.39"-0.51") of clearance.

The divided pickup is specially designed and adjusted for use on bass guitars with up to 6-strings, the pickup will not function with 6-string guitars.

The divided pickup should be attached between the bridge and rear pickup, ideally 10-20mm (0.39"-0.79") from the bridge. Make sure you have adequate space for proper installation of the pickup. Make sure your bass' neck (truss rod) and string height/intonation (bridge) are properly adjusted before installing the B1D.

Disconnect the Direct Bass Guitar Signal cable and the 13-pin cable from the B1D controller before installation.

Installing the Pickup Controller

Due to the divided pickup's magnetic strength, the double-sided tape may peel off the bass guitar body if the point of attachment is weak. Also, the pickup and controller may be knocked off, if the bass guitar is

● Select the Method of Installation

Three methods for installing the divided pickup are listed below.

● Base Plate Installation (Removable)

- Height adjustment is easily performed.
- The divided pickup can easily be removed yet pickup height adjustment is maintained.

● Double-sided Adhesive Tape

- Reduces the risk of damaging the bass guitar body.
- More time and care must be taken to achieve proper pickup height.

● Spring and Screw Installation

- Height adjustment is easily performed.
- The pickup can be securely attached to the bass body.
- **It will be necessary to drill holes in the bass guitar's body.**

Five methods for installing the Controller unit are listed below.

● Velcro Installation

- Easy removal and replacement.

● Bracket Installation

- Used in conjunction with adhesive tape, the controller can be installed on bodies that are not flat.
- The bracket can also be attached using the bass guitar's strap pin. However, some caution must be used to keep from damaging the strap pin screw.

● Suction Cup Installation

- Easy to remove, replace and transport the unit.
- Easy to attach the controller unit to a bass guitar with a flat top and a smooth, shiny finish.

● Double-sided Adhesive Tape

- Easy and secure attachment is possible.

● Screw Installation

- Used in conjunction with adhesive tape, the controller can be installed on bodies that are not flat.
- **It will be necessary to drill a hole in the bass guitar body.**

* **If you use the base plate attachment (removable) for the divided pickup, it is a good idea to attach the controller with Velcro tape or suction cups so it is removable as well.**

subject to strong shock or prolonged use, if an attachment method other than screw installation is used. Select a method of attachment according to installation position, and the strengths of the method of installation.

Attaching the Divided Pickup

■ Mark the Installation position for the divided Pickup.

The divided pickup should be located between the rear pickup and bridge so that the cable end of the pickup is oriented toward the lower bass string (the pickup will not function if it is attached facing the opposite direction).

The divided pickup is designed for use on basses with up to 6 strings (6B, 5E, 4A, 3D, 2G, 1C). If the pickup is to be used on a 4-string bass, align the 4 magnetic yokes, in the center portion of the pickup, with the strings.

For 5-string basses with a [B, E, A, D, G] tuning, use the 5 magnetic yokes on the cable end of the pickup. If the tuning is [E, A, D, G, C] use the 5 magnetic yokes opposite the cable end of the pickup.

- For 4-string basses (4E, 3A, 2D, 1G)

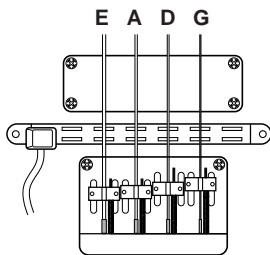

- For 5-string basses (5B, 4E, 3A, 2D, 1G)

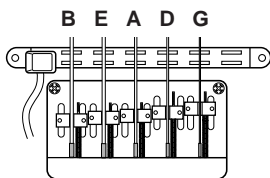

- For 5-string basses (5E, 4A, 3D, 2G, 1C)

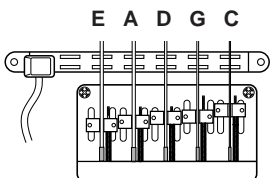

- For 6-string basses (6B, 5E, 4A, 3D, 2G, 1C)

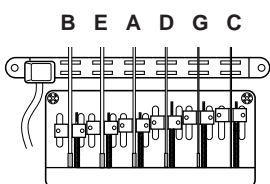

Place the divided pickup on the body and decide the optimum position for installation.

From the low end string side, slide the divided pickup under the bass guitar strings. Using the magnetic attraction of the pickup to the strings, adjust the position so that each string passes over its corresponding magnetic yoke.

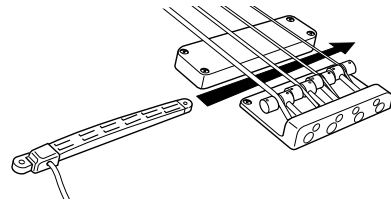

Adjust the position of the pickup so that it meets the conditions listed below.

1. Each string must pass over its corresponding magnet.

The pickup will not function properly if the string does not properly pass over the magnetic yoke. Check that the strings pass over the magnetic yokes, even when bending the strings.

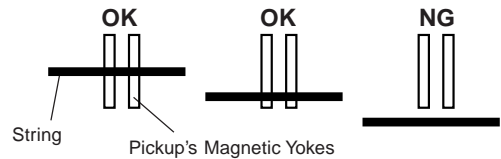

2. The distance between the divided pickup and the bridge should be about 10-20mm (0.39"-0.79").

- * Make sure the pickup is not in contact with the bridge.
- * The distance can be increased to more than 20mm (0.79") as long as the strings pass over the magnetic yokes when bending the strings.

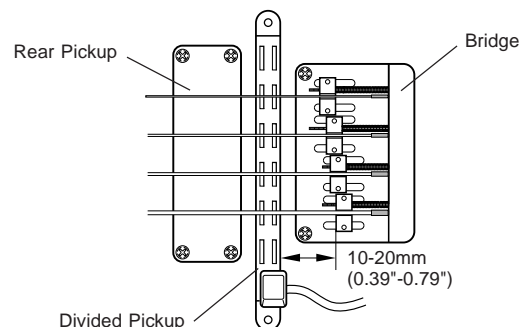

3. String height should not be widely varied.

Extreme variations in string height will result in a poor output level for the pickup (The output level can be somewhat controlled with the G50's Gain Setting).

Once the optimum installation position has been decided, you can prepare to attach the pickup. However, the distance between the string and the pickup's magnetic yoke is extremely important.

Since the height of the pickup's magnetic yokes cannot be adjusted individually, the pickup position, the pickup's overall height, and string height, can be adjusted to meet the conditions necessary for optimum string/pickup clearance.

The distance between the top of the pickup's magnetic yokes and the bottom of each string should be about 1-2mm (0.04"-0.08") when each string is fretted at the highest note on the neck. The distance between the pickup and the bottom of the strings can be set to less than 1mm (0.04") as long as the strings do not touch the pickup when the bass is played. However, as long as other strings can be set to a height of 2.0mm (0.08") or less, try to set the E and B strings between 1.5 (0.06") and 2.0mm (0.08").

Also, the output level for each of the magnetic pickups is fairly different so after the divided pickups is attached make sure you set Input Gain each strings with the Guitar MIDI Converter.

The chart below lists the optimum string/pickup distance and G50 Input Gain Settings for average bass guitars. Use the chart as a reference when setting up your pickup.

		Distance *1	Gain Setting *2
4-string bass	G string	1.0mm (0.04")	15
	D string	2.0mm (0.08")	30
	A string	2.0mm (0.08")	30
	E string	1.5mm (0.06")	10
5-string bass	G string	1.0mm (0.04")	15
	D string	1.0mm (0.04")	15
	A string	1.5mm (0.06")	22
	E string	2.0mm (0.08")	20
	B string	1.0mm (0.04")	6
6-string bass	C string	1.0mm (0.04")	15
	G string	1.5mm (0.06")	22
	D string	1.0mm (0.04")	15
	A string	1.0mm (0.04")	15
	E string	2.0mm (0.08")	20
	B string	2.0mm (0.08")	10

*1 The distance between the string and magnetic yoke when the string is fretted on its highest note.

*2 The G50's individual input gain settings (1-50).

* For 4-string basses
(looking from the bridge side).

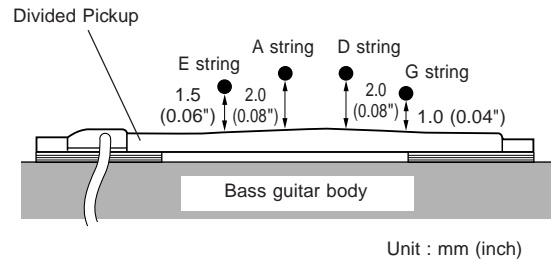

Unit : mm (inch)

Use the supplied clearance gauge (1mm (0.04") thick) to check pickup clearance. Put two gauges together to check for a clearance of 2mm (0.08").

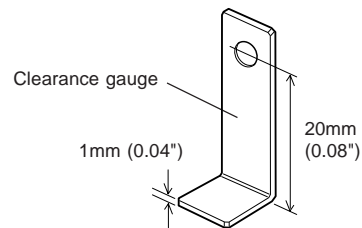

- **First, make sure the truss rod and string height are properly adjusted, then tune the strings to their normal pitch.**
- **Determine the optimum method of attaching the divided pickup.**
Refer to the "Select the Method of Installation" section on page 5, and determine the optimum method of attachment in regards to the attachment position, materials, type of body, playing requirements, etc.
- **Use the supplied suction cups to temporarily attach the Controller to the body so that it doesn't get in the way while attaching the Divided Pickup.**

■ Attach the Divided Pickup

(Removable) Fittings Attachment

The divided pickup can easily be removed yet pickup height adjustment is still maintained.

1. Apply the base plate's double-sided adhesive tape, to the underside of the base plate. (Do not remove the backing yet.)
2. Fix the Pickup Attachment Fittings to the Divided Pickup with the screws and springs. For proper height adjustment, select the best length screw (6, 8, 10, 12mm). To start with, loosely fix the pickup with the 6mm screws, and adjust the height after the base plate is attached to the body.
3. Use the 3x6 screws (with washer) to attach the pickup attachment fittings to the base plate.
4. With the pickup carefully positioned on the bass body, mark the position where the base plates (left/right) will be attached.
5. Remove the backing from the double-sided adhesive tape on the base plates (left/right).
6. Without letting the adhesive side of the tape come in contact with the bass body, position the base plate over the place where it is to be attached and then lower the base plate onto the body surface.
 - * Holding both ends of the pickup, apply light pressure to attach the pickup to the body.
 - * If the base plate is to be attached with screws, remove the pickup and pickup attachment fittings from the base plate. Drill a 2mm (0.08", approx.) diameter hole into the bass guitar's body making sure that the hole is drilled vertically. Use the plate tapping screws (3x10mm) to fix the base plate to the bass guitar body.
7. With the bass properly tuned, use the small screws to adjust the distance between each of the strings and their corresponding pickup yoke. With each string fretted at its highest note on the neck, check the distance between each string and its corresponding pickup using the supplied clearance gauge (→ pg. 7).

* To remove the base plate from the bass guitar's body, use a minus screwdriver to gently pry the base plate from the body, or use a pair of pliers to lift the base plate from the body. Either way, be careful not to scratch or damage the bass guitar body or the base plate while removing the base plate.

8. Once pickup height has been properly set, adjust the individual input levels on the Guitar MIDI Converter (Refer to pg. 14. Also, the Guitar MIDI Converter manual).

The pickup can be removed by loosening the 3x6mm small screws (with washer), and sliding the pickup attachment fittings out of the base plate. The next time the pickup is attached to the base plate, the previously set height adjustment will be maintained so further height adjustment will not be necessary.

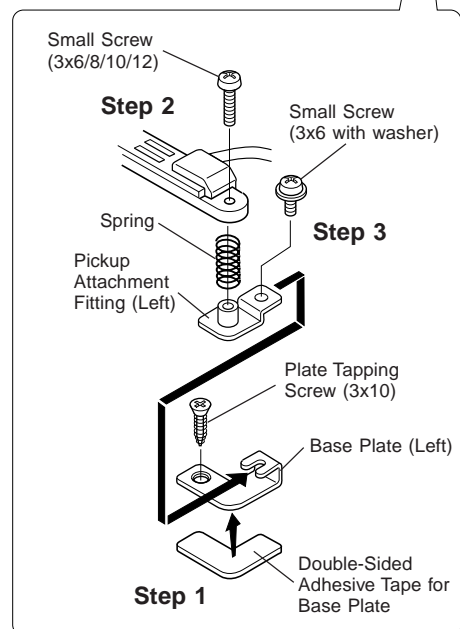
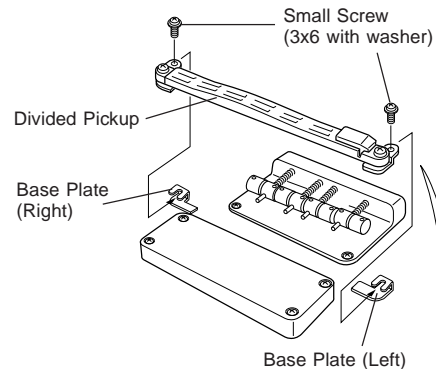

* If the base plate is in contact with the bass guitar's volume knob or, removal and replacement of the divided pickup is hindered, attach the base plate in the direction shown in the illustration below. Remove in the order shown (1 → 2).

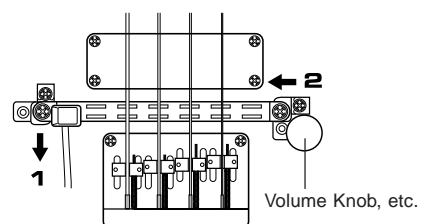

Double-Sided Adhesive Tape Attachment

Use the cushions and spacers to adjust the height of the pickup, and use the double-sided adhesive tape to attach the pickup to the bass guitar.

1. Cut in half the spacers (A, B) used to adjust the pickup's height.

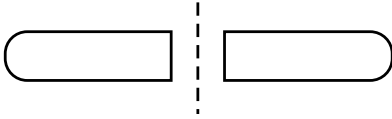

2. Determine how many spacers and/or cushions will be needed to attain proper height for the pickup.

With the backing still in place, stack spacers A (1mm thick), B (0.3mm thick), and the cushion underneath both ends of pickup (with the pickup underneath the strings) until proper clearance between the strings and magnetic yokes is achieved (→ pg. 7). Do not remove the backing from the cushions or spacers when initially setting up the pickup height. Initially use spacers A (1mm thick) and the cushion to gain the approximate height necessary, then use spacers B (0.3mm thick) to fine-tune the height of the pickup.

* Before you adjust the pickup height, make sure that the bass guitar is properly tuned.

* Please note that the cushion/spacer backing adds about 0.1 millimeter to their thickness, so take this added thickness into account when using a number of spacers.

* If the body surface is not flat, use the double-sided adhesive tape or cushion to attach the pickup to the bass guitar body so that the pickup properly adheres to the body.

* If you need to compensate for differences in height between the low and high strings, cut the double-sided adhesive tape and cushion into one-quarter or one-third widths and adjust the height.

3. Once the number of pieces has been determined, apply the cushions (with double-sided adhesive) or double-sided adhesive tape to the bottom of the pickup, then apply one spacer and check the clearance with the clearance gauge while the highest note on the neck is fretted (→ pg. 7). Add spacers one by one,

continually checking the clearance, until the proper height is attained. Do not remove the backing from the tape that is used to attach to the pickup to the bass guitar body until you are sure that proper height is achieved.

4. Once the proper height is achieved, remove the backing from the tape used to attach the pickup to the body. Keeping the exposed tape from coming into contact with the body, slide the pickup under the strings. From the high string side of the bass guitar, slide a minus driver or similar tool under the strings, to help support the pickup from the opposite side. Once the pickup is slid into position, attach the pickup/spacer assembly to the body.

* Make sure that the bass body is free from dust and oil which might prevent the adhesive from sticking to the body.

* Holding both ends of the pickup, apply light pressure to attach the pickup to the body.

5. Once the pickup is attached and the height has been adjusted, adjust the input gain levels on the Guitar MIDI Converter (Refer to pg. 14. Also, the Guitar MIDI Converter manual).

* To remove the divided pickup from the body without causing damage to the bass body, leave the spacer attached to the body in place and gently pry off the second layer spacer.

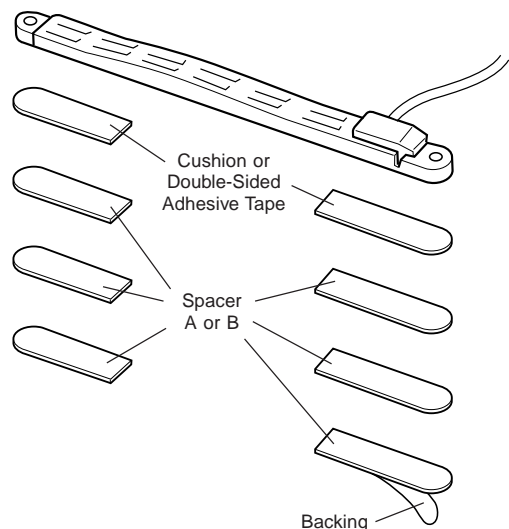

Attaching the Divided Pickup

Use the following steps if you need to readjust the pickup height.

1. Determine the number of spacers you need to add or remove.
2. Remove only the pickup from the body. Without applying any excessive force to the pickup, carefully pry the pickup from the spacers by sliding a thin, flat object under the low string end of the pickup, and gently lifting the pickup away from the spacer.

** Bending or twisting the pickup may cause the coil inside the pickup to snap, resulting in a damaged pickup. Use caution.*

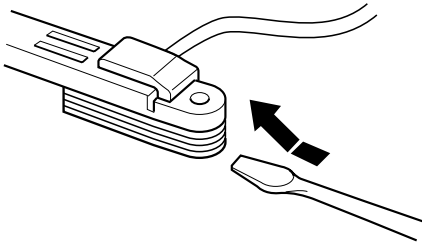

3. Carefully remove the double-sided tape from the underside of the pickup.
4. Readjust the height as required. If spacers must be added, remove the double-sided tape from the existing spacer. If spacers must be removed, be sure to remove both the spacer and its double-sided tape.
5. Finally, attach fresh double-sided tape or a cushion to the bottom of the pickup, remove the backing, carefully attach the pickup to the uppermost spacer.
6. Re-tune the bass and check the clearance with the supplied clearance gauge.
7. If proper clearance is achieved, adjust the input gain levels on the Guitar MIDI Converter (Refer to pg. 14. Also, the Guitar MIDI Converter manual).

Screw and Spring Attachment

It will be necessary to drill holes in the bass guitar body to attach the pickup with screws and springs.

1. Place the pickup in the position in which it will be attached, then carefully mark the centers of the two screw holes at either end of the pickup on the bass guitar body.
2. Drill the screw holes. Carefully drill a 2mm (0.08", approx.) diameter hole at both marked locations. Make sure that the holes are drilled vertically.
3. Insert the springs into the underside of the pickup, insert the tapping screws (3x25) through the screw holes and springs, and screw the screws in the holes in the body.
4. With the bass properly tuned, adjust the pickup height by loosening or tightening the pickup screws. Adjust the clearance while the highest note on each string is fretted. Pickup clearance can be checked using the supplied clearance gauge (→ pg. 7).
5. If proper clearance is achieved, adjust the input gain levels on the Guitar MIDI Converter (Refer to pg. 14. Also, the Guitar MIDI Converter manual).

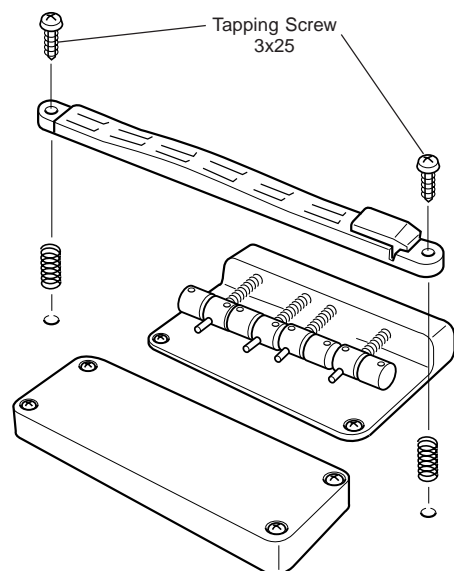

Attaching the Controller

Decide the position for attaching the controller.

Consider the following points carefully when deciding on the best location to install the controller.

- The controller and cable should not hinder performance.
- The controller should not block or hamper access to any of the bass guitar's controls: volume, tone, switches, etc.
- The BID controller should be positioned in an easily accessible position.
- Do not position the controller in a manner that will apply excessive force to the cord that connects the divided pickup and controller.
- Do not position the controller in a manner that will apply excessive force to the cord that connects the direct bass guitar signal and controller.
- Do not position the controller in a manner that will apply excessive force on the controller or cords when the bass is placed on a guitar stand.
- Do not position the controller in a manner that will apply excessive force on the BID or bass guitar when the bass is placed in its case.

Determine the optimum method of attaching the controller.

Refer to the "Select the Method of Installation" section on page 5, and determine the optimum method of attachment in regards to the attachment position, materials, type of body, playing requirements, etc.

Before you install the controller, disconnect the direct bass guitar signal cable and the 13-pin cable from the controller.

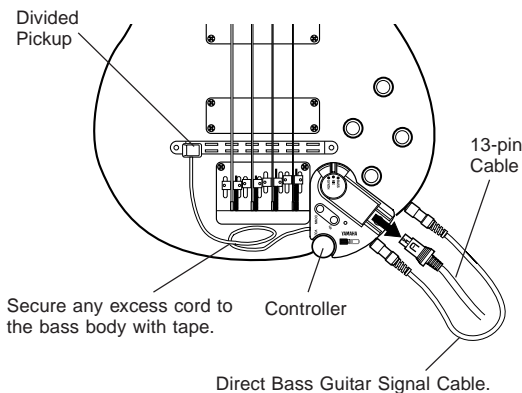

Attach the Controller

Velcro Tape Attachment

1. With the male and female portions of the Velcro still attached, cut the Velcro tape into three pieces, and attach one side of the Velcro to the underside of the controller.
2. Remove the backing from the other side of the Velcro tape, and attach the controller to the bass guitar's body.

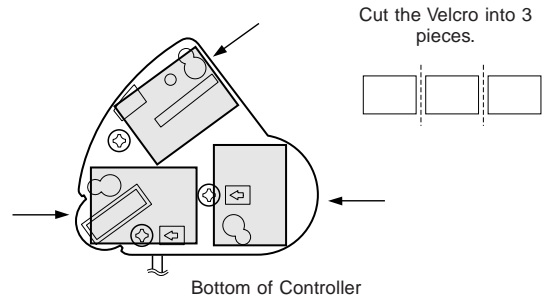

Bracket Attachment

1. Use the two screws (marked with arrows) on the bottom of the controller to attach the bracket to the controller.

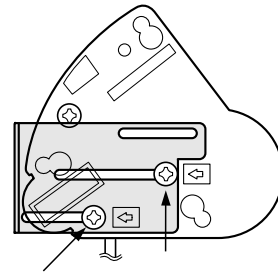

2. Attach an appropriate number of cushion (double-sided adhesive) to the bracket so that the bass guitar surface does not come in contact with the screw heads, and attach the bracket to the guitar in the appropriate position.

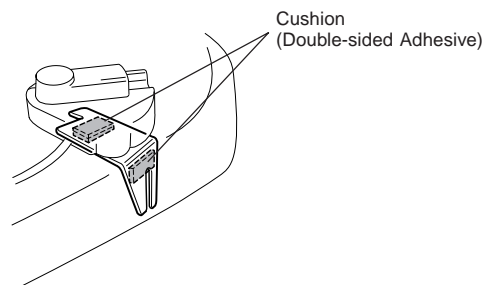

Attaching the Controller

The bracket can also be fixed to the bass guitar using the strap pin.

An alternate method is to attach the bracket using the bass guitar's strap pin. Loosen the screw holding the strap pin to the bass guitar body, slide the slot in the bracket under the pin, then tighten the pin screw until the bracket is held firmly in position.

* Attach enough cushion (double-sided adhesive) so that the screws, that are used to fix the bracket to the controller, do not come in contact with the bass guitar body.

* Repeated loosening and tightening of the strap pin, or application of excessive force to the bracket, can cause the strap pin screw to become loose.

* The bracket can also be used in combination with suction cups.

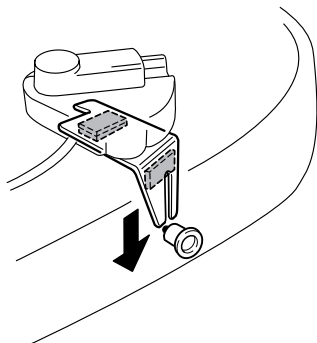

Suction Cup Attachment

Insert the three suction cups into the three holes on the bottom of the controller unit, then simply press the controller unit onto the bass guitar top at the appropriate location.

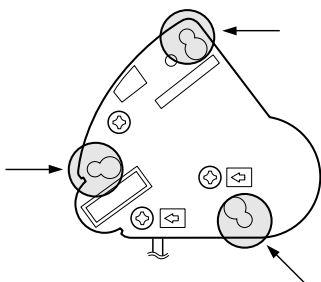

* Make sure the surface or your bass guitar top is free from any dirt and grease.

* The suction cups can be removed by slightly lifting the edge of each cup.

Cushion Attachment

Attach three pieces of controller cushion to the bottom of the controller.

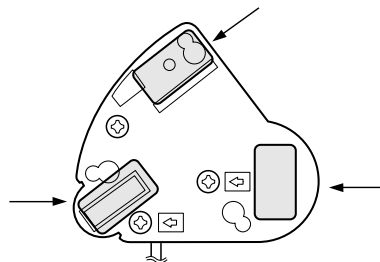

If your bass guitar body is not flat (arched top, etc.), use as many of the controller cushions (double-sided adhesive) as needed in the appropriate location(s) to position the controller as required.

* Make sure the surface or your bass guitar top is free from any dirt and grease.

Screw Attachment

Double check the attachment position of the controller before attaching.

1. Place the controller in exactly the position it is to be installed, and mark the center of the screw hole. Set the controller unit aside and carefully drill a 2mm (0.08", approx.) diameter hole at the marked location. Make sure the hole is drilled vertically.
2. In the same manner described in the "Double-sided Adhesive Tape Attachment" section, attach the double-sided adhesive tape to the bottom of the controller unit.
3. Making sure that the screw hole in the controller is perfectly aligned with the screw hole, attach the controller unit to the bass guitar body. Screw the supplied self-tapping screw (3x16mm) into the pre-drilled hole in the body through the hole in the controller. Make sure that the screw does not go in crooked.

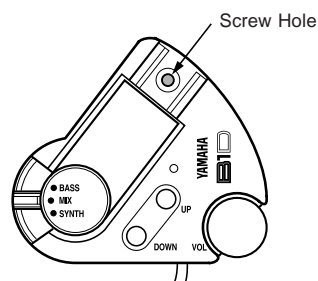

Connections

Make sure the power is OFF on all related equipment before making any connections. Also, set the amp volume to its lowest setting.

1. Use the direct bass guitar signal cable to connect the bass guitar's output jack to the BID's bass guitar input jack.

* Always connect the direct bass guitar signal cable, even if you don't intend to use the direct bass guitar sound. The direct signal cable is essential for proper grounding, to minimize noise, and prevent electric shock.

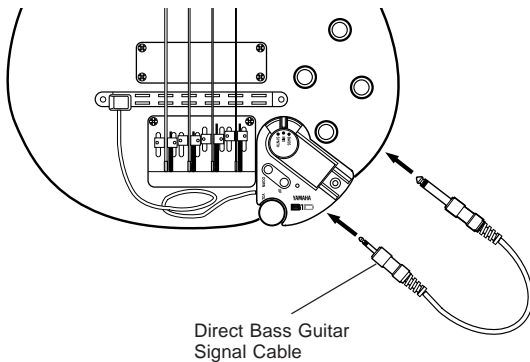

2. Use the 13-pin cable to connect the Guitar MIDI Converter's Divided Input to the BID.

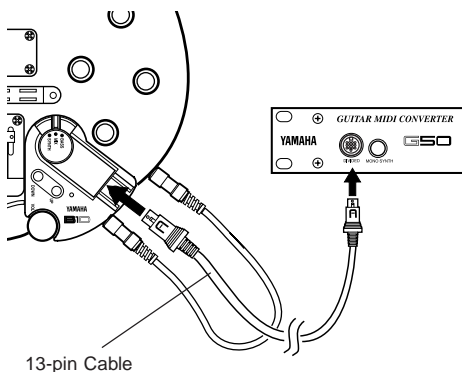

G50 Rear Panel Connections

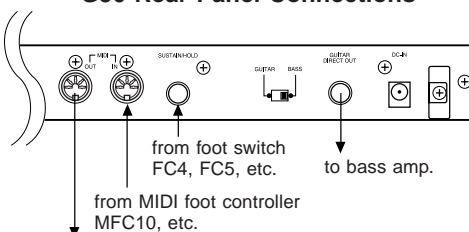

to tone generator
MU80, VL70-m, etc.

* For extra security and to prevent damage it is a good idea to pass the cable between the strap and bass guitar body near the body strap pin.

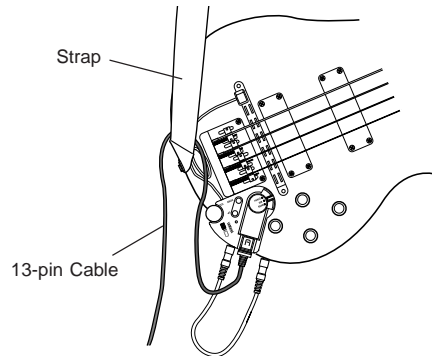

* The special 13-pin cable is of a locking type. To disconnect the cable, always unlock the cable and then remove the cable by gripping the plug firmly, not by pulling on the cable.

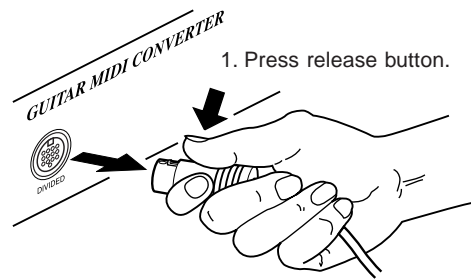

2. Unplug cable by gripping the plug firmly.

3. Connect the tone generator, bass amp, and any other related devices to the Guitar MIDI Converter.

4. Adjust the pickup settings on the Guitar MIDI Converter (Refer to your Guitar MIDI Converter manual).

If you are using the G50 Guitar MIDI Converter, set the GUITAR/BASS mode switch located on the rear panel of the G50 to the BASS position.

5. Turn ON the power in the following order, **Tone Generator**→**Guitar MIDI Converter**→**Related Equipment**→**Bass Amp**

The BID power indicator should light. If you are using the G50, "BASS" will appear in the display. With this, connection is finished and you are ready to play.

* If the indicator does not light, double check all connections.

G50 Settings

If you are using the Yamaha Guitar MIDI Converter G50, set the following settings on the G50.

● Guitar/Bass Mode Switch

With the G50 power switched OFF. Set the GUITAR/BASS mode switch, located on the rear panel of the G50, to the BASS position.

When the G50 is in the BASS mode, “*BASS*” will appear on the G50 display when the power is switched ON. Verify.

● Load the Bass Preset Program

With the G50 set to the BASS mode, bass preset program memory will be loaded into the G50's memory when the Initialize operation (→ refer to the G50 owner's manual: pg. 20) or the Preset Program Set operation (→ refer to the G50 owner's manual: pg. 8) is carried out.

* *Bass Preset Program List*
(Refer to the G50 owner's manual: pg. 25).

* *When the G50 is initialized, all program data stored in the G50 will be erased (it will be replaced with new data). If you have any data you want to save, use the MIDI bulk dump operation to save the data to an external MIDI device (→ Refer to the G50 owner's manual: pg.19).*

● Set the Input Gain (Refer to the G50 owner's manual: pg. 9)

Under normal playing conditions, the input level value should be between 20 and 60, playing harder may increase the level to about 90 or more.

However, the level for the E and B strings may only reach 80 when played hard.

Even if the input level is set to the above levels, you may experience double notes, other notes may sound, or the 5th and 7th fret harmonics may unexpectedly sound, so the input gain level for each string should be carefully adjusted. Particularly, the E and B strings should be set to low levels (5-10).

Also, if you play with your fingers, the picking finger may hit the adjacent low string causing unwanted triggering of the lower string (ex. when you play the A string, notes on the E string sound), so it is preferable to use lower input gain settings (E string) to remedy this problem.

On the same fret play with the same amount of force on all of the strings, while checking the balance of the input level value set the input gain level and make sure that each string is in balance with the others (→ Refer to the list on pg. 7).

● Set the Playing Style (Refer to the G50 owner's manual: pg. 14)

The Playing Style setting adjusts the G50's input level and velocity to the playing style you intend to use.

P *ic* (Pick): Pick mode

Standard setting for the bass mode, good for playing with your fingers. If you play with a pick or use a tapping technique, this mode should also be used.

Sl P (Slap): Slap mode

Use this mode if you use a slap technique. However, it is recommended that you mix the direct bass sound with the synth so that the slap attack covers up any delay in the triggering of synth sounds.

Controller and Switch

After connection and setup is finished, try to play your bass guitar.

● Play a synth sound only

- Set the output select switch to the SYNTH position
- Use the VOL knob to control the synth volume. Turn the knob right to increase the volume and left to decrease.
- The UP/DOWN buttons can be used to select different synthesizer voices and other functions on the Guitar MIDI Converter. If you are using the G50, you can increase or decrease, by a value of one, Program Memory Numbers, Parameter Values, Program Numbers, and Octave Shift Values. Refer to the Guitar MIDI Converter manual for more information.

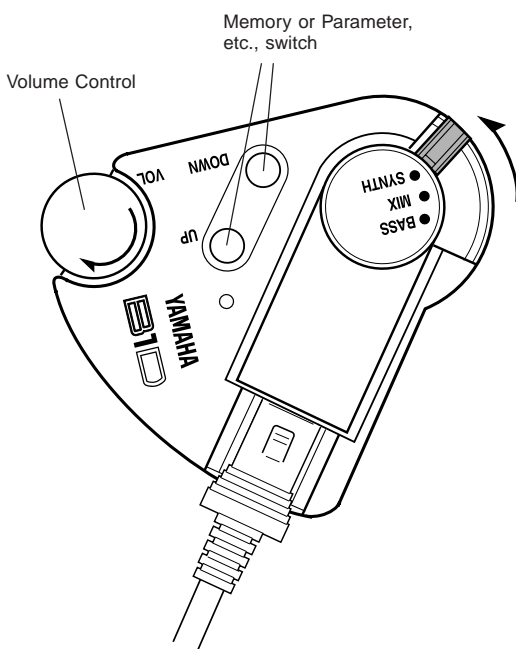

● Play the Bass Guitar sound only.

- Set the output select switch to the BASS position.
- The bass direct signal volume will not change even if the VOL knob is turned.

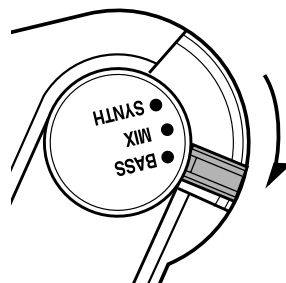

● Play the Bass Guitar and Synth sounds together.

- Set the output select switch to the MIX position.
- Turning the VOL knob changes the synthesizer volume only. The bass guitar's volume will not change.
- The UP/DOWN buttons function is identical to that described in the “Play a synth sound only” section above.

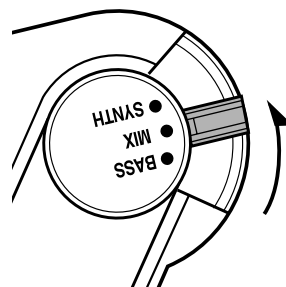

Getting the most out of your B1D & G50

Please use the following functions to get the most out of your B1D and G50.

What playing style will you use?

Set the G50's [A: Playing Style] to the "P i c" (pick) setting if you are going to play with your fingers. When using a pick, as long as you use a firm attack, not letting the pick "slide" over the strings, there should be no problems.

If you are going to use a slap technique, set the [A: Playing Style] to the "S L P" (slap) setting. However, it is recommended that you mix the direct bass sound with the synth so that the slap attack covers up any delay in the triggering of synth sounds.

Also, the synth sound is sometimes delayed due to the difficulties in accurately processing the slap attack, it is recommended that a "sweep" type of synth sound be used to provide a better overall sound (→ Refer to the G50 owner's manual: pg. 14).

Can you adjust the dynamics?

Set the G50's [D: Velocity] setting according to the type of sound you will be using. The following settings are possible, "n a r" (narrow), "n o r" (normal), "w i d e" (wide), "f i x e d" (fixed). The velocity setting specifies how the G50 will control the dynamic range of your playing style.

When programming data for a sequencer "n a r" or "f i x e d" settings will keep velocity data to an average.

Also, the "w i d e" setting can be used in conjunction with a velocity switch to change synth sounds with velocity (→ Refer to the G50 owner's manual: pg. 14).

Do you want to decrease pitch bend data going to the sequencer?

Set the G50's [E: Chromatic] setting to "o n" or "o f f". Or set the [G: Pitch Bend Range] setting to "o" and pitch bend data will not be produced at all (→ Refer to the G50 owner's manual: pgs. 14-15).

Can you control the synthesizer's attack and release?

By setting one of the G50's control numbers as follows [M(O): Assignable Control Number] to "73" (Attack Time) or to "72" (Release Time), you can control the parameter with [N(P): Assignable Control Value]. Value: 0 (Short) - 64 (Factory Default) - 127 (Long) (→ Refer to pg. 16 in the G50 Owner's Manual).

Depending on the type of tone generator, it may be impossible to carry out some control changes. If that is the case, the Attack and Release Times should be set on the tone generator itself.

Do you use a fretless bass?

You can use a fretless bass as well as fretted one. If you set the G50's [E: Chromatic] setting to "o f f", the sensitivity and unique pitch characteristics of the fretless bass will be accurately reproduced by the G50 (→ Refer to the G50 owner's manual: pgs. 14-15).

How can you effectively use the Split Mode functions?

As an example, you can play a slap bass tone on the first and second strings, and a fingered bass tone on the third and fourth strings, each style (or string) can be assigned sounds. You can get the best characteristics out of each style (or strings) by assigning different tones to different strings (→ Refer to the G50 owner's manual: pg. 17).

How can you effectively use the Split Mode in relation to picking position.

As an example, you can set up your bass so that by playing in the normal picking position you can play a fingered bass tone, and playing closer to the bridge you can play a slap bass tone, and switch between the two sounds by just changing your playing position (→ Refer to the G50 owner's manual : pg. 16 [Q: Split]). Program change data is transmitted when the split mode is active (when the tone is changed), and this data can be used with a sequencer as well.

How can you effectively use the Picking Position Control function?

If you set the G50's [H: Program Number] to a synth bass tone, and set the [T: Picking Position Control] to "74" (filter cut-off frequency), you can create a techno-bass tone (→ Refer to the G50 owner's manual: pg. 17).

How can you effectively use the Touch Control function?

If you set the G50's [H: Program Number] to a synth bass tone, and set the [W: Touch Control] to "74" (filter cut-off frequency), you can create a synth-bass tone (→ Refer to the G50 owner's manual: pg. 17).

How can you effectively use the Sustain 2 function?

Use a non-decaying tone, pluck and hold the lowest string (multiple strings can also be held), and you can play a melody on the other strings while the low string pitch sustains (→ Refer to the G50 owner's manual: pg. 18).

How can you effectively use the Hold function?

Use a non-decaying tone, play a chord and hold it, play a melody with a different tone while the chord holds. Also, by assigning an [H: Program Number] program that is set to "o f f", to the [Y: Sustain/Hold Pedal] you can hold a chord and play the direct bass sound over the chord (→ Refer to the G50 owner's manual: pg. 18).

Is the direct bass sound, coming from the G50, inferior?

The B1D has an internal buffer so there should be no problems with noise, but variations in signal levels may make the sound produced by the G50 may be a little louder or softer than the bass's direct sound.

Troubleshooting

If you think there may be a problem with your B1D and G50, first check the information below for a possible solution. If that does not solve the problem, contact the nearest Yamaha dealer or the music store where you purchased the device.

Low pitches produce no sound.

→ Is the GUITAR/BASS selector switch on the rear panel of the G50 set to BASS? (→ pg. 14).

Multiple notes sound.

→ If the string vibrates against a fret other, than the one being fretted, the resulting noise may interfere with the pitch being played. Try readjusting the neck of your bass guitar or adjust the string height to eliminate unwanted noise.

→ Are the strings coming into contact with the divided pickup? Adjust the height of the pickup (→ pg. 7).

→ Is the G50 Input Level set too high? Try lowering the Input Gain Level (→ pg. 7 & 14).

→ Are your fingernails hitting a string or do you rub the pick against a string? If you play hard you may get multiple notes even if the Play Style is set to the “SLP” (slap) mode.

→ Is the G50 [G: Pitch Bend Range] setting set to “0”? Try setting it to “12” (→ G50 owner’s manual: pg. 15).

Strings sound without being played.

→ Is the G50 Input Level set too high? You can control the problem using the G50 [B: Note ON Level] but, first try lowering the Input Gain Level (→ pg. 7 & 14. Also, the G50 owner’s manual: pg. 14).

The 5th and 7th fret harmonics sound.

→ If the G50’s Input Level is set too high, harmonics will easily be picked up by the pickup. Try lowering the Input Gain Level (→ pg. 7 & 14).

→ Harmonics are easily produced if the string is fretted exactly on top of the fret and then the finger is removed from the string. Try fretting the string slightly behind the fret.

The pitch is off.

→ Are the strings coming into contact with the divided pickup? Adjust the height of the pickup (→ pg. 7).

→ Is the G50’s Input Level set too high? Try lowering the Input Gain Level (→pg. 7 & 14).

→ Properly tune the bass guitar. Also, make sure the frets are properly tuned. If the G50 [E: Chromatic] setting is set to “0n”, pitch bend can only be done in half-tone increments, even using the “12” setting, if the bass guitar’s pitch is slightly off, that pitch will be used as the center of the pitch bend (→ G50 owner’s manual: pg. 14).

→ If the G50 [G: Pitch Bend Range] and the pitch bend range setting on the tone generator differs, the pitch will be off. When you change programs with the G50, the program’s pitch bend range data is transmitted to the tone generator but, depending upon the type of tone generator, pitch bend range data may not be received. In that case, the pitch bend range should be set on the tone generator itself.

If you send data to a MIDI sequencer, the pitch bend range and pitch bend center information must be set in the very beginning of the song in order for the sequencer to play back at the correct pitch.

→ Depending upon the type of tone (piano, etc.) you are using, pitch bends may not match well. In that case try setting the G50 [E: Chromatic] to “0n” or, [G: Pitch Bend Range] to “0” (→ G50 owner’s manual: pg. 14).

Vibrato is not detected.

→ Set the G50 [E: Chromatic] setting to “FFF”. If it is set to “0n”, pitch bend will only change the pitch by half-tone increments or decrements. If it is set to “12” it will be hard to detect the slight variations of the vibrato pitch (→ G50 owner’s manual: pg. 14).

The pitch lowers a half-step when your finger is removed from the fret.

→ When you play the bass directly, the same thing happens, it’s just that the sound fades so quickly that you don’t notice. This problem often occurs when tones with a long release time are used. If that is the case, try setting the G50 [E: Chromatic] to “0n” and [G: Pitch Bend Range] to “12”. Or, try setting the [G: Pitch Bend Range] to “0”.

When you glissando, new notes are triggered as you slide up the neck.

→ If the range set in [G: Pitch Bend Range] is exceeded, a new note on will be produced. Change the range value (→ G50 owner’s manual: pg. 15).

→ Is the G50’s Input Level set too high? Try lowering the Input Gain Level (→pg. 7 & 14). Or, play a note softly before you glissando.

Specifications

● Main Function

- Synthesizer Volume Knob
- Output Selector Switch (BASS/MIX/SYNTH)
- UP/DOWN Buttons
- Power Indicator
- Divided Pickup (6-string independent)
- Direct Bass Guitar Input Jack
- B1D Output Jack (Divided Pickup + Bass Guitar Signal)

● Package Contents

- Direct Bass Guitar Cable (1/4" mono phone
←→ mono mini-plug)
- Hardware Parts for Installation

● Bass Guitar String Spacing

- 4-string : 17-20mm (0.67"-0.79")
- 5-string : 18-20mm (0.71"-0.78")
- 6-string : 18-19mm (0.71"-0.75")

● Weight

78 g (2 lbs.12oz)

● Dimensions (W x D x H)

85.1mm x 75.9mm x 28.8mm
(3-3/8" x 2-15/16" x 1-1/8")

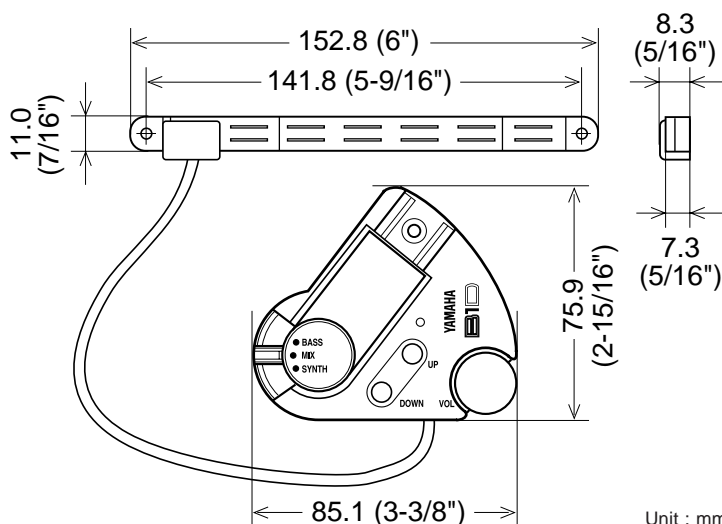

Unit : mm (inch)

YAMAHA GUITAR MIDI CONVERTER

G50

The G50 is a high-performance Guitar MIDI Converter designed to work in conjunction with the Yamaha B1D Divided Pickup Unit installed on an electric or steel-string acoustic guitar. The G50 offers unprecedented MIDI guitar synthesizer performance with exceptionally fast response and a range of advanced features that bring the true creative potential of MIDI control to guitar players for the first time.



YAMAHA ELECTRIC BASSES

TRB

Close interaction between Yamaha and some today's leading artists lead to the development the TRB line. These 4-, 5-, and 6-string basses reflect the growing needs of today's discriminating bassists. Each is a statement of quality craftsmanship and technological vision that offers unmatched sound and playability.



TRB-4
Natural Satin



TRB-6
Cherry Sunburst

For details of products, please contact your nearest Yamaha or the authorized distributor listed below.

Pour plus de détails sur les produits, veuillez-vous adresser à Yamaha ou au distributeur le plus proche de vous figurant dans la liste suivante.

Die Einzelheiten zu Produkten sind bei Ihrer unten aufgeführten Niederlassung und bei Yamaha Vertragshändlern in den jeweiligen Bestimmungsländern erhältlich.

Para detalles sobre productos, contacte su tienda Yamaha más cercana o el distribuidor autorizado que se lista debajo.

NORTH AMERICA

CANADA

Yamaha Canada Music Ltd.
135 Milner Avenue, Scarborough, Ontario,
M1S 3R1, Canada
Tel: 416-298-1311

U.S.A.

Yamaha Corporation of America
6600 Orangethorpe Ave., Buena Park, Calif.
90620, U.S.A.
Tel: 714-522-9011

MIDDLE & SOUTH AMERICA

MEXICO

**Yamaha De Mexico S.A. De C.V.,
Departamento de ventas**
Javier Rojo Gomez No.1149, Col. Gpe Del
Moral, Deleg. Iztapalapa, 09300 Mexico, D.F.
Tel: 686-00-33

BRASIL

Yamaha Musical Do Brasil LTDA.
Ave. Reboucas 2636, São Paulo, Brasil
Tel: 011-853-1377

PANAMA

Yamaha De Panama S.A.
Edificio Interseco, Calle Elvira Mendez no.10,
Piso 3, Oficina #105, Ciudad de Panama, Panama
Tel: 507-69-5311

OTHER LATIN AMERICAN COUNTRIES AND CARIBBEAN COUNTRIES

Yamaha Music Latin America Corp.
6101 Blue Lagoon Drive, Miami, Florida 33126,
U.S.A.
Tel: 305-261-4111

EUROPE

THE UNITED KINGDOM

Yamaha-Kemble Music (U.K.) Ltd.
Sherbourne Drive, Tilbrook, Milton Keynes,
MK7 8BL, England
Tel: 01908-366700

IRELAND

Danfay Ltd.
61D, Sallynoggin Road, Dun Laoghaire, Co. Dublin
Tel: 01-2859177

GERMANY/SWITZERLAND

Yamaha Europa GmbH.
Siemensstraße 22-34, 25462 Rellingen,
F.R. of Germany
Tel: 04101-3030

AUSTRIA

Yamaha Music Austria
Schleiergasse 20, A-1100 Wien Austria
Tel: 0222-60203900

THE NETHERLANDS

Yamaha Music Nederland
Kanaalweg 18G, 3526KL, Utrecht, The Netherlands
Tel: 030-2828411

BELGIUM

Yamaha Music Belgium
Keiberg Imperiastraat 8, 1930 Zaventem, Belgium
Tel: 02-7258220

FRANCE

**Yamaha Musique France,
Division Professionnelle**
BP 70-77312 Marne-la-Vallée Cedex 2, France
Tel: 01-64-61-4000

ITALY

**Yamaha Musica Italia S.P.A.,
Combo Division**
Viale Italia 88, 20020 Lainate (Milano), Italy
Tel: 02-935-771

SPAIN

Yamaha-Hazen Electronica Musical, S.A.
Jorge Juan 30, 28001, Madrid, Spain
Tel: 91-577-7270

PORTUGAL

Valentim de Carvalho CI SA
Estrada de Porto Salvo, Paço de Arcos 2780
Oeiras, Portugal
Tel: 01-443-3398/4030/1823

GREECE

Philippe Nakas S.A.
Navarinou Street 13, P.Code 10680, Athens,
Greece
Tel: 01-364-7111

SWEDEN

Yamaha Scandinavia AB
J. A. Wettergrens Gata 1, Box 30053
S-400 43 Göteborg, Sweden
Tel: 031 89 34 00

DENMARK

YS Copenhagen Liaison Office
Generatorvej 8B, DK-2730 Herlev, Denmark
Tel: 44 92 49 00

FINLAND

Warner Music Finland OY/Fazer Music
Aleksanterinkatu 11, P.O. Box 260
SF-00101 Helsinki, Finland
Tel: 0435 011

NORWAY

Narud Yamaha AS
Grini Næringspark 17, N-1345 Østerås, Norway
Tel: 67 14 47 90

ICELAND

Skeifan HF
Skeifan 17 P.O. Box 8120
IS-128 Reykjavik, Iceland
Tel: 525 5000

OTHER EUROPEAN COUNTRIES

Yamaha Europa GmbH.
Siemensstraße 22-34, 25462 Rellingen, F.R. of
Germany
Tel: 04101-3030

AFRICA

**Yamaha Corporation,
International Marketing Division**
Nakazawa-cho 10-1, Hamamatsu, Japan 430
Tel: 053-460-2312

MIDDLE EAST

TURKEY/CYPRUS

Yamaha Europa GmbH.
Siemensstraße 22-34, 25462 Rellingen,
F.R. of Germany
Tel: 04101-3030

OTHER COUNTRIES

**Yamaha Corporation,
International Marketing Division**
Nakazawa-cho 10-1, Hamamatsu, Japan 430
Tel: 053-460-2312

ASIA

HONG KONG

Tom Lee Music Co., Ltd.
11/F., Silvercord Tower 1, 30 Canton Road,
Tsimshatsui, Kowloon, Hong Kong
Tel: 730-1098

INDONESIA

**PT. Yamaha Music Indonesia (Distributor)
PT. Nusantik**
Gedung Yamaha Music Center, Jalan Jend. Gatot
Subroto Kav. 4, Jakarta 12930, Indonesia
Tel: 21-520-2577

KOREA

Cosmos Corporation
#131-31, Neung-Dong, Sungdong-Ku, Seoul
Korea
Tel: 02-466-0021-5

MALAYSIA

Yamaha Music Malaysia, Sdn., Bhd.
16-28, Jalan SS 2/72, Petaling Jaya, Selangor,
Malaysia
Tel: 3-717-8977

PHILIPPINES

Yupangco Music Corporation
339 Gil J. Puyat Avenue, P.O. Box 885 MCPO,
Makati, Metro Manila, Philippines
Tel: 819-7551

SINGAPORE

Yamaha Music Asia Pte., Ltd.
Blk 17A Toa Payoh #01-190 Lorong 7
Singapore 1231
Tel: 354-0133

TAIWAN

Kung Hsue She Trading Co., Ltd.
No. 322, Section 1, Fu Hsing S. Road,
Taipei 106, Taiwan. R.O.C.
Tel: 02-709-1266

THAILAND

Siam Music Yamaha Co., Ltd.
865 Phornprapha Building, Rama I Road,
Patumwan, Bangkok 10330, Thailand
Tel: 2-215-3443

THE PEOPLE'S REPUBLIC OF CHINA AND OTHER ASIAN COUNTRIES

**Yamaha Corporation,
International Marketing Division**
Nakazawa-cho 10-1, Hamamatsu, Japan 430
Tel: 053-460-2317

OCEANIA

AUSTRALIA

Yamaha Music Australia Pty. Ltd.
17-33 Market Street, South Melbourne, Vic.
3205, Australia
Tel: 3-699-2388

NEW ZEALAND

Music Houses of N.Z. Ltd.
146/148 Captain Springs Road, Te Papapa,
Auckland, New Zealand
Tel: 9-634-0099

COUNTRIES AND TRUST TERRITORIES IN PACIFIC OCEAN

**Yamaha Corporation,
International Marketing Division**
Nakazawa-cho 10-1, Hamamatsu, Japan 430
Tel: 053-460-2317

HEAD OFFICE Yamaha Corporation, Electronic Musical Instrument Division

Nakazawa-cho 10-1, Hamamatsu, Japan 430
Tel: 053-460-2445

YAMAHA

B10
DIVIDED PICKUP UNIT

**Owner's Manual
Bedienungsanleitung
Mode d'emploi**

