



RX-V457

AV Receiver

OWNER'S MANUAL

IMPORTANT SAFETY INSTRUCTIONS

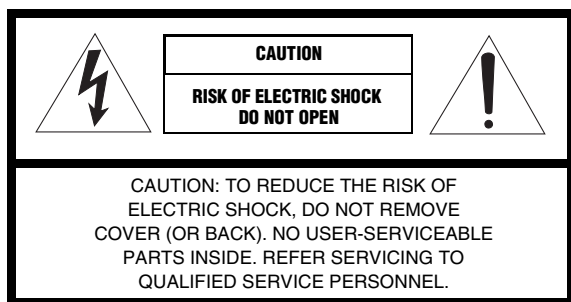

• Explanation of Graphical Symbols



The lightning flash with arrowhead symbol, within an equilateral triangle, is intended to alert you to the presence of uninsulated “dangerous voltage” within the product’s enclosure that may be of sufficient magnitude to constitute a risk of electric shock to persons.



The exclamation point within an equilateral triangle is intended to alert you to the presence of important operating and maintenance (servicing) instructions in the literature accompanying the appliance.

- 1** Read Instructions – All the safety and operating instructions should be read before the product is operated.
 - 2** Retain Instructions – The safety and operating instructions should be retained for future reference.
 - 3** Heed Warnings – All warnings on the product and in the operating instructions should be adhered to.
 - 4** Follow Instructions – All operating and use instructions should be followed.
 - 5** Cleaning – Unplug this product from the wall outlet before cleaning. Do not use liquid cleaners or aerosol cleaners. Use a damp cloth for cleaning.
 - 6** Attachments – Do not use attachments not recommended by the product manufacturer as they may cause hazards.
 - 7** Water and Moisture – Do not use this product near water – for example, near a bath tub, wash bowl, kitchen sink, or laundry tub; in a wet basement; or near a swimming pool; and the like.
 - 8** Accessories – Do not place this product on an unstable cart, stand, tripod, bracket, or table. The product may fall, causing serious injury to a child or adult, and serious damage to the product. Use only with a cart, stand, tripod, bracket, or table recommended by the manufacturer, or sold with the product. Any mounting of the product should follow the manufacturer’s instructions, and should use a mounting accessory recommended by the manufacturer.
 - 9** A product and cart combination should be moved with care. Quick stops, excessive force, and uneven surfaces may cause the product and cart combination to overturn.
- 
- 10** Ventilation – Slots and openings in the cabinet are provided for ventilation and to ensure reliable operation of the product and to protect it from overheating, and these openings must not be blocked or covered. The openings should never be blocked by placing the product on a bed, sofa, rug, or other similar surface. This product should not be placed in a built-in installation such as a bookcase or rack unless proper ventilation is provided or the manufacturer’s instructions have been adhered to.
 - 11** Power Sources – This product should be operated only from the type of power source indicated on the marking label. If you are not sure of the type of power supply to your home, consult your product dealer or local power company. For products intended to operate from battery power, or other sources, refer to the operating instructions.
 - 12** Grounding or Polarization – This product may be equipped with a polarized alternating current line plug (a plug having one blade wider than the other). This plug will fit into the power outlet only one way. This is a safety feature. If you are unable to insert the plug fully into the outlet, try reversing the plug. If the plug should still fail to fit, contact your electrician to replace your obsolete outlet. Do not defeat the safety purpose of the polarized plug.
 - 13** Power-Cord Protection – Power-supply cords should be routed so that they are not likely to be walked on or pinched by items placed upon or against them, paying particular attention to cords at plugs, convenience receptacles, and the point where they exit from the product.
 - 14** Lightning – For added protection for this product during a lightning storm, or when it is left unattended and unused for long periods of time, unplug it from the wall outlet and disconnect the antenna or cable system. This will prevent damage to the product due to lightning and power-line surges.
 - 15** Power Lines – An outside antenna system should not be located in the vicinity of overhead power lines or other electric light or power circuits, or where it can fall into such power lines or circuits. When installing an outside antenna system, extreme care should be taken to keep from touching such power lines or circuits as contact with them might be fatal.
 - 16** Overloading – Do not overload wall outlets, extension cords, or integral convenience receptacles as this can result in a risk of fire or electric shock.
 - 17** Object and Liquid Entry – Never push objects of any kind into this product through openings as they may touch dangerous voltage points or short-out parts that could result in a fire or electric shock. Never spill liquid of any kind on the product.
 - 18** Servicing – Do not attempt to service this product yourself as opening or removing covers may expose you to dangerous voltage or other hazards. Refer all servicing to qualified service personnel.
 - 19** Damage Requiring Service – Unplug this product from the wall outlet and refer servicing to qualified service personnel under the following conditions:
 - a)** When the power-supply cord or plug is damaged,
 - b)** If liquid has been spilled, or objects have fallen into the product,
 - c)** If the product has been exposed to rain or water,

- d) If the product does not operate normally by following the operating instructions. Adjust only those controls that are covered by the operating instructions as an improper adjustment of other controls may result in damage and will often require extensive work by a qualified technician to restore the product to its normal operation,
 - e) If the product has been dropped or damaged in any way, and
 - f) When the product exhibits a distinct change in performance - this indicates a need for service.
- 20 Replacement Parts** – When replacement parts are required, be sure the service technician has used replacement parts specified by the manufacturer or have the same characteristics as the original part. Unauthorized substitutions may result in fire, electric shock, or other hazards.
- 21 Safety Check** – Upon completion of any service or repairs to this product, ask the service technician to perform safety checks to determine that the product is in proper operating condition.
- 22 Wall or Ceiling Mounting** – The unit should be mounted to a wall or ceiling only as recommended by the manufacturer.
- 23 Heat** – The product should be situated away from heat sources such as radiators, heat registers, stoves, or other products (including amplifiers) that produce heat.

24 Outdoor Antenna Grounding – If an outside antenna or cable system is connected to the product, be sure the antenna or cable system is grounded so as to provide some protection against voltage surges and built-up static charges. Article 810 of the National Electrical Code, ANSI/NFPA 70, provides information with regard to proper grounding of the mast and supporting structure, grounding of the lead-in wire to an antenna discharge unit, size of grounding conductors, location of antenna discharge unit, connection to grounding electrodes, and requirements for the grounding electrode.

EXAMPLE OF ANTENNA GROUNDING

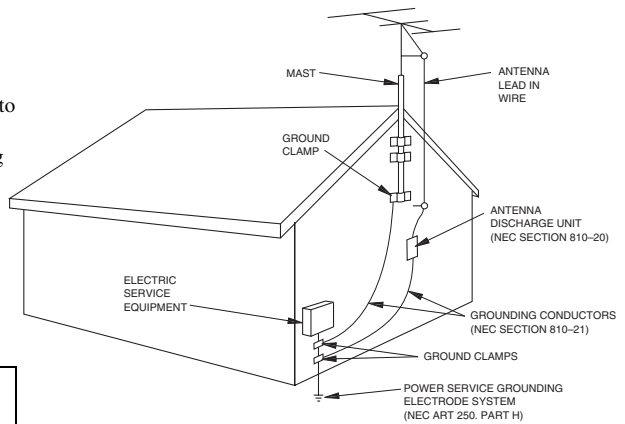

Note to CATV system installer:

This reminder is provided to call the CATV system installer’s attention to Article 820-40 of the NEC that provides guidelines for proper grounding and, in particular, specifies that the cable ground shall be connected to the grounding system of the building, as close to the point of cable entry as practical.

FCC INFORMATION (for US customers)

1 IMPORTANT NOTICE: DO NOT MODIFY THIS UNIT!

This product, when installed as indicated in the instructions contained in this manual, meets FCC requirements. Modifications not expressly approved by Yamaha may void your authority, granted by the FCC, to use the product.

2 IMPORTANT: When connecting this product to accessories and/or another product use only high quality shielded cables. Cable/s supplied with this product **MUST** be used. Follow all installation instructions. Failure to follow instructions could void your FCC authorization to use this product in the USA.

3 NOTE: This product has been tested and found to comply with the requirements listed in FCC Regulations, Part 15 for Class “B” digital devices. Compliance with these requirements provides a reasonable level of assurance that your use of this product in a residential environment will not result in harmful interference with other electronic devices.

This equipment generates/uses radio frequencies and, if not installed and used according to the instructions found in the users manual, may cause interference harmful to the operation of other electronic devices.

Compliance with FCC regulations does not guarantee that interference will not occur in all installations. If this product is found to be the source of interference, which can be determined by turning the unit “OFF” and “ON”, please try to eliminate the problem by using one of the following measures:

Relocate either this product or the device that is being affected by the interference.

Utilize power outlets that are on different branch (circuit breaker or fuse) circuits or install AC line filter/s.

In the case of radio or TV interference, relocate/reorient the antenna. If the antenna lead-in is 300 ohm ribbon lead, change the lead-in to coaxial type cable.

If these corrective measures do not produce satisfactory results, please contact the local retailer authorized to distribute this type of product. If you can not locate the appropriate retailer, please contact Yamaha Electronics Corp., U.S.A. 6660 Orangethorpe Ave, Buena Park, CA 90620.

The above statements apply **ONLY** to those products distributed by Yamaha Corporation of America or its subsidiaries.

CAUTION: READ THIS BEFORE OPERATING YOUR UNIT.

- 1 To assure the finest performance, please read this manual carefully. Keep it in a safe place for future reference.
- 2 Install this sound system in a well ventilated, cool, dry, clean place – away from direct sunlight, heat sources, vibration, dust, moisture, and/or cold. Allow ventilation space of at least 30 cm on the top, 20 cm on the left and right, and 20 cm on the back of this unit.
- 3 Locate this unit away from other electrical appliances, motors, or transformers to avoid humming sounds.
- 4 Do not expose this unit to sudden temperature changes from cold to hot, and do not locate this unit in a environment with high humidity (i.e. a room with a humidifier) to prevent condensation inside this unit, which may cause an electrical shock, fire, damage to this unit, and/or personal injury.
- 5 Avoid installing this unit where foreign object may fall onto this unit and/or this unit may be exposed to liquid dripping or splashing. On the top of this unit, do not place:
 - Other components, as they may cause damage and/or discoloration on the surface of this unit.
 - Burning objects (i.e. candles), as they may cause fire, damage to this unit, and/or personal injury.
 - Containers with liquid in them, as they may fall and liquid may cause electrical shock to the user and/or damage to this unit.
- 6 Do not cover this unit with a newspaper, tablecloth, curtain, etc. in order not to obstruct heat radiation. If the temperature inside this unit rises, it may cause fire, damage to this unit, and/or personal injury.
- 7 Do not plug in this unit to a wall outlet until all connections are complete.
- 8 Do not operate this unit upside-down. It may overheat, possibly causing damage.
- 9 Do not use force on switches, knobs and/or cords.
- 10 When disconnecting the power cord from the wall outlet, grasp the plug; do not pull the cord.
- 11 Do not clean this unit with chemical solvents; this might damage the finish. Use a clean, dry cloth.
- 12 Only voltage specified on this unit must be used. Using this unit with a higher voltage than specified is dangerous and may cause fire, damage to this unit, and/or personal injury. YAMAHA will not be held responsible for any damage resulting from use of this unit with a voltage other than specified.
- 13 To prevent damage by lightning, disconnect the power cord from the wall outlet during an electrical storm.
- 14 Do not attempt to modify or fix this unit. Contact qualified YAMAHA service personnel when any service is needed. The cabinet should never be opened for any reasons.
- 15 When not planning to use this unit for long periods of time (i.e. vacation), disconnect the AC power plug from the wall outlet.
- 16 Be sure to read the “TROUBLESHOOTING” section on common operating errors before concluding that this unit is faulty.
- 17 Before moving this unit, press STANDBY/ON to set this unit in the standby mode, and disconnect the AC power plug from the wall outlet.
- 18 VOLTAGE SELECTOR (Asia and General models only)

The VOLTAGE SELECTOR on the rear panel of this unit must be set for your local main voltage BEFORE plugging into the AC main supply. Voltages are:

Asia model 220/230–240 V AC, 50/60 Hz
General model
.....110/120/220/230–240 V AC, 50/60 Hz

WARNING

TO REDUCE THE RISK OF FIRE OR ELECTRIC SHOCK, DO NOT EXPOSE THIS UNIT TO RAIN OR MOISTURE.

This unit is not disconnected from the AC power source as long as it is connected to the wall outlet, even if this unit itself is turned off. This state is called the standby mode. In this state, this unit is designed to consume a very small quantity of power.

FOR CANADIAN CUSTOMERS

To prevent electric shock, match wide blade of plug to wide slot and fully insert.
This Class B digital apparatus complies with Canadian ICES-003.

IMPORTANT

Please record the serial number of this unit in the space below.
MODEL:
Serial No.:
The serial number is located on the rear of the unit.
Retain this Owner’s Manual in a safe place for future reference.

We Want You Listening For A Lifetime

YAMAHA and the Electronic Industries Association’s Consumer Electronics Group want you to get the most out of your equipment by playing it at a safe level. One that lets the sound come through loud and clear without annoying blaring or distortion – and, most importantly, without affecting your sensitive hearing.

Since hearing damage from loud sounds is often undetectable until it is too late, YAMAHA and the Electronic Industries Association’s Consumer Electronics Group recommend you to avoid prolonged exposure from excessive volume levels.



CONTENTS

INTRODUCTION

FEATURES	2
GETTING STARTED	3
Supplied accessories	3
Installing batteries in the remote control	3
CONTROLS AND FUNCTIONS	4
Front panel	4
Remote control.....	6
Using the remote control	7
Front panel display	8
Rear panel	10

PREPARATION

SPEAKER SETUP	11
Speaker placement	11
Speaker connections	12
CONNECTIONS	14
Before connecting components.....	14
Connecting video components.....	15
Connecting audio components.....	18
Connecting the FM and AM antennas	19
Connecting the power supply cord	20
Speaker impedance setting	21
Turning on the power.....	21
BASIC SETUP	22
Using the BASIC SETUP menu	22

BASIC OPERATION

PLAYBACK	25
Basic operations.....	25
Selecting sound field programs	27
Selecting input modes.....	31
FM/AM TUNING	33
Automatic and manual tuning.....	33
Presetting stations	34
Selecting preset stations.....	36
Exchanging preset stations	37
XM SATELLITE RADIO TUNING	39
What is XM Satellite Radio?	39
XM Satellite Radio connections	39
XM Satellite Radio functions	39
Activating XM Satellite Radio	40
Basic XM Satellite Radio operations.....	41
XM Satellite Radio search modes.....	42
Setting XM Satellite Radio preset channels	45
RECORDING	48

SOUND FIELD PROGRAMS

SOUND FIELD PROGRAM DESCRIPTIONS	49
For movie/video sources.....	49
For music sources	51

ADVANCED OPERATION

ADVANCED OPERATIONS	52
Using the sleep timer	52
Manually adjusting speaker levels.....	53
SET MENU	54
Using SET MENU.....	55
1 SOUND MENU.....	56
2 INPUT MENU.....	58
3 OPTION MENU.....	59
ADVANCED SETUP MENU	61
REMOTE CONTROL FEATURES	63
Control area	63
Setting remote control codes	64
Controlling other components	65
Switching library codes	66
Clearing set up remote control codes.....	66

ADDITIONAL INFORMATION

EDITING SOUND FIELD PARAMETERS	67
What is a sound field	67
Changing parameter settings	67
SOUND FIELD PARAMETER DESCRIPTIONS	69
TROUBLESHOOTING	71
RESETTING THE FACTORY PRESETS	75
GLOSSARY	76
Audio formats	76
Sound field programs.....	77
Audio information	77
Video signal information	78
SPECIFICATIONS	79

INTRODUCTION

PREPARATION

BASIC OPERATION

SOUND FIELD PROGRAMS

ADVANCED OPERATION

ADDITIONAL INFORMATION

FEATURES

Built-in 6-channel power amplifier

- ◆ Minimum RMS output power (0.06% THD, 20 Hz to 20 kHz, 8 Ω)
Front: 85 W + 85 W
Center: 85 W
Surround: 85 W + 85 W
Surround back: 85 W

Sound field features

- ◆ Proprietary YAMAHA technology for the creation of sound fields
- ◆ Dolby Digital/Dolby Digital EX decoder
- ◆ DTS/DTS-ES Matrix 6.1, Discrete 6.1, DTS Neo:6, DTS 96/24 decoder
- ◆ Dolby Pro Logic/Dolby Pro Logic II/Dolby Pro Logic IIx decoder
- ◆ Virtual CINEMA DSP
- ◆ SILENT CINEMA™

Sophisticated AM/FM tuner

- ◆ 40-station random and direct preset tuning
- ◆ Automatic preset tuning
- ◆ Preset station shifting capability (preset editing)

XM Satellite Radio

- ◆ XM Satellite Radio programming (using the “XM Connect and Play digital antenna accessory”, sold separately)

Other features

- ◆ 192-kHz/24-bit D/A converter
- ◆ A SET MENU that provides you with items for optimizing this unit for your audio/video system
- ◆ 6 additional input jacks for discrete multi-channel input
- ◆ S-video signal input/output capability
- ◆ Component video input/output capability
- ◆ Optical and coaxial digital audio signal jacks
- ◆ Sleep timer
- ◆ Cinema and music night listening modes
- ◆ Remote control with preset remote control codes

-  indicates a tip for your operation.
- Some operations can be performed by using either the buttons on the main unit or on the remote control. In cases when the button names differ between the main unit and the remote control, the button name on the remote control is given in parentheses.
- This manual is printed prior to production. Design and specifications are subject to change in part as a result of improvements, etc. In case of differences between the manual and product, the product has priority.



Manufactured under license from Dolby Laboratories.
“Dolby”, “Pro Logic”, “Surround EX”, and the double-D symbol are trademarks of Dolby Laboratories.

SILENT™
CINEMA

“SILENT CINEMA” is a trademark of YAMAHA CORPORATION.



“DTS”, “DTS-ES”, “Neo:6” and “DTS 96/24” are trademarks of Digital Theater Systems, Inc.



The XM name and related logos are registered trademarks of XM Satellite Radio Inc.

GETTING STARTED

Supplied accessories

Please check that you received all of the following parts.

Remote control

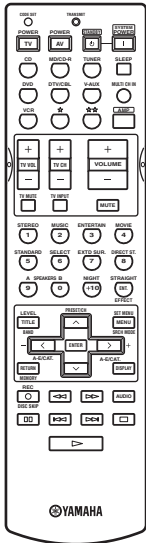

**Batteries (4)
(AAA, R03, UM-4)**

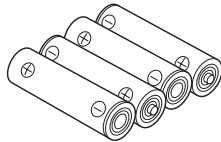

AM loop antenna

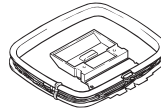

**75-ohm/300-ohm antenna
adapter (U.K. model only)**

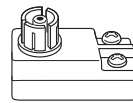

**Indoor FM antenna
(U.S.A., Canada, China, Asia
and General models)**

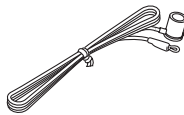

**Indoor FM antenna
(U.K., Europe, Australia
and Korea models)**

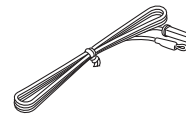

Installing batteries in the remote control

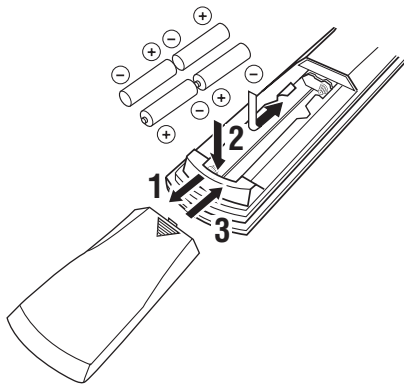

1 Press the ▼ part and slide the battery compartment cover off.

2 Insert four supplied batteries (AAA, R03, UM-4) according to the polarity markings (+ / -) on the inside of the battery compartment.

3 Slide the cover back until it snaps into place.

Notes on batteries

- Change all of the batteries if you notice the following conditions; the operation range of the remote control decreases, the indicator does not flash or its light becomes dim.
- Do not use old batteries together with new ones.
- Do not use different types of batteries (such as alkaline and manganese batteries) together. Read the packaging carefully as these different types of batteries may have the same shape and color.
- If the batteries have leaked, dispose of them immediately. Avoid touching the leaked material or letting it come into contact with clothing, etc. Clean the battery compartment thoroughly before installing new batteries.
- Do not throw away batteries with general house waste; dispose of them correctly in accordance with your local regulations.

If the remote control is without batteries for more than 2 minutes, or if exhausted batteries remain in the remote control, the contents of the memory may be cleared. When the memory is cleared, insert new batteries, set up the remote control code and program any acquired functions that may have been cleared.

CONTROLS AND FUNCTIONS

Front panel

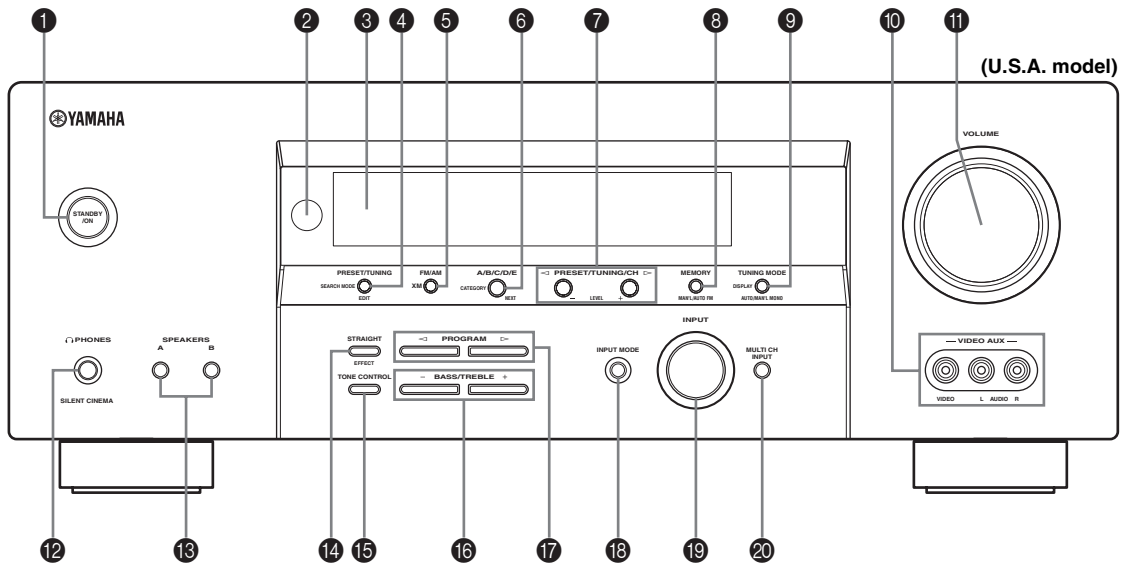

1 STANDBY/ON

Turns on this unit or sets it to the standby mode. When you turn on this unit, you will hear a click and there will be a 4 to 5-second delay before this unit can reproduce sound.

Note

In standby mode, this unit consumes a small amount of power in order to receive infrared-signals from the remote control.

2 Remote control sensor

Receives signals from the remote control.

3 Front panel display

Shows information about the operational status of this unit.

4 PRESET/TUNING (EDIT), SEARCH MODE*

Switches the function of PRESET/TUNING/CH <|/> (LEVEL -/+) between selecting preset station numbers and tuning.

5 FM/AM, XM*

Switches the reception band when the unit is in tuner mode.

6 A/B/C/D/E, NEXT, CATEGORY*

Selects one of the 5 preset station groups (A to E) when the unit is in tuner mode.

Selects the speaker channel to be adjusted when the unit is not in tuner mode.

7 PRESET/TUNING/ CH* <|/>, LEVEL -/+

Selects preset station number 1 to 8 when the colon (:) is displayed next to the band indication in the front panel display when the unit is in tuner mode. Selects the tuning frequency when the colon (:) is not displayed.

Adjusts the level of the speaker channel selected using A/B/C/D/E (NEXT) when the unit is not in tuner mode.

8 MEMORY (MAN'L/AUTO FM)

Stores a station in the memory. Hold down this button for more than 3 seconds to start automatic preset tuning.

9 TUNING MODE (AUTO/MAN'L MONO), DISPLAY*

Switches between automatic tuning (AUTO indicator on) and manual tuning (AUTO indicator off).

10 VIDEO AUX jacks

Input audio and video signals from a portable external source such as a game console. To reproduce source signals from these jacks, select V-AUX as the input source.

11 VOLUME

Controls the output level of all audio channels. This does not affect the REC OUT level.

12 PHONES (SILENT CINEMA) jack

Outputs audio signals for private listening with headphones. When you connect headphones, no signals are output to the OUTPUT jacks or to the speakers. All Dolby Digital and DTS audio signals are mixed down to the left and right headphone channels.

13 SPEAKERS A/B

Turns on or off the set of front speakers connected to the A and/or B terminals on the rear panel each time the corresponding button is pressed.

14 STRAIGHT (EFFECT)

Switches the sound fields off or on. When STRAIGHT is selected, input signals (2-channel or multi-channel) are output directly from their respective speakers without effect processing.

15 TONE CONTROL

Use to adjust the bass/treble balance for the front left and right speakers (see page 26).

16 BASS/TREBLE -/+

Use to adjust the bass/treble balance for the front left and right speakers (in conjunction with CONTROL).

17 PROGRAM ◀ / ▶

Use to select sound field programs (see page 26).

18 INPUT MODE

Sets the priority (AUTO, DTS, ANALOG) for the type of signals received when one component is connected to two or more of this unit's input jacks (see page 31).

19 INPUT selector

Selects the input source you want to listen to or watch.

20 MULTI CH INPUT

Selects the source connected to the MULTI CH INPUT jacks. When selected, the MULTI CH INPUT source takes priority over the source selected with INPUT (or the input selector buttons on the remote control).

* Available only when the unit is in the XM Satellite Radio mode (see page 39).

Remote control

This section describes the function of each control on the remote control used to control this unit. To operate other components, see “REMOTE CONTROL FEATURES” on page 63.

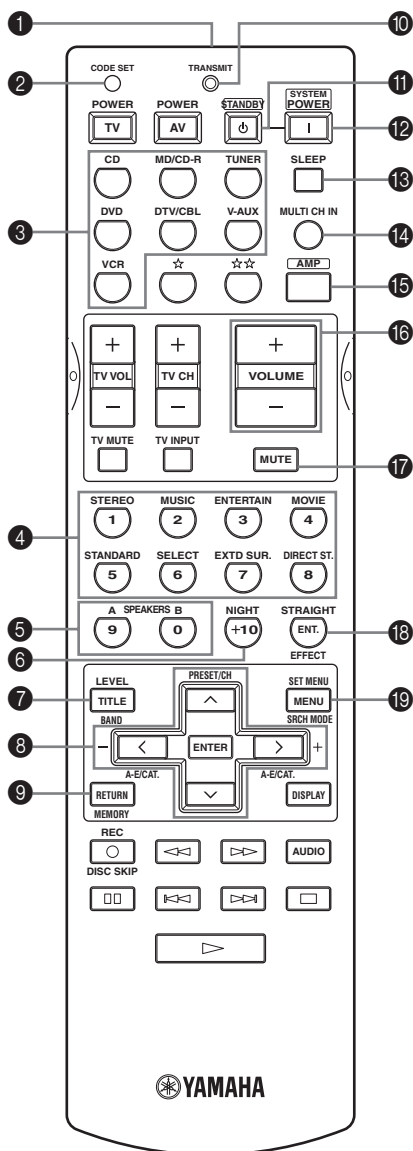

1 Infrared window

Outputs infrared control signals. Aim this window at the component you want to operate.

2 CODE SET

Use to set up remote control codes (see page 64).

3 Input selector buttons

Select the input source and change the control area.

4 Sound field program/numeric buttons

Use to select sound field programs.

Use numbers 1 through 8 to select preset stations when the unit is in tuner mode.

Use SELECT to playback 2-channel sources in surround (see page 29).

Use EXT D SUR. to switch between 5.1 or 6.1-channel playback of multi-channel software (see page 28).

Use DIRECT ST. to playback 2-channel sources in high fidelity sound (see page 30).

5 SPEAKERS A/B

Use to turn on or off the set of front speakers connected to the A and/or B terminals on the rear panel each time the corresponding button is pressed.

6 NIGHT

Turns on or off the night listening modes (see page 30).

7 LEVEL, BAND

Selects the speaker channel to be adjusted and sets the level.

Switches the reception band when the unit is in tuner mode.

8 Cursor buttons \wedge / \vee / \langle / \rangle / ENTER

Use to select and adjust sound field program parameters or SET MENU items.

Press \langle / \rangle to select a preset station group (A to E) when the unit is in tuner mode.

Press \wedge / \vee to select a preset station number (1 to 8) when the unit is in tuner mode.

9 RETURN, MEMORY*

Returns to the previous menu level when adjusting the SET MENU parameters.

10 TRANSMIT indicator

Flashes while the remote control is sending signals.

11 STANDBY

Sets this unit in the standby mode.

12 SYSTEM POWER

Turns on the power of this unit.

13 SLEEP

Sets the sleep timer.

14 MULTI CH IN

Selects multi-channel input when using an external decoder (etc.).

15 AMP

Selects the AMP mode. You must select the AMP mode to control the main unit.

16 VOLUME +/-

Increases or decreases the volume level.

17 MUTE

Mutes the sound. Press again to restore the audio output to the previous volume level.

18 STRAIGHT (EFFECT), ENT.*

Switches the sound fields off or on. When STRAIGHT is selected, input signals (2-channel or multi-channel) are output directly from their respective speakers without effect processing.

19 SET MENU, SRCH MODE*

Activates the SET MENU function.

* Available only when the unit is in the XM Satellite Radio mode (see page 39).

Using the remote control

The remote control transmits a directional infrared beam. Be sure to aim the remote control directly at the remote control sensor on the main unit during operation.

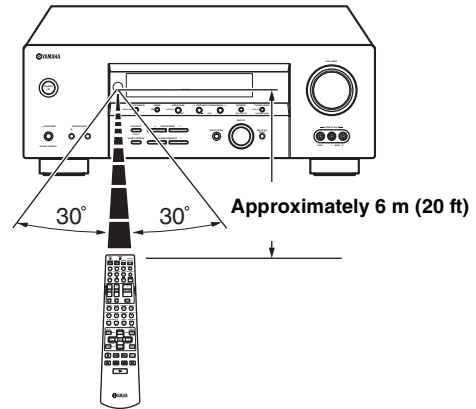

■ Handling the remote control

- Do not spill water or other liquids on the remote control.
- Do not drop the remote control.
- Do not leave or store the remote control in the following types of conditions:
 - places of high humidity, such as near a bath
 - high temperature, such as near a heater or stove
 - extremely low temperatures
 - dusty places

Front panel display

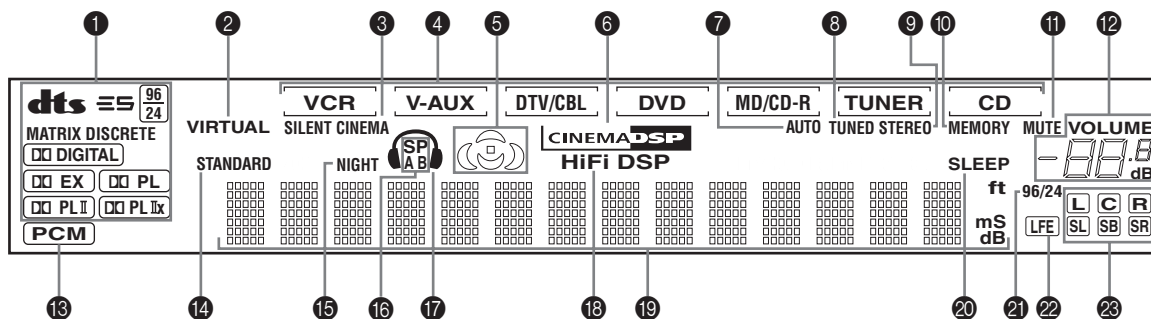

1 Decoder indicators

When any of this unit's decoders function, the respective indicator lights up.

2 VIRTUAL indicator

Lights up when Virtual CINEMA DSP is active (see page 31).

3 SILENT CINEMA indicator

Lights up when headphones are connected and a sound field program is selected (see page 26).

4 Input source indicators

A cursor lights to show the current input source.

5 Sound field indicators

Light to indicate the active DSP sound fields.

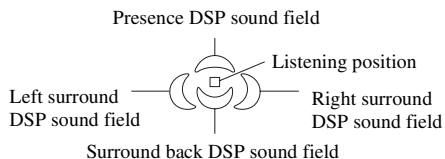

6 CINEMA DSP indicator

Lights up when you select a CINEMA DSP sound field program.

7 AUTO indicator

Lights up to indicate that automatic tuning is possible.

8 TUNED indicator

Lights up when this unit is tuned into a station.

9 STEREO indicator

Lights up when this unit is receiving a strong signal for an FM stereo broadcast while the AUTO indicator is lit.

10 MEMORY indicator

Flashes to show that a station can be stored.

11 MUTE indicator

Flashes while the MUTE function is on.

12 VOLUME level indication

Indicates the current volume level.

13 PCM indicator

Lights up when this unit is reproducing PCM (Pulse Code Modulation) digital audio signals.

14 STANDARD indicator

Lights up when Surround Standard or Surround Enhanced is selected (see page 29).

15 NIGHT indicator

Lights up when you select night listening mode.

16 SP A B indicators

Light up according to the set of front speakers selected. Both indicators light up when both sets of speakers are selected.

17 Headphones indicator

Lights up when headphones are connected.

18 HiFi DSP indicator

Lights up when you select a HiFi DSP sound field program.

19 Multi-information display

Shows the current sound field program name and other information when adjusting or changing settings.

20 SLEEP indicator

Lights up while the sleep timer is on.

⑳ 96/24 indicator

Lights up when a DTS 96/24 signal is input to this unit.

㉑ LFE indicator

Lights up when the input signal contains the LFE signal.

㉒ Input channel indicators/speaker indicators

Indicate the channel components of the current digital input signal.

Indicate the number of speakers connected in SPEAKERS (page 23), or indicate the channel being adjusted in SP LEVEL (page 57).

Rear panel

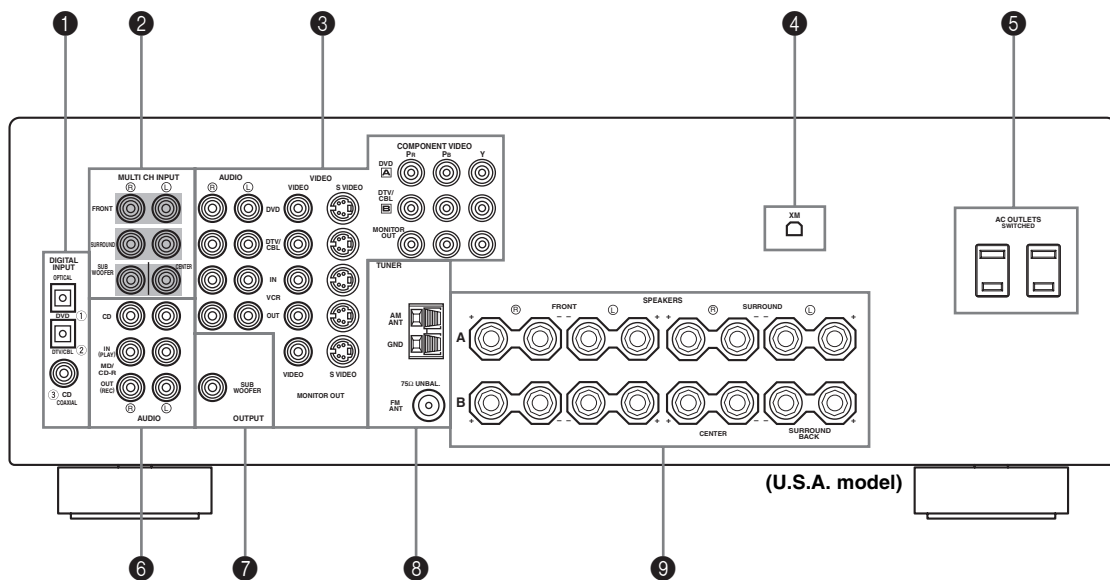

1 DIGITAL INPUT jacks

See pages 15, 17 and 18 for details.

2 MULTI CH INPUT jacks

See page 16 for connection information.

3 Video component jacks

See pages 15 and 17 for connection information.

4 XM jack

See page 39 for connection information.

5 AC OUTLET(S)

Use to supply power to your other A/V components (see page 20).

6 Audio component jacks

See page 18 for connection information.

7 SUBWOOFER OUTPUT jack

See page 13 for connection information.

8 Antenna terminals

See page 19 for connection information.

9 Speaker terminals

See page 13 for connection information.

■ Asia and General models only

VOLTAGE SELECTOR

See page 20.

SPEAKER SETUP

Speaker placement

The speaker layout below shows the standard ITU-R* speaker setting. You can use it to enjoy CINEMA DSP and multi-channel audio sources.

* ITU-R is the radio communication sector of the ITU (International Telecommunication Union).

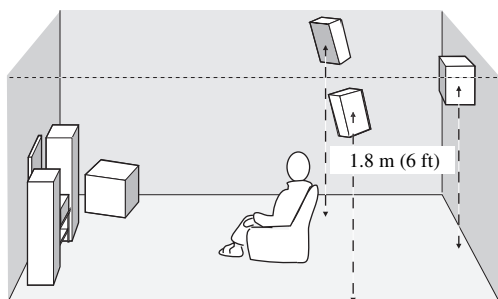
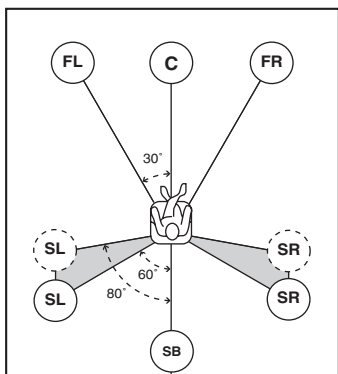

Front speakers (FR and FL)

The front speakers are used for the main source sound plus effect sounds. Place these speakers an equal distance from the ideal listening position. The distance of each speaker from each side of the video monitor should be the same.

Center speaker (C)

The center speaker is for the center channel sounds (dialog, vocals, etc.). If for some reason it is not practical to use a center speaker, you can do without it. Best results, however, are obtained with the full system. Align the front face of the center speaker with the front face of your video monitor. Place the speaker centrally between the front speakers and as close to the monitor as possible, such as directly over or under it.

Surround speakers (SR and SL)

The surround speakers are used for effect and surround sounds. Place these speakers behind your listening position, facing slightly inwards, about 1.8 m (6 ft) above the floor.

Surround back speaker (SB)

The surround back speaker supplements the surround speakers and provides for more realistic front-to-back transitions. Place this speaker directly behind the listening position and at the same height as the surround speakers.

Subwoofer

The use of a subwoofer, such as the YAMAHA Active Servo Processing Subwoofer System, is effective not only for reinforcing bass frequencies from any or all channels, but also for high fidelity reproduction of the LFE (low-frequency effect) channel included in Dolby Digital and DTS software. The position of the subwoofer is not so critical, because low bass sounds are not highly directional. But it is better to place the subwoofer near the front speakers. Turn it slightly toward the center of the room to reduce wall reflections.

Speaker connections

Be sure to connect the left channel (L), right channel (R), “+” (red) and “-” (black) properly. If the connections are faulty, no sound will be heard from the speakers, and if the polarity of the speaker connections is incorrect, the sound will be unnatural and lack bass.

CAUTION

- If you will use 4 or 6 ohm speakers, be sure to set this unit’s speaker impedance setting to 4 ohms before using (see page 21).
- Before connecting the speakers, make sure that the power of this unit is off.
- Do not let the bare speaker wires touch each other or do not let them touch any metal part of this unit. This could damage this unit and/or speakers.
- Use magnetically shielded speakers. If this type of speakers still creates the interference with the monitor, place the speakers away from the monitor.

A speaker cord is actually a pair of insulated cables running side by side. One cable is colored or shaped differently, perhaps with a stripe, groove or ridges. Connect the striped (grooved, etc.) cable to the “+” (red) terminals on this unit and your speaker. Connect the plain cable to the “-” (black) terminals.

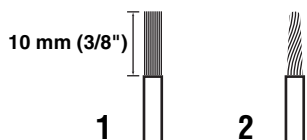

1 Remove approximately 10 mm (3/8") of insulation from the end of each speaker cable.

2 Twist the exposed wires of the cable together to prevent short circuits.

3 Unscrew the knob.

4 Insert one bare wire into the hole in the side of each terminal.

5 Tighten the knob to secure the wire.

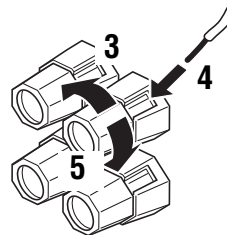

Red: positive (+)
Black: negative (-)

■ Banana plug connections

(With the exception of U.K., Europe and Asia models)
First, tighten the knob and then insert the banana plug connector into the end of the corresponding terminal.

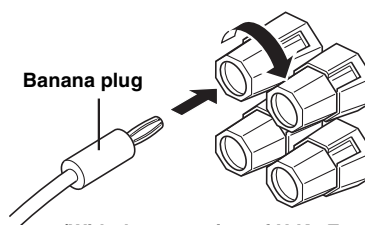

(With the exception of U.K., Europe and Asia models)

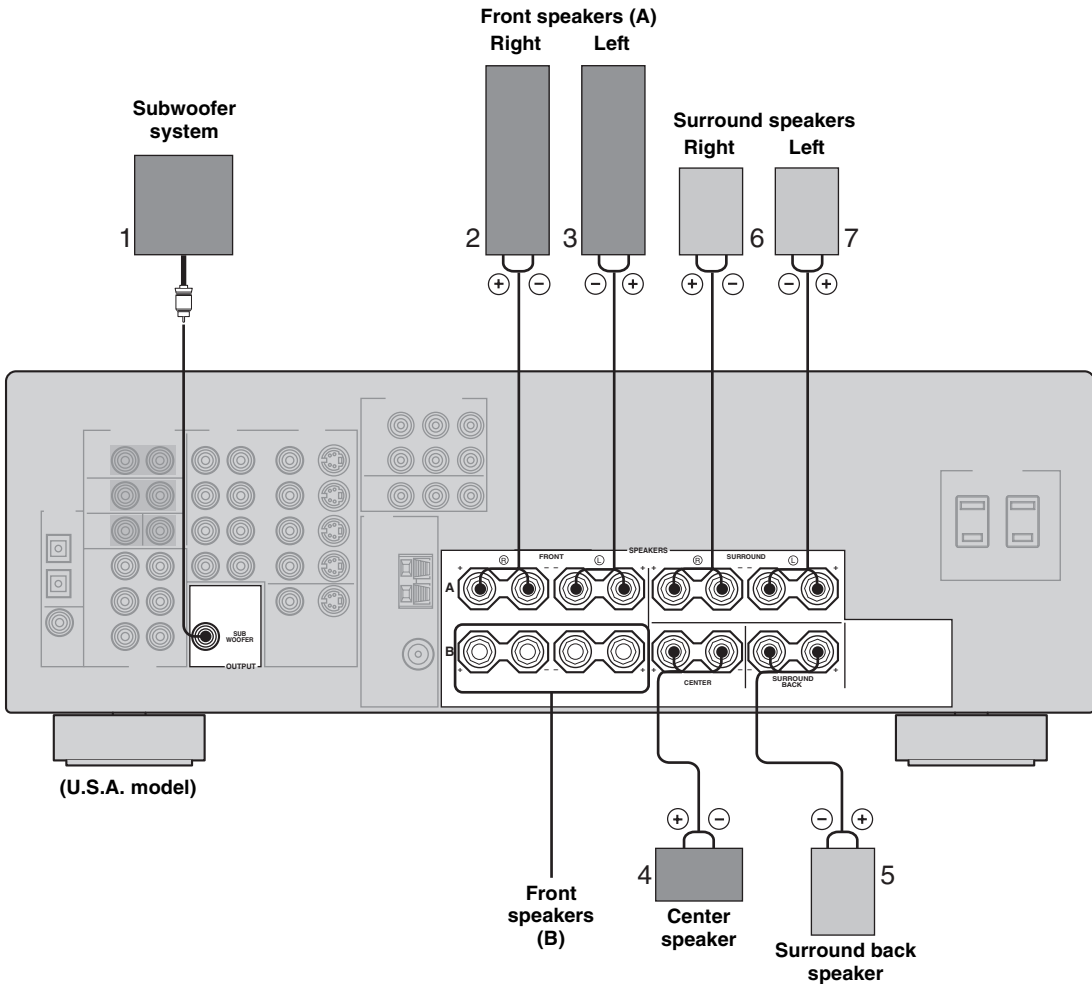

■ FRONT terminals

Connect one or two speaker systems (2, 3) to these terminals. If you use only one speaker system, connect it to the FRONT A or B terminals.

■ CENTER terminals

Connect a center speaker (4) to these terminals.

■ SURROUND terminals

Connect surround speakers (6, 7) to these terminals.

■ SUBWOOFER jack

Connect a subwoofer with built-in amplifier (1), such as the YAMAHA Active Servo Processing Subwoofer System, to this jack.

■ SURROUND BACK terminals

Connect a surround back speaker (5) to these terminals.

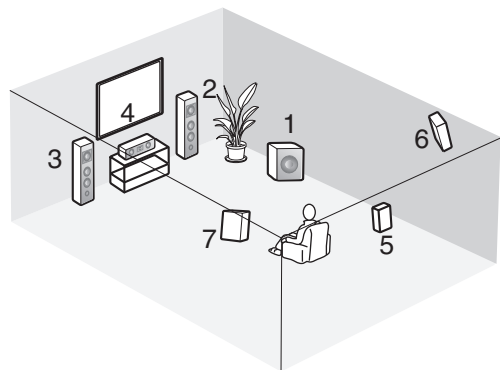

Speaker layout

CONNECTIONS

Before connecting components

CAUTION

Do not connect this unit or other components to the mains power until all connections between components are complete.

■ Cable indications

For analog signals

left analog cables



right analog cables



For digital signals

optical cables



coaxial cables



For video signals

video cables



S-video cables



component video cables

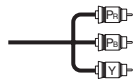

■ Analog jacks

You can input analog signals from audio components by connecting audio pin cable to the analog jacks on this unit. Connect red plugs to the right jacks and white plugs to the left jacks.

■ Digital jacks

This unit has digital jacks for direct transmission of digital signals through either coaxial or fiber optic cables. You can use the digital jacks to input PCM, Dolby Digital and DTS bitstreams. When you connect components to both the COAXIAL and OPTICAL jacks, priority is given to the input signals from the COAXIAL jack. All digital input jacks are compatible with 96-kHz sampling digital signals.

Note

This unit handles digital and analog signals independently. Thus audio signals input to the analog jacks are only output to the analog OUT (REC) jacks.

Dust protection cap

Pull out the cap from the optical jack before you connect the fiber optic cable. Do not discard the cap. When you are not using the optical jack, be sure to put the cap back in place. This cap protects the jack from dust.

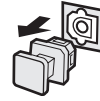

■ Video jacks

This unit has three types of video jacks. Connection depends on the availability of input jacks on your monitor.



VIDEO jacks

For conventional composite video signals.

S VIDEO jacks

For S-video signals, separated into luminance (Y) and color (C) video signals to achieve high-quality color reproduction.

COMPONENT VIDEO jacks

For component signals, separated into luminance (Y) and color difference (Pb, Pr) to provide the best quality in picture reproduction.

Signal flow inside this unit

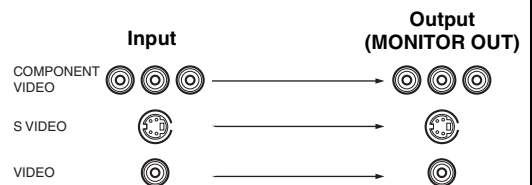

Connecting video components

■ Connections for DVD playback

Note

Be sure to connect your video source components in the same way you connect your video monitor to this unit. For example, if you connect your video monitor to this unit using a VIDEO connection, connect your video source components to this unit using the VIDEO connections.

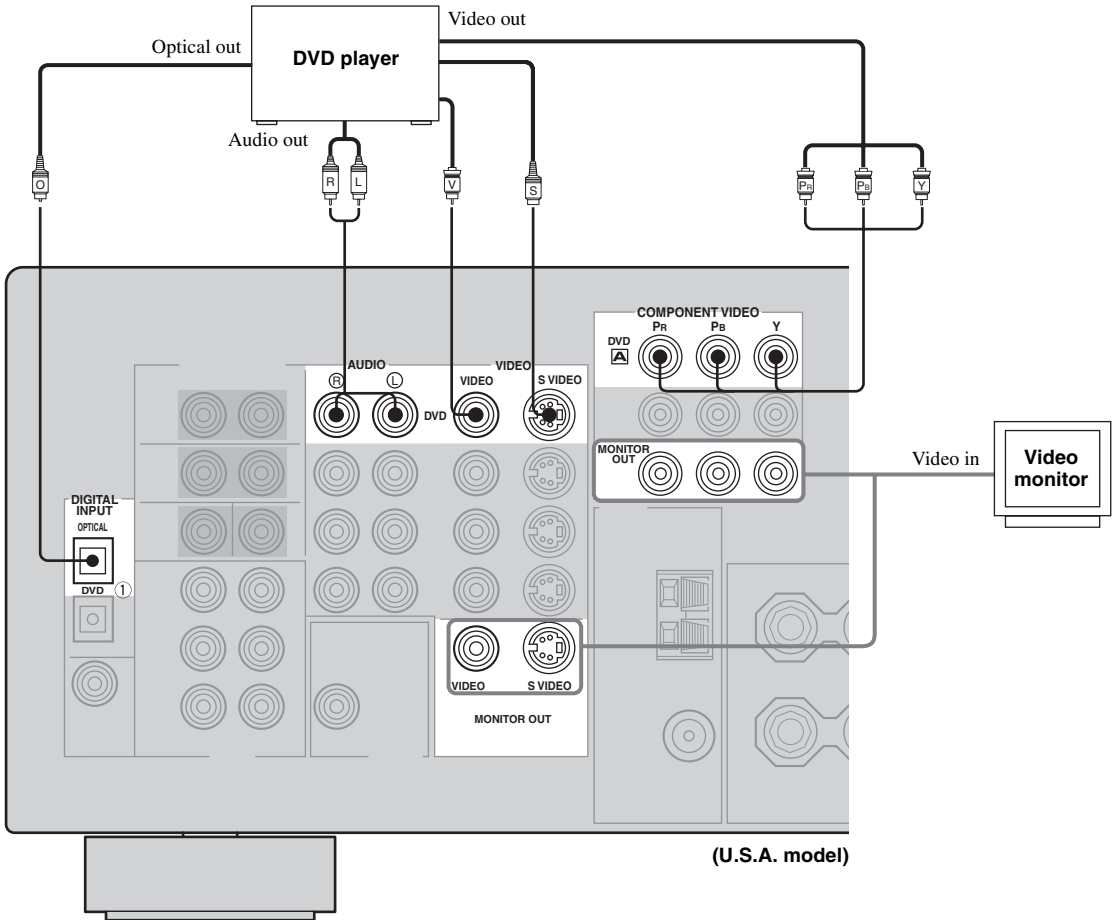

■ **Connecting to the MULTI CH INPUT jacks**

This unit is equipped with 6 additional input jacks (left and right FRONT, CENTER, left and right SURROUND and SUBWOOFER) for discrete multi-channel input from a multi-format player, external decoder, sound processor or pre-amplifier.

Connect the output jacks on your multi-format player or external decoder to the MULTI CH INPUT jacks. Be sure to match the left and right outputs to the left and right input jacks for the front and surround channels.

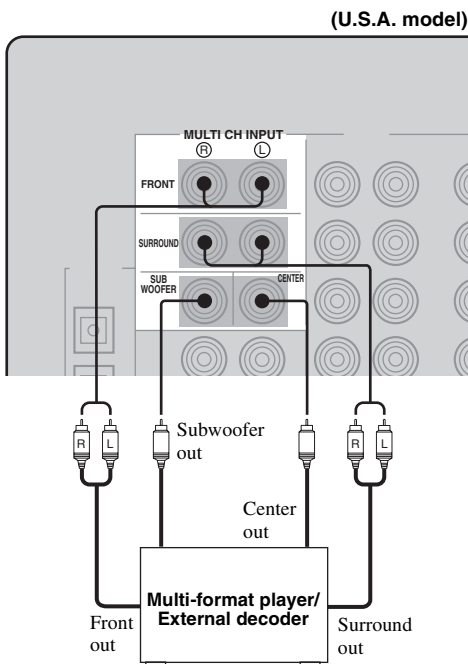

Notes

- When you select MULTI CH INPUT as the input source, this unit automatically turns off the digital sound field processor, and you cannot select sound field programs.
- This unit does not redirect signals input to the MULTI CH INPUT jacks to accommodate for missing speakers. We recommend that you connect at least a 5.1-channel speaker system before using this feature.
- When headphones are used, only front left and right channels are output.

■ Connections for other video components

Note

- Be sure to connect your video source components in the same way you connect your video monitor to this unit. For example, if you connect your video monitor to this unit using a VIDEO connection, connect your video source components to this unit using the VIDEO connection.
- Video signals are only output to the MONITOR OUT jacks. When recording, you must make the same type of video connections (i.e., S-video) between each component.

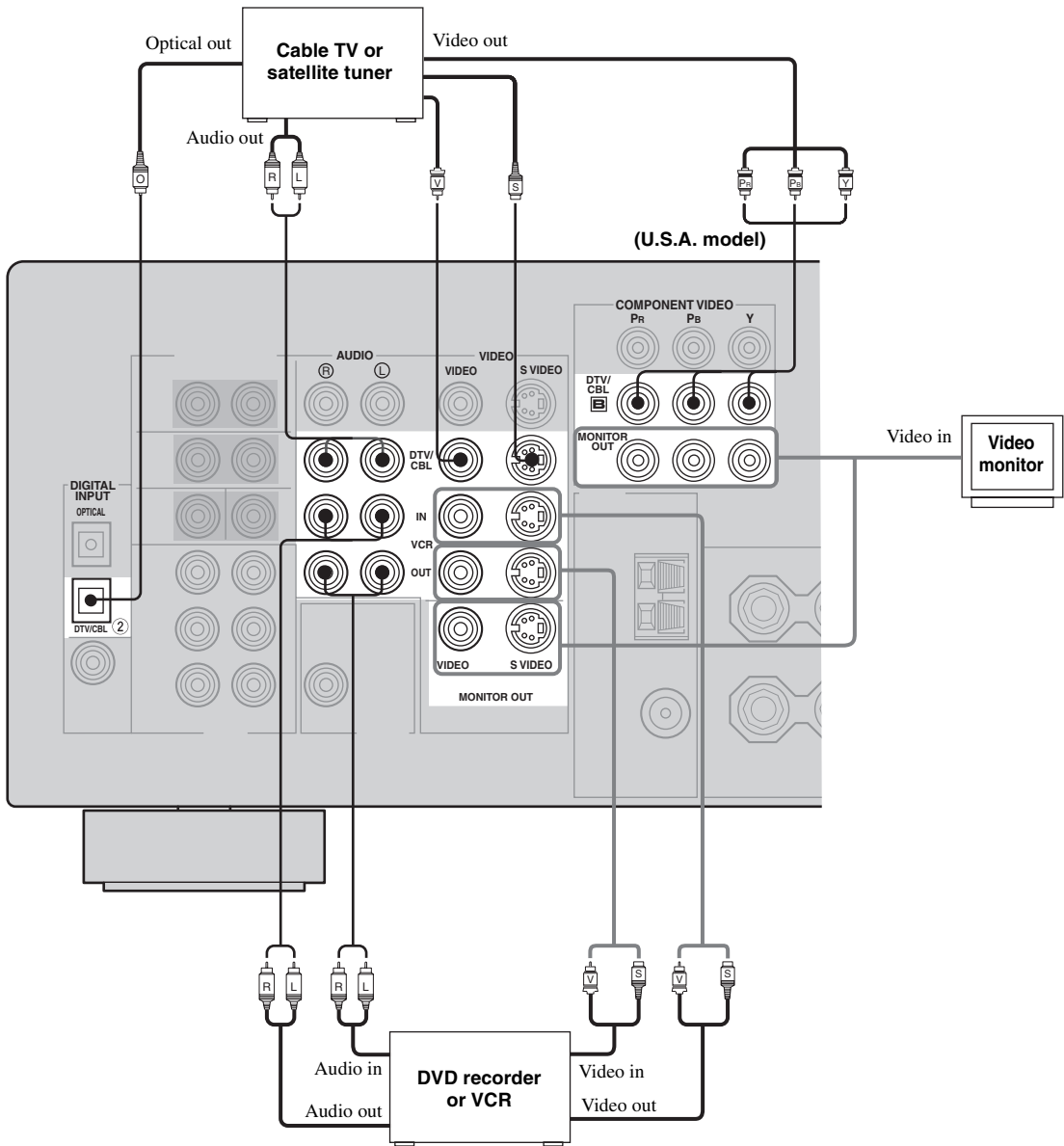

■ VIDEO AUX jacks (on the front panel)

Use these jacks to connect any video source, such as a game console or video camera, to this unit.

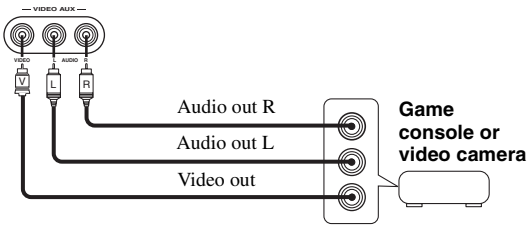

Connecting audio components

■ Connections for audio components

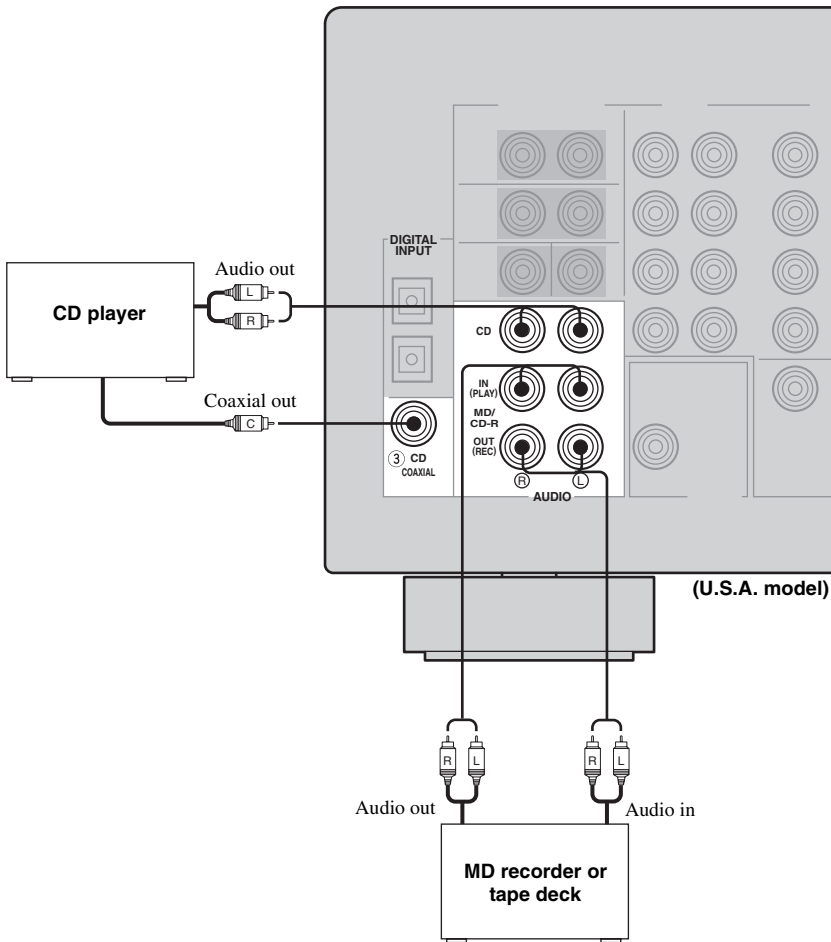

Connecting the FM and AM antennas

Both FM and AM indoor antennas are included with this unit. In general, these antennas should provide sufficient signal strength. Connect each antenna correctly to the designated terminals.

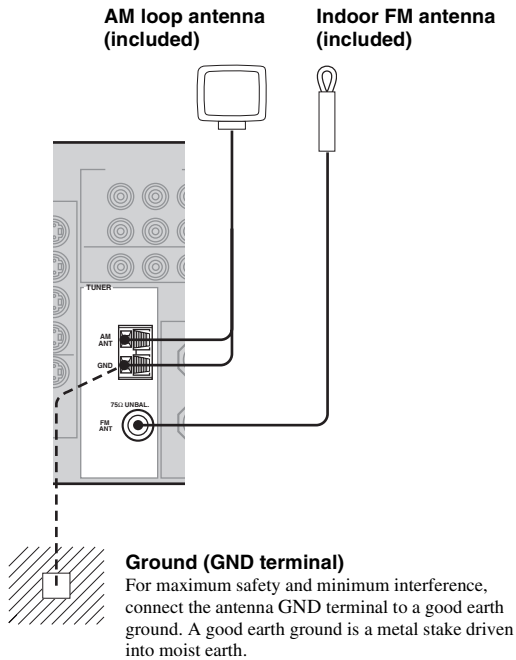

- 3 Orient the AM loop antenna for the best reception.

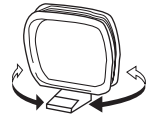

Notes

- The AM loop antenna should be placed away from this unit.
- The AM loop antenna should always be connected, even if an outdoor AM antenna is connected to this unit.
- A properly installed outdoor antenna provides clearer reception than an indoor one. If you experience poor reception quality, an outdoor antenna may improve the quality. Consult the nearest authorized YAMAHA dealer or service center about outdoor antennas.

Connecting the AM loop antenna

- 1 Set up the AM loop antenna, then connect it to the terminals on this unit.

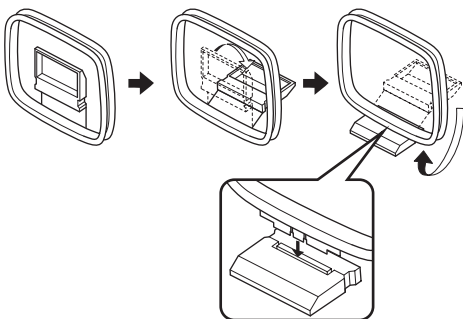

- 2 Press and hold the tab to insert the AM loop antenna lead wires into the AM ANT and GND terminals.



Connecting the power supply cord

■ **Connecting the AC power cord**

Plug the power cord into an AC wall outlet.

■ **AC OUTLET(S) (SWITCHED)**

U.K. and Australia models 1 outlet
 Korea model None
 Other models 2 outlets

Use these outlets to connect the power cords from your other components to this unit. Power to the AC OUTLET(S) is controlled by this unit's STANDBY/ON (or SYSTEM POWER and STANDBY). The outlet(s) supply power to any connected component whenever this unit is turned on. For information on the maximum power (total power consumption of components), see "SPECIFICATIONS" on page 79.

■ **VOLTAGE SELECTOR (Asia and General models only)**

The VOLTAGE SELECTOR on the rear panel of this unit must be set for your local main voltage BEFORE plugging into the AC main supply. Voltages are:

Asia model 220/230–240 V AC, 50/60 Hz
 General model 110/120/220/230–240 V AC, 50/60 Hz

■ **Memory back-up**

The memory back-up circuit prevents the stored data from being lost even if this unit is in the standby mode. However if the power cord is disconnected from the AC wall outlet, or the power supply is cut for more than one week, the stored data will be lost.

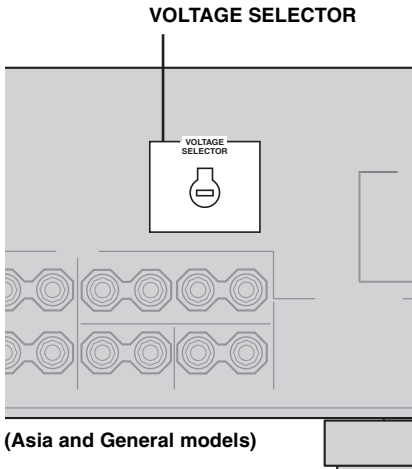

Speaker impedance setting

CAUTION

If you are using 4 or 6 ohm speakers, set the impedance to 4 or 6 ohms as follows before turning on the power.

Be sure this unit is in the standby mode.

- 1 Turn off the power to this unit, and while holding down STRAIGHT (EFFECT), press STANDBY/ON.

This unit turns on, and the ADVANCED SETUP menu appears in the front panel display.



While holding down, press



- 2 Press PROGRAM </> to move through the menu and select "SP IMP."



- 3 Press STRAIGHT (EFFECT) repeatedly to select "4Ω MIN".



- 4 Press STANDBY/ON to turn off the power.



The setting you made is reflected the next time this unit's power is turned on.

Turning on the power

When all connections are complete, turn on the power of this unit.

(U.S.A. model)

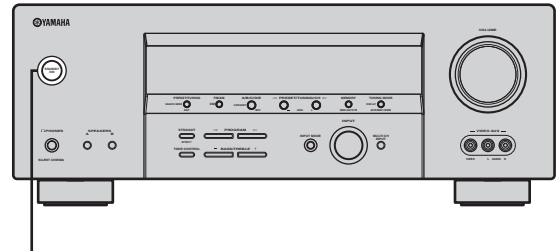

STANDBY/ON

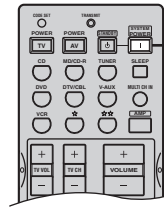

SYSTEM POWER

Press STANDBY/ON (or SYSTEM POWER on the remote control) to turn on the power of this unit.



Front panel

or



Remote control

BASIC SETUP

The basic setup feature is a useful way to set up your system quickly and with minimal effort.



- If you wish to configure the unit manually using more precise adjustments, use the detailed parameters in SOUND MENU (page 56) instead of using BASIC SETUP.
- Altering any parameters in BASIC SETUP will reset all parameters in SOUND MENU.
- Initial settings are indicated in bold for each parameter.

Using the BASIC SETUP menu

Before you begin:

- Press SPEAKERS A or B on the front panel (or press AMP to select the AMP mode, then press SPEAKERS A or B on the remote control) to select the front speakers you want to use.
- Make sure you disconnect your headphones from this unit.

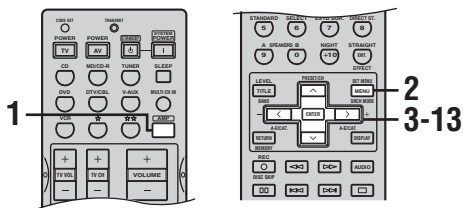

1 Press AMP.



2 Press SET MENU.

“BASIC SETUP” appears in the front panel display.

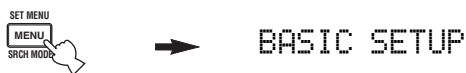

3 Press ENTER to enter BASIC SETUP.

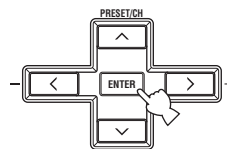

The ROOM parameter appears in the front panel display.

4 Press </> to select the desired setting.

ROOM: S M >L

Select the size of the room you have installed your speakers in. In general, the room sizes are defined as follows:

[U.S.A. and Canada models]

S (small) 16 x 13ft, 200ft² (4.8 x 4.0m, 20m²)

M (medium) 20 x 16ft, 300ft² (6.3 x 5.0m, 30m²)

L (large) 26 x 19ft, 450ft² (7.9 x 5.8m, 45m²)

[Other models]

S (small) 3.6 x 2.8m, 10m²

M (medium) 4.8 x 4.0m, 20m²

L (large) 6.3 x 5.0m, 30m²

5 Press ∨ to display the SUBWOOFER parameter.

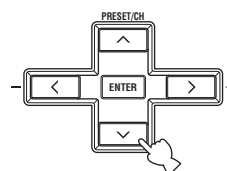

6 Press </> to select the desired setting.

SUBWOOFER • YES

YES If you have a subwoofer in your system.

NONE If you do not have a subwoofer in your system.

7 Press \vee to display the **SPEAKERS** parameter.

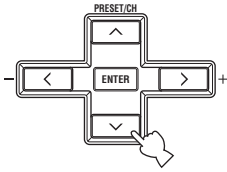

8 Press \langle / \rangle to select the number of speakers you connected.

SPEAKERS • • 6SPK

Choices	Display	Speakers
2SPK	L R	Front L/R
3SPK	L C R	Front L/R, Center
4SPK	L R SL SR	Front L/R, Surround L/R
5SPK	L C R SL SR	Front L/R, Center, Surround L/R
6SPK	L C R SL SB SR	Front L/R, Center, Surround L/R, Surround back

9 Press \vee to display **SET/CANCEL**.

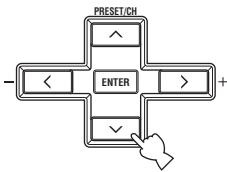

10 Press \langle / \rangle to select the desired setting.

>SET CANCEL

- SET** To apply the settings you chose in steps 4 through 8.
- CANCEL** To cancel the setup without making any changes.

11 Press **ENTER** to confirm your selection.

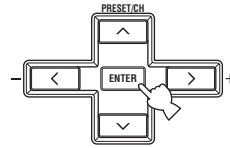

If you selected **SET**, you hear a test tone from each speaker in turn. “CHECK:TestTone” appears in the front panel display for a few seconds, then “CHECK: OK?”.

CHECK:TestTone



CHECK OK? YES

12 Press \langle / \rangle to select the desired setting.

CHECK OK? YES

- YES** To complete the setup process if the test tone levels from each speaker were satisfactory.
- NO** To proceed to the **SPEAKER LEVEL** speaker level adjustment menu to balance the level of each speaker.

13 Press **ENTER** to confirm your selection.

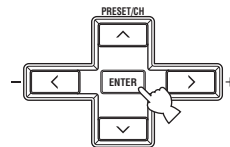

If you selected **NO** in step 12, the front speaker level adjustment display appears in the front panel display.

■ To balance the speaker levels

Perform the following steps after step 13 (see page 23).



The unit outputs the test tone from the selected speaker and the left front (or left surround) speaker in turn. The indicator of the speaker currently outputting the test tone flashes in the front panel display.

1 Press ∇ / \blacktriangle to select a speaker, then use \langle / \rangle to adjust the balance.

The control range is from +10 dB to -10 dB.

FR -----||-----

Adjusts the balance between the front left and right speakers.

C -----||-----

Adjusts the balance between the front left and center speakers.

SL -----||-----

Adjusts the balance between the front left and surround left speakers.

SB -----||-----

Adjusts the balance between the surround left and surround back speakers.

SR -----||-----

Adjusts the balance between the surround left and surround right speakers.

SWFR -----||-----

Adjusts the balance between the front left speaker and the subwoofer.

2 Press SET MENU to exit after balancing the speakers.

Memory back-up

The memory back-up circuit prevents the stored data from being lost even if this unit is in the standby mode. However, if the power cord is disconnected from the AC outlet, or the power supply is cut for more than one week, the stored data will be lost. If so, adjust the items again.

PLAYBACK

Basic operations

(U.S.A. model)

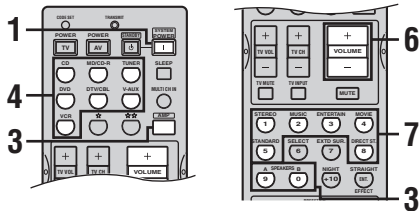
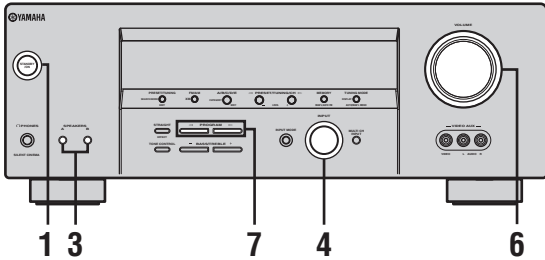

- 1 Press **STANDBY/ON** (or **SYSTEM POWER** on the remote control) to turn on the power.

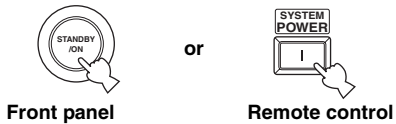

- 2 Turn on the video monitor connected to this unit.

- 3 Press **SPEAKERS A** or **B** (or press **AMP** to select the **AMP** mode, then press **SPEAKERS A** or **B** on the remote control).

Each press turns the respective speakers on or off.

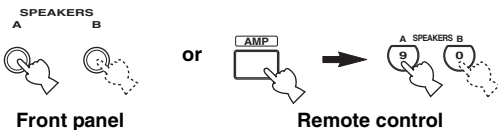

- 4 Select the input source.

Use **INPUT** (or press one of the input selector buttons on the remote control) to select the input you desire.

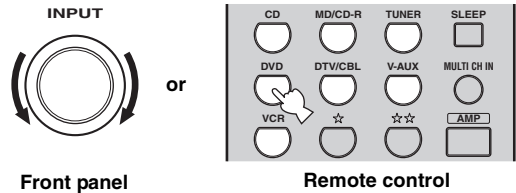

The current input source name and input mode appear in the front panel display for a few seconds.

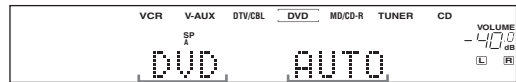

Selected input source Input mode

- 5 Start playback or select a broadcast station on the source component.

Refer to the operating instructions for the component.

- 6 Adjust the volume to the desired output level.

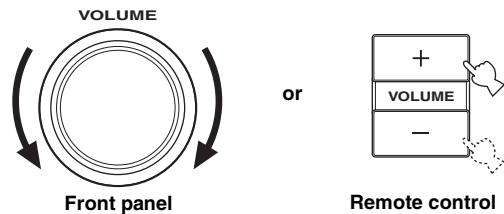

7 Select a sound field program if desired.

Press PROGRAM < / > repeatedly (or press AMP to select the AMP mode, then press one of the sound field program buttons on the remote control) to select a sound field program. (See page 49 for details about sound field programs.)



Front panel

or

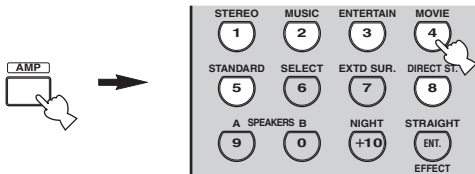

Remote control

■ To listen with headphones (“SILENT CINEMA”)

“SILENT CINEMA” allows you to enjoy multi-channel music or movie sound, including Dolby Digital and DTS surround, through ordinary headphones. “SILENT CINEMA” activates automatically whenever you connect headphones to the PHONES jack while listening to CINEMA DSP or HiFi DSP sound field programs. When activated, the “SILENT CINEMA” indicator lights up in the front panel display.

Notes

- This unit will not be set to “SILENT CINEMA” when MULTI CH INPUT is selected as the input source.
- “SILENT CINEMA” is not effective when the Direct Stereo or 2ch Stereo program is selected, or in STRAIGHT mode.

■ To adjust the tone

You can adjust the tonal quality of your front left and right speakers or headphones (when connected).

Press TONE CONTROL on the front panel repeatedly to select TREBLE or BASS, then press BASS/TREBLE -/+ repeatedly to increase or decrease.

- Select TREBLE to adjust the high frequency response.
- Select BASS to adjust the low frequency response.

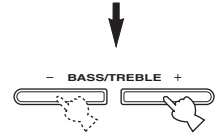

Speaker and headphone adjustments are stored independently.

Notes

- If you increase or decrease the high-frequency or low-frequency sound to an extreme level, the tonal quality of the surround speakers may not match that of the front left and right speakers.
- TONE CONTROL is not effective with the Direct Stereo program (page 30) or MULTI CH INPUT.
- When TC BYPASS is set to AUTO (page 58), and BASS and TREBLE are set to 0 dB, audio output automatically bypasses this unit's tone control circuitry.

■ To mute the sound

Press MUTE on the remote control.

The MUTE indicator flashes in the front panel display.

To resume the audio output, press MUTE again (or press VOLUME -/+). The MUTE indicator disappears from the display.



You can adjust the muting level (see page 58).

■ Selecting MULTI CH INPUT

Press MULTI CH INPUT (or MULTI CH IN on the remote control) so that “MULTI CH INPUT” appears in the front panel display.

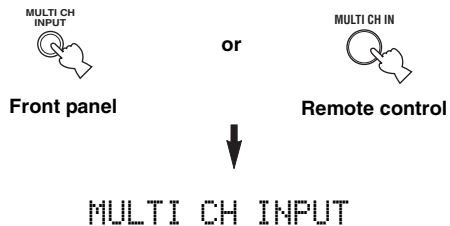

Note

When “MULTI CH INPUT” is shown in the front panel display, no other source can be played. To select another input source with INPUT (or one of the input selector buttons), press MULTI CH INPUT (or MULTI CH IN on the remote control) to turn off “MULTI CH INPUT” in the front panel display.

■ Playing video sources in the background

You can combine a video image from a video source with sound from an audio source. For example, you can enjoy listening to classical music while viewing beautiful scenery from the video source on the video monitor.

Use the input selector buttons on the remote control to select a video source, then select an audio source.

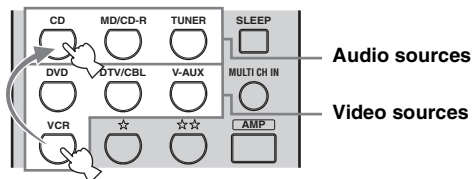

Note

If you want to enjoy audio from the MULTI CH INPUT jacks together with a video source, first select the video source, then press MULTI CH INPUT (or MULTI CH IN on the remote control).

Selecting sound field programs

■ Front panel operation

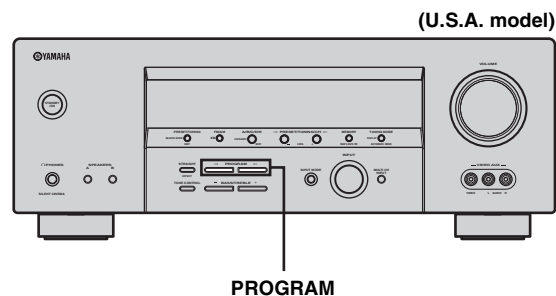

Press PROGRAM < / > repeatedly to select the desired program.

The name of the selected program appears in the front panel display.

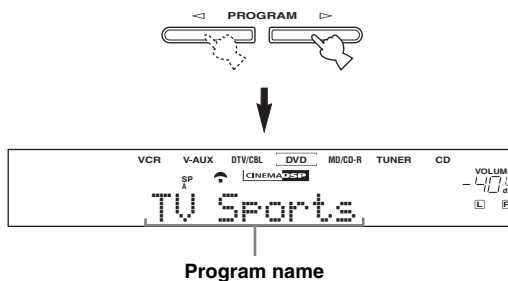

■ Remote control operation

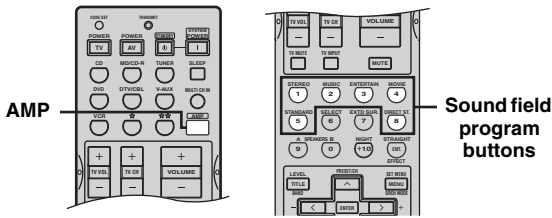

Press AMP to select the AMP mode, then press one of the sound field program buttons repeatedly to select the desired program.

The name of the selected program appears in the front panel display.

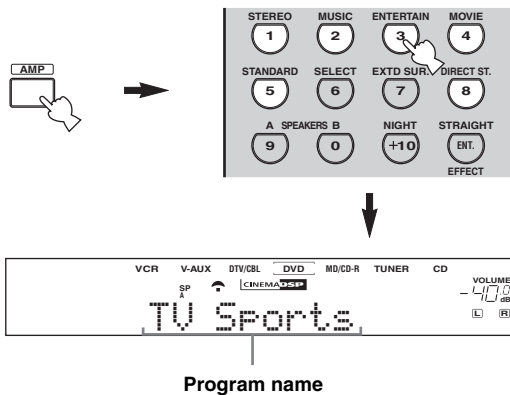

Feel free to choose a sound field program based on your listening preference, and not purely on the name of the program itself.

Notes

- When you select an input source, this unit automatically selects the last sound field program used with that source.
- Sound field programs cannot be selected when MULTI CH INPUT is selected.
- Sampling frequencies higher than 48 kHz (except for DTS 96/24 signals) will be sampled down to 48 kHz, then sound field programs will be applied.

■ Enjoying multi-channel software

If you connected a surround back speaker, use this feature to enjoy 6.1-channel playback for multi-channel sources using the Dolby Pro Logic IIX, Dolby Digital EX or DTS-ES decoders.

Press AMP on the remote control to select the AMP mode, then press EXTD SUR. to switch between 5.1 and 6.1-channel playback.



To select a decoder, press </> repeatedly while PLIIxMusic (etc.) is displayed.

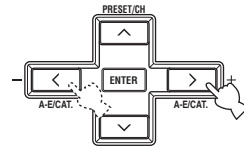

Auto (AUTO)

When a signal (flag) that can be recognized by the unit is input, the unit selects the optimum decoder for playing back the signal in 6.1 channels.

If the unit cannot recognize the flag or no flag is present in the input signal, it cannot automatically be played in 6.1 channels.

Decoders (select with </>)

You can select from the following decoders depending on the format of the software you are playing.

PLIIxMusic

For playing back Dolby Digital or DTS signals in 6.1 channels using the Pro Logic IIX music decoder.

EX/ES

For playing back Dolby Digital signals in 6.1 channels using the Dolby Digital EX decoder.

DTS signals are played back in 6.1 channels using the DTS-ES decoder.

EX

For playing back Dolby Digital or DTS signals in 6.1 channels using the Dolby Digital EX decoder.

Off (OFF)

Decoders are not used to create 6.1 channels.

Notes

- Some 6.1-channel compatible discs do not have a signal (flag) which this unit can automatically detect. When playing these kinds of discs with 6.1-channel, select a decoder manually (PLIIx Music, EX/ES or EX).
- 6.1-channel playback is not possible even if EXTD SUR. is pressed in the following cases:
 - When “SUR. LR” (see page 56) or “SUR. B” (see page 56) is set to NONE.
 - When the source connected to the MULTI CH INPUT jack is being played.
 - When the source being played does not contain surround left and right channel signals.
 - When a Dolby Digital KARAOKE source is being played.
 - When “2ch Stereo” or “Direct Stereo” is selected.
- When the power of this unit is turned off, this setting will be reset to AUTO.
- The Pro Logic IIx decoder is not available when “SUR. B” is set to NONE (see page 56).

■ Enjoying 2-channel software in surround

Signals input from 2-channel sources can also be played back on multiple channels.

Press AMP to select the AMP mode, then press STANDARD on the remote control to switch between the SUR. STANDARD and SUR. ENHANCED programs.



Or press MOVIE to select the MOVIE THEATER program.



Press SELECT on the remote control to select the decoder.



You can select from the following modes depending on the type of software you are playing and your personal preference.

When you select the SUR. STANDARD program:

PRO LOGIC
Dolby Pro Logic processing for any sources.

PLII Movie
Dolby Pro Logic II processing for movie software.

PLII Music
Dolby Pro Logic II processing for music software.

PLII Game
Dolby Pro Logic II processing for game software.

PLIIx Movie
Dolby Pro Logic IIx processing for movie software.

PLIIx Music
Dolby Pro Logic IIx processing for music software.

PLIIx Game
Dolby Pro Logic IIx processing for game software.

Neo:6 Cinema
DTS processing for movie software.

Neo:6 Music
DTS processing for music software.

When you select the SUR. ENHANCED or MOVIE THEATER program:

PRO LOGIC
Dolby Pro Logic processing for any sources.

PLII Movie
Dolby Pro Logic II processing for movie software.

PLIIx Movie
Dolby Pro Logic IIx processing for movie software.

Neo:6 Cinema
DTS processing for movie software.



You can also select a decoder by pressing </> on the remote control when the decoder type is displayed in the front panel display.

Note

The Pro Logic IIx decoder is not available when “SUR. B” is set to NONE (see page 56).

■ Listening to high fidelity stereo sound (Direct Stereo)

Direct Stereo allows you to bypass this unit's decoders and DSP processors to enjoy pure high fidelity sound from 2-channel PCM and analog sources.

Press **PROGRAM** \triangleleft / \triangleright repeatedly (or press **AMP** to select the AMP mode, then press **DIRECT ST.** on the remote control) to select "DIRECT STEREO".

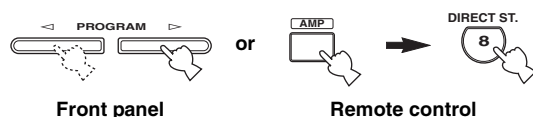

DIRECT STEREO

Notes

- To avoid unexpected noise, do not play DTS-encoded CDs in this mode.
- When multi-channel signals (Dolby Digital and DTS) are input, this unit automatically switches to the corresponding analog input. (When DTS is selected as an input mode, no sound will be heard.)
- No sound will be output from the subwoofer.
- TONE CONTROL (page 26) and SET MENU (page 54) settings are not effective.
- The front panel display automatically dims.
- If you press AMP on the remote control to select the AMP mode, then press DIRECT ST., the unit automatically enters Direct Stereo mode and you cannot toggle between the unit's other sound field programs.

■ Night listening modes

The night listening modes are designed to improve listenability at lower volumes or at night. Choose either NIGHT:CINEMA or NIGHT:MUSIC depending on the type of material you are playing.

Press **AMP** on the remote control to select the AMP mode, then press **NIGHT** repeatedly to select cinema or music.

When night listening is selected, the NIGHT indicator in the front panel display lights up.



- Select NIGHT:CINEMA when watching films to reduce the dynamic range of film soundtracks and make dialog easier to hear at lower volumes.
- Select NIGHT:MUSIC when listening to music sources to preserve ease-of-listening for all sounds.
- Select OFF if you do not want to use this function.

Press \triangleleft / \triangleright to adjust the effect level while NIGHT:CINEMA or NIGHT:MUSIC is displayed.

This adjusts the level of compression.

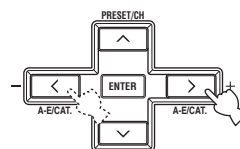

Remote control

Effect. Lvl: MID

- Select MIN for minimum compression.
- Select MID for standard compression.
- Select MAX for maximum compression.



NIGHT:CINEMA and NIGHT:MUSIC adjustments are stored independently.

Notes

- You cannot use the night listening modes with the Direct Stereo program or MULTI CH INPUT (even though the NIGHT indicator lights up when Direct Stereo is selected).
- The night listening modes may vary in effectiveness depending on the input source and surround sound settings you use.

■ Downmixing to 2 channels

You can enjoy 2-channel stereo playback even from multi-channel sources.

Press **PROGRAM** ◀ / ▶ repeatedly (or press **AMP** to select the **AMP** mode, then press **STEREO** on the remote control) to select **2ch Stereo**.

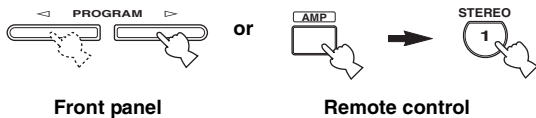

Front panel

Remote control



2ch Stereo



You can use a subwoofer with this program when **SWFR** or **BOTH** is selected in "BASS OUT".

■ Listening to unprocessed input signals

In **STRAIGHT** mode, two channel stereo sources are output from only the front left and right speakers. Multi-channel sources are decoded straight into the appropriate channels without any additional effect processing.

Press **STRAIGHT** (or press **AMP** on the remote control to select the **AMP** mode, then press **STRAIGHT**) to select **STRAIGHT**.

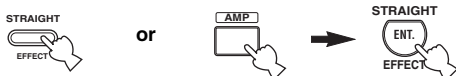

Front panel

Remote control



STRAIGHT

Press **STRAIGHT** (**EFFECT**) again so that "STRAIGHT" disappears from the display when you want to turn the sound effect back on.

■ Virtual CINEMA DSP

Virtual CINEMA DSP allows you to enjoy the CINEMA DSP programs without surround speakers. It creates virtual speakers to reproduce the natural sound field. If you set "SUR. LR" to **NONE** (see page 56), Virtual CINEMA DSP activates automatically whenever you select a CINEMA DSP sound field program.

Note

Virtual CINEMA DSP will not activate, even when "SUR. LR" is set to **NONE** (see page 56) in the following cases:

- When **MULTI CH INPUT** is selected as the input source.
- When headphones are connected to the **PHONES** jack.

Selecting input modes

This unit comes with a variety of input jacks. Do the following to select the type of input signals you want to use.

1 Rotate **INPUT** to select the input source.



Front panel

2 Press **INPUT MODE** to select an input mode. In most cases, use **AUTO**.

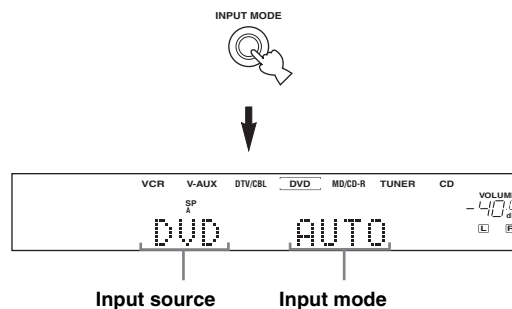

AUTO

Automatically selects input signals in the following order:

- 1) Digital signals*
- 2) Analog signals

DTS

Selects only digital signals encoded in DTS. If no DTS signals are input, no sound is output.

ANALOG

Selects only analog signals. If no analog signals are input, no sound is output.

* If this unit detects a Dolby Digital or DTS signal, the decoder automatically switches to the appropriate decoder.



You can adjust the default input mode of this unit (see page 59).

Notes

- When playing a DTS-CD/LD, be sure to set INPUT MODE to DTS.
- If the digital output data of the player has been processed in any way, you may not be able to perform DTS decoding even if you make a digital connection between this unit and the player depending on the player.

■ **Displaying information about the input source**

You can display the type, format and sampling frequency of the current input signal.

1 Select the input source.

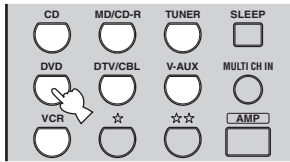

2 Press AMP to select the AMP mode, then press STRAIGHT so that “STRAIGHT” appears in the display.

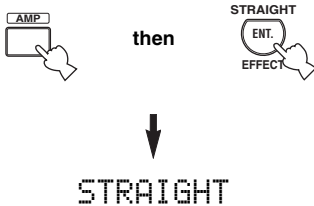

3 Press ^ / v to display the following information about the input signal.

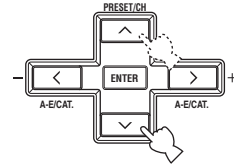

- (Format) Signal format display. When the unit cannot detect a digital signal it automatically switches to analog input.
- in Number of source channels in the input signal. For example, a multi-channel soundtrack with 3 front channels, 2 surround channels and LFE, is displayed as “3/2/LFE”.
- fs Sampling frequency. When the unit is unable to detect the sampling frequency “Unknown” appears.
- rate Bit rate. When the unit is unable to detect the bit rate “Unknown” appears.
- flg Flag data encoded with DTS or Dolby Digital signals that cue this unit to automatically switch decoders.

FM/AM TUNING

Automatic and manual tuning

There are 2 tuning methods; automatic and manual. Automatic tuning is effective when station signals are strong and there is no interference.

Automatic tuning

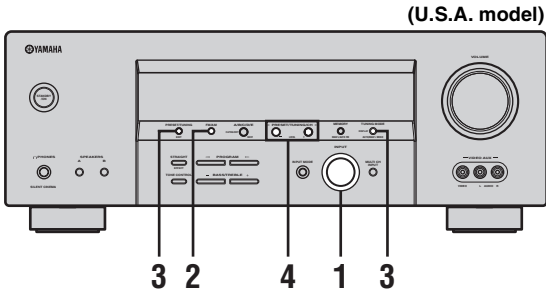

- 1 Rotate INPUT to select TUNER as the input source.



- 2 Press FM/AM to select the reception band. "FM" or "AM" appears in the front panel display.



- 3 Press TUNING MODE (AUTO/MAN'L MONO) so that the AUTO indicator lights up in the front panel display.



If a colon (:) appears in the front panel display, tuning is not possible. Press PRESET/TUNING (EDIT) to turn the colon (:) off.

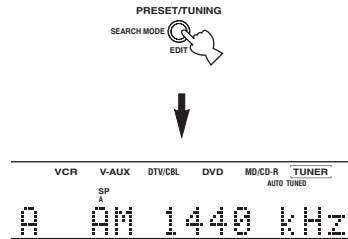

- 4 Press PRESET/TUNING/CH < / > once to begin automatic tuning.

Press > to tune into a higher frequency, or press < to tune into a lower frequency.

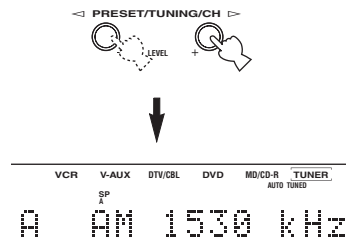

When tuned into a station, the TUNED indicator lights up and the frequency of the received station is shown in the front panel display.

Manual tuning

If the signal from the station you want to select is weak, tune into it manually. Manually tuning into an FM station will automatically switch the tuner to monaural reception to increase the signal quality.

1 Select TUNER and the reception band following steps 1 and 2 as described in “Automatic tuning”.

2 Press TUNING MODE (AUTO/MAN'L MONO) so that the AUTO indicator disappears from the front panel display.



If a colon (:) appears in the front panel display, tuning is not possible. Press PRESET/TUNING (EDIT) to turn the colon (:): off.

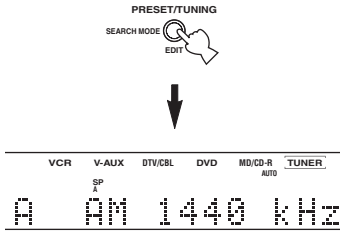

3 Press PRESET/TUNING/CH </> to tune into the desired station manually.

Hold down the button to continue searching.



Presetting stations

Automatically presetting FM stations

You can use the automatic preset tuning feature to store FM stations. This function enables this unit to automatically tune into FM stations with strong signals, and to store up to 40 (8 stations in 5 groups, A1 through E8) of those stations in order. You can then recall any preset station easily by selecting the preset station number.

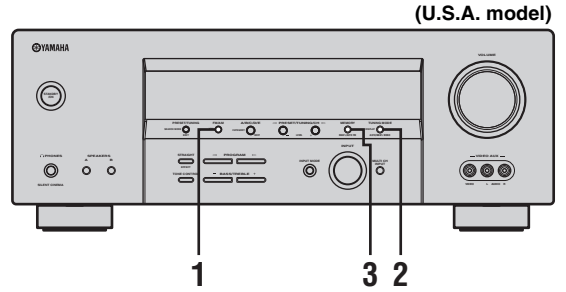

1 Press FM/AM to select the FM band.



2 Press TUNING MODE (AUTO/MAN'L MONO) so that the AUTO indicator lights up in the front panel display.



If a colon (:) appears in the front panel display, tuning is not possible. Press PRESET/TUNING (EDIT) to turn the colon (:): off.

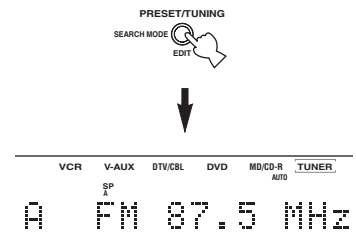

3 Press and hold MEMORY (MAN'L/AUTO FM) for more than 3 seconds.

The preset number, the MEMORY and AUTO indicators flash. After about 5 seconds, automatic presetting starts from the frequency currently displayed and proceeds toward the higher frequencies.

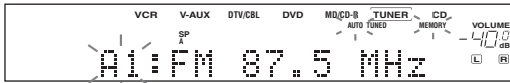

When automatic preset tuning is completed, the front panel display shows the frequency of the last preset station.

Notes

- Any stored station data existing under a preset number is cleared when you store a new station under that preset number.
- If the number of received stations does not reach 40 (E8), automatic preset tuning has automatically stopped after searching all stations.
- Only FM stations with sufficient signal strength are stored automatically by automatic preset tuning. If the station you want to store is weak in signal strength, tune into it manually and store it by following the procedure in “Manually presetting stations”.

Automatic preset tuning options:

You can select the preset number from which this unit will store FM stations and/or begin tuning toward lower frequencies.

After pressing MEMORY in step 3:

- 1 Press A/B/C/D/E (NEXT), then PRESET/TUNING/CH <|/> to select the preset number under which the first station will be stored. Automatic preset tuning will stop when stations have all been stored up to E8.
- 2 Press PRESET/TUNING (EDIT) to turn off the colon (:) and then press PRESET/TUNING/CH <|/> to begin tuning toward the lower frequencies.

Memory back-up

The memory back-up circuit prevents the stored data from being lost even if this unit is set in the standby mode, the power cord is disconnected from the AC outlet, or the power supply is temporarily cut due to power failure. However, if the power is cut for more than one week, the preset stations may be cleared. If so, store the stations again by using the presetting station methods.

Manually presetting stations

You can also store up to 40 stations (8 stations x 5 groups) manually.

(U.S.A. model)

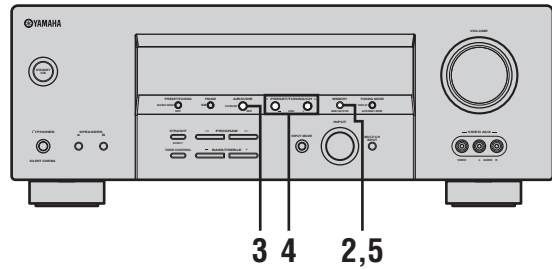

1 Tune into a station.

See page 33 for tuning instructions.

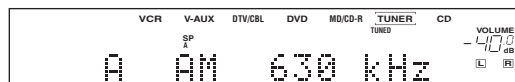

When tuned into a station, the front panel display shows the frequency of the station received.

2 Press MEMORY (MAN'L/AUTO FM).

The MEMORY indicator flashes for about 5 seconds.

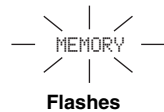

Flashes

3 Press A/B/C/D/E (NEXT) repeatedly to select a preset station group (A to E) while the MEMORY indicator is flashing.

The group letter appears. Check that the colon (:) appears in the front panel display.

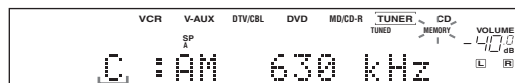

Preset group

4 Press PRESET/TUNING/CH </> to select a preset station number (1 to 8) while the MEMORY indicator is flashing.

Press > to select a higher preset station number.
Press < to select a lower preset station number.

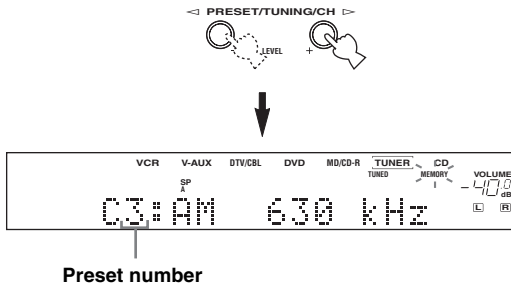

5 Press MEMORY (MAN'L/AUTO FM) on the front panel while the MEMORY indicator is flashing.

The station band and frequency appear in the front panel display with the preset group and number you have selected.

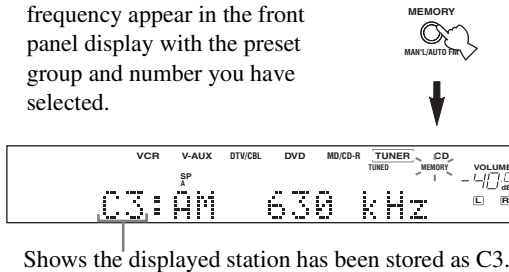

6 Repeat steps 1 to 5 to store other stations.

Notes

- Any stored station data existing under a preset number is cleared when you store a new station under that preset number.
- The reception mode (stereo or monaural) is stored along with the station frequency.

Selecting preset stations

You can tune any desired station simply by selecting the preset station number under which it was stored.

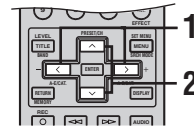
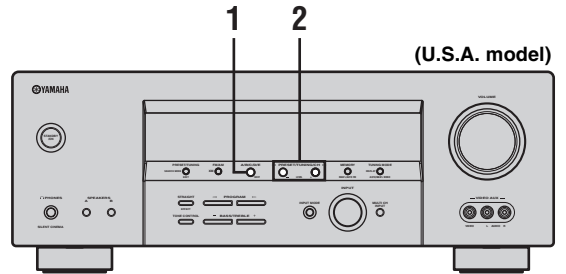

When performing this operation with the remote control, first press TUNER to set the remote to tuner mode.

1 Press A/B/C/D/E (NEXT) (or A-E/CAT. </>) on the remote control) to select the preset station group.

The preset group letter appears in the front panel display and changes each time you press the button.

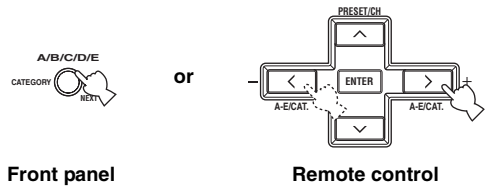

2 Press PRESET/TUNING/CH ◀/▶ (or PRESET/CH ^/∨ on the remote control) to select a preset station number (1 to 8).

The preset group and number appear in the front panel display along with the station band, frequency and the TUNED indicator lights up.

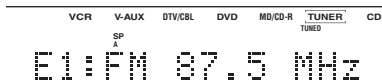
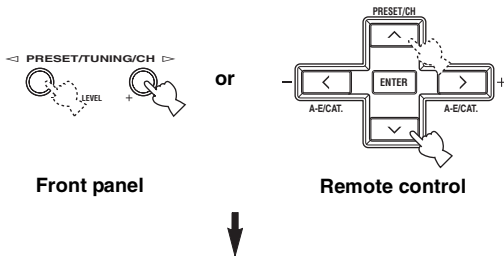

Exchanging preset stations

You can exchange the assignment of two preset stations with each other. The example below describes the procedure for exchanging preset station “E1” with “A5”.

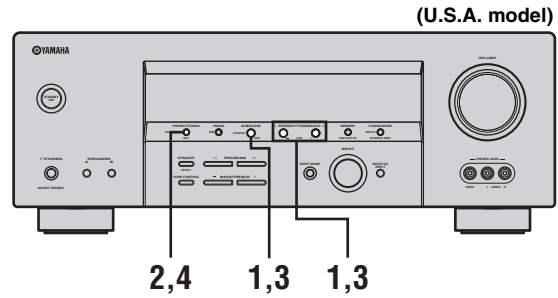

1 Select preset station “E1”.

See “Selecting preset stations”.

2 Press and hold PRESET/TUNING (EDIT) for more than 3 seconds.

“E1” and the MEMORY indicator flash in the front panel display.

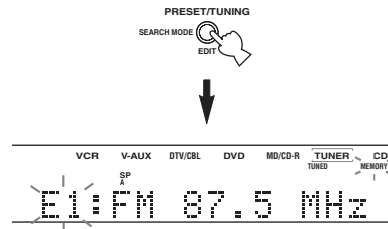

3 Select preset station "A5" using A/B/C/D/E and PRESET/TUNING/CH </>.

"A5" and the MEMORY indicator flash in the front panel display.

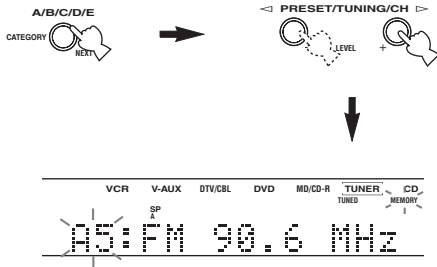

4 Press PRESET/TUNING (EDIT) again.

The stations stored at the two preset assignments are exchanged.

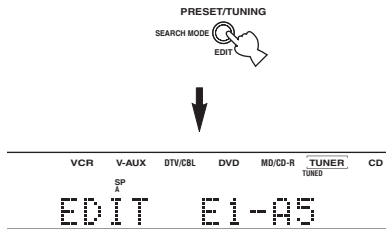

XM SATELLITE RADIO TUNING

What is XM Satellite Radio?

XM Satellite Radio is the satellite radio service with millions of listeners across the U.S., broadcasting live daily. XM's channel lineup includes more than 130 digital channels of choice from coast to coast: 68 commercial-free music channels, featuring hip hop to opera, classical to country, bluegrass to blues; 33 channels of premier sports, talk, comedy, children's and entertainment programming; and more than 20 channels of the traffic and weather information for major metropolitan areas nationwide.

Because XM Satellite Radio is a subscription service, you will need to set up an account and activate service with XM using your XM Satellite Radio ID number. To check your ID number, follow "Activating XM Satellite Radio" on page 40. For further information on XM Satellite Radio services, see the XM Satellite Radio website at "http://www.xmradio.com".

Notes

- The XM Satellite Radio service is only available in the 48 contiguous United States (not available in Alaska and Hawaii).
- XM Connect and Play digital antenna accessory and monthly subscription are sold separately. For details, see the XM Satellite Radio website at "http://www.xmradio.com".

XM Satellite Radio connections

■ Connecting the XM Connect and Play digital antenna accessory

Connect the XM Connect and Play digital antenna accessory (sold separately) to the XM jack on the rear of this unit. (For details, see the operating instructions provided with the XM Connect and Play digital antenna accessory.)

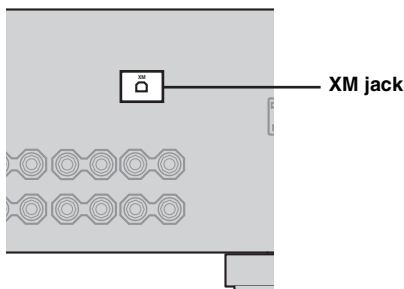

Notes

- For information on obtaining the XM Connect and Play digital antenna accessory, see the website at "http://www.xmradio.com" or visit your local retailer that sells XM Ready products.
- To ensure optimal reception of XM's satellite signal, the XM Connect and Play digital antenna accessory should be placed at or near a southerly facing window with nothing obstructing its path to the sky. You can mount it indoors or outdoors.

XM Satellite Radio functions

This section describes the functions of each control used for XM Satellite Radio tuning.

■ Front panel functions

Note

The following controls are only available when the unit is in the TUNER mode and the XM Connect and Play digital antenna accessory is connected to the XM jack on the rear of this unit. (For details, see "XM Satellite Radio connections".)

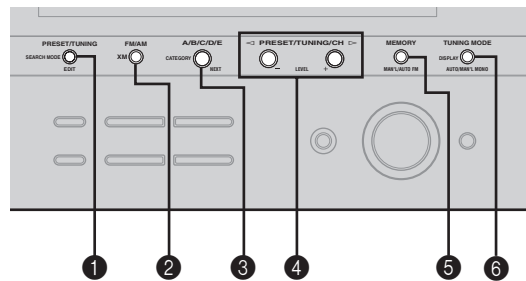

1 SEARCH MODE

Switches between the All Channel Search, Category Search, and Preset Search modes. (For details, see "XM Satellite Radio search modes" on page 42.)

2 XM

Switches the reception band between AM, FM and XM.

3 CATEGORY

(All Channel Search mode)

Changes the channel category to next one (while staying in the All Channel Search mode).

(Category Search mode)

Changes the channel category to next one.

(Preset Search mode)

Switches between five preset groups (A to E).

4 PRESET/TUNING/CH ◀ / ▶

(All Channel Search mode)

Searches a radio channel within all channels. Press and hold for quick search.

(Category Search mode)

Searches a radio channel within the selected category. Press and hold for quick search.

(Preset Search mode)

Changes the preset number (1 to 8).

5 MEMORY

Switches the unit to the preset memory mode.

6 DISPLAY

Switches XM information such as channel number/name, category, or artist name/song title displayed in the front panel display. (For details, see "Switching XM information" on page 42.)

Remote control functions

Note

The following controls are only available when the unit is in the TUNER mode. To switch to the TUNER mode, press TUNER to select TUNER as the input source.

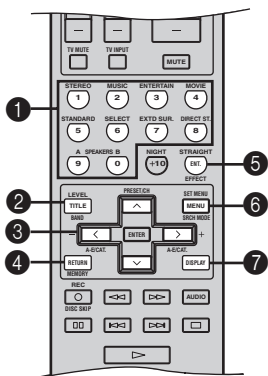

- 1 **Numeric buttons**
(All Channel Search or Category Search mode)
Use 1 to 9 and 0 to enter a channel number directly.
(Preset Search mode)
Use 1 to 8 to enter a preset channel number directly.

- 2 **BAND**
Switches the reception band between the currently selected band (AM or FM) and XM.

- 3 **Cursor buttons** $\wedge / \vee / \langle / \rangle$
(All Channel Search mode)
Press A-E/CAT. \langle / \rangle to change the channel category.
Press PRESET/CH \wedge / \vee to search a radio channel within all channels. Press and hold for quick search.
(Category Search mode)
Press A-E/CAT. \langle / \rangle to change the channel category.
Press PRESET/CH \wedge / \vee to search a radio channel within the selected category. Press and hold for quick search.
(Preset Search mode)
Press A-E/CAT. \langle / \rangle to change the preset group (A to E).
Press PRESET/CH \wedge / \vee to change the preset number (1 to 8).

- 4 **MEMORY**
Switches the unit to the preset memory mode.

- 5 **ENT.**
Confirms an entered channel number during the Direct Number Access mode (see pages 44).

- 6 **SRCH MODE**
Switches between the All Channel Search, Category Search, and Preset Search modes. (For details, see "XM Satellite Radio search modes" on page 42.)

- 7 **DISPLAY**
Switches XM information such as channel number/name, category, or artist name/song title displayed in the front panel display. (For details, see "Switching XM information" on page 42.)

Activating XM Satellite Radio

To sign up for an account with the XM Satellite Radio service, an XM Satellite Radio ID number is required. Follow the procedure below to check your ID number, and then access the website at "http://activate.xmradio.com" or call "1-800-XM-RADIO (1-800-967-2346)" with a major credit card for signing up.

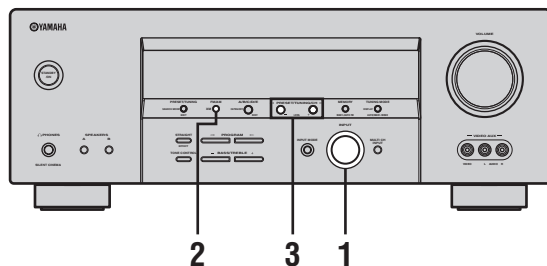

- 1 **Rotate INPUT (or press TUNER on the remote control) to select TUNER as the input source.**

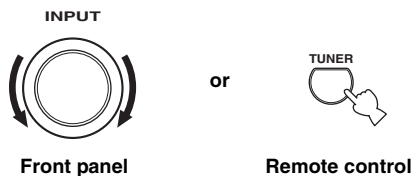

- 2 **Press XM (or BAND on the remote control) to select "XM" as the reception band.**

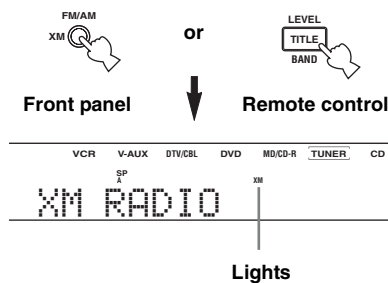

If "CHECK ANTENNA" appears in the front panel display, the XM Connect and Play digital antenna accessory may not be connected to the XM jack on the rear of this unit properly. See "XM Satellite Radio connections" on page 39 and check the connection.

3 Press PRESET/TUNING/CH ◀/▶ (or PRESET/CH ^/∨ on the remote control) to select channel “0”.

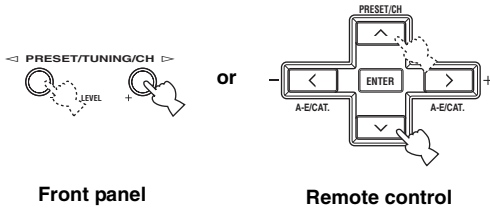

Note

You cannot select channel “0” if the “All Channel Search mode” (see page 42) is not selected.

4 Check the XM Satellite Radio ID number displayed in the front panel display and write it down.

ID: _____

Basic XM Satellite Radio operations

Selecting the XM Satellite Radio mode

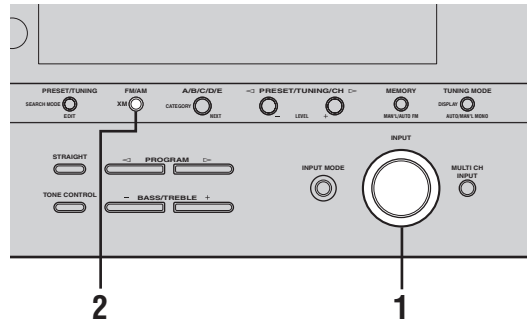

1 Rotate INPUT (or press TUNER on the remote control) to select TUNER as the input source.

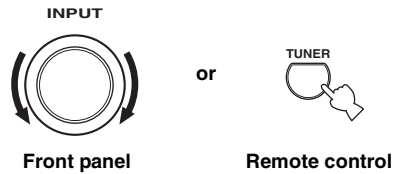

2 Press XM (or BAND on the remote control) to select “XM” as the reception band.

Information (such as channel number/name, category, or artist name/song title) for the channel currently selected appears in the front panel display and the XM indicator lights up.

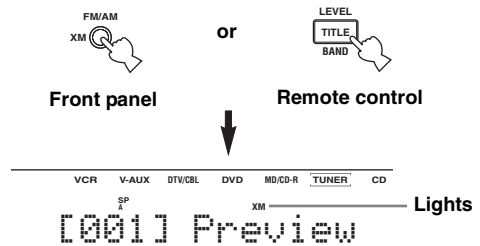

- Selecting the “XM” band automatically recalls the channel previously selected.
- You can change the kind of XM information by pressing DISPLAY repeatedly. (For details, see “Switching XM information” on page 42.)

Note

XM Satellite Radio signals cannot be output from the AUDIO OUT (REC) jacks.

BASIC OPERATION

■ Switching XM information

You can display XM information (such as channel number/name, category, or artist name/song title) for the channel currently selected in the front panel display.

Press DISPLAY on the unit (or remote control during the TUNER mode) repeatedly to toggle between the following XM information display modes.

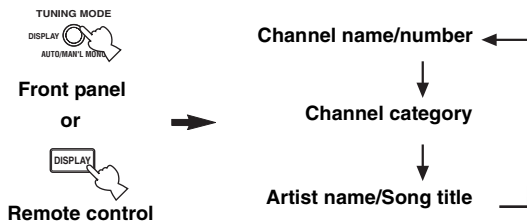

When the channel number/name is displayed:



When the channel category is displayed:

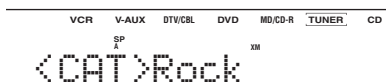

When the artist name/song title is displayed:

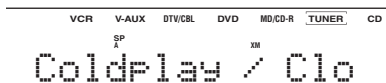

- The front panel display can indicate up to 14 alphanumeric characters at once. If the information contains more than 14 characters, the information scrolls from right to left.
- If the information contains a character that cannot be recognized by the unit, the character will be displayed with an underbar “_”.

Note

If a status message or an error message appears in the display, see “Status and error messages” on page 47.

XM Satellite Radio search modes

You can search for the channel you want to listen to using one of three search modes. You can also enter the number directly to select the desired channel. (For details, see “Direct Number Access mode” on page 44.)

■ All Channel Search mode

(U.S.A. model)

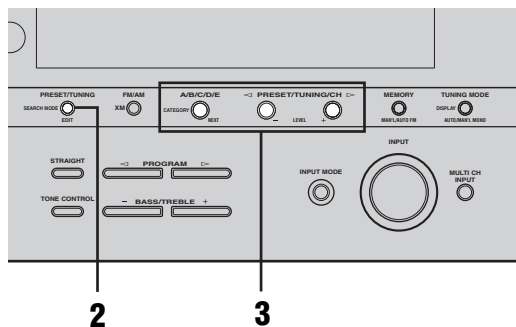

1 Carry out “Selecting the XM Satellite Radio mode” on page 41.

2 Press SEARCH MODE (or SRCH MODE on the remote control) repeatedly to select “ALL CH SEARCH”.

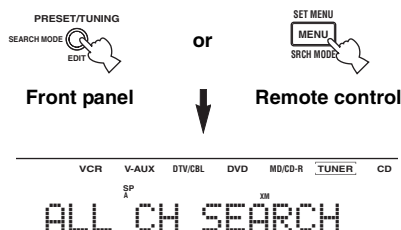

- 3** To change the channel category, press **CATEGORY** (or **A-E/CAT.** </> on the remote control) repeatedly.



Front panel

or

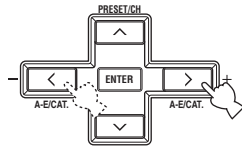

Remote control

To search a channel within all channels, press **PRESET/TUNING/CH** </> (or **PRESET/CH** ^/∨ on the remote control) repeatedly.

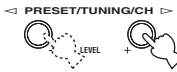

Front panel

or

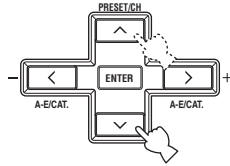

Remote control



You can search a channel with the quick search by pressing and holding **PRESET/TUNING/CH** </> (or **PRESET/CH** ^/∨ on the remote control).

Category Search mode

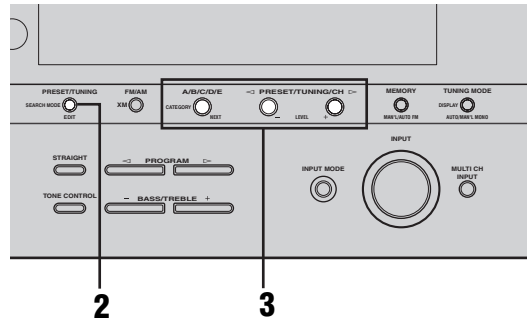

- 1** Carry out “Selecting the XM Satellite Radio mode” on page 41.

- 2** Press **SEARCH MODE** (or **SRCH MODE** on the remote control) repeatedly to select “**CAT SEARCH**”.

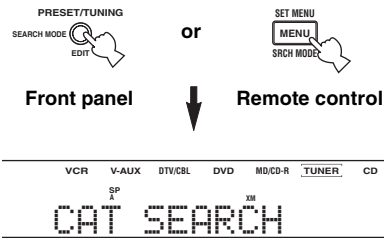

- 3** To change the channel category, press **CATEGORY** (or **A-E/CAT.** </> on the remote control) repeatedly.



Front panel

or

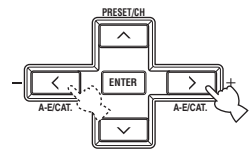

Remote control

To search a channel within the selected channel category, press **PRESET/TUNING/CH** </> (or **PRESET/CH** ^/∨ on the remote control) repeatedly.



Front panel

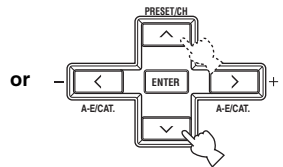

Remote control



You can search a channel with the quick search by pressing and holding **PRESET/TUNING/CH** </> (or **PRESET/CH** ^/∨ on the remote control).

■ Preset Search mode

Prior to selecting a preset channel in the Preset Search mode, you should preset XM Satellite Radio channels. For details, see “Setting XM Satellite Radio preset channels” on page 45. All preset channels (A1 to E8) recalls “001 Preview” by the factory setting.

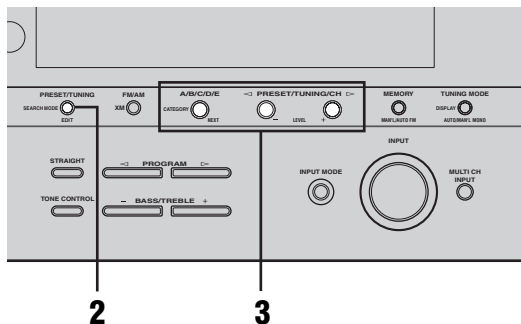

1 Carry out “Selecting the XM Satellite Radio mode” on page 41.

2 Press SEARCH MODE (or SRCH MODE on the remote control) repeatedly to select “PRESET SEARCH”.

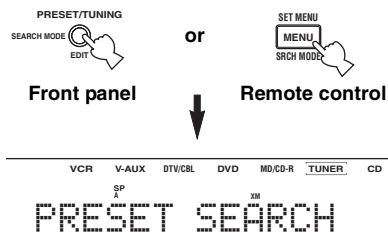

3 To change the preset group (A to E), press CATEGORY (or A-E/CAT. </> on the remote control) repeatedly.

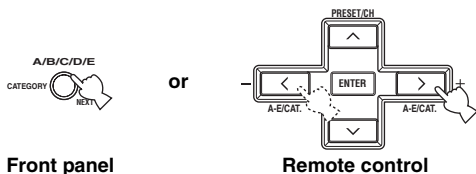

To change the preset number (1 to 8), press PRESET/TUNING/CH </> (or PRESET/CH ^ / v on the remote control) repeatedly.

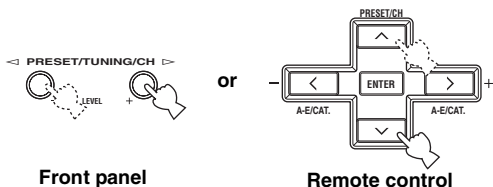

■ Direct Number Access mode

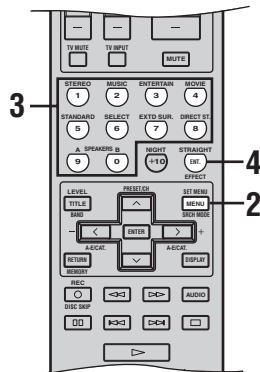

1 Carry out “Selecting the XM Satellite Radio mode” on page 41.

2 Press SEARCH MODE (or SRCH MODE on the remote control) repeatedly to select “ALL CH SEARCH” or “CAT SEARCH”.

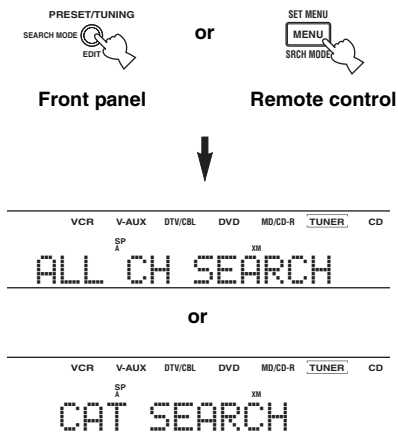

You can also select the preset number directly by pressing the numeric buttons (1 to 8) on the remote control.

3 Press the numeric buttons to enter the desired channel number.

For example, to enter the number 123, press the numeric buttons as shown below.



The display changes as follows.

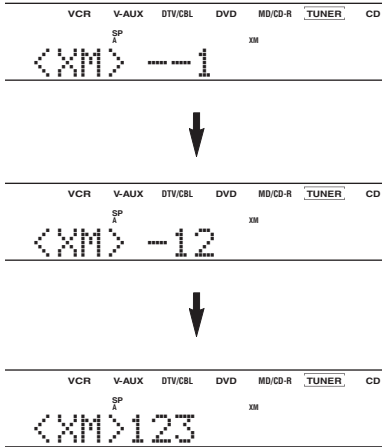

4 If you enter fewer than three numbers, you may press ENT. to tune to the channel immediately or wait a few seconds to confirm the entered channel number.



- If no button is pressed within a few seconds after entering one-digit or two-digit number, the unit automatically confirms the entered channel number.
- Pressing a button other than numeric buttons or ENT. cancels the direct number access procedure.

Setting XM Satellite Radio preset channels

You can use this feature to store up to 40 XM Satellite Radio channels (eight preset numbers in five preset groups, A1 to E8). You can then recall any preset channel easily by selecting the preset group and number as described in “Preset Search mode” on page 44.

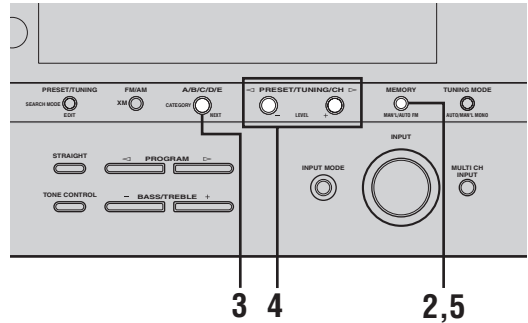

1 Search the XM Satellite Radio channel you want to set as a preset channel.

To search the desired channel, carry out “All Channel Search mode” on page 42, “Category Search mode” on page 43, or “Direct Number Access mode” on page 44.

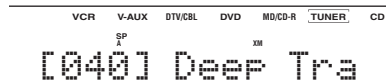

When the channel number “040” is selected

2 Press MEMORY on the unit (or remote control during the TUNER mode).

The MEMORY indicator flashes for about five seconds.

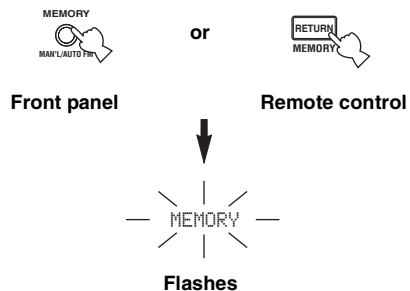

- 3** While the MEMORY indicator is flashing, press **CATEGORY** (or **A-E/CAT.** </> on the remote control) to select a preset group (A to E).

The group letter appears.

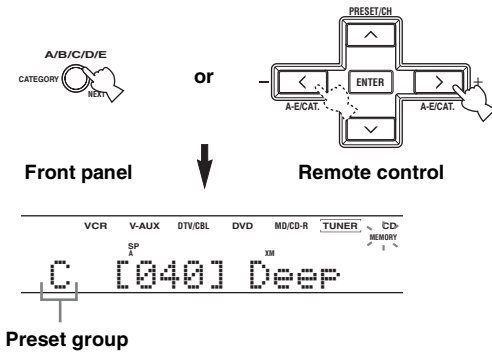

- 5** While the MEMORY indicator is flashing, press **MEMORY** on the unit (or the remote control) to preset the selected XM Satellite Radio channel.

A colon appears next to the preset number for confirmation, and the MEMORY indicator turns off.

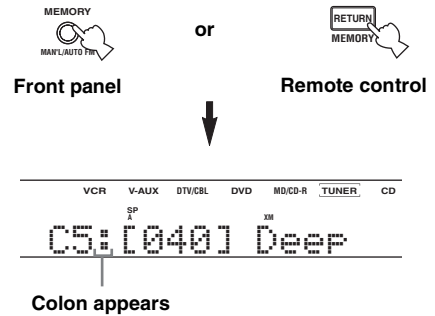

- 4** While the MEMORY indicator is flashing, press **PRESET/TUNING/CH** </> (or **PRESET/CH** ^/∨ on the remote control) to select a preset number (1 to 8).

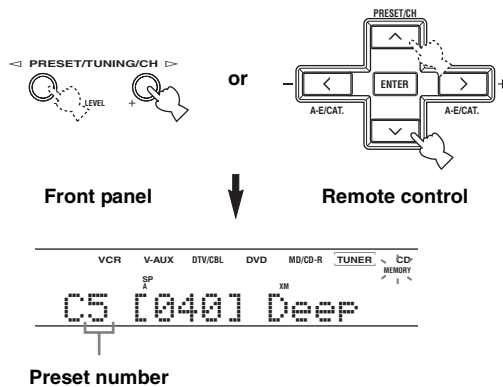

Note

Presetting a new channel clears the former preset channel stored in the same preset group and number.

■ **Status and error messages**

If an operation takes longer than usual or an error occurs, one of the following messages may appear in the front panel display. In this case, read the cause and follow the corresponding remedies.

Message	Cause	Remedy
CHECK ANTENNA	The XM Connect and Play digital antenna accessory is not connected, or does not work properly.	<ul style="list-style-type: none"> • Check the XM Connect and Play digital antenna accessory connections.
UPDATING	The XM user encryption code is being updated.	<ul style="list-style-type: none"> • Wait until the encryption code is updated.
NO SIGNAL	The signal is too weak.	<ul style="list-style-type: none"> • Check the XM Connect and Play digital antenna accessory connections and orient it for the best reception.
LOADING	It takes longer than four seconds for audio or text data to be decoded.	<ul style="list-style-type: none"> • Wait until the decoding process has finished.
OFF AIR	The XM Satellite Radio channel you selected is not currently broadcasting any signal.	<ul style="list-style-type: none"> • Check the channel number again or select another XM Satellite Radio channel.
<XM> - - -	The channel Station ID (SID) is no longer available.	
- - - / - - -	No artist name/feature or song/program title is available.	
<CAT> - - -	No channels are available for the selected category.	<ul style="list-style-type: none"> • Select another channel category by pressing CATEGORY (or A-E/CAT, </> on the remote control) repeatedly.

RECORDING

Recording adjustments and other operations are performed from the recording components. Refer to the operating instructions for those components.

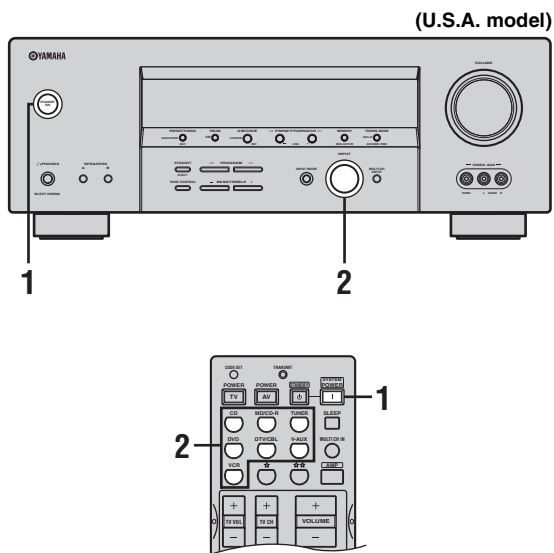

1 Turn on the power of this unit and all connected components.

2 Select the source component you want to record from.

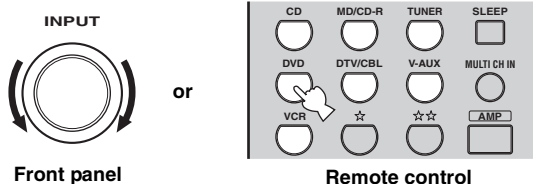

3 Start playback (or select a broadcast station) on the source component.

4 Start recording on the recording component.



Do a test recording before you start an actual recording.

Notes

- When this unit is set in the standby mode, you cannot record between other components connected to this unit.
- The setting of TONE CONTROL, VOLUME, "SP LEVEL" (page 57) and the sound field programs does not affect recorded material.
- A source connected to the MULTI CH INPUT jacks of this unit cannot be recorded.
- S-video and composite video signals pass independently through this unit's video circuits. Therefore, when recording or dubbing video signals, if your video source component is connected to provide only an S-video (or only a composite video) signal, you can record only an S-video (or only a composite video) signal to your VCR.
- Digital signals input to the DIGITAL INPUT jacks are not output to the analog AUDIO OUT (L/R) jacks for recording. You can only record analog signals.
- A given input source is not output on the same REC OUT channel. (For example, the signal input from VCR IN is not output on VCR OUT.)
- Check the copyright laws in your country to record from records, CDs, radio, etc. Recording of copyrighted material may infringe copyright laws.

If you playback a video source that uses scrambled or encoded signals to prevent it from being dubbed, the picture itself may be disturbed due to those signals.

Special considerations when recording DTS software

The DTS signal is a digital bitstream. Attempting to digitally record the DTS bitstream will result in noise being recorded. Therefore, if you want to use this unit to record sources that have DTS signals recorded on them, the following considerations and adjustments need to be made.

For DVDs and CDs encoded with DTS, when your player is compatible with the DTS format, follow its operating instructions to make a setting so that the analog signal will be output from the player.

SOUND FIELD PROGRAM DESCRIPTIONS

This unit is equipped with a variety of precise digital decoders that allow you to enjoy multi-channel playback from almost any sound source (stereo or multi-channel). This unit is also equipped with a YAMAHA digital sound field processing (DSP) chip containing several sound field programs which you can use to enhance your playback experience. Most of these sound field programs are precise digital recreations of actual acoustic environments found in famous concert halls, music venues, and movie theaters.



The YAMAHA CINEMA DSP modes are compatible with all Dolby Digital, DTS, and Dolby Surround sources. Set the input mode to AUTO (see page 31) to enable this unit to automatically switch to the appropriate digital decoder according to the input signal.

Notes

- This unit's DSP sound field programs are recreations of real-world acoustic environments made from precise measurements taken in the actual hall, etc. Thus you may notice variations in the strength of the reflections coming from the front, back, left and right.
- Feel free to choose a sound field program based on your listening preference, and not purely on the name of the program itself.

For movie/video sources

You can select from the following sound fields when playing movie or video sources. The sound fields marked "MULTI" can be used with multi-channel sources, like DVD, digital TV, etc. Those marked "2-CH" can be used with 2-channel (stereo) sources like TV programs, video tapes, etc

Program selection methods vary depending on sound field program types. For details on how to select sound field programs, see "Selecting sound field programs" on pages 27 to 31.

Remote control button	Program	Features	Sources
1	STEREO: 2ch Stereo	Downmixes multi-channel sources to 2 channels (left and right) or plays back 2-channel sources as is.	MULTI 2-CH
2	MUSIC: Pop/Rock	This program lends an enthusiastic atmosphere to the sound, giving you the feeling you are at an actual jazz or rock concert.	
3	ENTERTAINMENT: TV Sports	Though the presence sound field is relatively narrow, the surround sound field employs the sound environment of a large concert hall. This effect enhances the experience of watching various TV programs such as news, variety shows, music programs or sports programs.	
	ENTERTAINMENT: Mono Movie	This program is provided for reproducing monaural video sources (such as old movies). The program produces the optimum reverberation to create sound depth using only the presence sound field.	
	ENTERTAINMENT: Game	This program adds a deep and spatial feeling to video game sounds.	

SOUND FIELD PROGRAM DESCRIPTIONS

Remote control button	Program	Features	Sources
4	MOVIE THEATER: Spectacle	CINEMA DSP processing. This program creates the extremely wide sound field of a 70-mm movie theater. It precisely reproduces the source sound in detail, making both the video and the sound field incredibly real. This is ideal for any kind of video source encoded with Dolby Surround, Dolby Digital or DTS (especially large-scale movie productions).	MULTI 2-CH
	MOVIE THEATER: Sci-Fi	CINEMA DSP processing. This program clearly reproduces dialog and sound effects in the latest sound form for science fiction films, thus creating a broad and expansive cinematic space amid silence. You can enjoy science fiction films in a virtual-space sound field that includes Dolby Surround, Dolby Digital and DTS-encoded software employing the most advanced techniques.	
	MOVIE THEATER: Adventure	CINEMA DSP processing. This program is ideal for precisely reproducing the sound design of the newest 70-mm and multi-channel soundtrack films. The sound field is made to be similar to that of the newest movie theaters, so the reverberations of the sound field itself are restrained as much as possible.	
	MOVIE THEATER: General	CINEMA DSP processing. This program is for reproducing sounds from 70-mm and multi-channel soundtrack films, and is characterized by soft and extensive sound field.	
5	SUR. STANDARD	Standard processing for the selected decoder.	
	SUR. ENHANCED	Enhanced processing for the selected decoder.	

For music sources

You can select from the following sound fields when playing music sources, like CD, FM/AM broadcasting, tapes, etc.

Program selection methods vary depending on sound field program types. For details on how to select sound field programs, see “Selecting sound field programs” on pages 27 to 31.

Remote control button	Program	Features	Sources
1	STEREO: 2ch Stereo	2-channel (left and right) playback.	2-CH
	STEREO: 6ch Stereo	Use to increase the output stereo sources (in stereo) from all speakers. This provides a larger sound field and is ideal for background music at parties, etc.	
2	MUSIC: Hall in Vienna	HiFi DSP processing. A classic shoe-box type concert hall with approximately 1700 seats. Pillars and ornate carvings create extremely complex reflections which produce a very full, rich sound.	MULTI 2-CH
	MUSIC: The Btm Line	HiFi DSP processing. This is the sound field at stage front in “The Bottom Line”, a famous New York jazz club. The floor can seat 300 people to the left and right in a sound field offering a real and vibrant sound.	
	MUSIC: The Roxy Thtr	HiFi DSP processing. The ideal program for lively, dynamic rock music. The data for this program was recorded at LA’s “hottest” rock club. The listener’s virtual seat is at the center-left of the hall.	
3	ENTERTAINMENT: Disco	HiFi DSP processing. This program recreates the acoustic environment of a lively disco in the heart of a big city. The sound is dense and highly concentrated. It is also characterized by high-energy, “immediate” sound.	
5	SUR. STANDARD	Standard processing for the selected decoder.	
	SUR. ENHANCED	Enhanced processing for the selected decoder.	

ADVANCED OPERATIONS

Using the sleep timer

Use this feature to automatically set this unit in the standby mode after a certain amount of time. The sleep timer is useful when you are going to sleep while this unit is playing or recording a source. The sleep timer also automatically turns off any external components connected to AC OUTLET(S).

■ Setting the sleep timer

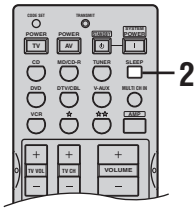

1 Select a source and start playback on the source component.

2 Press SLEEP repeatedly to set the amount of time.

Each time you press SLEEP, the front panel display changes as shown below. The SLEEP indicator flashes while switching the amount of time for the sleep timer.

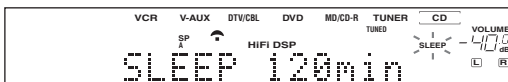
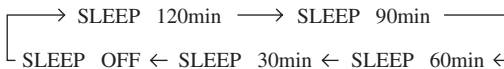

The SLEEP indicator lights up in the front panel display, and the display returns to the selected sound field program.

SLEEP indicator



■ Canceling the sleep timer

Press SLEEP repeatedly until “SLEEP OFF” appears in the front panel display.

After a few seconds, “SLEEP OFF” disappears, and the SLEEP indicator goes off.



The sleep timer setting can also be canceled by pressing STANDBY on the remote control (or STANDBY/ON on the front panel) to set this unit to the standby mode.

Manually adjusting speaker levels

You can adjust the output level of each speaker while listening to a music source. This is also possible when playing sources through the MULTI CH INPUT jacks. Please note that this operation will override the level adjustments made in “BASIC SETUP” (page 22) and “SP LEVEL” (page 57).

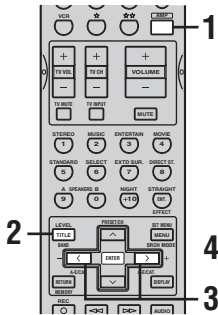

1 Press AMP.

2 Press LEVEL repeatedly to select the speaker you want to adjust.

- FRONT L Front left speaker level
- CENTER Center speaker level
- FRONT R Front right speaker level
- SUR. R Surround right speaker level
- SUR. B Surround back speaker level
- SUR. L Surround left speaker level
- SWFR Subwoofer level



Once you press LEVEL, you can also select the speaker by pressing \wedge / \vee .

3 Press \langle / \rangle to adjust the speaker output level.
The control range is from +10 dB to -10 dB.

4 Press ENTER when you have completed your adjustment.



This operation can also be performed using the controls on the front panel. Press NEXT repeatedly to select the speaker you want to adjust, then press LEVEL $-/+$ to adjust the output level.

SET MENU

You can use the following parameters in SET MENU to adjust a variety of system settings and customize the way this unit operates. Change the initial settings (indicated in bold under each parameter) to reflect the needs of your listening environment.

■ BASIC SETUP

Use to quickly setup basic system parameters (see page 22).

■ MANUAL SETUP

Use to adjust speaker and system settings manually.

1 SOUND MENU

Use to manually adjust any speaker setting, alter the quality and tone of the sound output by the system or compensate for video signal processing delays when using LCD monitors or projectors.



Most of the parameters described in SOUND MENU are set automatically when you perform “BASIC SETUP” (see page 22). You can use SOUND MENU to make further adjustments.

Item	Features	Page
A)SPEAKER SET	Selects the size of each speaker, the speakers for low-frequency signal output, and the cross over frequency.	56
B)SP LEVEL	Adjusts the output level of each speaker.	57
C)SP DISTANCE	Adjusts the delay time of each speaker.	57
D)CENTER GEO	Adjusts the tonal quality of the center speaker.	57
E)LFE LEVEL	Adjusts the output level of the LFE channel for Dolby Digital or DTS signals.	57
F)D. RANGE	Adjusts the dynamic range for Dolby Digital or DTS signals.	57
G)AUDIO SET	Customizes the muting level and audio delay.	58

2 INPUT MENU

Use to reassign digital input/outputs and select the input mode.

Item	Features	Page
A)I/O ASSIGN	Assigns jacks according to the component to be used.	58
B)INPUT MODE	Selects the initial input mode of the source.	59
C)INPUT RENAME	Changes the name of the inputs.	59

3 OPTION MENU

Use to adjust the optional system parameters.

Item	Features	Page
A)DISPLAY SET	Adjusts the brightness of the display.	59
B)MEMORY GUARD	Locks sound field program parameters and other SET MENU settings.	59
C)PARAM. INI	Initializes the parameters of a group of sound field programs.	59
D)MULTI ZONE	Specifies the location of the speakers connected to the SPEAKERS B terminals.	60
E)XM RADIO SET	Displays the current reception level for the XM Connect and Play digital antenna accessory.	60

Using SET MENU

Use the remote control to access and adjust each parameter.

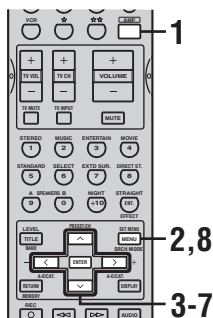

You can change SET MENU parameters while the unit is reproducing sound.

Note

You cannot change some SET MENU parameters while the unit is in either cinema or music night listening mode.

1 Press AMP.

2 Press SET MENU.

“BASIC SETUP” appears in the front panel display.

3 Press ^ / v to display MANUAL SETUP.

MANUAL SETUP

4 Press ENTER to enter MANUAL SETUP.

1 SOUND MENU appears in the front panel display.

1 SOUND MENU

5 Press ^ / v to display the desired menu.

```

1 SOUND MENU
  ↓
2 INPUT MENU
  ↓
3 OPTION MENU
  ↗
1 SOUND MENU
  
```

6 Press ENTER to enter the displayed menu.

Repeat steps 5 and 6 to navigate to and enter the items you want to adjust.

To return to the previous menu level, press RETURN.

7 Press ^ / v to select the item you want to adjust, then press < / > to change the setting of the item.

Repeat this operation to select and adjust each setting.

To return to the previous menu level, press RETURN.

8 To exit, press SET MENU when finished.

Memory back-up

The memory back-up circuit prevents the stored data from being lost even if this unit is in the standby mode. However, if the power cord is disconnected from the AC outlet, or the power supply is cut for more than one week, the stored data will be lost. If so, adjust the items again.

1 SOUND MENU

Use to manually adjust any speaker setting or compensate for video signal processing delays when using LCD monitors or projectors. Most of the SOUND MENU parameters are set automatically when you perform "BASIC SETUP" (see page 22).

■ Speaker settings A) SPEAKER SET

Use to manually adjust any speaker setting.



If you are not satisfied with the bass sounds from your speakers, you can change these settings according to your preference.

Front speakers FRONT

Choices: **LARGE**, SMALL

- Select **LARGE** if you have large front speakers. The unit directs the entire range of the front left and right channel signals to the front left and right speakers.
- Select **SMALL** if you have small front speakers. The unit directs the low-frequency signals of the front channel to the speakers selected with "BASS OUT".

Center speaker CENTER

Choices: LRG, **SML**, NONE

- Select **LRG** if you have a large center speaker. The unit directs the entire range of the center channel signal to the center speaker.
- Select **SML** if you have a small center speaker. The unit directs the low-frequency signals of the center channel to the speakers selected with "BASS OUT".
- Select **NONE** if you do not have a center speaker. The unit directs all of the center channel signal to the front left and right speakers.

Surround left/right speakers SUR. LR

Choices: LRG, **SML**, NONE

- Select **LRG** if you have large surround left and right speakers. The entire range of the surround channel signal is directed to the surround left and right speakers.
- Select **SML** if you have small surround left and right speakers. The low-frequency signals of the surround channel are directed to the speakers selected with "BASS OUT".
- Select **NONE** if you do not have surround speakers. This will set the unit to the Virtual CINEMA DSP mode (see page 31) and automatically set the surround back speaker setting (SUR. B) to **NONE**.

Surround back speaker SUR. B

Choices: LRG, **SML**, NONE

- Select **LRG** if you have a large surround back speaker.
- Select **SML** if you have a small surround back speaker. The low-frequency signals of the surround back channel are directed to the speakers selected with "BASS OUT", and the rest of the frequency signals are directed to the surround back speaker.
- Select **NONE** if you do not have a surround back speaker. The unit directs all of the surround back channel signal to the surround left and right speakers.

Bass out BASS OUT

Low-frequency (bass) signals can be directed to the subwoofer and/or the front left and right speakers according to the characteristics of your system. This setting also determines the routing of the LFE (low-frequency effect) signals found in Dolby Digital or DTS sources.

Choices: SWFR (subwoofer), FRONT, **BOTH**

- Select **SWFR** if you connect a subwoofer. LFE and low-frequency signals from other channels are directed to the subwoofer according to the speaker settings.
- Select **FRONT** if you do not use a subwoofer. LFE and low-frequency signals from other channels are directed to the front speakers according to the speaker settings (even if you have previously set the front speakers to **SML**).
- Select **BOTH** if you connect a subwoofer and you want to output low-frequency signals from front channels to both the front speakers and subwoofer. LFE and low-frequency signals from other channels are also directed to the subwoofer according to the speaker settings. Use this function to reinforce low-frequency signals using the subwoofer when playing back sources such as CDs.

Cross over CrossOver

Use this feature to select a cross-over (cut-off) frequency for all low-frequency signals. All frequencies below the selected frequency will be sent to the subwoofer.

Choices: 40Hz, 60Hz, **80Hz**, 90Hz, 100Hz, 110Hz, 120Hz, 160Hz, 200Hz

Subwoofer phase SWFR PHASE

If bass sounds are lacking or unclear, use this feature to switch the phase of your subwoofer.

Choices: **NRM** (normal), REV (reverse)

- Select **NRM** if you do not want to reverse the phase of your subwoofer.
- Select **REV** to reverse the phase of your subwoofer.

■ Speaker level B)SP LEVEL

Use these settings to manually balance the level of each speaker selected in SPEAKER SET (page 56).

Choices: -10.0 dB to +10.0 dB

- **FL** adjusts the balance of the front left speaker.
- **FR** adjusts the balance of the front right speaker.
- **C** adjusts the balance of the center speaker.
- **SL** adjusts the balance of the surround left speaker.
- **SR** adjusts the balance of the surround right speaker.
- **SB** adjusts the balance of the surround back speaker.
- **SWFR** adjusts the balance of the subwoofer.

■ Speaker distance C)SP DISTANCE

Use this feature to manually input the distance of each speaker and adjust the delay applied to respective channel. Ideally, each speaker should be the same distance from the main listening position. However, this is not possible in most home situations. Thus, a certain amount of delay must be applied to the sound from each speaker so that all sound will arrive at the listening position at the same time.

Unit UNIT

Choices: meters (m), feet (ft)

Initial setting:

U.S.A. and Canada models: feet (ft)

Other models: meters (m)

- Select meters to input speaker distances in meters.
- Select feet to input speaker distances in feet.

Speaker distances

Choices: 0.3 to 24.0 m (1 to 80 ft)

- **FRONT L** adjusts the distance of the front left speaker. Initial setting: 3.0 m (10.0 ft)
- **FRONT R** adjusts the distance of the front right speaker. Initial setting: 3.0 m (10.0 ft)
- **CENTER** adjusts the distance of the center speaker. Initial setting: 3.0 m (10.0 ft)
- **SUR. L** adjusts the distance of the surround left speaker. Initial setting: 3.0 m (10.0 ft)
- **SUR. R** adjusts the distance of the surround right speaker. Initial setting: 3.0 m (10.0 ft)
- **SUR. B** adjusts the distance of the surround back speaker. Initial setting: 2.10 m (7.0 ft)
- **SWFR** adjusts the distance of the subwoofer. Initial setting: 3.0 m (10.0 ft)

■ Center graphic equalizer D)CENTER GEO

Use this feature to adjust the built-in 5-band graphic equalizer for the center channel so that the tonal quality of the center speaker matches that of the front speakers. You can make adjustments listening to the currently selected source component or a test tone.

You can adjust 5 frequency bands:
100Hz, 300Hz, 1kHz, 3kHz, 10kHz

Choices: -6 to +6 dB

Initial setting: 0 dB

- Select ON to output test tones from the front left and center speakers, and adjust the tonal quality of the center speaker.
- Select OFF to stop the test tone and output the currently selected source component.

■ Low-frequency effect level E)LFE LEVEL

Use to adjust the output level of the LFE (low-frequency effect) channel according to the capacity of your subwoofer or headphones. The LFE channel carries low-frequency special effects which are only added to certain scenes. This setting is effective only when this unit decodes Dolby Digital or DTS signals.

Choices: -20 to 0 dB

Speaker SP LFE

Select to adjust the speaker LFE level.

Headphone HP LFE

Select to adjust the headphone LFE level.

Note

Depending on the "LFE LEVEL" setting, some signals may not be output from the SUBWOOFER OUTPUT jack.

■ Dynamic range F)D. RANGE

Use to select the amount of dynamic range compression to be applied to your speakers or headphones. This setting is effective only when the unit is decoding Dolby Digital and DTS signals.

Choices: **MAX** (maximum), **STD** (standard), **MIN** (minimum)

Speaker SP D.R

Select to adjust the speaker compression.

Headphone HP D.R

Select to adjust the headphone compression.

- Select MAX for feature films.
- Select STD for general use.
- Select MIN for listening to sources at low volume levels.

■ Audio settings G)AUDIO SET

Use to customize this unit's overall audio settings.

Muting type MUTE TYP.

Use to adjust how much the mute function reduces the output volume.

Choices: **FULL**, -20dB

- Select **FULL** to completely halt all output of sound.
- Select -20dB to reduce the current volume by 20 dB.

Audio delay A.DELAY

Use to delay the sound output and synchronize it with the video image. This may be necessary when using certain LCD monitors or projectors.

Choices: **0** to 160 ms

Tone bypass TC.BYPASS

Use to select whether audio output bypasses tone control circuitry when TREBLE and BASS (page 26) are set to 0 dB.

Choices: **AUTO**, OFF

- Select **AUTO** if you want signals to bypass tone control circuitry to provide the purest signal possible.
- Select **OFF** if you do not want signals to bypass tone control circuitry.

2 INPUT MENU

Use to reassign digital input/outputs and select the input mode.

■ Input/output assignment A)I/O ASSIGN

You can assign jacks according to the component to be used if this unit's initial settings do not correspond to your needs. Change the following parameters to reassign the respective jacks and effectively connect more components. Once the inputs have been reassigned, you can select the corresponding component by using **INPUT** on the front panel or the input selector buttons on the remote control.

For COMPONENT VIDEO jacks A (C.V[A]) and B (C.V[B])

Choices: [A] **DVD**, DTV/CBL, V-AUX, VCR

[B] **DVD**, **DTV/CBL**, V-AUX, VCR

For OPTICAL INPUT jacks 1 (IN (1)) and 2 (IN (2))

Choices: (1) CD, MD/CD-R, **DVD**, DTV/CBL, V-AUX, VCR

(2) CD, MD/CD-R, DVD, **DTV/CBL**, V-AUX, VCR

For COAXIAL INPUT jack 3 (IN (3))

Choices: **CD**, MD/CD-R, DVD, DTV/CBL, V-AUX, VCR

Notes

- You cannot select a specific item more than once for the same type of jack.
- When you connect a component to both the COAXIAL and OPTICAL jacks, priority is given to the input signals from the COAXIAL jack.

■ Input mode B)INPUT MODE

Use this feature to designate the input mode for sources connected to the DIGITAL INPUT jacks when you turn on this unit (see page 31 for details about the input mode).

Choices: **AUTO**, **LAST**

- Select **AUTO** to allow this unit to automatically detect the type of input signal and select the appropriate input mode.
- Select **LAST** to set this unit to automatically select the last input mode used for that source.

Note

Even if **LAST** is selected, the last setting for the EXT D SUR. button will not be recalled.

■ Input rename C)INPUT RENAME

Use this feature to change the name of the inputs in the front panel display.

1 Press an input selector button to select the input you want to change the name of.

2 Press **AMP**.

3 Press **</>** to place the **_** (under-bar) under the space or the character you want to edit.

4 Press **^ / v** to select the character you want, then use **</>** to move to the next space.

- You can use up to 8 characters for each input.
 - Press **v** to change the character in the following order, or press **^** to go in the reverse order:
A to Z, a space, 0 to 9, a space, a to z, a space, symbols (#, *, -, +, etc.).
-

5 Repeat steps 1 through 4 to rename each input.

6 To exit, press **SET MENU** when finished.

3 OPTION MENU

Use to adjust the optional system parameters.

■ Display settings A)DISPLAY SET

Dimmer DIMMER

Use to adjust the brightness of the front panel display.

Choices: **-4** to **0**

■ Memory guard B)MEMORY GUARD

Use this feature to prevent accidental changes to DSP program parameter values and other system settings.

Choices: **ON**, **OFF**

Select **ON** to protect:

- DSP program parameters
- All **SET MENU** items
- All speaker levels

Note

When **MEMORY GUARD** is set to **ON**, you cannot select any other **SET MENU** items.

■ Parameter initialization C)PARAM. INI

Use this feature to initialize the parameters for each sound field program within a sound field program group. When you initialize a sound field program group, all of the parameter values within that group revert to their initial settings.

Press the corresponding numeric button for the sound field program that you want to initialize.

Choices: **STEREO**, **MUSIC**, **ENTERTAINMENT**,
MOVIE, **STANDARD**

Notes

- You cannot automatically revert to the previous parameter settings once you initialize a sound field program group.
- You cannot separately initialize individual sound field programs.
- You cannot initialize any program groups when “**MEMORY GUARD**” is set to **ON**.

■ Zone set D) MULTI ZONE

Use to specify the location of speakers connected to the SPEAKERS B terminals.

Speaker B setting SP B

Use this feature to select the location of the front speakers connected to the SPEAKERS B terminals.

Choices: **FRONT**, ZONE B

- Select **FRONT** to turn on/off SPEAKERS A and B when the speakers connected to the SPEAKERS B terminals are set in the main room.
- Select **ZONE B** if the speakers connected to the SPEAKERS B terminals are set in another room. If SPEAKERS A is turned OFF and SPEAKERS B is turned ON, all the speakers including the subwoofer in the main room are muted and the unit outputs sound from SPEAKERS B only.

Notes

- If you connect headphones to the PHONES jack on the unit when "SP B" is set to ZONE B, the sound is output from both headphones and SPEAKERS B.
- If a DSP program is selected when "SP B" is set to ZONE B, the unit automatically enters the Virtual CINEMA DSP mode.

■ XM Radio setting E) XM RADIO SET

XM Radio antenna XM ANT.

Use to check the current reception level for the XM

Connect and Play digital antenna accessory connected to this unit. For the best reception, orient the XM Connect and Play digital antenna accessory so that a value of XX% or more is displayed here.

Range: NONE, 0 to 100%

Note

"NONE" is displayed if the XM Connect and Play digital antenna accessory is not connected to this unit. If this happens, check the antenna connections (see page 39).

ADVANCED SETUP MENU

The ADVANCED SETUP menu is displayed in the front panel display.



- During the advanced setup procedure, audio output is muted.
- During the advanced setup procedure, only the STANDBY/ON, STRAIGHT (EFFECT) and PROGRAM </> buttons on the front panel are available for operation.

CAUTION

Be sure to set the speaker impedance before using this unit to play back audio or video signals.

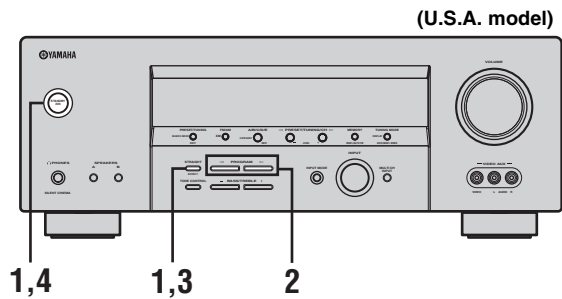

- 1 Turn off the power to this unit, and while holding down STRAIGHT (EFFECT), press STANDBY/ON.**

This unit turns on, and the ADVANCED SETUP menu appears in the front panel display.



While holding down, press



- 2 Press PROGRAM </> repeatedly to move through the menu and select the item you want to set up.**

See the end of this section for a complete list of available parameters.



- 3 Press STRAIGHT (EFFECT) repeatedly to toggle between the available parameters.**



- 4 Press STANDBY/ON to confirm your selection.**



This completes the advanced setup procedure.

The settings you made are reflected the next time this unit's power is turned on.

■ ADVANCED SETUP menu items

Change the initial settings (indicated in bold under each parameter) to reflect the needs of your listening environment.

Speaker impedance **SP IMP.**

Use to switch the speaker impedance for this unit.

Choices: **8 Ω MIN**, 4 Ω MIN

- Select 8 Ω MIN to set the speaker impedance to 8 Ω .
- Select 4 Ω MIN to set the speaker impedance to 4 Ω .

SP IMP.	Speaker	Impedance level
4 Ω MIN	Front	If you use one set (A or B), the impedance of each speaker must be 4 Ω or higher.
		If you use two sets (A and B), the impedance of each speaker must be 8 Ω or higher.
	Center	The impedance of each speaker must be 6 Ω or higher.
	Surround	
Surround back		
8 Ω MIN	Front	If you use one set (A or B), the impedance of each speaker must be 8 Ω or higher.
		If you use two sets (A and B), the impedance of each speaker must be 16 Ω or higher.*
	Center	The impedance of each speaker must be 8 Ω or higher.
	Surround	
Surround back		

* The Canada model cannot use two separate speaker systems (A and B) simultaneously when SP IMP. is set to 8 Ω MIN.

Factory presets **PRESET**

Use to reset all parameters to the factory presets (see page 75).

Choices: **CANCEL**, RESET

- Select CANCEL if you do not want this unit's parameters to be initialized when you reset the factory presets.
- Select RESET if you want all of this unit's parameters to be initialized when you reset the factory presets.

Note

This setting does not affect ADVANCED SETUP menu item parameters.

<U.S.A., Canada, Australia, Korea, Asia and General models only>

Remote **REMOTE**

Use to switch the ID for the remote control of this unit.

Choices: **ID1**, ID2

- Select ID1 to operate this unit using the default code.
- Select ID2 to operate this unit using an alternative code.

Note

You must also make settings for the remote control (see page 64).

< Asia and General models only >

Tuner **TU**

Use to switch the frequency step selection according to the frequency spacing in your area.

Choices: **AM10/FM100**, AM9/FM50

- North, Central and South America: AM10/FM100 (kHz)
- Other areas: AM9/FM50 (kHz)

REMOTE CONTROL FEATURES

In addition to controlling this unit, the remote control can also operate other A/V components made by YAMAHA and other manufacturers. To control other components, you must set up remote control with the appropriate remote control codes.

Control area

■ Controlling this unit

The shaded areas below can be used to control this unit when the AMP mode is selected. Press AMP to activate the AMP mode.

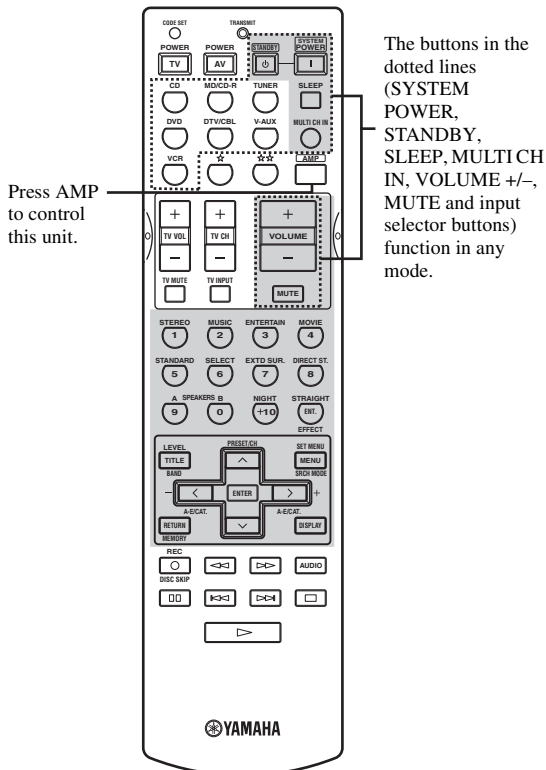

■ Controlling other components

The shaded areas below can be used to control other components. Each button has a different function depending on the selected components. Select the component you want to control by pressing an input selector button.

☆/☆☆ buttons and the input selector buttons switch the function of the component control area below.
 * Use the ☆/☆☆ buttons to control other components regardless of whether they are connected to this unit.

Component control area

You can control up to 9 different components by setting appropriate remote control codes (see page 64).

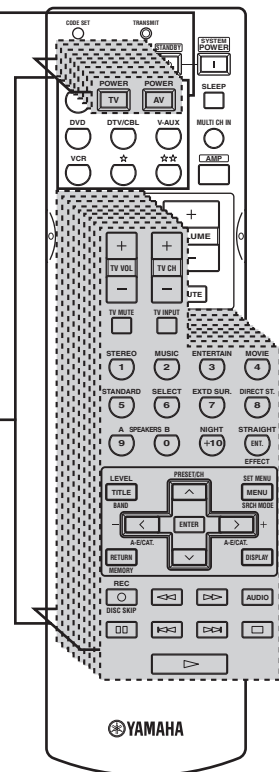

Setting remote control codes

You can control other components by setting the appropriate remote control codes. Codes can be set up for each input area. For a complete list of available remote control codes, refer to “LIST OF REMOTE CONTROL CODES” at the end of this manual.

The following table shows the default component (Library: component category) and the remote control code for each area.

Remote Control Code Default Settings

Input area	Component category (Library)	Manufacturer	Default YAMAHA code
CD	CD	YAMAHA	0005
MD/CD-R	MD	YAMAHA	0024
TUNER	TUNER	YAMAHA	0023*1 0033*2
DVD	DVD	YAMAHA	0098
DTV/CBL	-	-	-
V-AUX	-	-	-
VCR	-	-	-
☆	DVR	YAMAHA	0208
☆☆	-	-	-

*1 U.K. and Europe models

*2 Other models

Note

You may not be able to operate your YAMAHA component even if a YAMAHA remote control code is initially set as listed above. In this case, try to set other YAMAHA remote control code(s).

- 1 Press an input selector button or ☆/☆☆ to select the component you want to set up.

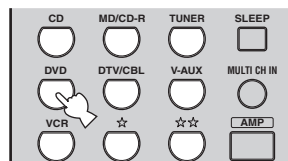

- 2 Press CODE SET using a ballpoint pen or similar object.

The TRANSMIT indicator on the remote control flashes twice.



- 3 Press the numeric buttons (0 to 9) to enter the four-digit remote control code for the component to be used.

Refer to “LIST OF REMOTE CONTROL CODES” at the end of this manual.

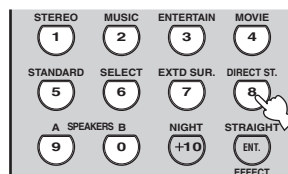

The TRANSMIT indicator on the remote control flashes twice, and the remote control code for the selected component is set.

Notes

- If the manufacturer of your component has more than one code, try each of them until you find the correct one.
- If you wait for more than 30 seconds during step 3, the setup process is canceled. If this happens, start over from step 2.

Controlling other components

Once you set the appropriate remote control codes, you can use this remote to control your other components. Note that some buttons may not correctly operate the selected component. Use the input selector buttons to select the component you want to operate. The remote control automatically switches to the appropriate control mode for that component.

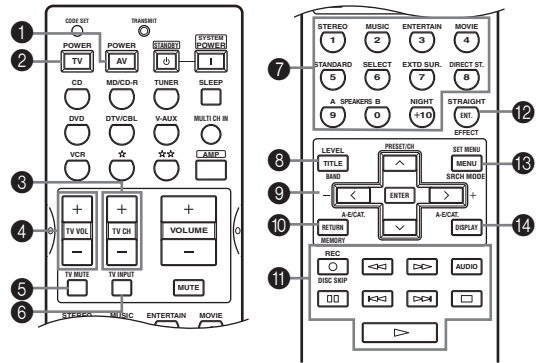

	DVD player	VCR	Digital TV/ Cable TV	CD player	MD/CD recorder	Tuner
1 AV POWER	Power *1	Power *1	VCR power *3	Power *1	Power *1	Power *1
2 TV POWER	TV power *2	TV power *2	TV power	TV power *2	TV power *2	TV power *2
3 TV CH +	TV channel up *2	TV channel up *2	TV channel up	TV channel up *2	TV channel up *2	TV channel up *2
TV CH -	TV channel down *2	TV channel down *2	TV channel down	TV channel down *2	TV channel down *2	TV channel down *2
4 TV VOL +	TV volume up *2	TV volume up *2	TV volume up	TV volume up *2	TV volume up *2	TV volume up *2
TV VOL -	TV volume down *2	TV volume down *2	TV volume down	TV volume down *2	TV volume down *2	TV volume down *2
5 TV MUTE	TV mute *2	TV mute *2	TV mute	TV mute *2	TV mute *2	TV mute *2
6 TV INPUT	TV input *2	TV input *2	TV input	TV input *2	TV input *2	TV input *2
7 1-9, 0, +10	Numeric buttons	Numeric buttons	Numeric buttons	Numeric buttons	Numeric buttons	Preset stations (1-8)
8 TITLE	Title					
9 PRESET/CH ^	Up	VCR channel up				Preset up (1-8)
PRESET/CH v	Down	VCR channel down				Preset down (1-8)
<	Left					Preset down (A-E)
>	Right					Preset up (A-E)
ENTER	Play					
10 RETURN	Return					
11 REC/ DISC SKIP	Disc skip (player)	Rec	VCR rec *3	Disc Skip	Rec (MD)	
▷	Play	Play	VCR play *3	Play	Play	
◀◀	Search backward	Search backward	VCR search backward *3	Search backward	Search backward	
▶▶	Search forward	Search forward	VCR search forward *3	Search forward	Search forward	
AUDIO	Audio					
⏸	Pause	Pause	VCR pause *3	Pause	Pause	
◀◀◀	Skip backward			Skip backward	Skip backward	
▶▶▶	Skip forward			Skip forward	Skip forward	
◻	Stop	Stop	VCR stop *3	Stop	Stop	
12 ENTER	Title/Index	Enter	Enter	Index	Index	
13 MENU	Menu					
14 DISPLAY	Display		Display	Display	Display	

*1 This button functions only when the original remote control of the component has a POWER button.

*2 These buttons can operate your TV without switching the input if the remote control code is set in DTV/CBL or ☆☆.

When the remote control code for your TV is set up in both the DTV/CBL and ☆☆ areas, priority is given to the signal in the DTV/CBL area.

*3 These buttons can operate your VCR without switching the input to VCR if the remote control code is set in VCR.

Switching library codes

You can select the unit you want to operate with the remote control by entering the library code.

1 Press CODE SET using a ballpoint pen or similar object.

The TRANSMIT indicator on the remote control flashes twice.



2 Enter the code number "9991" or "9992" (see the table below).

The TRANSMIT indicator on the remote control flashes twice, and the library code is changed.

AMP library code (remote control setting)	Function	Remote control ID (unit setting: see page 62)
9991	To operate this unit using the default code.	ID1 (initial setting)
9992	To operate this unit using an alternative code.	ID2

When using multiple YAMAHA receivers/amplifiers, you may be able to operate the other components simultaneously with the default code setting. In this case, set one of the alternative codes to operate this unit separately.

Note

You must also make settings for the receiver/amplifier.

Clearing set up remote control codes

■ Clearing a setup remote control code for component control

1 Press an input selector button or ☆/☆☆ to select the component control for which you want to clear the remote control code.

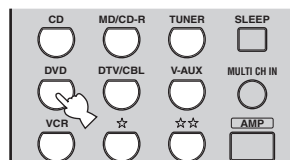

2 Press CODE SET using a ballpoint pen or similar object.

The TRANSMIT indicator on the remote control flashes twice.



3 Enter the code number "0000".

The TRANSMIT indicator on the remote control flashes twice, and the remote control code for the selected component is cleared.



- If you do not press any button within 30 seconds after step 2, the clearing process is canceled. If this happens, start over from step 1.
- You can clear all setup remote control codes at once by entering the code number "9990".

EDITING SOUND FIELD PARAMETERS

What is a sound field

What really creates the rich, full tones of a live instrument are the multiple reflections from the walls of the room. In addition to making the sound “live”, these reflections enable us to tell where the player is situated, and the size and shape of the room in which we are sitting.

■ Elements of a sound field

In any environment, in addition to the direct sound coming straight to our ears from the player’s instrument, there are two distinct types of sound reflections that combine to make up the sound field:

Early reflections

Reflected sounds reach our ears extremely rapidly (50 ms – 100 ms after the direct sound), after reflecting from one surface only – for example, from the ceiling or a wall. Early reflections actually add clarity to the direct sound.

Reverberations

These are caused by reflections from more than one surface – walls, ceiling, the back of the room – so numerous that they merge together to form a continuous sonic “afterglow”. They are non-directional, and lessen the clarity of the direct sound.

Direct sound, early reflections and subsequent reverberation taken together help us to determine the subjective size and shape of the room, and it is this information that the digital sound field processor reproduces in order to create sound fields.

If you could create the appropriate early reflections and subsequent reverberations in your listening room, you would be able to create your own listening environment. The acoustics in your room could be changed to those of a concert hall, a dance floor, or virtually any size room at all. This ability to create sound fields at will is exactly what YAMAHA has done with the digital sound field processor.

Changing parameter settings

You can enjoy good quality sound with the factory preset parameters. Although you do not have to change the initial settings, you can change some of the parameters to better suit the input source or your listening room.

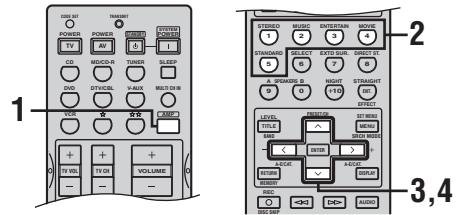

1 Press AMP.



2 Select the sound field program you want to adjust.

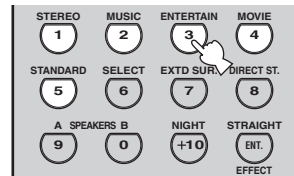

3 Press ^ / v to select the parameters.

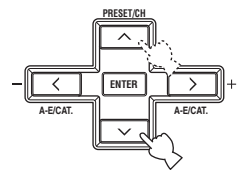

4 Press < / > to change the parameter value.

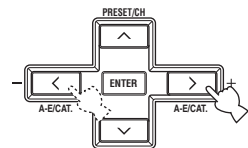

If you press and hold < / > to change the parameter value, the front panel display automatically stops at the factory preset parameter momentarily.

5 Repeat steps 2 through 4 as necessary to change other program parameters.

Note

You cannot change parameter values when "MEMORY GUARD" is set to ON. If you want to change the parameter values, set "MEMORY GUARD" to OFF (see page 59).

Memory back-up

The memory back-up circuit prevents the stored data from being lost even if this unit is set in the standby mode, the power cord is disconnected from the AC outlet, or the power supply is temporarily cut due to power failure. However, if the power is cut for more than one week, the parameter values will return to the factory settings. If this happens, edit the parameter value again.

■ **Resetting parameters to the factory presets**

Use PARAM. INI (see page 59).

SOUND FIELD PARAMETER DESCRIPTIONS

You can adjust the values of certain digital sound field parameters so the sound fields are recreated accurately in your listening room. Not all of the following parameters are found in every program.

■ DSP LEVEL (DSP level)

Function: Adjusts the level of all the DSP effect sounds within a narrow range.

Description: Depending on the acoustics of your listening room, you may want to increase or decrease the DSP effect level relative to the level of the direct sound.

Control range: -6 dB to +3 dB

■ INIT.DLY (Initial delay)

Function: Changes the apparent distance from the source sound by adjusting the delay between the direct sound and the first reflection heard by the listener.

Description: The smaller the value, the closer the sound source seems to the listener. The larger the value, the farther it seems. For a small room, set to a small value. For a large room, set to a large value.

Control range: 1 to 99 msec

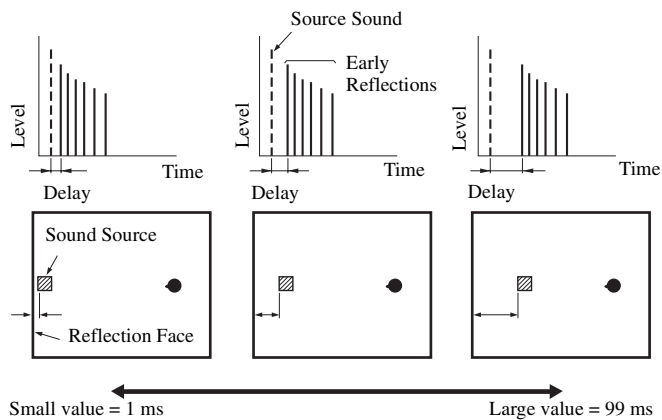

For 2ch Stereo:

■ DIRECT (Direct)

Function: Bypasses this unit's decoders and DSP processors for pure high fidelity sound when playing 2-channel analog sources. The AUTO setting is effective only when BASS and TREBLE are set to 0 dB.

Choices: **AUTO**, OFF

Notes

- When multi-channel signals (Dolby Digital and DTS) are input, they are downmixed to 2 channels and output from the front left and right speakers.
- When "BASS OUT" is set to BOTH, or "FRONT" set to SMALL and "BASS OUT" set to SWFR, front left and right speaker low-frequency signals are redirected to the subwoofer.

For 6ch Stereo:

Function: These parameters adjust the volume level for each channel in 6-channel stereo mode.

Control range: 0 to 100%

- **CT LEVEL (Center level)**
- **SL LEVEL (Surround left level)**
- **SR LEVEL (Surround right level)**
- **SB LEVEL (Surround back level)**

For PRO LOGIC IIx Music and PRO LOGIC II Music:**■ PANORAMA (Panorama)**

Function: Sends stereo signals to the surround speakers as well as the front speakers for a wraparound effect.

Choices: **OFF, ON**

■ DIMENSION (Dimension)

Function: Gradually adjusts the sound field either towards the front or towards the rear.

Control range: -3 (towards the rear) to +3 (towards the front), initial setting is STD (standard).

■ CT WIDTH (Center width)

Function: Adjusts the center image from all three front speakers to varying degrees. A larger value adjusts the center image towards the front left and right speakers.

Control range: 0 (center channel sound is output only from center speaker) to 7 (center channel sound is output only from front left and right speakers)

Initial setting: 3

Note

This parameter can be set only when SUR. STANDARD is selected.

For DTS Neo:6 Music:**■ C. IMAGE (Center image)**

Function: Adjusts the center image from all three front speakers to varying degrees.

Control range: 0 to 1.0

Initial setting: 0.3

Note

This parameter can be set only when SUR. STANDARD is selected.

TROUBLESHOOTING

Refer to the chart below when this unit does not function properly. If the problem you are experiencing is not listed below or if the instruction below does not help, set this unit to the standby mode, disconnect the power cord, and contact the nearest authorized YAMAHA dealer or service center.

■ General

Problem	Cause	Remedy	Refer to page
This unit fails to turn on when STANDBY/ON (or SYSTEM POWER) is pressed, or enters the standby mode soon after the power has been turned on.	The power cord is not connected or the plug is not completely inserted.	Connect the power cord firmly.	—
	The impedance setting is incorrect.	Set the impedance to match your speakers.	62
	The protection circuitry has been activated.	Make sure all speaker wire connections on this unit and on all speakers are secure and that the wire for each connection does not touch anything other than its respective connection.	11-13
	This unit has been exposed to a strong external electric shock (such as lightning or strong static electricity).	Set this unit in the standby mode, disconnect the power cord, plug it back in after 30 seconds, then use it normally.	—
No sound	Incorrect input or output cable connections.	Connect the cables properly. If the problem persists, the cables may be defective.	14-20
	The input mode is set to DTS or ANALOG.	Select AUTO.	31
	No appropriate input source has been selected.	Select an appropriate input source with INPUT, MULTI CH INPUT (or MULTI CH IN on the remote control) or the input selector buttons.	25
	Speaker connections are not secure.	Secure the connections.	12
	The front speakers to be used have not been selected properly.	Select the front speakers with SPEAKERS A and/or B.	25
	The volume is turned down.	Turn up the volume.	—
	The sound is muted.	Press MUTE or any operation button of this unit to resume audio output, then adjust the volume.	26
	The input mode is set to ANALOG while playing a source encoded with a DTS signal.	Set the input mode to AUTO or DTS.	31
Signals this unit cannot reproduce are being received from a source component, such as a CD-ROM.	Play a source whose signals can be reproduced by this unit.	—	

Problem	Cause	Remedy	Refer to page
The sound suddenly goes off.	The protection circuitry has been activated because of a short circuit, etc.	Check that the impedance selector setting is correct.	62
		Check that the speaker wires are not touching each other and then turn this unit back on.	—
	The sleep timer has turned the unit off.	Turn on the power, and play the source again.	—
	The sound is muted.	Press MUTE to cancel a mute.	26
Only the speaker on one side can be heard.	Incorrect cable connections.	Connect the cables properly. If the problem persists, the cables may be defective.	12
	Incorrect balance settings in SET MENU.	Adjust the SP LEVEL settings.	57
Only the center speaker outputs substantial sound.	When playing a monaural source with a CINEMA DSP program, the source signal is directed to the center channel, and the front and surround speakers output effect sounds.		
No sound from the effect speakers.	The sound field programs are turned off.	Press STRAIGHT (EFFECT) to turn them on.	31
	You are using a source or program combination that does not output sound from all channels.	Try another sound field program.	27, 49
No sound from the center speaker.	The output level of the center speaker is set to minimum.	Raise the level of the center speaker.	57
	“CENTER SP” in SET MENU is set to NONE.	Select the appropriate setting for the center speaker.	56
	One of the HiFi DSP programs (except for 6ch Stereo) has been selected.	Try another sound field program.	27, 49
No sound from the surround speakers.	The output level of the surround speakers is set to minimum.	Raise the output level of the surround speakers.	57
	“SUR. LR” in SET MENU is set to NONE.	Select the appropriate setting for the surround left and right speakers.	56
	A monaural source is being played with STRAIGHT.	Press STRAIGHT (EFFECT) to turn on the sound fields.	—
No sound from the surround back speaker.	“SUR. LR” in SET MENU is set to NONE.	If the surround left and right speakers are set to NONE, the surround back speaker setting is automatically set to NONE. Select the appropriate setting for the surround speakers.	56
	“SUR. B” in SET MENU is set to NONE.	Select LRG or SML.	56
No sound from the subwoofer.	“BASS OUT” in SET MENU is set to FRONT when a Dolby Digital or DTS signal is being played.	Select SWFR or BOTH.	56
	“BASS OUT” in SET MENU is set to SWFR or FRONT when a 2-channel source is being played.	Select BOTH.	56
	The source does not contain low bass signals.		

Problem	Cause	Remedy	Refer to page
Dolby Digital or DTS sources cannot be played. (Dolby Digital or DTS indicator in the front panel display does not light up.)	The connected component is not set to output Dolby Digital or DTS digital signals.	Make an appropriate setting following the operating instructions for your component.	—
	The input mode is set to ANALOG.	Set the input mode to AUTO or DTS.	31
A “humming” sound can be heard.	Incorrect cable connections.	Firmly connect the audio plugs. If the problem persists, the cables may be defective.	—
The volume level cannot be increased, or the sound is distorted.	The component connected to the OUT (REC) jacks of this unit is turned off.	Turn on the power to the component.	—
The sound effect cannot be recorded.	It is not possible to record the sound effect with a recording component.		
A source cannot be recorded by a digital recording component connected to this DIGITAL OUTPUT jack.	The source component is not connected to this unit’s DIGITAL INPUT jacks.	Connect the source component to the DIGITAL INPUT jacks.	14-18
	Some components cannot record the Dolby Digital or DTS sources.		
A source cannot be recorded by an analog component connected to the AUDIO OUT jacks.	The source component is not connected to this unit’s analog AUDIO IN jacks.	Connect the source component to the analog AUDIO IN jacks.	14-18
The sound field parameters and some other settings on this unit cannot be changed.	“MEMORY GUARD” in SET MENU is set to ON.	Select OFF.	59
This unit does not operate properly.	The internal microcomputer has been frozen by an external electric shock (such as lightning or excessive static electricity) or by a power supply with low voltage.	Disconnect the AC power cord from the outlet and then plug it in again after about 30 seconds.	—
“CHECK SP WIRES” appears in the front panel display.	Speaker cables are short circuited.	Make sure all speaker cables are connected correctly.	12
There is noise interference from digital or radio frequency equipment, or this unit.	This unit is too close to the digital or high-frequency equipment.	Move this unit further away from such equipment.	—
The picture is disturbed.	The video source uses scrambled or encoded signals to prevent dubbing.		
This unit suddenly turns into the standby mode.	The internal temperature becomes too high and the overheat protection circuitry has been activated.	Wait about 1 hour for this unit to cool down and then turn it back on.	—

■ **Tuner**

Problem		Cause	Remedy	Refer to page
FM	FM stereo reception is noisy.	The characteristics of FM stereo broadcasts may cause this problem when the transmitter is too far away or the antenna input is poor.	Check the antenna connections. Try using a high-quality directional FM antenna.	19
			Use the manual tuning method.	34
	There is distortion, and clear reception cannot be obtained even with a good FM antenna.	There is multipath interference.	Adjust the antenna position to eliminate multipath interference.	—
	The desired station cannot be tuned in with the automatic tuning method.	The signal is too weak.	Use a high-quality directional FM antenna.	19
Use the manual tuning method.			34	
Previously preset stations can no longer be tuned in.	This unit has been disconnected for a long period.	Preset the stations again.	34	
AM	The desired station cannot be tuned in with the automatic tuning method.	The signal is weak or the antenna connections are loose.	Tighten the AM loop antenna connections and orient it for the best reception.	—
			Use the manual tuning method.	34
	There are continuous crackling and hissing noises.	Noises result from lightning, fluorescent lamps, motors, thermostats and other electrical equipment.	Use an outdoor antenna and a ground wire. This will help somewhat, but it is difficult to eliminate all noise.	—
	There are buzzing and whining noises.	A TV set is being used nearby.	Move this unit away from the TV.	—

■ **Remote control**

Problem	Cause	Remedy	Refer to page	
The remote control does not work nor function properly.	Wrong distance or angle.	The remote control will function within a maximum range of 6 m (20 ft) and no more than 30 degrees off-axis from the front panel.	7	
	Direct sunlight or lighting (from an inverter type of fluorescent lamp, etc.) is striking the remote control sensor of this unit.	Reposition this unit.	—	
	The batteries are weak.	Replace all batteries.	3	
	The remote control code was not correctly set.		Set the remote control code correctly using “LIST OF REMOTE CONTROL CODES” at the end of this manual.	64
			Try to set another code for the same remote control using “LIST OF REMOTE CONTROL CODES” at the end of this manual.	64
	The remote control ID and this unit’s ID do not match.	Switch the library code.	66	
	Even if the remote control code is correctly set, there are some models that do not respond to the remote control.			

RESETTING THE FACTORY PRESETS

If you want to reset all of your unit's parameters for any reason, do the following. This procedure completely resets ALL parameters, including the SET MENU, level, assign and tuner presets.

Be sure this unit is in standby mode.

(U.S.A. model)

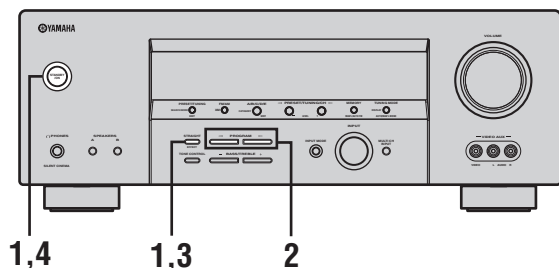

- 4 Press **STANDBY/ON** to confirm your selection.



If you selected "RESET", the unit is reset to its factory presets and switches to standby mode. If you selected "CANCEL", the unit switches to standby mode and nothing is reset.

- 1 With the unit in standby mode, hold down **STRAIGHT (EFFECT)** on the front panel and press **STANDBY/ON**.



The **ADVANCED SETUP** menu appears in the front panel display.



While holding down, press



To cancel the initialization procedure without making any changes, press **STANDBY/ON**.

- 2 Press **PROGRAM**   repeatedly to move through the menu and select "PRESET".



- 3 Press **STRAIGHT (EFFECT)** to select the desired setting.



RESET To reset the unit to its factory presets.
CANCEL To cancel without making any changes.

Audio formats

■ Dolby Digital

Dolby Digital is a digital surround sound system that gives you completely independent multi-channel audio. With 3 front channels (left, center, and right), and 2 surround stereo channels, Dolby Digital provides 5 full-range audio channels. With an additional channel especially for bass effects, called LFE (low frequency effect), the system has a total of 5.1-channels (LFE is counted as 0.1 channel). By using 2-channel stereo for the surround speakers, more accurate moving sound effects and surround sound environment are possible than with Dolby Surround. The wide dynamic range (from maximum to minimum volume) reproduced by the 5 full-range channels and the precise sound orientation generated using digital sound processing provide listeners with previously unheard of excitement and realism.

With this unit, any sound environment from monaural up to a 5.1-channel configuration can be freely selected for your enjoyment.

■ Dolby Digital EX

Dolby Digital EX creates 6 full-bandwidth output channels from 5.1-channel sources. This is done using a matrix decoder that derives 3 surround channels from the 2 in the original recording. For the best results, Dolby Digital EX should be used with movie sound tracks recorded with Dolby Digital Surround EX. With this additional channel, you can experience more dynamic and realistic moving sound especially with scenes with “flyover” and “fly-around” effects.

■ Dolby Pro Logic II

Dolby Pro Logic II is an improved technique used to decode vast numbers of existing Dolby Surround software. This new technology enables a discrete 5-channel playback with 2 front left and right channels, 1 center channel, and 2 surround left and right channels (instead of only 1 surround channel for conventional Pro Logic technology). Music and Game modes are also available for 2-channel sources in addition to the Movie mode.

■ Dolby Pro Logic IIx

Dolby Pro Logic IIx is a new technology enabling discrete multi-channel playback from 2-channel or multi-channel sources. There is a Music mode for music, a Movie mode for movies (for 2-channel sources only) and a Game mode for games.

■ Dolby Surround

Dolby Surround uses a 4 channel analog recording system to reproduce realistic and dynamic sound effects: 2 front left and right channels (stereo), a center channel for dialog (monaural), and a surround channel for special sound effects (monaural). The surround channel reproduces sound within a narrow frequency range.

Dolby Surround is widely used with nearly all video tapes and laser discs, and in many TV and cable broadcasts as well. The Dolby Pro Logic decoder built into this unit employs a digital signal processing system that automatically stabilizes the volume on each channel to enhance moving sound effects and directionality.

■ DTS 96/24

DTS 96/24 offers an unprecedented level of audio quality for multi-channel sound on DVD-Video, and is fully backward-compatible with all DTS decoders. “96” refers to a 96 kHz sampling rate (compared to the typical 48 kHz sampling rate). “24” refers to 24-bit word length. DTS 96/24 offers sound quality transparent to the original 96/24 master, and 96/24 5.1-channel sound with full-quality full-motion video for music programs and motion picture soundtracks on DVD-video.

■ DTS (Digital Theater Systems) Digital Surround

DTS digital surround was developed to replace the analog soundtracks of movies with a 6-channel digital sound track, and is now rapidly gaining popularity in movie theaters around the world. Digital Theater Systems Inc. has developed a home theater system so that you can enjoy the depth of sound and natural spatial representation of DTS digital surround in your home. This system produces practically distortion-free 6-channel sound (technically, a left, right and center channels, 2 surround channels, plus an LFE 0.1 channel as a subwoofer, for a total of 5.1-channels). The unit incorporates a DTS-ES decoder that enables 6.1-channel reproduction by adding the surround back channel to existing 5.1-channel format.

■ Neo:6

Neo:6 decodes the conventional 2-channel sources for 6 channel playback by the specific decoder. It enables playback with the full-range channels with higher separation just like digital discrete signal playback. Two modes are available; “Music mode” for playing music sources and “Cinema mode” for movies.

Sound field programs

■ CINEMA DSP

Since the Dolby Surround and DTS systems were originally designed for use in movie theaters, their effect is best felt in a theater having many speakers and designed for acoustic effects. Since home conditions, such as room size, wall material, number of speakers, and so on, can differ so widely, it's inevitable that there are differences in the sound heard as well. Based on a wealth of actually measured data, YAMAHA CINEMA DSP uses YAMAHA original sound field technology to combine Dolby Pro Logic, Dolby Digital and DTS systems to provide the visual and audio experience of movie theater in the listening room of your own home.

■ SILENT CINEMA

YAMAHA has developed a natural, realistic sound effect DSP algorithm for headphones.

Parameters for headphones have been set for each sound field so that accurate representations of all the sound field programs can be enjoyed on headphones.

■ Virtual CINEMA DSP

YAMAHA has developed a Virtual CINEMA DSP algorithm that allows you to enjoy DSP sound field surround effects even without any surround speakers by using virtual surround speakers.

It is even possible to enjoy Virtual CINEMA DSP using a minimal two-speaker system that does not include a center speaker.

Audio information

■ ITU-R

ITU-R is the radio communication sector of the ITU (International Telecommunication Union). ITU-R recommends a standard speaker placement which is used in many critical listening rooms, especially for mastering purposes.

■ LFE 0.1 channel

This channel is for the reproduction of low bass signals. The frequency range for this channel is 20 Hz to 120 Hz. This channel is counted as 0.1 because it only enforces a low frequency range compared to the full-range reproduced by the other 5/6 channels in Dolby Digital or DTS 5.1/6.1-channel systems.

■ PCM (Linear PCM)

Linear PCM is a signal format under which an analog audio signal is digitized, recorded and transmitted without using any compression. This is used as a method of recording CDs and DVD audio. The PCM system uses a technique for sampling the size of the analog signal per very small unit of time. Standing for "pulse code modulation", the analog signal is encoded as pulses and then modulated for recording.

■ Sampling frequency and number of quantized bits

When digitizing an analog audio signal, the number of times the signal is sampled per second is called the sampling frequency, while the degree of fineness when converting the sound level into a numeric value is called the number of quantized bits.

The range of rates that can be played back is determined based on the sampling rate, while the dynamic range representing the sound level difference is determined by the number of quantized bits. In principle, the higher the sampling frequency, the wider the range of frequencies that can be played back, and the higher the number of quantized bits, the more finely the sound level can be reproduced.

Video signal information

■ **Component video signal**

With the component video signal system, the video signal is separated into the Y signal for the luminance and the P_B and P_R signals for the chrominance. Color can be reproduced more faithfully with this system because each of these signals is independent. The component signal is also called the “color difference signal” because the luminance signal is subtracted from the color signal. A monitor with component input jacks is required in order to use the component signal for output.

■ **Composite video signal**

With the composite video signal system, the video signal is composed of three basic elements of a video picture; color, brightness and synchronization data. A composite video jack on a video component transmits these three elements combined.

■ **S-video signal**

With the S-video signal system, the video signal normally transmitted using a pin cable is separated and transmitted as the Y signal for the luminance and the C signal for the chrominance through the S-video cable. Using the S VIDEO jack eliminates video signal transmission loss and allows recording and playback of even more beautiful images.

SPECIFICATIONS

AUDIO SECTION

- Minimum RMS Output Power for Front, Center, Surround, Surround back
20 Hz to 20 kHz, 0.06% THD, 8 Ω 85 W
- Maximum Power (EIAJ)
[Asia, Korea and General models]
1 kHz, 10% THD, 8 Ω 125 W
- Dynamic Power (IHF)
8/6/4/2 Ω 115/150/185/230 W
- DIN Standard Output Power [U.K. and Europe models]
1 kHz, 0.7% THD, 4 Ω 130 W
- IEC Output Power [U.K., Europe and Asia models]
1 kHz, 0.06% THD, 8 Ω 95 W
- Damping Factor (IHF)
20 Hz to 20 kHz, 8 Ω 120 or more
- Frequency Response
CD terminal to Front L/R 10 Hz to 100 kHz, -3 dB
- Total Harmonic Distortion
CD, etc. to Front L/R (20 Hz to 20 kHz, 40 W, 8 Ω)
..... 0.06% or less
- Signal to Noise Ratio (IHF-A Network)
CD (250 mV) to Front L/R, Effect Off 100 dB or more
- Residual Noise (IHF-A Network)
Front L/R 150 μV or less
- Channel Separation (1 kHz/10 kHz)
CD (5.1 kΩ terminated) to Front L/R 60 dB/45 dB or more
- Tone Control (Front L/R)
BASS Boost/Cut ±10 dB/60 Hz
TREBLE Boost/Cut ±10 dB/20 kHz
- Phones Output 150 mV/100 Ω
- Input Sensitivity/Input Impedance
CD, etc. 200 mV/47 kΩ
MULTI CH INPUT 200 mV/47 kΩ
- Output Level/Output Impedance
REC OUT 200 mV/1.2 kΩ
SUBWOOFER 4 V/1.2 kΩ

VIDEO SECTION

- Video Signal Type PAL/NTSC
- Signal to Noise Ratio 50 dB or more
- Frequency Response (MONITOR OUT)
Composite, S-video 5 Hz to 10 MHz, -3 dB
Component 5 Hz to 60 MHz, -3 dB

FM SECTION

- Tuning Range
[U.S.A. and Canada models] 87.5 to 107.9 MHz
[Asia and General models] 87.5/87.50 to 108.0/108.00 MHz
[Other models] 87.50 to 108.00 MHz
- Usable Sensitivity (IHF) 1.0 μV (11.2 dBf)
- Signal to Noise Ratio (IHF)
Mono/Stereo 76 dB/70 dB
- Harmonic Distortion (1 kHz)
Mono/Stereo 0.2%/0.3%
- Stereo Separation (1 kHz) 42 dB
- Frequency Response 20 Hz to 15 kHz, +0.5, -2 dB

AM SECTION

- Tuning Range
[U.S.A. and Canada models] 530 to 1710 kHz
[Asia and General models] 530/531 to 1710/1611 kHz
[Other models] 531 to 1611 kHz
- Usable Sensitivity 300 μV/m

GENERAL

- Power Supply
[U.S.A. and Canada models] AC 120 V, 60 Hz
[Australia model] AC 240 V, 50 Hz
[Korea model] AC 220 V, 60 Hz
[U.K. and Europe models] AC 230 V, 50 Hz
[General model] AC 110/120/220/230-240 V, 50/60 Hz
[Asia model] AC 220/230-240 V, 50/60 Hz
- Power Consumption
[U.S.A. and Canada models] 350 W/440 VA
[Other models] 360 W
- Standby Power Consumption 0.1 W or less
- AC Outlets
[U.K. and Australia models] 1 (Total 100 W maximum)
[U.S.A. and Canada models] 2 (Total 100 W maximum)
[Europe, Asia and General models] 2 (Total 50 W maximum)
- Dimensions (W x H x D) 435 x 161 x 416 mm
(17-1/8" x 6-5/16" x 16-3/8")
- Weight 11 kg (24 lbs 4 oz)

LIST OF REMOTE CONTROL CODES

TV		ELIN	1001	LEYCO	1001	PENNY	0161, 0361, 0521,
A TANDY	0941	ELTA	0331	LG (GOLDSTAR)	0031, 0121,		0531, 0621, 0731,
ABEX	1151	EMERSON	0001, 0021, 0061,		0351, 0411, 0731,		0751, 0761, 0781,
ADMIRA	1141		0071, 0081, 0091,		0741, 0861, 0941,		0791, 0861, 0931,
ADVENTURA	1131		0111, 0811, 0821,		0971, 1001, 1031,		0941, 1031, 1041,
AIKO	1121		0831, 0841, 0851,		1111, 1151		1111, 1151, 1161
AIWA	1481		0861, 0871, 0901,	LIESENK & TTER	1001	PEONY	1561, 1621
AKAI	0331, 1101, 1111		0921, 0941, 0981,	LLOYTRON	0941	PHILCO	0361, 0581, 0591,
ALBA	0431		1011, 1031, 1051,	LOEWE	1001		0601, 0611, 0631,
ALLERON	1091	ENVISION	1081, 1091	LOGIK	0991, 1771		0961, 1031, 1111
AMBASSADOR	1081	ERRES	0361, 1111	LUXMAN	0351, 0971	PHILIPS	0101, 0401, 1001
AMSTRAD	0481, 1081	ETRON	1001	LXI	0101, 0621, 0761,	PHONOLA	1001
ANAM	0251, 1041, 1051,	FERGUSON	0331		0861, 0981	PILOT	0941, 1031, 1111
	1061, 1071	FINLUX	1001	MAGNAVOX	0101, 0341, 0391,	PIONEER	0511, 0551, 0871
ANAM NATIONAL	1041	FISHER	0171, 0801, 0981		0401, 0411, 0421,	PORTLAND	0941, 1031, 1121
AOC	0361, 1021, 1031,	FORMENTI	0441		0581, 0591, 0601,	PRICECLUB	0931
	1111, 1161	FORMONTI	1001		0611, 0631, 0661,	PRISM	0751
ARCHER	1161	FORTRESS	1141	MAJESTIC	0991	PROSCAN	0761
AUDIOSONIC	1001	FUJITSU	1091	MARANTZ	0101, 0221, 0361,	PROTECH	1001
AUDIOVOX	1051, 1161	FUNAI	1051, 1091, 1501,		1001, 1111	PROTON	0501, 0861, 0941,
BAUER	0441		1521	MARK	1001	PULSAR	1021, 1161
BAUR	1001	FUTURETECH	1051	MATSUI	0271, 0331, 1001	PULSER	0891
BEIJING	1511, 1551, 1561	GE	0131, 0161, 0201,	MEDIATOR	1001	QUASAR	1031
BELCOR	1031		0751, 0761, 0771,	MEGATRON	0691, 0861, 1161	QUASAR	0251, 0751, 1041
BELL & HOWELL	0981, 0991		0781, 0791, 0811,	MEI	1011	QUELLE	1001
BEON	1001		0861, 1041	M-ELECTRONIC	1001	RADIO SHACK	0541, 0941,
BRADFORD	1051	GEC	0271, 1001	MEMOREX	0331, 0571, 0861,		1031, 1051,
BROCKWOOD	1031	GEMINI	0391		0971, 0981, 0991,		1151
BROKSONIC	1161	GENEXXA	0431		1771	RADIOLA	1001
BUSH	1001	GIBRALTER	0891, 1031, 1111	METZ	1791, 1831, 1891,	RCA	0051, 0141, 0151,
CANDLE	0351, 0361, 0961,	GOODMANS/TASHIKO	0271, 0661, 1001		1901, 1911, 1921,		0181, 0411, 0491,
	0971, 1111, 1131				1931, 1941		0531, 0761, 0771,
CAPEHART	1021	GRANADA	1001	MGA	0361, 0561, 0571,	REALISTIC	0871, 1031
CARVER	0101	GRUNDIG	1781, 1791, 1801,		0861, 1031, 1111		0541, 0861, 0941,
CATHAY	1001		1811, 1821, 1831,	MIDLAND	0751, 0761, 0891,		0971, 0981, 1031,
CELEBRITY	0951		1841, 1851, 1861,		0941, 1151		1051, 1111, 1151
CENTURION	0411		1871, 1881	MITSUBISHI	0221, 0321, 0561,	RHAPSODY	1011
CHANGHONG	1541, 1551, 1561,	GUNPY	1051, 1091		0571, 0661, 0861,	R-LINE	1001
	1621	H/K	0721		1031, 1101, 1381	RUNCO	0891, 1111
CITIZEN	0351, 0361, 0921,	HALLMARK	0861	MONTGOMERY	1091	SAISHO	0331, 1081
	0931, 0941, 0961,	HANSEATIC	1001	MOTOROLA	1041, 1141	SAMPO	0361, 0941, 1021,
	0971, 1111, 1121,	HARVARD	1051, 1061	MTC	0351, 0361, 0881,		1111, 1151
	1131	HINARI	1001, 1091		0931, 0971, 1011,	SAMSUNG	0331, 0341, 0351,
CLAIRTONE	1011	HITACHI	0181, 0351, 0671,		1031, 1111		0361, 0861, 0931,
CLARIVOX	1001		0681, 0691, 0701,	MULTITECH	0881, 1051		0941, 0971, 1001,
CONCERTO	0351, 0971		0711, 0871, 0941,	NAD	0551, 0621, 0861	SAMSUX	1031, 1111, 1151
CONROWA	1751		0971, 1351	NEC	0241, 0351, 0361,	SANSUX	0941
CONTEC	0901, 0911, 1011,	HYPSON	1001		0661, 0971, 1031,	SANYO	0171, 0231, 0271,
	1051	IMA	1051		1111, 1321, 1711		0661, 0801, 0911,
CORANDO	0941	INDIANA	1001	NECKERMANN	1001		0981, 1231, 1251,
CRAIG	0251, 1051	INFINITY REFERENCE	0101	NEI	1001	SBR	1261
CROWN	0941, 1051	INTERFUNK	1001	NIKKAI	0271, 0431, 1001,	SCHEIDER	1001
CURTIS MATHES	0161, 0361,	ITT	0611		1151	SCIMITSU	1031
	0931, 0941,	JANEIL	1131	NIKKO	0861, 1111, 1121	SCOTCH	0861
	0981, 1111	JBL	1010	NOVABEAM	0721	SCOTT	0831, 0861, 0941,
CXC	1051	JCB	0951	NTC	1121		1031, 1051, 1091
DAEWOO	0291, 0301, 0331,	JENSEN	0311	ONWA	1051	SEARS	0101, 0161, 0171,
	0721, 0941, 1001,	JINXING	1531, 1541, 1551,	OPTIMUS	0551		0351, 0481, 0521,
	1031, 1121, 1191,		1561, 1571, 1621,	OPTONICA	0541, 1141		0621, 0761, 0801,
	1531, 1581, 1591,		1631, 1641, 1651,	ORION	0831, 1001		0861, 0971, 0981,
	1601		1691, 1731	OSAKI	0271, 1151		1091
DANSAI	1001	JVC	0261, 0281, 0641,	OTTO VERSAND	1001	SHANGHAI	1561, 1681
DAYTRON	0941, 1031		0651, 0661, 0841	PANASONIC	0101, 0191, 0251,	SHARP	0461, 0471, 0541,
DECCA	0271, 1001	KAWASHO	0901		0751, 1041, 1311,		0661, 0911, 0941,
DIXI	0331, 1001, 1071	KAYPANI	1021		1371, 1431		1141
DUMONT	0891, 1031	KENWOOD	0361, 1031, 1111	PANDA	1541, 1721	SHOGUN	1031
DYNATECH	0881	KLOSS	0631, 0721, 1131			SIGNATURE	0991, 1771
ELECTROBAND	0951, 1011	KTV	0921, 0941, 1011,			SIMPSON	0581, 0961
ELECTROHOME	0941		1051, 1111			SOLAVOX	1151
ELECTRON	0941					SONOKO	1001

APPENDIX-i

SONTEC	1001	BBT	0076	STANDARD COMPONENTS	CRAIG	0832, 0842, 0852,	
SONY	0371, 0451, 0661,	CABLETIME	0166	0186		0912, 0922	
	0841, 0951, 1281,	CABLEVISION	0196	STARCOM V	0256	CURTIS MATHES	0662, 0822,
	1441	COLOUR VOICE	0306, 0346	STARGATE	0276		0932
SOUNDESIGN	0861, 0961, 1051,	COMTRONICS	0216, 0276	SYLVANIA/TEXSCAN		CYBERNEX	0922
	1091	EAGLE COMTRONICS		0376, 0496		DAEWOO	0802, 0812, 0982
SOUNDWAVE	1001		0276	TEKNIKA	0176	DBX	0202
SPECTRICON	1161	EASTERN	0066	TELESERVICE	0056	DYNATECH	0472, 0992
SQUAREVIEW	0481	ELECTRICORD	0206	TELEVIEW	0276	ELECTROHOME	0912
SSS	1031, 1051	ELECTUS	0266	TEXSCAN	0186, 0376	ELECTROPHONIC	0912
STAR-LITE	1051	GE	0116, 0126	TFC	0026	EMEREX	0792
SUPREM	0951	GEC CABLE SYSTEM		TOCOM	0226, 0356	EMERSON	0072, 0132, 0142,
SUPRE-MACY	1131		0196	TOCOM 5503A	0526		0152, 0162, 0172,
SURPA	0351, 0971	GENERAL INSTRUMENT		TOCOM 5503VIP/5507			0182, 0192, 0212,
SYLVANIA	0101, 0361, 0441,		0926, 0936, 0946		0516		0702, 0712, 0722,
	0581, 0591, 0601,	HAMLIN H5	0676	TOCOM TC56	0506		0732, 0742, 0752,
	0611, 0631, 0961,	HAMLIN H6	0666	TOSHIBA	0386		0762, 0772, 0782,
	1111	HAMLIN H6S	0656	TUDI	0046		0872, 0882, 0892,
SYMPHONIC	0481	HAMLIN H8	0646	UNIKA	0136		0912, 0952, 0992,
SYSLINE	1001	HAMLIN H9	0636	UNIVERSAL	0136, 0156, 0206,		1072
TANDY	0271, 0431, 1141	JERROLD	0256		0286	FINLUX	0002, 0992
TATUNG	0271, 0881, 1001,	JERROLD 400L	0626	VIDEOWAY	0096	FISHER	0682, 0692, 0842,
	1041, 1161	JERROLD 450L	0616	VIEWSTAR	0216		0902
TCL	1561, 1631, 1701	JERROLD 550	0606	ZENITH	0246, 0386, 0486	FUJI	0672, 0932
TECHNICS	0751	JERROLD OSD CATV				FUNAI	0992
TECHWOOD	0351, 0751, 0971		0596			GARRARD	0992
TEKNIKA	0101, 0351, 0571,	JERROLD SPRUCER				GE	0662, 0822, 0932
	0931, 0941, 0961,		0436	ALPHA STAR	0826	GO VIDEO	0642, 0652
	0971, 0991, 1031,	MAGNAVOX/PHILIPS		CHAPARRAL	0756	GOODMANS	0402
	1051, 1091, 1121,		0416, 0426	ECHOSTAR	0836	GRADIENTE	0992
	1131, 1771	MAMM	0296	GENERAL INSTRUMENT		GRANDA	0612, 0902
TELETECH	0331	MEMOREX	0386		0776, 0876	GRUNDIG	0002
TERA	0501	MOTOROLA	0956, 0966	HTS	0836	H/K	1082
THAKRAL	1671	MOVIE TIME	0146, 0206	HUGHES NETWORK SYSTEMS		HARLEY DAVIDSON	
THORM	1001	NORTHCOAST	0016		0816		0992
TMK	0351, 0861, 0971,	NSC	0146	JERROLD	0776, 0786	HARMAN/KARDON	
	1081	OAK	0106	PANASONIC	0806		0632, 1082
TOSHIBA	0381, 0521, 0621,	OAK SIGMA 450	0546	PRIMESTAR	0776, 0786	HARWOOD	0752, 0852
	0661, 0931, 0981,	OAK SIGMA 550	0536	RCA	0766	HEADQUARTER	0612
	1301	PANASONIC TZ 120/130		SONY	0796	HI-Q	0842
TOSONIC	1011		0476	(DBS)		HINARI	0852
TOTEVISION	0941	PANASONIC TZ 170/180		HITACHI	0856	HITACHI	0102, 0562, 0572,
TRICAL	0911		0446	MAGNAVOX	0886		0582, 0592, 0602,
UNIVERSAL	0781, 0791	PANASONIC TZ140	0466	MEMOREX	0886		0992
UNIVERSUM	1001	PANASONIC TZ150/160		PANASONIC	0896	ITT	0942
VECTOR RESEARCH			0456	PHILIPS	0886	JVC (VICTOR)	0202, 0522, 0532,
	0361, 1111	PARAGON	0386	SONY	0906		0542, 0552
VESTEL	1001	PHILIPS	0036, 0216, 0306,	STAR CHOICE	0876	KENWOOD	0202, 0542, 0612,
VICTOR	0651		0316, 0326, 0336,	TOSHIBA	0866, 0916		0632, 0902
VIDEO CONCEPT	1101		0346	UNIDEN	0886	KLH	0852
VIDIKRON	0101, 0211	PIONEER	0006, 0086			KODAK	0912, 0932
VIDTECH	0861, 1031	PIONEER BR50	0846			LG (GOLDSTAR)	0082, 0632,
VIKING	1131	PIONEER BR60/70/80/81/82		VCR			0912
WARDS	0101, 0361, 0451,		0696	A TANDY	0902	LLOYD	0992
	0541, 0581, 0591,	PIONEER BR90	0556	ADVENTURA	0992	LOGIK	0852
	0601, 0611, 0771,	PULSAR	0386	AIKO	0982	LUXOR	0942
	0781, 0791, 0861,	RCA DIGITAL SATELLITE		AIWA	0992	LXI	0022, 0912
	0971, 0991, 1031,	SYSTEM	0396, 0406, 0986,	AKAI	0262, 0942, 0952,	MAGNAVOX	0002, 0482, 0492,
	1091, 1111, 1771		0996, 1006		0962, 0972		0502, 0512, 0932
WATSON	1001	REALISTIC	0136	AMERICAN HIGH	0932	MAGNIN	0922
XOGEGO	1611, 1621, 1661,	REGENCY/EASTERN0686		AMSTRAD	0992	MARANTZ	0002, 0202, 0402,
	1741, 1761	RUNCO	0386	ASA	0002, 0912		0632, 0932
YAMAHA	0361, 1031, 1111,	SAMSUNG	0276	ASHA	0922	MARTA	0912
	1951, 1961, 1971,	SCIENTIC ATLANTA		AUDIO DYNAMICS	0202	MATSUSHITA	0932
	1981		0976	AUDIOVOX	0912	MATSUI	0722
YOKO	1001	SCIENTIFIC ATLANTA 175/475		BEAUMARK	0922	MEI	0222, 0932
ZENITH	0011, 0041, 0891,		0576	BELL & HOWELL	0902	MEMOREX	0232, 0242, 0472,
	0991, 1771	SCIENTIFIC ATLANTA 75		BLAUPUNKT	0412		0512, 0612, 0842,
ZONDA	1161		0366, 0586	BROKSONIC	0872, 0882, 0892		0902, 0912, 0922,
		SCIENTIFIC ATLANTA 8650		BUSH	0852		0932, 0992
			0566	CALIX	0912	MGA	0762, 0952
CABLE TV		SIGNAL	0276	CANON	0862, 0932	MGA TECHNOLOGY	
ABC	0256, 0376	SL MARX	0276	CCE	0852, 0982		0922
ANTRONIX	0136	SPECTAVISION	0236	CITIZEN	0912, 0982	MINOLTA	0592, 0602
ARCHER	0136, 0286			COLT	0852		

MITSUBISHI	0452, 0462, 0542, 0762, 0952, 1082	SYLVANIA	0002, 0492, 0502, 0762, 0932, 0992	MARANTZ	0027	ONKYO	0155, 0455, 0495, 0805, 1155
MOTOROLA	0472, 0932	SYMPHONIC	0992	MITSUBISHI	0137	OPTIMUS	0225, 0245, 0555, 0595, 0845, 0855, 0865, 0895, 0935
MTC	0922, 0992	TANDY	0992	NAD	0137	PANASONIC	0055, 0825, 1095, 1125
MULTITECH	0852, 0992	TASHIKO	0712, 0992	PANASONIC	0077, 0177	PENNY	0905
NAD	0442	TEAC	0992	PHILIPS	0027	PHILIPS	0165, 0215
NEC	0122, 0202, 0292, 0422, 0432, 0542, 0632	TECHNICS	0932	PIONEER	0017, 0037, 0137	PIONEER	0305, 0935, 1045
NIKKO	0912	TEKNIKA	0322, 0912, 0932, 0992	RCA	0167	PROTON	0215, 1185
NOBLEX	0922	TELEFUNKEN	0252	REALISTIC	0157	QUASAR	0055
OLYMPUS	0412, 0932	TMK	0212, 0732, 0772, 0922	SHARP	0127	RCA	0205, 0915, 1115
OPTIMUS	0442, 0472, 0912	TOSHIBA	0062, 0302, 0342, 0622, 0682, 0712, 0762	SONY	0047, 0057, 0117	REALISTIC	0205, 0225, 0235, 0325, 0555, 0845
OPTONICA	0402	TOTEVISION	0912, 0922	VICTOR	0097	REVOX	1175
ORION	0212, 0722, 0742, 0772	UNITECH	0922	YAMAHA	0007, 0067	ROTEL	0215
OSAKI	0912	VECTOR RESEARCH	0202, 0432, 0632			SABA TELECOMMANDER (E)	0505
PANASONIC	0012, 0052, 0092, 0222, 0372, 0382, 0392, 0412, 0932	VIDEO CONCEPTS	0202, 0432, 0632, 0952			SAE	0215
PENNY	0202, 0432, 0602, 0632, 0692, 0912, 0922, 0932	WARDS	0322, 0402, 0472, 0482, 0602, 0712, 0842, 0852, 0922, 0932, 0992			SAMSUNG	1285
PENTAX	0592, 0602	YAMAHA	0202, 0632			SANSUI	0215, 0625, 0975, 1025, 1105
PERDIO	0992	ZENITH	0042, 0362, 0512, 0672			SANYO	0145, 0555, 0635, 0765
PHILCO	0002, 0932					SCOTT	0325, 1105
PHILIPS	0002, 0282, 0402, 0492, 0932					SEARS	0345
PILOT	0912					SHARP	0235, 0665, 0895, 1065, 1075
PIONEER	0442, 0542					SHERWOOD	0115, 0235, 0395, 0475
PROSCAN	1002, 1012, 1022, 1032, 1042, 1052, 1062					SIEMENS GARRARD	1245
PULSAR	0512					SIGNATURE	0175
QUARTER	0612					SONTEC	1165
QUARTZ	0272, 0612					SONY	0065, 0565, 0865, 1145
QUASAR	0382, 0392, 0932					STARON	1235
RADIO SHACK	0912, 0992					STS	0025
RADIX	0912					SYLVANIA	0215
RANDEX	0912					SYMPHONIC	0335
RCA	0112, 0382, 0392, 0482, 0592, 0602, 0662, 0822, 0942					TANDY	0305
REALISTIC	0402, 0472, 0612, 0682, 0842, 0902, 0912, 0922, 0932, 0992					TANGBERG	1195
RICOH	0352, 0362					TEAC	0235, 0335, 0385, 0525, 0795, 0835, 1355
SAISHO	0212, 0582, 0722, 0732, 0742, 0772					TECHNICS	0055, 0605, 1095
SALORA	0612, 0762					TECHWOOD	1325
SAMSUNG	0212, 0312, 0922, 0962					TELEFUNKEN (E)	0505
SANKY	0472, 0512					THOMSON (E)	0505
SANSUI	0292, 0542, 0832					TOSHIBA	0035, 0685
SANYO	0242, 0612, 0842, 0902, 0922					VECTOR RESEARCH	0065, 1135
SBR	0002, 0282					VICTOR	0315
SCHEIDER	0852					WARDS	0175
SCOTT	0342, 0712, 0762, 0872, 0882, 0892					YAMAHA	0005, 0015, 0085, 0415, 0545, 0575, 1065
SEARS	0302, 0592, 0602, 0612, 0682, 0692, 0842, 0902, 0912, 0932						
SHARP	0402, 0472						
SHINTOM	0852						
SHOGUN	0922						
SINGER	0852						
SONY	0032, 0332, 0352, 0362, 0672, 0792, 0932						
STS	0602						
SUNPAK	0352						

CD PLAYER	
ACOUSTIC RESEARCH	1295
ADC	0025, 0065
ADCOM	0205, 0255, 1015
ADS	0265
AIWA	0295, 0945, 1035, 1055
AKAI	0175, 0485, 0535
ALPINE	1215, 1305
AUDIO-TECHNICA	0545
BSR	0245, 0655, 0775
CALIFORNIA AUDIO LAB	0055
CAPETRONIC	1205
CARRERA	0245
CARVER	0285, 1135
CASIO	0345
CROWN	0185
CURTIS MATHES	0345
DENON	0275, 0875, 0885
DEUAL (E)	0505
DYNAMIC BASS (H)	0555
EMERSON	0205, 0325, 1105
EROICA	1275
FISHER	0095, 0555, 0925, 1005
GARRARD	0365
GENEXXA	0305, 0325, 1105
H/K	0105, 0175, 0465, 0995
HITACHI	0195, 0205, 0505, 0815
INKEL	0115, 0395
JVC	0315
KENWOOD	0045, 0095, 0405, 0585, 0725, 0735, 0745, 0755, 0895
KYOCERA	0025
LG (GOLDSTAR)	1135, 1225, 1265, 1335
LUXMAN	0075, 0425, 0675, 0705, 0715, 0985
MAGNAVOX	0165, 0215, 0645, 0955
MARANTZ	0215, 0235, 0375, 0785, 1345
MCINTOSH	0355, 1085
MCS	0905, 1315
MEMOREX	0205, 0225, 0235, 0305, 0325, 1105
MGA	0135
MISSION	0215
MITSUBISHI	0135, 0445
MTC	1255
NAD	0035, 0615, 0685, 0695
NAKAMICHI	0125, 0435, 0515
NEC	0255, 0905, 0965
NIKKO	0545, 1005

DVD PLAYER	
AKAI	0058
AIWA	0218
DENON	0188
HITACHI	0198
JVC	0088, 0178
KENWOOD	0148
LG	0228
MAGNAVOX	0128
MITSUBISHI	0138
ONKYO	0068, 0128
PANASONIC	0028
PHILIPS	0098, 0128
PIONEER	0108, 0118
PROSCAN	0158
RCA	0158
SAMSUNG	0078
SHARP	0038
SONY	0018
TECHNICS	0028
THOMSON	0168
TOSHIBA	0048, 0128
YAMAHA	0008, 0028, 0098
ZENITH	0128

DVD RECORDER	
PANASONIC	0238, 0248, 0258
PHILIPS	0208
PIONEER	0278, 0288, 0298
SHARP	0338, 0348
SONY	0308, 0318, 0328
TOSHIBA	0268
YAMAHA	0208

LD PLAYER	
AIWA	0157
DENON	0147
DISCO VISION	0017
FUNAI	0157
HITACHI (E)	0017
KENWOOD	0087, 0107
MAGNAVOX	0027

CD RECORDER	
HITACHI	0474
JVC	0504
MARANTZ	0484, 0494
PHILIPS	0444
PIONEER	0454, 0464
YAMAHA	0414

MD RECORDER

KENWOOD	0384
PIONEER	0424
SHARP	0434
SONY	0394
YAMAHA	0024, 0394, 0404, 0514

TAPE DECK

AIWA	0094, 0214, 0224
AKAI	0184
CARVER	0094
DENON	0304
FISHER	0144
GARRARD	0194, 0204
JVC	0274, 0284, 0294
KENWOOD	0124, 0134, 0154, 0234, 0244, 0264
MAGNAVOX	0094
MARANTZ	0094, 0344
MITSUBISHI	0184
OPTIMUS	0034, 0064, 0204, 0334
ONKYO	0364, 0374
PHILIPS	0094
PIONEER	0034, 0044, 0064
REVOX	0354
SANSUI	0094, 0344
SHARP	0264
SHERWOOD	0334
SONY	0054, 0084, 0324
TEAC	0194, 0254
TECHNICS	0074, 0314
VICTOR	0294
WARDS	0034
YAMAHA	0004, 0014, 0104, 0114, 0164, 0174, 0264



© 2005 YAMAHA CORPORATION All rights reserved.

YAMAHA ELECTRONICS CORPORATION, USA 6660 ORANGETHORPE AVE., BUENA PARK, CALIF. 90620, U.S.A.
YAMAHA CANADA MUSIC LTD. 135 MILNER AVE., SCARBOROUGH, ONTARIO M1S 3R1, CANADA
YAMAHA ELECTRONIK EUROPA G.m.b.H. SIEMENSSTR. 22-34, 25462 RELLINGEN BEI HAMBURG, GERMANY
YAMAHA ELECTRONIQUE FRANCE S.A. RUE AMBROISE CROIZAT BP70 CROISSY-BEAUBOURG 77312 MARNE-LA-VALLEE CEDEX02, FRANCE
YAMAHA ELECTRONICS (UK) LTD. YAMAHA HOUSE, 200 RICKMANSWORTH ROAD WATFORD, HERTS WD18 7GQ, ENGLAND
YAMAHA SCANDINAVIA A.B. J A WETTERGRENS GATA 1, BOX 30053, 400 43 VÄSTRA FRÖLUNDA, SWEDEN
YAMAHA MUSIC AUSTRALIA PTY, LTD. 17-33 MARKET ST., SOUTH MELBOURNE, 3205 VIC., AUSTRALIA

YAMAHA CORPORATION
Printed in Malaysia ◀ WE59830