



UAB

YSP-1100

Digital Sound Projector

OWNER'S MANUAL

IMPORTANT SAFETY INSTRUCTIONS

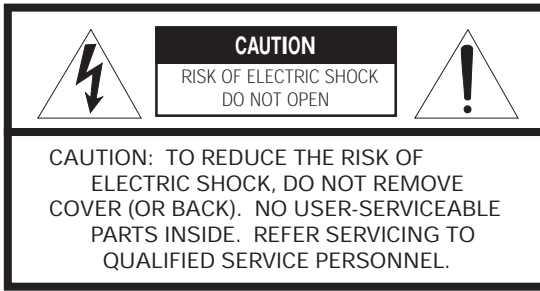

■ Explanation of Graphical Symbols

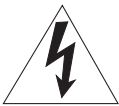

The lightning flash with arrowhead symbol, within an equilateral triangle, is intended to alert you to the presence of uninsulated “dangerous voltage” within the product’s enclosure that may be of sufficient magnitude to constitute a risk of electric shock to persons.



The exclamation point within an equilateral triangle is intended to alert you to the presence of important operating and maintenance (servicing) instructions in the literature accompanying the appliance.

- 1 Read these instructions.
- 2 Keep these instructions.
- 3 Heed all warnings.
- 4 Follow all instructions.
- 5 Do not use this apparatus near water.
- 6 Clean only with dry cloth.
- 7 Do not block any ventilation openings. Install in accordance with the manufacturer’s instructions.
- 8 Do not install near any heat sources such as radiators, heat registers, stoves, or other apparatus (including amplifiers) that produce heat.
- 9 Do not defeat the safety purpose of the polarized or grounding-type plug. A polarized plug has two blades with one wider than the other. A grounding type plug has two blades and a third grounding prong. The wide blade or the third prong are provided for your safety. If the provided plug does not fit into your outlet, consult an electrician for replacement of the obsolete outlet.
- 10 Protect the power supply cable from being walked on or pinched particularly at plugs, convenience receptacles, and the point where they exit from the apparatus.
- 11 Only use attachments/accessories specified by the manufacturer.
- 12 Use only with the cart, stand, tripod, bracket, or table specified by the manufacturer, or sold with the apparatus. When a cart is used, use caution when moving the cart/apparatus combination to avoid injury from tip-over.
- 13 Unplug this apparatus during lightning storms or when unused for long periods of time.
- 14 Refer all servicing to qualified service personnel. Servicing is required when the apparatus has been damaged in any way, such as power-supply cord or plug is damaged, liquid has been spilled or objects have fallen into the apparatus, the apparatus has been exposed to rain or moisture, does not operate normally, or has been dropped.



FCC INFORMATION (for US customers)

1. IMPORTANT NOTICE: DO NOT MODIFY THIS UNIT!

This product, when installed as indicated in the instructions contained in this manual, meets FCC requirements. Modifications not expressly approved by YAMAHA may void your authority, granted by the FCC, to use the product.

2. IMPORTANT:

When connecting this product to accessories and/or another product use only high quality shielded cables. Cable/s supplied with this product **MUST** be used. Follow all installation instructions. Failure to follow instructions could void your FCC authorization to use this product in the USA.

3. NOTE:

This product has been tested and found to comply with the requirements listed in FCC Regulations, Part 15 for Class "B" digital devices. Compliance with these requirements provides a reasonable level of assurance that your use of this product in a residential environment will not result in harmful interference with other electronic devices.

This equipment generates/uses radio frequencies and, if not installed and used according to the instructions found in the users manual, may cause interference harmful to the operation of other electronic devices.

Compliance with FCC regulations does not guarantee that interference will not occur in all installations. If this product is found to be the source of interference, which can be determined by turning the unit "OFF" and "ON", please try to eliminate the problem by using one of the following measures:

Relocate either this product or the device that is being affected by the interference.

Utilize power outlets that are on different branch (circuit breaker or fuse) circuits or install AC line filter/s.

In the case of radio or TV interference, relocate/reorient the antenna. If the antenna lead-in is 300 ohm ribbon lead, change the lead-in to coaxial type cable.

If these corrective measures do not produce satisfactory results, please contact the local retailer authorized to distribute this type of product. If you can not locate the appropriate retailer, please contact YAMAHA Electronics Corp., U.S.A. 6660 Orangethorpe Ave, Buena Park, CA 90620.

The above statements apply **ONLY** to those products distributed by YAMAHA Corporation of America or its subsidiaries.

We Want You Listening For A Lifetime

YAMAHA and the Electronic Industries Association's Consumer Electronics Group want you to get the most out of your equipment by playing it at a safe level. One that lets the sound come through loud and clear without annoying blaring or distortion – and, most importantly, without affecting your sensitive hearing.

Since hearing damage from loud sounds is often undetectable until it is too late, YAMAHA and the Electronic Industries Association's Consumer Electronics Group recommend you to avoid prolonged exposure from excessive volume levels.



CAUTION: READ THIS BEFORE OPERATING THIS UNIT.

- 1 To assure the finest performance, please read this manual carefully. Keep it in a safe place for future reference.
- 2 Install this sound system in a well ventilated, cool, dry, clean place with at least 5 cm of space above (or below) this unit – away from direct sunlight, heat sources, vibration, dust, moisture, and/or cold.
- 3 Locate this unit away from other electrical appliances, motors, or transformers to avoid humming sounds.
- 4 Do not expose this unit to sudden temperature changes from cold to hot, and do not locate this unit in an environment with high humidity (i.e. a room with a humidifier) to prevent condensation inside this unit, which may cause an electrical shock, fire, damage to this unit, and/or personal injury.
- 5 Avoid installing this unit where foreign object may fall onto this unit and/or this unit may be exposed to liquid dripping or splashing. On the top of this unit, do not place:
 - Other components, as they may cause damage and/or discoloration on the surface of this unit.
 - Burning objects (i.e. candles), as they may cause fire, damage to this unit, and/or personal injury.
 - Containers with liquid in them, as they may fall and liquid may cause electrical shock to the user and/or damage to this unit.
- 6 Do not cover this unit with a newspaper, tablecloth, curtain, etc. in order not to obstruct heat radiation. If the temperature inside this unit rises, it may cause fire, damage to this unit, and/or personal injury.
- 7 Do not plug in this unit to a wall outlet until all connections are complete.
- 8 Do not operate this unit upside-down. It may overheat, possibly causing damage.
- 9 Do not use force on switches, knobs and/or cords.
- 10 When disconnecting the power cable from the wall outlet, grasp the plug; do not pull the cable.
- 11 Do not clean this unit with chemical solvents; this might damage the finish. Use a clean, dry cloth.
- 12 Only voltage specified on this unit must be used. Using this unit with a higher voltage than specified is dangerous and may cause fire, damage to this unit, and/or personal injury. YAMAHA will not be held responsible for any damage resulting from use of this unit with a voltage other than specified.
- 13 To prevent damage by lightning, keep the power cable disconnected from a wall outlet or this unit during a lightning storm.
- 14 Do not attempt to modify or fix this unit. Contact qualified YAMAHA service personnel when any service is needed. The cabinet should never be opened for any reasons.
- 15 When not planning to use this unit for long periods of time (i.e. vacation), disconnect the AC power plug from the wall outlet.
- 16 Be sure to read the “TROUBLESHOOTING” section on common operating errors before concluding that this unit is faulty.
- 17 Before moving this unit, press STANDBY/ON to set this unit in standby mode, and disconnect the AC power plug from the wall outlet.
- 18 Condensation will form when the surrounding temperature changes suddenly. Disconnect the power cable from the outlet, then leave the unit alone.
- 19 When using the unit for a long time, the unit may become warm. Turn the power off, then leave the unit alone for cooling.
- 20 Install this unit near the AC outlet and where the AC power plug can be reached easily.
- 21 The batteries shall not be exposed to excessive heat such as sunshine, fire or the like.

WARNING

TO REDUCE THE RISK OF FIRE OR ELECTRIC SHOCK, DO NOT EXPOSE THIS UNIT TO RAIN OR MOISTURE.

WARNING

THE POWER SUPPLY CABLE OF THIS UNIT MUST BE CONNECTED TO THE MAIN SOCKET OUTLET VIA A PROTECTIVE EARTHING CONNECTION.

This unit is not disconnected from the AC power source as long as it is connected to the AC wall outlet, even if this unit itself is turned off. This state is called the standby mode. In this state, this unit is designed to consume a very small quantity of power.

IMPORTANT

Please record the serial number of this unit in the space below.
MODEL:
Serial No.:
The serial number is located on the rear of the unit. Retain this Owner's Manual in a safe place for future reference.

FOR CANADIAN CUSTOMERS

To prevent electric shock, match wide blade of plug to wide slot and fully insert.
This Class B digital apparatus complies with Canadian ICES-003.

FOR U.K. CUSTOMERS

If the socket outlets in the home are not suitable for the plug supplied with this appliance, it should be cut off and an appropriate 3 pin plug fitted. For details, refer to the instructions described below. Note that the plug severed from the mains lead must be destroyed, as a plug with bared flexible cord is hazardous if engaged in a live socket outlet.

IMPORTANT

THE WIRES IN MAINS LEAD ARE COLOURED IN ACCORDANCE WITH THE FOLLOWING CODE:

Blue: NEUTRAL
Brown: LIVE

As the colours of the wires in the mains lead of this apparatus may not correspond with the coloured markings identifying the terminals in your plug, proceed as follows:

The wire which is coloured BLUE must be connected to the terminal which is marked with the letter N or coloured BLACK. The wire which is coloured BROWN must be connected to the terminal which is marked with the letter L or coloured RED. Make sure that neither core is connected to the earth terminal of the three pin plug.

CAUTION

Danger of explosion if battery is incorrectly replaced. Replace only with the same or equivalent type.

CAUTION

Use of controls or adjustments or performance of procedures other than those specified herein may result in hazardous radiation exposure.

CONTENTS

INTRODUCTION

OVERVIEW	2
FEATURES	3
USING THIS MANUAL	4
SUPPLIED ACCESSORIES	5
CONTROLS AND FUNCTIONS	6
Front panel.....	6
Front panel display	7
Rear panel	8
Remote control.....	9

PREPARATION

INSTALLATION	11
Before installing this unit.....	11
Installing this unit	11
CONNECTIONS	15
Connecting a TV.....	16
Connecting a DVD player/recorder	17
Connecting a VCR.....	18
Connecting a digital satellite tuner or a cable TV tuner	19
Connecting a digital airwave tuner	20
Connecting other external components	21
Connecting a subwoofer	22
Connecting the power supply cable.....	23
About the RS-232C/REMOTE IN/IR-OUT terminals	23

SETUP

GETTING STARTED	24
Installing batteries in the remote control	24
Operation range of the remote control.....	24
Using the remote control	25
Turning on the power.....	25
USING SET MENU	26
Displaying the OSD	26
The flow chart of SET MENU.....	27
CHANGING OSD LANGUAGE	28
AUTO SETUP (IntelliBeam)	29
The flow chart of AUTO SETUP	29
Installing the optimizer microphone.....	30
Using AUTO SETUP (IntelliBeam).....	31
USING THE SYSTEM MEMORY	36
Convenient usage of the system memory	36
Saving settings.....	36
Loading settings.....	37

BASIC OPERATION

PLAYBACK	39
Selecting the input source.....	39
Playing back sources.....	40
Adjusting the volume.....	41
Muting the sound	41
ENJOYING SURROUND SOUND	42
5 beam.....	42

Stereo plus 3 beam.....	43
3 beam.....	43
Enjoying 2-channel sources in surround sound	45
Adjusting surround mode parameters.....	46
ENJOYING STEREO SOUND	47
Stereo playback.....	47
PLAYING BACK SOUND CLEARLY (My beam)	48
Using auto-adjust function.....	48
Using manual-adjust function.....	49
USING SOUND FIELD PROGRAMS	50
What is a sound field?	50
Sound field program descriptions	51
Turning on CINEMA DSP programs	52
Turning off CINEMA DSP programs	54
Adjusting CINEMA DSP effect levels	54
USING THE VOLUME MODE (Night listening mode/TV volume equal mode)	55
USING BASS SOUND ENHANCER (TruBass)	57
USING THE SLEEP TIMER	58
Setting the sleep timer	58
Canceling the sleep timer	59

ADVANCED OPERATION

MANUAL SETUP	60
Using MANUAL SETUP	61
BEAM MENU	62
SOUND MENU.....	66
INPUT MENU.....	68
DISPLAY MENU.....	70
ADJUSTING THE AUDIO BALANCE	72
Using the test tone	72
Using the audio output being player back	73
SELECTING THE INPUT MODE	75
ADJUSTING SYSTEM PARAMETERS	76
Using the system parameters	76
Setting the MEMORY PROTECT	76
Setting the MAX VOLUME.....	77
Setting the TURN ON VOLUME	78
Setting the DEMO MODE	78
Setting the FACTORY PRESET	79
REMOTE CONTROL FEATURES	81
Setting remote control codes	81
Controlling other components	82
Using the TV macro	84

ADDITIONAL INFORMATION

TROUBLESHOOTING	86
GLOSSARY	89
Audio formats	89
Audio information	89
INDEX	90
SPECIFICATIONS	91

INTRODUCTION

PREPARATION

SETUP

BASIC
OPERATION

ADVANCED
OPERATION

ADDITIONAL
INFORMATION

English

OVERVIEW

It is generally accepted that in order to fully enjoy the benefits of surround sound at home, you must endure the agony of wiring and installing a great number of speakers in the hope that your listening room will give you the same kind of surround sound experience as your local movie theater.

YAMAHA YSP-1100 Digital Sound Projector challenges this preconception that complicated speaker setup and troublesome wiring go hand-in-hand with the enjoyment of multi-channel surround sound.

This slimline unit does away with the need for complicated wiring and installation worries, leaving you with a unit that is not only easy to set up, but which is also capable of reproducing the kind of powerful surround sound you have been waiting for from its built-in 2 woofers and 40 full-range small speakers.

You can fine-tune the parameters of this unit to adjust the delay time for separate sound beams, resulting in highly directional sound that comes in on the listening position from all directions.

The YSP-1100 projects sound beams containing surround sound information for the front right (R), front left (L), surround right (SR) and surround left (SL) speaker positions, which are reflected off the walls of your listening room before reaching the actual listening position. With the addition of center (C) sound beams, this Digital Sound Projector creates true-to-life 5.1 channel surround sound that makes you feel as if there are actual speakers around the room.

Sit back and enjoy the real sound experience of this simple, yet stylish Digital Sound Projector.

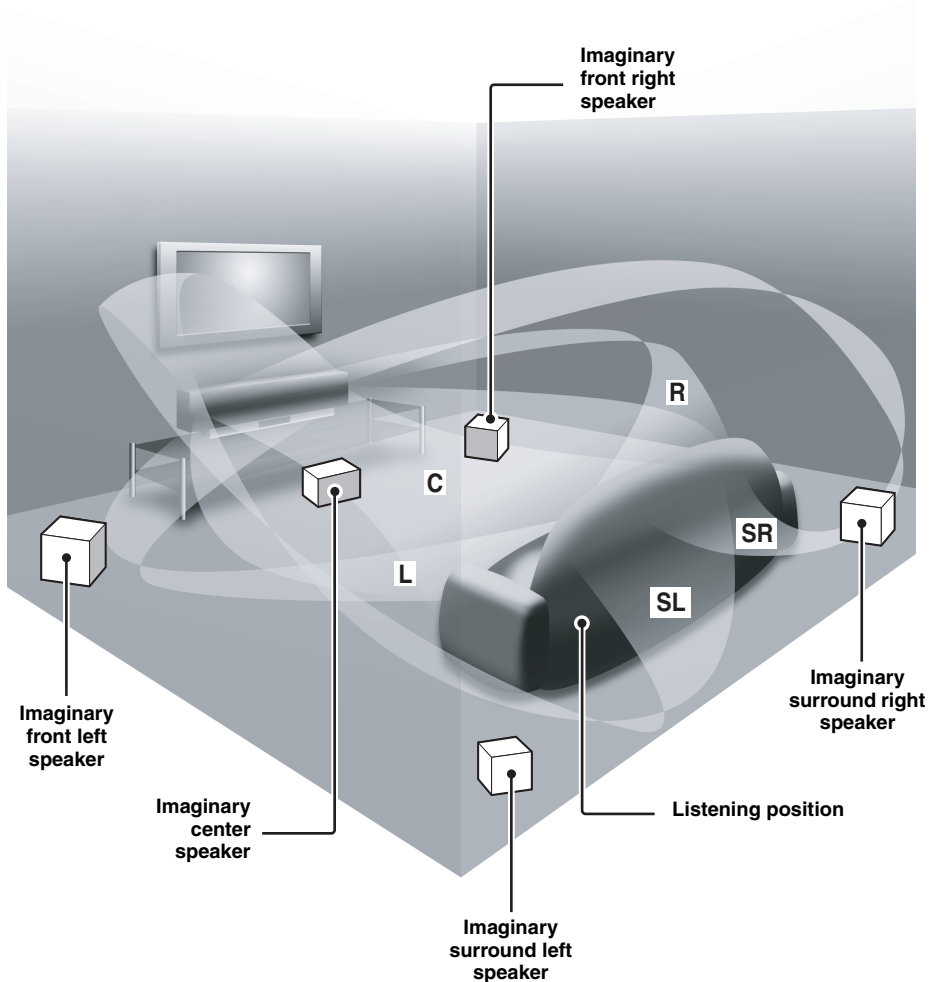

FEATURES

Digital Sound Projector

This unit employs the digital sound projector technology that allows one slim unit to control and steer multiple channels of sound to generate multi channel surround sound, thus eliminating the need for satellite loudspeakers and cabling normally associated with conventional surround sound systems. This unit is also equipped with the following beam modes so that you can enjoy the surround sound.

- ◆ 5 beam
- ◆ Stereo plus 3 beam
- ◆ 3 beam

This unit also employs the stereo playback and my beam.

My beam

This unit employs the my beam so that you can achieve a clear sound in noisy environment. You can adjust the beam angle manually or automatically using the supplied remote control.

Cinema DSP Digital

This unit employs the Cinema DSP Digital technology developed by YAMAHA Electronics Corp. so that you can experience movies at home with all the dramatic sound impact that the director intended to convey.

Versatile Remote Control

The supplied remote control come with preset remote control codes to be used to control the DVD player, VCR, cable TV tuner and digital satellite tuner connected to this unit. In addition, the remote control is equipped with the macro capability so that you can perform a series of operations with the press of a single button.

IntelliBeam

The “IntelliBeam” logo and “IntelliBeam” are trademarks of YAMAHA Corporation.



The “CINEMA DSP” logo and “Cinema DSP” are registered trademarks of YAMAHA Corporation.



Manufactured under license from Dolby Laboratories. “Dolby”, “Pro Logic”, and the double-D symbol are trademarks of Dolby Laboratories.

AUTO SETUP (IntelliBeam)

This unit employs the automatic sound beam and acoustic optimization technology with the aid of the supplied optimizer microphone so that you can avoid troublesome listening-based speaker setup and achieve highly accurate sound beam adjustments that best match your listening environment.

Compatibility with the Newest Technologies

This unit employs decoders compatible with Dolby Digital, DTS (Digital Theater Systems), Dolby Pro Logic, Dolby Pro Logic II and DTS Neo:6.

- ◆ Dolby Digital
This is the standard audio signal format used on DVDs and other purely digital media. This surround technology deliver high-quality digital audio for up to 5.1 discrete channels to produce a directional and more realistic effect.
- ◆ DTS (Digital Theater Systems)
This is an audio signal format used on DVDs and other purely digital media. This surround technology deliver high-quality digital audio for up to 5.1 discrete channels to produce a directional and more realistic effect.
- ◆ Dolby Pro Logic
This sophisticated, matrix decoding technology up-converts any 2 channel source audio to a 5.1 channel full bandwidth playback, resulting in a surround sound experience.
- ◆ Dolby Pro Logic II
This is fundamentally a redesigned version of Dolby Pro Logic that employs 2 stereo surround channels, a subwoofer and a greatly enhanced steering logic. As a result, this improved technology provides an exceptionally stable sound field that simulates 5.1 to a much greater degree than the original Dolby Pro Logic. In addition, Dolby Pro Logic II features Movie, Music and Game modes specifically designed for movies, music and games respectively.
- ◆ DTS Neo:6
This technology decodes the conventional 2 channel sources for 6 channel playback, enabling playback with the full-range channels with higher separation. Music mode and Cinema mode are available to play back music and movie sources respectively.



“DTS” and “Neo:6” are trademarks of Digital Theater Systems, Inc.



Manufactured under license from 1 Ltd. Worldwide patents applied for.

The “1” logo and “Digital Sound Projector™” are trademarks of 1 Ltd.



TruBass, SRS and the “(●)” symbol are registered trademarks of SRS Labs, Inc. TruBass technology is incorporated under license from SRS Labs, Inc.

USING THIS MANUAL

Notes

- This manual describes how to connect and operate this unit. For details regarding the operation of external components, refer to the supplied owner's manual for the component.
- Some operations can be performed by using either the buttons on the main unit or on the remote control. In such cases, the operation is described using remote control operation.
-  indicates a tip for your operation.
- This manual is printed prior to production. Design and specifications are subject to change in part as a result of improvements, etc. In case of differences between the manual and product, the product has priority.

1 Install this unit in your listening room.

See "INSTALLATION" on page 11.



2 Connect this unit to your TV and other external components.

See "CONNECTIONS" on page 15.



3 Prepare the remote control and turn on the power of this unit.

See "GETTING STARTED" on page 24.



4 Run AUTO SETUP.

See "AUTO SETUP (IntelliBeam)" on page 29.



5 Play back a source.

See "PLAYBACK" on page 39.



6 Change the beam modes and/or CINEMA DSP settings.

See "ENJOYING SURROUND SOUND" on page 42.



If you want to make additional settings and adjustments

7 Run MANUAL SETUP to fine-tune settings and/or set remote control codes.

See "MANUAL SETUP" on page 60 and "REMOTE CONTROL FEATURES" on page 81.

SUPPLIED ACCESSORIES

Check that you have received all of the following parts.

Remote control (×1)

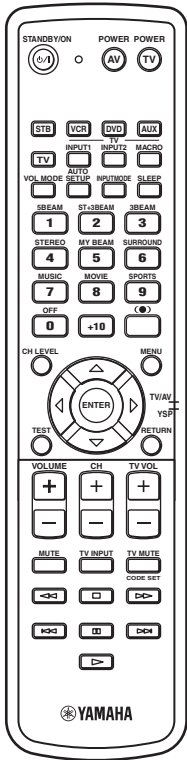

**Batteries (×2)
(AA, R6, UM-3)**

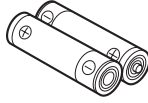

Optical cable (×1)

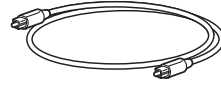

OSD video pin cable (×1)

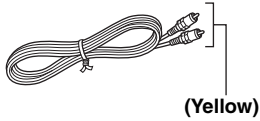

Digital audio pin cable (×1)

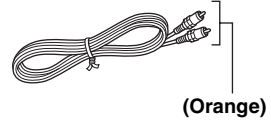

Optimizer microphone (×1)

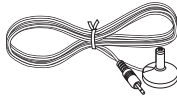

Audio pin cable (×1)

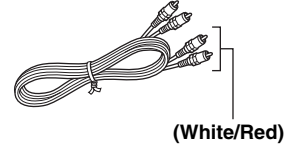

Cable clamp (×1)

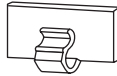

Fasteners (×4)

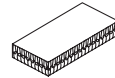

Cardboard microphone stand (×1)

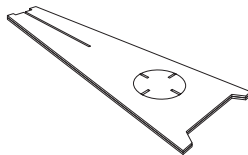

Power supply cable (×1)

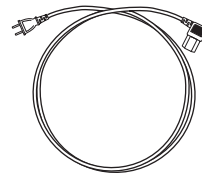

CONTROLS AND FUNCTIONS

Front panel

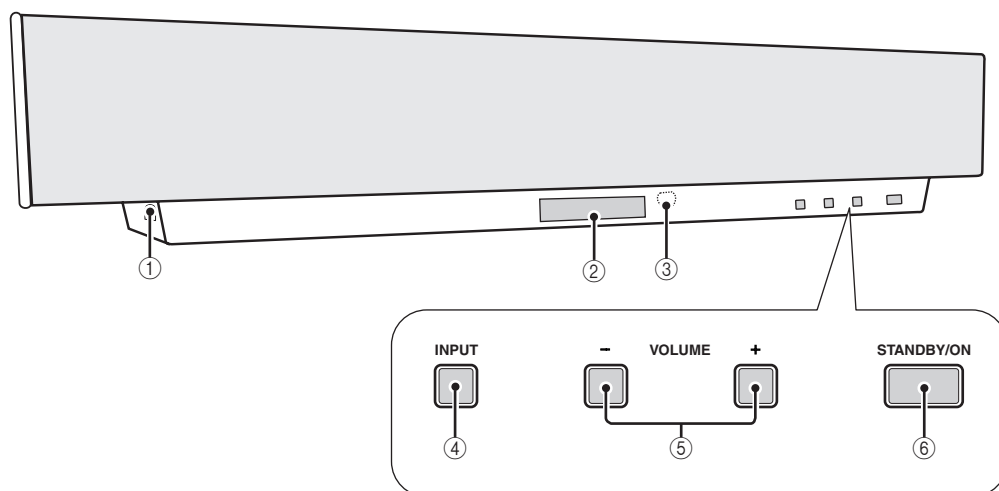

① OPTIMIZER MIC jack

Use to connect the supplied optimizer microphone to be used to run AUTO SETUP (see page 30).

② Front panel display

Shows information about the operational status of this unit.

③ Remote control sensor

Receives infrared signals from the remote control.

④ INPUT

Press repeatedly to switch between input sources (TV, STB, VCR, DVD or AUX). See page 39 for details. Outputs a test tone to experience the sound beam (see page 72).

⑤ VOLUME -/+

Controls the volume level of all audio channels (see page 41).

⑥ STANDBY/ON

Turns on the power of this unit or sets it to the standby mode (see page 25).

Notes

- When you turn on the power of this unit, you will hear a click and there will be a 4 to 5-second delay before it can reproduce sound.
- In the standby mode, this unit consumes a small amount of power in order to receive infrared-signals from the remote control.

Front panel display

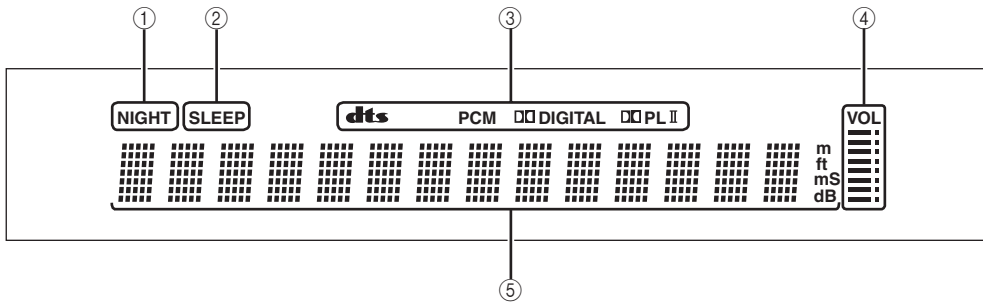

① NIGHT indicator

Lights up when one of the night listening modes is selected (see page 55).

② SLEEP indicator

Lights up when the sleep timer is turned on (see page 58).

③ Decoder indicators

Light up when the corresponding decoder of this unit is in operation (see page 44).

④ Volume level indicator

Shows the current volume level (see page 41).

⑤ Multi-information display

Shows information when you adjust the parameters of this unit.



You can adjust the brightness of the front panel display using the DISPLAY MENU parameters in MANUAL SETUP (see page 70).

Rear panel

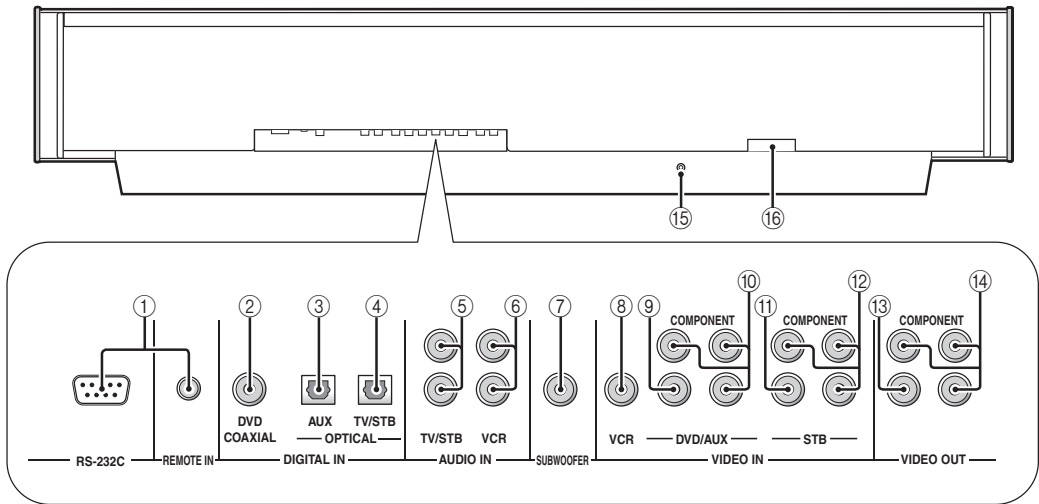

① **RS-232C/REMOTE IN terminals**

These are control expansion terminals for factory use only (see page 23).

② **DVD COAXIAL DIGITAL IN jack**

Use to connect a DVD player/recorder via a coaxial digital connection (see page 17).

③ **AUX OPTICAL DIGITAL IN jack**

Use to connect an external component via an optical digital connection (see page 21).

④ **TV/STB OPTICAL DIGITAL IN jack**

Use to connect a TV, a digital satellite tuner or a cable TV tuner via an optical digital connection (see pages 16, 19 and 20).

⑤ **TV/STB AUDIO IN jacks**

Use to connect a TV, a digital satellite tuner or a cable TV tuner via an analog audio connection (see pages 16, 19 and 20).

⑥ **VCR AUDIO IN jacks**

Use to connect a VCR via an analog audio connection (see pages 17 and 18).

⑦ **SUBWOOFER jack**

Use to connect a subwoofer (see page 22).

⑧ **VCR VIDEO IN jack**

Use to connect a VCR via a composite analog video connection (see page 18).

⑨ **DVD/AUX VIDEO IN jack**

Use to connect a DVD player/recorder or an external component via a composite analog video connection (see page 17).

⑩ **DVD/AUX COMPONENT VIDEO IN jacks**

Use to connect a DVD player/recorder or an external component via a component analog video connection (see page 17).

⑪ **STB VIDEO IN jack**

Use to connect a digital satellite tuner or a cable TV tuner via a composite analog video connection (see pages 19 and 20).

⑫ **STB COMPONENT VIDEO IN jacks**

Use to connect a digital satellite tuner or a cable TV tuner via a component analog video connection (see pages 19 and 20).

⑬ **VIDEO OUT jack**

Use to connect to the video input jack of your TV via a composite analog video connection to display the OSD of this unit (see page 16).

⑭ **COMPONENT VIDEO OUT jacks**

Use to connect to the video input jacks of your TV via a component analog video connection to display the OSD of this unit (see page 16).

⑮ **IR-OUT terminal**

This is a control expansion terminal for factory use only (see page 23).

⑯ **AC IN**

Use to connect the supplied power supply cable (see page 23).

Remote control

The functions of some buttons change depending on the position of the operation mode selector (29). This section basically describes the functions of the remote control used to control this unit.



You can also control other components using the remote control once you set the appropriate remote control codes. See "Controlling other components" on page 82 for details.

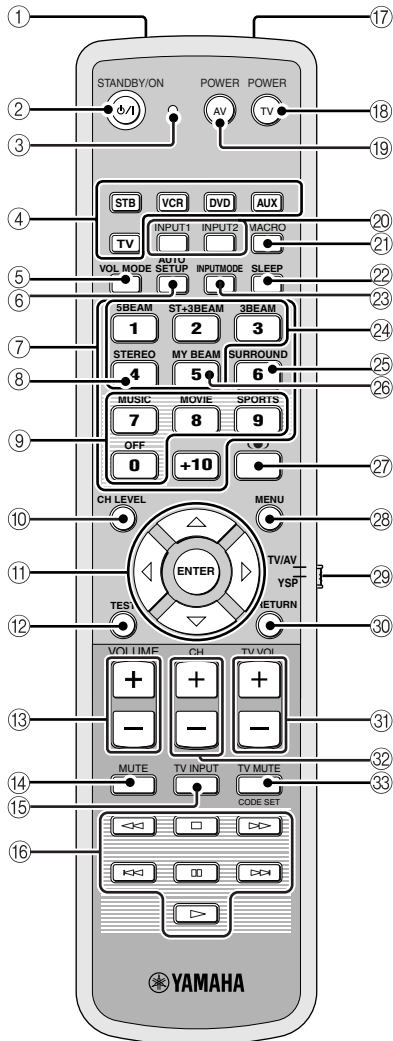

① Infrared window

Outputs infrared control signals. Aim this window at the component you want to operate.

② STANDBY/ON

Sets this system to the standby mode (see page 25).

③ Transmission indicator

Lights up when infrared control signals are being output.

④ Input selector buttons

Use to select an input source (STB, VCR, DVD, AUX or TV). Use to change the control area of the remote control. (29:TV/AV)

⑤ VOL MODE

Turns on or off the volume modes (see page 55).

⑥ AUTO SETUP

Use to enter the AUTO SETUP menu (see page 29).

⑦ Numeric buttons

Use to enter numbers. (29:TV/AV)

⑧ STEREO

Use the playback sources in 2-channel stereo (see page 47).

⑨ Sound field program buttons

Use to select sound field programs (see page 50).

⑩ CH LEVEL

Adjusts the volume level of each channel (see page 73).

⑪ Cursor buttons $\triangle / \nabla / \leftarrow / \rightarrow$, ENTER

Use to select and adjust SET MENU items.

Use to select DVD menu items. (29:TV/AV)

⑫ TEST

Outputs a test tone when adjusting the output level of each speaker (see page 72).

⑬ VOLUME +/-

Increases or decreases the volume level of this unit (see page 41).

⑭ MUTE

Mutes the sound. Press again to restore the audio output to the previous volume level (see page 41).

⑮ TV INPUT

Switches the input source or the TV (see page 82).

⑯ DVD player/VCR control buttons

Use to control the DVD player or the VCR (see pages 82 and 83).

⑰ My beam microphone

Use to collect the test tones from this unit when using the my beam auto-adjust function (see page 48).

18 TV POWER

Turns on the power of the TV or sets it to the standby mode (see page 82).

19 AV POWER

Turns on the power of the selected component or sets it to the standby mode (see pages 82 and 83).

20 INPUT1/INPUT2

Selects the input source of the TV (see page 82).

21 MACRO

Use to set the TV macro (see page 84).

22 SLEEP

Sets the sleep timer (see page 58).

23 INPUTMODE

Switches between input modes (AUTO, DTS or ANALOG). See page 75 for details.

24 Beam mode buttons

Change the beam mode settings (see pages 42, 47 and 48).

25 SURROUND

Selects the surround mode for playback (see page 42).

26 MY BEAM

Use to select the my beam as the beam mode (see page 48).

27  TruBass

Use to effectively reproduce the bass sound (see page 57).

28 MENU

Displays the setup menu on your TV monitor (see pages 31 and 61).

Display the DVD menu. ()TV/AV)

29 Operation mode selector

Selects the operation mode of this unit. Select YSP when operating this unit and select TV/AV when operating the TV or other AV components set up the appropriate remote control codes.

30 RETURN

Use to select sleep timer settings or return to the previous SET MENU screen.

Use to return to the previous DVD menu screen or exit the DVD menu. ()TV/AV)

31 TV VOL +/-

Adjusts the volume level of the TV (see page 82).

32 CH +/-

Switches between channels of the TV or the VCR (see pages 82 and 83).

33 TV MUTE, CODE SET

Mutes the audio output of the TV (see page 82).

Use to set up remote control codes (see page 81).

INSTALLATION

This section describes a suitable installation location to install the unit using a metal wall bracket, a rack or a stand.

Before installing this unit

This unit creates surround sound by reflecting projected sound beams off the walls of your listening room. The surround sound effects produced by this unit may not be sufficient when the unit is installed in the following locations.

- Rooms with surfaces inadequate for reflecting sound beams
- Rooms with acoustically absorbent surfaces
- Rooms with measurements outside the following range W (3 to 7 m) x H (2 to 3.5 m) x D (3 to 7 m)
- Rooms with less than 1.8 m from the listening position to the speaker positions
- Rooms where objects such as furniture are likely to obstruct the path of sound beams
- Rooms where the listening position is close to the walls
- Rooms where the listening position is not in front of this unit

Make sure you leave an adequate amount of ventilation space so that heat can escape. Make at least 5 cm of space above or below this unit.

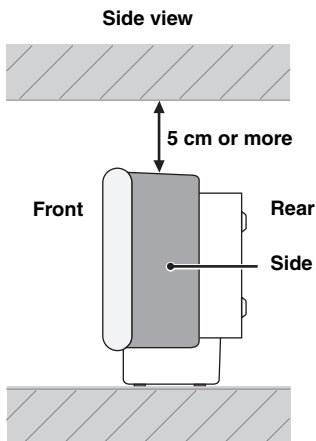

Notes

- We do not recommend installing this unit so that it is positioned directly on the floor of your listening room. Please install this unit using a metal wall bracket, rack or stand.
- This unit weighs 9.0 kg. Be sure to install this unit where it will not fall subject to vibrations, such as from an earthquake, and where it is out of the reach of children.
- When using a cathode-ray tube (CRT) TV, do not install this unit directly above your TV.
- This unit is shielded against magnetic rays. However, if the picture on your TV screen becomes blurred or distorted, we recommend moving the speakers away from your TV.

Installing this unit

Install this unit where there are no obstacles such as furniture obstructing the path of sound beams. Otherwise, the desired surround sound effects may not be achieved. You may install this unit in parallel with the wall or in the corner.

Parallel installation

Install this unit in the exact center of the wall when it is measured from the left and right corners.

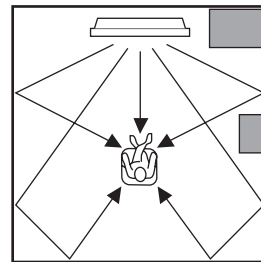

 An object, such as furniture

Corner installation

Install this unit in the corner at a 40° to 50° angle from the adjacent walls.

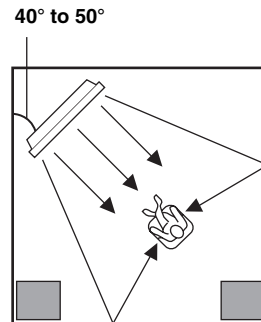

 An object, such as furniture

■ Installation examples

Example 1

Install this unit as close to the exact center of the wall as possible.

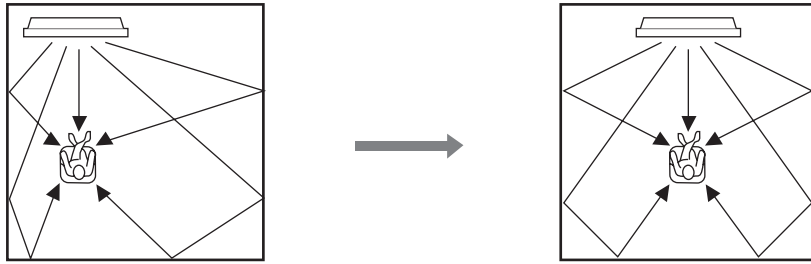

Example 2

Install this unit so that the sound beams can be reflected off the walls.

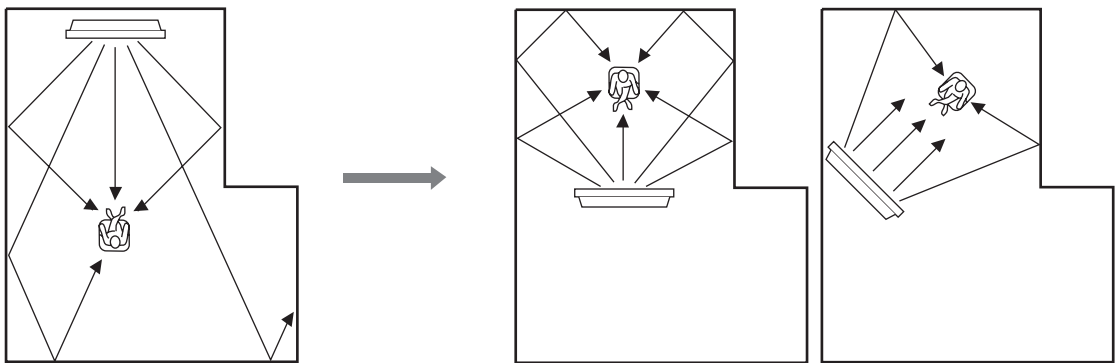

Example 3

Install this unit as close to the exact front of your normal listening position.

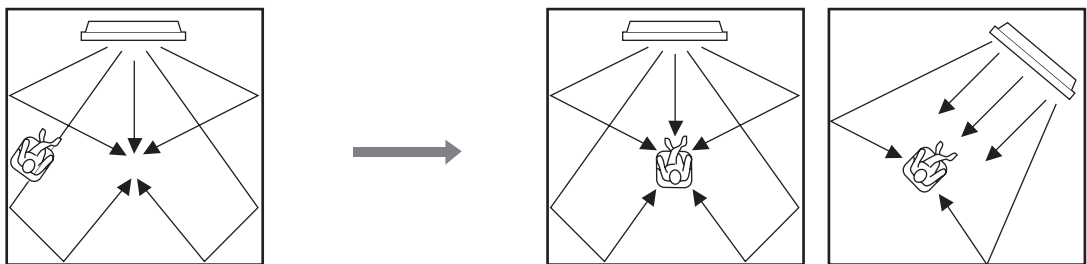

■ **Using a metal wall bracket**

You can use the optional metal wall bracket to mount this unit on the wall in your listening room.

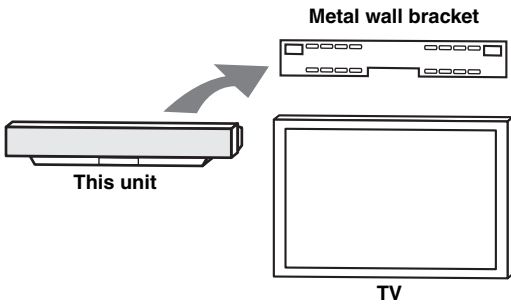

☛ Refer to the instructions supplied with the metal bracket for details on how to attach the metal bracket to the wall or how to attach this unit to the metal bracket.

■ **Using a stand**

You can mount your TV on the stand placed on a commercially available rack to install this unit under your TV.

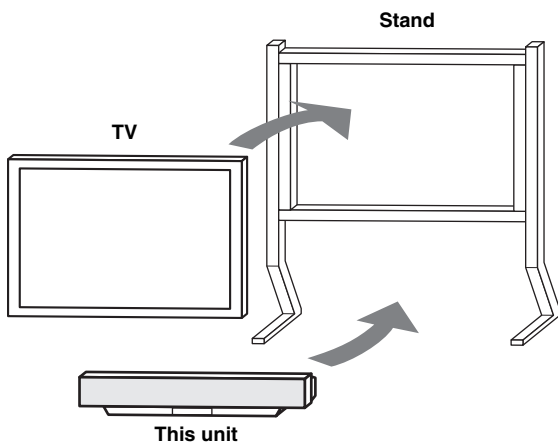

☛ Refer to the instructions supplied with the stand for details on how to install the stand or how to mount this unit and the TV on the stand.

■ **Using a TV stand**

You can use the optional TV stand to install this unit. For detailed information on installing this unit using a TV stand, refer to the installation manual supplied with the optional TV stand.

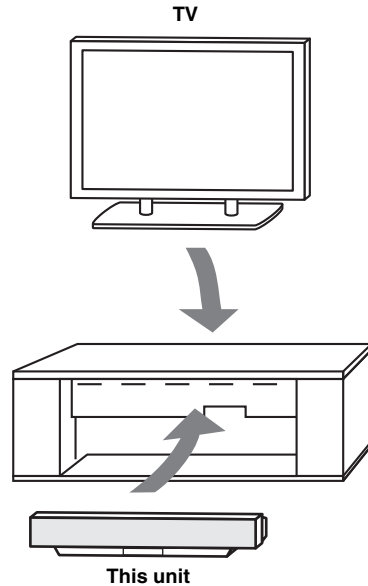

■ **Using a rack**

You can install this unit either above or under your TV in a commercially available rack.

When this unit is installed above your TV

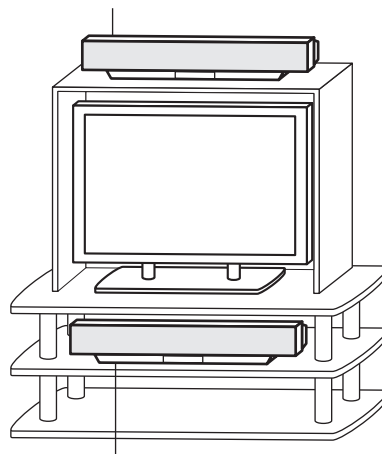

When this unit is installed under your TV

Note

Make sure that the rack is large enough to allow adequate ventilation space around this unit (see page 11) and that it is strong enough to support the weight of both this unit and your TV.

■ Affixing this unit

Peel off the film from each of the four supplied fasteners and then secure them to the bottom four corners of this unit and the top of the rack, etc.

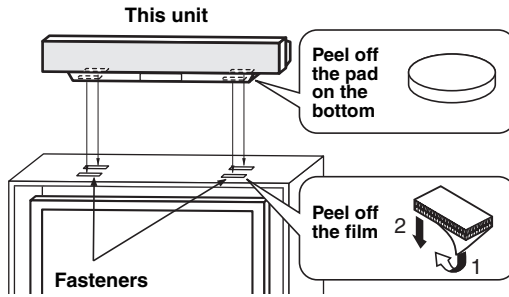
**Notes**

- Do not install this unit on top of a slanted surface. This unit may fall over and cause injury.
- Make sure you wipe the surface of the rack, etc. before securing the fasteners. Applying the tape to a dirty or wet surface will weaken the sticking power of the tape, and this unit may fall as a result.

CONNECTIONS

This unit is equipped with the following types of audio/video input/output jacks:

For audio input

- 2 optical digital input jacks
- 1 coaxial digital input jack
- 2 sets of analog input jacks

For video input

- 3 composite analog input jacks
- 2 sets of component analog input jacks

For video output

- 1 composite analog output jack
- 1 set of component analog output jacks

Use these audio/video input/output jacks to connect external components such as your TV, DVD player, VCR, digital satellite tuner, cable TV tuner and game console. Further, by connecting a subwoofer to this unit, you can enjoy reinforced low bass sounds. For details on how to connect various types of external components to this unit, see pages 16 to 22.

CAUTION

Do not connect this unit or other components to the main power until all connections between components are complete.

 Audio connection

 Video connection

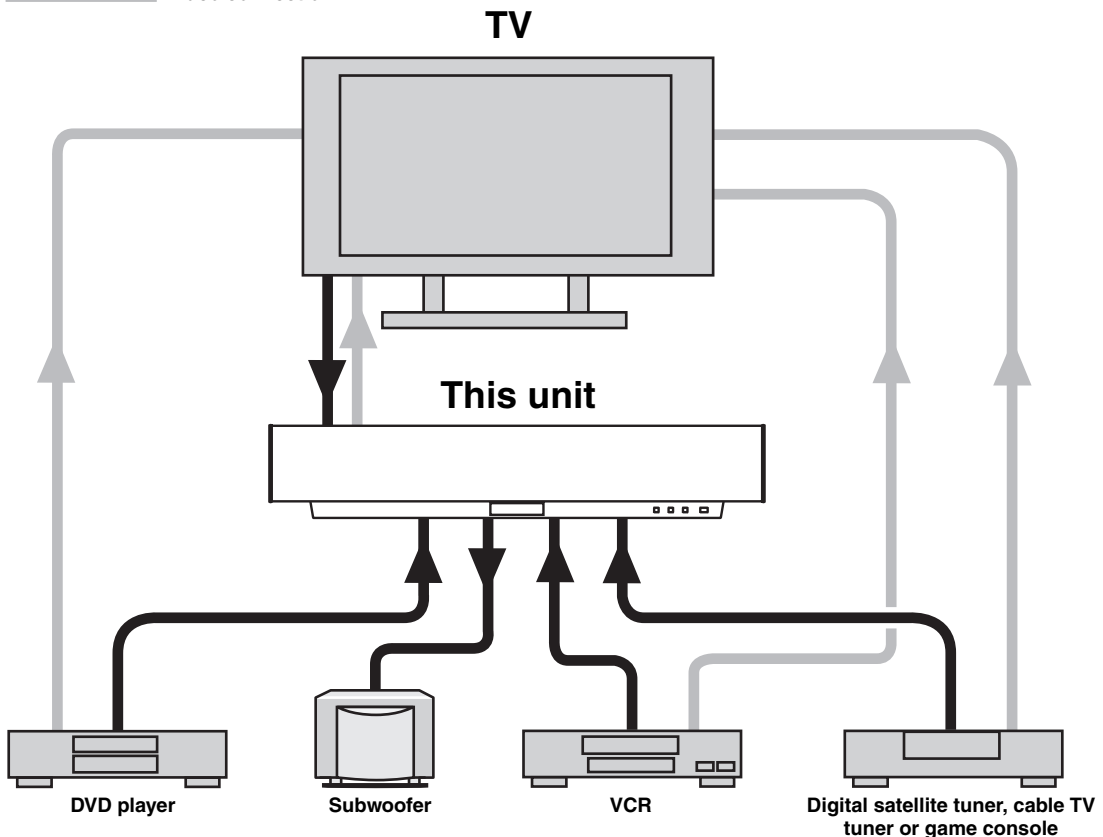

To prevent cables from becoming unplugged, place the supplied cable clamp with the open side facing upward, attach it to the rear panel of this unit in a suitable position and then affix cables in the cable clamp.

Optical fiber cable

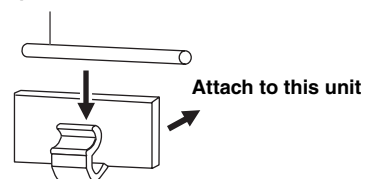

Connecting a TV

Connect a TV to this unit and display the OSD for easy viewing when you adjust the system parameters in SET MENU.

Audio connections

Connect the analog audio output jacks of your TV to the TV/STB AUDIO IN jacks of this unit. If your TV has an optical digital output jack, connect the optical digital output jack of your TV to the TV/STB OPTICAL DIGITAL IN jack of this unit in addition to the analog audio connection. Once the digital audio connection is made, digital audio signals can be input to this unit during digital broadcasting.



- The circuits of composite and component video signals are independent of each other.
- To prevent the optical cable from being unplugged, affix the optical cable in the supplied cable clamp (see page 15).

Note

If you connect this unit to the analog audio and optical digital audio output jacks at the same time as shown in the left illustration below, the digital audio signals output at the optical digital output jack take priority over the analog audio signals output at the analog audio output jacks.

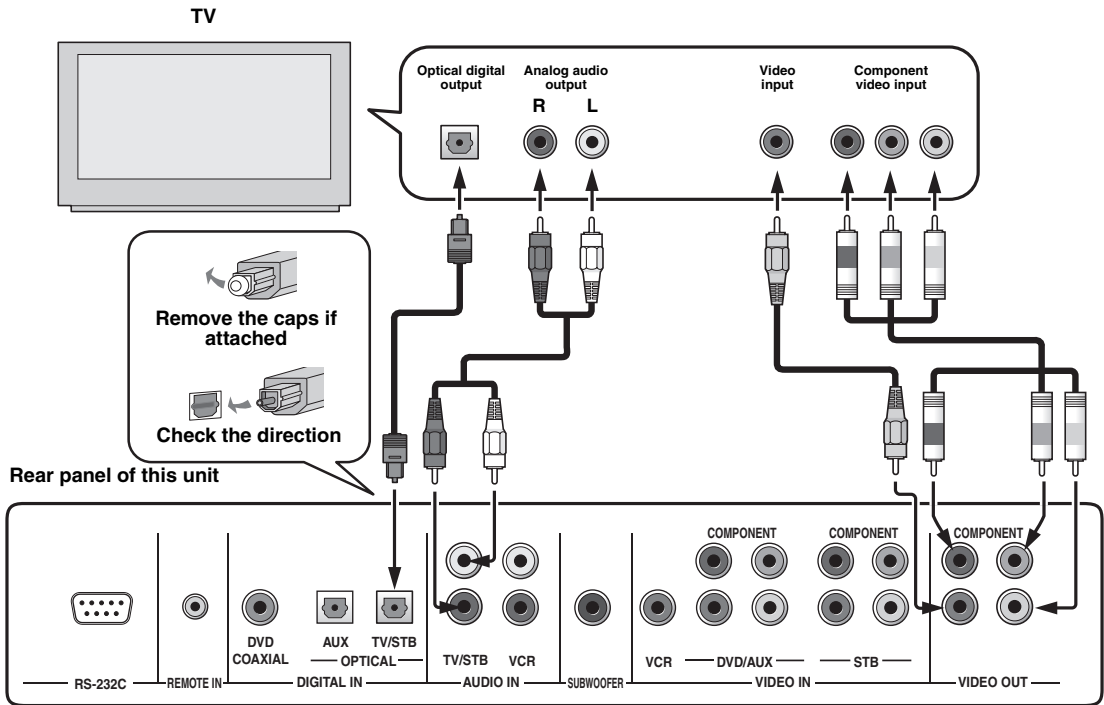

Cables used for audio connections

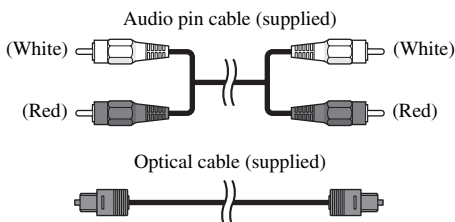

Cables used for video connections

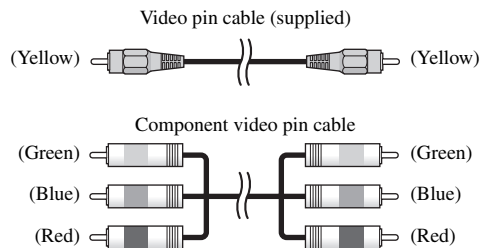

Connecting a DVD player/recorder

Connect a DVD player/recorder and enjoy DVDs.

Audio connections

Connect the optical digital output jack of your DVD player/recorder to the DVD COAXIAL DIGITAL IN jack of this unit. In case you connect this unit to a DVD/VCR combo player/recorder, connect the analog audio output jacks of your DVD/VCR combo player/recorder to the VCR AUDIO IN jacks of this unit in addition to the optical digital audio connection.



To prevent the optical cable from being unplugged, affix the optical cable in the supplied cable clamp (see page 15).

Notes

- Check that your DVD player/recorder is properly set to output Dolby Digital and DTS digital audio signals. If not, adjust the system settings of your DVD player/recorder. For details, refer to the operation manual supplied with your DVD player/recorder.
- If your DVD player/recorder does not have a coaxial digital output jack, make an optical digital audio connection instead (see page 21).

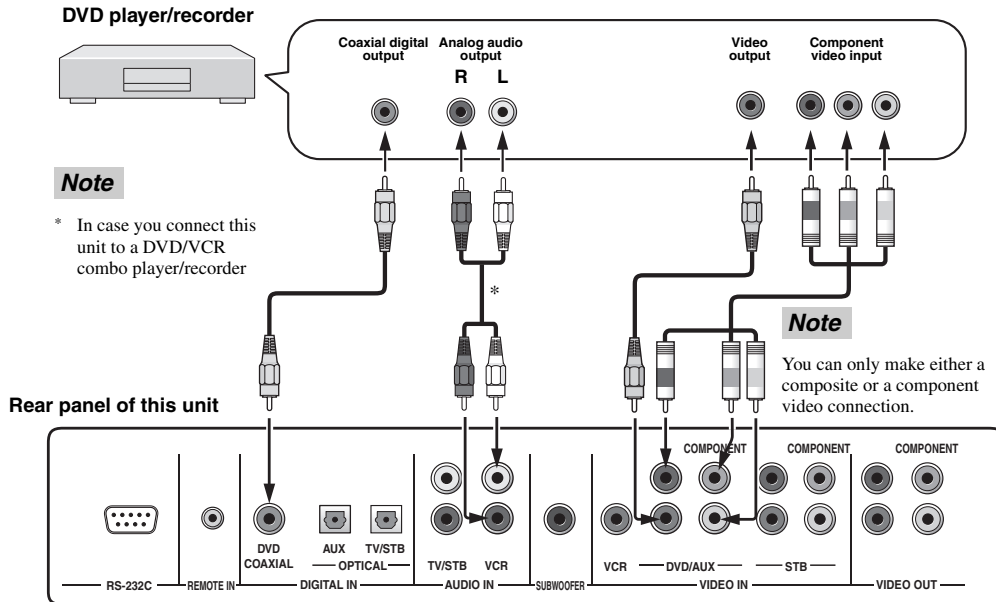

Cables used for audio connections

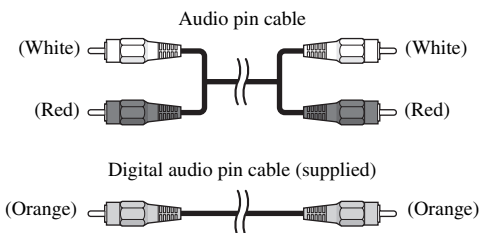

Cables used for video connections

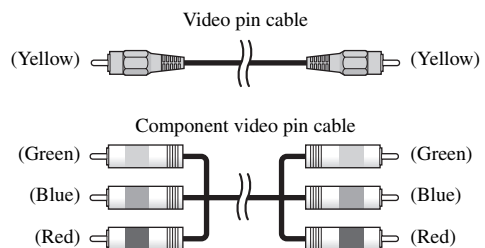

Connecting a VCR

Connect a VCR and enjoy video cassette tapes.

■ Audio connections

Connect the analog audio output jacks of your VCR to the VCR AUDIO IN jacks of this unit.

■ Video connections

Connect the video output jack of your VCR to the VCR VIDEO IN jack of this unit.

Note

Be sure to match the left and right output jacks of your VCR with the left and right input jacks of this unit.

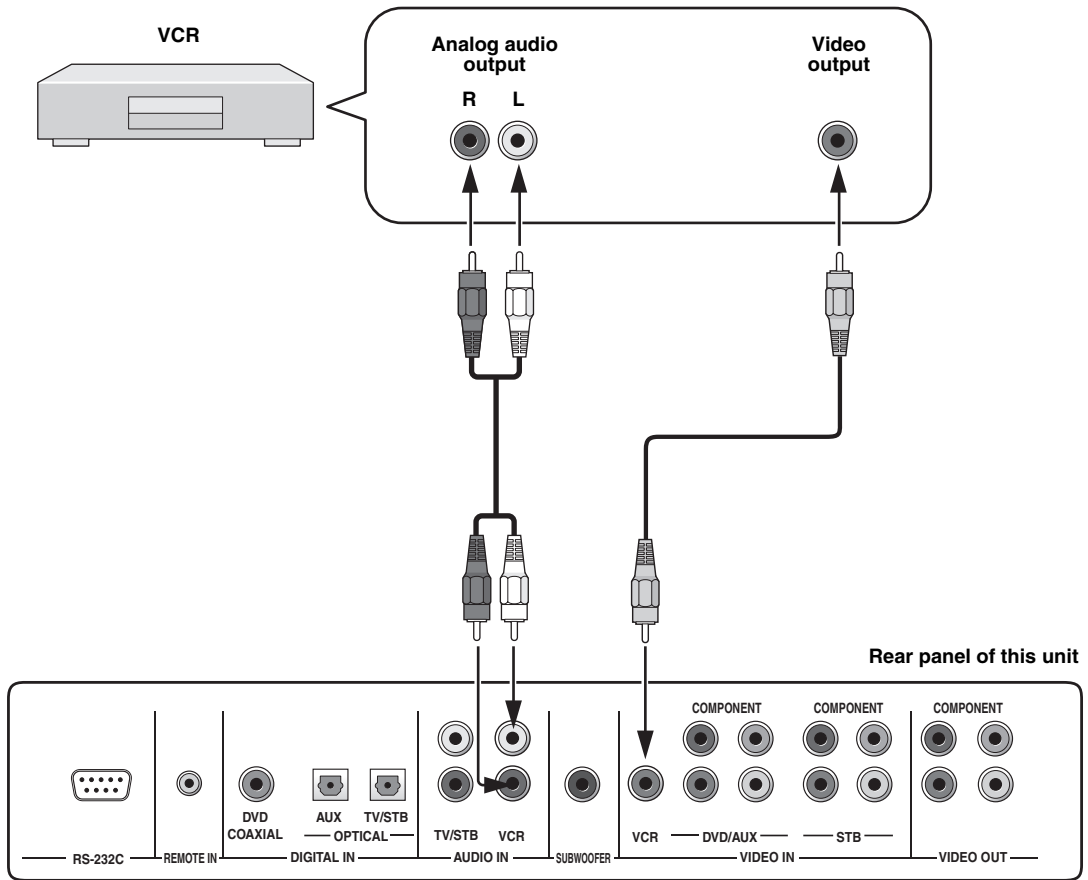

Cables used for audio connections

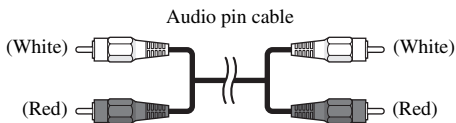

Cables used for video connections

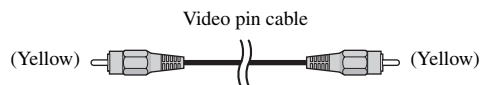

Connecting a digital satellite tuner or a cable TV tuner

Connect a digital satellite tuner or a cable TV tuner and enjoy digital satellite broadcasting or cable TV broadcasting.

Audio connections

Connect the optical digital output jack of your digital satellite tuner or cable TV tuner to the TV/STB OPTICAL DIGITAL IN jack of this unit. Connect the analog audio output jacks of your digital satellite tuner or cable TV tuner to the TV/STB AUDIO IN jacks of this unit in addition to the optical digital audio connection.

Video connections

Connect the video output jack of your digital satellite tuner or cable TV tuner to the STB VIDEO IN jack of this unit. If your digital satellite tuner or cable TV tuner has component video output jacks, connect the component video output jacks of your digital satellite tuner or cable TV tuner to the STB COMPONENT VIDEO IN jacks of this unit. Once the component video connection is made, you can enjoy images with better resolution.



To prevent the optical cable from being unplugged, affix the optical cable in the supplied cable clamp (see page 15).

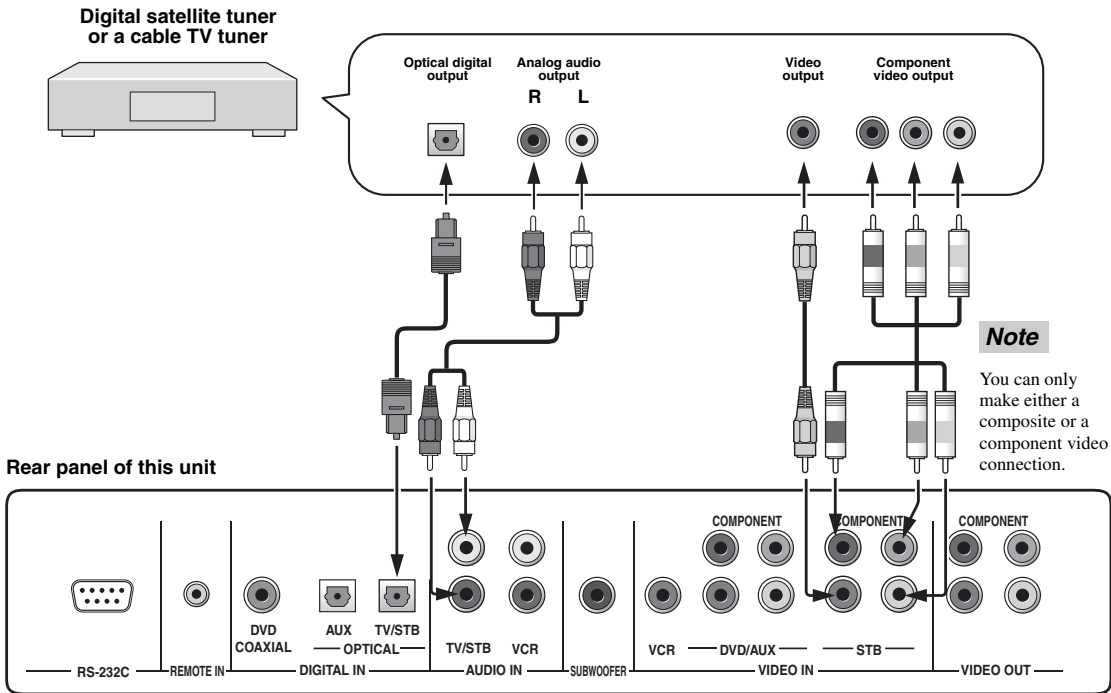

Cables used for audio connections

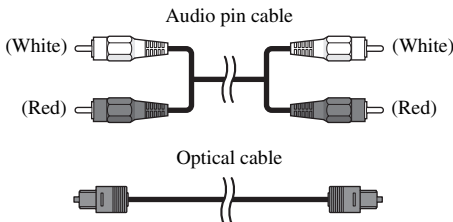

Cables used for video connections

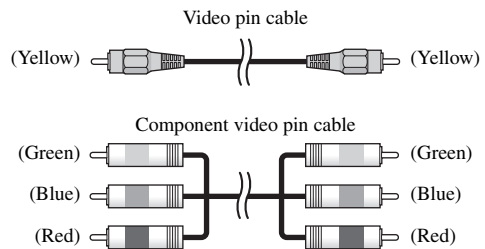

Connecting a digital airwave tuner

If your digital airwave tuner does not support analog broadcasting, make audio/video connections as shown below.

■ Audio connections

Connect the optical digital output jack of your digital airwave tuner to the TV/STB OPTICAL DIGITAL IN jack of this unit. Connect the TV/STB AUDIO IN jacks of this unit to the analog audio output jacks of your TV in addition to the optical digital audio connection between your digital airwave tuner and this unit.

■ Video connections

Connect the video output jack of your digital airwave tuner to the STB VIDEO IN jack of this unit. If your digital airwave tuner has component video output jacks, connect the component video output jacks of your digital airwave tuner to the STB COMPONENT VIDEO IN jacks of this unit. Once the component video connection is made, you can enjoy images with better resolution.



To prevent the optical cable from being unplugged, affix the optical cable in the supplied cable clamp (see page 15).

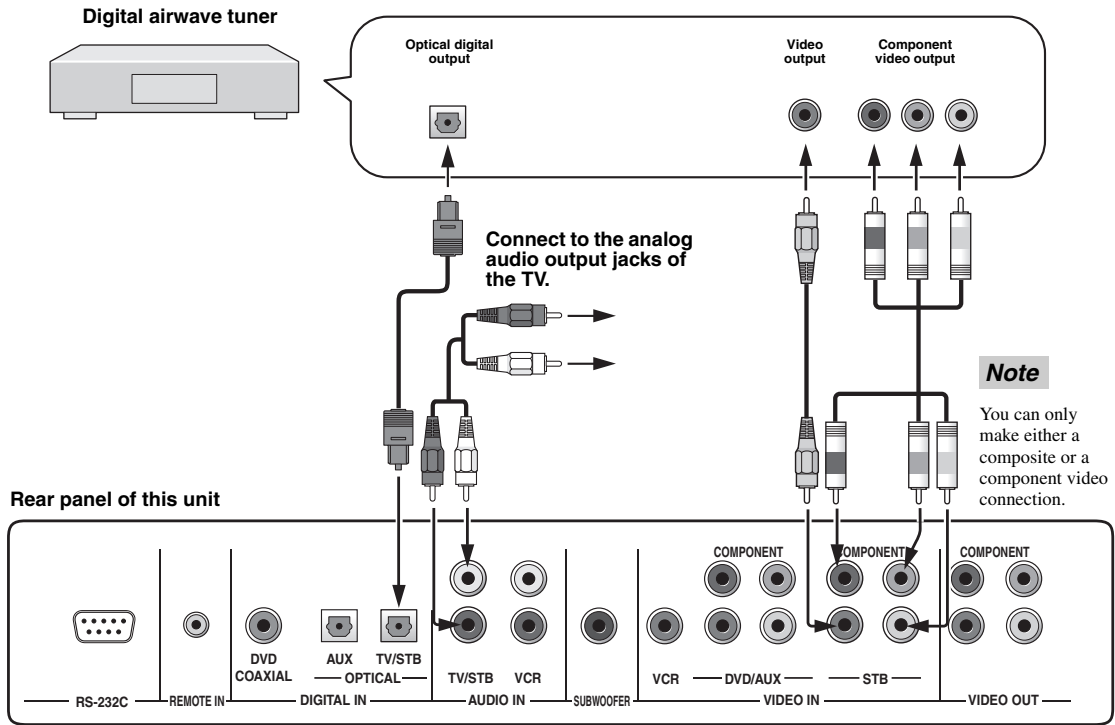

Cables used for audio connections

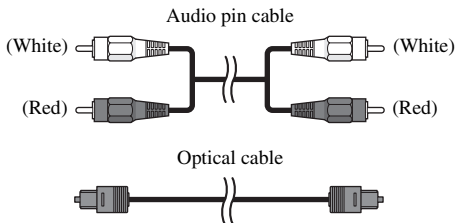

Cables used for video connections

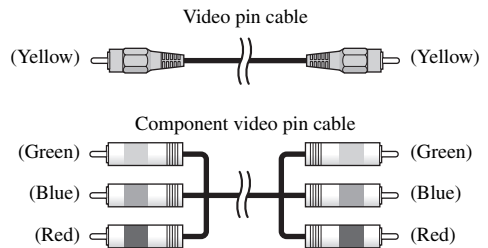

Connecting other external components

To connect other external components, connect the optical digital output jack of an external component to the AUX OPTICAL DIGITAL IN jack of this unit. Use this connection method to connect an external component that supports an optical digital connection or to connect a DVD player/recorder via an optical digital connection.



To prevent the optical cable from being unplugged, affix the optical cable in the supplied cable clamp (see page 15).

Note

If you connect a DVD player/recorder via a coaxial digital connection, adjust settings for INPUT ASSIGNMENT (see page 68).

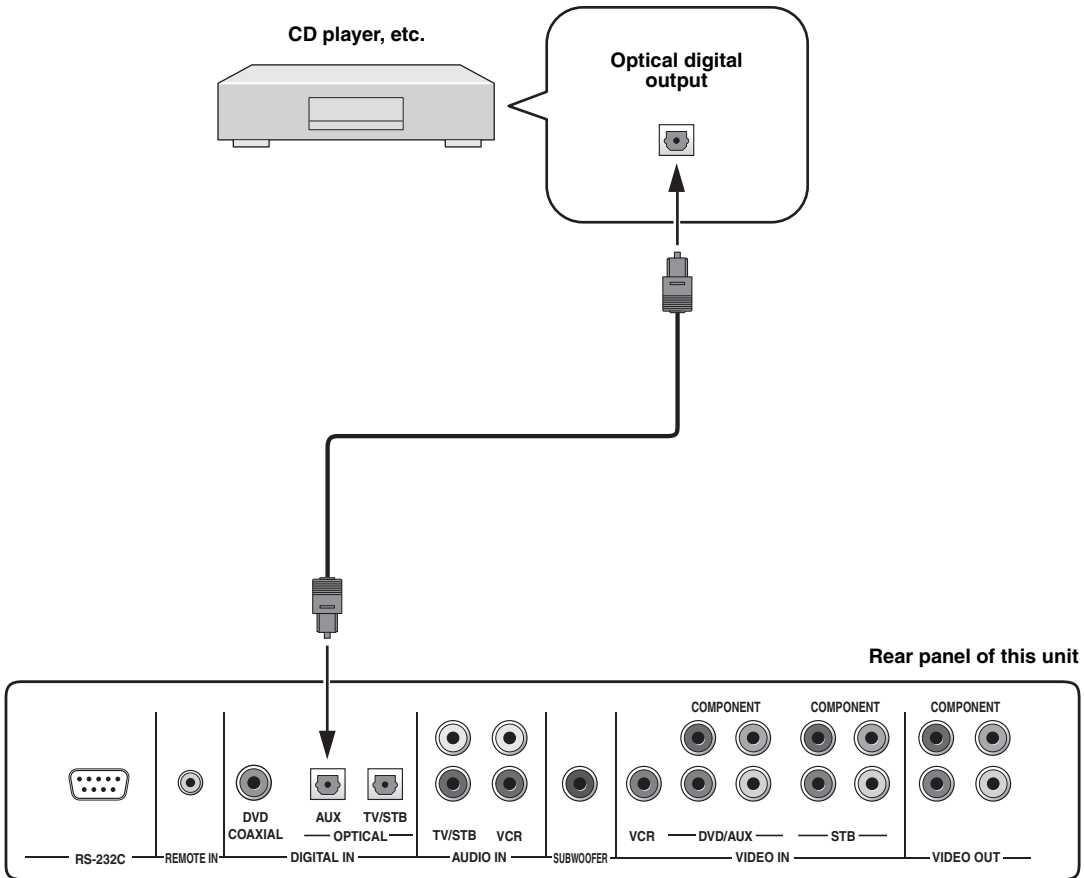

Cables used for connections

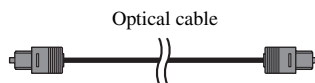

Connecting a subwoofer

To connect a subwoofer, connect the monaural input jack of your subwoofer to the SUBWOOFER jack of this unit. If a subwoofer is connected to this unit, turn on the power of your subwoofer and then run AUTO SETUP (see page 29) or select SWFR for BASS OUT in SUBWOOFER SET (see page 67).

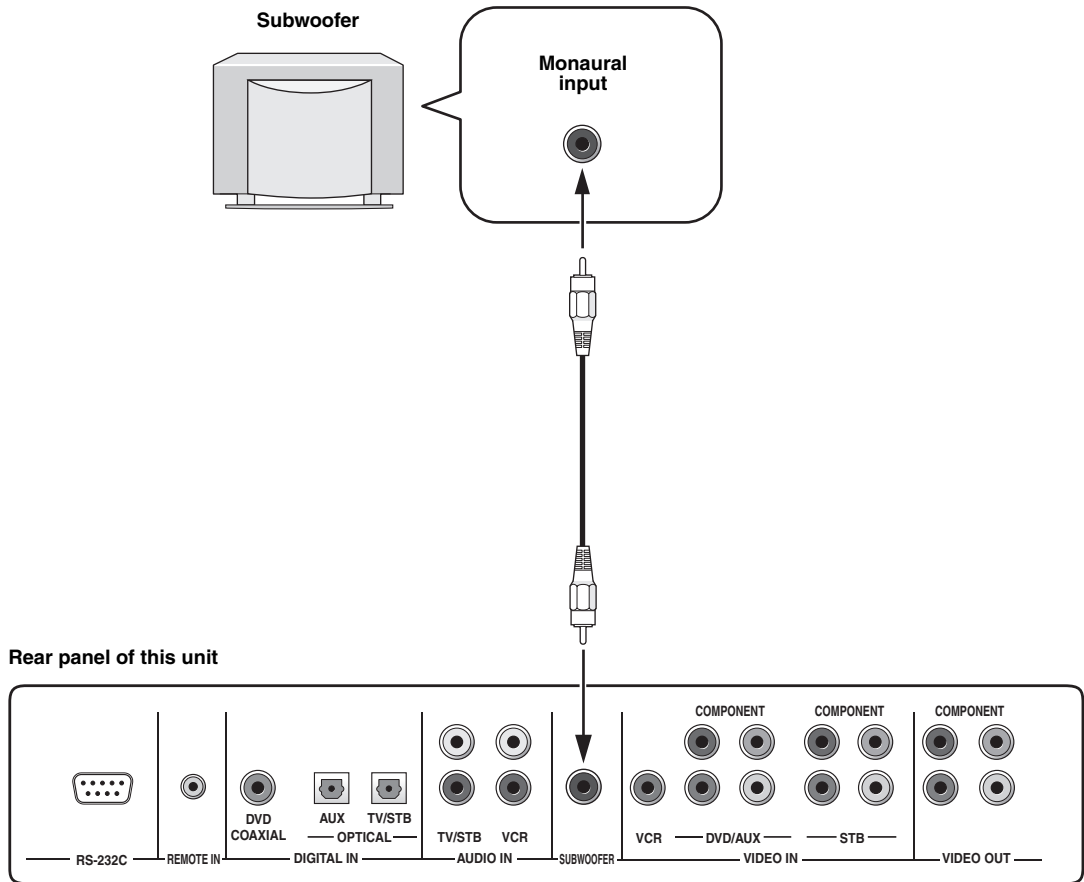

Cables used for connections

Subwoofer pin cable

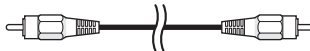

Connecting the power supply cable

Once all other connections are complete, plug one end of the power supply cable into the AC IN terminal of this unit and then plug the other end into the AC wall outlet.

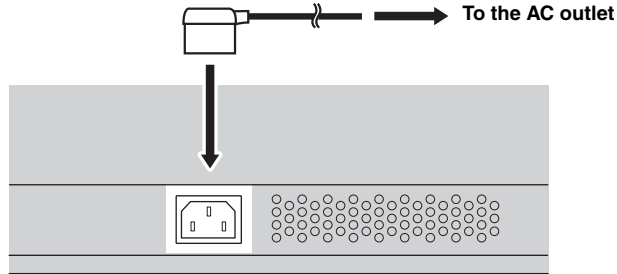

About the RS-232C/REMOTE IN/IR-OUT terminals

The RS-232C, REMOTE IN and IR-OUT terminals do not support normal external component connections. These are control expansion terminals for factory use only.

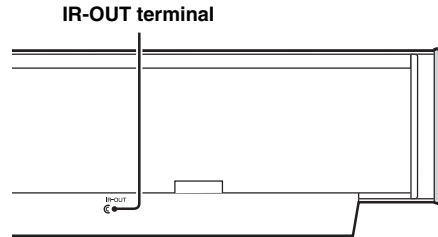
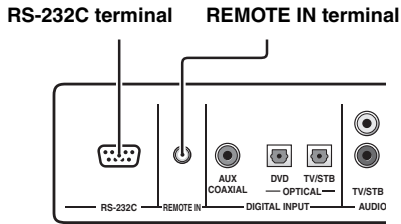

GETTING STARTED

Installing batteries in the remote control

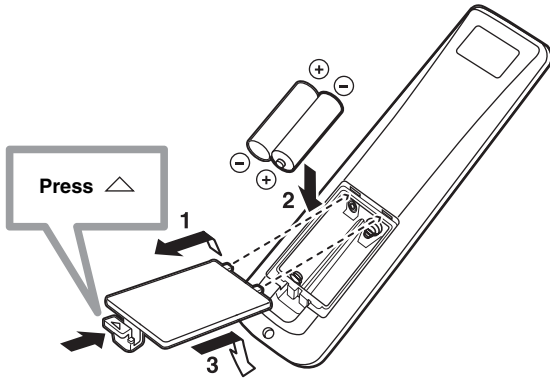

- 1 Press and hold the \triangle mark on the battery cover and then slide off the cover.**
- 2 Insert the two supplied batteries (AA, R6, UM-3) into the battery compartment.**
Make sure you insert the batteries according to the polarity markings (+/-).
- 3 Close the battery cover.**

Notes

- Change all of the batteries if you notice the following conditions; the operation range of the remote control decreases, the indicator does not blink or its light becomes dim.
- Do not use old batteries together with new ones.
- Do not use different types of batteries (such as alkaline and manganese batteries) together. Read the packaging carefully as these different types of batteries may have the same shape and color.
- Exhausted batteries may leak. If the batteries have leaked, dispose of them immediately. Avoid touching the leaked material or letting it come into contact with clothing, etc. Clean the battery compartment thoroughly before installing new batteries.
- Do not throw away batteries with general house waste. Dispose of them correctly in accordance with your local regulations.
- The contents of the memory stored in the remote control may be erased in the following cases:
 - The remote control is left without batteries for more than 2 minutes.
 - Exhausted batteries remain in the remote control.
 - The buttons on the remote control are accidentally pressed when you change batteries.
- If the memory stored in the remote control is unwantedly erased, insert new batteries and reset the remote control codes again.



Remove the transparent sheet before using the remote control.

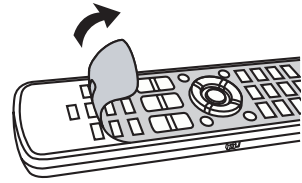

Operation range of the remote control

The remote control transmits a directional infrared beam. Use the remote control within 6 m of this unit and point it toward the remote control sensor on this unit during operation.

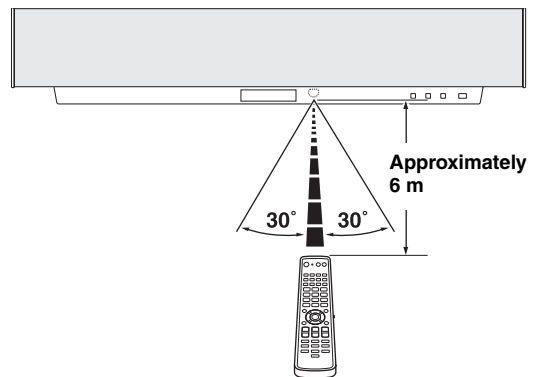

Notes

- Do not spill water or other liquids on the remote control.
- Do not drop the remote control.
- Do not leave or store the remote control in the following types of conditions:
 - places of high humidity, such as near a bath
 - places of high temperatures, such as near a heater or a stove
 - places of extremely low temperatures
 - dusty places
- Do not expose the remote control sensor on this unit to direct sunlight or lighting such as inverted fluorescent lamps.
- If the batteries grow old, the effective operation distance of the remote control decreases considerably. If this happens, replace the batteries with two new ones as soon as possible.

Using the remote control

This section describes how to control this unit using the supplied remote control. The functions of the remote control change depending on the position of the operation mode selector. Set the operation mode selector to YSP to switch to the operation mode of this unit. The buttons on the remote control numbered ① to ④ are operational only when you select YSP. Also, functions of the buttons numbered ⑤ to ⑨ vary depending on the position of the operation mode selector. The corresponding functions of the buttons, see page 9.



You can control other components by setting the appropriate remote control codes (see page 81). Once the remote control code for each input source (DVD, VCR, STB, TV or AUX) is set, see "Controlling other components" on page 82 for further information on the specific functions of the available remote control buttons for each input source.

Operational buttons only when YSP is selected

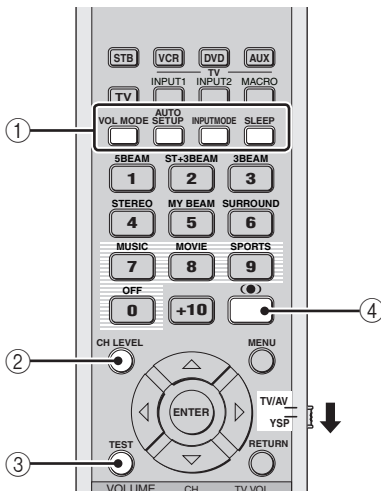

Function-varying buttons

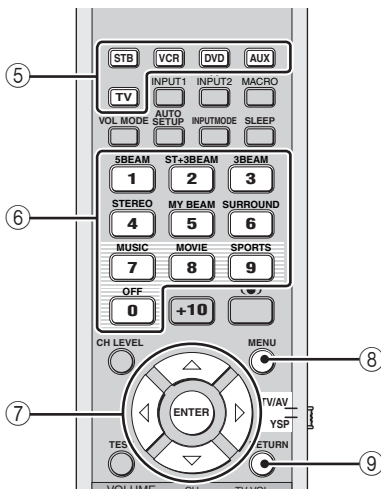

Turning on the power

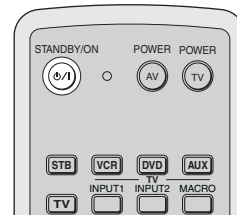
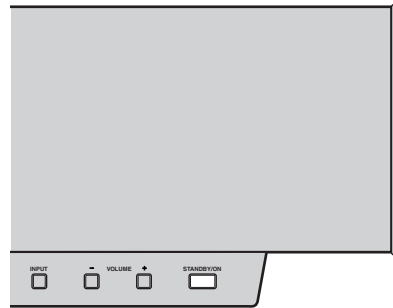

- 1 Press **STANDBY/ON** on the front panel or on the remote control to turn on the power of this unit.

The volume level appears in the front panel display and then the input source and beam mode currently selected are displayed.

STANDBY/ON



Front panel

or



Remote control

- 2 Press **STANDBY/ON** on the front panel or on the remote control again to set this unit to the standby mode.

Note

When the unit is in the standby mode, only **STANDBY/ON** on the front panel or on the remote control is operational, and the other control buttons on the front panel or on the remote control are not operational until the power of this unit is turned on.

USING SET MENU

Displaying the OSD

This section simply describes how to display the OSD (on-screen display) of this unit on your TV screen and set the parameters for your listening room. Once this is complete, you can enjoy real surround sound while watching TV in the comfort of your own home.

Note

The OSD is not output at the COMPONENT VIDEO OUT jacks of this unit. Connect the VIDEO OUT jack of this unit to the video input jacks of your TV to display the OSD.

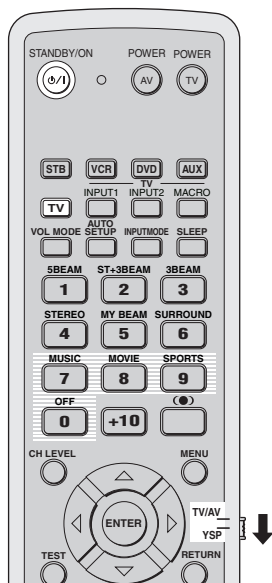

5 Press TV on the remote control to display the OSD of this unit on your TV screen.

It may take a few seconds before this unit's OSD appears on your TV screen.

If the OSD does not appear, use the remote control provided with your TV to switch the video input until the OSD appears.

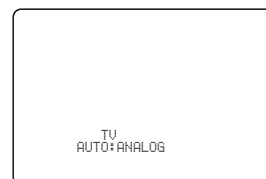

OSD screen example

1 Check that the video input jack on your TV is connected to the VIDEO OUT jacks of this unit to display the OSD of this unit.

2 Press STANDBY/ON on the front panel or on the remote control to turn on the power of this unit.



Front panel

or



Remote control

3 Turn on the power of your TV.

4 Set the operation mode selector to YSP to switch to the operation mode of this unit.



The flow chart of SET MENU

The following diagram illustrates the overall flow of the setup procedure.

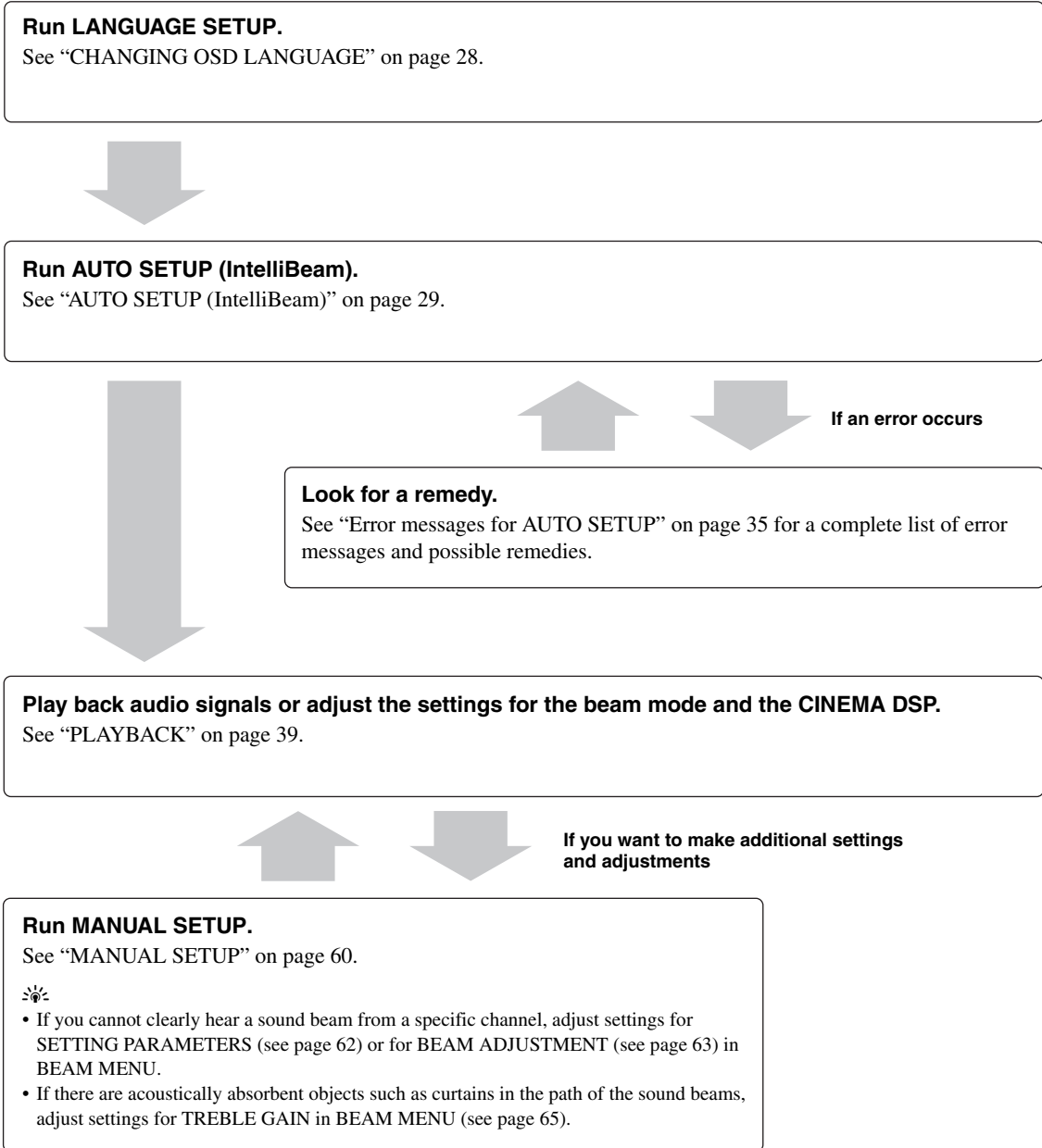

CHANGING OSD LANGUAGE

This feature allows you to select the language of your choice that appears in the SET MENU of this unit.

- 1 Set the operation mode selector to YSP to switch to the operation mode of this unit.**



- 2 Press MENU on the remote control.**
The SET MENU screen appears on your TV.

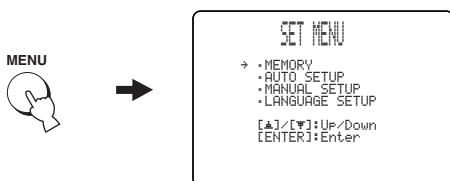

- The control buttons used for SET MENU are displayed on the bottom of the screen.
- To return to the previous screen while using SET MENU, press RETURN on the remote control.
- To cancel the SET MENU screen, press MENU once more.
- You can also perform the following operations in the front panel display.

- 3 Press ▲ / ▼ to select LANGUAGE SETUP and then press ENTER.**

The following screen appears on your TV.

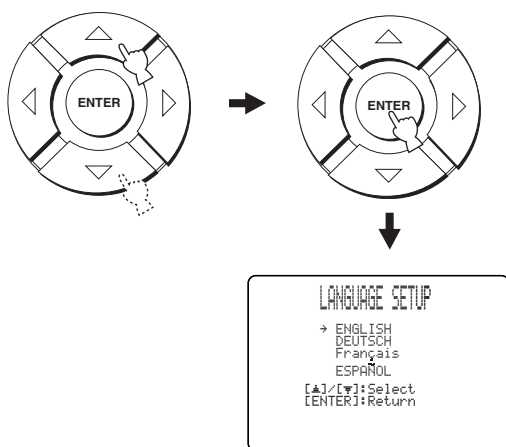

- 4 Press ▲ / ▼ to select the language and then press ENTER.**

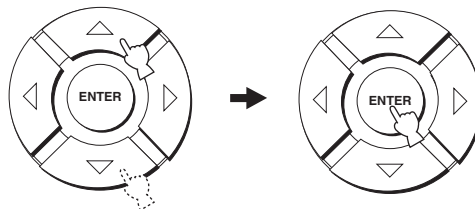

Choices: **ENGLISH** (English), **DEUTSCH** (German), **Français** (French), **ESPAÑOL** (Spanish)

AUTO SETUP (IntelliBeam)

This unit creates a sound field by reflecting sound beams on the walls of your listening room and broadening the cohesion of all the channels. Just as you would arrange the speaker position of other audio systems, you need to set the beam angle to enjoy the best possible sound from this unit.

This unit employs the beam optimization and sound optimization features with the aid of the supplied optimizer microphone, allowing you to avoid troublesome listening-based setup and achieving highly accurate sound adjustments that best match your listening environment. We call these 2 features “IntelliBeam” generically.

The beam optimization creates the best possible surround sound field without manually setting the parameters for your listening room.

The sound optimization feature performs the following checks and automatically makes appropriate sound adjustments.

DISTANCE:

Checks the distance of each beam from this unit and adjusts the delay of each channel so that each sound beam reaches the listening position at the same time.

EQUALIZING:

Adjusts frequency and levels of each channel’s parametric equalizer to reduce coloration across the channels and create a cohesive sound field. The sound optimization feature incorporates three parameters (frequency, level and Q factor) for each of the seven bands in its parametric equalizer to provide highly precise automatic adjustment of frequency characteristics.

LEVEL:

Checks and adjusts the sound output level of each channel.

The flow chart of AUTO SETUP

This unit performs a series of checks to optimize the beam angle, delay, volume and quality. You can choose to optimize all or part of the parameters.

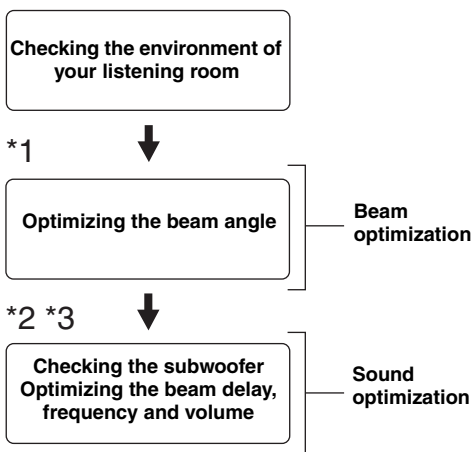

Notes

- *1 The beam angle checking procedure is skipped if SOUND OPTIMZ only is selected.
- *2 The sound optimization procedure is skipped if BEAM OPTIMZ only is selected.
- *3 The subwoofer checking procedure is skipped if BEAM OPTIMZ only is selected.

Installing the optimizer microphone

The supplied optimizer microphone collects and analyzes the sound that this unit produces in your actual listening environment. Follow the procedure below to connect the optimizer microphone to this unit and make sure that the optimizer microphone is placed in a proper location and that there are no large obstacles between the optimizer microphone and the walls in your listening room.

Notes

- After you have completed the AUTO SETUP procedure, be sure to disconnect the optimizer microphone.
- The optimizer microphone is sensitive to heat.
 - Keep it away from direct sunlight.
 - Do not place it on top of this unit.
- Do not connect the optimizer microphone to an extension cable as doing so may result in an inaccurate sound optimization.
- An error may occur during the AUTO SETUP procedure if the optimizer microphone is not properly placed in your listening room. To avoid the possibility of an error:
 - Do not place the optimizer microphone to the extreme right or left from the center of this unit.
 - Do not place the optimizer microphone within 1.8 m (6.0 ft) from the front of this unit.
 - Do not place the optimizer microphone more than 1 m (3.3 ft) upper or lower from the center height of this unit.
- Make sure that there are no obstacles between the optimizer microphone and the walls in your listening room as these objects obstruct the path of sound beams. However, any objects that are in contact with the walls will be regarded as a protruding part of the walls.
- The best possible results are achieved if the optimizer microphone is placed at the same height as your ears would be when you are seated in your listening position. However, if this is not possible, you can manually fine-tune the sound beam angle and balance the sound beam output levels using MANUAL SETUP (see page 60) once the AUTO SETUP procedure is completed.
- If a subwoofer with adjustable volume and crossover/high cut frequency controls is connected to this unit, set the volume between 11 and 1 o'clock as viewed on a conventional clockface and set the crossover/high cut frequency to the maximum.

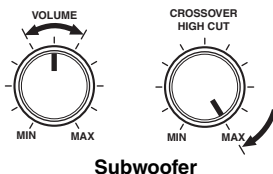

1 Press **STANDBY/ON** on the front panel or on the remote control to turn off the power of this unit.



Front panel

or



Remote control

2 Connect the supplied optimizer microphone to the **OPTIMIZER MIC** jack on the side of this unit.

Side view

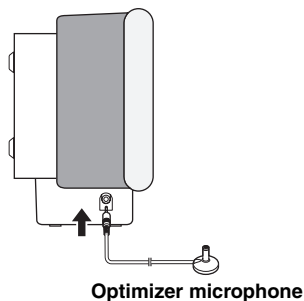

Optimizer microphone

3 Place the optimizer microphone on a flat level surface more than 1.8 m (6.0 ft) from the front of the unit and within 1 m (3.3 ft) upper or lower from the center height of the unit with the optimizer microphone head upward at your normal listening position.

Note

Be sure to place the optimizer microphone on an imaginary center line drawn from this unit.



You may want to use the supplied cardboard microphone stand to affix the optimizer microphone at the same height as your ears would be when you are seated in your listening position.

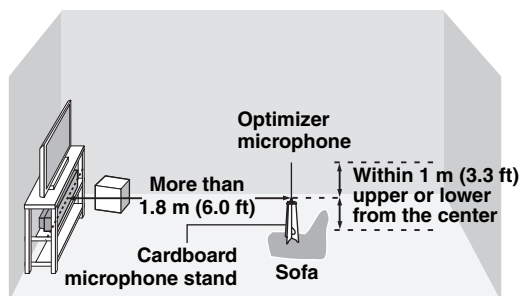

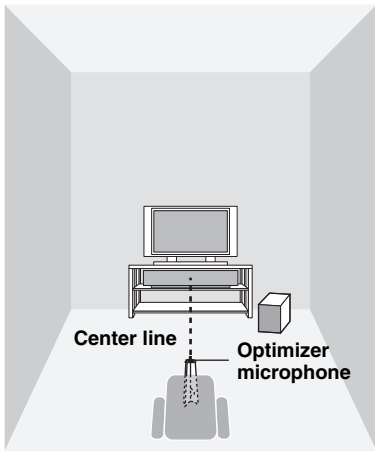

Using AUTO SETUP (IntelliBeam)

Once the optimizer microphone is firmly connected to this unit and properly placed in your listening room, follow the procedure below to start the AUTO SETUP procedure. You can also enter the AUTO SETUP procedure simply by pressing and holding AUTO SETUP on the remote control more than 2 seconds. In this case, this unit performs both of the beam optimization and sound optimization procedures.

■ Assembling the supplied cardboard microphone stand

You will find three separate parts (one circular-shaped part and two longitudinal-shaped parts) of the cardboard microphone stand originally put together.

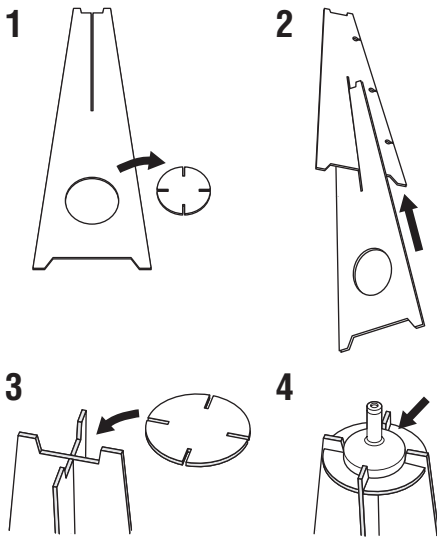

- 1** Disassemble the three parts of the cardboard microphone stand originally put together.
- 2** Insert one of the longitudinal-shaped part into the crevice of the other longitudinal-shaped part.
- 3** Place the circular-shaped part on top of the two combined longitudinal-shaped parts.
- 4** Place the supplied optimizer microphone on top of the circular-shaped part.

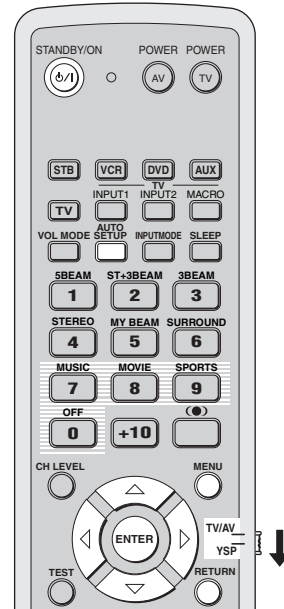
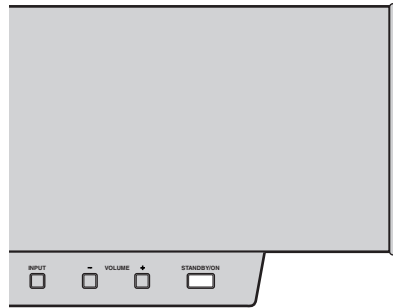

Notes

- Make sure that your listening room is as quiet as possible while this unit is performing the AUTO SETUP procedure.
- To achieve the best results possible, evacuate yourself from your listening room until the AUTO SETUP procedure is completed so that you may not obstruct the path of sound beams.
- Be advised that it is normal for loud test tones to be output during the AUTO SETUP procedure.
- The AUTO SETUP procedure may not be run successfully if this unit is installed in one of the rooms described in “Before installing this unit” on page 11. In such cases, run MANUAL SETUP (see page 60) to manually adjust the corresponding parameters.
- If an error occurs, an error buzzer is played, the AUTO SETUP procedure stops and then an error message appears on the screen. See “Error messages for AUTO SETUP” on page 35 for appropriate remedies.



- The AUTO SETUP procedure takes about 3 minutes maximum. A chime is played when the AUTO SETUP procedure is run successfully.
- If there are curtains in your listening room, we recommend following the procedure below.
 1. Open the curtains to improve sound reflection.
 2. Run BEAM OPTIMZ only.
 3. Close the curtains.
 4. Run SOUND OPTIMZ only.
- You can save the settings optimized by the AUTO SETUP procedure (see page 36). A set of settings optimized according to specific conditions of your listening environment can be recalled later depending on the varying conditions of your listening environment (see page 37).

1 Press STANDBY/ON on the front panel or on the remote control to turn on the power of this unit.

If a subwoofer is connected to this unit, turn on the power of the subwoofer.



Front panel

or



Remote control

2 Set the operation mode selector to YSP to switch to the operation mode of this unit.



3 Press MENU on the remote control.

The SET MENU screen appears on your TV.



- The control buttons used for SET MENU are displayed on the bottom of the screen.
- To return to the previous screen while using SET MENU, press RETURN on the remote control.
- To cancel the SET MENU screen, press MENU again.
- You can start the BEAM+SOUND OPTIMZ procedure simply by pressing and holding AUTO SETUP on the remote control for more than 2 seconds. Step 4 and 5 are skipped and then the screen shown in step 5 is displayed on your TV. Start the AUTO SETUP procedure from step 6.
- You can also perform the following operations in the front panel display.

4 Press ▲ / ▼ on the remote control to select AUTO SETUP and then press ENTER.

The following screen appears on your TV.

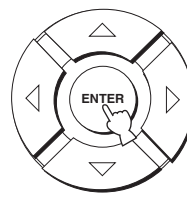
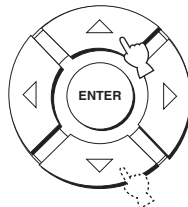

- 5 Press \triangle / ∇ to select BEAM+SOUND OPTIMZ, BEAM OPTIMZ only or SOUND OPTIMZ only and then press ENTER.**

The following screen appears on your TV.

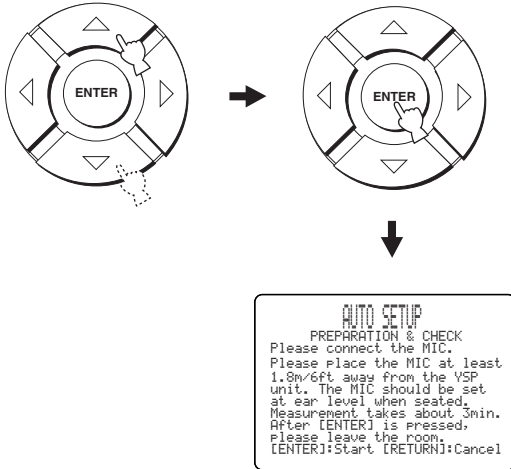

**BEAM+SOUND OPTIMZ
(Beam optimization and sound optimization)**

Use to optimize the beam angle, delay, volume and quality so that the parameters best match your listening environment.

It is recommended that you should select this optimization feature in the following cases:

- If you make settings for the first time.
- If the unit has been relocated.
- If your listening room has been restructured.
- If the objects in your listening room (furniture, etc.) have been rearranged.

This menu takes about 3 minutes.

**BEAM OPTIMZ only
(Beam optimization only)**

Use to optimize the beam angle so that the parameter best matches your listening environment.

This menu takes about 1 minute.

**SOUND OPTIMZ only
(Sound optimization only)**

Use to optimize the beam delay, volume and quality so that the parameters best match your listening environment.

It is recommended that you should select this optimization feature in the following cases:

- If you have opened or closed the curtains in your listening room before using this unit.
- If you have manually set the beam angle.

This menu takes about 2 minutes.

Note

You must optimize the beam angle in the BEAM OPTIMZ only procedure before starting the SOUND OPTIMZ only procedure.

- 6 Check the following points once again before starting the AUTO SETUP procedure.**

- Is the optimizer microphone firmly connected to this unit?
- Is the optimizer microphone placed in a proper location?
- Are there any large obstacles in between the optimizer microphone and the walls in your listening room?

- 7 Press ENTER to start the AUTO SETUP procedure.**

The following screen appears on your TV and the AUTO SETUP procedure starts in 10 seconds.

Evacuate yourself from your listening room before starting the AUTO SETUP procedure.

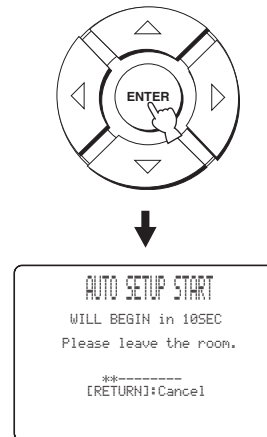

If an error occurs, an error buzzer is played and an error message is displayed. See “Error messages for AUTO SETUP” on page 35 for a complete list of error messages and their proper remedies. Follow the instructions and perform the AUTO SETUP procedure again.

SETUP

English

8 Check that the following screen is displayed on your TV.

The results of the AUTO SETUP procedure are displayed on your TV.

Example 1

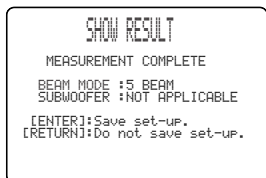

Example 2

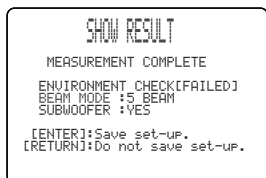

- If “ENVIRONMENT CHECK [FAILED]” is displayed, we recommend running the AUTO SETUP procedure again. For details, see step 9.
- If “SUBWOOFER : NOT APPLICABLE” is displayed even though a subwoofer is connected to this unit, increase the volume level of the subwoofer and run the AUTO SETUP procedure again.
- Depending on the environment of your listening room, the beam angle of front left and right, and surround left and right may be set to the same value even if 5BEAM is displayed as a result.

9 Press ENTER to confirm the results or press RETURN to cancel the results.

The following screen is displayed temporarily for 2 seconds and then disappears from your TV.

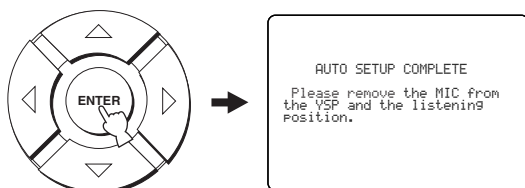

If “ENVIRONMENT CHECK [FAILED]” is displayed in step 8, the following screen is displayed after pressing ENTER. In this case, see ERROR E-1 in “Error messages for AUTO SETUP” on page 35. Press ENTER to exit the AUTO SETUP and then run the procedure again from step 3.

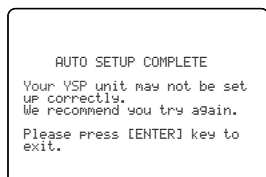

10 Disconnect the optimizer microphone from the OPTIMIZER MIC jack on the front panel.

Side view

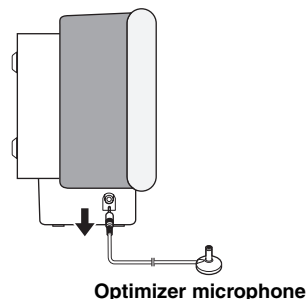

■ Error messages for AUTO SETUP

Before the AUTO SETUP procedure starts

Error message	Cause	Remedy	See page
ERROR E-2 No MIC Detected. Please check MIC connection and re-try.	The optimizer microphone is not connected to this unit.	Connect the optimizer microphone to this unit.	30

While the AUTO SETUP procedure is in progress

If one of the errors shown below except E-1 is displayed, press RETURN. In case you have started the AUTO SETUP procedure by pressing AUTO SETUP on the remote control in step 3, run the procedure again from step 3 after once the screen disappears. In case you have started the AUTO SETUP procedure by pressing MENU on the remote control in step 3, run the procedure again from step 5 after the screen in step 4 is displayed. Run the MANUAL SETUP if the problem is difficult to be saved.

Error message	Cause	Remedy	See page
ERROR E-1 Please test in quieter environment.	There is too much unwanted noise in your listening room.	Make sure that your listening room is as quiet as possible. You may want to choose certain hours during the day when there is not much noise coming from outside.	—
ERROR E-2 No MIC detected. Please check MIC connection and re-try.	The optimizer microphone was disconnected while the AUTO SETUP procedure was in progress.	Make sure that the optimizer microphone is firmly connected to this unit.	30
ERROR E-3 Unexpected control is detected. Please re-try.	Some other operations were performed on this unit while the AUTO SETUP procedure was in progress.	Do not perform any other operations while the AUTO SETUP procedure is in progress.	—
ERROR E-4 Please check MIC position. MIC should be set in front of YSP.	The optimizer microphone is not placed in front of this unit.	Make sure that the optimizer microphone is installed in front of this unit.	30
ERROR E-5 Please check MIC position. MIC should be set above 1.8m/6ft.	The optimizer microphone is not placed in the right distance from this unit.	Make sure that the optimizer microphone is installed more than 1.8 m from the front of this unit and within 1 m from the center height of this unit.	30
ERROR E-6 Volume level is lower than expected. Please check MIC position/connection and re-try.	The optimizer microphone cannot collect the sound produced by this unit because the sound output level is too low.	Make sure that the optimizer microphone is firmly connected to this unit and placed in a proper location. If the problem persists, contact the nearest YAMAHA service center for assistance.	30
ERROR E-7 Unexpected error happened. Please re-try.	An internal system error occurred.	Repeat the AUTO SETUP procedure.	—

USING THE SYSTEM MEMORY

Convenient usage of the system memory

You can save the current settings adjusted in SET MENU in the system memory of this unit. It is handy to save certain settings according to the varying conditions of your listening environment. For example, if there are curtains in the path of beams, the effectiveness of the beams will vary depending on whether the curtains are open or closed.

When the curtains are open

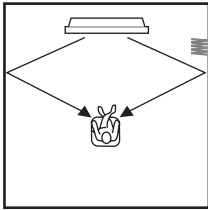

When the curtains are closed

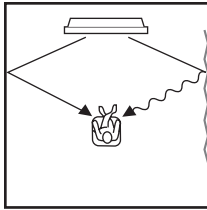

Saving settings

- 1 Set the operation mode selector to YSP to switch to the operation mode of this unit.



- 2 Press MENU on the remote control. The SET MENU screen appears on your TV.

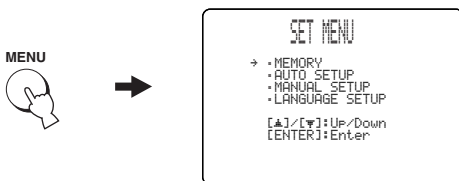

- The control buttons used for SET MENU are displayed on the bottom of the screen.
- To return to the previous screen while using SET MENU, press RETURN on the remote control.
- To cancel the SET MENU screen, press MENU once more.
- You can also perform the following operations in the front panel display.

- 3 Press Δ / ∇ to select MEMORY and then press ENTER.

The following screen appears on your TV.

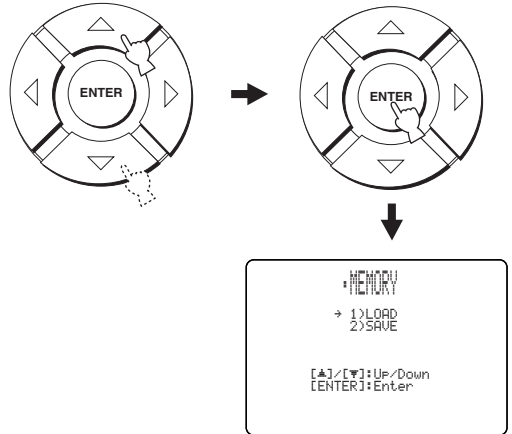

- 4 Press Δ / ∇ to select SAVE and then press ENTER.

The following screen appears on your TV.

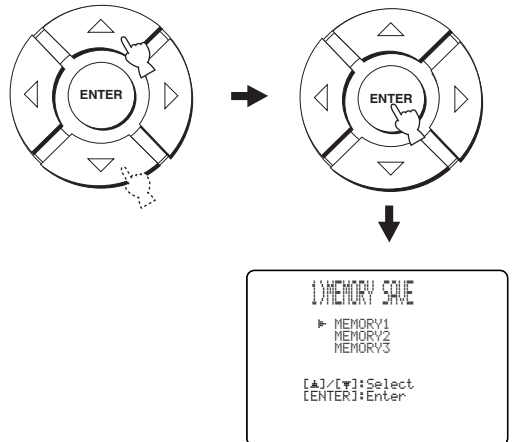

5 Press \triangle / \triangleright to select MEMORY1, MEMORY2 or MEMORY3 and then press ENTER.

The following screen appears on your TV.

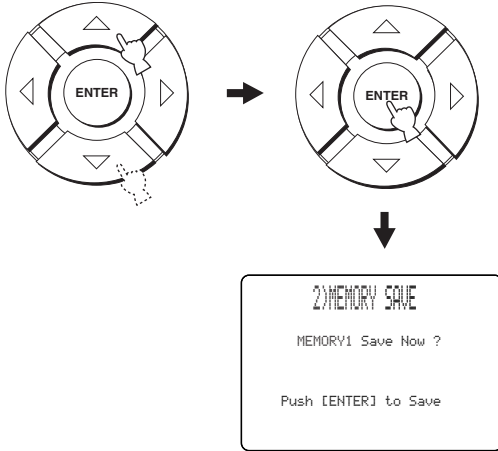

6 Press ENTER again.

The new parameters are saved as MEMORY1, MEMORY2 or MEMORY3. Once the parameters are saved, the display returns to the SET MENU screen.

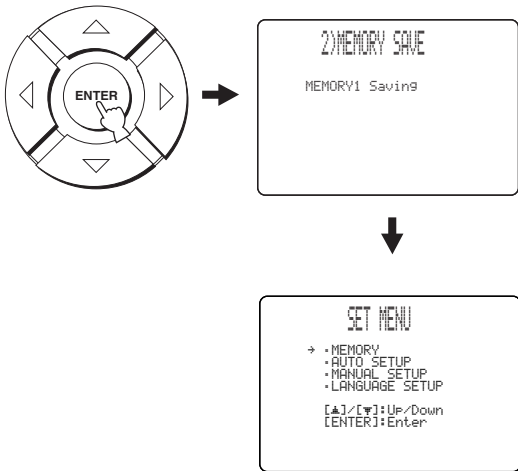

7 Press MENU to exit.

The SET MENU screen disappears from your TV.



Loading settings

You can recall the settings saved in “Saving settings” on page 36 according to the varying conditions of your listening environment.

1 Set the operation mode selector to YSP to switch to the operation mode of this unit.



2 Press MENU on the remote control.

The SET MENU screen appears on your TV.

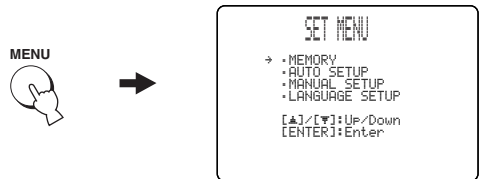

- The control buttons used for SET MENU are displayed on the bottom of the screen.
- To return to the previous screen while using SET MENU, press RETURN on the remote control.
- To cancel the SET MENU screen, press MENU once more.
- You can also perform the following operations in the front panel display.

3 Press \triangle / \triangleright to select MEMORY and then press ENTER.

The following screen appears on your TV.

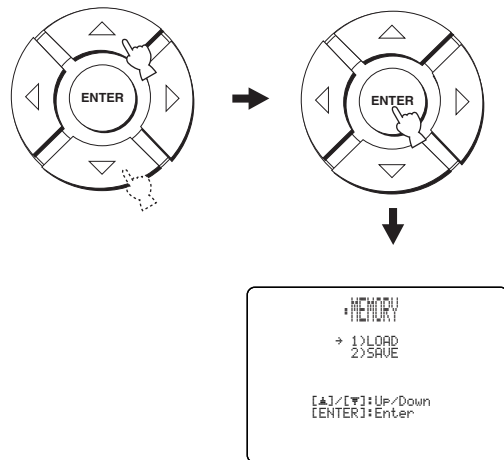

4 Press \triangle / ∇ to select LOAD and then press ENTER.

The following screen appears on your TV.

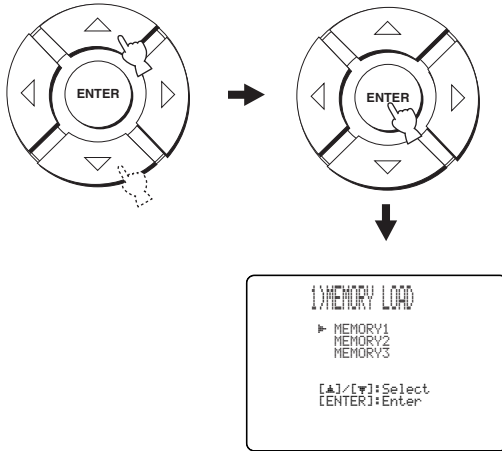

5 Press \triangle / ∇ to select MEMORY1, MEMORY2 or MEMORY3 and then press ENTER.

The following screen appears on your TV.

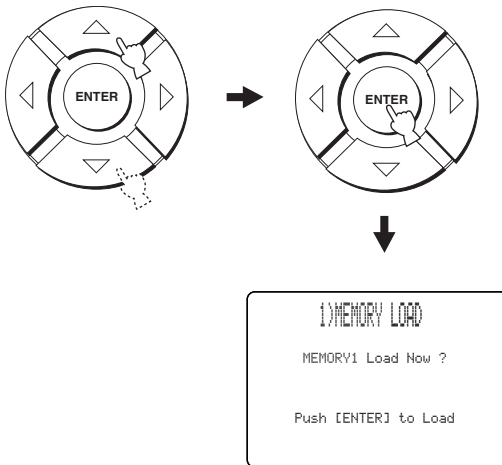

6 Press ENTER again.

The new parameters are saved as MEMORY1, MEMORY2 or MEMORY3. Once the parameters are saved, the display returns to the SET MENU screen.

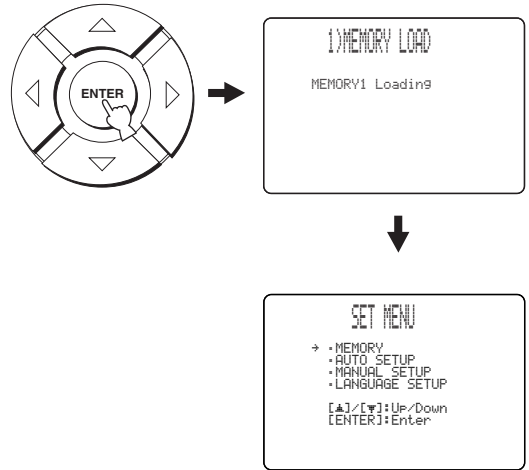

7 Press MENU to exit.

The SET MENU screen disappears from your TV.



PLAYBACK

Selecting the input source

You can play back sound from the components connected to this unit simply by pressing INPUT on the front panel repeatedly or pressing one of the input selector buttons (TV, STB, VCR, DVD or AUX) on the remote control. The name of the selected input source and the type of the corresponding input mode appear in the front panel display.

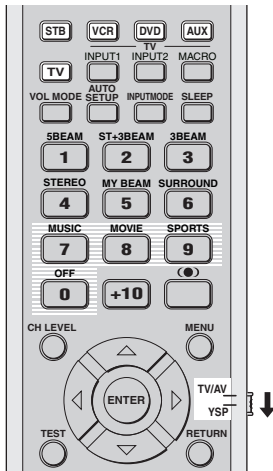
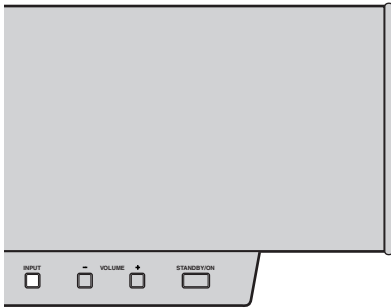

■ Front panel operations

Press **INPUT** on the front panel repeatedly to **toggle between TV, DVD, VCR and AUX.**

The name of the corresponding input source and the type of the current input mode are shown in the front panel display.

■ Remote control operations

Set the operation mode selector to **YSP** to switch to the operation mode of this unit and then press **TV** on the remote control to play back a TV program.

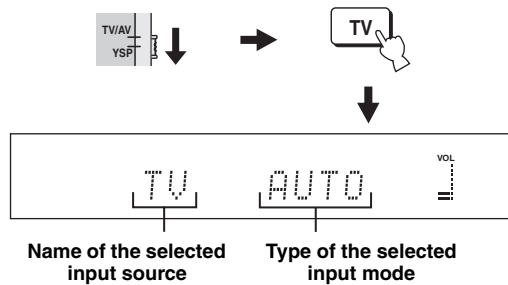

Set the operation mode selector to **YSP** to switch to the operation mode of this unit and then press **STB** on the remote control to play back a satellite broadcast.

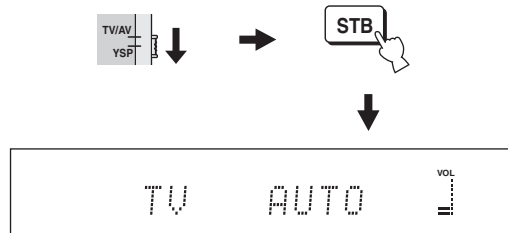

Set the operation mode selector to **YSP** to switch to the operation mode of this unit and then press **DVD** on the remote control to play back a DVD.

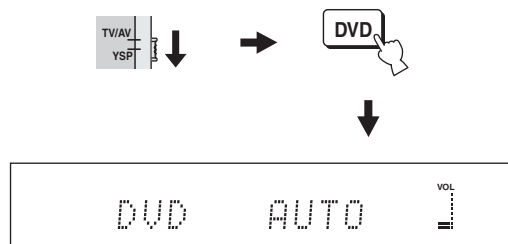

Set the operation mode selector to YSP to switch to the operation mode of this unit and then press VCR on the remote control to play back a video tape.

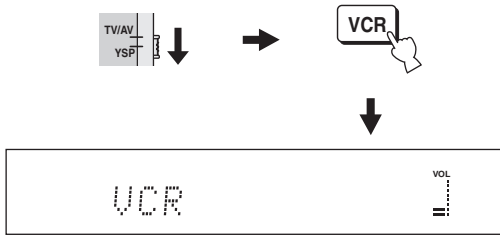

Set the operation mode selector to YSP to switch to the operation mode of this unit and then press AUX on the remote control to play back a component connected to the AUX jack on the rear panel of this unit.

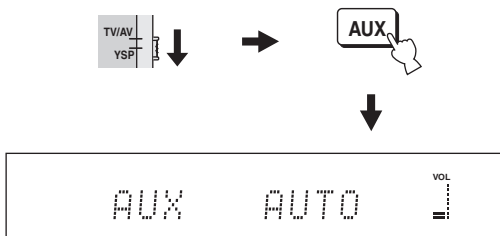

Playing back sources

Once an input source is selected (see page 39), you can play back the selected input source.

Note

This section uses a DVD player as an example of the playback source.



For details on the TV and the DVD player you are using, refer to the owner's manual supplied with the TV and the DVD player.

- 1 Turn on the power of your DVD player using the remote control supplied with the DVD player.
- 2 Switch to the video input on your TV using the remote control supplied with the TV so that the DVD menu screen is displayed.
- 3 If necessary, turn down the volume of your TV until you cannot hear any sound.
- 4 Set the operation mode selector to YSP to switch to the operation mode of this unit.



- 5 Press DVD on the remote control to select DVD as the input source.



- 6 Play back the DVD on your DVD player using the supplied remote control.

Audio signals from your DVD player are output from this unit.



- You can check the digital signal being input at the DVD player with the digital connection (optical/coaxial). Press ST+3BEAM on the remote control while playing back a DVD recorded in 5.1 channel. The **DIGITAL** or **dts** indicator lights up when this unit detects the 5.1 channel signal input at the optical/coaxial jack. If the **PCM** indicator lights up, confirm the digital connection and the settings of the digital output, bitstream output, and/or DTS output of the DVD player.
- If the output volume is too low, increase the volume on this unit to around 45.
- If you have set the appropriate remote control codes for your TV and DVD player, you can use the remote control supplied with this unit to operate these components. For details on how to set remote control codes, see page 81.

Adjusting the volume

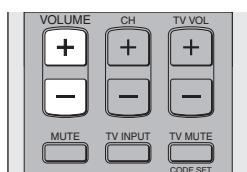
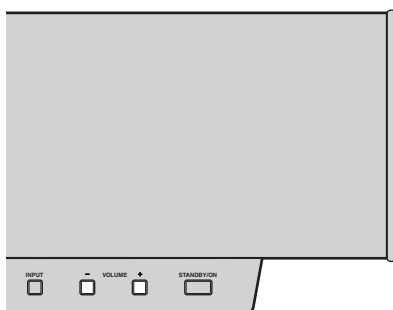

Press **VOLUME +/-** on the front panel or on the remote control to increase or decrease the volume level.

The numeric value of the volume level appears in the front panel display.

Control range: MIN (minimum), 01 to 99, MAX (maximum)

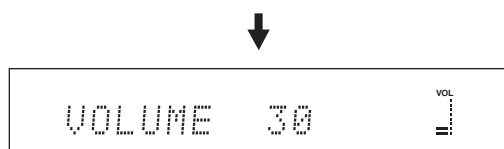
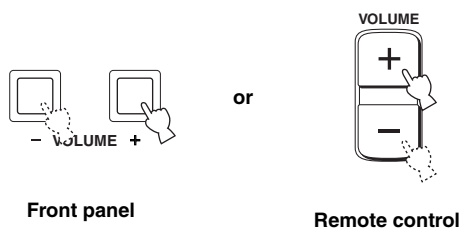

Notes

- The volume level of all input sources (including multi-channel as well as stereo sources) changes at the same time.
- One of the volume level increases or decreases each time you press VOLUME +/-.
- You can continuously increase or decrease the volume level if you press and hold VOLUME +/-.

Muting the sound

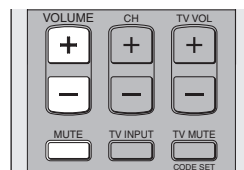

- 1 Press **MUTE** on the remote control to mute the sound.

AUDIO MUTE ON appears in the front panel display, and the volume level indicator flashes.

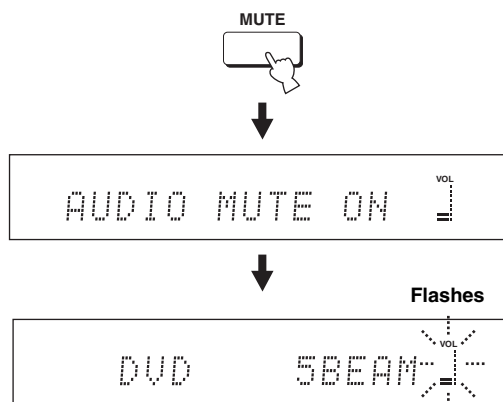

- 2 Press **MUTE** on the remote control again (or press **VOLUME +/-**) to resume the sound output.

AUDIO MUTE OFF appears temporarily in the front panel display (or the numeric value of the current volume level appears if you press VOLUME +/-), and the volume level indicator lights up.

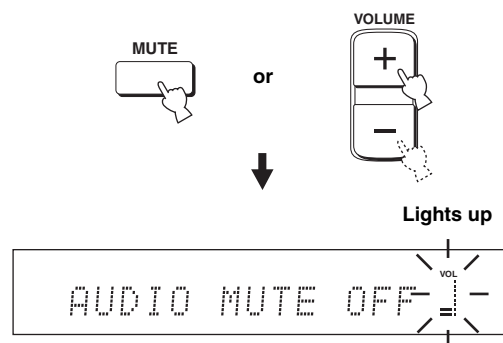

Note

The sound output of all input sources (including multi-channel as well as stereo sources) is muted at the same time.



You can select whether the sound output is to be muted completely or by 20 dB when you press MUTE (see page 67).

ENJOYING SURROUND SOUND

You can enjoy multi channel surround sound by changing the beam mode using the beam mode buttons on the remote control. Select 3 beam, 5 beam and stereo plus 3 beam for multi channel playback.

Note

When ANGLE TO WALL OR CORNER is set in MANUAL SETUP (see page 62), 5 beam and 3 beam cannot be selected.

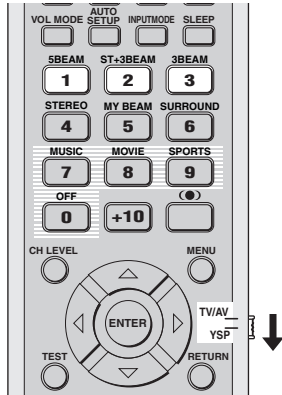

- 1 Set the operation mode selector to YSP to switch to the operation mode of this unit.



- 2 Press one of the beam mode buttons (5BEAM, ST+3BEAM or 3BEAM) to select the desired beam mode for 5.1-channel playback.

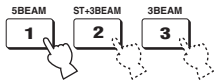

5 beam

Outputs sound beams from the front left and right, center, and surround left and right channels. This mode is ideal for enjoying surround sound effects to the fullest when watching DVDs recorded in a multi-channel format or playing back 2-channel sources in a multi-channel format.

Press 5BEAM on the remote control to select the 5 beam.

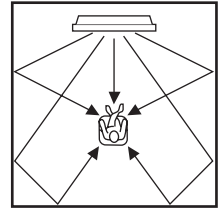

Notes

- To achieve the best surround sound effect, make sure that there are no obstacles placed in the path of sound beams in that the objects may prevent the beams from rebounding directly off the walls in your listening room.
- The front left and right sound beams are output towards the walls in your listening room.

Stereo plus 3 beam

Outputs normal sound from the front left and right channels and sound beams from the center and surround left and right channels. This mode is ideal for watching live recordings on a DVD. Vocals and instrumental sounds can be heard close to the center of the listening position while sound reflections from the venue itself can be heard on your right and left, giving you the feeling that you are sitting right in front of the stage.

Press ST+3BEAM on the remote control to select the stereo plus 3 beam.

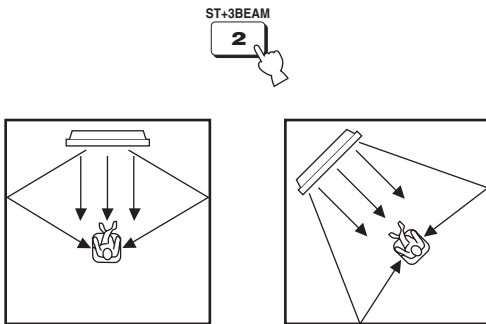

Note

The front left and right sound beams are output directly to the listening position.

3 beam

Outputs sound beams from the front left and right and center channels. This mode is ideal for enjoying movies with the whole family. Because the listening position area is widened, you can enjoy excellent quality surround sound over a wider area. In addition, you can use this mode when the listening position is close to the backside of the wall and the surround left and right beams cannot reflect.

Press 3BEAM on the remote control to select the 3 beam.

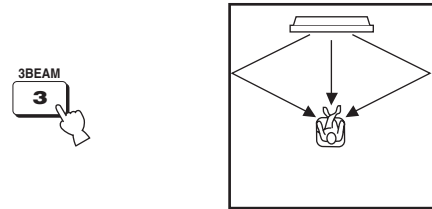

You can achieve a more realistic surround effect if you adjust settings for IMAGE LOCATION in BEAM MENU (see page 66).

Notes

- When you play back multi-channel sources, surround left and right signals are mixed down and output from the front left and right channels.
- The front left and right sound beams are output towards the walls in your listening room.

■ Decoder indicators

Depending on the input source and the selected surround mode, the indicators in the front panel display light up as follows:

Status	Indicator
When PCM signals are being input	PCM
When DTS digital signals are being input or when DTS Neo:6 is selected	dts
When Dolby Digital signals are being input	DIGITAL
When Dolby Pro Logic is selected	PL
When Dolby Pro Logic II is selected	PL II



- You can select an input mode (AUTO, DTS or ANALOG) by pressing INPUTMODE on the remote control repeatedly (see page 75).
- Discs encoded in DTS-ES or Dolby Digital 5.1 EX will be played back in DTS or Dolby Digital.

■ Surround modes and recommended sources

Surround mode		Recommended source
Dolby Pro Logic	–	All sources
Dolby Pro Logic II	Movie Music Game	Movies Music Games
DTS Neo:6	Cinema Music	Movies Music

Notes

- Surround modes are available when the beam mode is set to a setting other than the stereo playback or the my beam as the beam mode.
- When you select an input source (see page 39), the surround mode used for the previously selected input source is selected.
- If the power of this unit is turned off and on again, the surround mode used for the previously selected input source before the power was turned off is selected.
- The surround modes are available only when the CINEMA DSP programs are turned off (see page 54) or when the movie program is selected as the CINEMA DSP program (see page 52).
- Only Dolby Pro Logic, Dolby Pro Logic II Movie and DTS Neo:6 Cinema are available when the movie program is selected as the CINEMA DSP program (see page 52).
- If the surround modes are not available, “Prohibit” appears in the front panel display when you press SURROUND on the remote control.
- The surround modes are available only when 2-channel signals are being input. If you try to switch between the surround modes when 5.1 channel signals are being input, “Prohibit” appears in the front panel display.

Enjoying 2-channel sources in surround sound

This unit can decode 2-channel sources for 5.1 channel playback so that you can enjoy a variety of surround sound effects by switching the surround mode.



The surround modes are available only when the CINEMA DSP programs are turned off (see page 54) or when the movie program is selected as the CINEMA DSP program (see page 52). In addition, the beam must be set to the 5 beam, the stereo plus 3 beam or the 3 beam (see page 42).

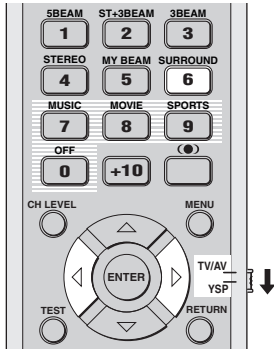

- 1 Set the operation mode selector to YSP to switch to the operation mode of this unit.



- 2 Press SURROUND on the remote control repeatedly (or press SURROUND and then press \leftarrow/\rightarrow) to switch between surround modes.

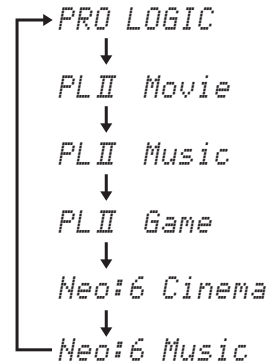
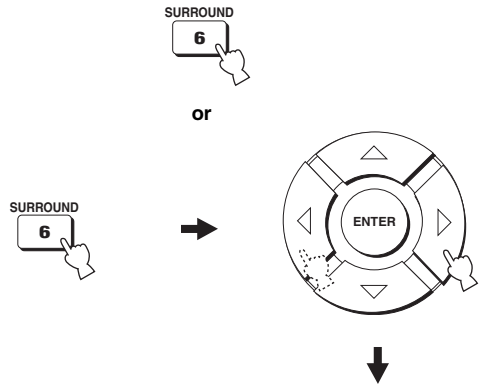

Example of the surround mode display in the front panel display when the CINEMA DSP program is turned off

Adjusting surround mode parameters

You can configure the parameters for Dolby Pro Logic II Music and DTS Neo:6 Music to fine-tune the surround sound effect.

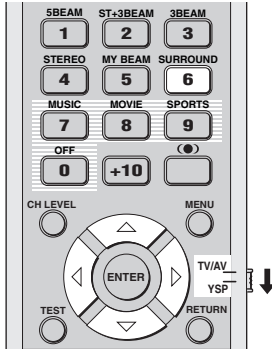

1 Repeat steps 1 and 2 in “Enjoying 2-channel sources in surround sound” on page 45 and select PL II Music or Neo:6 Music.

2 Press \triangle / ∇ to select the parameter.

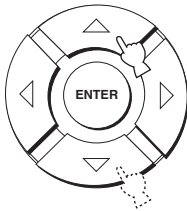

3 Press $\triangleleft / \triangleright$ to configure the parameter.

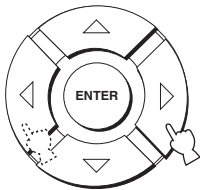

■ When Dolby Pro Logic II Music is selected

PANORAMA

Gives front left and right channel sound a wraparound effect, distributed throughout the entire surround sound field to give you an expansive feeling.

Choices: ON/OFF

Default setting: OFF

DIMENSION

Adjusts the difference in volume between front and surround channels to the volume balance you desire.

Control range: -3 (toward the surround direction) to +3 (toward the front direction)

Default setting: STD

CT WIDTH

Distributes the center channel sound to the left and right. If set to 0, center channel sounds output only from the center channel.

Control range: 0 to 7

Default setting: 3

■ When DTS Neo:6 Music is selected

C. IMAGE

Adjusts the center image from three channels (front and center) to varying degrees.

Control range: 0.0 (wider) to 1.0 (toward the center)

Default setting: 0.3

ENJOYING STEREO SOUND

Stereo playback

You can enjoy 2-channel stereo playback by changing the beam mode to the stereo playback using the beam mode buttons on the remote control. The normal sounds are output from the front and left channels in the 2-channel stereo. This is ideal for playing back hi-fi sources, such as CDs, and can be used to replace your TV speakers.

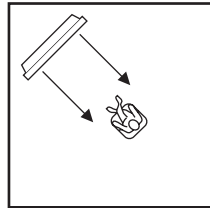
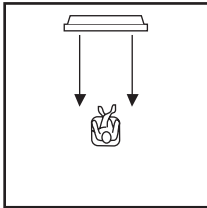
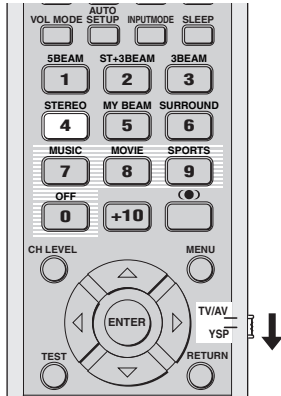

- 1 Set the operation mode selector to YSP to switch to the operation mode of this unit.



- 2 Press STEREO on the remote control to select the stereo playback as a beam mode.



Notes

- When you play back multi-channel sources, all signals except those for the front left and right channels are mixed down and output from the front left and right channels. No audio is output from the center and rear channels.
- The surround mode becomes disabled when the stereo playback is selected as the beam mode.
- When you play back Dolby Digital audio signals in the stereo playback, the dynamic range becomes compressed. If the volume level decreases to the extreme, use other beam modes except the my beam.
- If the stereo playback is selected as the beam mode, the surround modes (see page 44) and the CINEMA DSP programs (see page 52) become ineffective.

PLAYING BACK SOUND CLEARLY (My beam)

You can improve listenability in a noisy environment by changing the beam mode to the my beam, outputs sound beams directly to the listening position in a single channel. In addition, the my beam is also ideal if you do not want the sound beams to be reflected on the walls in your listening room or if you do not disturb others asleep while enjoying music or movies at night.

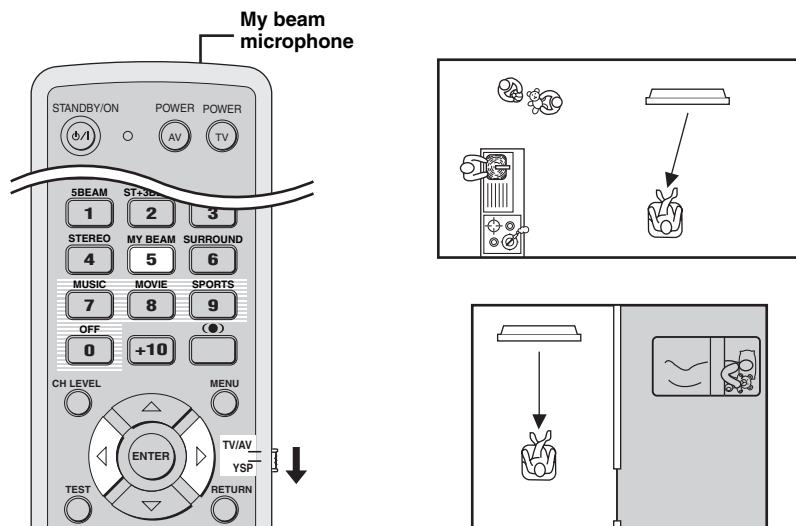

Note

If the my beam is selected as the beam mode, the surround modes (see page 44), the CINEMA DSP programs (see page 50) and the TruBass (see page 57) become ineffective. In addition, no audio is output from the subwoofer connected to this unit.

Using auto-adjust function

The my beam microphone on the remote control collects the test tones from this unit, and then the beam angle is automatically adjusted.

- 1 Set the operation mode selector to YSP to switch to the operation mode of this unit.



- 2 Press and hold MY BEAM on the remote control more than 2 seconds.

A test tone is output twice from this unit. Keep pointing the remote control toward this unit during the test tones are being output so that the my beam microphone can collect the test tones.

Control range: L50° to R50°

Operation guarantee range: 6 m, L30° to R30°



Notes

- If an error occurs, an error buzzer is played and MY BEAM ERROR is displayed on the front panel display.
- An error may occur if the listening room is noisy. Make sure that the listening room is as quiet as possible during the test tones are being output.
- Do not shake or move the remote control during the test tones are being output.
- Do not cover the my beam microphone on the remote control during the test tones are being output.
- The batteries in the remote control may be weak if the remote control does not function properly. In such case, replace all the batteries and then try the procedure again.

Using manual-adjust function

You can adjust the beam angle manually while playing back an input source. This function is also ideal if the listening position is out of the operation guarantee range of the auto-adjust function.

- 1 Set the operation mode selector to YSP to switch to the operation mode of this unit.



- 2 Press MY BEAM on the remote control. MY BEAM is displayed in the front panel display.



- 3 Press ◀ / ▶ while MY BEAM is displayed to adjust the angle.

Control range: L90° to R90°

- Press ◀ repeatedly to increase the horizontal angle on the left side.
- Press ▶ repeatedly to increase the horizontal angle on the right side.

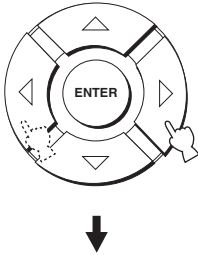

USING SOUND FIELD PROGRAMS

This unit is equipped with a variety of precise digital decoders that allow you to enjoy multi-channel playback from stereo or multi-channel sources. This unit is also equipped with a YAMAHA CINEMA DSP (digital sound field processing) chip containing several sound field programs which you can use to enhance your playback experience. Most of the sound field programs are precise digital recreations of actual acoustic environments found in famous concert halls, music venues and movie theaters.



The YAMAHA CINEMA DSP modes are compatible with all Dolby Digital, DTS and Dolby Surround sources.

Note

Choose a sound field program based on your listening preference and do not purely rely on the name of the sound field program itself.

What is a sound field?

A significant factor that creates the rich, full tones of a live instrument are the multiple reflections from the walls of the room. In addition to making the sound live, these reflections enable the listener to tell where the player is situated as well as the size and shape of the room in which the listening is sitting.

■ Elements of a sound field

In any environment, there are two distinct types of sound reflections that combine with the direct sound coming straight to our ears from the player's instrument to make up the sound field.

Early reflections

Reflected sounds reach our ears extremely rapidly (50 ms to 80 ms after the direct sound) after reflecting from one surface only (from the ceiling or a wall, for example). Early reflections help add clarity to the direct sound.

Reverberations

These are caused by reflections from more than one surface (i.e. wall, ceiling, the back of the room, etc.) so numerous that they merge together to form a continuous sonic afterglow. They are non-directional and lessen the clarity of the direct sound.

Direct sound, early reflections and subsequent reverberation taken together help us to determine the subjective size and shape of the room, and it is this information that the digital sound field processor reproduces in order to create sound fields.

If you could create the appropriate early reflections and subsequent reverberations in your listening room, you would be able to create your own listening environment. The acoustics in your room could be changed to those of a concert hall, a dance floor or a listening room of virtually any size at all. This ability to create sound fields at will is exactly what YAMAHA has done with the CINEMA DSP technology.

Sound field program descriptions

You can select from the following sound field programs based on your listening preference when you play music, movie or sports sources. For details on how to switch between the available sound field programs, see page 52.

Note

There is only one sports sound field program available.

Sound field program	Source	Feature
Music Video	Music	This program produces a vibrant environment and lets you feel as if you are at an actual jazz or rock concert.
Concert Hall		This program creates a rich surround effect of a large round concert hall with a great deal of presence, emphasizing the extension of sounds, and lets you feel as if you are seated close to the center of the stage.
Jazz Club		This program recreates the acoustic environment of “The Bottom Line”, a famous jazz club in New York and lets you feel as if you are seated right in front of the stage.
Sci-Fi	Movie	This program clearly reproduces dialogs and special sound effects of the latest science fiction films and lets you feel a broad and expansive cinematic space amid silence.
Spectacle		This program reproduces the wide and grand environment and lets you have added impressions on spectacular scenes with strong visual impacts.
Adventure		This program reproduces the thrilling environment of the latest action films and lets you feel the dynamic and excitement of fast-moving scenes.
SPORTS	Sports	This program reproduces the energetic environment of live sports broadcasting, converging a commentator’s voice on the center and broadening the overall atmosphere of the stadium, and lets you feel as if you are seated at an actual stadium or a ball park.

Turning on CINEMA DSP programs

You can select from three different sound field programs (MUSIC, MOVIE and SPORTS) depending on the type of sources you want to enjoy.

Notes

- The CINEMA DSP programs are not available if the stereo playback (see page 47) or the my beam (see page 48) is selected as the beam mode.
- If the CINEMA DSP programs are not available, "Prohibit" appears in the front panel display when you press one of the sound field program buttons on the remote control.

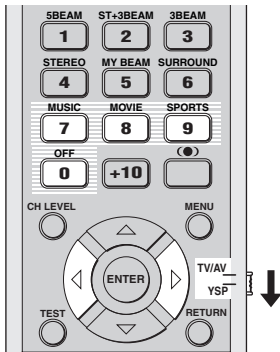

■ Music programs

Select this sound field program when you play music sources. This program produces a vibrant atmosphere and lets you feel as if you are seated in an actual rock or jazz concert hall.

- 1 Set the operation mode selector to YSP to switch to the operation mode of this unit.



- 2 Press MUSIC on the remote control to select the music sound field program.



- 3 Check that MUSIC is displayed in the front panel display and then press MUSIC on the remote control repeatedly (or press \triangle/\square on the remote control) to switch between the music sound field programs.

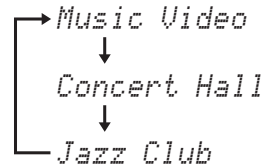
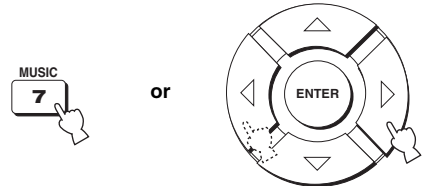

For detailed descriptions of each sound field program, see "Sound field program descriptions" on page 51.

■ Movie programs

Select this sound field program when you play movie sources, especially the ones encoded in Dolby Digital, DTS or Dolby Surround. This program clearly reproduces dialog and sound effects, thus creating a broad and expansive cinematic space amid silence.

- 1 Set the operation mode selector to YSP to switch to the operation mode of this unit.



- 2 Press MOVIE on the remote control to select the movie sound field program.



- 3 Check that MOVIE is displayed in the front panel display and then press MOVIE on the remote control repeatedly (or press ◀/▶ on the remote control) to switch between the music sound field programs.

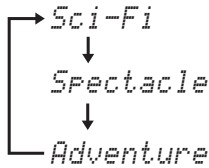
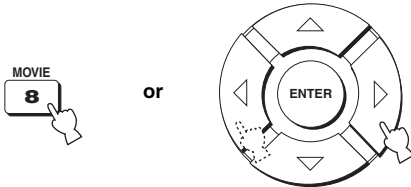

For detailed descriptions of each sound field program, see “Sound field program descriptions” on page 51.

■ Sports program

Select this sound field program when you play sports sources. This program densely concentrates the vocal sound of the commentator in the center while broadening the sound from the audience or the environment all around your listening room.

- 1 Set the operation mode selector to YSP to switch to the operation mode of this unit.



- 2 Press SPORTS on the remote control to select the sports sound field program.

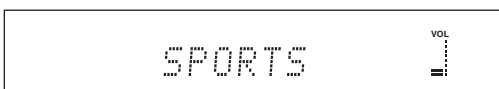

There is only one sports sound field program available.
 For detailed descriptions of each sound field program, see “Sound field program descriptions” on page 51.

Turning off CINEMA DSP programs

Turn off the CINEMA DSP programs if you want to enjoy the original sound without the sound field program effect.

- 1 Set the operation mode selector to YSP to switch to the operation mode of this unit.



- 2 Press OFF on the remote control to turn off the sound field programs.

CINEMA DSP OFF is shown in the front panel display.

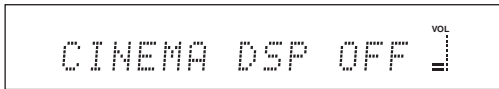

Adjusting CINEMA DSP effect levels

You can enjoy good quality sound with the factory preset parameters. However, you can also adjust the effect level of the CINEMA DSP programs relative to the level of the direct sound so that each sound field program can reflect your listening environment and your preference even more accurately.

- 1 Set the operation mode selector to YSP to switch to the operation mode of this unit.



- 2 Press MUSIC, MOVIE or SPORTS on the remote control to select the desired sound field program.



- 3 Press \triangle / ∇ on the remote control.

DSP LEVEL is shown in the front panel display.



- 4 Press \triangleleft / \triangleright on the remote control to adjust the effect level of the CINEMA DSP programs.

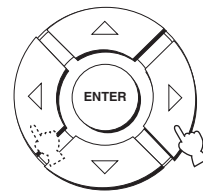

Control range: -6 dB to +3 dB

- A larger value increases the effect level.
- A smaller value decreases the effect level.

USING THE VOLUME MODE (Night listening mode/TV volume equal mode)

The night listening modes are designed to improve listenability at lower volumes or at night. In addition, you can limit the volume level of the TV so that it will not vary suddenly to a great extent whenever the contents being broadcast change (i.e. due to commercials, etc.).

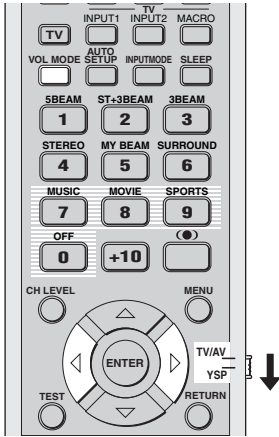

1 Set the operation mode selector to YSP to switch to the operation mode of this unit.



2 Press VOL MODE on the remote control repeatedly to select NIGHT:CINEMA, NIGHT:MUSIC, TV EQUAL VOL or OFF.



The NIGHT indicator lights up in the front panel display when NIGHT:CINEMA or NIGHT:MUSIC is selected.

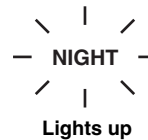

- Select NIGHT:CINEMA when watching films to reduce the dynamic range of film soundtracks and make dialog easier to hear at lower volumes.
- Select NIGHT:MUSIC when listening to music sources to preserve ease-of-listening for all sounds.
- Select TV EQUAL VOL when watching TV programs.
- Select OFF to turn off the volume mode.

- 3 Press ◀/▶ on the remote control to adjust the effect level of compression while NIGHT:CINEMA, NIGHT:MUSIC or TV EQUAL VOL is displayed.

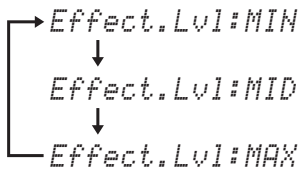
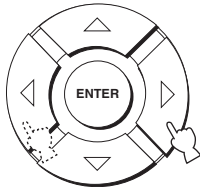

- Select Effect.Lvl:MIN for minimum compression.
- Select Effect.Lvl:MID for standard compression.
- Select Effect.Lvl:MAX for maximum compression.

Note

The volume mode settings are canceled if you press STANDBY/ON on the front panel or on the remote control or if you disconnect the power supply cable from the AC wall outlet.

USING BASS SOUND ENHANCER (TruBass)

This unit can produce the perception of an improved low frequency performance with the aid of the SRS TruBass technology, which improves bass even without a subwoofer and provides deeper, richer bass in the presence of a subwoofer.

Note

The TruBass is not available when the my beam is selected as the beam mode (see page 48).

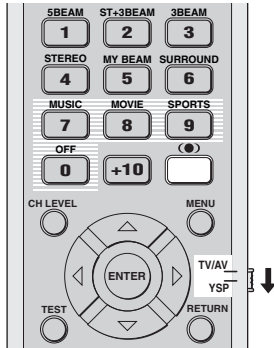

- 1 Set the operation mode selector to YSP to switch to the operation mode of this unit.



- 2 Press **(●)** on the remote control.
The current setting (TruBass MID, TruBass DEEP, or TruBass OFF) is shown in the front panel display.

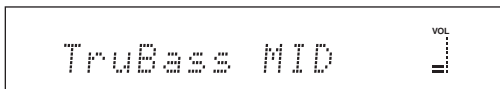

or

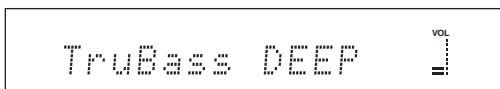

or

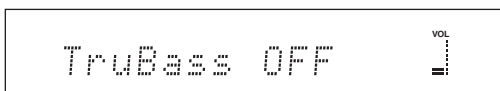

- 3 Press **(●)** on the remote control repeatedly to select TruBass MID or TruBass DEEP.

You can select TruBass MID or TruBass DEEP depending on the type of material you are playing.

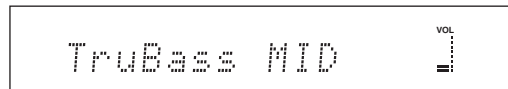

or

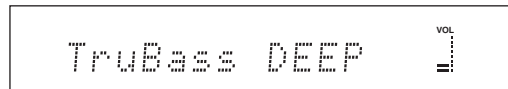

- Select TruBass MID for standard effects.
- Select TruBass DEEP for maximum effects.
- Select TruBass OFF to turn off the TruBass.

USING THE SLEEP TIMER

Use this feature to automatically set this unit to the standby mode after a specified time period. The sleep timer is useful if you are going to sleep after a certain amount of time while this unit is still playing back a source.

Setting the sleep timer

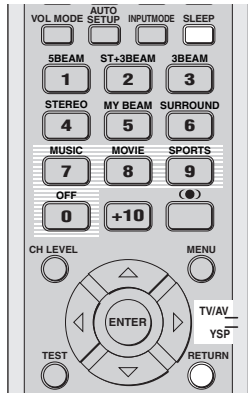

- 1 Set the operation mode selector to YSP to switch to the operation mode of this unit.



- 2 Press SLEEP on the remote control repeatedly to set the amount of time for the sleep timer.

Choices: 120min, 90min, 60min, 30min, OFF
The SLEEP indicator in the front panel display flashes while switching the amount of time for the sleep timer.



Each time you press SLEEP on the remote control, the front panel display changes as shown below.

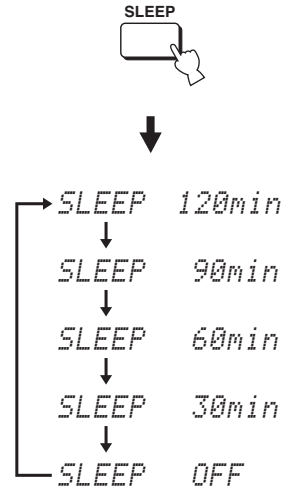

- 3 Wait for a few seconds without operating this unit to confirm the setting for the sleep timer.

The SLEEP indicator lights up in the front panel display, indicating that the sleep timer is activated.



Canceling the sleep timer

- 1 Set the operation mode selector to YSP to switch to the operation mode of this unit.



- 2 Press SLEEP on the remote control repeatedly so that SLEEP OFF appears in the front panel display.



- 3 Wait for a few seconds without operating this unit to confirm the setting for the sleep timer. The SLEEP indicator disappears from the front panel display, indicating that the sleep timer is deactivated.

SLEEP
Disappears

Note

The previous setting for the sleep timer before you deactivate it is stored in the system memory and automatically restored when you make a new setting next time.



The sleep timer setting can also be deactivated if you press STANDBY/ON on the front panel or on the remote control to set this unit to the standby mode or unplug the power supply cable from the AC outlet.

MANUAL SETUP

To achieve the best quality surround sound, you can use MANUAL SETUP to fine-tune the listening environment parameters, as well as to make advanced settings for sound signals, sound beams, digital input and the OSD. Change the initial settings (indicated in bold under each parameter) to reflect the needs of your own listening environment.



- You can save the settings optimized by the AUTO SETUP procedure (see page 36). A set of settings optimized according to specific conditions of your listening environment can be recalled later depending on the varying conditions of your listening environment (see page 37).
- Most of the parameters in SOUND MENU and BEAM MENU are automatically set when you run AUTO SETUP (see page 29). Use SOUND MENU and BEAM MENU to make additional adjustments.
- BEAM MENU allows you to make settings for the surround sound effects normally available in the speaker settings menu.
- Make settings for the parameters in BEAM MENU first before you make settings for the parameters in SOUND MENU, INPUT MENU and DISPLAY MENU.

SOUND MENU

Use to manually adjust various parameters related to the sound output.

Item	Features	Page
TONE CONTROL	Adjusts the output level of high-frequency or low-frequency sound.	66
SUBWOOFER SET	Adjusts the various subwoofer settings.	67
MUTE LEVEL	Adjusts the muting level.	67
AUDIO DELAY	Adjusts audio delay.	67
ROOM EQ	Adjusts the tonal quality of the listening room.	67
DD/DTS Dynamic Range	Adjusts the dynamic range of Dolby Digital or DTS signals.	68

BEAM MENU

Use to manually adjust various parameters related to the sound beam output.

Item	Features	Page
SETTING PARAMETERS	Adjusts listening room and listening position settings.	62
BEAM ADJUSTMENT	Adjusts various beam settings.	63
IMAGE LOCATION	Adjusts the sound position of the front left and right channels.	66

INPUT MENU

Use to manually adjust various parameters related to the audio and video input.

Item	Features	Page
INPUT ASSIGNMENT	Assigns jacks according to the component to be used.	68
INPUT MODE	Selects the initial input of the source.	69
INPUT TRIM	Adjusts the input level of the source.	69
INPUT RENAME	Renames the displayed input source.	70

DISPLAY MENU

Use to manually adjust various parameters related to the display.

Item	Features	Page
DIMMER SET	Adjusts the brightness of the display.	70
OSD SET	Adjusts the display position and the background color of the OSD.	71
UNIT SET	Changes the display unit of measurement.	71

Using MANUAL SETUP

Use the remote control to access and adjust each parameter.

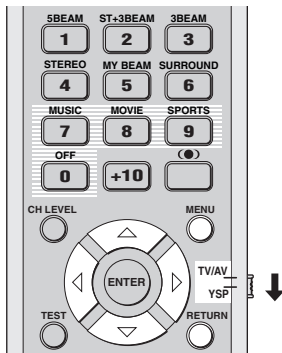

You can adjust the SET MENU parameters while the unit is reproducing sound.

1 Set the operation mode selector to YSP to switch to the operation mode of this unit.



2 Press MENU on the remote control. The SET MENU screen appears on your TV.

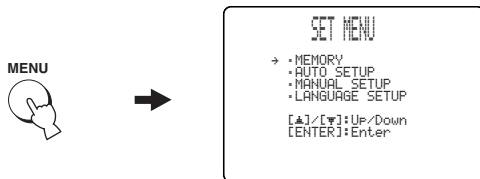

-
- The control buttons used for SET MENU are displayed on the bottom of the screen.
 - To return to the previous screen while using SET MENU, press RETURN on the remote control.
 - To cancel the SET MENU screen, press MENU once more.
 - You can also perform the following operations in the front panel display.

3 Press ▲ / ▼ to select MANUAL SETUP and then press ENTER.

The following screen appears on your TV.

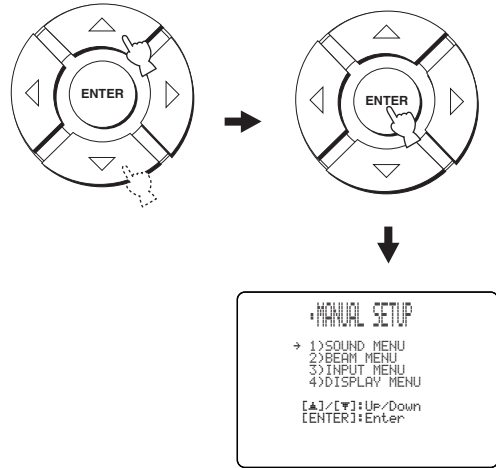

4 Press ▲ / ▼ to select a sub menu and then press ENTER.

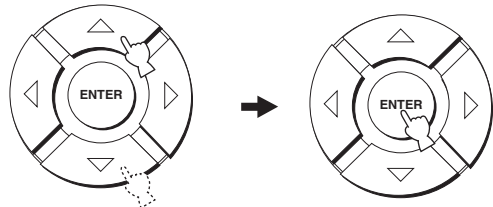

5 Press ▲ / ▼ / ◀ / ▶ and ENTER to configure each parameter.

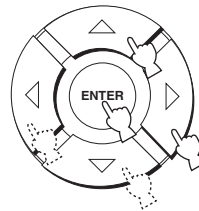

6 Press MENU to exit.

The OSD disappears from your TV screen.



BEAM MENU

Use to manually adjust various parameters related to the sound beam output.

SET MENU → MANUAL SETUP → BEAM MENU



You can adjust the sound beam output level of each channel in “ADJUSTING THE AUDIO BALANCE” (see page 72).

SETTING PARAMETERS (Setting parameters)

Use to set the position of this unit in your listening room and the distance of this unit from the listening position. When you make settings for each parameter, other related parameters are automatically adjusted to best match your listening environment.

Note

If you make adjustments in SETTING PARAMETERS, the beam optimization settings made in the AUTO SETUP procedure will be lost. If you want to keep the beam optimization settings made in the AUTO SETUP and make further adjustments, adjust settings in BEAM ADJUSTMENT first (see page 63).



INSTALLED POSITION

(Installed position of this unit)

Use to adjust the installed position of this unit.

Choices: **FLAT TO WALL** (Parallel to wall installation),
ANGLE TO WALL OR CORNER (Corner installation)

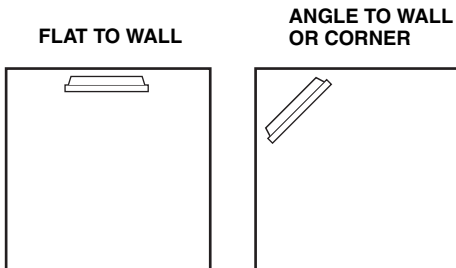

- Select **FLAT TO WALL** if this unit is installed in parallel with the wall in your listening room. Adjust the width and length of your listening room as well as the distance of the listening position from this unit and the distance of the center of this unit from the left wall.

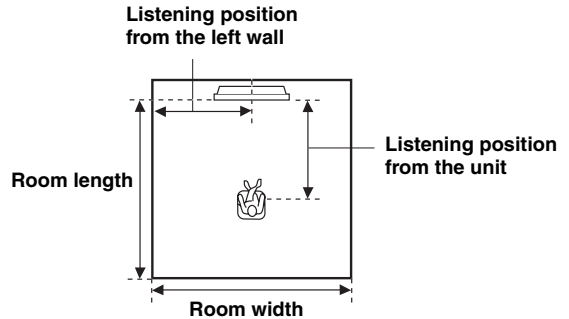

Choices for the room width and length:

2.0 m to 12.0 m

Choices for the listening position from this unit:

1.8 m to 9.0 m

Choices for the listening position from the left wall:

0.6 m to 11.4 m

Room width and length

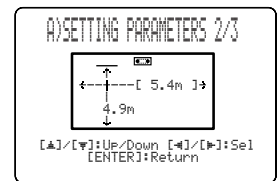

Listening position from the unit and the left wall

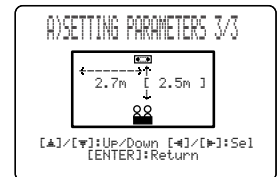

- Select ANGLE TO WALL OR CORNER if this unit is installed in the corner in your listening room. Adjust the width and length of your listening room as well as the distance of the listening position from this unit.

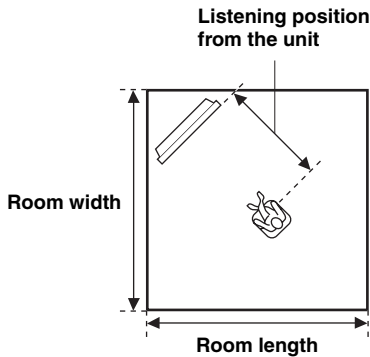

Choices for the room width and length:
2.0 m to 12.0 m

Choices for the listening position from this unit:
1.8 m to 9.0 m

Room width and length

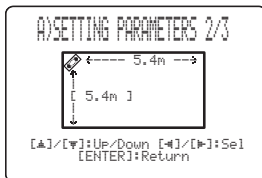

Listening position from the unit

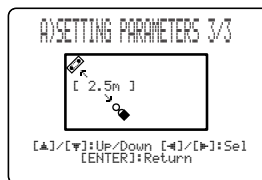

Note

When you set the INSTALLED POSITION parameter in MANUAL SETUP (see page 62), the parameters newly set for the width and length of your listening room are automatically set as the factory default value.

INSTALLED HEIGHT (Installed height of this unit)

Use to adjust the installed height of this unit.

Control range: 0.0 m to 3.0 m

Initial setting: 1.0 m

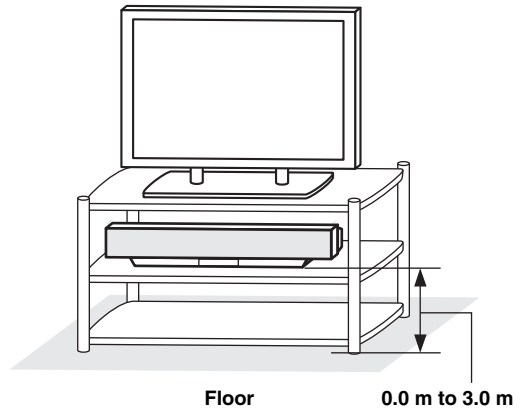

BEAM ADJUSTMENT (Beam adjustment)

Use to manually adjust the various beam settings. We recommend that you select 5 beam as the beam mode before adjusting these parameters.

Notes

- When INSTALLED POSITION is adjusted in MANUAL SETUP (see page 62), the factory default value is automatically set for this parameter except CENTER in FOCAL LENGTH (see page 65).
- Depending on the beam mode settings (see pages 42 and 47), some channel positions may not be available for selection. In this case, “--” is displayed. When using the stereo plus 3 beam as the beam mode, set the surround left and right signals to be output from the front left and right channels.



HORIZONTAL ANGLE (Horizontal angle)

Use to adjust the horizontal angle of beams for each channel. By adjusting the horizontal angle of the beams, you can optimize the sound beam paths. A test tone is automatically output.

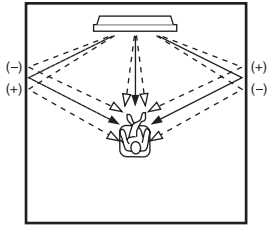

Choices: L90° to R90°

Adjust towards L (left) to move the direction of the output to the left and adjust towards R (right) to move it to the right.

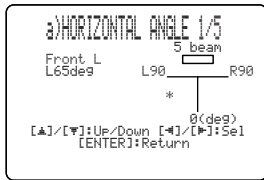

VERTICAL ANGLE (Vertical angle)

Use to adjust the vertical angle of sound beams for each speaker. By altering the beam path, you can optimize sound beam angles.

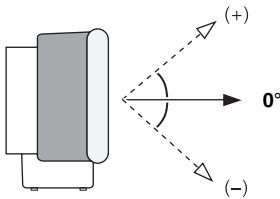

Choices: -45° to +45°

Initial setting: 0°

- Adjust towards - (minus) to move the angle downward.
- Adjust towards + (plus) to move the angle upward.

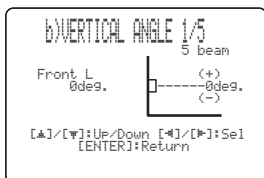

Note

A test tone is automatically output.

BEAM TRAVEL LENGTH (Beam travel length)

A certain amount of delay must be applied to the sound from each channel so that all sound will arrive at the listening position at the same time. This menu sets the distance that sound beams travel after being output and reflected off the wall until they arrive at the listening position and adjust the delay applied to the respective channel.

The lines in the illustration below indicate the distance.

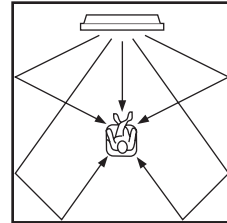

Choices: 0.3 m to 24.0 m

- **Front L** adjusts the distance the front left channel sound beams travel.
- **Front R** adjusts the distance the front right channel sound beams travel.
- **Center** adjusts the distance the center channel sound beams travel.
- **Surround L** adjusts the distance the surround left channel sound beams travel.
- **Surround R** adjusts the distance the surround right channel sound beams travel.



We recommend that you use the setting optimized by the AUTO SETUP (see page 29). Set this menu only when you changed the HORIZONTAL ANGLE (see page 64).

FOCAL LENGTH (Focal length)

Use to set the distance from the front of this unit to the focal point of output for each channel and adjust an expansive feeling of each channel.

The focal points except the center channel should be set near the reflection points on the walls. The shorter the distance, more the expansion.

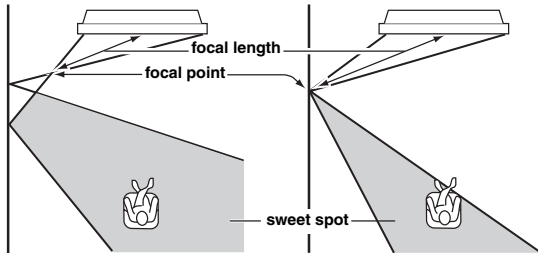

Front left channel

Center channel

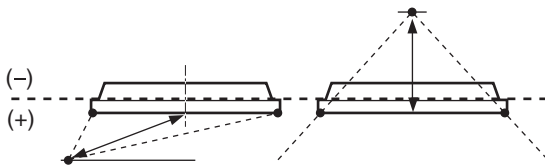

Choices: -1.0 m to +13.0 m

Adjust towards - (minus) to move the focus outward and adjust towards + (plus) to move the focus towards the normal position.

- **Front L** adjusts the focal length for the front left sound beams.
- **Front R** adjusts the focal length for the front right sound beams.
- **Center** adjusts the focal length for the center sound beams. Initial setting: -0.5 m
- **Surround L** adjusts the focal length for the surround left sound beams.
- **Surround R** adjusts the focal length for the surround right sound beams.



We recommend that you use the initial setting (-0.5 m) for the center channel.

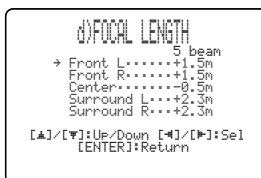

TREBLE GAIN (Treble gain)

Use to adjust the high frequency output level of each channel.



If the reflection point of the front left and right or surround left and right sound beams is a curtain or other acoustically absorbent surface, you can achieve more effective surround sound by increasing the treble level for those sound beams.

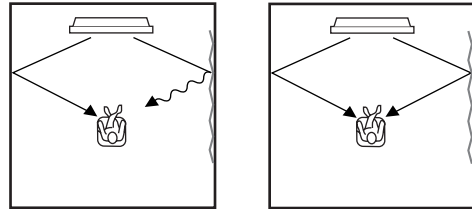

Choices: -12.0 dB to +12.0 dB

Initial setting: 0 dB

- **FL** adjusts the high frequency output level of the front left channel.
- **FR** adjusts the high frequency output level of the front right channel.
- **C** adjusts the high frequency output level of the center channel.
- **SL** adjusts the high frequency output level of the surround left channel.
- **SR** adjusts the high frequency output level of the surround right channel.

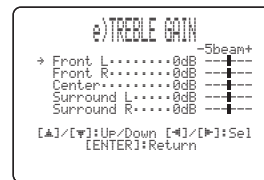

■ IMAGE LOCATION (Image location)

Use to adjust the direction from which the front left and right channel sound is heard so that the each sound can be heard closer to the center channel.

Use this feature to redirect audio signals if the sound coming from the front left and right seems unnatural, such as when your listening position is not the center of your listening room.

You can only adjust this parameter when 3 beam or 5 beam is selected as the beam mode (see page 42).

Choices: ON, OFF

Setting range: 0% to 95%

Initial setting: 0%

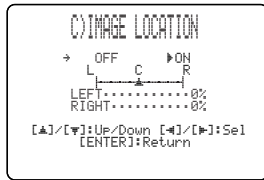

LEFT (Left)

Adjusts audio signals towards the left.

The higher the percentage, the louder the output from the center.

Without adjustment

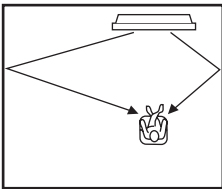

With the front left channel adjusted

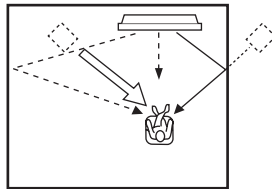

RIGHT (Right)

Adjusts audio signals towards the right.

The higher the percentage, the louder the output from the center.

Without adjustment

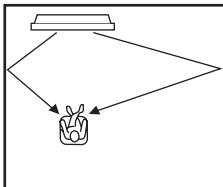

With the front right channel adjusted

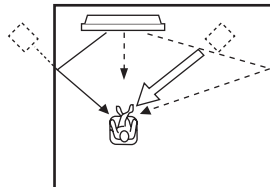

SOUND MENU

Use to manually adjust various parameters related to the sound output.

SET MENU → MANUAL SETUP → SOUND MENU

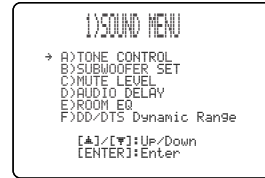

■ TONE CONTROL (Tone control)

You can adjust the tonal quality of the sound beams.



TREBLE (Treble)

Use to adjust the high frequency response.

Choices: -12 dB to +12 dB

Initial setting: 0 dB

BASS (Bass)

Use to adjust the low frequency response.

Choices: -12 dB to +12 dB

Initial setting: 0 dB

■ SUBWOOFER SET (Subwoofer set)

Use to manually adjust various subwoofer settings.

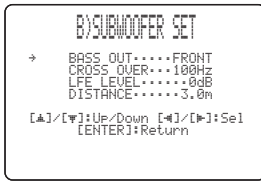

BASS OUT (Bass out)

Low-frequency (bass) signals can be directed to the subwoofer and/or the front left and right channels. This setting also determines the routing of LFE (low-frequency effect) signals found in Dolby Digital or DTS sources.

Choices: SWFR (subwoofer), **FRONT**

- Select SWFR if you connect a subwoofer. LFE and low-frequency signals from other channels are directed to the subwoofer.
- Select FRONT if you do not use a subwoofer. LFE and low-frequency signals from other channels are directed to the front left and right channels.

CROSS OVER (Cross over)

When BASS OUT is set to SWFR, you can use this feature to select a cross-over (cut-off) frequency for all low-frequency signals. All frequencies below the selected frequency will be sent to the subwoofer speaker position.

Choices: 80Hz, **100Hz**, 120Hz

LFE LEVEL (Low-frequency effect level)

Select to adjust the output level of the LFE (low-frequency effect) channel according to the capacity of your subwoofer. The LFE channel carries low-frequency special effects which are only added to certain scenes.

This setting is effective only when this unit decodes Dolby Digital or DTS signals.

Choices: -20 to **0** dB

DISTANCE (Distance)

Select to adjust the distance of the subwoofer from the listening position.

Choices: 0.3 to 15.0 m

Initial setting: 3.0 m

■ MUTE LEVEL (Muting level)

Use to adjust how much the mute function reduces the volume level.

Choices: **MUTE**, -20 dB

- Select MUTE to completely halt all sound output.
- Select -20 dB to reduce the current volume level by 20 dB.



■ AUDIO DELAY (Audio delay)

Use to delay the sound output and synchronize it with the video image. This may be necessary when using certain LCD monitors or projectors.

Choices: **0** to 160 msec



■ ROOM EQ (Room equalizer)

Use to change the tonal qualities of your listening room when the unit is mounted on the wall.

Choices: MOUNTING (Mount type),
REFLECTING (Reflectivity type)

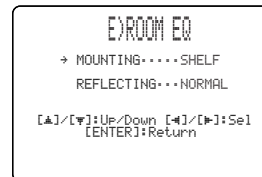

MOUNTING (Mount type)

Use to enhance medium to low range sounds.

Choices: WALL (Wall mount), **SHELF** (Shelf mount)

- Select WALL if this unit is mounted on the wall in your listening room.
- Select SHELF if this unit is mounted on the shelf in your listening room.

REFLECTING (Reflectivity type)

Use to select the reflectivity of your listening room.

Choices: **NORMAL** (Normal), HI ECHO (High echo)

- Select NORMAL if your listening room has a normal reflectivity.
- Select HI ECHO if your listening room has highly reflective surfaces such as concrete walls.

■ DD/DTS Dynamic Range (Dynamic range of Dolby Digital and DTS signals)

Use to select the amount of dynamic range compression. This setting is effective only when the unit is decoding Dolby Digital and DTS signals. Dynamic range is the difference between the smallest sound that can be heard above the noise of the equipment and the biggest sound that can be heard without distortion.

Choices: MIN (minimum), STD (standard), **MAX** (maximum)



Select to adjust the dynamic range compression.

- Select MIN for listening to sources at low volume levels.
- Select STD for general use.
- Select MAX for feature films.

INPUT MENU

Use to manually adjust various parameters related to the audio and video input.

SET MENU → MANUAL SETUP → INPUT MENU



■ INPUT ASSIGNMENT (Input assignment)

Use to assign the input jacks of this unit to other components if the initial settings of this unit do not correspond to your needs. By assigning other components to the input jacks on this unit, you can display the name of the connected component in the front panel display and OSD, and operate the component with the input selector button of the same name. If you connect a component to the input jacks of this unit and do not assign it, the default component name for that input jack is displayed in the front panel and OSD when selected.

- Select OPTICAL IN (1) to assign components to the TV OPTICAL IN jack of this unit.
Choices: **TV**, VCR
- Select OPTICAL IN (2) to assign components to the AUX OPTICAL DIGITAL IN jack of this unit.
Choices: **AUX**, DVD

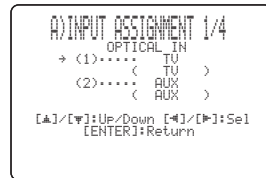

- Select COAXIAL IN (3) to assign components to the COAXIAL DIGITAL IN jack of this unit.
Choices: **DVD**, AUX



- Select COMPONENT (1) to assign components to the STB COMPONENT VIDEO IN jacks of this unit.
Choices: **TV, VCR**
- Select COMPONENT (2) to assign components to the DVD/AUX COMPONENT VIDEO IN jacks of this unit.
Choices: **DVD, AUX**

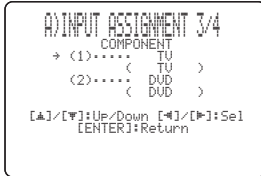

- Select COMPOSITE (3) to assign components to the DVD/AUX VIDEO IN jack of this unit.
Choices: **AUX, DVD**



■ INPUT MODE (Input mode)

Use to designate the input mode for the input sources connected to the DIGITAL INPUT jacks when you turn on the power of this unit. For information on the types of audio signals that can be output by this unit, see “Surround modes and recommended sources” on page 44.
Choices: **AUTO, LAST**



- Select AUTO to allow this unit to automatically detect the type of input signal and select the appropriate input mode.
- Select LAST to set this unit to automatically select the last input mode used for that input source. If the type of input signal is different from the setting, no sounds will be produced.

■ INPUT TRIM (Input trim)

Use to adjust the input level of the input source.

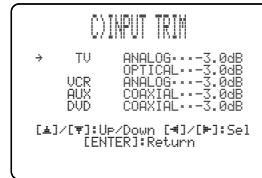

- Select TV ANALOG to adjust the level of audio and video signals input at the TV/STB analog audio input jacks of this unit.
Control range: -6.0 dB to 0.0 dB
Initial setting: -3.0 dB
- Select TV OPTICAL to adjust the level of audio and video signals input at the TV OPTICAL IN jack of this unit.
Control range: -6.0 dB to 0.0 dB
Initial setting: -3.0 dB
- Select VCR ANALOG to adjust the level of audio and video signals input at the VCR analog audio input jacks of this unit.
Control range: -6.0 dB to 0.0 dB
Initial setting: -3.0 dB
- Select AUX OPTICAL to adjust the level of audio and video signals input at the AUX OPTICAL IN jack of this unit.
Control range: -6.0 dB to 0.0 dB
Initial setting: -3.0 dB
- Select DVD COAXIAL to adjust the level of audio and video signals input at the COAXIAL IN jack of this unit.
Control range: -6.0 dB to 0.0 dB
Initial setting: -3.0 dB

■ INPUT RENAME (Input rename)

Use to change the name of the input source in the OSD and the front panel display. Press an input selector button (TV, STB, DVD, VCR, or AUX) to select the component you want to change the name for and then perform the following procedure.



- 1 Press **← / →** to place the **_ (underbar)** under the space or the character you want to edit. The **_ (underbar)** flashes.

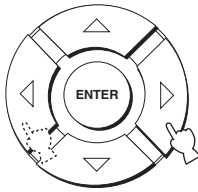

- 2 Press **▲ / ▼** to select the desired character.
 - You can use up to 8 characters for each input.
 - Press **▲** to change the character in the following order or press **▼** to go in the reverse order: A to Z, a space, 0 to 9, a space, a to z, a space, #, *, +, etc.

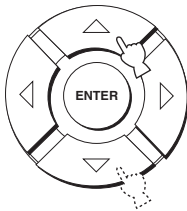

- 3 Repeat steps 1 to 3 to rename each input.

- 4 Press **ENTER** to exit.

The new names are registered, and the display returns to the previous screen.

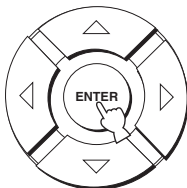

DISPLAY MENU

Use to manually adjust various parameters related to the display.
SET MENU → MANUAL SETUP → DISPLAY MENU



■ DIMMER SET (Dimmer settings)

Use to adjust the brightness of the front panel display.

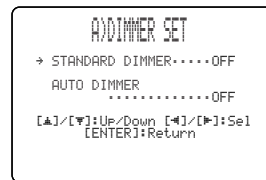

STANDARD DIMMER (Standard dimmer)

Use to adjust the brightness of the front panel display when you operate this unit by using the control buttons on the front panel or on the remote control.

Choices: -2, -1, **OFF**

AUTO DIMMER (Auto dimmer)

If no operation is performed for a specified period, the front panel display dims. Use to adjust the brightness of the front panel display in this case.

Choices: **OFF** (the same brightness as the STANDARD DIMMER setting), -1 to -3 (based on the STANDARD DIMMER setting), DISPLAY OFF

■ OSD SET (OSD settings)

Use to adjust the display position and the background color of the OSD.



OSD SHIFT (OSD shift)

Use to adjust the vertical position of the OSD. Adjust towards the – (minus) direction to raise the position of the OSD, and adjust towards the + (plus) direction to lower it.

Choices: –5 to +5

Initial setting: 0

OSD BACK COLOR (OSD background color)

Use to select the background color of the OSD.

Choices: **BLUE**, GRAY

■ UNIT SET (Unit settings)

Use this to change the display unit of measurement.

Choices: **METERS** (Australia and U.K. models),
FEET (U.S.A. model)



- Select METERS to input distances in meters.
- Select FEET to input distances in feet.

Note

If you change this setting, the adjusted beam settings may change.

ADJUSTING THE AUDIO BALANCE

You can adjust the sound beam output level of each channel by using the test tone or the audio output being played back in each beam mode to achieve a more true-to-life surround sound experience.

Using the test tone

You can use the test tone feature to output a test tone from each channel to manually balance the channel levels.

Use the test tone to set channel levels so that the volume level of each channel is identical when heard from your listening position.

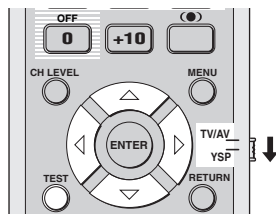

- 1 Set the operation mode selector to YSP to switch to the operation mode of this unit.



- 2 Press TEST on the remote control.

TEST FRONT L appears in the front panel display and a test tone is output from the front left channel.



- 3 Press \triangle / ∇ to select the channel you want to adjust.

The front panel display changes as follows.

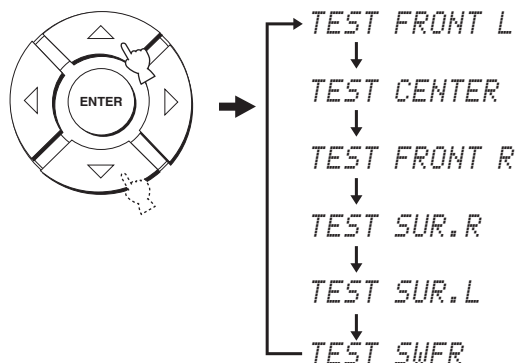

Note

TEST SWFR is only available when a subwoofer is connected to this unit and SWFR is selected for BASS OUT in SOUND MENU (see page 67).

- 4 Press \triangleleft / \triangleright to adjust channel volumes.

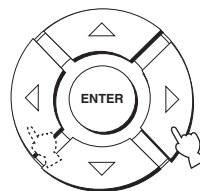

Control range: -10 dB to +10 dB

5 Press TEST when you have completed all your adjustments.



Notes

- All the channel levels cannot be adjusted when the stereo playback or my beam is selected as the beam mode (see pages 47 and 48).
- FRONT L/R cannot be adjusted when the stereo plus 3 beam is selected as the beam mode (see page 43).
- FRONT L/R are automatically adjusted depending on the settings of the other channels when the stereo plus 3 beam or stereo playback is selected as the beam mode (see pages 43 and 47).



If the level of a particular channel cannot be adjusted, --dB appears in the front panel display.

Using the audio output being player back

You can also manually adjust the channel levels while playing back an input source such as a DVD.

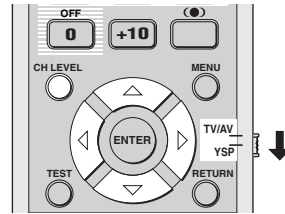

1 Set the operation mode selector to YSP to switch to the operation mode of this unit.



2 Press CH LEVEL repeatedly (or press CH LEVEL and then \triangle / ∇) to select the channel you want to adjust.

The front panel display changes as follows.

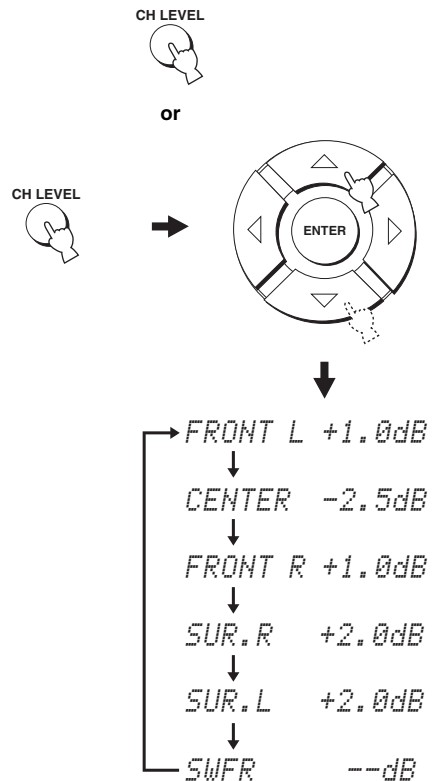

Note

SWFR is only available when a subwoofer is connected to this unit and SWFR is selected for BASS OUT in SOUND MENU (see page 66).

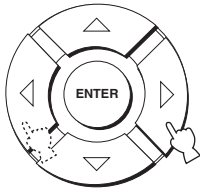
3 Press ◀ / ▶ to adjust channel volumes.

Control range: -10 dB to +10 dB

4 Wait for a few seconds without operating this unit when you have completed your adjustment.
Notes

- All the channel levels cannot be adjusted when the stereo playback is selected as the beam mode (see page 47).
- FRONT L/R cannot be adjusted when the stereo plus 3 is selected as the beam mode (see page 41).
- Only CENTER can be adjusted when the my beam is selected as the beam mode (see page 48).
- FRONT L/R are automatically adjusted depending on the settings of the other channels when the stereo plus 3 beam or stereo playback is selected as the beam mode (see pages 43 and 47).



If the level of a particular channel cannot be adjusted, --dB appears in the front panel display.

SELECTING THE INPUT MODE

You can select the type of audio input signals of the selected input source according to your preference or the conditions of the input source.



We recommend setting the input mode to AUTO in most cases.

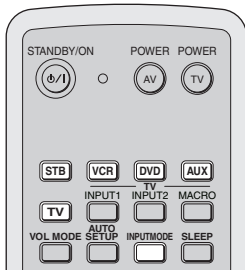

1 Set the operation mode selector to YSP to switch to the operation mode of this unit.



2 Press one of the input selector buttons on the remote control to select the desired input source.

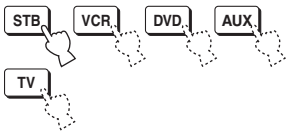

3 Press INPUTMODE on the remote control repeatedly to toggle between input modes.

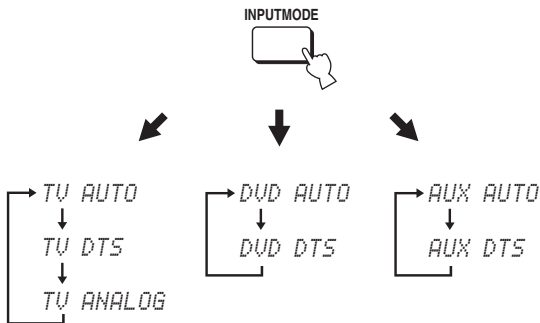

When TV or STB is selected as the input source

When DVD is selected as the input source

When AUX is selected as the input source

Notes

- The input mode of VCR is fixed to ANALOG. However, if the TV OPTICAL IN jack of this unit is assigned to VCR, AUTO, DTS and ANALOG become available as the input mode of VCR (see page 68).
- ANALOG is not available as the input mode of DVD and AUX.

AUTO

Automatically selects audio input signals in the following priority order:

- 1) Dolby Digital or DTS
- 2) PCM
- 3) Analog

Use this input mode in most cases.

DTS

Selects only digital signals encoded in DTS.

Compared to AUTO, this input mode provides greater stability while playing back CDs or LDs encoded in DTS.

ANALOG

Selects only analog signals.

Even when both digital and analog signals are input simultaneously, only analog signals are selected.



You can adjust the default input mode to be selected when the power of this unit is turned on (see page 69).

ADJUSTING SYSTEM PARAMETERS

This unit has additional menus that are displayed in the front panel display. These menus offer additional operations to adjust and customize the way this unit operates.

Using the system parameters

Follow the procedure below to enter the system parameters.

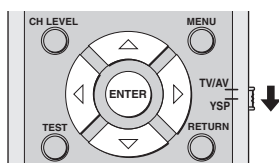
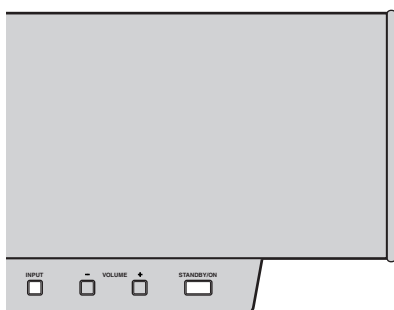

- 1 Press **STANDBY/ON** on the front panel to turn off the power of this unit.



- 2 Press and hold **INPUT** on the front panel and then press **STANDBY/ON** on the front panel to turn on the power of this unit.

MEMORY PROTECT is shown in the front panel display.



- 3 Release **INPUT** on the front panel.

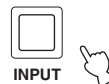

Setting the MEMORY PROTECT

You can protect the settings you saved in the system memory of this unit from being accidentally erased or unwantedly changed.

- 1 Repeat steps 1 to 3 in “Using the system parameters” on this page.
- 2 Set the operation mode selector to **YSP** to switch to the operation mode of this unit.
- 3 Confirm that **MEMORY PROTECT** is shown in the front panel display and then press **ENTER**.

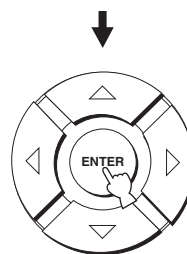

- 4 Press \triangle / ∇ to switch between PROTECT: ON and PROTECT: OFF.

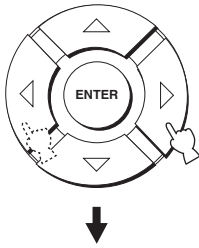

- Select PROTECT: ON to activate the protection feature.
- Select PROTECT: OFF to deactivate the protection feature.

- 5 Press **STANDBY/ON** on the front panel to set this unit to the standby mode.



The new setting will be activated when you turn on the power of this unit next time.

Setting the MAX VOLUME

You can set the maximum volume level so that this unit will not output sound beyond the limited volume level.

- 1 Repeat steps 1 to 3 in “Using the system parameters” on page 76.
- 2 Set the operation mode selector to YSP to switch to the operation mode of this unit.



- 3 Press \triangle / ∇ on the remote control so that MAX VOLUME SET is shown in the front panel display.

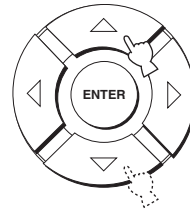

- 4 Press **ENTER**.

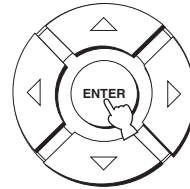

- 5 Press \triangle / ∇ to adjust the maximum volume level.

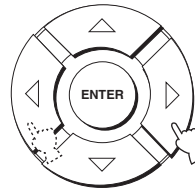

Control range: MAX, 99 to 01, MIN
Control step: 1

- 6 Press **STANDBY/ON** on the front panel to set this unit to the standby mode.



The new setting for the maximum volume level will be activated when you turn on the power of this unit next time.

Setting the **TURN ON VOLUME**

You can set the initial volume level when the power of this unit is turned on.

- Repeat steps 1 to 3 in “Using the system parameters” on page 76.
- Set the operation mode selector to YSP to switch to the operation mode of this unit.



- Press \triangle / ∇ on the remote control so that **TURN ON VOLUME** is shown in the front panel display.

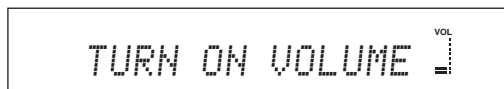
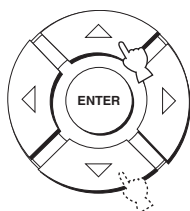

- Press ENTER.

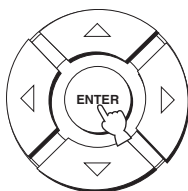

- Press \triangleleft / \triangleright to adjust the initial volume level.

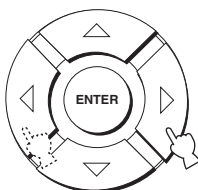

Control range: MAX, 99 to 01, OFF
Control step: 1

- Press **STANDBY/ON** on the front panel to set this unit to the standby mode.



The new setting for the maximum volume level will be activated when you turn on the power of this unit next time.

Setting the **DEMO MODE**

You can test the beam output from this unit to experience the sound beam.



You can also perform this function simply by pressing INPUT on the front panel. A sound beam is output from this unit when you press and hold INPUT for more than 2 seconds. The sound beam shuttles between left and right twice, and then stops.

- Repeat steps 1 to 3 in “Using the system parameters” on page 76.
- Set the operation mode selector to YSP to switch to the operation mode of this unit.



- Press \triangle / ∇ on the remote control so that **DEMO MODE** is shown in the front panel display.

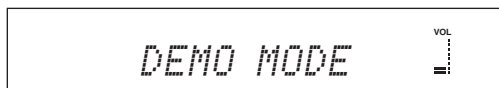
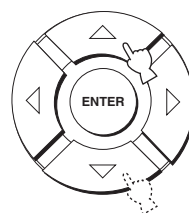

- 4 Press ◀ / ▶ to switch between DEMO: ON and DEMO: OFF.

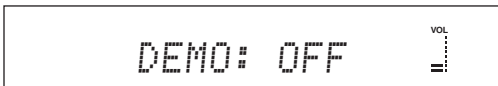
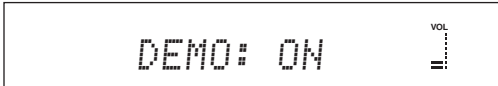
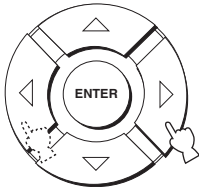

- Select DEMO: ON to activate the demo mode.
- Select DEMO: OFF to deactivate the demo mode.

- 5 Press STANDBY/ON on the front panel to set this unit to the standby mode.



The new setting will be activated when you turn on the power of this unit next time.
Press ENTER to test the sound beam.
The sound beam being output shuttles between left and right. Press ENTER again to stop shuttling.

Setting the FACTORY PRESET

You can reset all of the parameters of this unit to the factory presets. This procedure completely resets ALL the parameters in SET MENU.

Note

After performing the following procedure you must run the AUTO SETUP again to match your surround sound environment.

- 1 Repeat steps 1 to 3 in “Using the system parameters” on page 76.
- 2 Set the operation mode selector to YSP to switch to the operation mode of this unit.



- 3 Press ▲ / ▼ on the remote control so that FACTORY PRESET is shown in the front panel display.

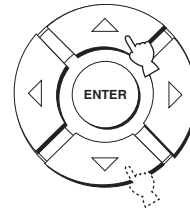

- 4 Press ENTER.

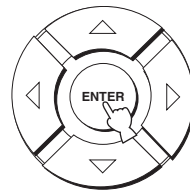

- 5** Press ◀ / ▶ to switch between PRESET: RESET and PRESET: CANCEL.

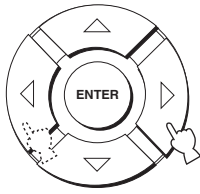

- Select PRESET: RESET to reset all of the current settings.
- Select PRESET: CANCEL to cancel the resetting procedure.

- 6** Press STANDBY/ON on the front panel to set this unit to the standby mode.



The new setting will be activated when you turn on the power of this unit next time.

REMOTE CONTROL FEATURES

In addition to controlling this unit, the remote control can also operate other A/V components made by YAMAHA and other manufacturers. To control other components, you must set up the remote control with the appropriate remote control codes and set the operation mode selector to TV/AV to change the control area.

Note

Depending on the external A/V component you are using, you may not be able to operate the component with the remote control, even if a remote control code is set. In this case, operate the component using the supplied remote control.

Setting remote control codes

You can control other components by setting the appropriate remote control codes. Codes can be set up for each input area (TV, STB, DVD, VCR and AUX). For a complete list of available remote control codes, refer to "LIST OF REMOTE CONTROL CODES" at the end of this manual.

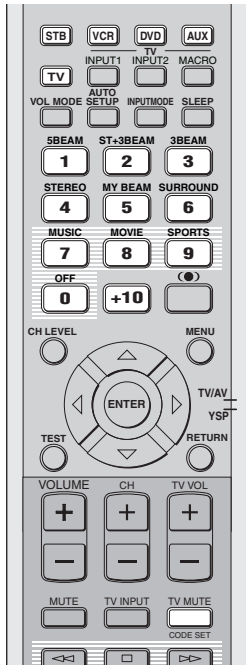

- 1 Press and hold CODE SET on the remote control and then press one of the input selector buttons to select the input source you want to set a remote control code for.** The transmission indicator flashes twice and then remains lit. Proceed to step 2 while holding down CODE SET.

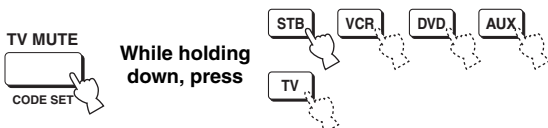

- 2 Press the numeric buttons to enter the remote control code while holding down CODE SET.**

Setting example: YAMAHA DVD input area

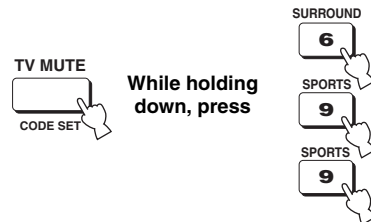

- 3 Refer to "Controlling other components" on page 82 to operate the external component using the remote control.**

If the external component functions correctly, the remote control code setup was successful. If the external component does not function correctly, the remote control code may be incorrect. Confirm that the remote control code is correct (see "LIST OF REMOTE CONTROL CODES" at the end of this manual) and start over from step 1.

Note

If the manufacturer of your component has more than one code, try each of them until you find the correct one.

If the remote control is without batteries for more than 2 minutes, or if exhausted batteries remain in the remote control, the contents of the memory may be cleared. When the memory is cleared, insert new batteries and reset the remote control codes. When changing the batteries, be careful not to press any of the buttons on the remote control. Doing so will clear the contents of the memory.

Controlling other components

■ Operating your TV

Set the operation mode selector to TV/AV and then press TV to select TV as the input source.

The control area of the remote control changes to the TV operation mode.

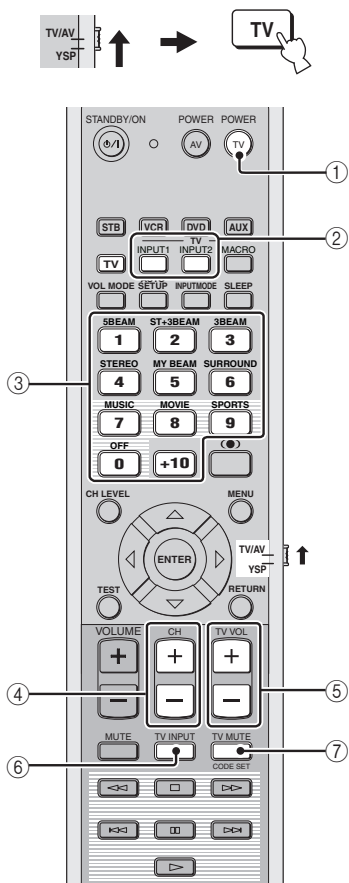

- ① **TV POWER**
Turns on or off the power of your TV.
- ② **TV INPUT1/2**
Selects the input source of the TV.
- ③ **Numeric buttons**
Selects a TV channel for playback.
- ④ **CH +/-**
Switches between the available TV channels.
- ⑤ **TV VOL +/-**
Adjusts the audio output level of the TV.
- ⑥ **TV MUTE**
Temporarily mutes audio output from the TV.
- ⑦ **TV INPUT**
Switches the input source for the TV.

■ Operating your DVD player

Set the operation mode selector to TV/AV and then press DVD to select DVD as the input source.

The control area of the remote control changes to the DVD operation mode.

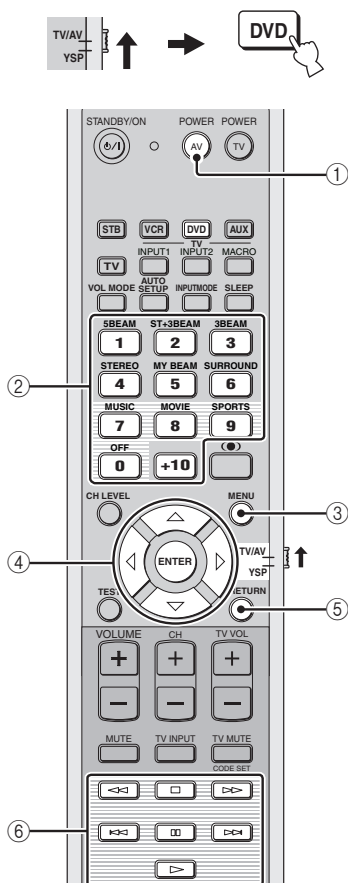

- ① **AV POWER**
Turns on or off the power of your DVD player.
- ② **Numeric buttons**
Use to enter numeric digits.
- ③ **MENU**
Displays the DVD menu.
- ④ **Cursor buttons** $\triangle / \nabla / \triangleleft / \triangleright$, **ENTER**
Use to select DVD menu items.
- ⑤ **RETURN**
Use to return to the previous DVD menu screen or exit the DVD menu.
- ⑥ **Operation buttons for DVD and VCR players**
Use to perform DVD player operations, such as play and stop.

■ Operating your VCR

Set the operation mode selector to TV/AV and then press VCR to select VCR as the input source.

The control area of the remote control changes to the VCR operation mode.

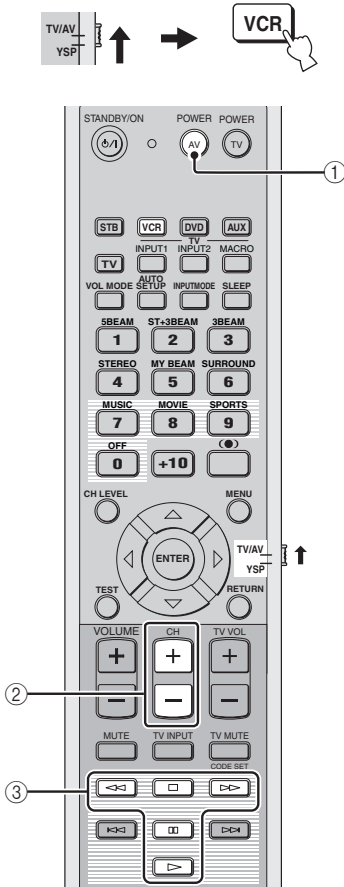

① **AV POWER**

Turns on or off the power of your VCR.

② **CH +/-**

Switches between the available VCR channels.

③ **Operation buttons for DVD and VCR**

Use to perform VCR operations, such as play and stop.

■ Operating your STB (CATV/Satellite tuner)

Set the operation mode selector to TV/AV and then press STB to select STB as the input source.

The control area of the remote control changes to the STB operation mode.

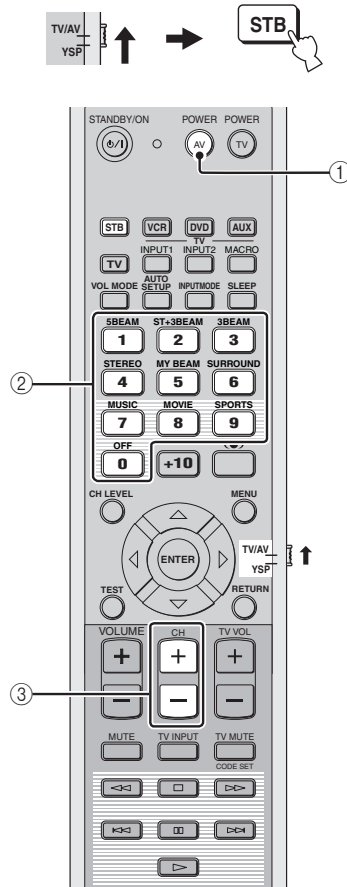

① **AV POWER**

Turns on or off the power of your STB.

② **Numeric buttons**

Use to enter the numeric digits.

③ **CH +/-**

Switches between the available STB channels.

Using the TV macro

The TV macro feature makes it possible to perform a series of operations with the press of a single button. For example, when you want to play a DVD, you would normally turn on the component, select DVD as the input source and press the play button to start playback. The TV macro feature lets you perform all of these operations simply by pressing the DVD macro button.

Notes

- Be sure to set up a remote control code for your TV before setting macros.
- The ways to set macros differ if your TV does not have the tuning capability.
- If you press any control buttons on the remote control other than the ones used to set macros while setting macros, the setting procedure is automatically canceled.
- If it takes more than 10 seconds in steps 2 and 3, the setting procedure is automatically canceled. In this case, repeat from step 1.

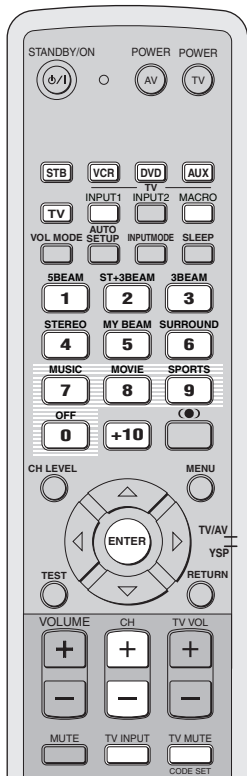

Setting macros for the TV with the tuning capability

- 1 Press and hold CODE SET on the remote control and then press one of the input selector buttons to select the input source you want to set macros for.**

Proceed to step 2 while holding down CODE SET.

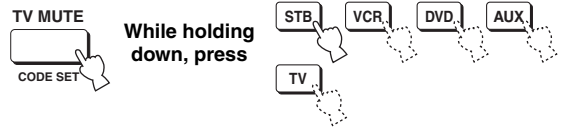

- 2 Press MACRO on the remote control while holding down CODE SET.**

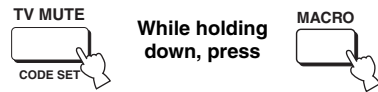

- 3 Press CH +/- or the numeric buttons to select the TV channel.**

Check that the TV screen changes to the tuner screen.

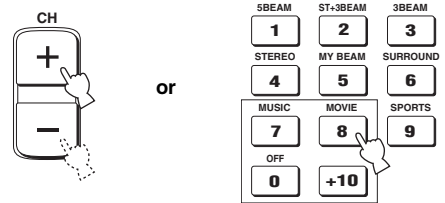

- 4 Press TV INPUT on the remote control repeatedly so that the screen changes to the display of the input source selected in step 1.**



- 5 Press ENTER on the remote control to confirm the macro setting.**

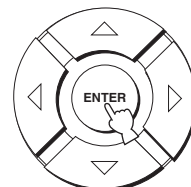

■ Setting macros for the TV without the tuning capability

- 1 Press and hold **CODE SET** on the remote control and then press one of the input selector buttons to select the input source you want to set macros for.

Proceed to step 2 while holding down **CODE SET**.

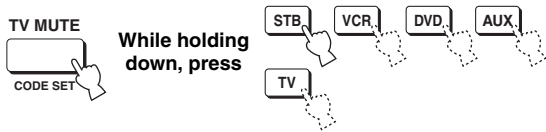

- 2 Press **MACRO** on the remote control while holding down **CODE SET**.

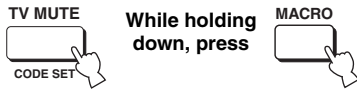

- 3 Press **INPUT1** on the remote control.



- 4 Press **CH +/-** or **TV INPUT** on the remote control repeatedly so that the screen changes to the display of the input source selected in step 1.

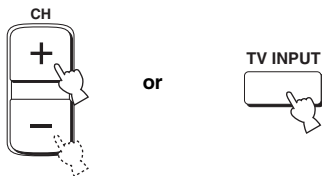

- 5 Press **ENTER** on the remote control to confirm the setting.

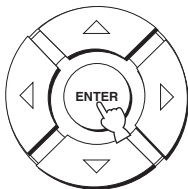

■ Operating macros

- 1 Set the operation mode selector to **YSP** to switch to the operation mode of this unit.



- 2 Press and hold one of the input selector buttons for approximately 2 seconds to select the input source you want to operate macros for.

The TV input changes at the same time the input mode changes.

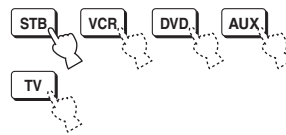

■ Canceling the macros

- 1 Press and hold **CODE SET** on the remote control and then press one of the input selector buttons to select the input source you want to cancel the macros for.

Proceed to step 2 while holding down **CODE SET**.

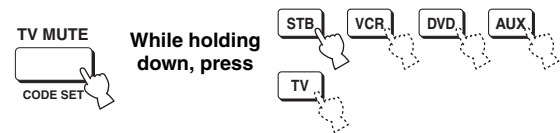

- 2 Press **MACRO** on the remote control while holding down **CODE SET**.

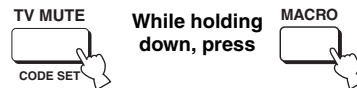

- 3 Press **ENTER** on the remote control to cancel the macros.

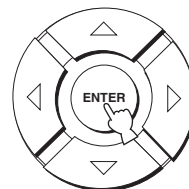

TROUBLESHOOTING

Refer to the chart below when this unit does not function properly. If the problem you are experiencing is not listed below or if the instruction below does not help, set this unit to the standby mode, disconnect the power supply cable and contact the nearest authorized YAMAHA dealer or service center.

■ General

Problem	Cause	Remedy	See page
This unit fails to turn on when STANDBY/ON is pressed, or enters the standby mode soon after the power has been turned on.	The power supply cable is not firmly connected to the AC wall outlet or to the AC inlet on the rear panel of this unit.	Connect the power supply cable firmly to the AC wall outlet or to the AC inlet on the rear panel of this unit.	23
	This unit has been exposed to a strong external electric shock (such as lightning and strong static electricity).	Set this unit to the standby mode, disconnect the power supply cable, plug it back in after 30 seconds, then use it normally.	—
This unit suddenly enters the standby mode.	The internal temperature becomes too high and the overheat protection circuitry has been activated.	Wait about 1 hour for this unit to cool down and then turn it back on.	—
	The sleep timer has turned the unit off.	Turn on the power, and play the source again.	—
No sound.	Incorrect input or output cable connections.	Connect the cables properly. If the problem persists, the cables may be defective.	15
	No appropriate input source has been selected.	Select an appropriate input source with INPUT or the input selector buttons.	39
	The volume is turned down.	Turn up the volume.	41
	The sound is muted.	Press MUTE or VOLUME +/- on the remote control to resume audio output and then adjust the volume level.	41
	Signals this unit cannot reproduce (such as PCM signals with more than 96 kHz of sampling frequency) are being received from a source component.	Play a source whose signals can be reproduced by this unit.	—
		Change the system settings of the source component.	—
The sound suddenly goes off.	The sleep timer has turned the unit off.	Turn on the power, and play the source again.	—
	The sound is muted.	Press MUTE or VOLUME +/- on the remote control to resume audio output and then adjust the volume level.	41
No sound from the effect channels.	You are playing back the source or program in the stereo mode or my beam mode.	Press one of the beam mode buttons on the remote control to select a multi-channel playback mode and then try to play back the source or program once more.	42
No sound from the center channel.	The output level of the center channel is set to minimum.	Raise the level of the center channel.	72
No sound from the surround channels.	The output level of the surround channels is set to minimum.	Raise the output level of the surround channels.	72
No sound from the subwoofer.	BASS OUT in SUBWOOFER SET is set to FRONT.	Select SWFR.	67
	The source does not contain low bass signals.		

Problem	Cause	Remedy	See page
Distorted or too little bass sound.	CROSS OVER in SUBWOOFER SET is set incorrectly.	Set CROSS OVER correctly.	67
	One of the night listening modes is currently selected.	Turn off the night listening modes.	55
Too much bass sound.	TruBass is currently turned on.	Turn off TruBass.	57
	The volume level of the subwoofer is too high.	Turn down the volume level of the subwoofer.	—
Surround sound effects are insubstantial.	The listening room is not a regular shape.	Install this unit in a square or rectangular shaped room.	—
	There is no wall in the path of the sound beam.	Try placing a flat object, such as a board, in the path of the sound beam.	—
Dolby Digital or DTS sources cannot be played. (Dolby Digital or DTS indicator does not light up in the front panel display.)	The connected component is not set to output Dolby Digital or DTS digital signals.	Make an appropriate setting following the operating instructions for your component.	—
	The input mode is set to ANALOG.	Set the input mode to AUTO.	75
There is noise interference when a subwoofer is not connected to this unit.	The protection circuitry was in operation because a source with strong bass elements was played back.	Turn down the volume level.	41
		Select SWFR for BASS OUT.	67
		Connect a subwoofer and adjust settings for SUBWOOFER SET.	67
Low frequency sounds are distorted.	CROSS OVER in SUBWOOFER SET is set incorrectly.	Set CROSS OVER correctly.	67
On-screen display does not appear.	The VIDEO OUT (composite) jack of this unit is not connected to the video input jacks of your TV.	Connect the VIDEO OUT (composite) jack of this unit to the video input jacks of your TV. The OSD is not output at the COMPONENT VIDEO OUT jacks.	16
	The video pin cable is not connected properly.	Connect the cable properly.	16
No picture is displayed for external components, such as a DVD player.	The video pin cable is not connected properly.	Connect the cable properly.	17
This unit does not operate properly.	The internal microcomputer has been frozen by an external electric shock (such as lightning or excessive static electricity) or by a power supply with low voltage.	Disconnect the AC power supply cable from the outlet and then plug it in again after about 30 seconds.	—
There is noise interference from digital or high-frequency equipment.	This unit is too close to the digital or high-frequency equipment.	Move this unit further away from such equipment.	—
This unit does not output effect sounds properly.	The original source includes surround effects.	Disable surround effect settings on this unit.	—
My beam auto-adjust function does not work.	The listening room is too noisy.	Keep the listening room as quiet as possible.	—
		Try manual adjustment.	49
	The sound reflectivity of the listening room is too much.	Set REFLECTING to HI ECHO.	67
	The remote control may be operated outside of the remote control operation range.	The remote control will function within a maximum range of 6 m and no more than 30 degrees off-axis from the front panel.	24

■ Remote control

Problem	Cause	Remedy	See page
The remote control does not work and/or function properly.	Wrong distance or angle.	The remote control will function within a maximum range of 6 m and no more than 30 degrees off-axis from the front panel.	24
	Direct sunlight or lighting (from an inverter type of fluorescent lamp, etc.) is striking the remote control sensor of this unit.	Reposition this unit.	—
	The batteries are weak.	Replace all batteries.	24
You cannot operate external components with this unit's remote control.	The external component you want to operate is not selected as the input source.	Press INPUT on the front panel or the input selector buttons on the remote control to select the external component you want to operate.	39
	The remote control code was not correctly set.	Set the remote control code correctly or try another code for the same manufacturer using the "LIST OF REMOTE CONTROL CODES" at the end of this manual.	81
	Even if the remote control code is correctly set, there are some models that do not respond to the remote control.	Use the remote control supplied with the external component.	—
The cursor buttons do not work during SET MENU operation.	The operation mode selector was unwantedly set to TV/AV.	Set the operation mode selector to YSP.	—
You cannot use the my beam auto-adjust function.	Wrong distance or angle.	The remote control will function within a maximum range of 6 m and no more than 30 degrees off-axis from the front panel.	24

GLOSSARY

Audio formats

■ Dolby Digital

Dolby Digital is a digital surround sound system that gives you completely independent multi-channel audio. With 3 front channels (left, center, and right), and 2 surround stereo channels, Dolby Digital provides 5 full-range audio channels. With an additional channel especially for bass effects, called LFE (low frequency effect), the system has a total of 5.1-channels (LFE is counted as 0.1 channel). By using 2-channel stereo for the surround channels, more accurate moving sound effects and surround sound environment are possible than with Dolby Surround. The wide dynamic range (from maximum to minimum volume) reproduced by the 5 full-range channels and the precise sound orientation generated using digital sound processing provide listeners with previously unheard of excitement and realism.

With this unit, any sound environment from monaural up to a 5.1-channel configuration can be freely selected for your enjoyment.

■ Dolby Pro Logic II

Dolby Pro Logic II is an improved technique used to decode vast numbers of existing Dolby Surround software. This new technology enables a discrete 5-channel playback with 2 front left and right channels, 1 center channel, and 2 surround left and right channels (instead of only 1 surround channel for conventional Pro Logic technology). Music and Game modes are also available for 2-channel sources in addition to the Movie mode.

■ Dolby Surround

Dolby Surround uses a 4 channel analog recording system to reproduce realistic and dynamic sound effects: 2 front left and right channels (stereo), a center channel for dialog (monaural), and a surround channel for special sound effects (monaural). The surround channel reproduces sound within a narrow frequency range.

Dolby Surround is widely used with nearly all video tapes and laser discs, and in many TV and cable broadcasts as well. The Dolby Pro Logic decoder built into this unit employs a digital signal processing system that automatically stabilizes the volume on each channel to enhance moving sound effects and directionality.

■ DTS (Digital Theater Systems) Digital Surround

DTS digital surround was developed to replace the analog soundtracks of movies with a 6-channel digital sound track, and is now rapidly gaining popularity in movie theaters around the world. Digital Theater Systems Inc. has developed a home theater system so that you can enjoy the depth of sound and natural spatial representation of DTS digital surround in your home. This system produces practically distortion-free 6-channel sound (technically, a left, right and center channels, 2 surround channels, plus an LFE 0.1 channel as a subwoofer, for a total of 5.1-channels). The unit incorporates a DTS-ES decoder that enables 6.1-channel reproduction by adding the surround back channel to existing 5.1-channel format.

■ DTS Neo:6

Neo:6 decodes the conventional 2-channel sources for 6 channel playback by the specific decoder. It enables playback with the full-range channels with higher separation just like digital discrete signal playback. Two modes are available; Music mode for playing music sources and Cinema mode for movies.

■ PCM (Linear PCM)

Linear PCM is a signal format under which an analog audio signal is digitized, recorded and transmitted without using any compression. This is used as a method of recording CDs and DVD audio. The PCM system uses a technique for sampling the size of the analog signal per very small unit of time. Standing for pulse code modulation, the analog signal is encoded as pulses and then modulated for recording.

Audio information

■ LFE 0.1 channel

This channel is for the reproduction of low bass signals. The frequency range for this channel is 20 Hz to 120 Hz. This channel is counted as 0.1 because it only enforces a low frequency range compared to the full-range reproduced by the other 5/6 channels in Dolby Digital or DTS 5.1/6.1-channel systems.

INDEX

A

AUTO SETUP (IntelliBeam) 29

B

Beam mode 42, 47, 48

C

Cable clamp 15

Cardboard microphone stand 31

D

Dolby Digital 44

Dolby Pro Logic 44

Dolby Pro Logic II 44

DTS 44

DTS Neo: 6 44

Dynamic range 68

F

Front panel display 7

L

LFE 0.1 channel 89

M

MANUAL SETUP 60

MEMORY 36, 37

My beam 48

O

On-screen display (OSD) 26

Optimizer microphone 30

P

PCM 89

Power supply cable 23

R

Remote control 9, 24, 25

Remote control code 81

S

SET MENU 26

Sleep timer 58

Sound field program 50

Surround mode 44

T

Test tone 72

TruBass 57

TV macro 84

V

Volume mode 55

SPECIFICATIONS

AMP SECTION

- Maximum Output Power (EIAJ)
.....2 W (1 kHz, 10% THD, 4 Ω) \times 40
20 W (100 Hz, 10% THD, 3 Ω) \times 2

SPEAKER SECTION

- Small dia. speakers4 cm cone magnetic shielding type \times 40
Woofers11 cm cone magnetic shielding type \times 2
- Input Jacks
AUDIO VCR, TV/STB (Analog) (1 V, 32 k Ω) ... 2 pairs (Analog)
AUDIO AUX, TV/STB (Optical) 2 (Digital)
AUDIO DVD (Coaxial) 1 (Digital)
COMPOSITE VIDEO, VCR, DVD/AUX, STB 3
COMPONENT VIDEO, DVD/AUX, STB 2 pairs
- Output Jacks
SUBWOOFER (1.5 V, less than 120 Hz) 1 (Subwoofer)
VIDEO (1 Vp-p, 75 Ω) 1 (Composite)
COMPONENT VIDEO (Y: 1 Vp-p, 75 Ω
Pb/Pr: 0.5 Vp-p, 75 Ω) 1
- System Connector Jacks
OPTIMIZER MIC 1 (Microphone input)
RS-232C 1 (System control)
REMOTE IN 1 (System control)
IR-OUT 1 (System control)

GENERAL

- Power supply
[U.S.A. and Canada models] AC 120 V, 60 Hz
[Australia model] AC 240 V, 50 Hz
[U.K. and Europe models] AC 230 V, 50 Hz
[China model] AC 220 V, 50 Hz
[Korea model] AC 220 V, 60 Hz
[General model] AC 110–120 V, 50/60 Hz
[Asia model] AC 220–240 V, 50/60 Hz
- Power Consumption 50 W
- Standby Power Consumption 0.1 W or less
- Dimensions (W x H x D) 1030 \times 194 \times 118 mm
- Weight 13.0 kg

* Specifications are subject to change without notice.

LIST OF REMOTE CONTROL CODES

TV

ADMIRAL 292, 293, 216
 AIWA 294, 276, 283, 284
 AKAI 295, 296
 ALBA 296
 AOC 297
 BELL &
 HOWELL 292
 BESTAR 298
 BLAUPUNKT 229, 222
 BLUE SKY 298
 BRANDT 223
 BROC SONIC 297
 BUSH 296
 BYD:SIGN 201, 202
 CLATRONIC 298
 CRAIG 224
 CROSLEX 225
 CURTIS MATHIS
 297, 226
 DAEWOO 297, 298, 224,
 227, 228
 DAYTRON 239
 DUAL 298
 DWIN 293, 281
 EMERSON 297, 224, 239, 232
 FURGUSON 223, 265, 266
 FIRST LINE 298
 FISHER 295, 233
 FRABA 298
 FUJITSU 289
 FUNAI 277, 278
 GE 293, 297, 234,
 235, 236
 GOODMAN'S 296, 298, 223
 GRUNDIG 229, 238, 249
 HITACHI 297, 239, 242,
 243, 285, 206
 ICE 296
 IRRADIO 296
 ITT/NOKIA 244, 245
 JC PENNY 293, 297, 234, 237
 JVC 296, 246, 247, 286
 KENDO 298
 KTV 297, 239
 LG/GOLDSTAR
 297, 298, 239, 237
 LOEWE 298, 248
 LXI 293, 297, 225,
 226, 233, 298
 MAGNAVOX 297, 225, 239, 298
 MARANTZ 298, 210
 MATSUI 295
 MEDION 203, 204, 298
 MEMOREX 297, 216
 MITSUBISHI 299, 297, 259, 287
 NAD 226, 255
 NEC 297, 252, 282
 NOKIA 244, 245
 NOKIA OCEANIC
 245
 NORDMENDE 265, 266
 ONWA 296
 PANASONIC 234, 235, 236,
 253, 288, 211
 PHILCO 297, 225, 239, 298
 PHILIPS 298, 225, 205
 PIONEER 226, 235, 254,
 255, 268
 PORTLAND 297, 256
 PROSCAN 293, 221

PROSCAN 231, 241, 251
 PROTON 297, 250, 260, 270
 QUASAR 234, 235
 RADIO SHACK 299, 293, 297
 RCA 293, 297, 234,
 256, 257, 258, 221
 RUNCO 220, 230, 271
 SABA 223, 269, 265, 266
 SAMPO 281, 297, 280
 SAMSUNG 297, 239, 248,
 262, 275
 SANYO 295, 233, 279,
 272, 273, 274, 212
 SCHNEIDER 296
 SCOTT 297
 SHARP 292, 239, 232, 213
 SIEMENS 229
 SIGNATURE 216
 SIGNATURE 292
 SONY 263, 214
 SYLVANIA 297, 225, 298
 SYNPHONIC 217, 218, 219
 TELEFUNKUN 269, 264, 265, 266
 THOMSON 223, 266
 TOSHIBA 292, 226, 267, 215
 VIDECH 297, 242
 WARDS 297, 239, 232, 216
 YAMAHA 299, 292, 242,
 285, 287, 253, 206
 ZENITH 216, 261, 271

DVD PLAYER

AIWA 648, 649
 APEX DIGITAL
 652, 653, 654
 BYD:SIGN 678, 679
 DAEWOO 655
 DENON 623, 624, 682
 FUNAI 625
 HARMAN/KARDON
 656, 657
 HITACHI 626
 JVC 627
 KENWOOD 628
 KLH 658
 LG/GOLDSTAR
 645, 663, 664
 MARANTZ 699, 659
 MITSUBISHI 629
 ONKYO 632, 633, 634
 PANASONIC 623, 635, 668,
 672, 682, 683, 684
 PHILIPS 699, 647, 659
 PIONEER 636, 637, 638,
 673, 674, 675, 685
 686, 687
 RCA 639
 SAMSUNG 642
 SHARP 643
 SONY 644, 676, 677
 SYLVANIA 662
 SYMPHONIC 662
 THOMSON 646
 TOSHIBA 634, 665, 666, 667
 YAMAHA 699, 622, 623,
 647, 682
 ZERITH 663, 664

VCR

ADMIRAL 395

AIWA 396, 397, 398, 329
 AKAI 322, 323, 324
 AUDIO DYNAMIC
 392, 394
 BELL & HOWELL
 393
 BLAUPUNKT 325, 326
 BROC SONIC 327
 BUSH 322
 CANON 325, 328
 CGM 396, 332
 CITIZEN 396
 CRAIG 396, 363
 CURTHIS MATHIS
 397, 328, 333
 DAEWOO 328, 334, 335
 DBX 392, 394
 DIMENSIA 333
 DYNATECH 397
 EMERSON 327, 334, 396, 397
 FISHER 393, 336
 FUNAI 397
 GE 328, 333, 387
 GO VIDEO 321, 331, 341,
 351, 353, 363
 GOODMAN'S 334, 337
 GRUNDIG 332, 338
 HITACHI 325, 333, 349,
 342, 343
 INSTANT REPLAY
 325, 328
 ITT/NOKIA 393
 JC PENNY 392, 393, 394,
 328, 333, 349,
 396, 363
 JVC 392, 394, 344,
 345, 346, 347
 KENDO 396
 KENWOOD 392, 394, 396
 LG/GOLDSTAR
 396, 388
 LOEWE 396, 337
 LUXOR 395
 LXI 393, 396, 397,
 336, 349
 MAGNAVOX 325, 326, 328
 MARANTZ 392, 394
 MARTA 396
 MATSUI 396
 MEMOREX 328, 336, 396, 397
 MINOLTA 333, 349
 MITSUBISHI 399, 344, 348,
 359, 353, 352
 MTC 363, 397
 MULTITECH 397, 348, 354
 NEC 392, 394, 344, 383
 NOKIA 393, 395
 NOKIA OCEANIC
 395
 OKANO 323
 OLYMPIC 325, 328
 ORION 327
 PANASONIC 325, 328, 339,
 355, 378, 384,
 385, 386
 PENTAX 333, 349
 PHILCO 325, 328, 397
 PHILLIPS 325, 326, 328,
 337, 356, 357
 PHONOLA 337
 PILOT 396
 PIONEER 325

QUASAR 325, 328
 RCA/PROSCAN
 325, 326, 328,
 333, 335, 349,
 358, 363, 397
 REALISTIC 393, 397, 328,
 336, 359, 362,
 396, 363
 SAMSUNG 354, 358, 363,
 364, 365, 366
 SANSUI 394
 SANYO 393, 336, 367
 SCHNEIDER 337
 SCOTT 399, 335, 336,
 348, 359, 354, 358
 SELECO 322
 SHARP 395, 362, 382
 SIEMENS 393
 SIGNATURE 2000
 395, 397
 SONY 368, 379, 372,
 373, 374, 375
 SYLVANIA 397, 325, 326, 328
 SYMPHONIC 397
 TANDBERG 334
 TANDY 397
 TASHIRO 396
 TATUNG 392, 394
 TEAC 392, 394, 397
 TECHNICS 325, 328
 TEKNIKA 396
 TELEFUNKUN
 376, 377
 THOMAS 397
 THORN 393, 396
 TOSHIBA 335, 389
 TOTEVISION 363, 396
 UNITECH 363
 UNIVERSUM 396, 327, 376
 VIDEOSONIC 363
 W.WHOUSE 396
 WARDS 395, 396, 336,
 362, 397, 363
 YAMAHA 399, 392, 393, 394
 ZERITH 344, 361, 368,
 371, 379, 396, 397

CABLE TV TUNER

ABC 739, 752, 753,
 755, 758, 759, 762
 GENERAL INSTRUMENT
 722
 HAMIN 723, 724, 725,
 726, 727
 HITACHI 722
 JEROLD 722, 728, 729,
 732, 733, 734,
 735, 736, 737
 MAGNAVOX 738
 MOTOROLA 748
 OAK 739, 742, 743
 PANASONIC 744, 745, 746,
 747, 783, 784
 PHILLIPS 763, 764, 765,
 766, 767, 768
 PIONEER 748, 785, 747
 RADIO SHACK 749
 SCIENTIFIC ATLANTA
 752, 753, 754
 SONY 756, 757
 TOCOM 755

UNIVERSAL 769, 772, 773,
774, 775
VIEWSTAR 764, 766, 776,
777, 778, 779, 782

SATELLITE TUNER

ECHOSTAR 822
GE 837, 838, 839
GENERAL INSTRUMENT
823
HITACHI 824
HUGHES 843, 844, 845, 846
JVC 822
MAGNAVOX 825
PANASONIC 826, 829
PHILLIPS 825, 843, 844,
845, 846, 847,
848, 849
PRIMESTAR 827
PROSCAN 837, 838, 839, 842
RADIO SHACK
828
RCA 837, 838, 839, 842
SAMSUNG 852
SONY 832, 835
TOSHIBA 833, 836
UNIDEN 825
ZENITH 834



© 2006 YAMAHA CORPORATION All rights reserved.

YAMAHA ELECTRONICS CORPORATION, USA 6660 ORANGETHORPE AVE., BUENA PARK, CALIF. 90620, U.S.A.
YAMAHA CANADA MUSIC LTD. 135 MILNER AVE., SCARBOROUGH, ONTARIO M1S 3R1, CANADA
YAMAHA ELECTRONIK EUROPA G.m.b.H. SIEMENSSTR. 22-34, 25462 RELLINGEN BEI HAMBURG, GERMANY
YAMAHA ELECTRONIQUE FRANCE S.A. RUE AMBROISE CROIZAT BP70 CROISSY-BEAUBOURG 77312 MARNE-LA-VALLEE CEDEX02, FRANCE
YAMAHA ELECTRONICS (UK) LTD. YAMAHA HOUSE, 200 RICKMANSWORTH ROAD WATFORD, HERTS WD18 7GQ, ENGLAND
YAMAHA SCANDINAVIA A.B. J A WETTERGRENS GATA 1, BOX 30053, 400 43 VÄSTRA FRÖLUNDA, SWEDEN
YAMAHA MUSIC AUSTRALIA PTY, LTD. 17-33 MARKET ST., SOUTH MELBOURNE, 3205 VIC., AUSTRALIA

YAMAHA CORPORATION
Printed in Malaysia ◀ WH82880



English

YSP-1100 QUICK REFERENCE GUIDE

This quick reference guide explains steps to connect a TV and a DVD player to this unit and achieve the surround sound effects in a quick, easy manner. For detailed operation, refer to the Owner's Manual.

Installing this unit

Decide where to install this unit.

Install this unit where there are no objects such as furniture obstructing the path of sound beams. Otherwise, the desired surround sound effects may not be achieved. You may install this unit in parallel with the wall or in the corner.

Install this unit in the exact center of the wall when it is measured from the left and right corners.

An object, such as furniture

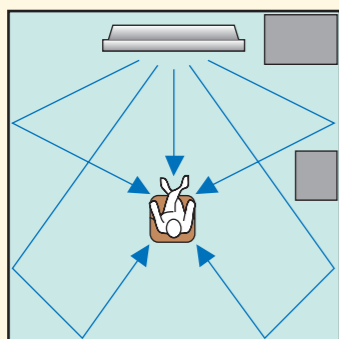

Install this unit in the corner at a 40° to 50° angle from the adjacent walls.

An object, such as furniture

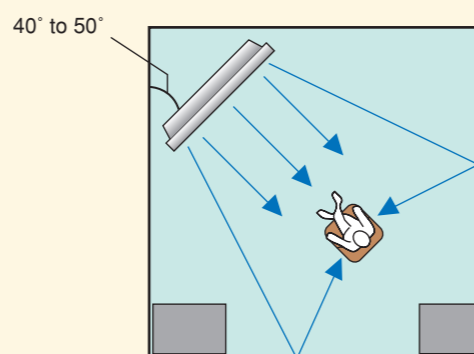

Install this unit either above or under your TV.

Please read the following for reference. For further information on installation, see pages 11 and 13 in the Owner's Manual. Make sure you use the supplied fasteners to prevent an accidental fall of this unit (see page 14 in the Owner's Manual).

When installing this unit above your TV, place it on the top panel of a commercially available rack as shown below. Make sure that the top panel of the rack is wide and stable enough to support the weight of this unit.

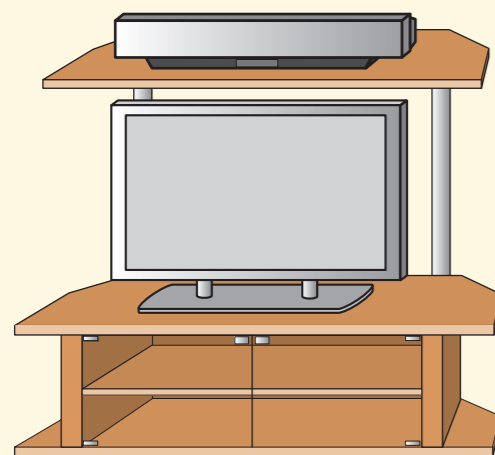

When installing this unit under your TV, place it in a TV cabinet as shown below. Make sure that the cabinet is large enough to allow adequate ventilation space around this unit. To enjoy better surround effects, place this unit on the upper shelf to keep it away from the floor.

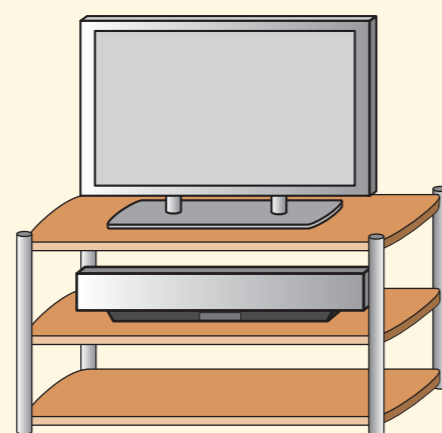

Connecting external components to this unit

Connect external component such as a TV or DVD player to this unit.

Connect your TV or DVD player to this unit using appropriate cables as shown below. Connecting a subwoofer enhances bass sound for listening enjoyment. For further information on connecting other components, see pages 15 to 22 in the Owner's Manual.

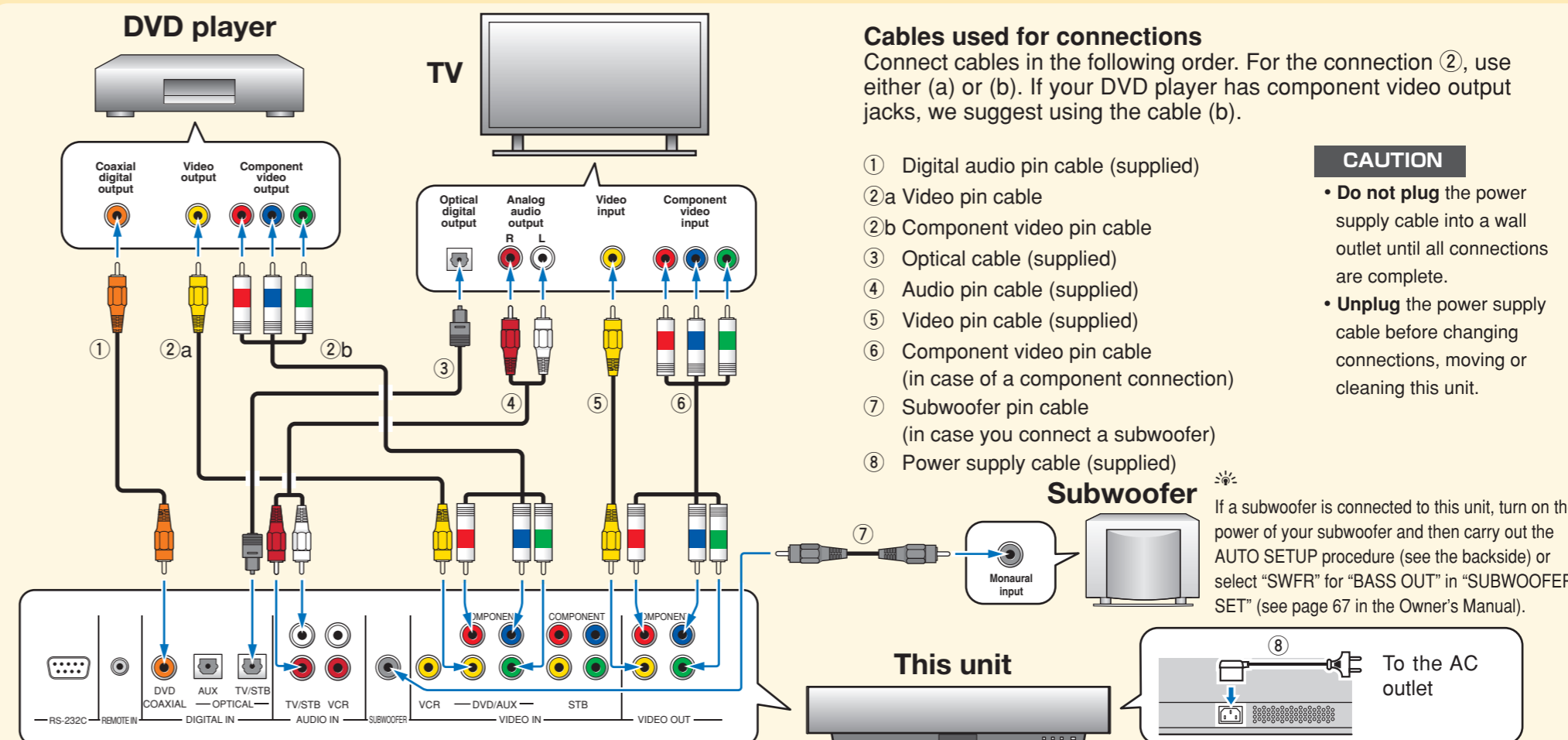

Setting up the listening environment automatically IntelliBeam

Connect the optimizer microphone to this unit.

You can automatically adjust the various channel settings that best match your listening environment using the supplied optimizer microphone. Follow the procedure below to connect the optimizer microphone to this unit and place it in a proper location.

Connect the optimizer microphone to the OPTIMIZER MIC jack on the left side of this unit.

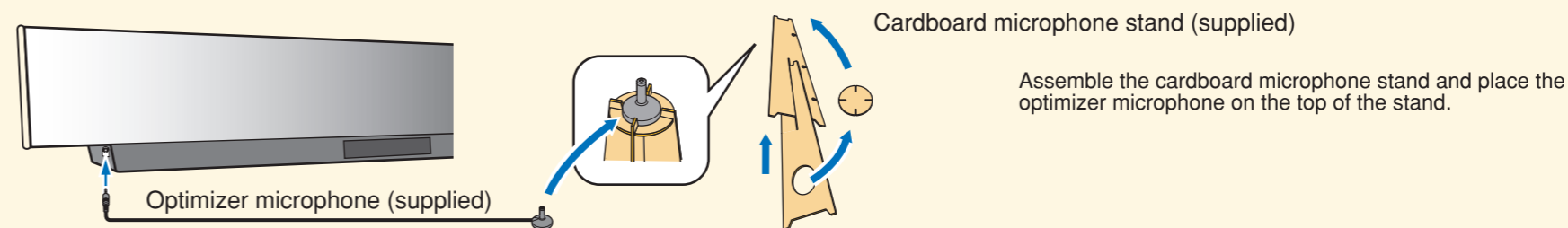

Set the optimizer microphone at your normal listening position. Use the supplied cardboard microphone stand or a tripod to place the optimizer microphone at the same height as your ears would be when you are seated.

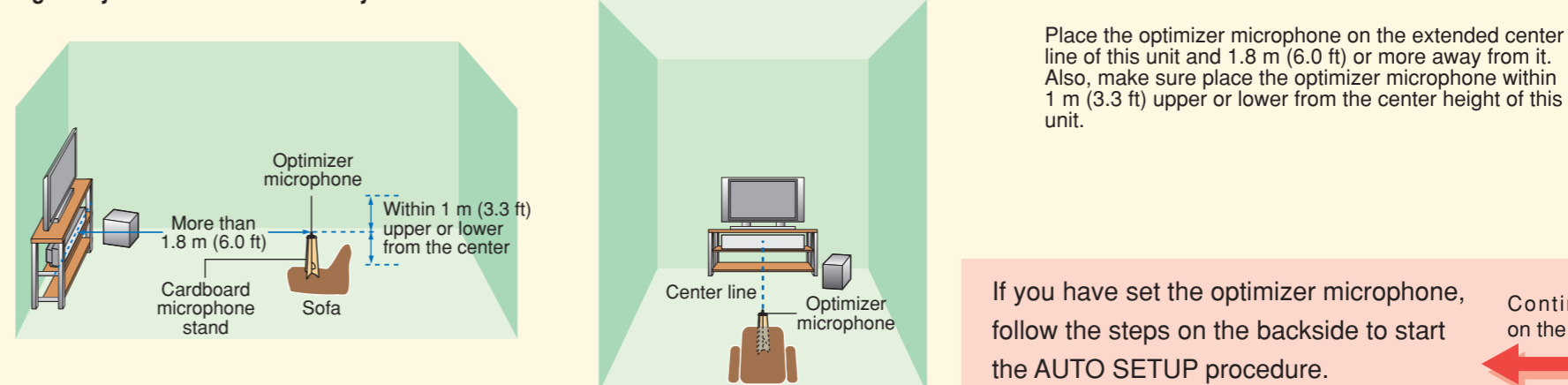

Continued on the back

Carry out the AUTO SETUP (IntelliBeam) procedure to adjust the settings that best match your listening environment.

This unit employs the YAMAHA IntelliBeam technology with the aid of the supplied optimizer microphone, allowing you to achieve highly accurate sound adjustments that best match your listening environment. Be advised that it is normal for loud test tones to be output during the AUTO SETUP procedure. Make sure that there are no children around in the listening room while the AUTO SETUP procedure is in progress.

1 Press STANDBY/ON on the remote control.

The power of this unit turns on.

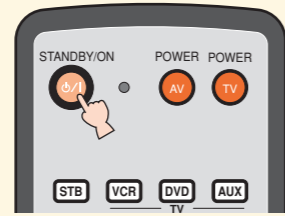

If a subwoofer with adjustable volume and crossover/high cut frequency controls is connected to this unit, set the volume between 11 and 1 o'clock as viewed on a conventional clockface and set the crossover/high cut frequency to the maximum.

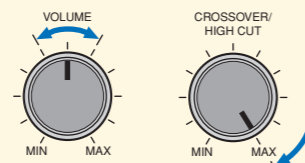

Subwoofer

2 Turn on the power of your TV.

3 Select the appropriate video input on your TV.

4 Set the operation mode selector to YSP.

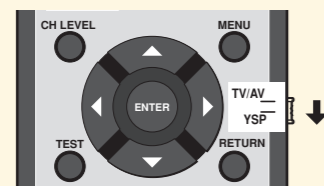

5 Press and hold AUTO SETUP for more than 2 seconds.

The menu screen appears on the TV. If the menu screen does not appear, check the video pin cable (connection ⑤ in the diagram on the front page) is connected properly and then press YSP followed by MENU.

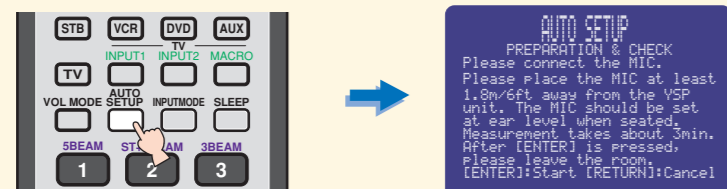

6 Check the following points.

- Is the optimizer microphone firmly connected to this unit?
- Is the optimizer microphone placed in a proper location?
- Are there any large obstacles in between the optimizer microphone and the walls in your listening room?
- The AUTO SETUP procedure starts in 10 seconds after pressing ENTER on step 7. To achieve the best results possible, evacuate yourself for your listening room until the AUTO SETUP procedure is completed.
- To cancel the AUTO SETUP procedure after it is started, press RETURN.
- The AUTO SETUP procedure takes about **3 minutes**.

7 Press ENTER to start the AUTO SETUP procedure.

The following screen appears on the TV and the AUTO SETUP procedure starts in 10 seconds.

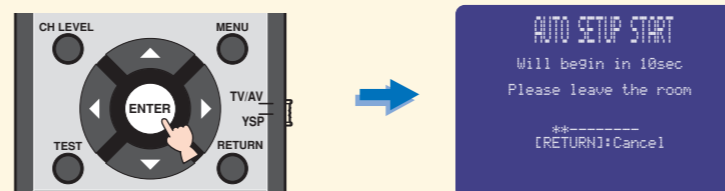

The setup screen automatically changes during the AUTO SETUP procedure. If any error occurs, the corresponding error message appears on the screen. In this case, see "Error messages for AUTO SETUP" on page 35 in the Owner's Manual and then follow the instructions. To start the AUTO SETUP procedure once again, press RETURN and then carry out the procedure from step 5.

When the AUTO SETUP procedure is complete, the following screen appears on the TV.

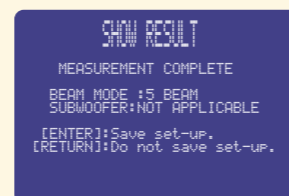

* This is an example of the result screen. The result may differ depending on the environment.

8 Press ENTER.

The result is confirmed and the following screen appears on the TV for 2 seconds and then the menu screen disappears from the TV.

The new settings are automatically saved in the system memory. Disconnect the optimizer microphone and keep it in a safe place.

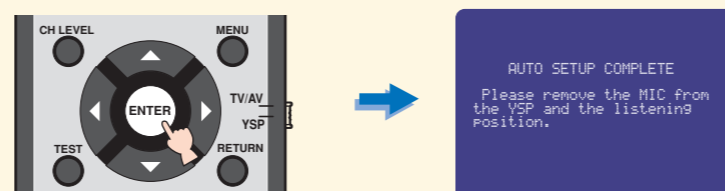

Enjoying surround sound

Enjoy TV or DVD audio in surround sound.

For instructions on your TV or DVD player, refer to the owner's manual supplied with each component. Before carrying out the procedure below, set the volume of this unit to 30. If necessary, adjust the volume level in step 4.

Enjoying TV in surround sound

- 1 Select the TV channel using the remote control supplied with your TV.

Enjoying DVDs in surround sound

- 1 Select the DVD video input on your TV.

- 2 Set the operation mode selector to YSP.

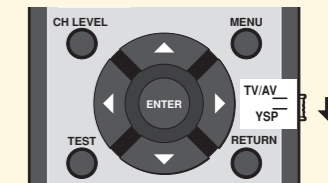

- 3 Press TV on the remote control of this unit.

This unit switches to the TV playback mode.

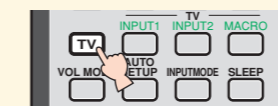

- 3 Press DVD on the remote control of this unit, and then start playback on the DVD player.

This unit switches to the DVD playback mode.

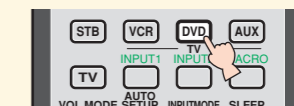

- 4 If you hear sound output from your TV speakers, turn down the volume level until you cannot hear any sound.

Use the remote control supplied with your TV.

- 5 Press VOLUME +/- on the remote control to adjust the volume level of this unit.

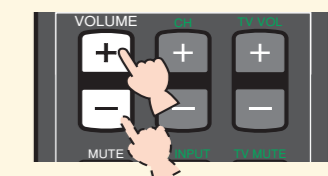

- 6 Press one of the beam mode buttons on the remote control to select the desired beam mode.

Select one of the three beam modes that best matches the current input source of this unit. For further information on the beam modes, see page 42 in the Owner's Manual.

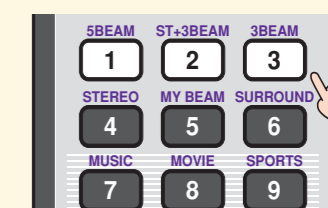

To fine-tune the listening environment parameters manually or make advanced settings for speaker positions, sound beams, etc., see "MANUAL SETUP" on page 60 in the Owner's Manual.