



YSP-5100 / YSP-4100

Digital Sound Projector™

Owner's Manual

English
for North America

IntelliBeam

The “IntelliBeam” logo and “IntelliBeam” are trademarks of Yamaha Corporation.



The “CINEMA DSP” logo and “Cinema DSP” are registered trademarks of Yamaha Corporation.

UniVolume

The “UniVolume” and “UniVolume” are trademarks of Yamaha Corporation.

yAired

The “yAired” and “yAired” are trademarks of Yamaha Corporation.



Manufactured under license from Dolby Laboratories. Dolby, Pro Logic and the double-D symbol are trademarks of Dolby Laboratories



Manufactured under license under U.S. Patent No's: 5,451,942;5,956,674;5,974,380;5,978,762;6,226,616;6,487,535 & other U.S. and worldwide patents issued & pending. DTS is a registered trademark and the DTS logos, Symbol, DTS-HD and DTS-HD Master Audio are trademark of DTS, Inc. © 1996-2007 DTS, Inc. All Rights Reserved.



Manufactured under license from Cambridge Mechatronics Ltd. Worldwide patents applied for.

The “1” logo and “Digital Sound Projector™” are trademarks of Cambridge Mechatronics Ltd.

HDMI

“HDMI”, the “HDMI” logo and “High-Definition Multimedia Interface” are trademarks or registered trademarks of HDMI Licensing LLC.

x.v.Color

“x.v.Color” is a trademark.

iPod™, iPhone™

iPod is a trademark of Apple Inc., registered in the U.S. and other countries. iPhone is a trademark of Apple Inc.



“Made for iPod” means that an electronic accessory has been designed to connect specifically to iPod and has been certified by the developer to meet Apple performance standards. “Works with iPhone” means that an electronic accessory has been designed to connect specifically to iPhone and has been certified by the developer to meet Apple performance standards. Apple is not responsible for the operation of this device or its compliance with safety and regulatory standards.



SIRIUS, XM and all related marks and logos are trademarks of Sirius XM Radio Inc. and its subsidiaries. All rights reserved. **Service not available in Alaska and Hawaii.**

About this manual

- Make sure you read precautions in “Safety and Accessory Information” (separate booklet) carefully before using this unit.
- This manual describes how to connect and operate this unit. For details regarding the operation of external components, refer to the supplied owner's manual for each component.
- Operations in this manual use keys on the supplied remote control of this unit unless otherwise specified.
-  indicates a tip for your operation.
- An illustration of the remote control in the left pages of this manual indicates the keys to be used in two facing (left and right) pages.
- This manual is produced prior to production. Designs and specifications are subject to change in part as a result of improvements, etc. In case of differences between the manual and the product, the product has priority.

CONTENTS

INTRODUCTION

Features	4
General operation flow	5
Controls and functions	6
Front panel	6
Front panel display	7
Rear panel.....	8
Remote control.....	9

PREPARATION

Installation	10
Connections	12
Before connecting components	12
Connecting external components	12
Connecting a subwoofer.....	13
Connecting the FM antenna	14
Preparing the remote control	14
Installing batteries in the remote control.....	14
Operation range of the remote control	14
Changing OSD language	15
AUTO SETUP (IntelliBeam)	15
Installing the IntelliBeam microphone.....	15
Using AUTO SETUP (IntelliBeam)	16
Using the system memory	19
Saving settings	19
Loading settings	19

PLAYBACK FEATURES

Playback	21
Playing back sources	21
Playing back TV sounds.....	21
Playing back a player	21
Muting audio output.....	21
Decoder and input channel indicators	21
Playback mode	22
Selecting surround or stereo playback	22
Enjoying CINEMA DSP programs.....	22
Changing the audio output method for surround playback.....	23
Enjoying 2-channel sources in surround sound	24
Playing back 5.1-channel sources in 7.1-channel surround	24
FM tuning	25
Tuning into the desired FM station (Frequency tuning)	25
Registering FM stations and tuning in (Preset tuning).....	25
SIRIUS Satellite Radio™ tuning	26
Listening to Satellite Radio	26
Connecting the SiriusConnect™ tuner.....	26
Activating SIRIUS Satellite Radio™ subscription	27
SIRIUS Satellite Radio™ operations	27
Registering SIRIUS Satellite Radio™ channels	28
Setting the Parental Lock	29
Displaying the SIRIUS Satellite Radio™ information	30
Playing back iPod™/iPhone™	30

Useful features	31
Adjusting volume level automatically (UniVolume).....	31
Using the HDMI™ control function.....	31
Using the sleep timer	31
Configuring settings for each input source (Option menu)	32
Displaying the input signal information	32

SETTINGS

Customizing this unit (SET MENU)	33
SET MENU items	33
Basic SET MENU operation.....	34
MANUAL SETUP.....	34
SOUND SET MENU	36
SOUND OUT MENU.....	37
INPUT MENU	38
DISPLAY MENU	39
System configurations (ADVANCED SETUP)	40
Using an external amplifier	41
Controlling external components	42

APPENDIX

Troubleshooting	43
Glossary	47
Specifications	48
List of remote control codes	49
Index	56

INTRODUCTION

Features

Digital Sound Projector

The Digital Sound Projector technology allows one slim unit to control and steer multiple channels of sound to generate multi-channel surround sound, thus eliminates the need for satellite loudspeakers and cabling normally associated with conventional surround sound systems. This unit also employs the beam modes that let you enjoy the surround sound (5 Beam, Stereo+3 Beam, 3 Beam for 5.1-channel audio, 5 Beam plus 2, Stereo + 3 Beam plus 2, 3 Beam for 7.1-channel audio) and 2-channel stereo playback.

HDMI (High-Definition Multimedia Interface)

- ◆ HDMI input x 4, HDMI output x 1
- ◆ HDMI interface for standard, enhanced, or high-definition video (including 1080p video signal transmission) as well as multi-channel digital audio based on HDCP
 - Automatic audio and video synchronization (lip sync) information capability
 - Deep Color video signal transmission capability
 - “x.v.Color” video signal transmission capability
 - High definition digital audio format signals capability
 - Multi-channel Linear PCM signal capability
- ◆ Simple and easy connections with HDMI supported external components
- ◆ Functional link which enables the remote control of your TV to control this unit (with an HDMI control-compatible TV)
 - Power mode switch capability (on/standby)
 - Volume adjustment capability
 - TV sounds reproduce device selection capability (this unit/TV)

AUTO SETUP (IntelliBeam)

This unit employs the automatic sound beam and acoustic optimization technology with the aid of the supplied IntelliBeam microphone. You can avoid troublesome listening-based speaker setup and achieve highly accurate sound beam adjustments that best match your listening environment.

Cinema DSP

This unit employs the Cinema DSP technology developed by Yamaha Electronics Corp. that lets you experience movies at home with all the original dramatic sound impact.

UniVolume

This unit employs the automatic volume adjustment function. You can limit the volume level of the TV so that it will not increase suddenly when whenever the contents being broadcast change (due to commercials, etc.).

Various digital audio decoders includes newly added HD audio decoder, and sound technologies

- ◆ Dolby TrueHD, Dolby Digital Plus, Dolby digital Surround EX, Dolby Digital, Dolby Pro Logic, Pro Logic II, Pro Logic IIx
- ◆ DTS-HD Master Audio, DTS-HD High Resolution Audio, DTS 96/24, DTS-ES, DTS, DTS-ES (discrete and matrix), DTS Neo: 6
- ◆ Music Enhancer to improve the sound quality of compression artifacts such as the MP3 format
- ◆ Bass Extension to produce powerful bass sounds

Sophisticated FM tuner

- ◆ 40-station random and direct preset tuning
- ◆ Automatic preset tuning

SIRIUS Satellite Radio

- ◆ SIRIUS Satellite Radio tuning capability, using SiriusConnect tuner, sold separately
- ◆ SIRIUS Satellite Radio information displaying capability

Wireless connection (yAired)

- ◆ Wireless connection with iPod/iPhone, using Yamaha wireless transmitter for iPod (PDX-50TX/PDX-50BC)
- ◆ Wireless connection with subwoofer, using Yamaha wireless subwoofer kit (SWK-W10) (not available in some countries)
- ◆ iPod/iPhone interlock feature to turn on/off this unit or switch the input source in conjunction with iPod/iPhone operations

Versatile Remote Control

The supplied remote control comes with preset remote control codes used to control external components connected to this unit.

General operation flow

1 Install this unit and connect to other components.

“Installation” (page 10), “Connections” (page 12)



2 Run AUTO SETUP to optimize the beam and sound settings.

“AUTO SETUP (IntelliBeam)” (page 15)



3 Play back a source.

“Playback” (page 21).



4 Change the playback method (surround/stereo), CINEMA DSP and/or beam modes settings.

“Playback mode” (page 22).



5 Configure this unit's settings and/or set remote control codes.

“Customizing this unit (SET MENU)” (page 33), “Controlling external components” (page 42).

Controls and functions

Front panel

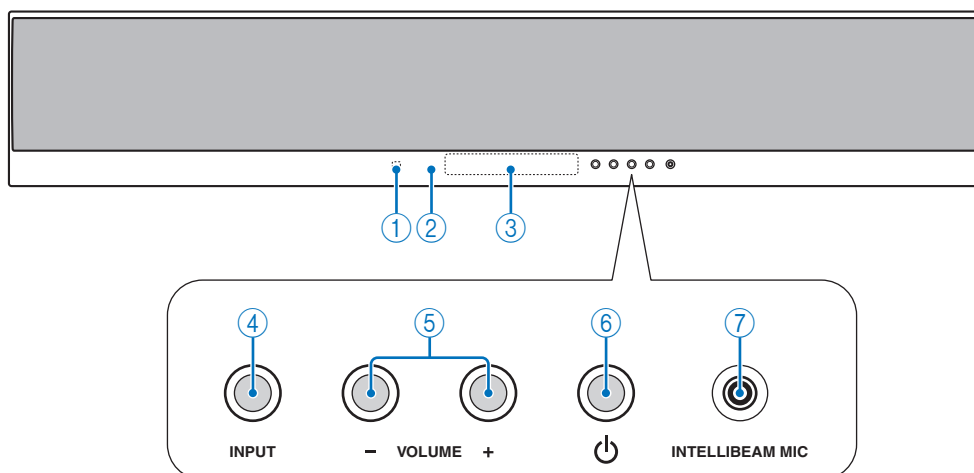

① **Remote control sensor**

Receives infrared signals from the remote control (page 14).

② **Power LED**

Lights up when the power is turned on (page 21).

③ **Front panel display**

Shows information about the operational status of this unit (page 7).

④ **INPUT**

Press repeatedly to switch between input sources.

⑤ **VOLUME +/-**

Controls the volume level of all audio channels.

Control range: MIN (minimum), 01 to 99, MAX (maximum)

⑥ **Power (⏻) key**

Turns on the power of this unit or sets it to the standby mode (page 21).

Note

- In the standby mode, this unit consumes a small amount of power in order to receive infrared signals from the remote control or to search for HDMI signals.

⑦ **INTELLIBEAM MIC jack**

Connect the supplied IntelliBeam microphone for AUTO SETUP (page 15).

Front panel display

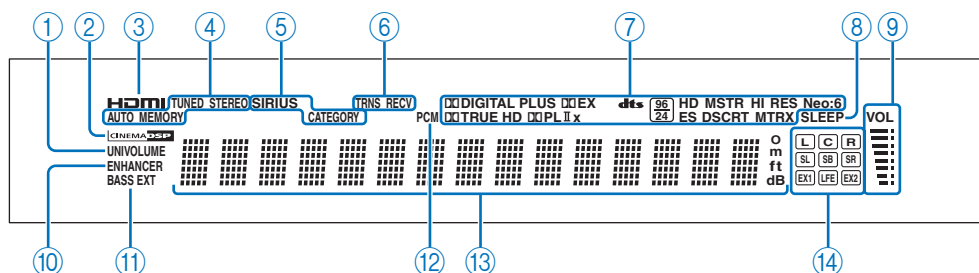

① UNIVOLUME indicator

Lights up when the UniVolume function is turned on (page 31).

② CINEMA DSP indicator

Lights up when a sound field program is selected (page 22).

③ HDMI indicator

Lights up when the signal of the selected input source is input from the HDMI IN jack(s).

④ Tuner indicators

FM: Light up when this unit is tuned into an FM station (page 25).
SIRIUS: MEMORY flashes during the preset operation (page 28).

⑤ SIRIUS indicators

Light up when this unit is tuned into a SIRIUS Satellite Radio channel (page 26).

⑥ Wireless indicators

TRNS Lights up when a wireless connection is established between the Yamaha wireless subwoofer kit (SWK-W10) and this unit (page 13).

REC'V Lights up when a wireless connection is established between the Yamaha wireless transmitter for iPod (PDX-50TX) and this unit (page 30).

⑦ Decoder indicators

Light up when the corresponding decoder operates (page 21).

⑧ SLEEP indicator

Lights up when the sleep timer is set (page 31).

⑨ Volume level indicator

Displays the current volume level.

⑩ ENHANCER indicator

Lights up when the Music Enhancer is selected (page 37).

⑪ BASS EXT indicator

Lights up when the bass extension mode is turned on (page 37).

⑫ PCM indicator

Lights up when this unit is reproducing PCM (Pulse Code Modulation) digital audio signals.

⑬ Multi-information display

Shows information with alphanumeric characters when you adjust the parameters of this unit. Current input source and audio output method are displayed when this unit is turned on.

⑭ Input channel indicators

The channel component of the current input signal is displayed (page 21).

Rear panel

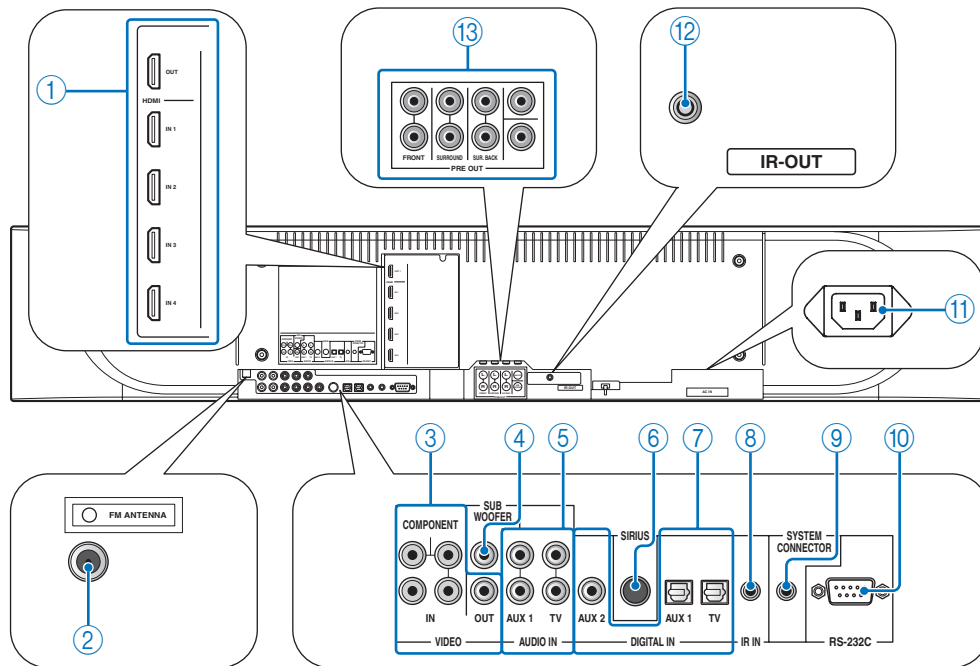

Note

- The rear panel illustration shows jacks and their names to help you find them easily. They are not exactly the same as the ones on the actual rear panel of this unit.

① HDMI jacks

Connect your HDMI components (page 12).

② FM ANTENNA jack

Connect the FM antenna (page 14).

③ VIDEO jacks

Connect to the video jacks of your external components (page 12).

④ SUBWOOFER jack

Connect your subwoofer (page 13).

⑤ AUDIO IN jacks

Connect to the analog audio output jacks of your external components (page 12).

⑥ SIRIUS antenna jack

Connect a SiriusConnect tuner (sold separately) (page 26).

⑦ DIGITAL IN jacks

Connect to the digital audio output jacks of your external components (page 12).

⑧ IR IN terminal

This is a control expansion terminal for commercial use only.

⑨ SYSTEM CONNECTOR terminal

Use to connect a Yamaha subwoofer equipped with a SYSTEM CONNECTOR terminal to this unit (page 13).

⑩ RS-232C terminal

This is a control expansion terminal for commercial use only.

⑪ AC IN

Connect the supplied power cable (page 12).

⑫ IR-OUT terminal

This is a control expansion terminal for commercial use only.

⑬ PRE OUT jacks

Connect your external amplifier (page 41).

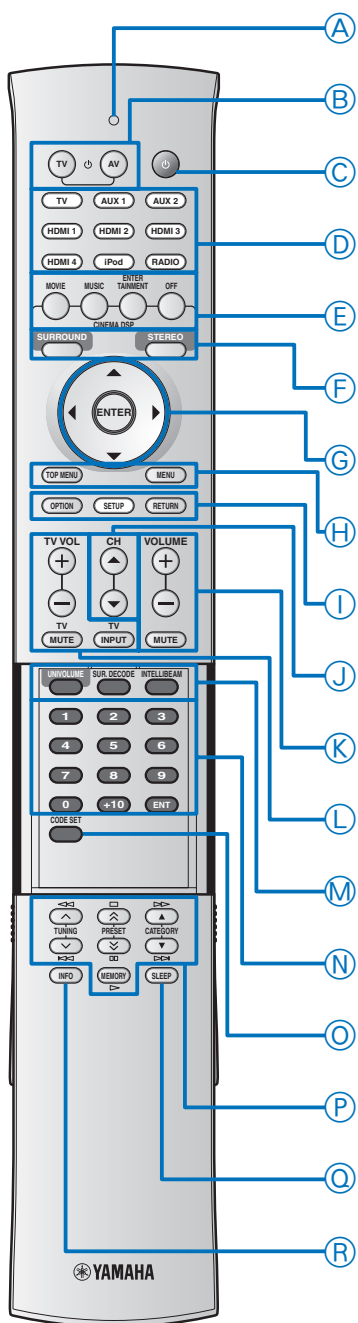

Note

- When operating the keys located on the slide cover (INFO, SLEEP, etc.), close the slide cover completely before operation.

A Transmission indicator

Lights up when infrared control signals are being output.

B TV (⏻)

Turns on the power of your TV or set it to the standby mode (page 42).

B AV (⏻)

Turns on the power of the selected component or set it to the standby mode (page 42).

C Power (⏻) key

Turns on the power of this unit or set it to the standby mode (page 21).

D Input selector keys

Use to select an input source (page 21). An input source key currently selected lights up when the remote control is operated.

E CINEMA DSP program keys

Select the CINEMA DSP programs (page 22).

F SURROUND/STEREO

Switches between surround and stereo playback (page 22).

G Cursor (⬆ / ⬇ / ⬅ / ➡) keys, ENTER

Select and adjust menu items.

H TOP MENU

Displays the top menu of a Blu-ray disc or DVD (page 42).

H MENU

Displays the menu of a Blu-ray disc or DVD (page 42).

I OPTION

Displays the option menu (page 32). The remote control turns to setting mode (ⓘSETUP lights up).

I SETUP

Displays the SETUP menu (page 33). Press and hold to directly enter the LANGUAGE SETUP menu (page 15). Lights up when the remote control is turned into the setting mode of the main unit.

I RETURN

Returns to the previous menu screen (page 34).

J CH ⬆ / ⬇

Changes the channels of your TV/recorder (page 42).

K VOLUME +/-

Increases or decreases the volume level of this unit (page 21).

K MUTE

Mutes the sound. (page 21).

L TV operation keys

Use to control your TV (page 42).

M UNIVOLUME

Turns on or off the UniVolume function (page 31).

M SUR.DECODE

Selects a decoder for surround playback (page 24). The remote control turns to setting mode (ⓘSETUP lights up).

M INTELLIBEAM

Enters the AUTO SETUP menu (page 16). The remote control turns to setting mode (ⓘSETUP lights up).

N Numeric keys

Use to enter numbers.

O CODE SET

Sets remote control codes for external component operations (page 42).

P Tuner / external component operation keys

Use to select or preset an FM station or Sirius Satellite Radio channel or control playback of your external components (pages 25, 26 and 42).

O SLEEP

Sets the sleep timer (page 31).

R INFO

Displays information about signals currently input to this unit (page 32).

PREPARATION

Installation

This section describes a suitable installation location to install this unit using a wall mount bracket, a rack, a table top stand or a floor stand. To achieve desired surround sound effects, install this unit where there are no objects such as furniture obstructing the path of sound beams (page 11). Depending on your installation environment, connections with external components (page 12) should be done before installation.

Notes

- Make sure you leave an adequate amount of ventilation space so that heat can escape. We recommend installing this unit using a wall mount bracket, a rack, a table top stand or a floor stand.
- Be sure to install this unit where it will not fall subject to vibrations, such as from an earthquake, and where it is out of the reach of children.
- When using a cathode-ray tube (CRT) TV, do not install this unit directly above your TV.
- If the picture on your TV screen becomes blurred or distorted, we recommend moving this unit away from your TV.

■ Attach the stands

Attach the supplied stands to this unit as shown below. Make sure that you attach the left and right stands correctly. These stands are unnecessary if you use the optional wall mount bracket.

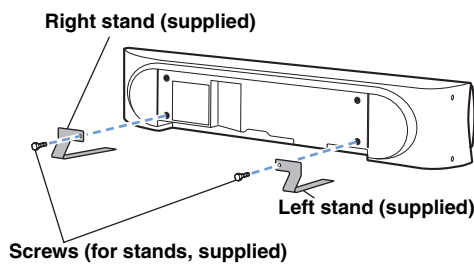

Note

- Depending on a rack, table top stand, or floor stand, the stands may not be necessary.

■ Using a rack

You can install this unit either above or under your TV in a commercially available rack. It should be large enough to allow adequate ventilation space around this unit and strong enough to support the weight of both this unit and your TV.

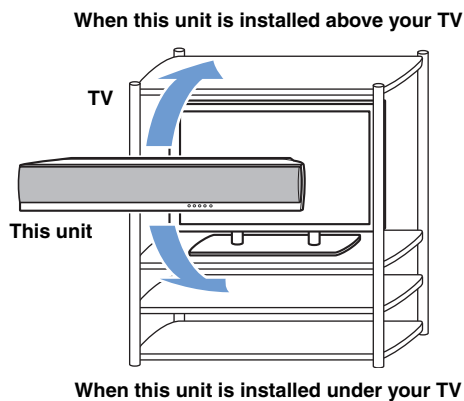

■ Using a wall mount bracket

You can use the optional wall mount bracket (such as SPM-K30) to mount this unit on the wall in your listening room.

Attachment of the wall mount bracket: refer to the owner's manual supplied with the wall mount bracket.

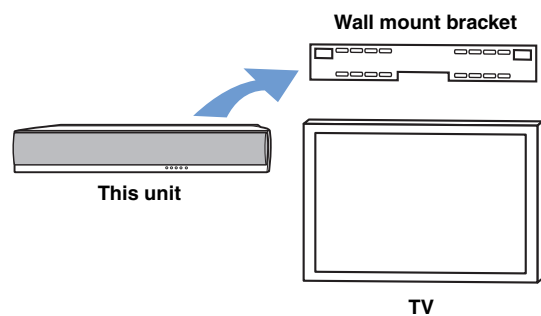

Dimensions when using SPM-K30

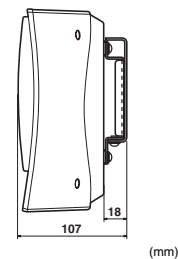
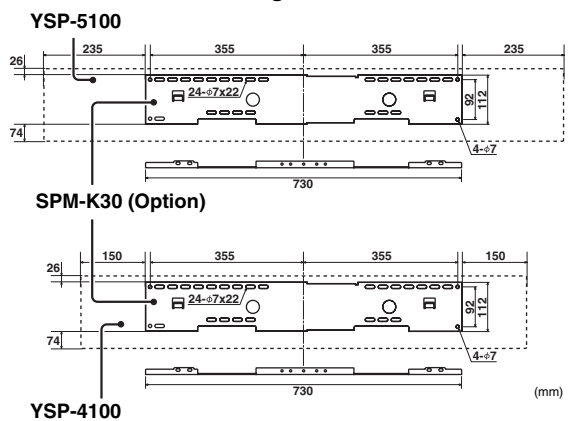

■ Using a table top stand or a floor stand

You can mount both your TV and this unit on a commercially available table top stand or floor stand.

■ Ideal installation condition

 : Object such as furniture

Parallel installation (with 5Beam)

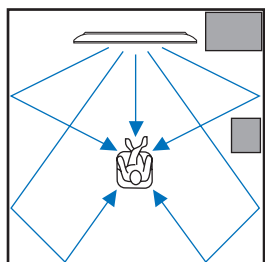

Corner installation (with Stereo+3Beam)

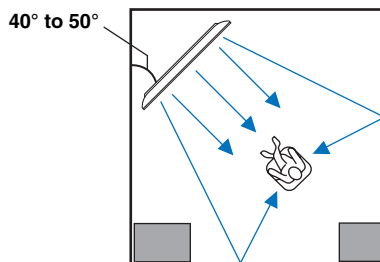

■ For better listening environment

Example 1

Install this unit as close to the exact center of the wall as possible.

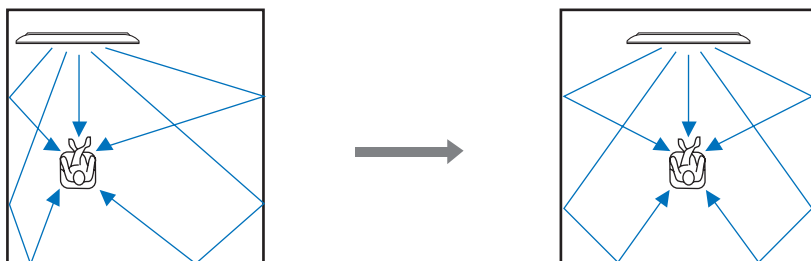

Example 2

Install this unit so that the sound beams can be reflected off the walls.

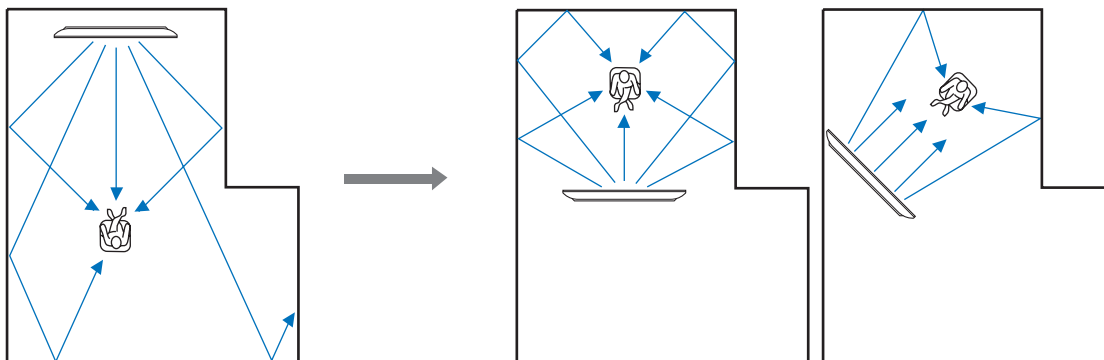

Example 3

Install this unit as close to the exact front of your normal listening position as possible.

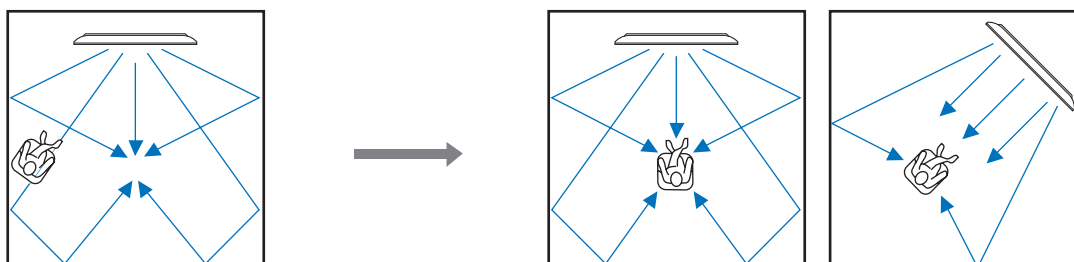

Connections

Before connecting components

Cables used for connections

The symbols on the left of cable names (such as 1, 1, and 1) correspond with the symbols described in “Connecting your TV and Blu-ray disc player” (page 12) and “Connecting audio video components” (page 13).

For audio and video

1 HDMI cable



For audio

1 Audio pin cable (supplied)

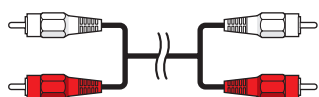

2 Optical cable (supplied)

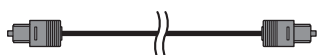

3 Digital audio pin cable (supplied)

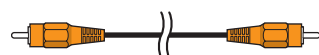

For video

1 Video pin cable (supplied)

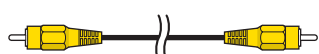

2 Component video pin cable

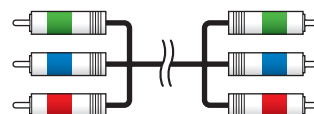

Information on HDMI

An HDMI cable can transmit both audio and video signals at the same time. If your TV and other components have HDMI jacks, use HDMI cables for simpler and easier connections.

See also: “Using the HDMI control function” (page 31), “INPUT MENU” (page 38)

Input source	Audio signal type
Blu-ray disc HD DVD	Dolby Digital, Dolby Digital Plus, Dolby TrueHD, DTS, DTS-HD High Resolution Audio, DTS-HD Master Audio, 2-channel PCM, multi-channel PCM
DVD video	Dolby Digital, DTS, 2-channel PCM, multi-channel PCM
DVD audio	2-channel PCM, multi-channel PCM



- This unit automatically converts input video signals and outputs the signals from the HDMI OUT jack.
- The HDMI of this unit supports High-Bandwidth Digital Content Protection (HDCP).
- We recommend that you use an HDMI cable shorter than 5 m (16 ft) with the HDMI logo printed on it.

Priority order for audio input signals

When digital and analog audio signals are simultaneously input from a single source component, this unit plays back digital audio signals by priority. For example, if audio signals are input to the DIGITAL IN (AUX 1) and AUDIO IN (AUX 1) jacks simultaneously, this unit plays back audio signals input to the DIGITAL IN (AUX 1) jack when “AUX1” is selected as the input source.

Connecting external components

Connect external components (TV, Blu-ray disc player, etc.) to this unit. Do not plug the power supply cable into an AC wall outlet until all connections are complete.

Connecting your TV and Blu-ray disc player

The following connection example shows a way to connect your TV and Blu-ray disc player by using the HDMI jacks. When you connect them by using the other jacks, refer to “Connecting audio and video components” (page 13). The symbols beside the cables correspond with the symbols described in “Cables used for connections” (page 12).

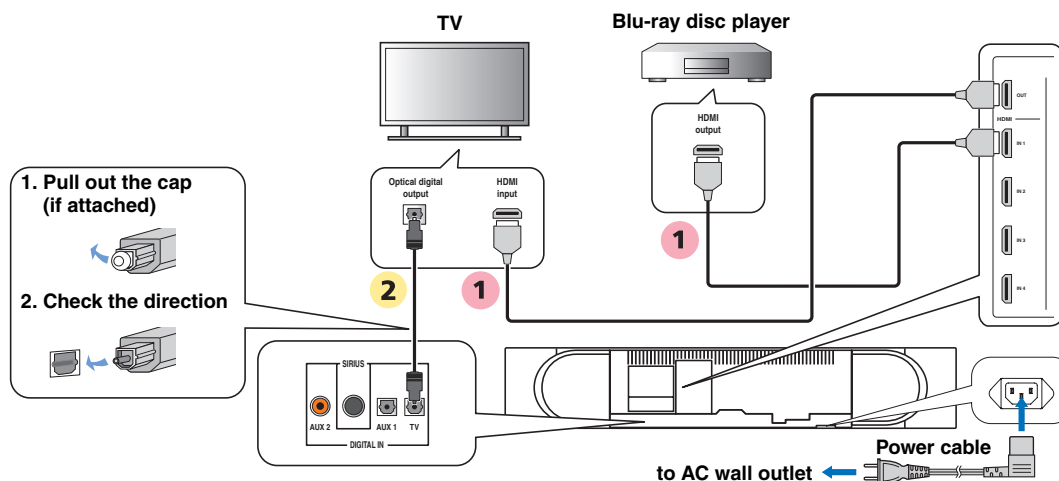

■ Connecting audio and video components

Determine the connection types depending on the jacks available on this unit and your external components. The symbols in the following table correspond with the symbols described in “Cables used for connections” (page 12).

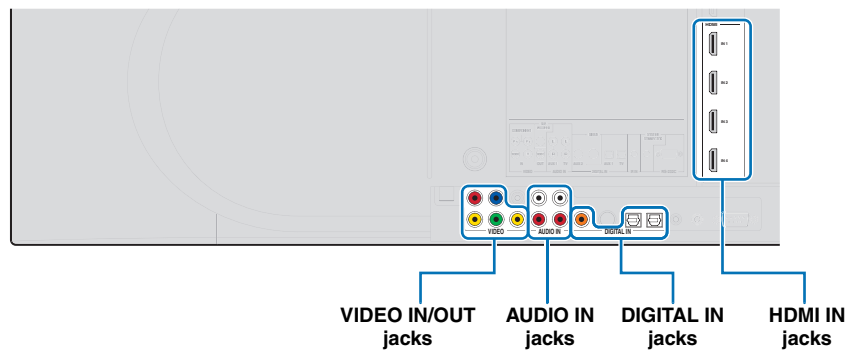

External component	Signal type	Jacks to use		Cable to use	Input selection key
		On external component	On this unit		
TV	Video	Composite video input	VIDEO OUT	1	
	Audio	Analog audio output	AUDIO IN (TV)	1	
External component with HDMI output	Audio/video	HDMI output	HDMI IN 1-4	1	HDMI1-4
External component with component video output	Audio	Coaxial digital output	DIGITAL IN (AUX 2)	3	AUX2
	Video	Component video output	VIDEO IN (COMPONENT)	2	
External component with composite video output	Audio	Optical digital output	DIGITAL IN (AUX 1)	2	AUX1
		Analog audio output	AUDIO IN (AUX 1)	1	
	Video	Composite video output	VIDEO IN (VIDEO)	1	



- Video signals input from the VIDEO IN (VIDEO) jack can be output not only to the VIDEO OUT jack but also the HDMI OUT jack. Video signals input from the VIDEO IN (COMPONENT) jacks are output to the HDMI OUT jack.

Connecting a subwoofer

Wireline connection

Connect the monaural input jack on your subwoofer to the SUBWOOFER jack on this unit.

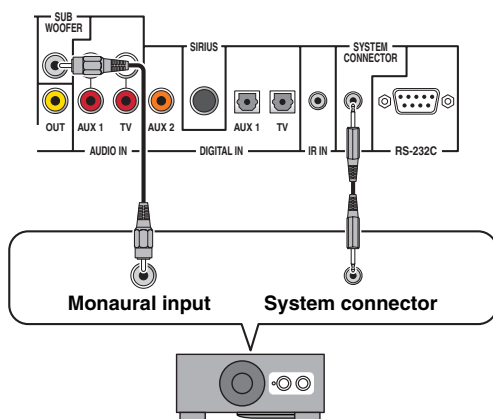

- If the subwoofer is connected by using a system type connection, changing the power mode of this unit controls the power mode of the subwoofer (Yamaha subwoofer).

Wireless connection

You can make a wireless connection of your subwoofer by using the Yamaha wireless subwoofer kit (SWK-W10). About SWK-W10, refer to “Safety and Accessory Information” (separate booklet). See also: “WIRELESS SETUP” (page 39)

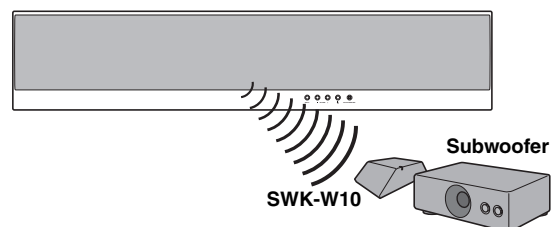

- For proper transmission, you need to set the group IDs of this unit and SWK-W10 to the same value. For the Group ID settings, refer to “Group ID” (page 39) and “Safety and Accessory Information (separate booklet)”.

Note

- Be sure to use the product only in the country in where it was purchased.

Connecting the FM antenna

Connect the supplied FM antenna or your antenna to the FM ANTENNA jack on this unit.

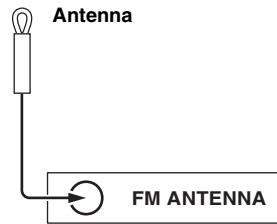

Preparing the remote control

Note

- Before installing batteries or using the remote control, make sure that you read precautions on the remote control and batteries in "Safety and Accessory Information" (separate booklet).

Installing batteries in the remote control

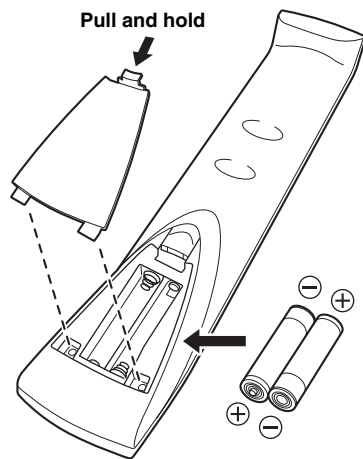

Operation range of the remote control

The remote control transmits a directional infrared beam. Use the remote control within 6 m (20 ft) of this unit and point it toward the remote control sensor of this unit during operation.

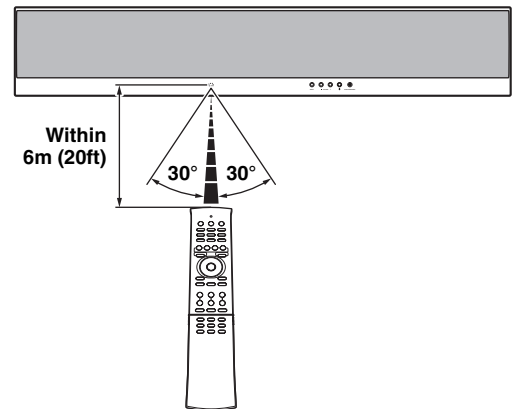

- 1 Pull and hold the tab on the battery cover and then open the cover.**
- 2 Insert the two supplied batteries (R03P, UM4, AAA) into the battery compartment.**
Make sure you insert the batteries according to the polarity markings (+/-).
- 3 Close the battery cover.**

ⒸENTER
Ⓒ△ / ▽
ⒾSETUP

Changing OSD language

You can select an OSD language among English, German, French, Spanish, Italian, Dutch and Russian. Before operating the following steps, select this unit as the video input on your TV.

- 1 Press and hold **⓪** **SETUP** until the “LANGUAGE SETUP” menu appears on your TV.



- 2 Press **⊕** / **⊖** to select the desired language and then press **⓪** **ENTER**.

Choices: ENGLISH (English), DEUTSCH (German), Français (French), ESPAÑOL (Spanish), ITALIANO (Italian), NEDERLANDS (Dutch), Русский (Russian)

Initial setting: ENGLISH (English)

- 3 To exit from the menu, press **⓪** **SETUP**.

Changing OSD language

AUTO SETUP (IntelliBeam)

Using the system memory

AUTO SETUP (IntelliBeam)

This unit creates a sound field by reflecting sound beams off the walls of your listening room and by broadening the cohesion of all the channels. Just as you would arrange the speaker position of other audio systems, you need to set the beam angle to enjoy the best possible sound from this unit.

Notes

- After you have completed the AUTO SETUP procedure, be sure to disconnect the IntelliBeam microphone.
- The IntelliBeam microphone is sensitive to heat.
 - Keep the IntelliBeam microphone away from direct sunlight.
 - Do not place the IntelliBeam microphone on top of this unit.
- You cannot use the AUTO SETUP when “PREOUT” is selected in “SOUND OUT” (page 38).
- You cannot run the AUTO SETUP while playing back the iPod/iPhone by using PDX-50TX. To run the AUTO SETUP, stop playback and then disconnect the iPod/iPhone from PDX-50TX. About PDX-50TX, refer to “Safety and Accessory Information” (separate booklet).

Installing the IntelliBeam microphone

Follow the procedure below to connect the IntelliBeam microphone to this unit and place it in a proper location.

- 1 Connect the supplied IntelliBeam microphone to the INTELLIBEAM MIC jack on the front panel.

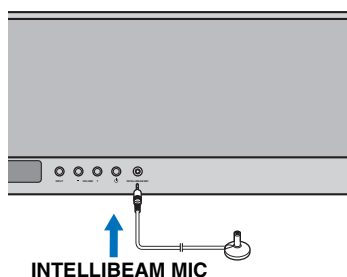

- Use the supplied cardboard microphone stand or a tripod to place the IntelliBeam microphone at the same height as your ears would be when you are seated.

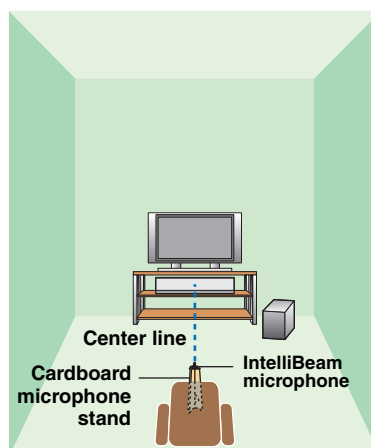
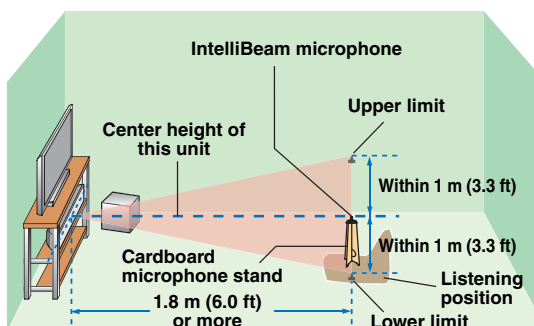

- 2 Place the IntelliBeam microphone on a flat level surface at your normal listening position.

Place the IntelliBeam microphone on the extended center line of this unit and 1.8 m (6.0 ft) or more away from it. Also, make sure place the IntelliBeam microphone within 1 m (3.3 ft) upper or lower from the center height of this unit.

■ Assembling the supplied cardboard microphone stand

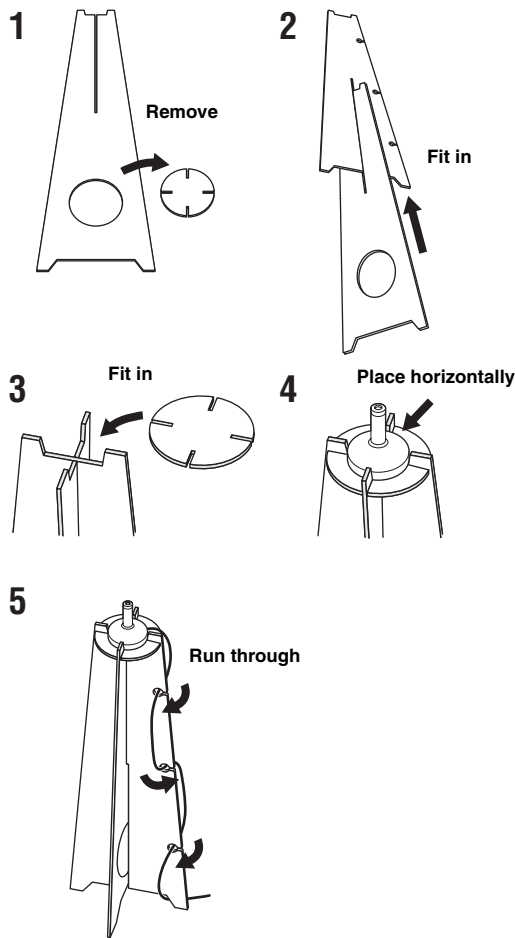
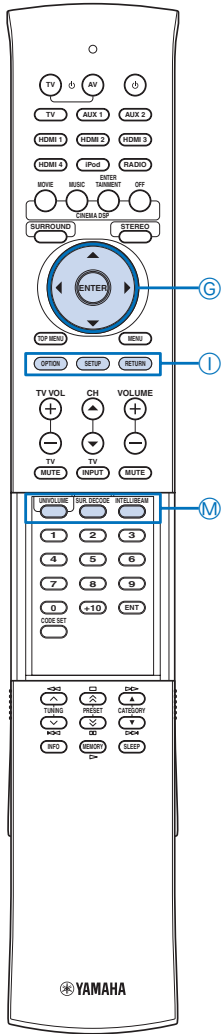

- If a subwoofer with adjustable volume and crossover frequency controls is connected to this unit, turn it on, set the volume to about half way and then set the crossover frequency to the maximum as shown below.

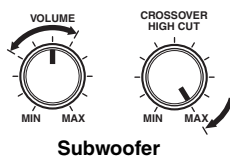

Using AUTO SETUP (IntelliBeam)

You can select one of the following AUTO SETUP types depending on your purpose.

“BEAM+SOUND OPTIMZ”

(Beam optimization and sound optimization)

Use to optimize the beam angle, delay, volume, and quality so that the parameters best match your listening environment. It is recommended that you should select this optimization feature in the following cases:

- If you make settings for the first time
- If the unit has been relocated
- If your listening room has been restructured
- If the objects in your listening room (furniture, etc.) have been rearranged

This menu takes about three minutes.

- ⓐENTER
- ⓐ△ / ▽
- ⓐRETURN
- ⓐSETUP
- ⓐINTELLIBEAM

“BEAM OPTIMZ ONLY”

(Beam optimization only)

Use to optimize the beam angle so that the parameter best matches your listening environment. This menu takes about one minute.

“SOUND OPTIMZ ONLY”

(Sound optimization only)

Use to optimize the beam delay, volume, and quality so that the parameters best match your listening environment. You must optimize the beam angle with “BEAM OPTIMZ ONLY” before starting “SOUND OPTIMZ ONLY”. It is recommended that you should select this optimization feature in the following cases:

- If you have opened or closed the curtains in your listening room before using this unit
- If you have manually set the beam angle.

This menu takes about three minutes.

Notes

- It is normal for loud test tones to be output during the AUTO SETUP procedure. Make sure that there are no children around in the listening room while the AUTO SETUP procedure is in progress.
- Make sure that your listening room is as quiet as possible. For accurate measurement, turn off air conditioner or other devices that make noises.
- To achieve the best results possible, vacate your listening room until the AUTO SETUP procedure is completed so that you may not obstruct the path of sound beams.
- If there are curtains in your listening room, we recommend following the procedure below.
 1. Open the curtains to improve sound reflection.
 2. Run “BEAM OPTIMZ ONLY”.
 3. Close the curtains.
 4. Run “SOUND OPTIMZ ONLY”.



- To return to the previous screen while using SET MENU, press ⓐRETURN.

1 Press ⓐSETUP.

The remote control keys to be used and available operations in each step are displayed at the bottom of the screen.



- You can also start the “BEAM+SOUND OPTIMZ” procedure simply by holding down ⓐINTELLIBEAM for more than two seconds. In this case, proceed to step 4.

- 2** Press \odot \triangle / ∇ to select “AUTO SETUP” and then press \odot ENTER.



- 3** Press \odot \triangle / ∇ to select “BEAM+SOUND OPTIMZ”, “BEAM OPTIMZ ONLY” or “SOUND OPTIMZ ONLY” and then press \odot ENTER.



- 4** Prepare to leave the room.

The best setting may not be done if you are in the room. Prepare to leave the room in 10 seconds after pressing \odot ENTER in step 5.



- Wait outside the room during the AUTO SETUP procedure.
- The AUTO SETUP procedure takes about 3 minutes.
- To cancel the AUTO SETUP procedure after it is started, press $\textcircled{1}$ RETURN.

- 5** Press \odot ENTER to start the AUTO SETUP procedure and then leave the room within 10 seconds.



The setup screen automatically changes during the AUTO SETUP procedure.

If an error occurs, an error buzzer sounds and an error message is displayed. For details on error messages, see “Error messages for AUTO SETUP” (page 18).

If the AUTO SETUP procedure is complete, this unit rings the chimes.

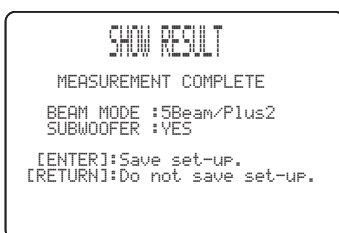

- If “ENVIRONMENT CHECK [FAILED]” is displayed, refer to “Error messages for AUTO SETUP” (page 18), press $\textcircled{1}$ RETURN, and then run the AUTO SETUP procedure again.
- If “SUBWOOFER :NOT APPLICABLE” is displayed even though a subwoofer is connected to this unit and turned on, check the connection and then increase the volume level of the subwoofer and run the AUTO SETUP procedure again.
- Depending on the environment of your listening room, the beam angles of front right and left and surround left and right may be set to the same value even if “BEAM MODE :5 BEAM” is displayed as a result.

- 6** Press \odot ENTER to confirm the results.

The menu screen disappears in two seconds.



- If you do not want to reflect the results, press $\textcircled{1}$ RETURN.

- 7** Disconnect the IntelliBeam microphone.

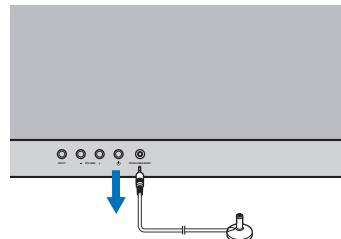

The measurement results are stored in the internal memory of this unit until you run the AUTO SETUP procedure again or configure the settings manually.

Changing OSD language

AUTO SETUP (IntelliBeam)

Using the system memory

■ Error messages for AUTO SETUP

If an error message is displayed on your TV, check the error message list to solve the problem and then follow the procedure below.

[ERROR E-1]: Press **Ⓒ**ENTER to run the AUTO SETUP procedure again or **Ⓓ**RETURN to cancel the operation
Other errors: Press **Ⓓ**RETURN to cancel the operation and then run the AUTO SETUP procedure again.

Note

If the problem is difficult to be solved, configure the settings manually in “MANUAL SETUP” (page 34).

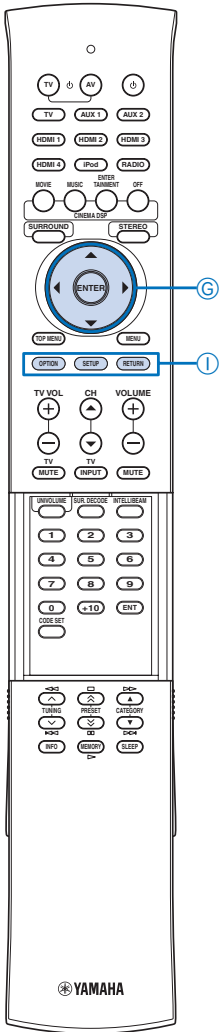

Error message	Cause	Remedy	See page
ERROR E-1 Please test in quieter environment.	There is too much unwanted noise in your listening room.	Make sure that your listening room is as quiet as possible. You may want to choose certain hours during the day when there is not much noise coming from outside.	—
ERROR E-2 No MIC detected. Please check MIC connection and re-try.	The IntelliBeam microphone is not connected to this unit or disconnected during the AUTO SETUP procedure.	Connect the IntelliBeam microphone to this unit firmly.	15
ERROR E-3 Unexpected control is detected. Please re-try.	Some other operations were performed on this unit while the AUTO SETUP procedure was in progress.	Do not perform any other operations while the AUTO SETUP procedure is in progress.	—
ERROR E-4 Please check MIC position. MIC should be set in front of the unit and re-try.	The IntelliBeam microphone is not placed in front of this unit.	Make sure that the IntelliBeam microphone is installed in front of this unit.	15
ERROR E-5 Please check MIC position. MIC should be set above 1.8m/6.0ft and re-try.	The IntelliBeam microphone is not placed in the right distance from this unit.	Make sure that the IntelliBeam microphone is installed more than 1.8 m (6.0 ft) from the front of this unit and within 1 m (3.3 ft) from the center height of this unit.	15
ERROR E-6 Volume level is lower than expected. Please check MIC position/connection and re-try.	The IntelliBeam microphone cannot collect the sound produced by this unit because the sound output level is too low.	Make sure that the IntelliBeam microphone is firmly connected to this unit and placed in a proper location. If the problem persists, contact the nearest authorized Yamaha service center for assistance.	15
ERROR E-7 Unexpected error happened. Please re-try.	An internal system error occurred.	Repeat the AUTO SETUP procedure.	—

ⒸENTER

Ⓒ△ / ▽

ⒹRETURN

ⒹSETUP

Using the system memory

You can save the current beam and sound settings in the system memory of this unit. It is handy to save certain settings according to the varying conditions of your listening environment. For example, if there are curtains in the path of sound beams, the effectiveness of the sound beams will vary depending on whether the curtains are open or closed.



- If there are curtains in your listening room, we recommend following the procedure below.
 - While the curtains are open, run "BEAM+SOUND OPTIMZ" (page 16) and then save the settings to "MEMORY1".
 - While the curtains are closed, run "SOUND OPTIMZ ONLY" (page 16) and then save the settings to "MEMORY2".

Saving settings

1 Press **⓪**SETUP.



2 Press **⓪**ENTER.

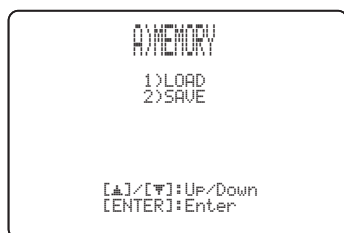

3 Press **⓪** ▲ / ▼ to select "SAVE" and then press **⓪**ENTER.



4 Press **⓪** ▲ / ▼ to select the desired memory number and then press **⓪**ENTER.



5 Press **⓪**ENTER.

The current beam and sound settings are saved to the selected memory number.



Loading settings

1 Press **⓪**SETUP.



2 Press **⓪**ENTER.

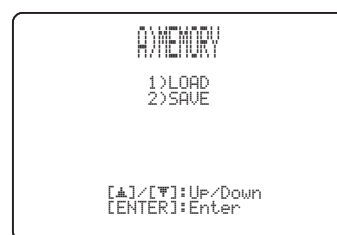

3 Press **⓪**ENTER again.

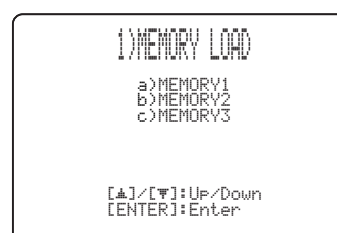

- If system settings are already stored in the selected memory number, this unit overwrites the old settings.

Changing OSD language

AUTO SETUP (IntelliBeam)

Using the system memory

-
- 4** Press **ⓐ** **▲** / **▼** to select the memory number to be loaded and then press **ⓐ**ENTER.

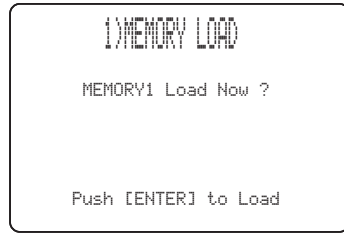
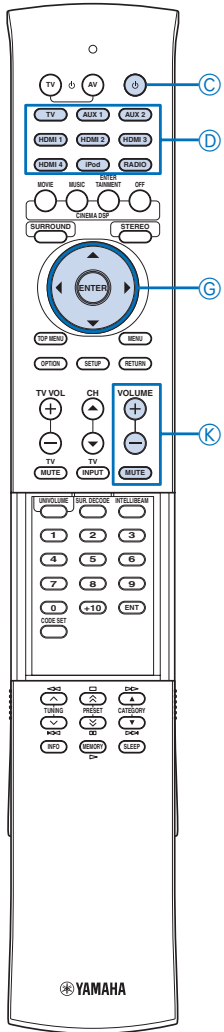

-
- 5** Press **ⓐ**ENTER.
The beam and sound settings saved in the selected memory number are loaded.



- ⓐPower
- ⓓAUX1/2
- ⓓHDMI1
- ⓓHDMI1-4
- ⓓInput selector keys
- ⓓTV
- ⓐENTER
- ⓐ▲ / ▼
- ⓐMUTE
- ⓐVOLUME +/-

PLAYBACK FEATURES

Playback

Playing back sources

This section describes how to playback source input from your external components. For details on your external components, refer to the owner's manual supplied with each component.

- 1 Press **Ⓞ**Power (**⏻**) key to turn on this unit.
- 2 Turn on external components (TV, Blu-ray disc player, etc.) connected to this unit.
- 3 Press one of the **Ⓞ**Input selector keys to select an external component as an input source.

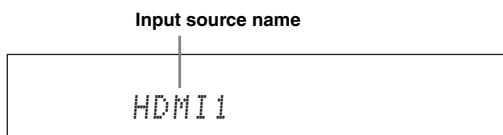

- You can change the input source name displayed on the front panel display (page 38).

- 4 Start playback of the external component that you have selected as the input source, or select a radio station on the tuner.
 - FM tuning (page 25)
 - Playing back iPod/iPhone (page 30)

- 5 Press **Ⓞ**VOLUME +/- to adjust the volume.

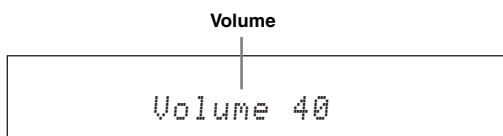

- 6 Press **Ⓞ**Power (**⏻**) key to turn this unit to the standby mode.

Playing back TV sounds

- 1 Select the desired TV channel.
- 2 Press **Ⓞ**TV to select the TV as the input source.
- 3 Mute the sound output on the TV.

Playing back a player

- 1 Select the player as the video input on the TV.
- 2 Press **Ⓞ**HDMI1-4 or **Ⓞ**AUX1/2 to select the player as the input source.
For example, if the player is connected to the HDMI IN 1 jack of this unit, press **Ⓞ**HDMI1.
- 3 Start playback of the player.
- 4 Mute the sound output on the TV.



- If your player supports the HD audio, check whether the audio output setting on the player is set to the value which supports HD audio output ("Auto", "Bitstream", etc.).
- If your player does not support the HD audio, check whether the audio output setting on the player is set to multi-channel linear PCM.
- If your player is connected to this unit through the digital connection, check whether the audio output setting on the player is set to digital output ("Bitstream", "Dolby Digital", "DTS", etc.).
- To enhance the surround sound effect, set the audio setting of your player to the multi-channel audio mode.
- You can use the supplied demonstration DVD to check the digital signals being input from the player through the digital connection (HDMI, optical or coaxial). The **DIGITAL** indicator lights up when this unit detects the digital audio signal input.

Muting audio output

- 1 Press **Ⓞ**MUTE to mute the audio output.
- 2 Press **Ⓞ**MUTE again to resume audio output.

Decoder and input channel indicators

■ Decoder indicators

Depending on the input source and the selected decoder, the indicators in the front panel display light up as follows:

Changing OSD language

AUTO SETUP (IntelliBeam)

Using the system memory

Playback

Playback mode

FM tuning

SIRIUS Satellite Radio™ tuning

Playing back iPod™

Useful features

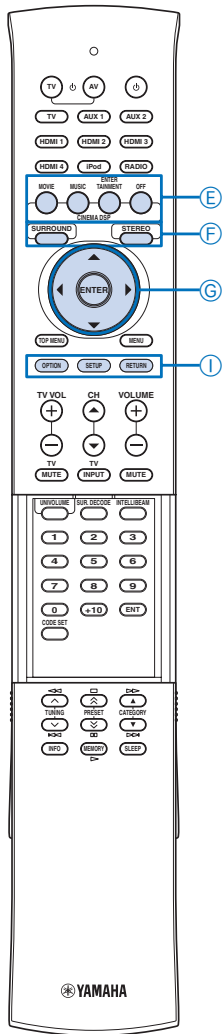

Status	Indicator
When PCM signals are being input	PCM
When Dolby TrueHD signals are being input	TRUE HD
When Dolby Digital Plus signals are being input	DIGITAL PLUS
When Dolby Digital signals are being input	DIGITAL
When Dolby Pro Logic is selected as the surround decoder	PL
When Dolby Pro Logic II is selected as the surround decoder	PL II
When Dolby Pro Logic IIx is selected as the surround decoder	PL IIx
When DTS HD Master Audio signals are being input	dts + HD + MSTR
When DTS HD High Resolution signals are being input	dts + HD + HI RES
When DTS digital signals are being input	dts
When DTS 96/24 signals are being input	dts + 96/24
When DTS ES discrete is selected as the surround decoder	dts + ES + DSCRT
When DTS ES matrix is selected as the surround decoder	dts + ES + MTRX
When DTS Neo:6 is selected as the surround decoder	dts + Neo:6



- You can select an audio signal to be played back (Auto or DTS) In “Decoder Mode” (page 32).

Input channel indicators

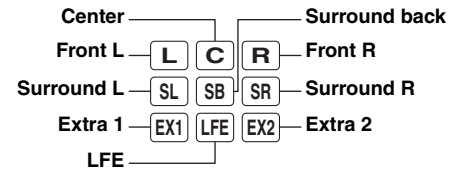

Depending on the channel component of the current digital input signal, the input channel indicators in the front panel display light up as follows:

Input signal	Indicator
2-channel stereo	L R
5.1-channel	L C R SL SB SR LFE
6.1-channel	L C R SL SB SR LFE
7.1-channel	L C R SL SR EX1 LFE EX2



- Extra (EX1/EX2) indicators light up when 7.1-channel signals recorded in a Blu-ray disc (etc.) are being input. Normally, surround back channel signals are recorded in the extra channels. This may vary depending on the disc.

Playback mode

You can select the playback method (surround or stereo), desired CINEMA DSP program and decoder to enjoy playback of the input source.

Selecting surround or stereo playback

Use to select the playback method (surround or stereo). See also: “Enjoying CINEMA DSP programs” (page 22), “Changing the audio output method for surround playback” (page 23).

Press **ⓔ**SURROUND or **ⓕ**STEREO.

You can enjoy high realistic sensation with surround playback and hi-fi sound with stereo playback.



- Normal sounds (not sound beams) are output from the front right and front left channels. When you play back multi-channel sources, all signals except those from the front right and left channels are mixed down and output from the front right and left channels.
- When the stereo playback is selected, CINEMA DSP (page 22) and the decoder (page 24) become ineffective.

Enjoying CINEMA DSP programs

This unit is equipped with a Yamaha CINEMA DSP

(digital sound field processing) chip containing several sound field programs used to enhance your playback experience. Most of the CINEMA DSP programs are precise digital recreations of actual acoustic environments of famous concert halls, music venues, and movie theaters.



- When you enjoy the CINEMA DSP programs, press **ⓔ** SURROUND to select the surround playback, and then follow the steps below.
- The CINEMA DSP programs are not available in the following conditions.
 - Stereo playback is selected.
 - HD audio signals are being played back.
 - Audio signals with sampling frequency of higher than 96 kHz are being played back.
 - Audio signals are output from the PRE OUT jacks.

- ⓔCINEMA DSP
- ⓔOFF
- ⓕSTEREO
- ⓕSURROUND
- ⓖENTER
- ⓖ ▲ / ▼
- ⓖ ◀ / ▶
- ⓖ ▼
- ⓇSETUP

1 Press the desired CINEMA DSP key.

The CINEMA DSP category name appears in the front panel display and the CINEMA DSP indicator (page 7) lights up.

2 While the category name is displayed, press the CINEMA DSP key repeatedly.

Each time you press the key, program switches.



- To turn off the CINEMA DSP program, press OFF .

Movie (MOVIE)**Sci-Fi**

This program clearly reproduces dialogs and special sound effects of the latest science fiction films and lets you feel a broad and expansive cinematic space.

Adventure

This program reproduces the thrilling environment of the latest action films and lets you feel the dynamic and excitement of fast-moving scenes.

Spectacle

This program reproduces the wide and grand environment and lets you have added impressions on spectacular scenes with strong visual impacts.

Music (MUSIC)**Music Video**

This program produces a vibrant environment and lets you feel as if you are at an actual jazz or rock concert.

Concert Hall

This program creates a rich surround effect of a large round concert hall with a great deal of presence, emphasizing the extension of sounds, and lets you feel as if you are seated close to the center of the stage.

Jazz Club

This program recreates the acoustic environment of "The Bottom Line", a famous jazz club in New York once and lets you feel as if you are seated right in front of the stage.

Entertainment (ENTERTAINMENT)**Sports**

This program reproduces the energetic environment of live sports broadcasting, converging a commentator's voice on the center and broadening the overall atmosphere of the stadium, and lets you feel as if you are seated at an actual stadium or a ball park.

Talk Show

This program reproduces excitement of live talk shows. It enhances the ambience of gaiety while keeping the conversations at a comfortable volume.

Drama

This program stables reverberations that match a wide range of movie genres from serious dramas to musicals and comedies, and offers an optimum 3D feeling, reproducing effects tones and background music softly but cubically around clear words.

Game

This program is suitable for role-playing and adventure games. It utilizes the sound field effects for movies to represent the depth and spatial feeling of the field during play, while offering movie-like surround effects in the movie scenes in the game.

Mch Stereo

This program downmixes multi-channel source to 2 channels and then outputs the sound from all speakers and produces stereo sounds in wide range. It is ideal for background music at parties, etc.

Changing the audio output method for surround playback

You can set the number of beam output channels and audio output method.

1 Press SETUP .

The "SET MENU" screen appears on the TV.

2 Use CINEMA DSP \uparrow / \downarrow and ENTER to select "SOUND OUT MENU"- "SOUND BEAM OUT CONFIG" - "CHANNEL OUT".**3 Press CINEMA DSP \leftarrow / \rightarrow to select the number of output channels.**

Choices: 5.1ch, 7.1ch
Initial setting: 7.1ch

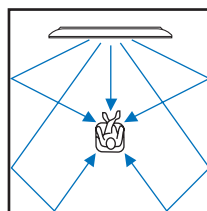
4 Press CINEMA DSP \downarrow to select "BEAM MODE".**5 Press CINEMA DSP \downarrow to select the desired audio output method.****6 To exit from the menu, press SETUP .****Beam modes for "5.1ch"****5Beam**

Outputs sound beams from the front right and left, center, and surround right and left channels. This mode is ideal for enjoying surround sound effects to the fullest when you watch 5.1-channel audio discs.

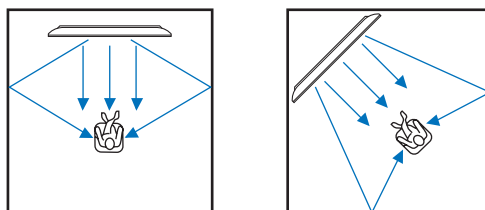
Stereo+3Beam

Outputs normal sound from the front right and left channels and sound beams from the center and surround right and left channels. This mode is ideal for watching live recordings on a DVD.

Playback

Playback mode

FM tuning

SIRIUS Satellite
Radio™ tuning

Playing back iPod™

Useful features

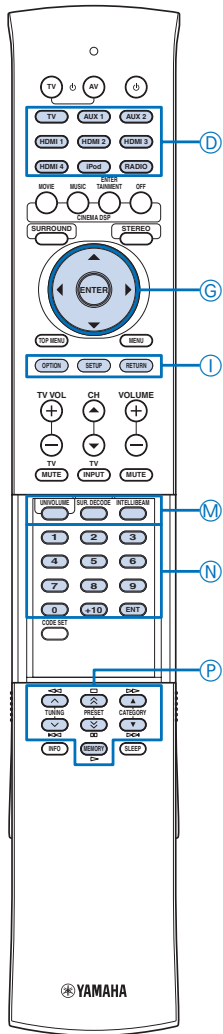

3 Beam

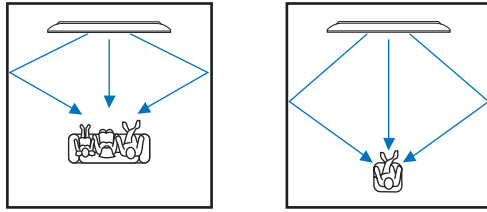

Outputs sound beams from the front right and left and center channels. For playback of multi-channel sources, surround right and left channel sources are mixed into the front right and left channels. This mode is ideal for enjoying movies with the whole family. In addition, you can use this mode when the listening position is close to the backside of the wall.

■ Beam modes for "7.1ch"

5BeamPlus2

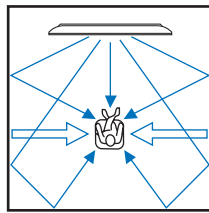

Outputs sound beams from the front right and left, center, and surround back right and left channels. Surround right and left channel sources are mixed into the front right and left and surround back right and left channels. This mode is ideal for enjoying surround sound effects to the fullest when you watch 7.1-channel audio discs.

ST+3BeamPlus2

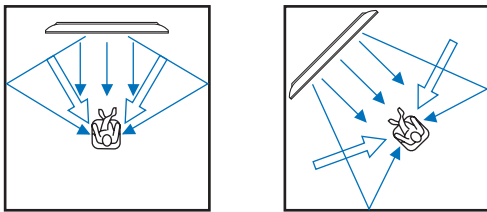

Outputs normal sound from the front right and left channels and sound beams from the center and surround back right and left channels. Surround right and left channel sounds are output by using front right and left channel sound and surround back right and left sound beams. This mode is ideal for watching live recordings on a DVD.

3 Beam

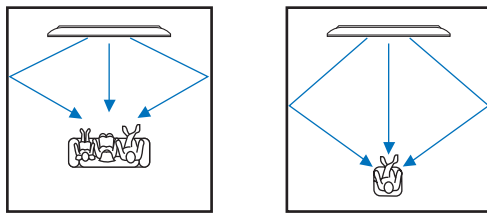

Outputs sound beams from the front right and left and center channels. For playback of multi-channel sources, surround right and left and surround back right and left channel sources are mixed into the front right and left channels. This mode is ideal for enjoying movies with the whole family. In addition, you can use this mode when the listening position is close to the backside of the wall.

- Ⓧ RADIO
- Ⓞ ENTER
- Ⓞ ▲ / ▼
- Ⓛ OPTION
- Ⓛ RETURN
- Ⓞ SUR.DECODE
- Ⓞ Numeric keys
- Ⓞ TUNING ▲ / ▼
- Ⓞ MEMORY

Enjoying 2-channel sources in surround sound

This unit can decode 2-channel sources for 7.1-channel or 5.1-channel playback so that you can enjoy a variety of surround sound effects by switching the decoder.



- The decoders are available only when surround playback (page 22) is selected.
- Available decoders vary depending on the "CHANNEL OUT" setting (page 23).

Press **SUR.DECODE** repeatedly to switch between decoders.

2ch → 5ch

Decoder		Recommended source
Pro Logic (Dolby Pro Logic)	—	All sources
PLII (Dolby Pro Logic II)	Movie Music Game	Movies Music Games
Neo:6 (DTS Neo:6)	Cinema Music	Movies Music

2ch → 7ch

Decoder		Recommended source
PLIIx (Dolby Pro Logic Iix)	Movie Music Game	Movies Music Games
Neo:6 (DTS Neo:6)	Cinema Music	Movies Music

Playing back 5.1-channel sources in 7.1-channel surround

This unit decodes 5.1-channel sources and then playback them in up to 7.1-channel surround. One of the following decoders is automatically selected depending on the input signals. Set "CHANNEL OUT" to "7.1ch" (page 23).

5.1ch input source	Decoder
PCM, Dolby Digital, Dolby Digital EX, Dolby TrueHD, Dolby Digital Plus	Dolby Pro Logic Iix Movie/Music
DTS Digital, DTS ES matrix, DTS HD Master Audio, DTS HD High Resolution Audio	DTS ES matrix
DTS ES discrete	DTS ES discrete



- Press **SUR.DECODE** to switch between Dolby Pro Logic Movie and Music. To switch to the Dolby Pro Logic Iix Music decoder, select "PLIIxMusic". To switch to the Dolby Pro Logic Iix Movie decoder, select one of the decoders other than "PLIIxMusic".

FM tuning

The FM tuner of this unit provides the following two modes for tuning.

• Frequency tuning mode

You can tune into a desired FM station by searching or specifying its frequency.

• Preset tuning mode

You can preset the frequencies of FM stations by registering them to specific numbers, and later just select those numbers to tune into.

Note

Adjust the FM antenna connected to this unit for the best reception.

Tuning into the desired FM station (Frequency tuning)

1 Press **RADIO** repeatedly to select “FM”.

Note

- If you select “FM” with INPUT on the front panel, press **RADIO** on the remote control prior to step 2 so that you can operate the procedures from step 2.

2 Press **TUNING** \wedge / \vee to specify the frequency.

The TUNED indicator on the front panel display lights up when the tuner is tuned into a station. The STEREO indicator also lights up if the program being broadcasted is in stereo.

See also: “FM Mode” (page 32)

Lights up



The frequency changes in the following manner according to how you press **TUNING** \wedge / \vee .

When you press the key more than 1 second

The tuner searches the frequency of a station that is detectable around the current frequency. This is effective when the tuner can receive strong signals without any interference. Once the search starts, release the key. When you keep holding the key, the search continues even when a station is detected. This is useful when you want to tune in to a specific station.

When you press and release the key

The tuner increases or decreases the frequency in steps. Use this method when the tuner cannot receive strong signals and stations are skipped during the search.

3 To directly specify the frequency, use **NUMERIC** keys to enter the frequency of the station.

Enter only integers. For example, if you want to set the frequency to 88.9 MHz, enter “889”.

Note

- When you press **NUMERIC** keys during preset tuning, a preset number is selected. Set the tuner to the frequency tuning mode using **TUNING** \wedge / \vee prior to the operation.



- The reception is noisy and the sound is hard to listen, switch to monaural mode to get better reception. In the option menu, select “Mono” in “FM Mode” (page 32).

Registering FM stations and tuning in (Preset tuning)

You can register up to 40 FM stations automatically or manually.

■ Registering stations automatically

The tuner automatically detects FM stations with strong signals and registers up to 40 stations.

1 Press **RADIO** repeatedly to select “FM”.

2 Press **OPTION**.

The option menu (page 32) appears on the front panel display.

3 Press **ENTER** \triangle / ∇ to select “Auto Preset” and then press **ENTER**.

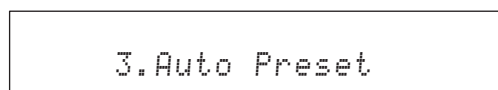

This unit starts to preset FM radio stations in 5 seconds.

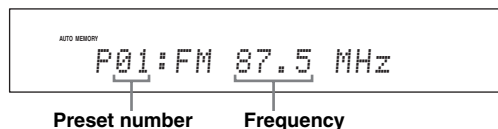

- You can select the preset number at which the preset starts by pressing **ENTER** \triangle / ∇ after pressing **ENTER**.
- To cancel the operation, press **RETURN**.

If auto preset is complete, “Preset Complete” appears.

4 To exit from the menu, press **OPTION**.

■ Registering stations manually

You can manually register FM stations with weak signals.

1 Tune into the desired FM station.

2 Press **MEMORY**.

“Manual Preset” appears on the front panel display, followed soon by the preset number to which the station will be registered.



- By holding down **MEMORY** for more than 2 seconds, you can skip the following steps and automatically register the selected station to an empty preset number (next to the lastly-registered preset number).

Playback

Playback mode

FM tuning

SIRIUS Satellite Radio™ tuning

Playing back iPod™

Useful features

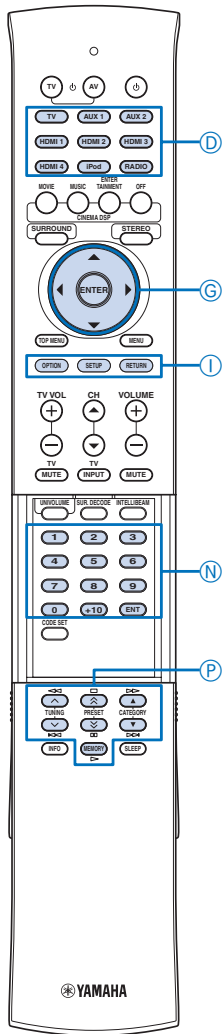

3 Press \textcircled{P} PRESET \wedge / \vee to select the preset number to which the station will be registered.
When you select a preset number to which no station is registered, "Empty" appears. When you select a preset number to which any station has been already registered, the frequency of the station is displayed.

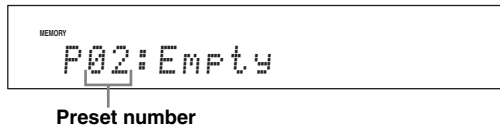

- You can also specify a preset number using the \textcircled{N} Numeric keys.

4 Press \textcircled{P} MEMORY.
When registration is complete, the front panel display returns to the original state.

- To cancel registration, press \textcircled{I} RETURN or leave this unit without any operations for about 30 seconds.

■ Calling a preset station (Preset tuning)
You can call preset stations registered automatically or manually.

Press \textcircled{P} PRESET \wedge / \vee to select the desired preset number.

- Preset numbers to which no stations are registered are skipped.
- "No Presets" is displayed if no stations are registered.

- You can directly select a preset number by pressing the \textcircled{N} Numeric keys while calling a preset station.
- When you press \textcircled{N} Numeric keys during normal frequency tuning, a frequency is entered. Set the tuner to the preset tuning mode using \textcircled{P} TUNING \wedge / \vee prior to the operation.

■ Clearing preset stations

Use to clear the preset FM stations.

1 Press \textcircled{D} RADIO repeatedly to select "FM".

2 Press \textcircled{I} OPTION.

The option menu (page 32) appears on the front panel display.

3 Press \textcircled{G} \triangle / ∇ to select "Clear Preset" and then press \textcircled{G} ENTER.

A preset station is displayed.

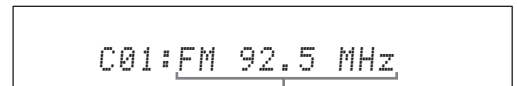

- To cancel the clearing operation, press \textcircled{I} RETURN.

4 Press \textcircled{G} \triangle / ∇ to select a preset station to be cleared, and then press \textcircled{G} ENTER.

The selected preset station is cleared. If the operation is completed, "Cleared" appears. To clear the multiple preset stations, repeat step 4.

5 To exit from the menu, press \textcircled{I} OPTION.

- \textcircled{D} RADIO
- \textcircled{G} ENTER
- \textcircled{G} \triangle / ∇
- \textcircled{I} OPTION
- \textcircled{I} RETURN
- \textcircled{N} Numeric keys
- \textcircled{N} 0
- \textcircled{N} ENT
- \textcircled{P} CATEGORY \triangle / ∇
- \textcircled{P} MEMORY
- \textcircled{P} PRESET \wedge / \vee
- \textcircled{P} TUNING \wedge / \vee

SIRIUS Satellite Radio™ tuning

Listening to Satellite Radio

To listen to Satellite Radio, you'll need to connect a SIRIUS Satellite Radio tuner (sold separately) to your Sirius-Ready receiver. SIRIUS Satellite Radio is available to residents of the US (except Alaska and Hawaii) and Canada.

Satellite Radio delivers a variety of commercial-free music from categories ranging from Pop, Rock, Country, R&B, Dance, Jazz, Classical and many more plus coverage of all the top professional and college sports including play by play games from select leagues and teams. Additional programming includes expert sports talk, uncensored entertainment, comedy, family programming, local traffic and weather and news from your most trusted sources.

Once you've purchased a SIRIUS tuner you'll need to activate it and subscribe to begin enjoying the service. Easy to follow installation and setup instructions are provided with the SIRIUS tuner. There are a variety of programming packages available, including the option of adding "The Best of XM" programming to the SIRIUS service. The "Best of XM" service is not available to SIRIUS Canada subscribers at this time. Please check with SIRIUS Canada for any updates using the numbers and web address below.

Family friendly packages are also available to restrict channels featuring content that may be inappropriate for children.

To subscribe to SIRIUS, U.S. and Canadian customers can call 1-888-539-SIRI (1-888-539-7474) or visit sirius.com (US) or siriuscanada.ca (Canada).

Connecting the SiriusConnect™ tuner

Connect the SiriusConnect tuner (sold separately) to the SIRIUS jack on the rear panel of this unit. For details, see the operating instructions provided with the SiriusConnect tuner.

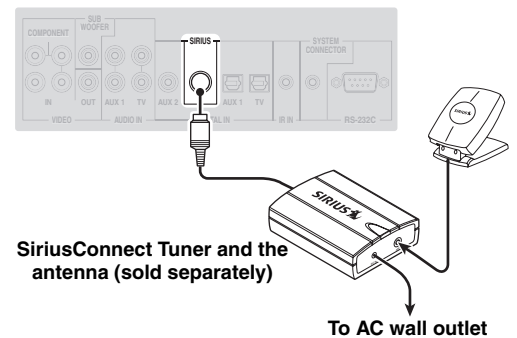



- To ensure optimal reception of the SIRIUS Satellite Radio signals, the antenna of the SiriusConnect tuner must be placed at or near a window with no obstacles in the path to the sky. The orientation of the antenna for the best reception differs depending on the area. Refer to the instruction manuals supplied with the SiriusConnect tuner for the installation of the antenna. You can mount it indoors or outdoors.
- Use the “Antenna Level” information in the front panel display (page 30) to check the antenna reception level and adjust the orientation of the antenna.
- You need to connect the SiriusConnect tuner to an AC wall outlet.

Note

- If “ANTENNA ERR” appears on the front panel display, the connection of the SiriusConnect tuner or antenna is incorrect. In such cases, check the connection of the SiriusConnect tuner and the antenna.

Activating SIRIUS Satellite Radio™ subscription

Before using the SIRIUS Satellite Radio feature, you need to activate your SIRIUS Satellite Radio subscription. To activate the subscription you need the Sirius ID which is uniquely assigned to the SiriusConnect tuner. Sirius ID is 12-digit number and it appears on the package of the SiriusConnect tuner, on the label of the SiriusConnect tuner, and when you tune into the SIRIUS Satellite Radio channel “0” (see below).

■ Displaying the Sirius ID of your SiriusConnect tuner

1 Press \textcircled{R} RADIO repeatedly to select “SIRIUS”.

2 Press $\textcircled{0}$ 0 and then \textcircled{N} ENT to display the Sirius ID of your SiriusConnect tuner.

“000 Sirius ID” and “xxxxxxxxxxxx” (“xxxxxxxxxxxx” indicates the 12-digit Sirius ID of your SiriusConnect tuner) appears on the front panel display.

Write the Sirius ID below.

ID: _____

3 Contact SIRIUS Satellite Radio to activate your subscription.

SIRIUS Satellite Radio online information

Contact for activation
 URL: <https://activate.siriusradio.com/>
 Phone: 1-888-539-SIRIUS (1-888-539-7474)



- Status messages appear on the front panel display during the activation. For details, see “SIRIUS Satellite Radio” (page 44). Once the activation is finished, “SUB UPDATED” appears.

SIRIUS Satellite Radio™ operations

1 Press \textcircled{R} RADIO repeatedly to select “SIRIUS”.

The SIRIUS indicator lights up on the front panel display and the SIRIUS Satellite Radio information for the currently selected channel appears on the front panel display.

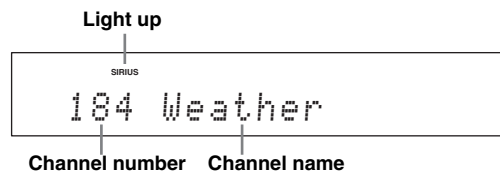

- When you select “SIRIUS” as the input source, this unit automatically recalls the previously selected channel.

Notes

- When you have not activated your subscription yet, you can only select “184” or “000”.
- If a status message or an error message appears on the front panel display, see “SIRIUS Satellite Radio” (page 44).

2 Search for a channel by using one of the SIRIUS Satellite Radio search modes.

- To select a channel from the all channel list, see “All Channel Search mode” on this page.
- To select a channel by category, see “Category Search mode” on this page.
- To select the desired channel directly by entering the channel number, see “Direct number access” on this page.
- To select a channel from the preset channels, see “Calling a preset channel (Preset Search mode)” (page 28).



- You can display the SIRIUS Satellite Radio information on the front panel display (page 30).
- You can set the SIRIUS Satellite Radio preset channels (page 28).

■ All Channel Search mode

Press \textcircled{T} TUNING \wedge / \vee repeatedly to search for a channel within all channels.

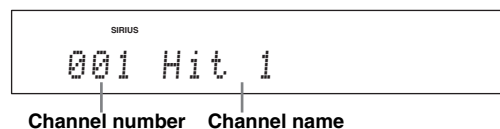

- You can search for a channel quickly by holding down \textcircled{T} TUNING \wedge / \vee .
- You can skip channels to the previous or next category by pressing \textcircled{C} CATEGORY \triangle / ∇ .

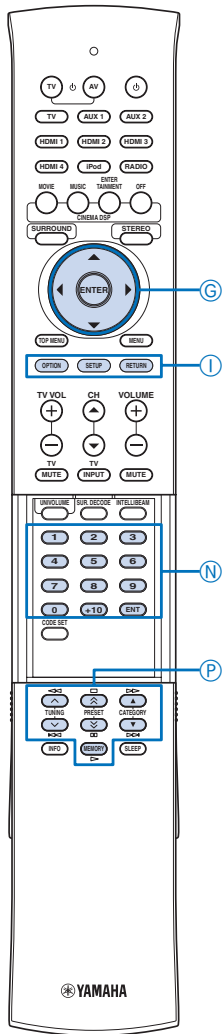

■ Category Search mode

- 1 Press **ⓅCATEGORY** \triangle / ∇ repeatedly to select the channel category.

The CATEGORY indicator lights up on the front panel display during channel category selection. When you select the category, the first channel in the category is selected.

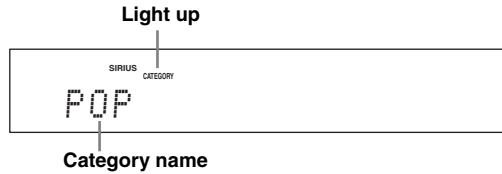

- If you do not operate within 10 seconds, the Category Search mode is automatically canceled.

- 2 While the CATEGORY indicator lights up, press **ⓅTUNING** \wedge / \vee repeatedly to search for a channel within the selected channel category.

- You can search for a channel quickly by pressing and holding **ⓅTUNING** \wedge / \vee .

Note

- This unit skips the channels when this unit is in the All Channel Search mode or Category Search mode in the following cases (it is not malfunction of this unit):
 - the channel is locked (page 29).
 - the channel is out of service.
 - you do not subscribe to the channel.

■ Direct number access

In the All Channel Search mode or Category search mode, press the **ⓃNumeric** keys to enter the desired three-digit channel number.

For example, to enter the number 123, press the **ⓃNumeric** keys as “1”, “2” and “3”.

- To display the Sirius ID number displayed on the front panel display, select channel “0”.
- To enter a one-digit or two-digit channel number, press the **ⓃNumeric** keys on the remote control and then press **ⓃENT** to confirm the input number.
- Instead of pressing **ⓃENT** to tune into the channel immediately, you can wait a few seconds until this unit confirms the entered channel number.
- If no key is pressed within a few seconds after you enter a one-digit or two-digit number, this unit automatically confirms the entered channel number.
- If the selected channel is locked, “PIN:___” appears on the front panel display. Enter the four-digit Parental Lock code number by using the **ⓃNumeric** keys or press **ⓃENT** to cancel (page 29).
- If the selected channel is not available, an advisory message may appear. For details, see “SIRIUS Satellite Radio” (page 44) in “Troubleshooting”.

- ⓄENTER
- Ⓞ \triangle / ∇
- Ⓞ \triangle / ∇
- ⓄOPTION
- ⓄRETURN
- ⓃNumeric keys
- ⓃENT
- ⓅCATEGORY \triangle / ∇
- ⓅMEMORY
- ⓅPRESET \wedge / \vee
- ⓅTUNING \wedge / \vee

Registering SIRIUS Satellite Radio™ channels

You can use this feature to store up to 40 SIRIUS Satellite Radio channels. You can then recall any preset channel easily by selecting the preset channel number as described in “Calling a preset channel (Preset Search mode)” on this page.

■ Registering preset channels

- 1 Search a channel you want to set as a preset channel in one of the SIRIUS Satellite Radio search modes.

For details, see “SIRIUS Satellite Radio operations” (page 27).

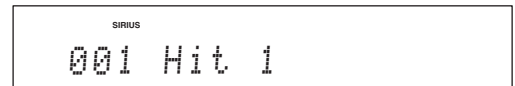

- 2 Press **ⓅMEMORY**.

The MEMORY indicator lights up on the front panel display.

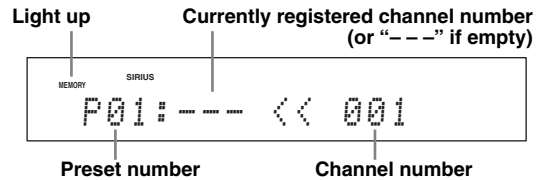

- By holding down **ⓅMEMORY** for more than 2 seconds, you can skip the following steps and automatically register the selected channel to an empty preset number (next to the lastly-registered preset number).
- To cancel the preset operation, press **ⓄRETURN**.

- 3 Press **ⓅPRESET** \wedge / \vee to select a preset number to which the selected channel is registered.

- You can also select a preset number using the **ⓃNumeric** keys.
- If you select a preset number being used (currently registered channel number appears next to the preset number), the current preset channel will be overwritten.

- 4 Press **ⓅMEMORY**.

■ Calling a preset channel (Preset Search mode)

Prior to selecting a preset channel in the Preset Search mode, you must preset SIRIUS channels. For details, see “Registering preset channels” on this page.

Press **ⓅPRESET** \wedge / \vee repeatedly to change the preset channel number (1 to 40).

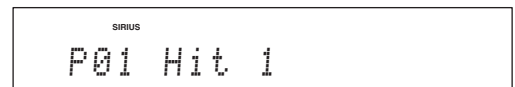

■ Clearing preset channels

You can clear the assignments of preset SIRIUS Satellite Radio channels.

1 Press **OPTION** on the remote control.

The option menu for “SIRIUS” appears on the front panel display.

2 Press **UP / DOWN** repeatedly to select “Clear Preset” and then press **ENTER**.



Preset number Channel name



• To cancel the clearing operation, press **RETURN**.

3 Press **UP / DOWN** to select the preset number to reset and then press **ENTER**.

The selected preset number is reset. To reset another preset number, repeat step 3.

4 To exit from the menu, press **OPTION**.

Setting the Parental Lock

You can use the Parental Lock feature to limit the access to the desired SIRIUS Satellite channels. This unit automatically skips the locked channels when this unit is in the All Channel Search mode or Category Search mode.

■ Setting the code number and locking channels

Use this feature to set the Parental Lock code number (PIN) and select the channels to be locked.

1 Press **OPTION** on the remote control.

The option menu for “SIRIUS” appears on the front panel display.

2 Press **UP / DOWN** repeatedly to select “ParentalLock” and then press **ENTER**.

3 Use **LEFT / RIGHT** (to select a digit to edit) and **UP / DOWN** (to select a number) to enter the desired 4-digit code number.

If you have entered a code number before, enter the same code number.

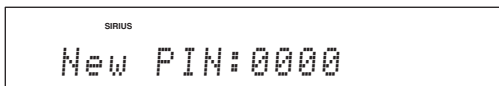

The entered code number is needed for tuning in the channel or unlocking the channel. Write it down below.
Code number: _____

4 Press **ENTER**.

The confirmation screen appears.

5 Press **ENTER** again to confirm the code number.

Note

- If a code number is already registered and you enter the different number, “Wrong” appears and the screen returns to step 3. Enter the correct code number.
- If you forget the Parental lock code or want to change it, reset it using “SIRIUS PIN” (page 41).

6 Press **LEFT / RIGHT** to select the category of a channel you want to lock.



7 Press **UP / DOWN** to select a channel you want to lock.

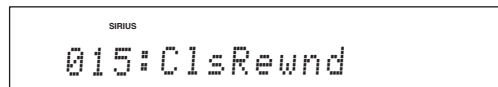

8 Press **ENTER** to lock the selected channel.

You can toggle channel lock and unlock as you press **ENTER**.



9 Repeat steps 6 through 8 to lock all the desired channels.

10 To exit from the menu, press **OPTION**.

This unit is tuned into the last channel you select in the “Parental Lock” screen. If the channel is locked, this unit is tuned into “184 Weather” or “000 Sirius ID”.

■ Tuning into the locked channels

Tune into the channel with direct number access (page 28) or Preset Search mode (page 28). When you tune into the locked channel, “LOCKED CH” appears on the front panel display, followed by the following message. Enter the Parental lock code by using the **NUMERIC** keys. To cancel this operation, press **ENT**.



Note

- If an incorrect number is entered, “Wrong” appears on the front panel display and this unit is tuned into the previously selected channel.

Displaying the SIRIUS Satellite Radio™ information

Use this feature to display the SIRIUS Satellite Radio information on the front panel display.

Note

- If a status message or an error message appears on the front panel display, see “SIRIUS Satellite Radio” (page 44).

Press **Ⓡ**INFO repeatedly to toggle the following SIRIUS Satellite Radio information display modes.

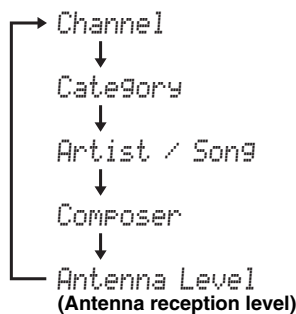

Display example (Artist / Song)

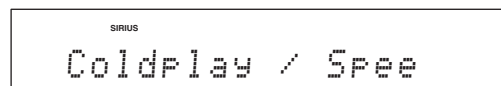

- If the SIRIUS Satellite Radio information contains a character that cannot be recognized by this unit, the character will be displayed with a space.
- When the antenna of the SiriusConnect tuner cannot receive the signals, “ACQUIRING” appears on the front panel display.
- When an information is unavailable, “—” appears.

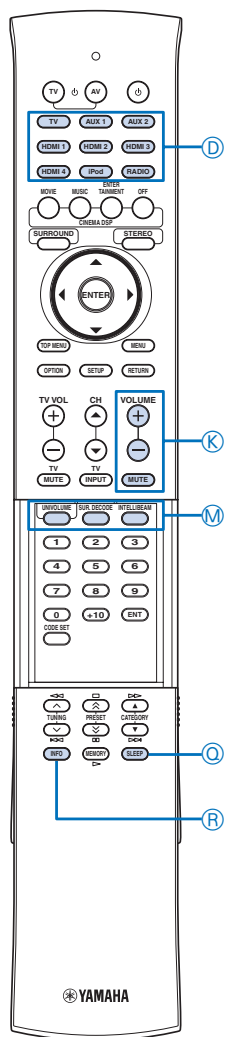

Playing back iPod™/iPhone™

By using the Yamaha wireless transmitter for iPod (PDX-50TX/PDX-50BC), you can use the iPod/iPhone as a remote control and enjoy playback of your iPod/iPhone on this unit. About PDX-50TX/PDX-50BC, refer to “Safety and Accessory Information” (separate booklet). See also: “iPod Interlock” (page 39)



- This unit supports the following iPod/iPhone models.
 - iPod 5th generation
 - iPod classic
 - iPod touch
 - iPod nano
 - iPhone
 - iPhone 3G

Notes

- Be sure to use the product only in the country in which it was purchased.
- This unit does not support iPod (4th generation or before), iPod without Dock connector, iPod photo and iPod mini.
- You cannot run the AUTO SETUP while playing back the iPod/iPhone by using PDX-50TX. To run the AUTO SETUP, stop playback and then disconnect the iPod/iPhone from PDX-50TX.

Connect your iPod/iPhone and PDX-50TX, and then start playback.

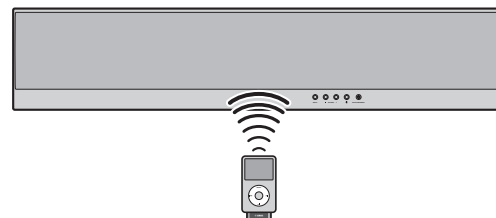

- When you start playback of your iPod/iPhone, this unit automatically operates as follows.
 - When this unit is on, this unit selects “iPod” as the input source.
 - When this unit is in the standby mode, this unit turns on and selects “iPod” as the input source.
- You can also select the input source with **Ⓢ**iPod.
- To adjust the volume level, use the volume control on the iPod/iPhone or **Ⓚ**VOLUME +/- on this unit.
- This unit automatically turns to the standby mode in the following conditions.
 - The iPod/iPhone is disconnected from PDX-50TX.
 - The iPod/iPhone is turned into sleep mode.

- Ⓢ iPod
- Ⓚ VOLUME +/-
- Ⓜ UNIVOLUME
- Ⓢ SLEEP
- Ⓡ INFO

Useful features

Adjusting volume level automatically (UniVolume)

This function adjusts the volume level of the TV so that it will not increase suddenly when whenever the contents being broadcast change (due to commercials, etc.).

Press **UNIVOLUME**.

The UNIVOLUME indicator lights up on the front panel display.



- To turn off the UniVolume function, press **UNIVOLUME** again.
- We recommend turning off the UniVolume function during playback of music.

Using the HDMI™ control function

You can operate the following functions of this unit with the remote control of your TV when the TV (HDMI control function supported) is connected to the HDMI OUT jack of this unit.

- Turning on this unit or to the standby (conjunction with TV)
- Adjusting the volume
- Selecting a device to reproduce TV sounds (this unit or TV)



- Even if your TV supports the HDMI control function, some functions may not be available. For details, refer to the manual supplied with your TV.
- If you connect this unit and Blu-ray disc player or DVD player (HDMI control function supported) with HDMI, you can also control those devices with the HDMI control function. For details, refer to the manual supplied with each device.
- We suggest that you use products (TV, Blu-ray disc/DVD player, etc.) from the same manufacturer.
- The HDMI control-compatible components include Panasonic VIERA Link compatible TV, DVD player/recorder and Blu-ray disc player.

To use this function, you need to set HDMI control function and register the HDMI components to the TV.



- For some HDMI components, you only need to set the HDMI control function. Registering HDMI components to TV is not required in this case.

Setting the HDMI control function

1 Turn on all devices connected to this unit with HDMI.

2 Enable the HDMI control function on each device.

For this unit, set "HDMI CONTROL" to "ON" (page 39).

For external devices, refer to the manual supplied with each device.

3 Turn off the TV and then turn on it again.

Registering HDMI components to TV

1 Select this unit as the input source of the TV.

2 Turn on the HDMI control device (Blu-ray disc or DVD player) connected to this unit.

3 Select the HDMI control device (Blu-ray disc or DVD player) as the input source of this unit to check the video input.

Note

- In case the HDMI control function does not work, check the followings. Also, turning off (unplug) and turning on (plug) the TV may be effective.
 - "HDMI CONTROL" is set to "ON" on this unit (page 39).
 - The HDMI control function is enabled on the TV.
 - If you changed the connection method or connected components, repeat steps 1-3.

Using the sleep timer

Use this feature to automatically set this unit to the standby mode after a specified period of time.

1 Press **SLEEP repeatedly to set the interval for the sleep timer.**

The SLEEP indicator (page 7) flashes in the front panel display while switching the interval for the sleep timer.

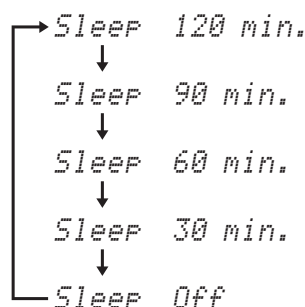

2 Wait for a few seconds without operating this unit to confirm the setting for the sleep timer.

The SLEEP indicator lights up in the front panel display, indicating that the sleep timer is activated.



- If this unit is set to the standby mode, the sleep timer setting is canceled.

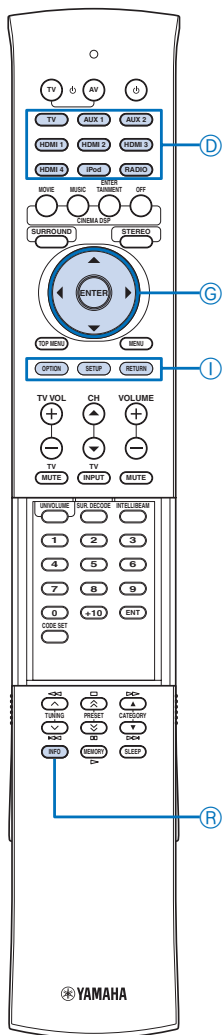

Configuring settings for each input source (Option menu)

You can configure various settings for each input source (TV, AUX1/2, HDMI1-4, iPod, FM and SIRIUS). Available menu items vary depending on the selected input source.

1 Press D Input selector keys to select the desired input source.

2 Press I OPTION.

The first item of the option menu for the selected input source appears on the front panel display.

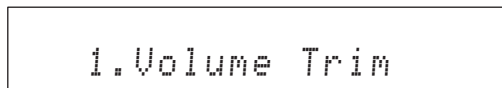

3 Press G ▲ / ▼ to select the desired menu item and then press G ENTER.

4 Press G ◀ / ▶ to select the desired setting and then press G ENTER.

5 To exit from the menu, press I OPTION.

Option menu items

The following menu items are provided for each input source.

Input source	Menu items			
HDMI1~4	Volume Trim	Decoder Mode		
TV	Volume Trim	Decoder Mode		
AUX1~2	Volume Trim	Decoder Mode		
FM	Volume Trim	FM Mode	Auto Preset	Clear Preset
SIRIUS	Volume Trim	Clear Preset	Parental Lock	
iPod	Volume Trim			

Details of the menu items are as follows. The configuration will be reflected to the input source currently selected.



- The initial settings are marked with “*”.

Volume Trim (Volume trim)

Use to reduce any change in volume when switching input sources by correcting volume differences between input sources.

Adjustable range: -6.0dB to +6.0dB (in 0.5 dB steps)
Initial setting: 0.0dB

Decoder Mode (Decoder mode)

Use to select DTS digital audio signals for reproduction.
Choices: Auto*, DTS

- Select Auto to automatically select audio input signals.
- Select DTS to selects DTS signals only. Other input signals are not reproduced.

FM Mode (FM receiving mode)

Use to set the FM broadcasting receiving mode.

Choices: Stereo*, Mono

- Select Stereo to receive in stereo mode by priority.
- Select Mono to receive in monaural mode.

Auto Preset (Automatic preset)

Use to automatically detect FM radio stations and registers them as preset stations (page 25).

Clear Preset (Clear preset station)

Use to clear the preset FM stations (page 26) or preset SIRIUS Satellite Radio channels (page 29).

ParentalLock (Parental lock)

Use to limit access to the desired SIRIUS Satellite Radio channels (page 29).

Displaying the input signal information

Use to display information of the sampling frequency, video signal type, and resolution for each input source on the front panel display.

1 Select an input source (TV, AUX1/2, and HDMI1-4) and then press R INFO.

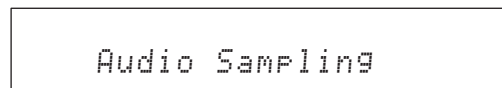

2 Press R INFO repeatedly to change items to be displayed.

Sampling frequency (Audio Sampling)

The sampling frequency per second in analog- to-digital conversion.

Video signal (Video Signal In)

Signal type and resolution of video input signal.

D Input selector keys

G ENTER

G ▲ / ▼

G ◀ / ▶

I OPTION

R INFO

SETTINGS

Customizing this unit (SET MENU)

You can manually configure various settings for this unit in “SET MENU”.

SET MENU items

Menu	Sub menu	Features	Page
MEMORY	LOAD	Loads the beam and sound settings saved in the memory.	19
	SAVE	Saves the current beam and sound settings to the memory.	19
AUTO SETUP	BEAM+SOUND OPTIMZ	Optimizes the beam and sound settings automatically.	16
	BEAM OPTIMZ ONLY	Optimizes the beam settings automatically.	16
	SOUND OPTIMZ ONLY	Optimizes the sound settings automatically.	16
MANUAL SETUP	SETTING PARAMETERS	Adjusts the listening room and listening position settings.	34
	BEAM ADJUSTMENT	Adjusts the various sound beam settings.	35
	IMAGE LOCATION	Adjusts the sound position of the front right and left channels.	35
SOUND SET MENU	TONE CONTROL	Adjusts the output level of high-frequency or low-frequency sound.	36
	SUBWOOFER SET	Configures the subwoofer settings.	36
	AUDIO DELAY	Adjusts delay in output timing between video signals and audio signals.	36
	DRC:Dynamic Range Control	Adjusts the dynamic range.	37
	BASS EXTENSION	Selects the bass sound extension.	37
	MUSIC ENHANCER	Selects the compressed audio enhancer.	37
	CHANNEL LEVEL	Adjusts the volume of each channel.	37
SOUND OUT MENU	SOUND BEAM OUT CONFIG	Configures the sound beam output settings.	37
	SOUND OUT	Configures the audio signal output settings.	37
INPUT MENU	INPUT ASSIGNMENT	Assigns jacks according to the component to be used.	38
	INPUT RENAME	Renames the displayed input source.	38
	HDMI SETUP	Configures the HDMI settings.	39
	WIRELESS SETUP	Configures the wireless settings.	39
DISPLAY MENU	F. DISPLAY SETUP	Configures the front panel display settings.	39
	OSD SETUP	Configures the OSD settings.	40
	LANGUAGE SETUP	Changes the language used in the OSD.	40
	UNIT SETUP	Changes the display unit of measurement.	40

Playback

Playback mode

FM tuning

SIRIUS Satellite Radio™ tuning

Playing back iPod™

Useful features

Customizing this unit (SET MENU)

System configurations (ADVANCED SETUP)

Using an external amplifier

Controlling external components

Basic SET MENU operation

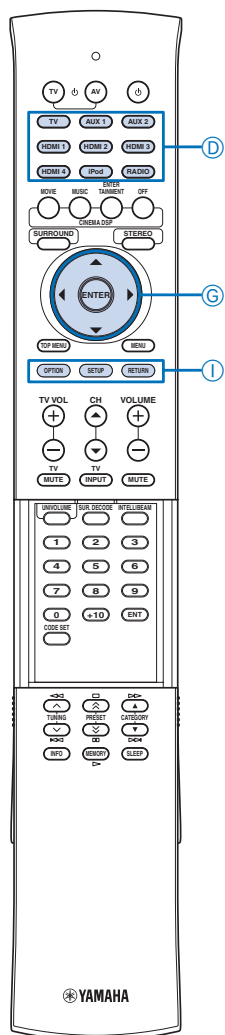

1 Press **D** SETUP.



2 Press **G** ▲ / ▼ to select the desired menu and then press **G** ENTER.



- To return to the previous menu, press **I** RETURN.

3 Press **G** ▲ / ▼ / ◀ / ▶ and **G** ENTER to configure each parameter.



- The initial settings are marked with “*”.

Note

- The menu screen disappears if one of the **D** Input selector keys is pressed while the SET MENU is being configured.

4 To exit from the menu, press **D** SETUP.

MANUAL SETUP

Use this menu to manually adjust the parameters related to the sound beam output. To fine-adjust parameters configured by AUTO SETUP, use “BEAM ADJUSTMENT” and “IMAGE LOCATION”.

■ SETTING PARAMETERS (Setting parameters)

SET MENU → MANUAL SETUP → SETTING PARAMETERS

Use to set the position of this unit in your listening room and the distance of this unit from the listening position.



- If you make adjustments in “SETTING PARAMETERS”, the “BEAM ADJUSTMENT” parameters are automatically adjusted.

Note

- If you make adjustments in “SETTING PARAMETERS”, the beam optimization settings made in the AUTO SETUP procedure will be lost.

- D** Input selector keys
- G** ENTER
- G** ▲ / ▼ / ◀ / ▶
- G** ▲ / ▼
- G** ▼
- I** RETURN
- D** SETUP

1 In “SETTING PARAMETERS 1/3”, configure “INSTALLED POSITION”.

Select the installed position of this unit.
Choices: FLAT TO WALL* (parallel to wall),
ANGLE TO WALL OR CORNER (angle to wall or corner)

FLAT TO WALL

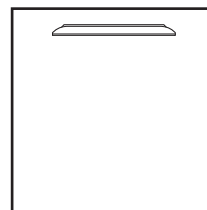

ANGLE TO WALL OR CORNER

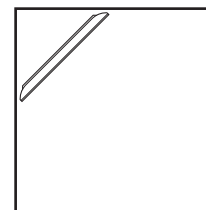

Note

- If you change this setting, “BEAM MODE” setting changes automatically (page 23).

2 Configure “INSTALLED HEIGHT”.

Specify the installed height of this unit.
Control range: 0.0 m to 3.0 m (0.0 ft to 10.0 ft)
Initial setting: 1.0 m (3.5 ft)

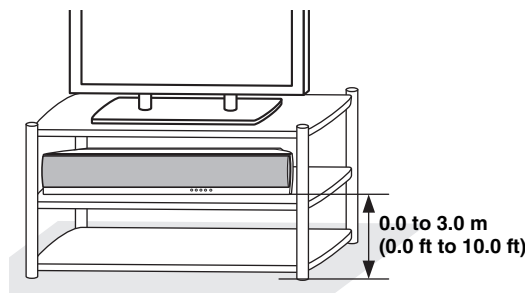

- Press **G** ▼ to proceed to the next page.

3 In “SETTING PARAMETERS 2/3”, configure the listening room settings.

Specify the length and width of the listening room.
Control range: 2.0 m to 12.0 m (6.5 ft to 40.0 ft)

When this unit is installed parallel to wall, specify the width of the listening room and the distance between this unit and rear wall.

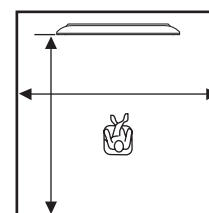

When this unit is installed at the corner of the room, specify the width of length of the listening room.

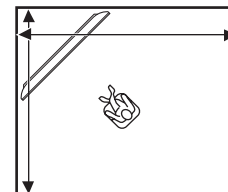

4 In “SETTING PARAMETERS 3/3”, configure the distance settings.

Specify the distance between the listening position and this unit. When this unit is installed parallel to wall, you also need to specify the distance between the listening position and left wall.

Control range (from this unit): 1.8 m to 9.0 m (6.0 ft to 30.0 ft)
 Control range (from left wall): 0.6 m to 11.4 m (2.0 ft to 38.0 ft)

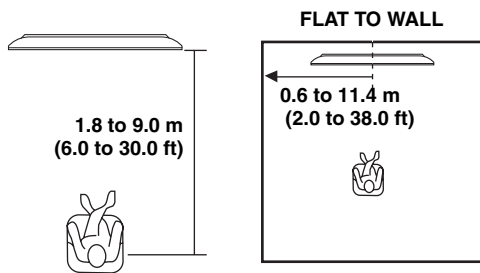

■ BEAM ADJUSTMENT (Beam adjustment)

SET MENU → MANUAL SETUP → BEAM ADJUSTMENT

Use to manually adjust the various sound beam settings.

Notes

- The "BEAM ADJUSTMENT" parameters are automatically adjusted (except "Center" in "FOCAL LENGTH") if you run the AUTO SETUP (page 15) or if you configure "SETTING PARAMETERS" (page 34).
- Depending on the beam mode settings (page 23), some channel positions may not be available for selection. In this case, "—" is displayed.
- If you change "BEAM ADJUSTMENT" settings while playing back your iPod/iPhone connected to PDX-50TX, the subwoofer connected to SWK-W10 outputs the iPod/iPhone audio. We recommend stopping the iPod/iPhone playback during the beam adjustment.

1 Configure "HORIZONTAL ANGLE".

Adjust the horizontal angle of sound beams for each channel using test tones.

Adjust toward L (left) to move the direction of the output to the left and adjust toward R (right) to move it to the right.

Control range: L90° to R90°

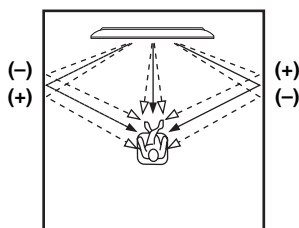

- Press to switch the channels.

2 Configure "VERTICAL ANGLE".

Adjust the vertical angle of sound beams for each channel using test tones.

Adjust toward - (minus) to move the angle downward and adjust toward + (plus) to move the angle upward.

Control range: -45° to +45°

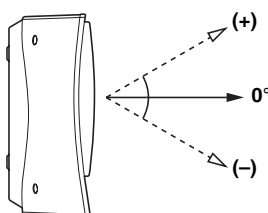

3 Configure "BEAM TRAVEL LENGTH".

Adjust the distance that sound beams travel after being output and reflected off the wall until they arrive at the listening position so that all sounds can arrive at the listening position at the same time.

Note

- Configure this setting only when you have adjusted "HORIZONTAL ANGLE".
- Control range: 0.3 m to 24.0 m (1.0 ft to 80.0 ft)

The length of each arrow indicates the beam travel length.

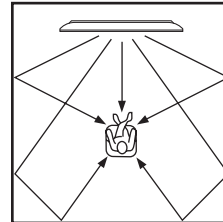

4 Configure "FOCAL LENGTH".

Adjust the distance from the front of this unit to the focal point of output for each channel to achieve an expansive feeling for each channel. Adjust toward - (minus) to move the focus outward (widen the sweet spot) and adjust toward + (plus) to move the focus toward the normal position (narrow the sweet spot).

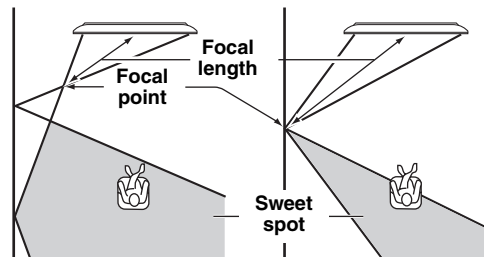

Control range: -1.0 m to +13.0 m (-3.5 ft to +43.5 ft)



- We recommend that you use the initial setting (-0.5 m or -1.5 ft) for "Center".
- The width of the sweet spot becomes slightly wider than the width of this unit if you run the AUTO SETUP (page 15) or if you configure "SETTING PARAMETERS" (page 34).

Example

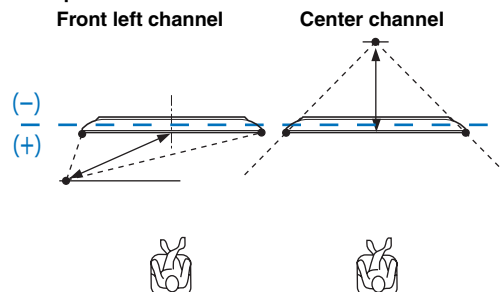

■ IMAGE LOCATION (Image location)

SET MENU → MANUAL SETUP → IMAGE LOCATION

Use to adjust the direction from which the front left and right channel sound is heard so that each sound can be heard closer to the center channel.

Use this feature to redirect audio signals if the sound coming from the front left and right channels seems unnatural.

You can adjust this parameter only when “5BeamPlus2”, “5 Beam” or “3 Beam” is selected in “BEAM MODE” (page 23).



- To adjust the volume of each channel, see “CHANNEL LEVEL” (page 37)

Choices: OFF*, ON

- Select “ON” to configure the sound direction.

1 Adjust the image location for the front left channel (LEFT).

The higher the percentage, the louder the output from the center

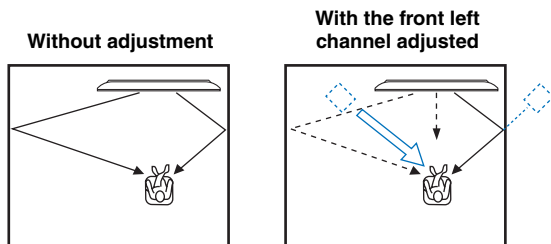

2 Adjust the image location for the front right channel (RIGHT).

The higher the percentage, the louder the output from the center

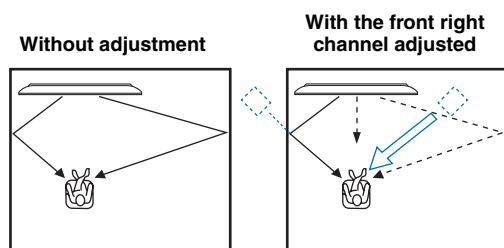

SOUND SET MENU

■ TONE CONTROL (Tone control)

SET MENU → SOUND SET MENU → TONE CONTROL

Use to adjust the tonal quality of sound beams.

TREBLE (Treble)

Use to adjust the high-frequency response.

Choices: -10.0 dB to +10.0 dB

Initial setting: 0.0 dB

BASS (Bass)

Use to adjust the low-frequency response.

Choices: -10.0 dB to +10.0 dB

Initial setting: 0.0 dB

■ SUBWOOFER SET (Subwoofer settings)

SET MENU → SOUND SET MENU → SUBWOOFER SET

Use to configure the subwoofer settings.

BASS OUT (Bass out)

Select where to output low-frequency effect (LFE) and low-frequency (bass) signals.

Choices: SUBWOOFER, FRONT OR AUTO*

- Select SUBWOOFER if you connect a subwoofer with a subwoofer cable. LFE and low-frequency signals from other channels are directed to the subwoofer.
- Select FRONT OR AUTO if you do not use a subwoofer or connect a subwoofer by wireless. LFE and low-frequency signals from other channels are directed to the front right and left channels when you do not use a subwoofer. They are directed to the subwoofer automatically when a wireless connection between a subwoofer and this unit is established properly. If the wireless connection is cut off, they are directed to the front channels automatically.

CROSS OVER (Crossover)

When “BASS OUT” is set to “SUBWOOFER”, you can use this feature to select a crossover (cutoff) frequency for all low-frequency signals. All frequencies below the selected frequency will be sent to the subwoofer position. Choices: 80Hz, 100Hz, 120Hz*

LFE LEVEL (Low-frequency effect level)

Adjust the output level of the low-frequency effect (LFE) channel according to the capacity of your subwoofer. This setting is effective only when this unit decodes Dolby Digital or DTS signals.

Choices: -20 dB to 0 dB*

DISTANCE (Distance)

Adjust the distance of the subwoofer from the listening position.

Choices: 0.3 m to 15.0 m (1.0 ft to 50.0 ft)

Initial setting: 3.0 m (10.0 ft)

■ AUDIO DELAY (Audio delay)

SET MENU → SOUND SET MENU → AUDIO DELAY

Use to adjust delay in output timing between video signals and audio signals.

AUTO LIP SYNC (Automatic lipsync)

Select whether to automatically adjust the audio output delay when a TV that supports the automatic lipsync is connected to the HDMI OUT jack of this unit.

Choices: ON*, OFF

- Select ON if the TV connected to the HDMI OUT jack of this unit supports the automatic lipsync. The audio output delay is automatically adjusted.
- Select OFF if the TV connected to the HDMI OUT jack of this unit does not support the automatic lipsync or you want to disable the automatic lipsync. You can manually adjust the audio output delay in “HDMI”.

TV

Adjust the audio output delay applied to signals input from the TV jacks.

Control range: 0 msec* to 400 msec

HDMI

Manually adjust the audio output delay applied to signals input from the HDMI IN jacks. This setting is effective only when “AUTO LIP SYNC” is set to “OFF”

Control range: 0 msec to 400 msec

Initial setting: 30msec

AUX1/2

Adjust the audio output delay applied to signals input from the AUX1/2 jacks.

Control range: 0 msec to 400 msec

Initial setting: 30msec

■ DRC:Dynamic Range Control (Dynamic range control)

SET MENU → SOUND SET MENU →

DRC:Dynamic Range Control

Use to adjust the dynamic range compression. Dynamic range is the difference between the smallest sound that can be heard above the noise of the equipment and the biggest sound that can be heard without distortion.

Adaptive DRC (Adaptive dynamic range control)

Select whether to automatically adjust the dynamic range in conjunction with the volume level. When this function is enabled, the dynamic range is adjusted as follows.

When the volume level is low: Narrow the dynamic range. Loud sound is played back softer, and soft sound which is hard to be listened to is played back louder.

When the volume level is high: Widen the dynamic range. From soft sound to loud sound, source sound is played back without adjusting volume.

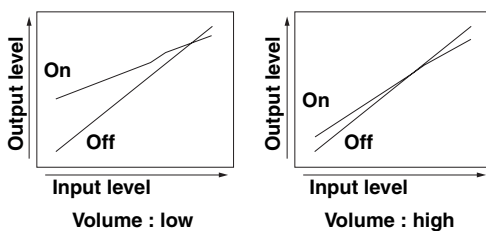

Choices: On*, Off

- Select On to enable the adaptive dynamic range control.
- Select Off to disable the adaptive dynamic range control.



- “Dolby/DTS DRC” is automatically set to “Max” when “Off” is selected.
- This setting is automatically set to “Off” when the UniVolume function is turned on while this setting is automatically set to “On” when the UniVolume function is turned off.

Dolby/DTS DRC (Dynamic range of Dolby Digital and DTS signals)

Select the amount of dynamic range applied when this unit is decoding Dolby Digital and DTS signals

Choices: Max* (Maximum), Standard, Min/Auto (Minimum/Auto)

- Select Max to output sound without adjusting the dynamic range of the input signals.
- Select Standard to set the standard dynamic range recommended for regular home use.
- Select Min/Auto to set the dynamic range suitable for low volume or a quiet environment, such as at night, for bitstream signals except for Dolby TrueHD signals (Min) or adjust the dynamic range for Dolby TrueHD signals based on input signal information (Auto).



- “Adaptive DRC” is automatically set to “Off” when the settings other than “Max” is selected.

■ BASS EXTENSION (Bass extension)

SET MENU → SOUND SET MENU → BASS EXTENSION

Use to turn on or off the bass sound extension. When this function is enabled, the BASS EXT indicator lights up on the front panel display (page 7).

Choices: OFF, MID*, DEEP

- Select OFF to output bass sounds without change.
- Select MID to output moderately-enhanced bass sounds.
- Select DEEP to output deep bass sounds.

■ MUSIC ENHANCER (Music Enhancer)

SET MENU → SOUND SET MENU → MUSIC ENHANCER

Use to turn on or off the compressed audio enhancer.

When this function is enabled, the ENHANCER indicator lights up on the front panel display (page 7).

AUX1/2

Select whether to apply the compressed audio enhancer for playback of AUX1/2 input sources.

Choices: ON, OFF*

- Select ON to enable the compressed audio enhancer for playback of AUX1/2 input sources.
- Select OFF to disable the compressed audio enhancer for playback of AUX1/2 input sources.

iPod

Select whether to apply the compressed audio enhancer to iPod/iPhone playback.

Choices: ON*, OFF

- Select ON to enable the compressed audio enhancer for iPod/iPhone playback.
- Select OFF to disable the compressed audio enhancer for iPod/iPhone playback.

■ CHANNEL LEVEL (Channel level)

SET MENU → SOUND SET MENU → CHANNEL LEVEL

Use to adjust the volume of each channel with test tones. Control range: -10.0 dB to +10.0 dB

Note

- Adjustable channels vary depending on the “CHANNEL OUT” setting.
- “Surround Back R” and “Surround Back L” are not adjustable when “SOUND OUT” is set to “SPEAKER”.

SOUND OUT MENU

■ SOUND BEAM OUT CONFIG (Sound beam output configuration)

SET MENU → SOUND OUT MENU → SOUND BEAM OUT CONFIG

Use to configure the number of output channels or audio output method. For details, see “Changing the audio output method for surround playback” (page 23).

■ SOUND OUT (Sound output)

SET MENU → SOUND OUT MENU → SOUND OUT

Use to configure the audio signal output settings.

Customizing this unit (SET MENU)

System configurations (ADVANCED SETUP)

Using an external amplifier

Controlling external components

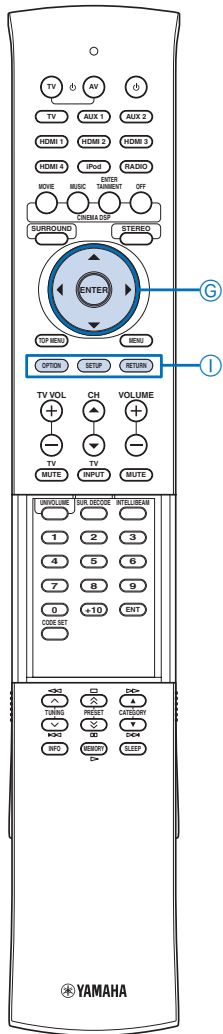

SOUND OUT (Sound output redirection)

Use to redirect the output of audio signals. Audio output of all the channels switches simultaneously.

Choices: SPEAKER*, PRE OUT

- Select SPEAKER to output sounds from this unit.
- Select PRE OUT to output audio signals from the PRE OUT jacks of this unit. You also need to configure the parameters from “BASS OUT” to “LFE Level” described below.



- The parameters from “BASS OUT” to “LFE Level” are settings for the PRE OUT jacks when they are selected as audio output jacks.

BASS OUT (Bass sound output redirection)

Use to redirect the output of bass sounds. The settings under “BASS OUT” are for the PRE OUT jacks.

Choices: SUBWOOFER, FRONT*

- Select SUBWOOFER to output bass sounds from the subwoofer.
- Select FRONT to output bass sounds from the external front right and left speakers.

Front SP Size (Front speaker size for PRE OUT)

Select the size of external front speakers.

Choices: Small, Large*

- Select Small if the diameter of the front speaker’s woofer is smaller than 16 cm. Low-frequency parts of front right and left channel signals are output from the subwoofer.

Center SP Size (Center speaker size for PRE OUT)

Select the size of external center speakers.

Choices: None, Small*

- Select None if no center speaker is used. Center channel signals are mixed into the front right and left speakers.
- Select Small if a center speaker is used. Low-frequency parts of center channel signals are output from the subwoofer (or mixed into the front right and left channel signals if subwoofer is not available).

PRE OUT Volume (PRE OUT volume)

Adjust the output level of the PRE OUT jacks.

Control range: -30.0 dB to 0.0 dB

Initial setting: -18.0 dB

LFE Level (Low-frequency effect level for PRE OUT)

Adjust the low-frequency effect output level of the PRE OUT jacks. This setting is effective only when this unit decodes Dolby Digital or DTS signals.

Control range: -20 dB to + 0 dB*

INPUT MENU

INPUT ASSIGNMENT (Input assignment)

SET MENU → INPUT MENU → INPUT ASSIGNMENT

Use to change the key assignments of input jacks on this unit. The parenthetic references displayed in the menu screen indicate the initial settings.

See also: “AUDIO SELECT” (page 39)



- Press ⑥ ▽ to proceed to the next page.

AUDIO1

Select the key to which the AUDIO IN (TV) jacks are assigned.

Choices: TV*, AUX1, AUX2, HDMI1, HDMI2, HDMI3, HDMI4

Note

- The input already selected in “AUDIO2” is not displayed. To set the input selected in “AUDIO2”, change “AUDIO2” parameter, and then reconfigure.

AUDIO2

Select the key to which the AUDIO IN (AUX 1) jacks are assigned.

Choices: AUX1*, AUX2, HDMI1, HDMI2, HDMI3, HDMI4, TV

Note

- The input already selected in “AUDIO1” is not displayed. To set the input selected in “AUDIO1”, change “AUDIO1” parameter, and then reconfigure.

OPTICAL1

Select the key to which the DIGITAL IN (TV) jack is assigned.

Choices: TV*, AUX1, AUX2, HDMI1, HDMI2, HDMI3, HDMI4

Note

- The input already selected in “OPTICAL2” or “COAX” is not displayed. To set the input selected in one of these parameters, change the corresponding parameter, and then reconfigure.

OPTICAL2

Select the key to which the DIGITAL IN (AUX 1) jack is assigned.

Choices: AUX1*, AUX2, HDMI1, HDMI2, HDMI3, HDMI4, TV

Note

- The input already selected in “OPTICAL1” or “COAX” is not displayed. To set the input selected in one of these parameters, change the corresponding parameter, and then reconfigure.

COAX

Select the key to which the DIGITAL IN (AUX 2) jack is assigned.

Choices: AUX2*, HDMI1, HDMI2, HDMI3, HDMI4, TV, AUX1

Note

- The input already selected in “OPTICAL1” or “OPTICAL2” is not displayed. To set the input selected in one of these parameters, change the corresponding parameter, and then reconfigure.

INPUT RENAME (Input rename)

SET MENU → INPUT MENU → INPUT RENAME

Use to change the name of the input source displayed when the input source is selected. Select a name from templates, or enter an original name.

Selecting a name from templates

- 1 Press ⑥ △ / ▽ to select the input source to be renamed.

- ⑥ ENTER
- ⑥ △ / ▽
- ⑥ ◀ / ▶
- ⑥ ▽
- ① RETURN

2 Press **to select a input source name.**
Choices: TV, Blu-ray, DVD, HDDVD, STB, Satellite, Game

3 To exit from the menu, press **RETURN.**

Entering an original name

1 Press **to select the input source to be renamed.**

2 Press **ENTER.**
“” appears above the new name display to indicate the position to be entered.

3 Press **to place the** **(underscore) under the space or the character you want to edit.**

4 Press **to select the desired character.**

5 Repeat steps 3 and 4 to edit other characters.

6 To complete the setting, press **ENTER.**

7 To exit from the menu, press **RETURN.**



- A to Z, 0 to 9, a to z, and symbols (!, ?, <, >, etc.) are available for input.

■ HDMI SETUP (HDMI setup)

SET MENU → INPUT MENU → HDMI SETUP

Use to configure the settings related to HDMI signals and HDMI control function.

SUPPORT AUDIO (Support audio)

Use to select a component to play back HDMI audio signals. This setting is effective only when “HDMI CONTROL” is set to “OFF”.



- HDMI video signals input to one of the HDMI IN jacks of this unit are always output from the HDMI OUT jack.

Choices: (Model name of this unit)*, OTHER

- Select this unit to play back HDMI audio signals on this unit.
- Select OTHER to play back HDMI audio signals on the component connected to the HDMI OUT jack.

AUDIO SELECT (Audio select)

Select whether or not to output HDMI audio signals input to each HDMI IN jacks. This function is useful when you want to enjoy another audio input source while watching HDMI video sources. For example, if you set “HDMI1” of “AUDIO SELECT” to “OFF” and “OPTICAL1” of “INPUT ASSIGNMENT” to “HDMI1” (page 38), you can enjoy the audio source input to the DIGITAL IN (AUX 1) jack while watching the HDMI video source input to HDMI IN 1 jack.

Choices: OFF, ON*

HDMI CONTROL (HDMI control)

Use this function to link this unit and an HDMI control-compatible TV via HDMI. For details, see “Using the HDMI control function” (page 31).

Choices: OFF*, ON

- Select OFF to turn off the HDMI control function. The standby consumption power of this unit decreases.
- Select ON to turn off the HDMI control function.

■ WIRELESS SETUP (Wireless setup)

SET MENU → INPUT MENU → WIRELESS SETUP

Use to configure the wireless connection between this unit and PDX-50TX or SWK-W10.

Wireless Function (Wireless function)

Select whether or not to use the wireless function of this unit,

Choices: No, Yes*

- Select No to disable the wireless function of this unit.
- Select Yes to enable the wireless function of this unit.

iPod Interlock (iPod interlock)

Select whether or not to use the iPod/iPhone interlock function. When the iPod/iPhone interlock function is on, this unit automatically turns on if you turn on the iPod/iPhone when this unit is in the standby mode. In addition, this unit is set to the standby mode if the iPod/iPhone is set to the standby mode.

Choices: OFF, ON*

- Select OFF to disable the iPod/iPhone interlock function. The standby consumption power of this unit decreases.
- Select ON to enable the iPod/iPhone interlock function.

Group ID (Group ID)

The group ID is used for wirelessly connecting Yamaha products that support yAired. To establish a connection among this unit, PDX-50TX and SWK-W10, set the group ID of these products to the same group.

Choices: A1*, A2, A3, B1, B2, B3



- PDX-50TX supports “1” (A1), “2” (A2), and “3” (A3) only.

DISPLAY MENU

■ F.DISPLAY SETUP (Front panel display setup)

SET MENU → DISPLAY MENU → F.DISPLAY SETUP

Use to adjust the brightness and display settings of the front panel display.

STANDARD DIMMER (Standard dimmer)

Use to adjust the brightness of the front panel display when you operate this unit.

Choices: -2, -1, OFF*

AUTO DIMMER (Auto dimmer)

Use to adjust the brightness of the front panel display when you do not operate this unit. The front panel display automatically dims or turns off according to this setting if no operation is performed for a specified period of time.

Choices: DISPLAY OFF, -3 to -1, OFF*

- Select OFF for the same brightness as “STANDARD DIMMER”.
- Select -3 to -1 to get dimmer (based on “STANDARD DIMMER”).
- Select DISPLAY OFF to turn off the front panel display.

Customizing this unit
(SET MENU)

System
configurations
(ADVANCED SETUP)

Using an external
amplifier

Controlling external
components

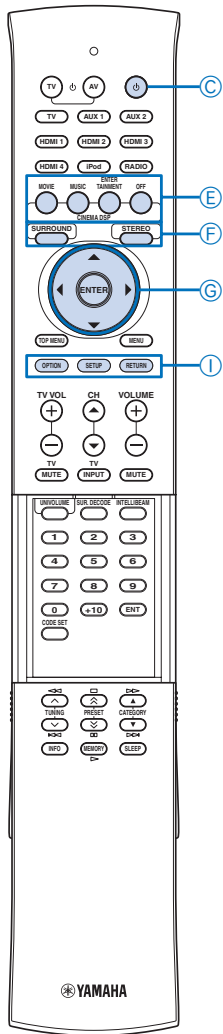

■ OSD SETUP (OSD setup)

SET MENU → DISPLAY MENU → OSD SETUP

Use to adjust the display position and select the background color of the OSD.

OSD SHIFT (OSD shift)

Use to adjust the vertical position of the OSD. Adjust toward the – (minus) direction to raise the position of the OSD, and adjust toward the + (plus) direction to lower it.

Choices: –5 to +5

Initial setting: ±0

OSD BACK COLOR (OSD background color)

Use to select the background color of the OSD.

Choices: Blue*, Gray, Black, Purple, Red

■ LANGUAGE SETUP (Language setup)

SET MENU → DISPLAY MENU → LANGUAGE SETUP

Use to select the language used in the OSD.

Choices: ENGLISH (English), DEUTSCH (German), Français (French), ESPAÑOL (Spanish), ITALIANO (Italian), NEDERLANDS (Dutch), Русский (Russian)

Initial setting: ENGLISH (English)

■ UNIT SETUP (Unit Setup)

SET MENU → DISPLAY MENU → UNIT SETUP

Use this to change the display unit of measurement.

Choices: METERS, FEET*

- Select METERS to enter distances in meters.
- Select FEET to enter distances in feet.

Note

- If you change this setting, the adjusted sound beam settings may change.

System configurations (ADVANCED SETUP)

This unit has additional menus that are displayed in the front panel display. These menus offer additional operations to adjust and customize the way this unit operates.

1 Press Power key to set this unit to the standby mode.

2 While holding down INPUT on the front panel, press Power key on the remote control.

Keep holding down INPUT until “ADVANCED SETUP” appears on the front panel display.

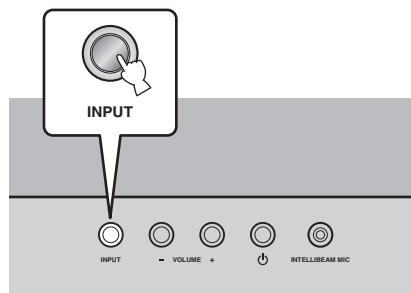

3 Press SETUP.

4 Press / to select the desired menu and then press ENTER.

Example (when “DEMO MODE” is selected)

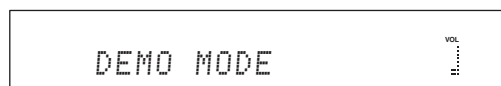

- To return to the previous screen, press RETURN.

5 Press to select the desired parameter.

6 Press Power key to set this unit to the standby mode.

The new setting will be reflected when you turn on this unit next time.



- The initial settings are marked with “*”.

TURN ON VOLUME (Volume level at power-on)

Set the initial volume level when the power of this unit is turned on.

Control range: OFF*, 01 to 99, MAX (Maximum)

MAX VOLUME SET (Maximum volume setting)

Set the maximum volume level so that this unit will not output sound beyond the limited volume level.

Control range: 01 to 99, MAX* (Maximum)

PANEL INP.KEY (Front panel input key)

Select whether or not to enable the INPUT key on front panel key. To disable the operations, select “P.INPUT: OFF”.

Choices: P.INPUT: ON*, P.INPUT: OFF

F.PANEL KEY (Front panel key)

Select whether or not to enable front panel key operations (except ADVANCED SETUP operations). To disable the operations, select “F.PANEL: OFF”.

Choices: F.PANEL: ON*, F.PANEL: OFF

- Power
- OFF
- STEREO
- SURROUND
- ENTER
- /
-
- RETURN
- SETUP

R.INPUT POWER (Power-on by remote control input keys)

Select whether or not to automatically turn on this unit when you select an input source on the remote control. To enable the function, select "R.INPUT PW: ON".
Choices: R.INPUT PW: OFF*, R.INPUT PW: ON

AC ON STANDBY (Standby after AC on)

Set this unit to the standby mode when the AC power is recovered after the power to this unit was lost temporarily (disconnect the AC power plug from the wall outlet, power outage, etc.). To enable the function, select "AC STANDBY: ON".
Choices: AC STANDBY: OFF*, AC STANDBY: ON

SIRIUS PIN (SIRIUS Satellite Radio PIN)

Reset the Parental Lock cord for SIRIUS Satellite Radio.
Choices: CANCEL*, RESET

MEMORY PROTECT (Memory protect)

Protect the settings you have saved in the system memory. To protect the settings, select "PROTECT: ON".
Choices: PROTECT: OFF*, PROTECT: ON

DEMO MODE (Demo mode)

Test the sound beam output from this unit to experience the sound beam. To set this unit to the demo mode, select "BEAM DEMO: ON".

Choices: BEAM DEMO: OFF*, BEAM DEMO: ON

- To move the beam horizontally, turn off this unit and then turn on it again ("DEMO" appears on the front panel display). Playback an input source and then press E OFF.
- To stop the beam movement, press E OFF again.
- To adjust the beam angle manually, press E SURROUND or E STEREO when the beam is not moving.



- After you checked the sound beam output, set this setting to "BEAM DEMO: OFF".
- If you set "SOUND OUT" to "PRE OUT", "DEMO MODE" does not function.

FACTORY PRESET (Factory preset)

Reset all of the parameters of this unit to the factory presets.
Choices: CANCEL*, RESET

Using an external amplifier

You can connect an external amplifier to the PRE OUT jacks. Set "SOUND OUT" (page 37) to "PRE OUT" and then configure "PRE OUT BASS Management" parameters.

See also: "Changing the audio output method for surround playback" (page 23)

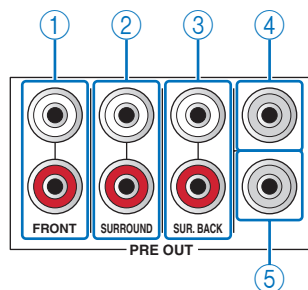

① FRONT PRE OUT jacks

Output front right and left channel signals.

② SURROUND PRE OUT jacks

Output surround right and left channel signals.

③ SUR. BACK PRE OUT jacks

Output surround back right and left channel signals.

④ CENTER PRE OUT jack

Outputs center channel signals.

⑤ SUBWOOFER PRE OUT jack

Connect a subwoofer with a built-in amplifier.

Note

- The following functions are disabled when an external amplifier is used.
 - AUTO SETUP (page 15)
 - CINEMA DSP programs (page 22)
 - UniVolume (page 31)
 - MUSIC ENHANCER (page 37)
 - BASS EXTENSION (page 37)
 - Adaptive DRC (page 37)

Controlling external components

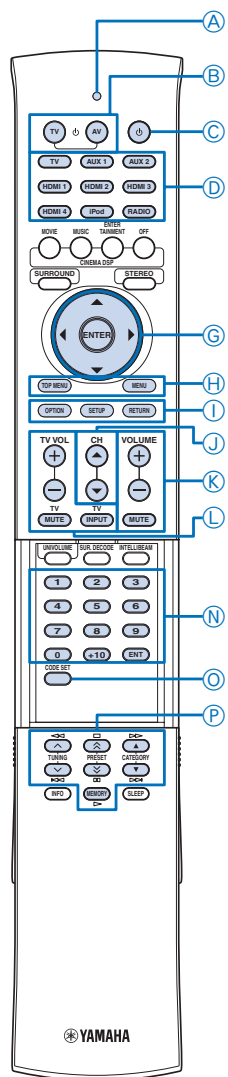

Ⓐ Transmission indicator

Ⓑ AV

Ⓒ TV

Ⓓ Power

Ⓔ Input selector keys

Ⓕ Cursor (▲ / ▼ / ◀ / ▶) keys

Ⓖ ENTER

Ⓗ MENU

Ⓖ TOP MENU

Ⓘ RETURN

Ⓙ CH ▲ / ▼

Ⓚ MUTE

Ⓛ VOLUME +/-

Ⓛ TV operation keys

Ⓝ Numeric keys

Ⓞ CODE SET

Ⓟ External component operation keys

Note

Depending on the external AV component you are using, you may not be able to operate the component with the remote control, even if a remote control code is set. In this case, operate the component using the supplied remote control.

You can control external components using the following keys on the remote control of this unit by setting the appropriate remote control codes (page 49). Before operating the control keys, press one of the Ⓓ Input selector keys to select an external component to be controlled.

Ⓑ TV ⏻

Turns on the power of your TV or set it to the standby mode.

Ⓑ AV ⏻

Turns on the power of the selected component or set it to the standby mode.

Ⓕ Cursor (▲ / ▼ / ◀ / ▶) keys, ENTER

Use to select menu items.

Ⓖ TOP MENU

Displays the top menu of a Blu-ray disc or DVD.

Ⓖ MENU

Displays the menu of a Blu-ray disc or DVD.

Ⓘ RETURN

Returns to the previous menu screen.

Ⓙ CH ▲ / ▼

Switches between available channels for your external component.

Ⓛ TV operation keys

TV VOL +/-

Adjusts the audio output level of your TV.

TV MUTE

Temporarily mutes audio output from your TV.

TV INPUT

Switched the input source for your TV.

Ⓝ Numeric keys

Use to enter numeric digits or specify a channel number.

Ⓞ CODE SET

Sets remote control codes for external component operations (page 42).

Ⓟ External component operation keys

Use to control playback of your external component.



• The Ⓑ TV ⏻ and Ⓛ TV operation keys always work regardless of the selected input source.

Notes

• Depending on external components, some or all operations may not work. In this case, operate the component using the supplied remote control.

• If you operate your TV with the remote control of this unit when the HDMI control function is activated, this unit or external component connected to this unit with HDMI works improperly in some cases.

Setting remote control codes

1 While holding down Ⓞ CODE SET, press Ⓓ Input selector key to which the remote control code is assigned.

Ⓐ Transmission indicator flashes twice.

2 Release Ⓞ CODE SET.

3 Press Ⓝ Numeric keys to enter the remote control code (page 49) for your external component.

Each time you press you press the key,

Ⓐ Transmission indicator flashes once. Once the 5-digit remote control code is entered properly,

Ⓐ Transmission indicator lights up for approximately 2 seconds.



• To clear remote control code set to a selected input source, enter "00010".

Note

• If any key other than Ⓝ Numeric keys is pressed,

Ⓐ Transmission indicator flashes 5 times and the setting mode is canceled.

4 Perform a test operation using the remote control of this unit.

If the external component functions correctly, the remote control code setup is successful. If it does not function correctly, the remote control code may be incorrect. Check the remote control code for your external component (page 49) and try again.

Note

• If no operation is performed after step 1 or in the middle of step 2 within 30 seconds, Ⓐ Transmission indicator flashes 5 times and the setting mode is canceled.

Resetting all remote control codes

1 While holding down Ⓞ CODE SET, press Ⓘ SETUP.

Ⓐ Transmission indicator flashes twice.

2 Release Ⓞ CODE SET.

3 Press Ⓝ Numeric keys to enter "99999".

Each time you press the Ⓝ Numeric keys,

Ⓐ Transmission indicator flashes once. Once the remote control code is entered properly,

Ⓐ Transmission indicator lights up for approximately 2 seconds and then the initialization is completed.





Note

• If one of the other keys is pressed, Ⓐ Transmission indicator flashes 5 times and the initialization is canceled.

Troubleshooting

Refer to the chart below when this unit does not function properly. If the problem you are experiencing is not listed below or if the instruction below does not help, set this unit to the standby mode, disconnect the AC power supply cable, and contact the nearest authorized Yamaha dealer or service center.

■ General

Problem	Cause	Remedy	See page
This unit does not operate properly.	The internal microcomputer has been frozen by an external electric shock (such as lightning or excessive static electricity) or by a power supply with low voltage.	Disconnect the AC power supply cable from the outlet and plug it in again after about 30 seconds.	12
This unit fails to turn on when  Power key is pressed, or enters the standby mode soon after the power has been turned on.	The AC power supply cable is not firmly connected to the AC wall outlet.	Connect the AC power supply cable firmly to the AC wall outlet.	12
	This unit has been exposed to a strong external electric shock (such as lightning and strong static electricity).	Set this unit to the standby mode, disconnect the AC power supply cable, plug it back in after 30 seconds, and use it normally.	12
This unit suddenly enters the standby mode.	The internal temperature becomes too high and the overheat protection circuitry has been activated.	Wait for about one hour for this unit to cool down and turn it back on.	—
	The sleep timer has turned the unit off.	Turn on the power and play back the source again.	21
No sound.	Incorrect input or output cable connections.	Connect the cables properly. If the problem persists, the cables may be defective.	12
	No appropriate input source has been selected.	Select an appropriate input source with INPUT or  Input selector keys.	21
	The volume is turned down.	Turn up the volume.	21
	The sound is muted.	Press  MUTE or  VOLUME +/- to resume audio output and adjust the volume level.	21
	The signals this unit cannot reproduce (such as PCM signals with more than 96 kHz of sampling frequency) are being received from the source component.	Play a source whose signals can be reproduced by this unit.	—
		Change the system settings of the source component.	—
	The HDMI components connected to this unit do not support the HDCP copy protection standards.	Connect the HDMI components that support the HDCP copy protection standards.	12
	“SUPPORT AUDIO” is set to “OTHER” and HDMI audio signals are not being played back on this unit.	Set “SUPPORT AUDIO” to this unit in “SET MENU”.	39
No sound or too small sound from a specific channel	The output level of the channel is muted.	Raise the output level of the channel.	37
	The beam setting is inappropriate.	Adjust the beam setting.	35
	You play back the source in the stereo mode.	Start surround playback.	22
	Some audio output methods do not output sound beams for certain channels.	Select another beam mode.	23
No sound from the subwoofer.	“BASS OUT” is set to “FRONT OR AUTO” in “SUBWOOFER SET”.	Set “BASS OUT” to “SUBWOOFER” in “SUBWOOFER SET”.	36
	The source does not contain low bass signals.		
No sound from the subwoofer connected by wireless.	The group IDs of this unit and SWK-W10 are not set to the same value.	Check whether the group IDs of this unit and SWK-W10 are set to the same value.	39
	“Wireless Function” is set to “No”.	Set “Wireless Function” to “Yes”.	39
Distorted or too little bass sound.	“CROSS OVER” is set incorrectly in “SUBWOOFER SET”.	Set “CROSS OVER” correctly in “SUBWOOFER SET”.	36

Problem	Cause	Remedy	See page
Surround sound effects are insubstantial.	The listening room is not a regular shape.	Install this unit in a square or rectangular shaped room.	—
	There is no wall in the path of the sound beam.	Try placing a flat object, such as a board, in the path of the sound beam.	—
Digital audio signals cannot be played back. (DIGITAL indicator does not light up in the front panel display.)	The playback component is connected to this unit with an analog connection.	Connect them with an HDMI connection or a digital connection.	12
	The external component is not set to output digital audio signals.	Refer to the owner's manual supplied with your component and check the setting.	—
	Bit streaming is disabled on the external component.	Refer to the owner's manual supplied with your component and check the setting.	—
There is noise interference when a subwoofer is not connected to this unit.	The protection circuitry was in operation because a source with strong bass elements was played back.	Turn down the volume level.	21
		Set "BASS OUT" to "SUBWOOFER" in "SUBWOOFER SET".	36
		Connect a subwoofer and adjust settings for "SUBWOOFER SET".	36
On-screen display does not appear.	The cable is not connected to the TV or this unit properly.	Connect the cable properly.	12
The HDMI control function does not work properly.	"HDMI CONTROL" is set to "OFF" in "SET MENU".	Set "HDMI CONTROL" to "ON" in "SET MENU".	39
	The HDMI control function is disabled on your TV.	Refer to the owner's manual supplied with your TV and check the setting.	—
	The number of the connected HDMI components is over the limit.	Disconnect some of the HDMI components.	—
The automatic lipsync is not effective even "AUTO LIP SYNC" is set to "ON".	The TV does not support the automatic lipsync.	Set "AUTO LIP SYNC" to "OFF" and then manually adjust the audio output delay.	36
"Not Available" appears on the front panel display after key operation.	The key is unable to function in the current condition.		—

■ FM tuner

Problem	Cause	Remedy	See page
FM stereo reception is noisy.	The characteristics of FM stereo broadcasts may cause this problem when the transmitter is too far away or the antenna input is poor.	Check the antenna connections.	14
		Try using a high-quality directional FM antenna.	—
		Use the manual tuning method.	25
There is distortion, and clear reception cannot be obtained even with a good FM antenna.	There is multi-path interference.	Adjust the antenna position to eliminate multi-path interference.	—
The desired station cannot be tuned into with the automatic tuning method.	The signal is too weak.	Use a high-quality directional FM antenna.	—
		Use the manual tuning method.	25
Previously preset stations can no longer be tuned into.	This unit has been disconnected for a long period.	Preset the stations again.	25

■ SIRIUS Satellite Radio

Status message	Cause	Remedy	See page
ANTENNA ERR	The antenna is not connected to the SiriusConnect tuner properly.	Check the connection of the antenna and SiriusConnect tuner.	26
SIRIUS LOADING	This unit is communicating with the SiriusConnect tuner.	The message disappears normally within several tens of seconds.	—
CHECK TUNER	The SiriusConnect tuner is not connected to the SIRIUS jack of this unit correctly.	Check the connection of the SiriusConnect tuner and this unit.	26
	The SiriusConnect tuner is not connected to the AC wall outlet.	Connect the power cable of the SiriusConnect tuner to the AC wall outlet.	26

Status message	Cause	Remedy	See page
ACQUIRING	The signal is too weak.	Adjust the orientation of the antenna of the SiriusConnect tuner. Use the "Antenna Level" information on the front panel display to check the antenna reception level.	—
UPDATE	The SiriusConnect tuner is updating the channel list.	Wait until the updating is complete.	—
	The period of the subscription is end.	Contact SIRIUS Satellite Radio to renew the subscription.	27
FW UPDATING	The SiriusConnect tuner is updating the firmware.	Wait until the updating is complete.	—
SUB UPDATED	The subscription information is updated.	—	—

■ Remote control

Problem	Cause	Remedy	See page
The remote control does not work and/or function properly.	Wrong distance or angle.	The remote control functions within a maximum range of 6 m (20 ft) and no more than 30 degrees off-axis from the front panel.	14
	Direct sunlight or lighting (from an inverter type of fluorescent lamp, etc.) is striking the remote control sensor of this unit.	Reposition this unit.	—
	The batteries are weak.	Replace all batteries.	14
Cannot operate external components with the remote control of this unit.	The external component you want to operate is not selected as the input source.	Press the desired  Input selector key to select the external component you want to operate.	42
	The remote control code was not correctly set.	Set the remote control code correctly or try another code for the same manufacturer using the "List of remote control codes".	42
	Even if the remote control code is correctly set, there are some models that do not respond to the remote control.	Use the remote control supplied with the external component.	—

■ iPod

Problem	Cause	Remedy	See page
No sound.	PDX-50TX is connected to another device.	Select the same group ID as selected on this unit.	—
	PDX-50TX and this unit are not connected since they are set to different groups.	Set both PDX-50TX and this unit to the same group.	39
	"Wireless Function" is set to "No".	Set "Wireless Function" to "Yes".	39
	Distance is too far.	Move PDX-50TX closer to this unit.	—
	There is a device (microwave oven, wireless LAN, etc.) outputting signals in 2.4 GHz frequency band nearby.	Move this unit away from the device. If the device is IEEE802.11n-compliant, change the channel setting of the device so as not to affect the unit.	—
	The iPod or iPhone is not connected to PDX-50TX firmly.	Connect the iPod or iPhone firmly.	—
	The firmware of the iPod or iPhone is not updated.	Download the latest iTunes software to update the firmware of the iPod or iPhone.	—
	The signal from PDX-50TX is blocked by your body or metallic objects, etc.	Change the way of holding, orientation, or position of PDX-50TX to avoid the object blocking the signal.	—
	The battery of iPod or iPhone is low.	Charge the iPod or iPhone.	—
	The iPod or iPhone is in the process of connecting with this unit.	Please wait for a while.	—
	The protection circuitry has been activated by excessive volume.	Turn down the volume.	21
Controlling volume on the iPod or iPhone does not work.	The iPod or iPhone being used is not supported by this unit.	Use an iPod or iPhone supported by this unit.	30
	The iPod or iPhone is not connected to PDX-50TX firmly.	Connect the iPod or iPhone firmly.	—

Problem	Cause	Remedy	See page
Suddenly this unit produces sounds even though an iPod or iPhone is not connected.	This unit is connected to another device.	Change the group ID of this unit.	39
The iPod/iPhone interlock function does not work.	"iPod Interlock" is set to "OFF".	Set "iPod Interlock" to "ON".	39

■ Dolby Digital

Dolby Digital is a digital surround sound system that gives you completely independent multi-channel audio. With 3 front channels (left, center, and right) and 2 surround stereo channels, Dolby Digital provides 5 full-range audio channels. With an additional channel especially for bass effects, called LFE (low-frequency effect), the system has a total of 5.1-channels (LFE is counted as 0.1-channel). By using 2-channel stereo for the surround channels, more accurate moving sound effects and surround sound environment are possible than with Dolby Surround. The wide dynamic range (from maximum to minimum volume) reproduced by the 5 full-range channels and the precise sound orientation generated using digital sound processing provide listeners with excitement and realism previously unheard of. With this unit, any sound environment from monaural up to a 5.1-channel configuration can be freely selected for your enjoyment.

■ Dolby Digital Surround EX

Dolby Digital EX creates 6 full-bandwidth output channels from 5.1-channel sources.

For the best results, Dolby Digital EX should be used with movie sound tracks recorded with Dolby Digital Surround EX. With this additional channel, you can experience more dynamic and realistic moving sound especially with scenes with “fly-over” and “fly-around” effects.

■ Dolby Digital Plus

Dolby Digital Plus is an advanced audio technology developed for high-definition programming and media including HD broadcasts, and Blu-ray Disc. Selected as an optional audio standard for Blu-ray Disc, this technology delivers multichannel sound with discrete channel output. Supporting bitrates up to 6.0 Mbps, Dolby Digital Plus can carry up to 7.1 discrete audio channels simultaneously. Supported by HDMI version 1.3 and designed for the optical disc players and AV receivers/amplifiers of the future, Dolby Digital Plus also remains fully compatible with the existing multichannel audio systems that incorporate Dolby Digital.

■ Dolby Pro Logic II

Dolby Pro Logic II is an improved technique used to decode vast numbers of existing Dolby Surround software. This new technology enables a discrete 5-channel playback with 2 front left and right channels, 1 center channel, and 2 surround left and right channels (instead of only 1 surround channel for conventional Pro Logic technology). Music and Game modes are also available for 2-channel sources in addition to the Movie mode.

■ Dolby Pro Logic IIx

Dolby Pro Logic IIx is a new technology enabling discrete multichannel playback from 2-channel or multi-channel sources. There are three modes available: “Music mode” for music sources, “Movie mode” for movie sources (for 2-channel sources only) and “Game mode” for game sources.

■ Dolby Surround

Dolby Surround uses a 4-channel analog recording system to reproduce realistic and dynamic sound effects: 2 front left and right channels (stereo), a center channel for dialog (monaural), and a surround channel for special sound effects (monaural). The surround channel reproduces sound within a narrow frequency range.

Dolby Surround is widely used with nearly all video tapes and laser discs, and in many TV and cable broadcasts as well. The Dolby Pro Logic decoder built into this unit employs a digital signal processing system that automatically stabilizes the volume on each channel to enhance moving sound effects and directionality.

■ Dolby TrueHD

Dolby TrueHD is an advanced lossless audio technology developed for high-definition disc-based media including Blu-ray Disc. Selected as an optional audio standard for Blu-ray Disc, this technology delivers sound that is bit-for-bit identical to the studio master, offering a high-definition home theater experience.

Supporting bitrates up to 18.0 Mbps, Dolby TrueHD can carry up to 8 discrete channels of 24-bit/96 kHz audio simultaneously.

Dolby TrueHD also remains fully compatible with the existing multichannel audio systems and retains the metadata capability of Dolby Digital, allowing dialog normalization and dynamic range control.

■ DTS 96/24

DTS 96/24 offers an unprecedented level of audio quality for multi-channel sound on DVD video, and is fully backward-compatible with all DTS decoders. “96” refers to a 96 kHz sampling rate compared to the typical 48 kHz sampling rate. “24” refers to 24-bit word length.

DTS 96/24 offers sound quality transparent to the original 96/24 master, and 96/24 5.1-channel sound with full-quality full-motion video for music programs and motion picture soundtracks on DVD video.

■ DTS Digital Surround

DTS digital surround was developed to replace the analog soundtracks of movies with a 6-channel digital sound track, and is now rapidly gaining popularity in movie theaters around the world. DTS, Inc. has developed a home theater system so that you can enjoy the depth of sound and natural spatial representation of DTS digital surround in your home. This system produces practically distortion-free 6-channel sound (technically, left, right, and center channels, 2 surround channels, plus an LFE 0.1-channel as a subwoofer, for a total of 5.1 channels). The unit incorporates a DTS-ES decoder that enables 6.1-channel reproduction by adding the surround back channel to existing 5.1-channel format.

■ DTS Neo:6

Neo:6 decodes the conventional 2-channel sources for 6-channel playback by the specific decoder. It enables playback with the full-range channels with higher separation just like digital discrete signal playback. Two modes are available: Music mode for playing music sources and Cinema mode for movies.

■ DTS-HD High Resolution Audio

DTS-HD High Resolution Audio is a high resolution audio technology developed for high-definition disc-based media including Blu-ray Disc. Selected as an optional audio standard for Blu-ray Disc, this technology delivers sound that is virtually indistinguishable from the original, offering a high-definition home theater experience.

Supporting bitrates up to 6.0 Mbps for Blu-ray Disc, DTS-HD High Resolution Audio can carry up to 7.1 discrete channels of 24-bit/96 kHz audio simultaneously.

DTS-HD High Resolution Audio also remains fully compatible with the existing multichannel audio systems that incorporate DTS Digital Surround.

■ DTS-HD Master Audio

DTS-HD Master Audio is an advanced lossless audio technology developed for high-definition disc-based media including Blu-ray Disc. Selected as an optional audio standard for Blu-ray Disc, this technology delivers sound that is bit-for-bit identical to the studio master, offering a high-definition home theater experience.

Supporting bitrates up to 24.5 Mbps for Blu-ray Disc, DTS-HD Master Audio can carry up to 7.1 discrete channels of 24-bit/96 kHz audio simultaneously. Supported by HDMI version 1.3 and designed

for the optical disc players and AV receivers/amplifiers of the future, DTS-HD Master Audio also remains fully compatible with the existing multichannel audio systems that incorporate DTS Digital Surround.

■ HDMI

HDMI (High-Definition Multimedia Interface) is the first industry-supported, uncompressed, all-digital audio/video interface. Providing an interface between any source (such as a set-top box or AV receiver) and an audio/video monitor (such as a digital television), HDMI supports standard, enhanced, or high-definition video as well as multi-channel digital audio using a single cable. HDMI transmits all ATSC HDTV standards and supports 8-channel digital audio, with bandwidth to spare to accommodate future enhancements and requirements.

When used in combination with HDCP (High-bandwidth Digital Content Protection), HDMI provides a secure audio/video interface that meets the security requirements of content providers and system operators. For further information on HDMI, visit the HDMI website at “<http://www.hdmi.org/>”.

■ LFE 0.1-channel

This channel is for the reproduction of low bass signals. The frequency range for this channel is 20 Hz to 120 Hz. This channel is counted as 0.1 because it only enforces a low-frequency range compared to the full-range reproduction by the other 5/6 channels in Dolby Digital or DTS 5.1/6.1-channel systems.

■ PCM (Linear PCM)

Linear PCM is a signal format under which an analog audio signal is digitized, recorded, and transmitted without using any compression. This is used as a method of recording CDs and DVD audio. The PCM system uses a technique for sampling the size of the analog signal per very small unit of time. Standing for pulse code modulation, the analog signal is encoded as pulses and then modulated for recording.

■ “x.v.Color”

A color space standard supported by HDMI version 1.3. It is a more extensive color space than sRGB, and allows the expression of colors that could not be expressed before. While remaining compatible with the color gamut of sRGB standards, “x.v.Color” expands the color space and can thus produce more vivid, natural images. It is particularly effective for still pictures and computer graphics.

Specifications

AMP SECTION

- Maximum Output Power
 - Woofer 20 W/ch (4 Ω, 100 Hz, 10% THD)
 - Small dia. speaker 2 W/ch (4 Ω, 1 kHz, 10% THD)

SPEAKER SECTION

- Speaker type 2-way acoustic suspension magnetic
- Driver
 - Small dia. speakers 4 cm (1-1/2 in) cone magnetic shielding type × 40
 - Woofers 11 cm (4-1/2 in) cone × 2
 - Tweeters (YSP-5100 only) 2.5 cm (1 in) balanced dome × 2
- Frequency response
 - YSP-5100 75 Hz to 20 kHz (-10dB, Stereo mode)
 - YSP-4100 90 Hz to 20 kHz (-10dB, Stereo mode)

CONNECTIONS

- Input Jacks
 - TV, AUX 1 AUDIO IN 2 pairs (Analog)
 - TV, AUX 1 DIGITAL IN
(FS=32 kHz, 44.1 kHz, 48 kHz, 64 kHz, 88.2 kHz, 96 kHz)
..... 2 (Optical digital)
 - AUX 2 DIGITAL IN
(FS=32 kHz, 44.1 kHz, 48 kHz, 64 kHz, 88.2 kHz, 96 kHz)
..... 1 (Coaxial digital)
 - AUX 1 VIDEO IN 1 (Composite)
[U.S.A., Canada, Korea, and General models] NTSC
[Other models] PAL
 - AUX 2 VIDEO IN 1 (Component)
 - HDMI IN 4
- Output Jacks
 - SUBWOOFER 1
 - VIDEO OUT (composite input or menu screen) 1 (Composite)
[U.S.A., Canada, Korea, and General models] NTSC
[Other models] PAL
 - HDMI OUT 1
- System Connector Jack
 - INTELLIBEAM MIC 1 (Microphone input)
 - RS-232C 1 (System control)
 - SYSTEM CONNECTOR 1 (for subwoofer power interlock)
 - IR IN 1 (System control)
 - IR-OUT 1 (System control)

FM SECTION

- Tuning Range
 - [U.S.A. and Canada models] 87.5 to 107.9 MHz
 - [Other models] 87.50 to 108.00 MHz

Wireless

- Frequency 2.4 GHz

GENERAL

- Power Supply
 - [U.S.A. and Canada models] AC 120 V, 60 Hz
 - [Australia model] AC 220–240 V, 50/60 Hz
 - [Europe and Russia models] AC 220–240 V, 50/60 Hz
 - [Korea model] AC 220–240 V, 50/60 Hz
 - [General model] AC 110–120 V, 50/60 Hz
 - [China and Asia models] AC 220–240 V, 50/60 Hz
- Power Consumption 55 W
- Standby Power Consumption
 - HDMI Control OFF/Wireless Power OFF 0.5 W or less
 - HDMI Control ON/yAired ON (factory preset) 1.0 W or less
- Dimensions (W x H x D)
 - YSP-5100
 - Maximum dimension 1200 x 212 x 90 mm (47-1/4 x 8-3/8 x 3-1/2 in)
 - With stands 1200 x 214 x 110.7mm (47-1/4 x 8-3/8 x 4-3/8 in)
 - YSP-4100
 - Maximum dimension 1030 x 212 x 90 mm (40-1/2 x 8-3/8 x 3-1/2 in)
 - With stands 1030 x 214 x 110.7mm (40-1/2 x 8-3/8 x 4-3/8 in)
- Weight
 - YSP-5100 11.0 kg (24.2 lbs)
 - YSP-4100 10.0 kg (22.0 lbs)

* Specifications are subject to change without notice.

HDMI interface of this unit is based on the following standard:

- HDCP (High-bandwidth Digital Content Protection System) licensed by Digital Content Protection, LLC.

List of remote control codes

TV	BASIC	00101	16701, 16801, 17801,	DUMONT	00201, 15401, 16301
ACCENT	BASIC LINE	14701, 14801, 15701,	17901, 18101, 18201,	DURABRAND	16801, 17601, 18201
ACCUPHASE		15901, 16201	18601	DUX	15701, 16201
ACTION	BAUR	00401, 04601, 06701,	CITY	D-VISION	15701, 16201
ACURA		14701, 14801, 15701,	CLARION	DWIN	09201, 10101
ADDISON		16101, 16201	CLARIVOX	DYNAMIC	14801
ADMIRAL	BAYSONIC	02701	CLATRONIC	DYNATECH	15401
	BEAUMARK	02601		DYNATRON	15701, 16201
	BEC	14701	CLP CLASSIC	DYNEX	15701
	BECRESE	14701, 15401	COLORTYME	ECE	00401
ADVENT	BEKO	04701, 06201, 09001,	COMPUTRON	ELBE	03501, 15001, 15701,
ADYSON		09101, 14701, 15701,	CONCERTO		16201
AEA		16201	CONCORDE	ELBIT	14701
AGB	BELCOR	16301	CONDOR	ELECS	14701
AIKO	BELL & HOWELL			ELECTRATUNE	
		02001, 14701, 18401,	CONIC		15401
AIM		18601, 18701	CONRAC	ELECTRO TECH	
AIWA	BENCHMARK-BEAUMARK		CONRAD		14801
		14701, 14801, 15401	CONTEC	ELECTROBAND	
AKAI	BEON	00401, 14701, 15701,			00001
		16201	CONTINENTAL EDISON	ELECTROHOME	
	BESTAR	14701, 14801, 15701,			15401, 16301, 17901,
		15901, 16201	CORONADO		19001
	BESTAR-DAEWOO		COSMEL	ELECTRONIKA	
		15901	CRAIG		14701
AKIBA	BIGSTON	14801	CROSLEY	ELEKTA	14801, 15701, 16201
AKITO	BLACK DIAMOND		CROWN	ELEKTRA	18601
AKURA		16201		ELEKTRONIKA	
	BLAUPUNKT	02801			14701
ALBA	BLUE SKY	08501, 11401, 14701,		ELG	15701, 16201
		15701, 16201	CRYSTAL	ELIN	00401, 06901, 14701,
	BONDSTEC	03301, 15501	CTC		14801, 15701, 16101,
ALFA	BPL	15701, 16201	CURTIS MATHES		16201
ALLSTAR	BRADFORD	02701		ELITE	04101, 14701, 15401,
AMERICA ACTION	BRANDT	01701, 04201, 15801,			15701, 16201
		16001		ELTA	00101, 14801, 14901
AMPRO	BRENDSTAR	14801		EMERSON	02001, 02601, 02701,
AMSTRAD	BRINKMANN	15701, 16201			03101, 04601, 05801,
	BRIONVEGA	14701, 15001, 15701,			07901, 15401, 15701,
		16201			16201, 16301, 16801,
ANAM	BRIORRYEGA	14701			17201, 17701, 17901,
	BROCKWOOD	15401	CXC		18201, 18501, 19301
ANAM NATIONAL	BROKSONIC	03101, 05801, 15401,	DAEWOO	ENVISION	00301, 10601, 16301,
		16801			17901
	BROKWOOD	16301		EPSON	11001
ANGLO	BUSH	00101, 00101, 00401,		ERRES	00401, 14701, 15701,
ANITECH		04801, 04901, 08501,			16201
		11401, 14701, 15701,		ESC	15701, 16201
		15901, 16101, 16201		ETHER	00101, 00301
ANSONIC	BYDESIGN	14301, 14401, 14501,		ETRON	00101, 14801, 15701,
		14601	DAICHI		16201
AOC	CAMPLE	15401	DANSAI	EUROMAN	15701, 16201
	CANDLE	00301, 15401, 16301,		EUROMANN	14701
		17801, 17901	DAWA	EUROPA	15701, 16201
	CAPEHART	14701, 15401	DAYTON	EUROPHON	06801, 14701, 15701,
APEX DIGITAL	CARAD	15701, 16201	DAYTRON		16201
	CARENA	15701, 16201		EXCEL	15701, 16201
	CARNIVALE	00301		EXQUISIT	15701, 16201
AR SYSTEM	CARREFOUR	14701, 15701, 16201	DE GRAAF	FAMILY LIFE	15701, 16201
ARC EN CIEL	CARVER	00801, 02401, 14701	DECCA	FENNER	14801, 15901
ARCAM	CASCADE	00101, 15701, 16201		FERGUSON	00401, 01001, 01701,
ARDEM	CASIO	15701, 16101, 16201	DEITRON		03201, 03801, 04201,
ARISTONA	CATHAY	00401, 14701, 15701,	DENON		07101, 15701, 15801,
ART TECH		16201	DENVER		16201
ASA	CCE	00401, 15701, 16201	DESMET	FIDELIS	14801
ASBERG	CELEBRITY	00001		FIDELITY	04601, 15701, 16201
ASORA	CELERA	09701	DIAMANT	FILSAI	14801
ASTRA	CENTURION	00401, 14701, 15701,	DIAMOND	FINLANDIA	02901, 04401, 15801
ATLANTIC		16201, 17901	DIGATRON	FINLUX	00401, 01401, 01501,
ATORI	CGE	03301, 14801, 16001	DIGILINE		04401, 06801, 14701,
ATORO	CGM	14801	DIGISTAR		14801, 15101, 15701,
AUDIOSONIC	CHANGHONG	09701	DIGITOR		16201
	CHING TAI	00101, 01201	DIK	FIRST LINE	14701, 14801, 15701,
	CHUN YUN	00001, 00101, 01201,	DIMENSIA		15901, 16101, 16201
		02701	DIXI	FIRSTAR	00101, 03101
AUDIOTON	CHUNG HSIN	00701, 01601, 02701		FIRSTLINE	00101, 03301, 08501
AUDIOVOX	CIE	14801	DORIC	FISHER	01401, 02001, 02901,
AUTOVOX	CIMLINE	00101, 14801	DTS		04701, 16101, 18901
AWA	CINERAL	01201, 05601	DUAL	FLINT	05701, 14701, 15701,
	CIRCUIT CITY	15401			16201
BAIRD	CITIZEN	00301, 00901, 01201,		FORMENTI	00401, 04101, 14701,
BANG & OLUFSEN		14701, 15401, 16301,			15701, 16201

FORTRESS	01301, 15401	HARRAD	15401	18701, 18901, 19001, 19101,	LUMA	14701, 14801, 15001, 15701, 15901, 16201	
FRABA	15701, 16201	HARVARD	02701, 15401		LUMATRON	15701, 16201	
FRIAC	15701, 16201	HARWOOD	15701, 16201	JCB	00001	LUX MAY	14701, 15701, 16201
FRONTECH	02201, 03301, 03701, 14801, 16101	HAUPPAUGE	15701, 16201	JEAN	00101, 00601, 01201, 02101, 03101	LUXMAN	16301, 17901
FUJITSU	08701, 10401, 15401, 15701, 16201	HAVERMY	01301	JENSEN	09601, 16301, 17901, 19501	LUXOR	04501, 04601, 15201, 16101
FUJITSU GENERAL	15001	HCM	00101, 05101, 14801, 15701, 16201	JETPOINT	14701	LXI	00501, 00801, 02001, 02101, 02601, 14701, 16301, 16601, 17401, 17701, 17901, 18101, 18401, 18701
FUNAI	02501, 02701, 03701, 14801, 15401, 17201, 17701, 18201	HEATHKIT	14701	JINLIPU	14801	M ELECTRONIC	000101, 00401, 01401, 01501, 01701, 02201, 03801, 04401, 04901, 06001, 14801
FUTURE	15701, 16201	HEDZON	15701, 16201	JMB	15701, 15901, 16201	M ELECTRONICS	14701, 14801
FUTURETECH	02701	HELLO KITTY	05601	JULIBEE	16201	MACYS	15401
GALAXI	15701, 16201	HEMMERMANN	16101	JUMBOTRONIC	14701	MADISON	15701, 16201
GALAXIS	15701, 16201	HIFIVOX	16001	JVC	00701, 04801, 05801, 08401, 08701, 14701, 18901	MAGNADYNE	03301, 06801, 14701, 14801
GALERIA	14801	HIGHLINE	15701, 16201	KAISER	14701	MAGNAFON	06801
GATEWAY	13301, 13401	HILINE	14801	KAISUI	00101, 14701, 14801, 15701, 16201	MAGNASONIC	14701, 14801, 15401
GBC	14801, 15901	HINARI	00101, 00401, 14701, 14801, 15701, 16201	KAPSCHE	02201	MAGNAVOX	00301, 00801, 12001, 12601, 14701, 15701, 16201, 16301, 17201, 17801, 17901
GE	00301, 00501, 00601, 01201, 02601, 02701, 05601, 07101, 11801, 12201, 12601, 15801, 16301, 16401, 16601, 17301, 17401, 17901, 18401, 18701, 19001, 19101	HITACHI	00101, 00301, 01201, 01501, 01701, 01801, 02201, 02601, 03001, 04501, 06101, 06901, 07301, 11701, 12101, 14701, 15401, 15701, 15801, 16101, 16201, 16301, 17701, 17901, 18601, 18901	KARCHER	07701, 14701, 14801, 15701, 16201	MANHATTAN	15701, 16201
GEC	00401, 06801, 15701, 16101, 16201	HORIZONT	14701	KATHREIN	07001, 15701, 16201	MARANTZ	00301, 00401, 00801, 07001, 14701, 15701, 16201, 16301, 17901
GELOSO	00101, 14801, 15901	HORNYPHON	14701	KAWASHO	16301, 17901	MARK	00401, 14701, 15701, 15901, 16201
GEMSOUND	14801	HORNYPHONE	15701, 16201	KEC	02701	MASUDA	15701, 16201
GENERAL	14801	HUA TUN	00101	KENDO	00401, 14701, 14801, 15001, 15701, 16201	MATSUI	00101, 00401, 02901, 04801, 06301, 06801, 14701, 14801, 15701, 16101, 16201
GENERAL ELECTRIC	15801	HUANYU	04901, 15901	KENWOOD	00301, 15401, 16301, 17901	MATSUSHITA	03401, 08301
GENERAL TECHNIC	14801	HYPER	14801, 15501	KIOTA	14801	MAVA	15401
GENEXXA	02201, 14701, 15701, 16201	HYPSON	00401, 03701, 14701, 14801, 15701, 16201	KITION	16201	MAXAM	14801
GIBRALTER	00201, 00301, 16301	IBERIA	15701, 16201	KITON	15701	MAXELL	14801
GITEM	14701	ICE	03701, 04801, 14701, 14801, 15701, 16201	KLH	15401	MCE	14801
GM	14801	ICT	15701, 16201	KNEISSEL	03501, 05401, 15301, 15701, 15901, 16201	MEDIATOR	00401, 14701, 15701, 16201
GMG	14801	IMA	15401	KOBIC	14801	MEDION	08501, 10301, 11401, 15701, 16201
GOLDHAND	14801	IMPERIAL	03301, 04701, 05201, 14701, 15701, 16101, 16201	KOLIN	00701, 01601, 02701	MEGATRON	01801, 02601, 16301, 17901
GOLDSTAR	00301, 00401, 01701, 02001, 02601, 05001, 14701, 14801, 15201, 15401, 15501, 15701, 16201, 16301, 16501, 17701, 17901, 18901	INDIANA	00401, 14701, 15701, 16201	KOLSTER	14701, 15701, 16101, 16201	MELECTRONIC	15701, 15801, 15901, 16101, 16201
GOODMANS	00401, 04801, 04901, 08201, 14701, 14801, 15701, 15801, 15901, 16201	INFINITY	00801, 14701	KONICHI	14801	MEMOREX	00101, 01901, 02001, 02601, 03401, 05801, 11401, 14801, 16301, 16801, 17901, 18401, 18601, 18701
GOREMJE	04701	INGELEN	02201	KONKA	15701, 16201, 18001, 19401	MERCURY	14801, 15701, 16201
GPM	14801	INGERSOLL	14801	KORPEL	00401, 14701, 15701, 16201	METZ	05501, 15701, 16201
GRADIENSTE	00701, 02401, 15701, 16201	INNO HIT	06801, 14701, 14801, 15201, 15701, 16201	KOSMOS	15701, 16201	MGA	00301, 01901, 02601, 15701, 16201, 16301, 16501, 17901, 18901, 19001
GRADIN	14701, 14801	INNOVA	00401	KOYODA	00101	MICROMAXX	10301, 15701, 16201
GRAETZ	02201, 04601, 15701, 16201	INNOVATION	15701, 16201	KTV	00301, 02701, 15401	MICROSTAR	10301
GRANADA	00401, 02901, 04301, 06801, 14701, 15701, 15801, 16201	INSIGNIA	16801, 17001, 17201, 17501, 17601, 18001, 18201, 19401, 19501	KUASHO	14701, 15401	MIDLAND	00201, 00501, 00601, 15401, 16401, 16601, 17401, 18701
GRANDIN	07701, 15701, 15901, 16201	INTEQ	00201	KUBA	16101	MINATO	15701, 16201
GRENADIER	14801	INTERACTIVE	15701, 16201	KUBA ELECTRONIC	16101	MINERVA	06301
GRUNDIG	00401, 02801, 06301, 07001, 07401, 15701, 16201	INTERBUY	14801, 15701, 16201	KUBA ELECTRONIC	16101	MINOKA	05101, 14701, 15701, 16201
GRUNPY	02701	INTERDISCOUNT	14701	KURAZAI	18601	MINUTZ	19101
GTT	14801	INTERFUNK	00401, 02201, 03301, 04601, 06701, 14701, 15701, 16101, 16201	L&S ELECTRONIC	10301	MITSUBISHI	00301, 01301, 01601, 01901, 02001, 02601, 02701, 03101, 03401, 06701, 11201, 11901, 14701, 14801, 15701, 16201, 16301
HAIER	17601, 18801	INTERNAL	15701, 15901, 16201	LEADER	14801	MIVAR	03901, 04001, 06801, 07601, 15201, 15301
HALLMARK	02601, 15401, 16301, 17901	INTERVISION	00401, 03701, 05001, 14901, 15701, 16201	LECSON	15701, 16201	MONTGOMERY WARD	18401, 18601,
HANKOOK	00301, 02601, 02701	IRRADIO	14701, 14801, 15101, 15201, 15501, 15701, 16201	LEGEND	14801		
HANSEATIC	00401, 04101, 04601, 05201, 07001, 14701, 14801, 15301, 15701, 16101, 16201	IST	14701	LENCO	14701, 14801, 15701, 15901, 16201		
HANTAREX	06801, 14701, 14801, 15701, 16201	ISUKAI	14701, 15701, 16201	LENOIR	14801		
HANTOR	15701, 16201	ITL	14801	LEVIS AUSTRIA	15701, 16201		
HARLEY DAVIDSON	15401	ITS	04801, 14801, 15701, 16201	LEYCO	00401, 03701, 14701, 15701, 16201		
HARMAN/KARDON	00801	ITT	02201, 04601, 06901, 16101	LG	00301, 00401, 00901, 01601, 02601, 09001, 15701, 16201, 16301, 16501, 17701, 17901, 18901		
		ITT NOKIA	16101	LIESENK & TTER	00401, 15701, 16201		
		ITV	15701, 15901, 16201	LIESENK?TTER	14701		
		JBL	00801, 14701	LIESENKOTTER	14701, 15701, 16201		
		JC PENNEY	16301, 16401, 16501, 16601, 16701, 17301, 17401, 17801, 17901, 18101, 18401, 18501,	LIFE	14801		
				LIFETEC	14801, 15701, 15901, 16201		
				LINITRON	15401		
				LLOYD	15401		
				LLOYD'S	14801		
				LODGENET	18401, 18601, 18701		
				LOEWE	06701, 14701, 15701, 16201		
				LOGIK	15701, 16201, 18401, 18601, 18701		

MORGAN'S	18701	16201	PYMI	14801	SAMSUX	15401, 17901	
MOTOROLA	15701, 16201	OTTO-VERSAND	14701, 14801, 14901	QUASAR	SAMTRON	16701	
MTC	01301, 14701	PACIFIC	15701, 16201	QUELLE	SANKY	15401	
	00301, 00901, 06701,	PAEL	15101		SANSEI	05601	
	15401, 16101, 16301,	PALLADIUM	04701, 05201, 14701,		SANSUI	05801, 14701, 14801,	
	16501, 16701, 17901,		15701, 16101, 16201			15401, 15701, 16201,	
	18101	PALSONIC	15701, 16201			16801	
MULTITEC	15701, 16201	PANAMA	03701, 14801, 15701,		SANYO	01401, 02001, 02701,	
MULTITECH	00101, 02701, 14701,		16201	R LINE		02901, 04301, 10201,	
	14801, 15401, 15701,	PANASHIBA	14801	RADIALVA		14801, 15301, 15701,	
	16101, 16201	PANASONIC	00401, 00601, 00801,	RADIO SHACK		16201, 16301, 18901	
MUSIKLAND	15701, 16201		02201, 03401, 08301,		SAVE	15701, 16201	
MYRYAD	07001, 15701, 16201		12401, 14701, 15701,		SBR	00401, 14701, 15701,	
NAD	02101, 02601, 04601,		16201, 16401	RADIOLA		16201	
	11301, 16301, 17901,	PANAVISION	15701, 16201		SCEPTRE	20201	
	18101	PANAVOX	14801		SCHAUB LORENZ		
NAIKO	15701, 16201	PANORAMA	14801	RADIOMARELLI		04601, 15901, 16101	
NAKIMURA	15701, 15901, 16201	PATHE CINEMA	03201, 04101, 15301,	RADIOSHACK		00401, 03301, 04801,	
NAMSUNC	14801		16101		SCHNEIDER	08501, 14701, 14801,	
NATIONAL	14701	PATHE MARCONI	16001	RADIOSTONE		15001, 15301, 15501,	
NEC	00101, 00301, 00601,	PAUSA	00101, 14801	RADIOTONE		15601, 15701, 15801,	
	02001, 02101, 02401,	PCE/PEC	15401	RCA		16101, 16201	
	02601, 05701, 06501,	PENNEY	00301, 00501, 00601,		SCOTCH	02601, 16301, 17901	
	13201, 14801, 15701,		00901, 02101, 02601,		SCOTT	02601, 02701, 03101,	
	15901, 16201, 16301,		12201, 15401			15401, 16301, 17901	
	16501, 17901	PERDIO	04101, 15701, 16201		SEARS	00501, 00801, 02001,	
NECKERMANN	00401, 07001, 14701,	PERFEKT	14701, 15701, 16201			02101, 02501, 02601,	
	14801, 15001, 15701,	PHILCO	00301, 00401, 00801,			16301, 16601, 16701,	
	16101, 16201		01801, 02601, 02701,			17201, 17401, 17901,	
NEI	00401, 14701, 15701,		03301, 05801, 13101,	REALISTIC		18101, 18201, 18401,	
	16201		14701, 14801, 15701,			18701, 18901	
NETSAT	00401, 15701, 16201		16201, 16301, 16501,		SEG	03701, 08501, 14801,	
NEUFUNK	15701, 16201		17801, 17901			15401, 15701, 16101,	
NEWAVE	00101, 01201, 01301,	PHILIPS	00001, 00301, 00401,	RECOR		16201	
	02601		00601, 00801, 01201,	RECORD		SEI	06801, 15701, 16101,
NEWTECH	14701, 14801, 15701,		01601, 02601, 04901,	RECTILIGNE		16201	
	15801, 16201		07001, 08801, 12601,	REDIFFUSION		SEI-SINUDYNE	
NEXSTECH	17501		15701, 15801, 15901,	REDSTAR			14701, 15701, 16201
NIKKAI	00401, 03701, 14701,		16201, 16301	REFLEX		SELECO	02201, 03501, 15001,
	15401, 15701, 16201		17201, 17301, 17801,	REGENTE			15301
NIKKO	00301, 01201, 02601,		18201	REOC		SEMIVOX	02701
	16301, 17901	PHILIPS (F)	14701	REVOX		SEMP	02101
NOBLEX	14801	PHOENIX	14701, 15701, 16201			SEMUA	15401
NOBLIKO	15101	PHONOLA	00401, 14701, 15701,	REVOX/STUDER		SENCORA	14801
NOGAMATIC	16001		16201	REX		SENTRA	16101
NOKIA	04601, 05901, 06001,	PILOT	00301, 15701, 16201,			SHARP	00301, 01301, 08301,
	06901, 08101, 14801,		16301	RFT			15401, 16301, 17901
	15901, 16101	PIONEER	01701, 02201, 02301,			SHEN YING	00101, 01201
NONAME	14701		03801, 08601, 09501,	RICOH		SHENG CHIA	00101, 01301, 03101
NORCENT	09301, 10801		11301, 14701, 15701,	R-LINE		SHINTOSHI	15701, 16201
NORDMENDE	01701, 03801, 07101,		15801, 16201, 16301,	RMB		SHIVAKI	14701, 15701, 15901,
	15701, 15801, 16001,		17901	ROADSTAR			16201
	16201	PLANTRON	14701, 14801, 15701,			SHOGUN	16301
NORMEREL	15701, 16201		16201	RODEX		SHOW	14801
NOVABEAM	14701	POLAROID	19201, 19501, 19601	ROSITA		SIAREM	06801
NOVATRONIC	14701, 14801, 15701,	POPPY	14801	ROWA		SIEMENS	00401, 02801, 14701,
	15901, 16201	PORTLAND	01201, 15401, 15901,	ROYAL			15401, 15701, 16201
NTC	01201		16301, 16501, 17901	RUKOPIR		SIERA	15701, 16201
O GENERAL	14801	PRANDONI PRINCE	15101	RUNCO		SIERRA	14701
OCEANIC	02201, 04601	PRANDONI-PRINCE	06801			SIGNATURE	18401, 18601, 18701,
OKANO	14801, 15701, 16201	PRICE CLUB	16701	SABA			19301
OLEVIA	19701, 19801, 19901,	PRIMA	09601, 14801, 15401,			SILMA	14701
	20001		17001, 17501	SACCS		SILVA	14801, 15701, 16201
OLYMPIC	14801	PRINCESS	14801	SAGEM		SILVER	15701, 16201
ONCEAS	14801	PRINZ	16101	SAISHO		SIMPSON	17801
ONWA	02701, 05301	PRISM	00601, 16401			SINGER	14701, 14801, 15701,
OPERA	14701, 15701, 16201	PROELCO	14701	SAIVOD			16201
OPTIMUS	02001, 02301, 03401,	PROFEX	00101, 04601, 14801,	SAKURA		SINUDYNE	06801, 14701, 15001,
	08301		14901	SALORA			15701, 16101, 16201
OPTONICA	01301	PROFITRONIC	14701, 15701, 16201			SKANTIC	04501
ORBIT	14701, 15701, 16201	PROLINE	15701, 16201	SAMBERS		SKY	00401, 15701, 16201
ORIENT	14801	PROSCAN	00501, 16601, 17401,	SAMPO		SKYGiant	02701
ORION	00401, 03101, 04101,		18401, 18701			SKYWORTH	00401
	05801, 06801, 14701,	PROSONIC	15701, 15901, 16201			SNYDER	14701
	14801, 15401, 15701,	PROTEC	14701, 14801			SOLAVOX	02201, 15701, 16201
	16201, 16801	PROTECH	00101, 00401, 03301,			SONIKO	15701, 16201
ORLINE	15701, 16201		03701, 05201, 08501,	SAMSUNG		SONITRON	02901
ORMOND	15701, 16201		15701, 16101			SONNECLAIR	15701, 16201
OSAKI	03701, 05101, 15701,	PROTECT	16201			SONOKO	00101, 00401, 14701,
	15901, 16201	PROTON	00101, 00301, 02601,				14801, 15701, 16201
	15701, 16201		14801, 15401, 16301,			SONOLOR	02201, 02901
OSIO	15701, 16201		17901, 18901			SONTEC	00401, 14701, 15701,
OSUME	15701, 16201	PROVISION	15701, 16201				16201
OTF	14801	PULSAR	00201, 16301			SONY	00001, 08301, 11101,
OTTO VERSAND	00401, 04101, 06701,	PULSER	14701, 14801, 15401				11601, 12701, 12901,
	07001, 14701, 14801,	PYE	14701, 15701, 15901,				15701, 16201
	14901, 15501, 15601,		16101, 16201			SOUND & VISION	
	15701, 15801, 16101,						

15701, 15901, 16201	08001, 08901, 15701,	15901	08005, 08105, 08305,
SOUNDESIGN 02601, 02701, 15401,	15801, 16001, 16201	VIDIKRON 00801	08505
16301, 17801, 17901	TELEFUSION 15701, 16201	VIDION 14801	CONCEPT 08705
SOUNDMASTER	TELEGAZI 15701, 16201	VIDTECH 02601, 16301, 16501,	CONIA 05805
14801	TELEMEISTER	17901	CROWN 06005
SOUNDWAVE 00401, 05201, 15701,	04101, 15701, 16201	VIEWSONIC 13301	CURTIS INTERNATIONAL
16201	TELEOPTA 14801	VISION 04101, 14801, 15701,	08505
SOWA 00601, 00901, 01201,	TELERENT 18401, 18601, 18701	16201	CYBERHOME 02405
02101, 02601	TELESONIC 15701, 16201	VISON 14701	CYTRON 06005
SPECTRICIAN 14701, 15401	TELESTAR 14801, 15701, 16201	VIZIO 18801	DAEWOO 03205, 03305
SQUAREVIEW 02501, 18201	TELETECH 00101, 14801, 15701,	VORTEC 14701, 15701, 16201	DANSAI 03205
SSS 02701, 16301	16201	VOXSON 02201, 14701, 15701,	DECCA 03205
STANDARD 00101, 14801, 15701,	TELETON 16101	16201	DENON 00005
15901, 16201	TELEVIEW 15701, 16201	WALTHAM 04501, 15701, 16201	DIAMOND 03105, 06005
STARLITE 02701, 14801, 15701,	TEMPEST 14801, 15701, 16201	WARDS 00301, 00801, 02601,	DIGITREX 02105, 07605
16201	TENNESSEE 15701, 16201	11301, 14701, 16301,	Digitrex 05805
STARLUX 14801	TENSAI 04101, 14701, 14801,	16501, 17301, 17801,	DISNEY 08405
STERN 02201, 03501, 15001,	15701, 15901, 16201	17901, 18401, 18601,	DUAL 05605, 06005
15301	TENSON 14801	18701, 19101	DURABRAND 07405
STRATO 15701, 16201	TERA 00301, 16301	WATSON 00401, 04101, 14701,	DVD2000 00205
SUNIC LINE 15701, 16201	TESLA 14701	14801, 15701, 16201	ELTA 05905, 07205, 07505
SUNKAI 15701, 16201	TESLA ORAVA 14701	WATT RADIO 16101	EMERSON 01205, 07405, 07805,
SUNSTAR 14801, 15701, 16201	TEVION 15701, 16201	WAYCON 02101	08405, 08605
SUNWOOD 14701, 14801, 15701,	TEXT 15901	WEGA 15701, 16201	ENTERPRISE 01205
16201	THOMAS 14701, 14801, 15401	WEGAVOX 14701, 14801, 15701,	FERGUSON 06005
SUPERSCAN 17201	THOMSON 01701, 03801, 07101,	16201	FISHER 02005
SUPERTEC 14801	08001, 12501, 15701,	WELTBlick 14701, 15701, 16201	FUNAI 07805, 08405
SUPERTECH 14801, 15701, 16201	15801, 16001, 16101,	WESTON 15701, 16201	GE 00305, 02605, 08705
SUPRA 14801, 15901, 16301	16201	WHARFEDALE	GO VIDEO 02505
SUPREMACY 15401	THORN 00401, 01401, 04601,	15701, 16201	GOLDSTAR 02905, 07405
SUPREME 00001	06701, 14701, 15101,	WHITE WESTINGHOUSE	GOODMANS 05905, 06005
SUTRON 14801	15701, 15801, 15901,	00401, 04101, 05801,	GRADIENTE 01805
SYC LINE 14801	16201	07901, 14701, 15701,	GREENHILL 02605, 08705
SYLVANIA 00301, 00801, 02501,	THORN-FERGUSON	16201, 17701	GRUNDIG 00705, 06005
14701, 16301, 16801,	14701, 15001	WINSTON 14701, 14801	HARMAN KARDON
17201, 17701, 17801,	TMK 02601, 16301, 17901	WINTERNITZ 14801	08205
17901, 18201	TNCI 00201	WORLDVIEW 14701, 14801	HARMAN/KARDON
SYMPHONIC 02501, 02701, 15401,	TOBO 14801	XRYPTON 15701, 16201	05505
17201, 17701, 18201	TOKAI 14701, 15701, 15901,	YAMAHA 00301, 01801, 08301,	HELIOS 09205
SYNCO 00001, 00901, 01201,	16201	10001, 11001, 13501,	HITACHI 01105, 01905
01301, 02601, 05601	TOSHIBA 00901, 02001, 02101,	13601, 13701, 13801,	HITEKER 02105, 05805, 07605
SYNTAX 19701	06601, 07801, 08301,	14001, 14101, 14201,	INITIAL 08705
SYSLINE 00401, 15701, 16201	10901, 12101, 12301,	16301, 16501, 17901	INSIGNIA 07405, 07705, 07805,
T + A 05501	13001, 13201, 16701,	YAMAJI 03609	08705, 08805
TACICO 00101, 01201, 02601	18101, 18901	YAMISHI 15701, 16201	JBL 08205
TAI YI 00101	TOSONIC 15401	YAPSHE 03401	JVC 00905, 01305
TANDBERG 15001	TOTEVISION 15401	YOKAN 15701, 16201	KENWOOD 00005, 00605
TANDY 01301, 02201	TOWADA 16101	YOKO 00401, 03701, 14701,	KLH 02605, 08705
TASHIKO 01201, 08301	TRANS CONTINENS	14801, 15701, 16201	KONKA 07705
TATUNG 00101, 00401, 00601,	15701, 16201	YORK 14701	KOSS 01805
00801, 00901, 02001,	TRANSONIC 15701, 16201	ZENITH 00201, 01201, 02601,	KXD 07305
02101, 06801, 14701,	TREVI 14801	05801, 14701, 16301,	LENCO 06005
15701, 16201, 18801	TRIAD 14701, 15701, 16201	16801, 17701, 17901,	LENOXX 05905, 07505
TCM 10301	TRILUX 14701	18601, 19301	LG 02905, 07405
TEAC 00101, 00401, 03701,	TRIUMPH 06801, 15701, 16201		LIFETEC 06005
05101, 05201, 05701,	TRIVISION 14801		LIMIT 03105
08501, 11401, 15701,	TUNTEX 00101, 00301, 01201		LIQUIDVIDEO 08805
16101, 16201	TVS 05801		MAGNAVOX 00105, 02205, 07805
TEAK 14801	TVTEXT 95 16201		MARANTZ 00705, 07405
TEC 03301, 14801, 15001,	UHER 04101, 14701, 15701,		MATSUI 06005
15701, 16201	15901, 16201		MBO 05905
TECH LINE 15701, 16201	ULTRAVOX 15701, 15901, 16201		MEDION 06005
TECHNEMA 04101	UMA 14701		MEMOREX 03805
TECHNICS 00601, 03401, 08301,	UNIC LINE 15701, 16101, 16201		MICO 02705
14701, 16401	UNIMOR 14701		MICROSOFT 00305
TECHNILAND 14701	UNITED 15701, 16201		MINTEK 02605, 08705
TECHNISAT 15701, 16201	UNIVERSAL 17301, 19101		MITSUBISHI 00205
TECHNOL 14801	UNIVERSUM 00401, 01401, 01501,		MUSTEK 02805, 05605
TECHWOOD 00601, 16301, 16401,	03701, 04401, 04701,		Mx ONDA 06005
17901	06401, 14701, 14801,		NAD 07405
TECNISON 14801	15701, 16101, 16201		NESA 02605, 08705
TECO 00101, 00601, 01201,	UNIVOX 15701, 16201		NORCENT 08005, 08505
01301, 02601, 03701,	URANYA 14801		ONKYO 00105
08401	VANGUARD 14801		OPPO 08905, 09005, 09105
TEDELEX 14801, 15701, 16201	VECO 14801		ORITRON 01805, 06005
TEKNANT 14701, 14801	VECTOR RESEARCH		PALSONIC 02105, 05805
TEKNIKA 00801, 00901, 01201,	00301		PANASONIC 00005, 01605, 04205
01901, 02701, 15401,	VESTEL 00401, 14701, 15701,		PHILIPS 00105, 00705, 01705,
16301, 16501, 16701,	16201		03905, 07805, 08405
17801, 17901, 18101,	VEXA 14701, 14801, 15701,		00405, 01005, 01505,
18401, 18601, 18701,	16201		01605
18901,	VICTOR 00701, 03401, 08301,		POLK AUDIO 00705
TEKON 14801	08401		PORTLAND 07505
TELEAVIA 15801, 16001	VIDEO SYSTEM		PROLINE 06005
TELECOR 15701, 16201	14701, 15701, 16201		PROSCAN 00305
TELEFAC 14801	VIDEOSAT 03301		PROSCAN 08005
TELEFUNKEN 01701, 03601, 04201,	VIDEOTECHNIC		QWESTAR 01805

DVD PLAYER

ACOUSTIC SOLUTIONS	02805, 05605
AIWA	05605, 05705, 07105
AKAI	07505
ALBA	02605
AMSTRAD	02305
APEX	07605, 08705
APEX DIGITAL	02105, 02605, 03005,
	03505, 03605, 03705,
	04105, 05805
AUDIOVOX	08805
AXION	08805
BBK	06105, 06205, 06305,
	06405, 06505, 06605,
	06705, 06805, 06905,
	07005
BLAUPINKT	02605
BLAUPUNKT	08705
BLUE PARADE	01005
BLUE SKY	05805
BRANDT	06005
BUSH	02305, 05905
CENTREX	02105
CENTRIOS	08805
CINEVISION	07405
CLASSIC	05605
CLATRONIC	03405
COBY	07305, 07605, 07905,

PENTAX	00702, 05402, 06202, 06502	SONIC BLUE	03002, 03102	ADELPHIA	04503	TS	00103
PERDIO	00002, 04702	SONTEC	00402	ALLEGRO	02903, 03403	TV86	03603
PHILCO	00302, 05602, 06402	SONY	00002, 00102, 00202, 00302, 03302, 04102, 04702	AMERICAST	02003	UNIKA	03703, 03803, 04303
PHILIPS	00302, 01502, 03202, 03902, 04002, 04602, 06402	STS	00702, 06202, 06402, 06502	ANTRONIX	03703, 03803	UNITED CABLE	00103
PHONOLA	01502	SUNKAI	02602	ARCHER	03703, 03803, 04003, 04303	UNIVERSAL	02903, 03703, 03803, 04003, 04303, 04603
PILOT	00402, 05702	SUNSTAR	00002, 04702	AT&T	04503	VIEWSTAR	03103, 03203, 03603, 04103
PIONEER	00702, 01302, 01502, 05802, 06002, 06202, 06702	SUNTRONIC	00002	BELL SOUTH	02003	VERIZON FIOS	05003, 05103
POLK AUDIO	01502	SYLVANIA	00002, 00302, 00802, 01502, 04702, 05602, 05902, 06302, 06402	BIRMINGHAM CABLE COMMUNICATIONS	00803	ZENITH	00003, 01503, 02003, 03403, 04303
PROFITRONIC	02002	SYMPHONIC	00002, 04702, 05902, 06302	BRITISH TELECOM	00103		
PROLINE	00002, 04702	TANDBERG	05002, 05202	CABLETENNA	03703		
PROSCAN	01202, 03802, 05602	TANDY	00002, 01602, 05902, 06102	CABLEVIEW	03703		
PROTEC	01402	TASHIKO	00002, 00402, 04702, 05702	CENTURY	04303		
PULSAR	00502	TATUNG	00002, 00602, 00902, 01302, 01502, 04702, 06602	CITIZEN	04303		
PYE	01502	TEAC	00002, 00602, 02102, 02202, 03402, 04702, 05902, 06302, 06602	COGECO	04503		
QUARTER	06102	TECHNICS	00302, 01902, 04802, 06402	COMCAST	04503		
QUARTZ	06102	TECO	00302, 00402, 00602, 01102	COMTRONICS	03103		
QUASAR	00302, 03702, 05602, 06402	TEKNIKA	00002, 00302, 00402, 04702, 05702, 05902, 06302, 06402	CONTEC	03503		
QUELLE	01502, 04602, 04802, 05002	TELEAVIA	00602	DAERYUNG	00203, 01403, 01903		
RADIO SHACK	05502, 05602, 05702, 05902, 06102, 06302, 06402	TELEFUNKEN	00602, 02402	DIRECTOR	01303		
RADIOLA	01502	TENOSAL	01402	FILMNET	01203		
RADIO SHACK	00002	TENSAI	00002	GARRARD	04303		
RADIX	00402, 05702	THOMAS	00002	GC ELECTRONICS	03803		
RANDEX	00402, 05702	THOMSON	00602, 01202, 01302, 02402	GENERAL INSTRUMENT	00103, 00803, 01303, 01703		
RCA	00302, 00702, 01202, 02002, 03502, 03702, 03802, 05502, 05602, 05702, 06202, 06402, 06502	TIVVO	03202, 03302	GENERAL INSTRUMENT (GI)	02803, 04503, 04703, 04803		
REALISTIC	00002, 00302, 00402, 01002, 01102, 01602, 04702, 05502, 05602, 05702, 05902, 06102, 06302, 06402	TMK	02002, 05002, 05502	GOLDSTAR	00503		
REOC	02602	TOSHIBA	00602, 00802, 00902, 01302, 01502, 03602, 06202	HAMLIN	00303, 00703		
REPLAYTV	03002, 03102	TOTEVISION	00402, 02002, 05502, 05702	HITACHI	04703		
REX	00602	UHER	02002	JASCO	04303		
RIO	05702	UNITECH	02002, 05502	JERROLLD	00103, 00803, 01303, 01703, 02803, 04203, 04703		
ROADSTAR	00402, 01402, 02002, 02102	UNIVERSUM	00002, 00402, 01502, 02002	LG	00503		
RUNCO	00502	VECTOR	00902	MAGNAVOX	03203		
SABA	00602, 02402	VECTOR RESEARCH	05402, 05802, 06002	MEMOREX	00003		
SAISHO	05002	VICTOR	00602, 01302, 05802, 06002	MNET	01203		
SALORA	00802	VIDEO CONCEPTS	00902, 05402, 05802, 06002	MOTOROLA	00803, 01303, 01703, 02303, 02803, 04503, 04703, 04803		
SAMPO	00402, 01102	VIDEOMAGIC	00402	MOVIE TIME	03603		
SAMSUNG	00902, 02002, 02802, 05502, 06202	VIDEOSONIC	02002, 05502	NOKIA	04903		
SANKY	00502, 01102	VILLAIN	00002	NOOS	01803		
SANSUI	00002, 00602, 01302, 04402, 05802, 06002, 06602	WARDS	00002, 00302, 00702, 01002, 01102, 01202, 01402, 01502, 02002, 05502, 05602, 05702, 05902, 06202, 06302, 06402, 06502	NSC	03603		
SANYO	01002, 01602, 02002, 05502, 06102	WHITE WESTINGHOUSE	01402, 05902	OAK	03503, 03903		
SAVILLE	02702	XR-1000	00002, 00302, 01402, 06302, 06402	PACE	00603, 02203		
SBR	01502	YAMAHA	00602, 05402, 05802, 06002, 06602	PANASONIC	00003, 00203, 00403, 02703		
SCHAUB LORENZ	00002, 00602, 01602	YAMISHI	01402	PARAGON	00003		
SCHNEIDER	00002, 01402, 01502, 04702	YOKAN	01402	PHILIPS	01003, 01103, 03203, 04303		
SCOTT	00802, 00902, 01702	YOKO	02002	PHILIPS-MAGNAVOX	03003, 03303		
SEARS	00002, 00302, 00402, 00702, 01002, 01602, 04202, 05702, 06102, 06202, 06402, 06502, 06702	ZENITH	00002, 00202, 00502, 04402, 05702, 05802, 05902, 06002	PIONEER	00503, 01603, 01903		
SEG	02002			PULSAR	00003		
SEI	01502			PVP STEREO VISUAL MATRIX	00103		
SELECO	00602			QUASAR	00003		
SEMP	00902			RADIO SHACK	03003, 03303, 03403		
SHARP	01102, 03502, 05902			RCA	02403, 02503, 04303		
SHINTOM	01402, 01602, 06202			REALISTIC	03803		
SHOGUN	05502			REGAL	00703, 00903		
SIEMENS	00402, 01502, 01602, 04602			REMBRANDT	04703		
SIGNATURE	05902			RUNCO	00003		
SILVA	00402			SAGEM	01803		
SINGER	00902, 01402, 06402			SAMSUNG	00003, 00503		
SINUDYNE	01502, 05202			SCIENTIFIC ATLANTA	00203, 01403, 01903		
				SHAW	04503		
				SIGNATURE	04703		
				SONY	02103		
				STARCOM	00103		
				SUPERCABLE	00803		
				TANDY	04103		
				TELE+1	01203		
				TOCOM	02803, 04203, 04403, 04803		
				TORX	00103		
				TOSHIBA	00003		
				TRANS PX	00803		

SATELLITE TUNER

@SAT	06404
ABSAT	00104
ALBA	01404
ALPHASTAR	02504
AMSTRAD	03004
ASTON	00304, 05004
ASTRO	00604
ATSAT	06404
AVALON	01304
BLAUPUNKT	00604
BRITISH SKY BROADCASTING	03004, 05204
CANAL DIGITAL	03104
CANAL SATELLITE	03104
CANAL+	03104
CHAPARRAL	00804
CITYCOM	05304
COMAG	09004, 09104, 09704, 10104, 10304, 11604, 11704, 11804, 12004
CONNEXIONS	01304
CROSSDIGITAL	04604
CYRUS	00704
DAERYUNG	01304
DAEWOO	06304
D-BOX	02104, 04904
DIGENIUS	01104
DIRECTV	00904, 01204, 01504, 01704, 02204, 02304, 02804, 04104, 04604, 05104, 06904
DISH NETWORK SYSTEM	02604, 03704
DISHPRO	02604, 03704
DISTRATEL	00004
DMT	04004
DNT	00704, 01304
DREAM MULTIMEDIA	05804
DREAMBOX	08604, 08704, 09604, 09804, 09904, 10004, 10404, 10604
ECHOSTAR	00504, 01304, 01604, 02604, 03104, 03604, 03704, 04304
ENGEL	03804
EXPRESSVU	02604
FINLUX	01404
FOXTEL	07004, 07104, 07204, 07304, 07404
FRACARRO	03604
FTE	03404
FUBA	01304
GALAXIS	03404, 04704
GE	01504
GENERAL INSTRUMENT	03504, 08204, 08304
GOI	02604
GOLD BOX	03104
GRUNDIG	00604, 03004
HIRSCHMANN	00604, 01304
HITACHI	01404, 02804
HOUSTON	08504, 10704, 10804, 11004, 11104, 11304, 11904
HTS	02604
HUGHES NETWORK SYSTEM	

CABLE TV TUNER

ABC	00103, 00203, 02803, 04703
-----	----------------------------

HUMAX	02304, 05104, 06904 03404, 05304	WISI	00604, 01304, 01404
INVIDEO	03604	XSAT	00104
JVC	02604	ZEHNDER	04004
KATHREIN	00104, 00604, 00704, 01004, 01804, 05604	ZENITH	03304
KREISELMEYER			
	00604		
LABGEAR	06304		
LOGIX	03804		
LORENZEN	01104		
MAGNAVOX	02004, 02204		
MANHATTAN	01404, 03804, 04204		
MARANTZ	00704		
MEDIASAT	03104		
MEMOREX	02204		
METRONIC	00004		
MITSUBISHI	02304		
MOTOROLA	03504		
MYRYAD	00704		
NEXT LEVEL	03504		
NOKIA	01404, 02104, 02404, 04904, 05704, 06804		
OCTALTV	03704		
ORBITECH	04504		
PACE	01404, 03004, 05204, 06604		
PANASONIC	00904, 01904, 03004, 06504		
PANDA	01404		
PAYSAT	02204		
PHILIPS	00204, 00704, 01404, 02004, 02204, 02304, 03104, 04104, 05104, 06904		
PIONEER	03104		
PRIMESTAR	08204, 08304		
PROMAX	01404		
PROSCAN	01204, 01504		
RADIOLA	00704		
RADIOSHACK			
	03504		
RADIX	01304		
RCA	00404, 01204, 01504, 03204		
RFT	00704		
SABRE	01404		
SAGEM	02904, 04804, 05904		
SAMSUNG	03804, 04604, 06004, 06204		
SAT CONTROL			
	06404		
SATSTATION	04204		
SCHWAIGER	04704		
SEEMANN	01304		
SIEMENS	00604		
SKY	03004, 03304, 05204, 12104, 12204, 12304		
SKY HD	12404		
SKY MASTER	07504, 07604, 07704, 07804, 07904, 08004		
SKY+ (SKY Digital +)			
	08104		
STARCHOICE	08204, 08304		
SM ELECTRONIC			
	05404		
SMART	08804, 08904, 09204, 09304, 09404, 09504, 10204, 10304, 10504, 10904, 11204, 11404, 11504		
SONY	01704, 03004, 06704		
STAR CHOICE	03504		
STRONG	06404		
TANTEC	01404		
TECHNISAT	04404, 04504		
TELESTAR	04504		
THOMSON	01404, 03104, 03904, 06104		
Tivo	08404		
TOPFIELD	05504		
TOSHIBA	02304, 02704, 06904		
TPS	02904, 05904		
ULTIMATETV	01204, 01704		
UNIDEN	02004, 02204		
UNIVERSUM	00604		
VENTANA	00704		

Index

■ Numerics

2-channel source surround decode	24
3Beam, beam mode	24
5.1ch beam mode	23
5.1-channel source 7.1-channel decode	24
5Beam, beam mode	23
5BeamPlus2, beam mode	24
7.1ch beam mode	24

■ A

AC IN jack	8
AC ON STANDBY, ADVANCED SETUP	41
Activating SIRIUS Satellite Radio subscription	27
Adaptive DRC, Dynamic range control	37
Adaptive dynamic range control, Dynamic range control	37
Adjusting volume level automatically UniVolume	31
ADVANCED SETUP	40
Adventure. CINEMA DSP program	23
All Channel Search mode, SIRIUS Satellite Radio	27
Attaching stands, installation	10
Audio / video component connection	13
AUDIO DELAY, SOUND SET MENU	36
Audio delay, SOUND SET MENU	36
AUDIO IN jacks	8
Audio Sampling, input signal information	32
AUDIO SELECT, HDMI setup	39
Audio select, HDMI setup	39
AUTO DIMMER, Front panel display setup	39
Auto dimmer, Front panel display setup	39
AUTO LIP SYNC, Audio delay	36
Auto Preset, option menu	32
AUTO SETUP	15
AUTO SETUP, Error messages	18
Automatic lipsync, Audio delay	36
Automatic preset, option menu	32
AUX1/2, Audio delay	36
AV button, Remote control	9
AV key, controlling external component	42

■ B

BASS EXT indicator	7
BASS EXTENSION, SOUND SET MENU	37
Bass extension, SOUND SET MENU	37
BASS OUT, Subwoofer settings	36
Bass out, Subwoofer settings	36
Bass sound output redirection, Sound output	38
BEAM ADJUSTMENT, MANUAL SETUP	35
Beam adjustment, MANUAL SETUP	35
Beam mode, 5.1ch	23
Beam mode, 7.1ch	24
Blu-ray disc player connection	12

■ C

cardboard microphone stand assemble	16
Category Search mode, SIRIUS Satellite Radio	28
CENTER PRE OUT jack	41
Center SP Size, Sound output	38
Center speaker size for PRE OUT, Sound output	38
CH key, controlling external component	42
CH keys, Remote control	9
CHANNEL LEVEL, SOUND SET MENU	37
Channel level, SOUND SET MENU	37
CINEMA DSP indicator	7
CINEMA DSP program keys, Remote control	9
CINEMA DSP programs	22
Clear preset station, option menu	32
Clear Preset, option menu	32
CODE SET key, controlling external component	42
CODE SET key, Remote control	9
Concert Hall. CINEMA DSP program	23
Configuring input source settings	32
Connecting audio / video components	13
Connecting Blu-ray disc player	12

Connecting external components	12
Connecting FM antenna	13
Connecting SiriusConnect tuner	26
Connecting subwoofer	14
Connecting TV	12
Connections	12
Controlling external component	42
Corner installation, placement	11
CROSS OVER, Subwoofer settings	36
Crossover, Subwoofer settings	36
Cursor keys, controlling external component	42
Cursor keys, Remote control	9
Customizing this unit	33

■ D

Decoder indicators	7, 21
Decoder Mode, option menu	32
Decoder mode, option menu	32
DEMO MODE, ADVANCED SETUP	41
Demo mode, ADVANCED SETUP	41
DIGITAL IN jacks	8
Direct number access, SIRIUS Satellite Radio	28
Display language change	15
DISPLAY MENU	39
Displaying input signal information	32
DISTANCE, Subwoofer settings	36
Distance, Subwoofer settings	36
Dolby Digital Plus, glossary	47
Dolby Digital Surround EX, glossary	47
Dolby Digital, glossary	47
Dolby Pro Logic II, glossary	47
Dolby Pro Logic IIx, glossary	47
Dolby Surround, glossary	47
Dolby TrueHD, glossary	47
Dolby/DTS DRC, Dynamic range control	37
Drama. CINEMA DSP program	23
DRC:Dynamic Range CTRL, SOUND SET MENU	37
DTS 96/24, glossary	47
DTS Digital Surround, glossary	47
DTS Neo:6, glossary	47
DTS-HD High Resolution Audio, glossary	47
DTS-HD Master Audio, glossary	47
Dynamic range control, SOUND SET MENU	37
Dynamic range of Dolby Digital and DTS signals, Dynamic range control	37

■ E

ENHANCER indicator	7
ENTER key, controlling external component	42
ENTER key, Remote control	9
ENTERTAINMENT. CINEMA DSP program	23
Entertainment. CINEMA DSP program	23
Error messages, AUTO SETUP	18
External amplifier using	41
External component connection	12
External component control	42
External component operation keys, controlling external component	42
External component operation keys, Remote control	9

■ F

F.DISPLAY SETUP, DISPLAY MENU	39
F.PANEL KEY, ADVANCED SETUP	40
FACTORY PRESET, ADVANCED SETUP	41
Factory preset, ADVANCED SETUP	41
FM antenna connection	13
FM ANTENNA jack	8
FM Mode, option menu	32
FM receiving mode, option menu	32
FM tuner, troubleshooting	44
FM tuning	25
Frequency tuning, FM tuning	25
Front panel	6

Front panel display	6, 7
Front panel display setup, DISPLAY MENU	39
Front panel input key, ADVANCED SETUP	40
Front panel key, ADVANCED SETUP	40
FRONT PRE OUT jacks	41
Front SP Size, Sound output	38
Front speaker size for PRE OUT, Sound output	38

■ G

Game. CINEMA DSP program	23
General, troubleshooting	43
Group ID, Wireless setup	39

■ H

HDMI control function	31
HDMI CONTROL, INPUT MENU	39
HDMI control, INPUT MENU	39
HDMI indicator	7
HDMI jacks	8
HDMI SETUP, INPUT MENU	39
HDMI setup, INPUT MENU	39
HDMI, Audio delay	36
HDMI, glossary	48

■ I

IMAGE LOCATION, MANUAL SETUP	35
Image location, MANUAL SETUP	35
INFO key, Remote control	9
INPUT ASSIGNMENT, INPUT MENU	38
Input assignment, INPUT MENU	38
Input channel indicators	7, 22
INPUT key, Front panel	6
INPUT MENU	38
INPUT RENAME, INPUT MENU	38
Input rename, INPUT MENU	38
Input selector keys, Remote control	9
Input signal information display	32
Input source setting configuration	32
Installing batteries, remote control	14
IntelliBeam	15
INTELLIBEAM key, Remote control	9
INTELLIBEAM MIC jack	6
iPod Interlock, Wireless setup	39
iPod interlock, Wireless setup	39
iPod, troubleshooting	45
iPod/iPhone playback	30
IR IN terminal	8
IR-OUT terminal	8

■ J

Jazz Club. CINEMA DSP program	23
-------------------------------------	----

■ L

LANGUAGE SETUP, DISPLAY MENU	40
Language setup, DISPLAY MENU	40
LFE 0.1-channel, glossary	48
LFE Level, Sound output	38
LFE LEVEL, Subwoofer settings	36
Linear PCM, glossary	48
Loading settings	19
Low-frequency effect level for PRE OUT, Sound output	38
Low-frequency effect level, Subwoofer settings	36

■ M

MANUAL SETUP	34
MAX VOLUME SET, ADVANCED SETUP	40
Maximum volume setting, ADVANCED SETUP	40
Mch Stereo. CINEMA DSP program	23
MEMORY PROTECT, ADVANCED SETUP	41
Memory protect, ADVANCED SETUP	41
MENU key, controlling external component	42
MENU key, Remote control	9
MOVIE. CINEMA DSP program	23

Movie. CINEMA DSP program	23	SIRIUS PIN, ADVANCED SETUP	41	VOLUME +/- keys, Front panel	6
Multi-information display	7	SIRIUS Satellite Radio channel registration	28	VOLUME +/- keys, Remote control	9
MUSIC ENHANCER, SOUND SET MENU	37	SIRIUS Satellite Radio PIN, ADVANCED SETUP ...	41	Volume level at power-on, ADVANCED SETUP	40
Music Video. CINEMA DSP program	23	SIRIUS Satellite Radio subscription activation	27	Volume level indicator	7
MUSIC. CINEMA DSP program	23	SIRIUS Satellite Radio, troubleshooting	44	Volume Trim, option menu	32
Music. CINEMA DSP program	23	SIRIUS Satellite Radio™ tuning	26	Volume trim, option menu	32
MUTE key, Remote control	9	SiriusConnect tuner connection	26		
Muting audio output	21	SLEEP indicator	7	W	
		SLEEP key, Remote control	9	wall mount bracket using, installation	10
N		Sleep timer	31	Wireless Function, Wireless setup	39
Numeric keys, controlling external component	42	SOUND BEAM OUT CONFIG, SOUND OUT MENU	37	Wireless function, Wireless setup	39
Numeric keys, Remote control	9	Sound beam output configuration, SOUND OUT MENU	37	Wireless indicators	7
		SOUND OUT MENU	37	WIRELESS SETUP, INPUT MENU	39
		SOUND OUT MENU	37	Wireless setup, INPUT MENU	39
O		SOUND OUT, SOUND OUT MENU	37		
Operation range, remote control	14	Sound output redirection, Sound output	38	X	
OPTION key, Remote control	9	Sound output, SOUND OUT MENU	37	x.v.Color, glossary	48
OSD BACK COLOR, OSD setup	40	SOUND SET MENU	36		
OSD background color, OSD setup	40	Specifications	48		
OSD language change	15	Spectacle. CINEMA DSP program	23		
OSD SETUP, DISPLAY MENU	40	Sports. CINEMA DSP program	23		
OSD setup, DISPLAY MENU	40	ST+3BeamPlus2, beam mode	24		
OSD SHIFT, OSD setup	40	Stand attachment, installation	10		
OSD shift, OSD setup	40	STANDARD DIMMER, Front panel display setup	39		
		Standard dimmer, Front panel display setup	39		
P		Standby after AC on, ADVANCED SETUP	41		
PANEL INP.KEY, ADVANCED SETUP	40	STEREO key, Remote control	9		
Parallel installation, placement	11	Stereo+3Beam, beam mode	23		
Parental lock, input signal information	32	Subwoofer connection	14		
ParentalLock, input signal information	32	SUBWOOFER jack	8		
PCM indicator	7	SUBWOOFER PRE OUT jack	41		
PCM, glossary	48	SUBWOOFER SET, SOUND SET MENU	36		
Playback	21	Subwoofer settings, SOUND SET MENU	36		
Playing back iPod/iPhone	30	SUPPORT AUDIO, HDMI setup	39		
Power key, Ffront panel	6	Support audio, HDMI setup	39		
Power key, Remote control	9	SUR. BACK PRE OUT jacks	41		
Power LED	6	SUR.DECODE key, Remote control	9		
Power-on by remote control input keys, ADVANCED SETUP	41	SURROUND key, Remote control	9		
PRE OUT jacks	8	SURROUND PRE OUT jacks	41		
PRE OUT Volume, Sound output	38	System configurations	40		
PRE OUT volume, Sound output	38	SYSTEM CONNECTOR terminal	8		
Preset tuning, FM tuning	25	System memory using	19		
R		T			
R.INPUT POWER, ADVANCED SETUP	41	Table top stand/floor stand using, installation	10		
Rack using, installation	10	Talk Show. CINEMA DSP program	23		
Rear panel	8	TONE CONTROL, SOUND SET MENU	36		
RECV, Wireless indicators	7	Tone control, SOUND SET MENU	36		
Registering SIRIUS Satellite Radio channels	28	TOP MENU key, controlling external component	42		
Remote control	9	TOP MENU key, Remote control	9		
Remote control code list	49	Transmission indicator, Remote control	9		
Remote control code resetting all	42	TREBLE, Tone control	36		
Remote control code setting	42	Treble, Tone control	36		
Remote control preparation	14	TRNS, Wireless indicators	7		
Remote control sensor	6	Troubleshooting	43		
Remote control, troubleshooting	45	Tuner indicators	7		
Resetting all remote control code	42	Tuner operation keys, Remote control	9		
Resolution, input signal information	32	TURN ON VOLUME, ADVANCED SETUP	40		
RETURN key, controlling external component	42	TV	36		
RETURN key, Remote control	9	TV button, Remote control	9		
RS-232C terminal	8	TV connection	12		
		TV INPUT key, controlling external component	42		
S		TV key, controlling external component	42		
Sampling frequency, input signal information	32	TV MUTE key, controlling external component	42		
Satellite radio listening, SIRIUS Satellite Radio	26	TV operation keys, Remote control	9		
Saving settings	19	TV VOL +/- key, controlling external component	42		
Sci-Fi. CINEMA DSP program	23	TV, Audio delay	36		
SET MENU	33				
SET MENU operation	34	U			
Setting Loading	19	UNIT SETUP, DISPLAY MENU	40		
SETTING PARAMETERS, MANUAL SETUP	34	Unit setup, DISPLAY MENU	40		
Setting parameters, MANUAL SETUP	34	UNIVOLUME indicator	7		
Setting remote control code	42	UNIVOLUME key, Remote control	9		
Setting saving	19				
Setting the Parental Lock, SIRIUS Satellite Radio	29	V			
SETUP key, Remote control	9	VIDEO jacks	8		
SIRIUS antenna jack	8	Video Signal In, input signal information	32		
SIRIUS indicators	7				

