

AWM EXPANDER MODULE TONE GENERATOR

EMT-10

USER'S GUIDE

BEDIENUNGSANLEITUNG

MANUEL DE L'UTILISATEUR

MANUAL DE INSTRUCCIONES

Thank you for purchasing a Yamaha AWM Expander Module Tone Generator EMT-10. The EMT-10 is a totally new type of sound generation module, utilizing the very latest in Yamaha's exclusive digital technology. Capable of producing incredibly authentic sounds, this Expander Module Tone Generator provides a richer dimension to your performances, invoking a deeper response in your audience. It is also equipped with a complete array of MIDI functions so you can greatly expand your range of musical expression when performing on a SINGLE KEYBOARD. This User's Guide has been designed to help you make proper use of the outstanding features of the EMT-10. Be sure to read it carefully before playing your EMT-10.

Contents

	Page		Page
1 The Power Supply	1	5 The Functions	6
2 Description of Parts	2	6 MIDI Control	8
3 EMT-10 Quick Reference	3	■ Possible Operating Errors	10
4 Voices & Effects	5		

Before Playing

To be sure you are using your EMT-10 under optimum conditions, pay attention to the following precautions.



••• Choosing a Place for Your EMT-10

Your EMT-10 will be damaged if used in any of the places below, so be sure to avoid doing so:

- Places exposed to direct sunlight, such as near a window, or extremely hot places near a source of heat.
- Places of particularly low temperatures.
- Places exposed to excessive humidity or dust.
- Places exposed to vibrations.
- EMT-10 is provided with numerous openings to allow heat to escape, so be sure they are not obstructed.
- Placing EMT-10 near an audio amplifier or similar device may cause a buzzing sound. If this happens, move EMT-10 away from that device.



••• Never Apply Unnecessary Force

Strong impact or unnecessary force will damage the unit, take care never to drop the unit nor place heavy objects on top of it.



••• The Power Supply

After you are finished using the unit, always turn OFF its POWER switch and disconnect the power adaptor.



••• Cleaning the Outer Case

If the unit requires cleaning, wipe it off with a soft, dry cloth. Never use thinners, benzines, or other similar solvents; their use will damage the unit.



••• Connection with Other Devices

Before connecting the unit with another device such as a SINGLE KEYBOARD instrument, make sure to turn OFF the POWER switches of both devices.

CAUTION: Do not place the power adaptor on top of EMT-10.

1 The Power Supply

The EMT-10 is designed to use a separately available Yamaha Power Adaptor as its power supply. Be sure to read the following precautions carefully to ensure proper connection of the power supply.

Using EMT-10 alone

Always use the Yamaha Power Adaptor PA-4 (in the U.S., PA-40) or PA-5. The use of another adaptor will damage the EMT-10 and is thus extremely dangerous.

Using EMT-10 concurrently with another EM-Series unit

When using EMT-10 together with another EM-Series unit (such as Disk Recorder EMQ-1), always use the Yamaha Power Adaptor PA-5. If the total maximum current of both EM-Series units is within the range of the adaptor's rated power (2 A), the units can be supplied with power by one PA-5.

Perform connection as shown on the right. Use the DC cord provided to connect the DC OUT jack of one unit to the DC IN jack of the other unit.

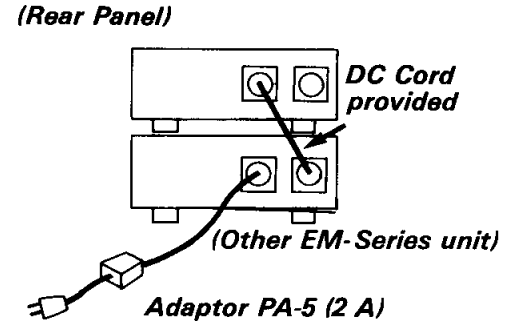

Concurrent use of 3 or more units

One PA-5 can be used to supply power to three EM-Series units, depending on the types of units involved. (Power cannot be supplied if the combination results in a total maximum current that exceeds the 2 A rated current of PA-5.) If you wish to use a single PA-5 adaptor, make sure to choose a combination of units for which the total maximum current does not exceed 2 A (2000 mA).

[Combination Example 1]

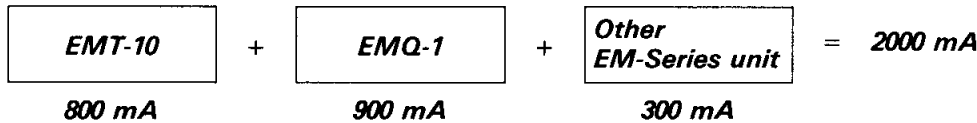

In the above case, 2 A (2000 mA) is not exceeded so three units can be used with a single PA-5.

[Combination Example 2]

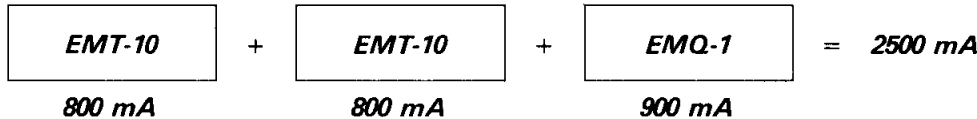

In this case, 2 A (2000 mA) is exceeded, so you will need to use two adaptors.

NOTE: DC OUT → DC IN jack connections should be made only between EM-series Expander Modules. Do not use an EM-series DC OUT jack to power other equipment.

Installing the Holders and Mounting Plates

- The EMT-10 comes supplied with two holders and two mounting plates. If you will be placing the EMT-10 on top of a Clavinova or other keyboard with top-mounted speakers, the holders and mounting plates raise the EMT-10 to prevent obstruction of the speaker. Attach one of the mounting plates to the five grooves on one of the holders. Then attach the mounting plate to the grooves on one side of the EMT-10. For added stability screw two of the screws provided into the holes in the bottom panel via the holes in the holder. Repeat this process with the remaining holder and mounting plate on the other side of the EMT-10.

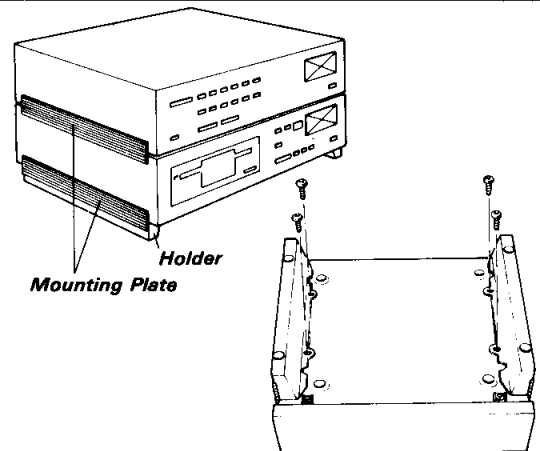

- To mount an EM-series device on top of another, use only the mounting plates to connect the grooves of the upper and lower units.

2 Description of Parts

■ Front Panel

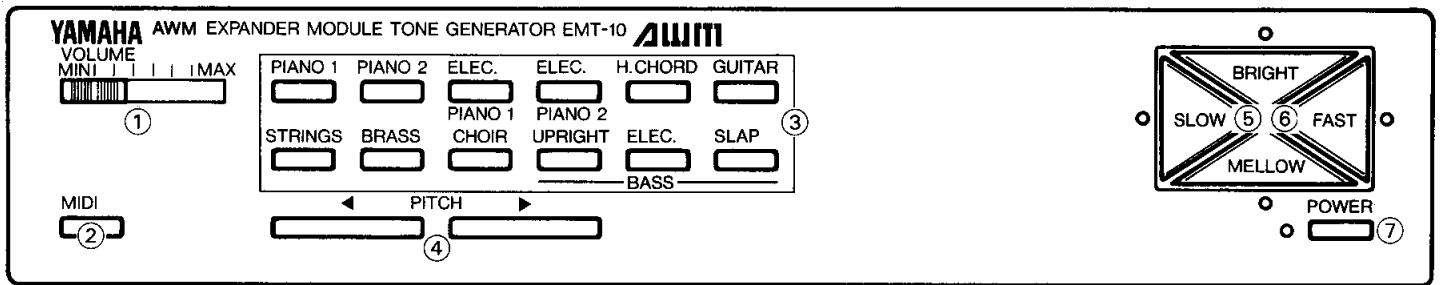

① VOLUME

Adjusts the volume level of the output sound.

② MIDI

Pressing another button while holding this button down lets you use a variety of functions.

③ Voice Selectors

Used to select the voice.

④ PITCH

Perform fine adjustment of the pitch. Press ◀ to lower the pitch, or press ▶ to raise the pitch.

⑤ BRIGHT/MELLOW (Voice Variator)

Adjust the brightness of a voice.

⑥ SLOW/FAST (Voice Variator)

Adjust the attack time of a voice.

⑦ POWER switch

Turns the power to ON or OFF.

■ Rear Panel

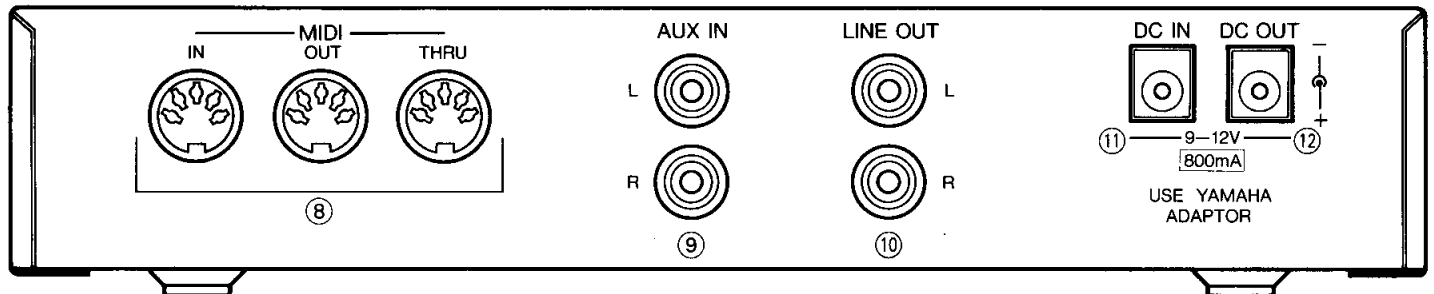

⑧ MIDI jacks

These jacks input or output performance data and other MIDI signals.

⑨ AUX IN jacks

These jacks input the audio signals. They are used when mixing an external sound with the unit's sound then outputting the mixed sound via the LINE OUT jacks.

⑩ LINE OUT jacks

These jacks output the audio signals to the amplifiers, etc.

⑪ DC IN jack

Connect the power adaptor (PA-4/PA-40/PA-5) to this jack.

⑫ DC OUT jack

This jack supplies power to another device.

3 Quick Reference

■ The MIDI Jacks

EMT-10 is provided with three MIDI jacks.

- ① **MIDI IN** : Inputs the MIDI signals.
- ② **MIDI OUT**: Outputs the MIDI signals from EMT-10.
- ③ **MIDI THRU**: Transfers and outputs the MIDI signals that were input to MIDI IN

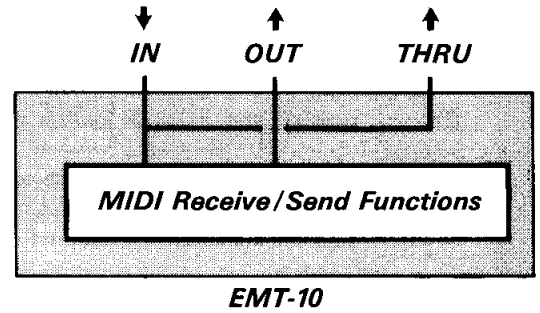

■ Sample Connection with a Keyboard

Basically, any SINGLE KEYBOARD provided with MIDI jacks can be connected. For details, carefully read the description on keyboards to confirm which data can be transmitted and received.

- You can play the keyboard and enjoy an ensemble sound that includes the voice of EMT-10.
- If the keyboard has no jacks for inputting audio signals, connect an external amplifier.

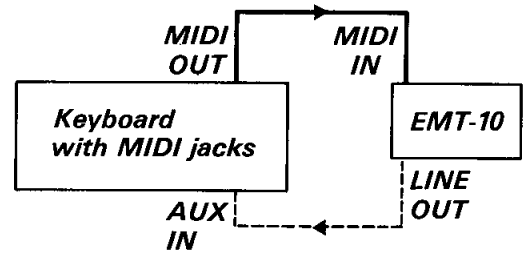

■ Enjoying an Orchestra Sound using a Sequencer/Recorder, Etc.

If you have a sequencer/recorder (for example, Yamaha EMQ-1) provided with an Overdub function and have multiple EMT-10 units, you can assign a different part to each EMT-10 unit to enjoy an orchestra-like performance. First, set each Send Channel of the keyboard to a different Channel Number for each part, then perform an Overdub recording. Next, set the Receive Channels of the EMT-10 units to match the Send Channels of the parts you wish to sound, then playback the sequencer/recorder.

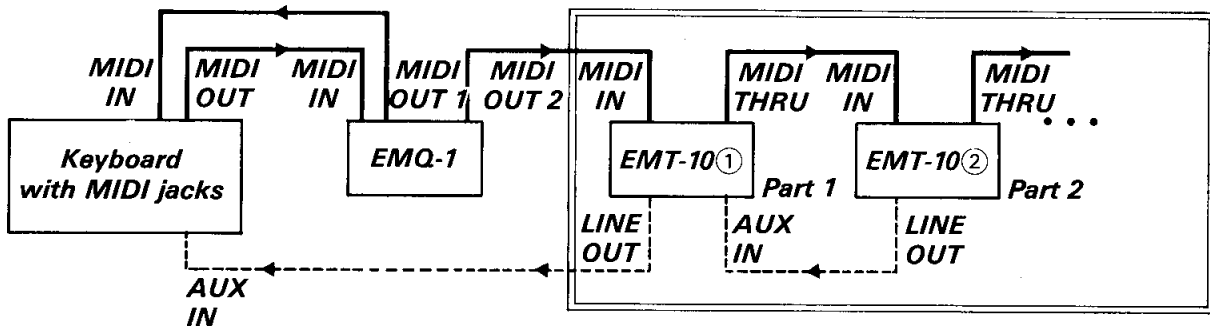

- For the connections surrounded by a double line, you can use a parallel box as shown on the right to connect the units so that the data is grouped by channel.

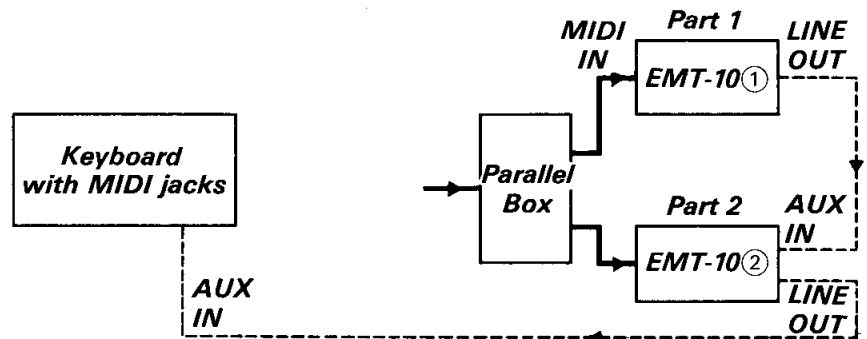

Now, Let's Produce Sounds from the Expander Module Tone Generator EMT-10

STEP 1 Getting Ready to Perform

- ① First, use the MIDI cable and connecting cord to perform connection according to the "Sample Connection with a Keyboard" on the previous page.
- ② Connect the power adaptor (PA-4/PA-40/PA-5) to DC IN of EMT-10.
- ③ Next, turn on the POWER switch of the keyboard and EMT-10.
- ④ Set the keyboard to the status in which it can produce sounds.

**Power Adaptor
(PA-4/PA-40/PA-5)**

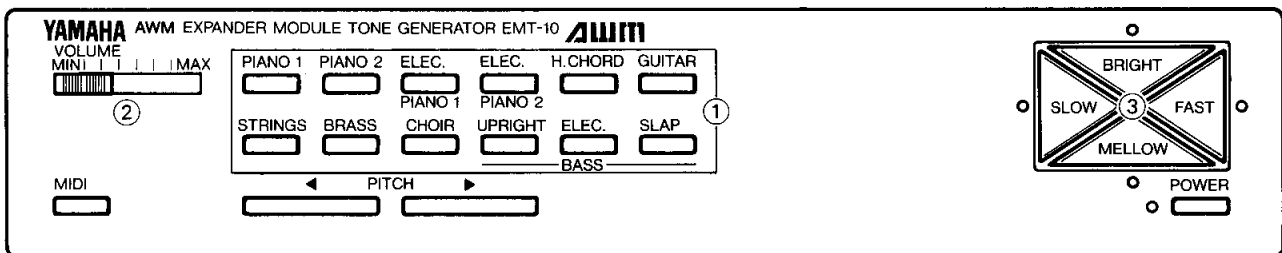
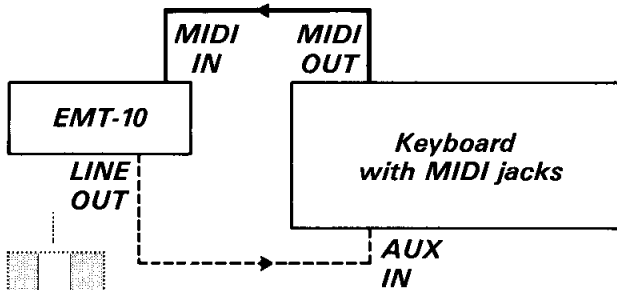
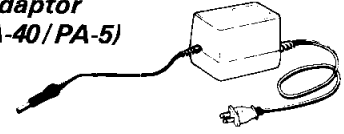

STEP 2 Performing on the keyboard

- ① Use the Voice Selectors ① to select a voice.
- ② Play the keyboard.
The voice of the keyboard and of EMT-10 are being sounded together.
- ③ Adjust the volume using the VOLUME lever ②.
- ④ Add the desired effects using the Voice Variator ③.

4 Voices & Effects

The following operation assumes that connection has been performed according to STEP 1 of the previous page, and that EMT-10 is set to its default status (the status which is automatically assumed when the power is turned on) of OMNI ON mode.

1 Select a voice.

Select one of the voices of the Voice Selectors. The 12 voices are grouped into Percussive voices and sustained voices, with each group having a different number of concurrently soundable notes.

Percussive voices: The nine voices outside the box shown on the right. Up to eight notes can be concurrently sounded (8-note polyphonic).

Sustained voices: The three voices enclosed by the box shown on the right. Up to eight notes can be concurrently sounded (8-note polyphonic), but you can also switch to 4-note polyphonic mode.

Selecting 4-note polyphonic mode for a sustained voice causes the voice to be detuned so that voice is provided with a richer sound.

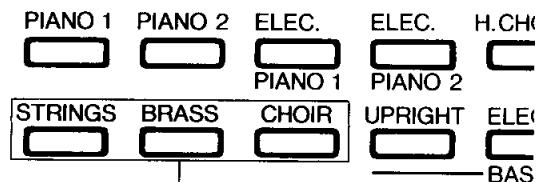

2 Adjust the volume.

Use this VOLUME lever to adjust the volume level.



3 Now, play the keyboard.

When you play the keyboard, the voice of the keyboard and the EMT-10 voice are heard as a layered sound. Because the soundable range is A_{-1} to C_7 , all of your notes can be sounded if you basically use no more than 88 keys of the keyboard. Bass notes, however, can be sounded one octave lower and the soundable Bass range in that case is A_{-2} to C_6 .

Now, try changing the voice of the keyboard. This also changes the voice of EMT-10.

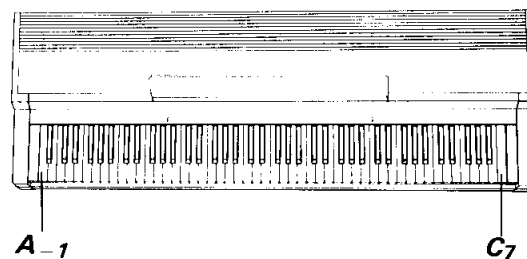

4 Experiment with the operations described below. (Receiving a Control Change)

Receive the following operations from the keyboard.

- Sustain or Damper
- Sustenuto (Percussive voices only)
- Soft Pedal
- Modulation, After Touch, Pitch Bend data cannot be received.

5 Use the Voice Variator to produce the desired voice.

- To add a brighter nuance to a voice, press the BRIGHT button. To suppress the brightness and enhance the mellowness of a voice, press the MELLOW button.
- To delay the attack time or the fade out of a voice, press the SLOW button. To speed these both up, press the FAST button.
- To turn OFF an effect that has a lit lamp, press the button on the opposite side.

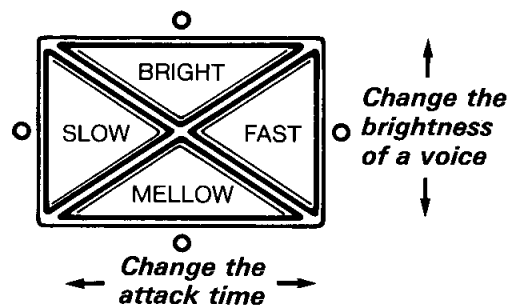

6 Adjust the Touch Curve.

With touch-sensitive keyboards such as Clavinovas, you can control the volume by key velocity (the speed of your pressure on the keys). If the volume seems too high, however, perform the "Changing the Touch Curve" operation described on page 7.

5 Functions

- These functions allow you to change the pitch, the number of concurrently soundable notes of sustained voices, use the Bass Split function which allows you play bass notes with your left hand, and much more.
- For the operations that use the MIDI button within the following description, you can check the current settings the first time the MIDI button is pressed. After that, press the MIDI button again. You can now change the values or settings.

■ PITCH: For fine adjustment of pitch.

Press the ► to raise the pitch, or press the ◀ button to lower the pitch. Each operation changes the pitch by ±3 cents. The possible range of pitch adjustment is ±50 cents.

- Pressing ◀ and ► at the same time returns the pitch to normal ($A_3=440$ Hz).



■ TRANSPOSE: To Change the Pitch in Half-step Units.

To raise the pitch, press the Voice Variator's BRIGHT button while holding down the MIDI button. To lower the pitch, press the MELLOW button while holding down the MIDI button. Each operation changes the pitch by ±100 cents (one half-step). The possible range of transposition is ±600 cents (±half octave).

- To return to normal pitch, press both the BRIGHT and MELLOW buttons while holding down the MIDI button.
- If the pitch is higher than normal pitch, the BRIGHT lamp lights up; if it is lower, the MELLOW lamp lights up.

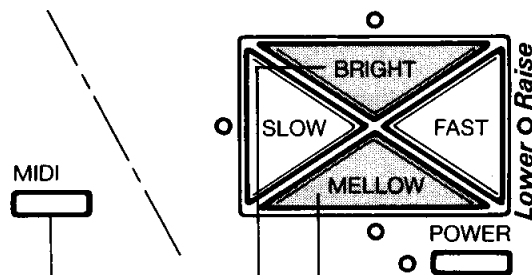

Press while holding down the MIDI button.

■ OCTAVE SHIFT: To Change the Pitch in Octave Units.

To raise the pitch, press the Voice Variator's FAST button while holding down the MIDI button. To lower the pitch, press the SLOW button while holding down the MIDI button. Each operation changes the pitch by ±1 octave. The possible range for shifting the octave is ±2 octaves.

NOTE: When TRANSPOSE or OCTAVE SHIFT function is used, any note that is outside the soundable range will be automatically raised or lowered one octave and changed to a note within the soundable range. **Example:** C_8 will be sounded as C_7 .

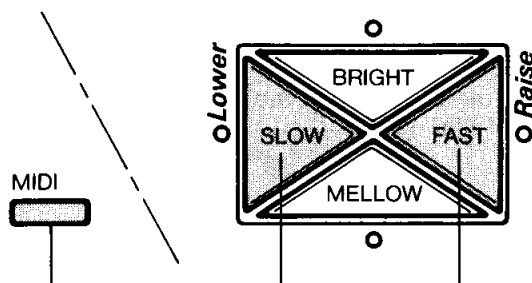

Press while holding down the MIDI button.

■ Switching the Polyphonic Mode of the Strings/Brass/Choir Voices (8-Note Mode ↔ 4-Note Mode).

To switch the polyphonic mode, press the SLAP BASS button while holding down the MIDI button.

- In 8-note polyphonic mode, the Voice Variator's MELLOW lamp lights up.
- In 4-note polyphonic mode, the BRIGHT lamp lights up.



■ BASS SPLIT: Concurrent Sounding of a Bass Voice and Another Voice.

When you simultaneously press the button of one of the three Bass voices and one of the other voice buttons, the keyboard is split. This enables you to perform using a Bass voice in the range of $F_{\#2}$ and lower, while using another voice in the range of G_2 and above.

In BASS SPLIT mode, the selected percussive or sustained voice is automatically sounded in 8-note polyphonic mode, with two notes assigned to the Bass voice and six notes assigned to the other voice.

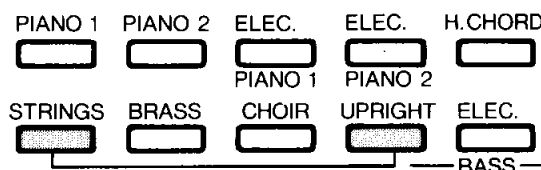

Simultaneously select a Bass voice and another voice.

■ Changing the Touch Curve.

- For touch-sensitive keyboards, the relationship between the key velocity and the volume of the sounded notes will vary with the model. If you have connected EMT-10 to one of the below models, and the volume sounds too high, switch the Touch Curve setting of EMT-10.

CVP-3/5/6/7/8/10

PSR-6300

CLP-20/30/50/100/200/300/500

DSR-2000

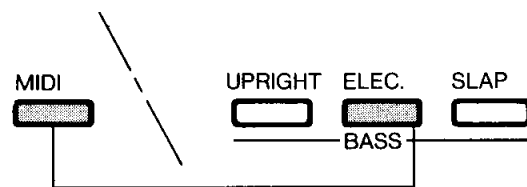

Press while holding down the MIDI button.

- Press the ELEC. BASS button while holding down the MIDI button, then check the currently set mode by looking at the Voice Variator lamps. If the MELLOW lamp is lit, the standard Touch Curve (mezzo forte at Velocity=64) is set; if the BRIGHT lamp is lit, the Touch Curve for Clavinovas and similar instruments (mezzo forte at Velocity=96) is set. Press the ELEC. BASS button once more while holding down the MIDI button to switch the appropriate Voice Variator lamps to ON or OFF.

■ BASS OCTAVE DOWN.

- You can select whether to sound the Bass notes at the same pitch as the input notes or at a pitch one octave lower than the input notes.
- Press the UPRIGHT BASS button while holding down the MIDI button, then check the currently set mode by looking at the Voice Variator lamps. If the MELLOW lamp is lit, the standard mode is set in which the Bass notes are sounded at the same pitch as the input notes; if the BRIGHT lamp is lit, they are sounded at a pitch one octave lower than the input notes. Press the UPRIGHT BASS button once more while holding down the MIDI button to switch the appropriate Voice Variator lamps to ON or OFF.

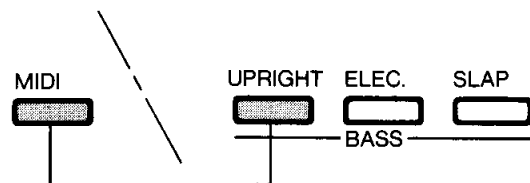

Press while holding down the MIDI button.

■ Selecting the Grouping of Received Notes.

- You can select whether to sound only the even-numbered note numbers, only the odd-numbered note numbers, or all of the note numbers (normal mode). This function is very effective when you want to play a 16-note polyphonic performance by setting one EMT-10 to receive the even-numbered note numbers and another EMT-10 to receive the odd-numbered note numbers.

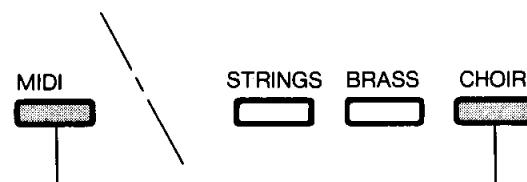

Select the mode while holding down the MIDI button.

- Press the CHOIR button while holding down the MIDI button, then check the currently set mode by looking at the Voice Variator lamps. If both the MELLOW and BRIGHT lamps are lit, all note numbers are sounded; if only the MELLOW lamp is lit, the even-numbered note numbers are sounded; and if only the BRIGHT lamp is lit, the odd-numbered note numbers are sounded. Press the CHOIR button once more while holding down the MIDI button to select the desired mode.

6 MIDI Control

■ MIDI Settings in Power On Status

Send Channel	Channel 1
Receive Channel	Channel 1
Mode	OMNI ON, POLY
Program Changes	Received
Control Changes	Received

All of these settings can be changed except for the POLY mode. In OMNI ON mode, the data of all Channels can be received. "POLY" is an abbreviation of "polyphonic," which means that multiple notes can be sounded at the same time.

■ Setting the Send/Receive Channels

To set a Send Channel, press the PIANO 1 button while holding down the MIDI button (or press PIANO 2 to set the Receive Channel). Each operation increments the current Channel Number by one. After Channel 16, the Channel Number returns to Channel 1.

You can also check the currently set Channel Number by checking the combination of Voice Variator lamps that are lit.

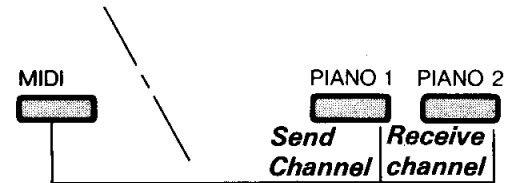

Press while holding down the MIDI button.

Lamp	Added Value	Lit Lamp(s)/Channel	1	2	3	4	5	6	7	8	9	10	11	12	13	14	15	16
BRIGHT	1	BRIGHT	●		●		●		●		●		●		●		●	
FAST	2	FAST		●	●			●	●			●	●			●	●	
MELLOW	4	MELLOW				●	●	●	●					●	●	●	●	
SLOW	8	SLOW								●	●	●	●	●	●	●	●	

Automatic Setting of the Send and Receive Channels

If you turn ON the POWER switch while holding down the MIDI button, both the Send and Receive Channels will be automatically set to Channel 7 and the OMNI OFF mode will be entered.

■ Receiving Mode Changes (OMNI ON/OFF), Program Changes, and Control Changes.

By pressing one of the buttons below while holding down the MIDI button, you can perform the following mode changes.

Button	Mode	MELLOW Lamp	BRIGHT Lamp
ELEC.PIANO 1	OMNI	ON	OFF
ELEC.PIANO 2	Program Change	ON	OFF
H.CHORD	Control Change	ON	OFF

- When OMNI OFF mode is set, only the messages of the specified channel are received.
- When Program Change OFF mode is set, Program Changes (changes in voice numbers) can be neither sent nor received.
- When Control Change OFF mode is set, Control Changes, such as Sustain or Damper ON/OFF data, cannot be received.

■ Sending/Receiving Program Changes (Voice Numbers) FORMAT: [CnH,pp] *n=Channel Number, pp=Voice Number.

Voice	Voice No.
PIANO 1	0
PIANO 2	1
ELEC. PIANO 1	2
ELEC. PIANO 2	3
HARPSICHORD	4
GUITAR	5
STRINGS	6
BRASS	7
CHOIR	8
UPRIGHT BASS	9
ELEC. BASS	10
SLAP BASS	11

- When the voice is changed at the master device (the transmitting side), that voice number is sent and the receiving unit also changes its voice according to the received voice number. This is called a "Program Change." A Program Change is one type of Channel Message, so the Send and Receive Channels must match to allow reception.
- If any voice numbers of 12 or higher are received, the processing of voice numbers is repeated from the starting voice number.
12→0, 13→1, 14→2, 15→3, 16→4...
(48—95 are used for BASS SPLIT)...96→0...127→4.

- The voice numbers used for BASS SPLIT are as follows:

	PIANO 1	PIANO 2	E. PIANO 1	E. PIANO 2	H. CHORD	GUITAR	STRINGS	BRASS	CHOIR
UPRIGHT BASS	48 57	49 58	50 59	51 60	52 61	53 62	54 63	55	56
ELEC. BASS	64 73	65 74	66 75	67 76	68 77	69 78	70 79	71	72
SLAP BASS	80 89	81 90	82 91	83 92	84 93	85 94	86 95	87	88

Exclusive Messages

■ Sending Panel Data. FORMAT: [F0H, 43H, 0nH, 7CH...F7H] *n=Channel No.

To send the current settings at the panel, press the GUITAR button while holding down the MIDI button. This function is mainly used to send panel data to a recorder.

Sent Data ("..." portion)	Pitch data, Transpose data, Octave Shift data, Voice Numbers, Voice Variator data, Polyphonic Mode data, Touch Curve data, Bass Octave Down data, and Received Note Grouping data.
------------------------------	--

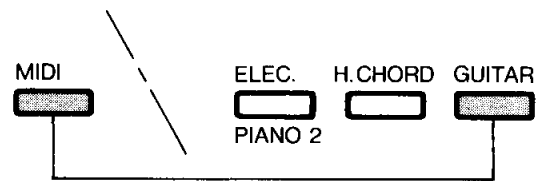

Press while holding down the MIDI button.

■ Sending/Receiving Voice Variator Data FORMAT: [F0H, 43H, 73H, 11H, 11H, nnH, F7H]

When you press a different Voice Variator button, the corresponding data on the right is sent. EMT-10 also responds to these data when received.

BRIGHT	nn=07H
NEUTRAL	nn=08H
MELLOW	nn=09H

FAST	nn=17H
NEUTRAL	nn=18H
SLOW	nn=19H

■ Sending/Receiving the Polyphonic Mode (4-Note/8-Note) of Strings/Brass/Choir Voices.

FORMAT: [F0H, 43H, 73H, 11H, 11H, nnH, F7H]

When the polyphonic mode is switched, the corresponding data on the right is sent. EMT-10 also responds to these data when received.

4-Note mode	nn=40H
8-Note mode	nn=41H

■ Sending/Receiving Touch Curve Changes. FORMAT: [F0H, 43H, 73H, 11H, 11H, nnH, F7H]

When the Touch Curve is changed, the corresponding data on the right is sent. EMT-10 also responds to these data when received.

64=Mezzo forte	nn=50H
96=Mezzo forte	nn=51H

■ Sending/Receiving the Bass Octave Down Data. FORMAT: [F0H, 43H, 73H, 11H, 11H, nnH, F7H]

When the Bass Octave Down function is executed, the corresponding data on the right is sent. EMT-10 also responds to these data when received.

Normal	nn=60H
Octave Down	nn=61H

■ Sending/Receiving the Received Note Grouping Data. FORMAT: [F0H, 43H, 73H, 11H, 11H, nnH, F7H]

When the grouping of received notes is selected, the corresponding data on the right is sent. EMT-10 also responds to these data when received.

Normal	nn=70H
Odd note nos. only	nn=71H
Even note nos. only	nn=72H

■ Other Exclusive Messages

Upon receiving an Exclusive Message having any of the formats below, the corresponding operation is performed.

Panel Data Send Request	FORMAT [F0H, 43H, 2nH, 7CH, F7H]	Send the panel data.
Name Data Send Request	FORMAT [F0H, 43H, 2nH, 7DH, F7H]	Send the Model ID data which indicates the name of the model.
Panel Data Receive Request	FORMAT [F0H, 43H, 0nH, 7CH...F7H]	Receives the panel data corresponding to the "..." portion.

*n=Channel Number.

Possible Operating Errors

- The phenomena listed below are easily misjudged as being mechanical failures. Before you conclude that your unit is defective, make sure to check each of the phenomenon below.
- The EMT-10 is a peripheral device and is never used alone. Consequently, the MIDI functions of any device to be connected greatly influence the use of EMT-10. Carefully read the MIDI-related sections in the manual provided with the target device, and thoroughly check its compatibility with this EMT-10.

Phenomenon	Cause and Solution
No sound is produced.	The LINE OUT jack of EMT-10 is not connected to the AUX IN jack of an amplifier or other device.
The notes stop sounding.	If you perform any of the operations below while notes are being sounded, the notes will stop sounding. <ul style="list-style-type: none"> • Transpose, Octave Shift, Voice change, OMNI mode change, change in the Send/Receive Channels. Sound will be produced the next time a key is pressed.
Bass notes are sounded in BASS SPLIT mode, but stop sounding when the 4-note mode is selected.	The 8-note mode is automatically set when the BASS SPLIT mode is ON. But if you switch to 4-note mode, the BASS SPLIT mode is cancelled and the Bass notes stop sounding.
When five keys of a sustained voice are concurrently pressed, the lowest fifth note is not sounded.	If 4-note polyphonic mode is selected, only the four notes are sounded. If you wish to concurrently sound five or more notes, select 8-note polyphonic mode.
While playing, certain notes change pitch and are sounded in a different octave.	When Transpose or Octave Shift is ON, any resulting notes that are outside of the soundable range are shifted to a higher or lower octave, and sounded within the permissible range. Try cancelling the Transpose or Octave Shift function to achieve the desired results.

Specifications

- | | |
|--|---|
| <ul style="list-style-type: none"> • Voices:
 Percussive: Piano 1, Piano 2,
 Electric Piano 1,
 Electric Piano 2,
 Harpsichord, Guitar
 Sustained: Strings, Brass, Choir
 Percussive Bass: Upright Bass,
 Electric Bass,
 Slap Bass • Sound Generation: AWM (Advanced Wave Memory)
 Sound Generator • Soundable Range: A₋₁ to C₇ • Number of Concurrently Soundable Notes: Percussive/Sustained Voices:
 8-note polyphonic
 Sustained Voices:
 8-note polyphonic • Modes: 8-Note Mode/4-Note Mode
 (Sustained Voices only), Bass Split | <ul style="list-style-type: none"> • Effects: Bright, Mellow, Slow, Fast • Miscellaneous: VOLUME Lever, MIDI Switch • Accessory Jacks: MIDI (IN, OUT, THRU), AUX IN (L,R), LINE OUT (L,R), DC IN (9-12V), DC OUT (9-12V) • Rated Power Supply: DC IN (9-12V)
 Power Adaptor (PA-4/PA-40/PA-5) • Maximum Current: 800 mA • External Dimensions: Width 218 mm (8 3/4")
 Depth 215 mm (8 3/5")
 Height 44 mm (1 3/4") • Weight: 1.2 kg (1.6 lbs) • Accessories: MIDI Cable × 1
 Connecting Cord × 1
 DC Cord × 1
 Holder × 2
 Mounting Plate × 2 |
|--|---|

Function...		Transmitted	Recognized	Remarks
Basic Channel	Default Channel	1 1-16	1 1-16	
Mode	Default Messages Altered	Mode 3 × *****	Mode 1 OMNI ON/OFF ×	
Note Number	True Voice	× *****	0-127 21-108	Bass note range A ₂ -C ₆
Velocity	Note ON Note OFF	× ×	9nH, v = 1-127 ×	
After Touch	Key's Ch's	× ×	× ×	
Pitch Bender		×	×	
Control Change	64 66 67	× × ×	○ ○ ○	Sustain, Damper Sostenuto Soft Pedal
Prog Change	True #	○ 0-88 *****	○ 0-127 0-88	
System Exclusive		○	○	
System Common	: Song Pos : Song Sel : Tune	× × ×	× × ×	
System Real Time	: Clock : Commands	× ×	× ×	
Aux Messages	: Local ON/OFF : All Notes Off : Active Sense : Reset	× × ○ ×	× ○ (123, 124, 125) ○ ×	
Notes				

Mode 1: OMNI ON, POLY
Mode 3: OMNI OFF, POLY

Mode 2: OMNI ON, MONO
Mode 4: OMNI OFF, MONO

○: Yes
×: No

FCC INFORMATION

Attention users in the U.S.A.

This equipment generates and uses radio frequency energy and if not installed and used properly, that is, in strict accordance with the manufacturer's instructions, may cause interference to radio and television reception. It has been type tested and found to comply with the limits for a Class B computing device in accordance with the specifications in Subpart J of Part 15 of FCC Rules, which are designed to provide reasonable protection against such interference in a residential installation. However, there is no guarantee that interference will not occur in a particular installation. If this equipment does cause interference to radio or television reception which can be determined by turning the equipment off and on, the user is encouraged to try to correct the interference by one or more of the following measures.

Reorient the receiver antenna

Relocate the equipment with respect to the receiver

Move the equipment away from the receiver

Plug the equipment into a different outlet so that equipment and receiver are on different branch circuits.

If necessary, the user should consult the dealer or an experienced radio/television technician for additional suggestions. The user may find the following booklet prepared by the Federal Communications Commission helpful:

"How to Identify and Resolve Radio-TV Interference Problems."

This booklet is available from the U.S. Government Printing Office, Washington D.C. 20402. Stock No. 004-000-00345-4.

- This applies only to products distributed by YAMAHA CORPORATION OF AMERICA.

Wichtiger Hinweis für die Benutzung in der Bundesrepublik Deutschland.

CANADA

THIS DIGITAL APPARATUS DOES NOT EXCEED THE "CLASS B" LIMITS FOR RADIO NOISE EMISSIONS FROM DIGITAL APPARATUS SET OUT IN THE RADIO INTERFERENCE REGULATION OF THE CANADIAN DEPARTMENT OF COMMUNICATIONS.

LE PRESENT APPAREIL NUMERIQUE N'EMET PAS DE BRUITS RADIOELECTRIQUES DEPASSANT LES LIMITES APPLICABLES AUX APPAREILS NUMERIQUES DE LA "CLASSE B" PRESCRITES DANS LE REGLEMENT SUR LE BROUILLAGE RADIOELECTRIQUE EDICTE PAR LE MINISTERE DES COMMUNICATIONS DU CANADA.

Bescheinigung des Importeurs

Hiermit wird bescheinigt, daß der/die/des

AWM Sound Expander Typ: EMT-10

(Gerät, Typ, Bezeichnung)

in Übereinstimmung mit den Bestimmungen der

VERFÜGUNG 1046/84

(Amtsblattverfügung)

funk-entstört ist.

Der Deutschen Bundespost wurde das Inverkehrbringen dieses Gerätes angezeigt und die Berechtigung zur Überprüfung der Serie auf Einhaltung der Bestimmungen eingeräumt.

Yamaha Europa GmbH

Name des Importeurs

- This applies only to products distributed by YAMAHA Canada Music Ltd.
- Ceci ne s'applique qu'aux produits distribués par Yamaha Canada Music Ltd.

- Dies bezieht sich nur auf die von der YAMAHA EUROPA GmbH vertriebenen Produkte.

YAMAHA

YAMAHA CORPORATION
P.O.Box 1, Hamamatsu, Japan