



YAMAHA

Clavinova®

Data List
Daten-Liste
Liste des données
Lista de datos

CVP-202

Table of Contents (English)

Voice List	3
Demo Songs	7
Drum/key Assignment List	8
Style List	10
Parameter Chart	11
Fingering Chart	12
MIDI Data Format	13
Effect Type List	24
Effect Parameter List	25
Effect Data Assign Table	29
MIDI Implementation Chart	30
Assembly	32
Specifications	38

Table des matières (Français)

Liste des voix	3
Morceaux de démo	7
Liste d'assignation instrument de batterie/touche du clavier	8
Liste des styles	10
Tableau des paramètres	11
Tablature	12
Format des données MIDI	13
Liste des types d'effet	24
Liste des paramètres d'effets	25
Tableau d'assignation des données d'effets	29
Feuille d'implantation MIDI	30
Montage	32
Spécifications	38

Inhalt (Deutsch)

Stimmenverzeichnis	3
Demo-Songs	7
Verzeichnis der Schlagzeugklänge	8
Style-Verzeichnis	10
Parameterübersicht	11
Akkordliste	12
MIDI-Datenformat	13
Liste der Effektypen	24
Liste der Effektparameter	25
Effekt-daten-Zuordnungstabelle	29
MIDI-Implementierungstabelle	30
Zusammenbau	32
Technische Daten	38

Índice (Español)

Lista de voces	3
Canciones de demostración	7
Lista de asignaciones de teclas/batería	8
Lista de estilos	10
Gráfica de parámetros	11
Gráfica de digitado	12
Formato de datos MIDI	13
Lista de tipos de efecto	24
Lista de parámetros de efectos	25
Tabla de asignación de datos para efectos	29
Gráfico de puesta en práctica de MIDI	30
Montaje	32
Especificaciones	38

Voice List / Stimmenverzeichnis / Liste des voix / Lista de voces



Voice Group	Voice Name	Voice #			
		MSB #	LSB #	Program Change # (0-127)	
Piano & Harpsi.	GrandPiano 1	0	122	0	
	GrandPiano 2	0	112	0	
	BrightPiano1	0	112	1	
	Harpsichord1	0	122	6	
	GrandHarpsi1	0	123	6	
	Honky Tonk	0	112	3	
	Rock Piano	0	114	2	
	Midi Grand	0	112	2	
	CP 80	0	113	2	
	Oct. Piano 1	0	113	3	
	Oct. Piano 2	0	114	3	
	GrandPiano 3	0	116	0	
	GrandPiano 4	0	115	0	
	BrightPiano2	0	116	1	
	BrightPiano3	0	115	1	
	Harpsichord2	0	112	6	
	GrandHarpsi2	0	113	6	
E.Piano	Galaxy EP	0	114	4	
	Polaris EP	0	115	4	
	Hyper Tines	0	113	5	
	New Tines	0	116	5	
	Funk EP	0	112	4	
	DX Modern	0	112	5	
	Modern EP	0	115	5	
	Tremolo EP	0	113	4	
	Super DX	0	117	5	
	Clavi	0	112	7	
	Suitcase EP	0	118	4	
	Venus EP	0	114	5	
	Wah Clavi	0	113	7	
	Organ & Accordion	Church Organ	0	123	19
Pipe Organ		0	112	19	
ChapelOrgan1		0	113	19	
ChapelOrgan2		0	114	19	
ChapelOrgan3		0	115	19	
Rock Organ 1		0	112	18	
Dance Organ		0	113	17	
Gospel Organ		0	119	16	
Purple Organ		0	114	18	
Jazz Organ 1		0	112	16	
Rock Organ 2		0	113	18	
Elec. Organ		0	118	17	
DrawbarOrgan		0	115	16	
Click Organ		0	112	17	
Mellow Draw		0	115	17	
Jazz Organ 2		0	113	16	
Bright Draw		0	116	16	
60's Organ		0	116	17	
Jazz Organ 3		0	120	16	
Blues Organ		0	117	17	
16'+1' Organ		0	121	16	
16'+2' Organ		0	122	16	
16'+4' Organ		0	123	16	
TheatreOrgn1		0	114	16	
TheatreOrgn2		0	114	17	
Musette		0	112	21	
Tutti Accord		0	113	21	
Accordion		0	115	21	
Tango Accord		0	112	23	
Bandoneon		0	113	23	
Soft Accord		0	114	21	
Blues Harp		0	114	22	
Harmonica		0	112	22	
Reed Organ		0	112	20	
Percussion		Vibraphone	0	112	11
		Jazz Vibes	0	113	11

Voice Group	Voice Name	Voice #		
		MSB #	LSB #	Program Change # (0-127)
	Marimba	0	112	12
	Xylophone	0	112	13
	Steel Drums	0	112	114
	Celesta	0	112	8
	Glocken	0	112	9
	Music Box	0	112	10
	Tubular Bell	0	112	14
	Kalimba	0	112	108
	Dulcimer	0	112	15
	Timpani	0	112	47
	StandardKit1	127	0	0
	StandardKit2	127	0	1
	Room Kit	127	0	8
	Rock Kit	127	0	16
	Electro Kit	127	0	24
	Analog Kit	127	0	25
	Dance Kit	127	0	27
	Jazz Kit	127	0	32
	Brush Kit	127	0	40
	Symphony Kit	127	0	48
	StyStd. Kit	127	0	80
	StyBrush Kit	127	0	82
	SFX Kit 1	126	0	0
	SFX Kit 2	126	0	1
Guitar	Spanish Gtr.	0	113	24
	Cool E.Gtr.	0	114	28
	12Str.Guitar	0	113	25
	Solid Guitar	0	118	27
	Vintage Amp	0	115	29
	Pedal Steel	0	125	27
	FeedbackGtr.	0	113	29
	Funk Guitar	0	113	28
	60's Clean	0	117	27
	Vintage Open	0	123	27
	Vintage Mute	0	115	28
	Folk Guitar	0	112	25
	ChorusGuitar	0	124	27
	Vintage Trem	0	120	27
	OctaveGuitar	0	113	26
	Deep Chorus	0	114	27
	CampfireGtr.	0	115	25
	Smooth Nylon	0	114	24
	Tremolo Gtr.	0	113	27
	HawaiianGtr.	0	114	26
	Bright Clean	0	116	27
	Wah Guitar	0	122	27
	Classic Gtr.	0	112	24
	Distortion	0	112	30
	Elec. 12Str.	0	119	27
	Mandolin	0	114	25
	Clean Guitar	0	112	27
	Muted Guitar	0	112	28
	FolkGw_pick1	0	116	25
	FolkGw_pick2	0	117	25
FolkGw_pick3	0	118	25	
Jazz Guitar	0	112	26	
Overdrive	0	112	29	
Bass	Finger Bass	0	112	33
	UprightBass	0	113	32
	Pick Bass	0	112	34
	SuperFretles	0	113	35
	Slap Bass	0	112	36
	Analog Bass	0	112	39
	Hi Q Bass	0	113	38
	Funk Bass	0	112	37
	Acc. Bass	0	112	32

Voice List / Stimmenverzeichnis / Liste des voix / Lista de voces

Voice Group	Voice Name	Voice #			
		MSB #	LSB #	Program Change # (0-127)	
	Fretless	0	112	35	
	Bass&Cymbal	0	114	32	
	Fusion Bass	0	113	36	
	Rave Bass	0	114	38	
	Dance Bass	0	113	39	
	Synth Bass	0	112	38	
Brass	SweetTrumpet	0	115	56	
	Trombone	0	112	57	
	MutedTrumpet	0	112	59	
	Flugel Horn	0	113	56	
	Soft Trumpet	0	114	56	
	BrassSection	0	112	61	
	Mellow Brass	0	116	61	
	BigBandBrass	0	113	61	
	Pop Brass	0	118	61	
	Brass Combo	0	115	66	
	Solo Trumpet	0	112	56	
	Mellow Tromb	0	114	57	
	Trb. Section	0	113	57	
	French Horn	0	112	60	
	Mellow Horns	0	119	61	
	Bright Brass	0	120	61	
	Full Horns	0	114	61	
	High Brass	0	115	61	
	Ballroom Brs	0	113	59	
	Small Brass	0	117	61	
	80's Brass	0	113	62	
	Analog Brass	0	112	63	
	Techno Brass	0	114	62	
	Synth Brass	0	112	62	
	Brass Hit	0	126	61	
Tuba	0	112	58		
WoodWind	Sweet Tenor	0	117	66	
	Breathy Alto	0	113	65	
	Soprano Sax	0	112	64	
	Clarinet	0	112	71	
	Sweet Flute	0	114	73	
	Tenor Sax	0	112	66	
	Pan Flute	0	113	73	
	Oboe	0	112	68	
	English Horn	0	112	69	
	Baritone Sax	0	112	67	
	Breath Tenor	0	114	66	
	Alto Sax	0	112	65	
	MelClarinet	0	113	71	
	Bassoon	0	112	70	
	ClassicFlute	0	115	73	
	Piccolo	0	112	72	
	Ethnic Flute	0	112	75	
	Flute	0	112	73	
	Shakuhachi	0	112	77	
	Whistle	0	112	78	
	Recorder	0	112	74	
	Ocarina	0	112	79	
	WoodwindEns.	0	113	66	
	Sax Section	0	116	66	
	Bagpipe	0	112	109	
	Strings	Orch.Strings	0	113	48
		Symphon.Strs	0	114	48
		Strings	0	112	48
		Slow Strings	0	113	49
		Chamber Strs	0	112	49
		SynthStrings	0	112	50
		ConcertoStrs	0	115	48
		Orch. Brass	0	118	49
Orch. Flute		0	119	49	

Voice Group	Voice Name	Voice #			
		MSB #	LSB #	Program Change # (0-127)	
	Orch. Oboe	0	121	49	
	Solo Violin	0	112	40	
	Soft Violin	0	113	40	
	Fiddle	0	112	110	
	Viola	0	112	41	
	Cello	0	112	42	
	Contrabass	0	112	43	
	Str. Quartet	0	114	49	
	Bow Strings	0	116	48	
	Marcato Strs	0	115	49	
	Tremolo Strs	0	112	44	
	Pizz.Strings	0	112	45	
	Analog Strs	0	112	51	
	Tech Strings	0	113	50	
	Harp	0	112	46	
	Hackbrett	0	113	46	
	Banjo	0	112	105	
	Sitar	0	112	104	
	Koto	0	112	107	
	Shamisen	0	112	106	
	Orch. Hit	0	112	55	
	Choir & Pad	Gothic Vox	0	113	53
		Vocal Ens.	0	113	52
		Vox Humana	0	112	53
		Choir	0	112	52
		Air Choir	0	112	54
		Cyber Pad	0	113	99
		Fantasia	0	112	88
		Insomnia	0	113	94
		Wave 2001	0	112	95
		Atmosphere	0	112	99
		Xenon Pad	0	112	91
		Equinox	0	112	94
		DX Pad	0	112	92
		Symbiont	0	113	88
		Stargate	0	114	88
		Area 51	0	112	89
		Dark Moon	0	113	89
		Ionosphere	0	115	94
		Golden Age	0	115	88
	Solaris	0	114	94	
Millennium	0	117	88		
Transform	0	113	95		
Synth.	Square Lead	0	112	80	
	Saw. Lead	0	112	81	
	Fire Wire	0	116	81	
	Analogon	0	115	81	
	Fargo	0	119	81	
	Blaster	0	114	81	
	Big Lead	0	113	81	
	Warp	0	117	81	
	Tiny Lead	0	118	80	
	Stardust	0	112	98	
	Aero Lead	0	112	83	
	Mini Lead	0	114	80	
	Sub Aqua	0	118	81	
Sun Bell	0	113	98		
Hi Bias	0	116	80		
Viny lead	0	115	80		

Voice List / Stimmenverzeichnis / Liste des voix / Lista de voces

XG

Voice Name	Voice #		
	MSB #	LSB #	Program Change # (0-127)
GrandPno	0	0	0
GrndPnoK	0	1	0
MelloGrP	0	18	0
PianoStr	0	40	0
Dream	0	41	0
BritePno	0	0	1
BritPnoK	0	1	1
El.Grand	0	0	2
ElGrPnoK	0	1	2
Det.CP80	0	32	2
LayerCP1	0	40	2
LayerCP2	0	41	2
HnkyTonk	0	0	3
HnkyTnkK	0	1	3
E.Piano1	0	0	4
El.Pno1K	0	1	4
MelloEP1	0	18	4
Chor.EP1	0	32	4
HardEl.P	0	40	4
VX El.P1	0	45	4
60sEl.P1	0	64	4
E.Piano2	0	0	5
El.Pno2K	0	1	5
Chor.EP2	0	32	5
DX Hard	0	33	5
DXLegend	0	34	5
DX Phase	0	40	5
DX+Analg	0	41	5
DXKotoEP	0	42	5
VX El.P2	0	45	5
Harpsi.	0	0	6
Harpsi.K	0	1	6
Harpsi.2	0	25	6
Harpsi.3	0	35	6
Clavi	0	0	7
Clavi K	0	1	7
ClaviWah	0	27	7
PulseClv	0	64	7
PierceCl	0	65	7
Celesta	0	0	8
Glocken	0	0	9
MusicBox	0	0	10
Orgel	0	64	10
Vibes	0	0	11
Vibes K	0	1	11
HardVibe	0	45	11
Marimba	0	0	12
MarimbaK	0	1	12
SineMrmb	0	64	12
Balimba	0	97	12
Log Drum	0	98	12
Xylophon	0	0	13
TubulBel	0	0	14
ChrchBel	0	96	14
Carillon	0	97	14
Dulcimer	0	0	15
Dulcimr2	0	35	15
Cimbalom	0	96	15
Santur	0	97	15
DrawOrgn	0	0	16

Voice Name	Voice #		
	MSB #	LSB #	Program Change # (0-127)
DetDrwOr	0	32	16
60sDrOr1	0	33	16
60sDrOr2	0	34	16
70sDrOr1	0	35	16
DrawOrg2	0	36	16
60sDrOr3	0	37	16
EvenBar	0	38	16
16+2'2/3	0	40	16
Organ Ba	0	64	16
70sDrOr2	0	65	16
CheezOrg	0	66	16
DrawOrg3	0	67	16
PercOrgn	0	0	17
70sPcOr1	0	24	17
DetPrcOr	0	32	17
Lite Org	0	33	17
PercOrg2	0	37	17
RockOrgn	0	0	18
RotaryOr	0	64	18
SloRotar	0	65	18
FstRotar	0	66	18
ChrchOrg	0	0	19
ChurOrg3	0	32	19
ChurOrg2	0	35	19
NotreDam	0	40	19
OrgFlute	0	64	19
TrmOrgFl	0	65	19
ReedOrgn	0	0	20
Puff Org	0	40	20
Acordion	0	0	21
AccordIt	0	32	21
Harmnica	0	0	22
Harmo. 2	0	32	22
TangoAcd	0	0	23
TngoAcd2	0	64	23
NylonGtr	0	0	24
NylonGt2	0	16	24
NylonGt3	0	25	24
VelGtHrm	0	43	24
Ukulele	0	96	24
SteelGtr	0	0	25
SteelGt2	0	16	25
12StrGtr	0	35	25
Nyln&Stl	0	40	25
Stl&Body	0	41	25
Mandolin	0	96	25
Jazz Gtr	0	0	26
MelloGtr	0	18	26
Jazz Amp	0	32	26
CleanGtr	0	0	27
ChorusGt	0	32	27
Mute Gtr	0	0	28
FunkGtr1	0	40	28
MuteStlG	0	41	28
FunkGtr2	0	43	28
Jazz Man	0	45	28
Ovrdrive	0	0	29
Gt.Pinch	0	43	29
Dist.Gtr	0	0	30
FeedbkGt	0	40	30

Voice Name	Voice #		
	MSB #	LSB #	Program Change # (0-127)
FeedbGt2	0	41	30
GtrHarmo	0	0	31
GtFeedbk	0	65	31
GtrHrmo2	0	66	31
Aco.Bass	0	0	32
JazzRthm	0	40	32
VXUprght	0	45	32
FngrBass	0	0	33
FingrDrk	0	18	33
FlangeBa	0	27	33
Ba&DstEG	0	40	33
FngrSlap	0	43	33
FngBass2	0	45	33
Mod.Bass	0	65	33
PickBass	0	0	34
MutePkBa	0	28	34
Fretless	0	0	35
Fretles2	0	32	35
Fretles3	0	33	35
Fretles4	0	34	35
SynFretl	0	96	35
SmthFrt1	0	97	35
SlapBas1	0	0	36
ResoSlap	0	27	36
PunchThm	0	32	36
SlapBas2	0	0	37
VeloSlap	0	43	37
SynBass1	0	0	38
SynBa1Dk	0	18	38
FastResB	0	20	38
AcidBass	0	24	38
Clv Bass	0	35	38
TechnoBa	0	40	38
Orbiter	0	64	38
Sqr.Bass	0	65	38
RubberBa	0	66	38
Hammer	0	96	38
SynBass2	0	0	39
MelloSBa	0	6	39
Seq Bass	0	12	39
ClkSynBa	0	18	39
SynBa2Dk	0	19	39
SmthSynB	0	32	39
ModulrBa	0	40	39
DX Bass	0	41	39
X WireBa	0	64	39
Violin	0	0	40
Slow Vln	0	8	40
Viola	0	0	41
Cello	0	0	42
Contrabs	0	0	43
Trem.Str	0	0	44
SlwTrStr	0	8	44
Susp.Str	0	40	44
Pizz.Str	0	0	45
Harp	0	0	46
YangChin	0	40	46
Timpani	0	0	47
Strings1	0	0	48
S.Strngs	0	3	48

XG

Voice Name	Voice #		
	MSB #	LSB #	Program Change # (0-127)
Bright	0	0	100
FantaBel	0	64	100
Smokey	0	96	100
Goblins	0	0	101
GobSynth	0	64	101
Creeper	0	65	101
Ring Pad	0	66	101
Ritual	0	67	101
ToHeaven	0	68	101
Night	0	70	101
Glisten	0	71	101
BelChoir	0	96	101
Echoes	0	0	102
Echoes 2	0	8	102
Echo Pan	0	14	102
EchoBell	0	64	102
Big Pan	0	65	102
SynPiano	0	66	102
Creation	0	67	102
StarDust	0	68	102
Reso&Pan	0	69	102
Sci-Fi	0	0	103
Starz	0	64	103
Sitar	0	0	104
DetSitar	0	32	104
Sitar 2	0	35	104
Tambra	0	96	104
Tamboura	0	97	104
Banjo	0	0	105
MuteBnjo	0	28	105
Rabab	0	96	105
Gopichnt	0	97	105
Oud	0	98	105
Shamisen	0	0	106
Koto	0	0	107
Taisho-k	0	96	107
Kanoon	0	97	107
Kalimba	0	0	108
Bagpipe	0	0	109

Voice Name	Voice #		
	MSB #	LSB #	Program Change # (0-127)
Fiddle	0	0	110
Shanai	0	0	111
Shanai 2	0	64	111
Pungi	0	96	111
Hichriki	0	97	111
TnkIBell	0	0	112
Bonang	0	96	112
Altair	0	97	112
Gamelan	0	98	112
S.Gamlan	0	99	112
Rama Cym	0	100	112
AsianBel	0	101	112
Agogo	0	0	113
SteelDrm	0	0	114
GlasPerc	0	97	114
ThaiBell	0	98	114
WoodBlok	0	0	115
Castanet	0	96	115
TaikoDrm	0	0	116
Gr.Cassa	0	96	116
MelodTom	0	0	117
Mel Tom2	0	64	117
Real Tom	0	65	117
Rock Tom	0	66	117
Syn Drum	0	0	118
Ana Tom	0	64	118
ElecPerc	0	65	118
RevCymb1	0	0	119
FretNoiz	0	0	120
BrthNoiz	0	0	121
Seashore	0	0	122
Tweet	0	0	123
Telephone	0	0	124
Helicptr	0	0	125
Applause	0	0	126
Gunshot	0	0	127
CuttngNz	64	0	0
CttngNz2	64	0	1
Str Slap	64	0	3

Voice Name	Voice #		
	MSB #	LSB #	Program Change # (0-127)
Fl.KClik	64	0	16
Shower	64	0	32
Thunder	64	0	33
Wind	64	0	34
Stream	64	0	35
Bubble	64	0	36
Feed	64	0	37
Dog	64	0	48
Horse	64	0	49
Tweet 2	64	0	50
Ghost	64	0	54
Maou	64	0	55
Tel.Dial	64	0	64
DoorSqek	64	0	65
DoorSlam	64	0	66
ScratchC	64	0	67
ScratchS	64	0	68
WindChim	64	0	69
Telphon2	64	0	70
CarElgnt	64	0	80
CarTSqel	64	0	81
Car Pass	64	0	82
CarCrash	64	0	83
Siren	64	0	84
Train	64	0	85
JetPlane	64	0	86
Starship	64	0	87
Burst	64	0	88
Coaster	64	0	89
Submarin	64	0	90
Laugh	64	0	96
Scream	64	0	97
Punch	64	0	98
Heart	64	0	99
Footstep	64	0	100
MchinGun	64	0	112
LaserGun	64	0	113
Xplosion	64	0	114
Firework	64	0	115

Demo Songs / Demo-Songs / Morceaux de démo / Canciones de demostración

SONG DEMO

	Title	Composer
Song 1	Andante Spianato and Grand Polonaise Brillante Op.22	F. Chopin
Song 3	Beautiful Dreamer	S.C. Foster
Song 4	Annie Laurie	Traditional

VOICE DEMO

Voice Group	Title	Composer
Piano&Harpsi.	Consolation No.3	F. Chopin
	Gavotte	J.S. Bach

- Some of the demonstration pieces listed above are specially-arranged excerpts from the original compositions listed above. All other songs are original (© 2003 Yamaha Corporation).
- Bei manchen der oben aufgelisteten Demostücke handelt es sich um Auszüge aus den Originalkompositionen mit speziellem Arrangement. Alle anderen Stücke sind eigene Kompositionen (© 2003 Yamaha Corporation).
- Certains des morceaux de démonstration énumérés ci-dessus sont de courts extraits des compositions originales. Tous les autres morceaux sont des créations originales (© 2003 Yamaha Corporation).
- Algunas de las piezas de demostración arriba listadas son exceptos especialmente preparados de las composiciones originales de arriba. Todas las otras canciones son originales (© 2003 Yamaha Corporation.)

Drum/key Assignment List / Verzeichnis der Liste d'assignation instrument de batterie/ Lista de asignaciones de teclas/batería

Bank Select MSB					127	127	127	127	127	127	127	
Bank Select LSB					0	0	0	0	0	0	0	
Program Change (0-127)					0	1	8	16	24	25	27	
Keyboard Note	MIDI		Key off	Alternate assign	Standard Kit 1	Standard Kit 2	Room Kit	Rock Kit	Electro Kit	Analog Kit	Dance Kit	
	Note #	Note										
C#	1	13	C#	-1	3	Surdo Mute	Surdo Mute	Surdo Mute	Surdo Mute	Surdo Mute	Surdo Mute	Surdo Mute
D	1	14	D	-1	3	Surdo Open	Surdo Open	Surdo Open	Surdo Open	Surdo Open	Surdo Open	Surdo Open
D#	1	15	D#	-1		Hi Q	Hi Q	Hi Q	Hi Q	Hi Q	Hi Q	Hi Q
E	1	16	E	-1		Whip Slap	Whip Slap	Whip Slap	Whip Slap	Whip Slap	Whip Slap	Whip Slap
F	1	17	F	-1	4	Scratch H	Scratch H	Scratch H	Scratch H	Scratch H	Scratch H	Scratch H
F#	1	18	F#	-1	4	Scratch L	Scratch L	Scratch L	Scratch L	Scratch L	Scratch L	Scratch L
G	1	19	G	-1		Finger Snap	Finger Snap	Finger Snap	Finger Snap	Finger Snap	Finger Snap	Finger Snap
G#	1	20	G#	-1		Click Noise	Click Noise	Click Noise	Click Noise	Click Noise	Click Noise	Click Noise
A	1	21	A	-1		Mtrnm Click	Mtrnm Click	Mtrnm Click	Mtrnm Click	Mtrnm Click	Mtrnm Click	Mtrnm Click
A#	1	22	A#	-1		Mtrnm Bell	Mtrnm Bell	Mtrnm Bell	Mtrnm Bell	Mtrnm Bell	Mtrnm Bell	Mtrnm Bell
B	1	23	B	-1		Seq Click L	Seq Click L	Seq Click L	Seq Click L	Seq Click L	Seq Click L	Seq Click L
C	2	24	C	0		Seq Click H	Seq Click H	Seq Click H	Seq Click H	Seq Click H	Seq Click H	Seq Click H
C#	2	25	C#	0		Brush Tap	Brush Tap	Brush Tap	Brush Tap	Brush Tap	Brush Tap	Brush Tap
D	2	26	D	0	○	Brush Swirl	Brush Swirl	Brush Swirl	Brush Swirl	Brush Swirl	Brush Swirl	Brush Swirl
D#	2	27	D#	0		Brush Slap	Brush Slap	Brush Slap	Brush Slap	Brush Slap	Brush Slap	Brush Slap
E	2	28	E	0	○	BrushTapSwrl	BrushTapSwrl	BrushTapSwrl	BrushTapSwrl	ReversCymbal	ReversCymbal	ReversCymbal
F	2	29	F	0	○	Snare Roll	Snare Roll 2	Snare Roll	Snare Roll	Snare Roll	Snare Roll	Snare Roll
F#	2	30	F#	0		Castanet	Castanet	Castanet	Castanet	Hi Q 2	Hi Q 2	Hi Q 2
G	2	31	G	0		Snare Soft	Snare Soft 2	Snare Soft	Snare Noisy	SnrSnpylctr	SnareNoisy 4	SnareTechno3
G#	2	32	G#	0		Sticks	Sticks	Sticks	Sticks	Sticks	Sticks	Sticks
A	2	33	A	0		Kick Soft	Kick Soft	Kick Soft	Kick Tight 2	Kick 3	Kick Tight 2	KickTechno Q
A#	2	34	A#	0		OpenRimShot	RimShotHShrt	OpenRimShot	OpenRimShot	OpenRimShot	OpenRimShot	Rim Gate
B	2	35	B	0		Kick Tight	KickTghtShrt	Kick Tight	Kick 2	Kick Gate	KickAnlgShrt	KickTechno L
C	3	36	C	1		Kick	Kick Short	Kick	Kick Gate	KckGateHeavy	KickAnlg	KickTechno 2
C#	3	37	C#	1		Side Stick	Side Stick	Side Stick	Side Stick	Side Stick	SideStickAn	SideStickAn
D	3	38	D	1		Snare	Snare Short	Snare Snappy	Snare Rock	SnareNoisy 2	SnareAnalog	Snare Clap
D#	3	39	D#	1		Hand Clap	Hand Clap	Hand Clap	Hand Clap	Hand Clap	Hand Clap	Hand Clap
E	3	40	E	1		Snare Tight	SnareTight H	SnrTightSnp	SnareRockRim	SnareNoisy 3	SnareAnalog2	Snare Dry 2
F	3	41	F	1		Floor Tom L	Floor Tom L	Tom Room 1	Tom Rock 1	TomElectro 1	Tom Analog 1	Tom Analog 1
F#	3	42	F#	1	1	Hi-HatClosed	Hi-HatClosed	Hi-HatClosed	Hi-HatClosed	Hi-HatClosed	HatCloseAnlg	HiHatClose 3
G	3	43	G	1		Floor Tom H	Floor Tom H	Tom Room 2	Tom Rock 2	TomElectro 2	Tom Analog 2	Tom Analog 2
G#	3	44	G#	1	1	Hi-Hat Pedal	Hi-Hat Pedal	Hi-Hat Pedal	Hi-Hat Pedal	Hi-Hat Pedal	HatCloseAn 2	HatCloseAn 2
A	3	45	A	1		Low Tom	Low Tom	Tom Room 3	Tom Rock 3	TomElectro 3	Tom Analog 3	Tom Analog 3
A#	3	46	A#	1	1	Hi-Hat Open	Hi-Hat Open	Hi-Hat Open	Hi-Hat Open	Hi-Hat Open	HatOpen Anlg	HiHat Open 3
B	3	47	B	1		Mid Tom L	Mid Tom L	Tom Room 4	Tom Rock 4	TomElectro 4	Tom Analog 4	Tom Analog 4
C	4	48	C	2		Mid Tom H	Mid Tom H	Tom Room 5	Tom Rock 5	TomElectro 5	Tom Analog 5	Tom Analog 5
C#	4	49	C#	2		CrashCymbal1	CrashCymbal1	CrashCymbal1	CrashCymbal1	CrashCymbal1	Crash Analog	Crash Analog
D	4	50	D	2		High Tom	High Tom	Tom Room 6	Tom Rock 6	TomElectro 6	Tom Analog 6	Tom Analog 6
D#	4	51	D#	2		RideCymbal 1	RideCymbal 1	RideCymbal 1	RideCymbal 1	RideCymbal 1	RideCymbal 1	RideCymbal 1
E	4	52	E	2		Chinese Cym	Chinese Cym	Chinese Cym	Chinese Cym	Chinese Cym	Chinese Cym	Chinese Cym
F	4	53	F	2		Ride Cym Cup	Ride Cym Cup	Ride Cym Cup	Ride Cym Cup	Ride Cym Cup	Ride Cym Cup	Ride Cym Cup
F#	4	54	F#	2		Tambourine	Tambourine	Tambourine	Tambourine	Tambourine	Tambourine	Tambourine
G	4	55	G	2		SplashCymbal	SplashCymbal	SplashCymbal	SplashCymbal	SplashCymbal	SplashCymbal	SplashCymbal
G#	4	56	G#	2		Cowbell	Cowbell	Cowbell	Cowbell	Cowbell	Cowbell Anlg	Cowbell Anlg
A	4	57	A	2		CrashCymbal2	CrashCymbal2	CrashCymbal2	CrashCymbal2	CrashCymbal2	CrashCymbal2	CrashCymbal2
A#	4	58	A#	2		Vibraslap	Vibraslap	Vibraslap	Vibraslap	Vibraslap	Vibraslap	Vibraslap
B	4	59	B	2		RideCymbal 2	RideCymbal 2	RideCymbal 2	RideCymbal 2	RideCymbal 2	RideCymbal 2	RideCymbal 2
C	5	60	C	3		Bongo H	Bongo H	Bongo H	Bongo H	Bongo H	Bongo H	Bongo H
C#	5	61	C#	3		Bongo L	Bongo L	Bongo L	Bongo L	Bongo L	Bongo L	Bongo L
D	5	62	D	3		Conga H Mute	Conga H Mute	Conga H Mute	Conga H Mute	Conga H Mute	Conga Anlg H	Conga Anlg H
D#	5	63	D#	3		Conga H Open	Conga H Open	Conga H Open	Conga H Open	Conga H Open	Conga Anlg M	Conga Anlg M
E	5	64	E	3		Conga L	Conga L	Conga L	Conga L	Conga L	Conga Anlg L	Conga Anlg L
F	5	65	F	3		Timbale H	Timbale H	Timbale H	Timbale H	Timbale H	Timbale H	Timbale H
F#	5	66	F#	3		Timbale L	Timbale L	Timbale L	Timbale L	Timbale L	Timbale L	Timbale L
G	5	67	G	3		Agogo H	Agogo H	Agogo H	Agogo H	Agogo H	Agogo H	Agogo H
G#	5	68	G#	3		Agogo L	Agogo L	Agogo L	Agogo L	Agogo L	Agogo L	Agogo L
A	5	69	A	3		Cabasa	Cabasa	Cabasa	Cabasa	Cabasa	Cabasa	Cabasa
A#	5	70	A#	3		Maracas	Maracas	Maracas	Maracas	Maracas	Maracas 2	Maracas 2
B	5	71	B	3	○	SambaWhistlH	SambaWhistlH	SambaWhistlH	SambaWhistlH	SambaWhistlH	SambaWhistlH	SambaWhistlH
C	6	72	C	4	○	SambaWhistlL	SambaWhistlL	SambaWhistlL	SambaWhistlL	SambaWhistlL	SambaWhistlL	SambaWhistlL
C#	6	73	C#	4		Guiro Short	Guiro Short	Guiro Short	Guiro Short	Guiro Short	Guiro Short	Guiro Short
D	6	74	D	4	○	Guiro Long	Guiro Long	Guiro Long	Guiro Long	Guiro Long	Guiro Long	Guiro Long
D#	6	75	D#	4		Claves	Claves	Claves	Claves	Claves	Claves 2	Claves 2
E	6	76	E	4		Wood Block H	Wood Block H	Wood Block H	Wood Block H	Wood Block H	Wood Block H	Wood Block H
F	6	77	F	4		Wood Block L	Wood Block L	Wood Block L	Wood Block L	Wood Block L	Wood Block L	Wood Block L
F#	6	78	F#	4		Cuica Mute	Cuica Mute	Cuica Mute	Cuica Mute	Scratch H 2	Scratch H 2	Scratch H 2
G	6	79	G	4		Cuica Open	Cuica Open	Cuica Open	Cuica Open	Scratch L 2	Scratch L 3	Scratch L 3
G#	6	80	G#	4	2	TriangleMute	TriangleMute	TriangleMute	TriangleMute	TriangleMute	TriangleMute	TriangleMute
A	6	81	A	4	2	TriangleOpen	TriangleOpen	TriangleOpen	TriangleOpen	TriangleOpen	TriangleOpen	TriangleOpen
A#	6	82	A#	4		Shaker	Shaker	Shaker	Shaker	Shaker	Shaker	Shaker
B	6	83	B	4		Jingle Bells	Jingle Bells	Jingle Bells	Jingle Bells	Jingle Bells	Jingle Bells	Jingle Bells
C	7	84	C	5		Bell Tree	Bell Tree	Bell Tree	Bell Tree	Bell Tree	Bell Tree	Bell Tree
-		85	C#	5								
-		86	D	5								
-		87	D#	5								
-		88	E	5								
-		89	F	5								
-		90	F#	5								
-		91	G	5								

- Key Off: Keys marked "○" stop sounding the instant they are released.
- Alternate Assign: Playing any instrument within a numbered group will immediately stop the sound of any other instrument in the same group of the same number.

- Key Off: Durch "○" gekennzeichnete Klänge verstummen beim Loslassen der Taste.
- Alternate Assign: Mit derselben Nummer gekennzeichnete Klänge werden von demselben Instrument erzeugt und können daher nicht gleichzeitig produziert werden. Spielt einer dieser Klänge gerade, wird er beim Anschlagen einer anderen Taste mit derselben "Alternate Assign"-Nummer stummgeschaltet.

Schlagzeugklänge / touche du clavier /

Bank Select MSB					127	127	127	127	127	126	126
Bank Select LSB					0	0	0	0	0	0	0
Program Change (0-127)					32	40	48	80	82	0	1
Keyboard Note	MIDI		Key off	Alternate assign	Jazz Kit	Brush Kit	Symphony Kit	Sty Std.Kit	Sty BrushKit	SFX Kit 1	SFX Kit 2
	Note #	Note									
C# 1	13	C# -1		3	Surdo Mute	Surdo Mute	Surdo Mute	Surdo Mute	Surdo Mute		
D 1	14	D -1		3	Surdo Open	Surdo Open	Surdo Open	Surdo Open	Surdo Open		
D# 1	15	D# -1			Hi Q	Hi Q	Hi Q	Hi Q	Hi Q		
E 1	16	E -1			Whip Slap	Whip Slap	Whip Slap	Whip Slap	Whip Slap		
F 1	17	F -1		4	Scratch H	Scratch H	Scratch H	Scratch H	Scratch H		
F# 1	18	F# -1		4	Scratch L	Scratch L	Scratch L	Scratch L	Scratch L		
G 1	19	G -1			Finger Snap	Finger Snap	Finger Snap	Finger Snap	Finger Snap		
G# 1	20	G# -1			Click Noise	Click Noise	Click Noise	Click Noise	Click Noise		
A 1	21	A -1			Mtrnm Click	Mtrnm Click	Mtrnm Click	Mtrnm Click	Mtrnm Click		
A# 1	22	A# -1			Mtrnm Bell	Mtrnm Bell	Mtrnm Bell	Mtrnm Bell	Mtrnm Bell		
B 1	23	B -1			Seq Click L	Seq Click L	Seq Click L	Seq Click L	Seq Click L		
C 2	24	C 0			Seq Click H	Seq Click H	Seq Click H	Seq Click H	Seq Click H		
C# 2	25	C# 0			Brush Tap	Brush Tap	Brush Tap	BrshTpStyStd	BrshTpStBrsh		
D 2	26	D 0	○		Brush Swirl	Brush Swirl	Brush Swirl	BrshSwStyStd	BrshSwStBrsh		
D# 2	27	D# 0			Brush Slap	Brush Slap	Brush Slap	BrshSlStyStd	BrshSlStBrsh		
E 2	28	E 0	○		BrushTapSwrl	BrushTapSwrl	BrushTapSwrl	BrshTSStyStd	BrshTSSStBrsh		
F 2	29	F 0	○		Snare Roll	Snare Roll	Snare Roll	Snare Roll	Snare Roll		
F# 2	30	F# 0			Castanet	Castanet	Castanet	Castanet	Castanet		
G 2	31	G 0			Snare Soft	Brush Slap 2	Brush Slap 2	SnrSftStyStd	SnrSftStBrsh		
G# 2	32	G# 0			Sticks	Sticks	Sticks	Sticks	Sticks		
A 2	33	A 0			Kick Soft	Kick Soft	Kick Soft 2	KckSftStyStd	KckSftStBrsh		
A# 2	34	A# 0			OpenRimShot	OpenRimShot	OpenRimShot	RimShtStyStd	RimShtStBrsh		
B 2	35	B 0			Kick Tight	Kick Tight	Gran Cassa	KickT StyStd	KickT StBrsh		
C 3	36	C 1			Kick Jazz	Kick Small	GranCassa Mu	Kick StyStd	Kick StBrsh	CuttingNoiz	Phone Call
C# 3	37	C# 1			Side Stick	Side Stick	Side Stick	S StkStyStd	S StkStBrsh	CuttingNoiz2	Door Squeak
D 3	38	D 1			Snare	Brush Slap 3	Band Snare	Snare StyStd	Snare StBrsh		Door Slam
D# 3	39	D# 1			Hand Clap	Hand Clap	Hand Clap	Hand Clap	Hand Clap	String Slap	Scratch Cut
E 3	40	E 1			Snare Tight	Brush Tap 2	Band Snare 2	Snr T StyStd	Snr T StBrsh		Scratch H 3
F 3	41	F 1			Tom Jazz 1	Tom Brush 1	Tom Jazz 1	FirTmLStyStd	FirTmLStBrsh		Wind Chime
F# 3	42	F# 1		1	Hi-HatClosed	Hi-HatClosed	Hi-HatClosed	HHCls StyStd	HHCls StBrsh		Telephone 2
G 3	43	G 1			Tom Jazz 2	Tom Brush 2	Tom Jazz 2	FirTmHStyStd	FirTmHStBrsh		
G# 3	44	G# 1		1	Hi-Hat Pedal	Hi-Hat Pedal	Hi-Hat Pedal	HHPdl StyStd	HHPdl StBrsh		
A 3	45	A 1			Tom Jazz 3	Tom Brush 3	Tom Jazz 3	LoTmStyStd	LoTmStBrsh		
A# 3	46	A# 1		1	Hi-Hat Open	Hi-Hat Open	Hi-Hat Open	HHOpn StyStd	HHOpn StBrsh		
B 3	47	B 1			Tom Jazz 4	Tom Brush 4	Tom Jazz 4	MidTmLStyStd	MidTmLStBrsh		
C 4	48	C 2			Tom Jazz 5	Tom Brush 5	Tom Jazz 5	MidTmHStyStd	MidTmHStBrsh		
C# 4	49	C# 2			CrashCymbal1	CrashCymbal1	Hand Cymbal	Crash1StyStd	Crash1StBrsh		
D 4	50	D 2			Tom Jazz 6	Tom Brush 6	Tom Jazz 6	HiTom StyStd	HiTom StBrsh		
D# 4	51	D# 2			RideCymbal 1	RideCymbal 1	HandCymShort	Ride1 StyStd	Ride1 StBrsh		
E 4	52	E 2			Chinese Cym	Chinese Cym	Chinese Cym	ChiCymStyStd	ChiCymStBrsh	Fl.Key Click	Ignition
F 4	53	F 2			Ride Cym Cup	Ride Cym Cup	Ride Cym Cup	R Cup StyStd	R Cup StBrsh		Squeal
F# 4	54	F# 2			Tambourine	Tambourine	Tambourine	Tambourine	Tambourine		Exhaust
G 4	55	G 2			SplashCymbal	SplashCymbal	SplashCymbal	SplashStyStd	SplashStBrsh		Crash
G# 4	56	G# 2			Cowbell	Cowbell	Cowbell	Cowbell	Cowbell		Siren
A 4	57	A 2			CrashCymbal2	CrashCymbal2	HandCymbal 2	Crash2StyStd	Crash2StBrsh		Train
A# 4	58	A# 2			Vibraslap	Vibraslap	Vibraslap	Vibraslap	Vibraslap		Jet Plane
B 4	59	B 2			RideCymbal 2	RideCymbal 2	HandCym2Shrt	Ride 2StyStd	Ride 2StBrsh		Starship
C 5	60	C 3			Bongo H	Bongo H	Bongo H	Bongo H	Bongo H		Burst
C# 5	61	C# 3			Bongo L	Bongo L	Bongo L	Bongo L	Bongo L		Coaster
D 5	62	D 3			Conga H Mute	Conga H Mute	Conga H Mute	Conga H Mute	Conga H Mute		Submarine
D# 5	63	D# 3			Conga H Open	Conga H Open	Conga H Open	Conga H Open	Conga H Open		
E 5	64	E 3			Conga L	Conga L	Conga L	Conga L	Conga L		
F 5	65	F 3			Timbale H	Timbale H	Timbale H	Timbale H	Timbale H		
F# 5	66	F# 3			Timbale L	Timbale L	Timbale L	Timbale L	Timbale L		
G 5	67	G 3			Agogo H	Agogo H	Agogo H	Agogo H	Agogo H		
G# 5	68	G# 3			Agogo L	Agogo L	Agogo L	Agogo L	Agogo L	Shower	Laugh
A 5	69	A 3			Cabasa	Cabasa	Cabasa	Cabasa	Cabasa	Thunder	Scream
A# 5	70	A# 3			Maracas	Maracas	Maracas	Maracas	Maracas	Wind	Punch
B 5	71	B 3	○		SambaWhistlH	SambaWhistlH	SambaWhistlH	SambaWhistlH	SambaWhistlH	Stream	Heartbeat
C 6	72	C 4	○		SambaWhistlL	SambaWhistlL	SambaWhistlL	SambaWhistlL	SambaWhistlL	Bubble	Footsteps
C# 6	73	C# 4			Guiro Short	Guiro Short	Guiro Short	Guiro Short	Guiro Short	Feed	
D 6	74	D 4	○		Guiro Long	Guiro Long	Guiro Long	Guiro Long	Guiro Long		
D# 6	75	D# 4			Claves	Claves	Claves	Claves	Claves		
E 6	76	E 4			Wood Block H	Wood Block H	Wood Block H	Wood Block H	Wood Block H		
F 6	77	F 4			Wood Block L	Wood Block L	Wood Block L	Wood Block L	Wood Block L		
F# 6	78	F# 4			Cuica Mute	Cuica Mute	Cuica Mute	Cuica Mute	Cuica Mute		
G 6	79	G 4			Cuica Open	Cuica Open	Cuica Open	Cuica Open	Cuica Open		
G# 6	80	G# 4		2	TriangleMute	TriangleMute	TriangleMute	TriangleMute	TriangleMute		
A 6	81	A 4		2	TriangleOpen	TriangleOpen	TriangleOpen	TriangleOpen	TriangleOpen		
A# 6	82	A# 4			Shaker	Shaker	Shaker	Shaker	Shaker		
B 6	83	B 4			Jingle Bells	Jingle Bells	Jingle Bells	Jingle Bells	Jingle Bells		
C 7	84	C 5			Bell Tree	Bell Tree	Bell Tree	Bell Tree	Bell Tree	Dog	Machine Gun
-	85	C# 5								Horse	Laser Gun
-	86	D 5								Bird Tweet 2	Explosion
-	87	D# 5									Firework
-	88	E 5									
-	89	F 5									
-	90	F# 5								Ghost	
-	91	G 5								Maou	

- Key off : Le son produit par les touches marquées "○" cesse à l'instant où la touche est relâchée.
- Alternate Assign : Le fait de jouer un instrument appartenant à un groupe ayant un numéro arrête immédiatement le son de tout autre instrument appartenant à un groupe ayant le même numéro.

- Key Off: Las teclas marcadas con "○" dejan de sonar en el momento en que se sueltan.
- Alternate Assign: Al tocar algún instrumento con un grupo numerado detendrá inmediatamente el sonido de cualquier otro instrumento del mismo grupo con el mismo número.

Style List / Style-Verzeichnis / Liste des styles / Lista de estilos

Style Group	Style Name	Style Group	Style Name	Style Group	Style Name	Style Group	Style Name		
POP&ROCK	60'sGtrPop	SWING& JAZZ	BigBandFast1	LATIN	Brazil Samba	PIANIST	Stride1		
	60's8Beat		BigBandMed1		BossaNova		Stride2		
	8Beat1		40'sBigBand		PopBossa		PianoSwing1		
	OffBeat		BigBandFast2		BigBandMambo		PianoSwing2		
	60'sRock		BigBandMed2		BigBandSalsa		PianoSwing3		
	RockShuffle		BigBandBalad		Tijuana		PianoRag1		
	8BeatRock		BigBandShufl		DiscoLatin		PianoRag2		
	PopShuffle1		JazzClub		RockChaCha		Arpeggio1		
	PopShuffle2		Swing1		Beguine		Arpeggio2		
	GuitarPop		Swing2		Mambo		Arpeggio3		
	16BtUptempo		Five/Four		Salsa		PianoOrchBld		
	KoolShuffle		JazzPiano		GypsyRumba		Musical		
	JazzRock		Bebop		HappyReggae		Traditional1		
	POPBALLADS		8BeatModern		JazzBallad1		MARCH& WORLD	USMarch	Traditional2
			MovieBallad		GypsySwing			6/8March	Traditional3
		SecretService	ElectricJazz	GermanMarch	PianoBoogie				
		OrganBallad	Charleston	Showtune	PnoRock&Roll				
Unplugged		Dixieland	PolkaPop	SlowRock					
8BeatAdria		Ragtime	OberPolka	2BeatSwing					
PianoBallad		R&B	ScottishReel	JazzBallad2					
RomanticBld			Soul	8Beat2					
LoveSong			DetroitPop	8BeatBallad1					
6/8ModernEP			60'sRock&Rol	8BeatBallad2					
6/8SlowRock1			SwingBoogie	4Stroke					
6/8SlowRock2			Gospel Bros	Nocturne					
16Beat			6/8Soul	PianoMarch1					
PopBallad			CrocoTwist	PianoMarch2					
16BeatBalad1			Rock&Roll	6/8PnoMarch					
16BeatBalad2			SoulBeat	Waltz					
RockBallad		SoulShuffle	JazzWaltz3						
DANCE	EuroTrance	6/8Blues	WALTZ	Gtr Serenade	PianoBoss				
	Ibiza	BluesPiano		SwingWaltz	PianoSamba				
	HouseMusik	Amaz. Gospel		JazzWaltz1	PianoChaCha				
	SwingHouse	ComboBoogie		JazzWaltz2	PianoBeguine				
	Clubdance	COUNTRY		OberWalzer	PianoRumba				
	ClubLatin	Country8Beat		Musette	SlowWaltz				
	Garage	CountryPop		VienneseWltz					
	TechnoParty	CountryRock		EnglishWaltz					
	UKPop	CountrySwing		Slowfox					
	HipHopGroove	CountryWaltz		Foxtrot					
	HipHopLight	CntryBallad	Quickstep						
	HipHopPop	Cntry2/4	Tango						
	70'sDisco1	CountryBoogie	Pasodoble						
	70'sDisco2	CntryShuffle	Samba						
	LatinDisco	Hoedown	ChaChaCha						
	SaturdyNight		Rumba						
	DiscoHands		Jive						

Parameter Chart / Parameterübersicht / Tableau des paramètres / Gráfica de parámetros

Group	Contents	Default	One Touch Setting	Music Database	Set Up Memory	Registration Freeze Group	All Set Up	Backup Group	Recall Group	
VOICE	RIGHT1 VOICE	Grand Piano 1	○	○	○	VOICE SETTING	○	VOICE SETTING	VOICE SETTING	
	RIGHT1 OCTAVE SHIFT	0	○	○	○	VOICE SETTING	○	VOICE SETTING	VOICE SETTING	
	RIGHT1 PAN	Center	○	○	○	VOICE SETTING	○	VOICE SETTING	VOICE SETTING	
	RIGHT1 VOLUME	127	○	○	○	VOICE SETTING	○	VOICE SETTING	VOICE SETTING	
	Selected voice in each VOICE SELECT page	Top voice	—	—	—	—	○	VOICE SETTING	VOICE SETTING	
	HARMONY ON/OFF	OFF	○	○	○	VOICE SETTING	○	VOICE SETTING	VOICE SETTING	
	HARMONY TYPE	Depends on voice selection.	○	○	○	VOICE SETTING	○	VOICE SETTING	VOICE SETTING	
	HARMONY VOLUME	Depends on voice selection.	○	○	○	VOICE SETTING	○	VOICE SETTING	VOICE SETTING	
	HARMONY SPEED	Depends on voice selection.	○	○	○	VOICE SETTING	○	VOICE SETTING	VOICE SETTING	
	DUAL	DUAL ON/OFF	OFF	○	○	○	VOICE SETTING	○	VOICE SETTING	VOICE SETTING
	RIGHT2 VOICE	SlowStrs.	○	○	○	VOICE SETTING	○	VOICE SETTING	VOICE SETTING	
	RIGHT2 OCTAVE SHIFT	0	○	○	○	VOICE SETTING	○	VOICE SETTING	VOICE SETTING	
	DUAL DETUNE DEPTH	5	○	○	○	VOICE SETTING	○	VOICE SETTING	VOICE SETTING	
	RIGHT2 PAN	Center	○	○	○	VOICE SETTING	○	VOICE SETTING	VOICE SETTING	
	RIGHT2 VOLUME	127	○	○	○	VOICE SETTING	○	VOICE SETTING	VOICE SETTING	
SPLIT	SPLIT ON/OFF	OFF	—	○	○	VOICE SETTING	○	VOICE SETTING	VOICE SETTING	
	LEFT VOICE	Aco Bass	—	○	○	VOICE SETTING	○	VOICE SETTING	VOICE SETTING	
	LEFT OCTAVE SHIFT	+1	—	○	○	VOICE SETTING	○	VOICE SETTING	VOICE SETTING	
	SPLIT POINT	F#2	—	—	○	VOICE SETTING	○	VOICE SETTING	VOICE SETTING	
	LEFT PAN	Center	—	○	○	VOICE SETTING	○	VOICE SETTING	VOICE SETTING	
	LEFT VOLUME	127	—	○	○	VOICE SETTING	○	VOICE SETTING	VOICE SETTING	
	PEDAL RANGE	RIGHT	—	—	○	PEDAL	○	PEDAL	PEDAL	
REVERB	REVERB ON/OFF	Depends on voice selection.	○	○	○	REV/CHO/EFF	○	REV/CHO/EFF	REV/CHO/EFF	
	REVERB TYPE	Depends on style (voice) selection.	—	○	○	REV/CHO/EFF	○	REV/CHO/EFF	REV/CHO/EFF	
	REVERB TOTAL DEPTH	64	—	○	○	REV/CHO/EFF	○	REV/CHO/EFF	REV/CHO/EFF	
	REVERB PART DEPTH (RHYTHM, ACMP)	64	—	○	○	REV/CHO/EFF	○	REV/CHO/EFF	REV/CHO/EFF	
	REVERB PART DEPTH (LEFT, RIGHT1, RIGHT2)	Depends on voice selection.	○	○	○	REV/CHO/EFF	○	REV/CHO/EFF	REV/CHO/EFF	
EFFECT	EFFECT ON/OFF	Depends on voice selection.	○	○	○	REV/CHO/EFF	○	REV/CHO/EFF	REV/CHO/EFF	
	EFFECT TYPE (RIGHT1, RIGHT2, LEFT)	Depends on voice selection.	○	○	○	REV/CHO/EFF	○	REV/CHO/EFF	REV/CHO/EFF	
	EFFECT DEPTH	Depends on voice selection.	○	○	○	REV/CHO/EFF	○	REV/CHO/EFF	REV/CHO/EFF	
	EFFECT VARIATION	Depends on style selection.	○	○	○	REV/CHO/EFF	○	REV/CHO/EFF	REV/CHO/EFF	
CHORUS	CHORUS TYPE	Depends on style selection.	○	○	○	REV/CHO/EFF	○	REV/CHO/EFF	REV/CHO/EFF	
	CHORUS DEPTH (RIGHT1, RIGHT2, LEFT)	Depends on voice selection.	○	○	○	REV/CHO/EFF	○	REV/CHO/EFF	REV/CHO/EFF	
REGISTRATION	REGISTRATION FREEZE ON/OFF	OFF	—	—	—	—	—	REGISTRATION	REGISTRATION	
	FREEZE CATEGORY ON/OFF (VOICE SETTING), REVERB/EFFECT, TUNE, PEDAL, ACMP.SETTING	ACMP. SETTING: ON Others: OFF	—	—	—	—	—	REGISTRATION	REGISTRATION	
	ALL REGISTRATION Memory Data (20)	Factory preset data	—	—	—	—	○	REGISTRATION	REGISTRATION	
MIXER	MIXER PART VOLUME (RHYTHM, BASS, CHORD, PAD, PHRASE)	110	—	○	—	ACMP. SETTING	○	ACMP SETTING	ACMP SETTING	
	KEYBOARD VOLUME	127	—	○	○	VOICE SETTING	○	VOICE SETTING	VOICE SETTING	
ACCOMPANIMENT	STYLE	60'sStrPop	—	○	—	ACMP. SETTING	○	ACMP SETTING	ACMP SETTING	
	Selected style in each STYLE SELECT page	Top style	—	—	—	—	○	ACMP SETTING	ACMP SETTING	
	MAIN A/B/C/D	MAIN C	—	○	—	ACMP. SETTING	○	ACMP SETTING	ACMP SETTING	
	ACMP. ON/OFF	OFF	ON	ON	—	ACMP. SETTING	○	ACMP SETTING	ACMP SETTING	
	ACCOMPANIMENT MODE	MULTI FINGER	—	—	—	ACMP. SETTING	○	ACMP SETTING	ACMP SETTING	
	TEMPO ¹	Depends on style selection.	—	○	—	ACMP. SETTING	○	ACMP SETTING	ACMP SETTING	
	INTRO/FILL IN/ENDING	OFF	—	—	—	ACMP. SETTING	○	—	—	
METRONOME	METRONOME TYPE	NORMAL	—	—	—	—	○	ACMP SETTING	ACMP SETTING	
	METRONOME VOLUME	64	—	—	—	—	○	ACMP SETTING	ACMP SETTING	
SONG	GUIDE MODE	NORMAL	—	—	—	—	—	—	—	
	SOUND REPEAT	AUTO	—	—	—	—	○	SONG SETTING	SONG SETTING	
	PIANO ROLL DISPLAY	AUTO	—	—	—	—	○	SONG SETTING	SONG SETTING	
	GUIDE LAMP ON/OFF	ON	—	—	—	—	○	SONG SETTING	SONG SETTING	
	LYRICS ON/OFF	ON	—	—	—	—	○	SONG SETTING	SONG SETTING	
	SONG VOLUME	[ACMP/SONG VOLUME] slider value	—	—	—	—	—	SONG SETTING	—	
HELP FUNCTION	LANGUAGE	ENGLISH	—	—	—	—	○	Always backed up.	—	
	TUNE	440.0Hz (A3)	—	—	—	—	○	TUNE	TUNE	
	TRANPOSE (ALL)	0	—	—	—	VOICE SETTING	○	VOICE SETTING	VOICE SETTING	
	TRANPOSE (SONG)	0	—	—	—	—	○	VOICE SETTING	VOICE SETTING	
	VOICE SETTING	AUTO	—	—	—	—	○	VOICE SETTING	VOICE SETTING	
	KEY TOUCH	NORMAL	—	—	—	VOICE SETTING	○	VOICE SETTING	VOICE SETTING	
	FIXED VELOCITY	76	—	—	—	VOICE SETTING	○	VOICE SETTING	VOICE SETTING	
	LEFT PEDAL FUNCTION	SOFT	—	○	○	PEDAL	○	PEDAL	PEDAL	
	LEFT PART MIDI SEND Ch.	3	—	—	—	—	○	MIDI SETTING	MIDI SETTING	
	RIGHT 1 PART MIDI SEND Ch.	1	—	—	—	—	○	MIDI SETTING	MIDI SETTING	
	RIGHT 2 PART MIDI SEND Ch.	2	—	—	—	—	○	MIDI SETTING	MIDI SETTING	
	LOCAL CONTROL ON/OFF	ON	—	—	—	—	○	MIDI SETTING	MIDI SETTING	
	SYNC. CLOCK	INT.	—	—	—	—	○	MIDI SETTING	MIDI SETTING	
	PROGRAM CHANGE SEND/RECEIVE ON/OFF	TX&RX (ON)	—	—	—	—	○	MIDI SETTING	MIDI SETTING	
	CONTROL CHANGE SEND/RECEIVE ON/OFF	TX&RX (ON)	—	—	—	—	○	MIDI SETTING	MIDI SETTING	
	SYSTEM EXCLUSIVE SEND/RECEIVE ON/OFF	TX&RX (ON)	—	—	—	—	○	MIDI SETTING	MIDI SETTING	
	START/STOP SEND/RECEIVE ON/OFF	OFF	—	—	—	—	○	MIDI SETTING	MIDI SETTING	
	MIDI FILTER ON/OFF (all channels)	ON	—	—	—	—	○	MIDI SETTING	MIDI SETTING	
	MIDI TRANPOSE RECEIVE ON/OFF	ON	—	—	—	—	○	MIDI SETTING	MIDI SETTING	
	ACMP & RHY SEND ON/OFF	OFF	—	—	—	—	○	MIDI SETTING	MIDI SETTING	
	HARMONY SEND ON/OFF	OFF	—	—	—	—	○	MIDI SETTING	MIDI SETTING	
	SEQUENCER SEND ON/OFF	OFF	—	—	—	—	○	MIDI SETTING	MIDI SETTING	
	REMOTE KEYBOARD	OFF	—	—	—	—	○	MIDI SETTING	MIDI SETTING	
	MICRO TUNING ON/OFF	OFF	—	—	—	—	○	TUNE	TUNE	
	MICRO TUNE. SETTING	0	—	—	—	—	○	TUNE	TUNE	
	SCALE TUNING SELECT	PRESET	—	—	—	TUNE	○	TUNE	TUNE	
	PRESET SCALE SELECT	EQUAL	—	—	—	TUNE	○	TUNE	TUNE	
	PRESET SCALE KEY	C	—	—	—	TUNE	○	TUNE	TUNE	
	USER SCALE SETTING	0	—	—	—	TUNE	○	TUNE	TUNE	
	BACKUP ON/OFF	Set separately for each group. ²	—	—	—	—	—	—	Always backed up.	—

1 When a Music Database setup or registration is recalled during Auto Accompaniment playback, the style thereby selected will begin playing immediately if it is the same as the style that is currently playing, or from the top of the next measure if it is a different style.

2 REGISTRATION: ON; Others: OFF

1 Bei Wiederaufruf eines Musikdatenbank-Setup oder einer Registrierung während des Auto Accompaniment-Backup (Backup von Autom. Begleitung) wird der dabei gewählte Style sofort abgespielt, sofern dieser derselbe ist wie der aktuell abgespielte Style, oder ab der obersten Stelle des nächsten Taktes, falls es sich um einen anderen Style handelt.

2 REGISTRATION: ON; Andere: OFF

1 Si une configuration de Music Database ou une registration est rappelée au cours de l'accompagnement automatique, le style ainsi sélectionné sera joué immédiatement s'il est identique au style en cours de lecture, ou au début de la mesure suivante s'il s'agit d'un style différent.

2 REGISTRATION : ON ; Autres : OFF

1 Cuando un registro o los ajustes Music Database están llamados durante una reproducción Auto Accompaniment, el estilo seleccionado reproducirá inmediatamente si es el mismo que el estilo que se está reproduciendo o desde el principio del compás siguiente si es un estilo diferente.

2 REGISTRATION: ON; Otros: OFF

Fingering Chart / Akkordliste / Tablature / Gráfica de digitado















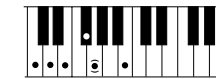



















* All fingerings shown are simple root-position types.

* Die hier gezeigten Akkorde sind jeweils die Grundakkorde.

* Tous les doigts indiqués sont du type à position fondamentale simple.

* Todos los digitados se muestran como tipos de posición de raíz sencilla.

Example for "C" chords Beispiele für "C"-Akkorde Exemples d'accords en "C" Ejemplo de acordes "C"

C	C6	CM7	CM7 (b5)	CM7 (#11)
				
Cadd9	CM7(9)	C6(9)	C(b5)	Caug
				
C7(#5)	CM7(#5)	Cm	Cm6	Cm7
				
Cm7(b5)	Cmadd9	Cm7(9)	Cm7(11)	CmM7(b5)
				
CmM7	CmM7(9)	Cm(b5)	Cdim7	C7
				
C7sus4	C7(9)	C7(#11)	C7(13)	C7(b5)
				
C7(b9)	C7(b13)	C7(#9)	Csus4	
				

MIDI Data Format / MIDI-Datenformat / Format des données MIDI / Formato de datos MIDI.....

Many MIDI messages listed in the MIDI Data Format are expressed in decimal numbers, binary numbers and hexadecimal numbers. Hexadecimal numbers may include the letter "H" as a suffix. Also, "n" can freely be defined as any whole number.

To enter data/values, refer to the table below.

Decimal	Hexadecimal	Binary
0	00	0000 0000
1	01	0000 0001
2	02	0000 0010
3	03	0000 0011
4	04	0000 0100
5	05	0000 0101
6	06	0000 0110
7	07	0000 0111
8	08	0000 1000
9	09	0000 1001
10	0A	0000 1010
11	0B	0000 1011
12	0C	0000 1100
13	0D	0000 1101
14	0E	0000 1110
15	0F	0000 1111
16	10	0001 0000
17	11	0001 0001
18	12	0001 0010
19	13	0001 0011
20	14	0001 0100
21	15	0001 0101
22	16	0001 0110
23	17	0001 0111
24	18	0001 1000
25	19	0001 1001
26	1A	0001 1010
27	1B	0001 1011
28	1C	0001 1100
29	1D	0001 1101
30	1E	0001 1110
31	1F	0001 1111
32	20	0010 0000
33	21	0010 0001
34	22	0010 0010
35	23	0010 0011
36	24	0010 0100
37	25	0010 0101
38	26	0010 0110
39	27	0010 0111
40	28	0010 1000
41	29	0010 1001
42	2A	0010 1010
43	2B	0010 1011
44	2C	0010 1100
45	2D	0010 1101
46	2E	0010 1110
47	2F	0010 1111
48	30	0011 0000
49	31	0011 0001
50	32	0011 0010
51	33	0011 0011
52	34	0011 0100
53	35	0011 0101
54	36	0011 0110
55	37	0011 0111
56	38	0011 1000
57	39	0011 1001
58	3A	0011 1010
59	3B	0011 1011
60	3C	0011 1100
61	3D	0011 1101
62	3E	0011 1110
63	3F	0011 1111

- Except the table above, for example 144-159(decimal)/9nH/1001 0000-1001 1111(binary) displays the Note On Message for each channel (1-16). 176-191/BnH/1011 0000-1011 1111 displays the Control Change Message for each channel (1-16). 192-207/CnH/1100 0000-1100 1111 displays the Program Change Message for each channel (1-16). 240/F0H/1111 0000 denotes the start of a System Exclusive Message. 247/F7H/1111 0111 denotes the end of a System Exclusive Message.
- aaH (hexidecimal)/0aaaaaaa (binary) denotes the data address. The address contains High, Mid, and Low.
- bbH/0bbbbbbb denotes the byte count.
- ccH/0ccccccc denotes the check sum.
- ddH/0ddddddd denotes the data/value.

(1) TRANSMIT FLOW

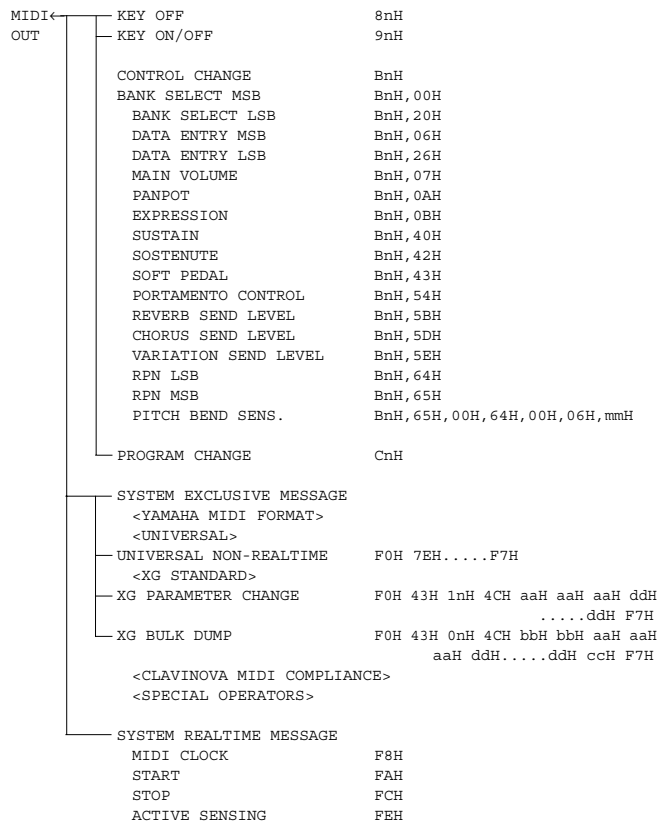

(2) RECEIVE FLOW

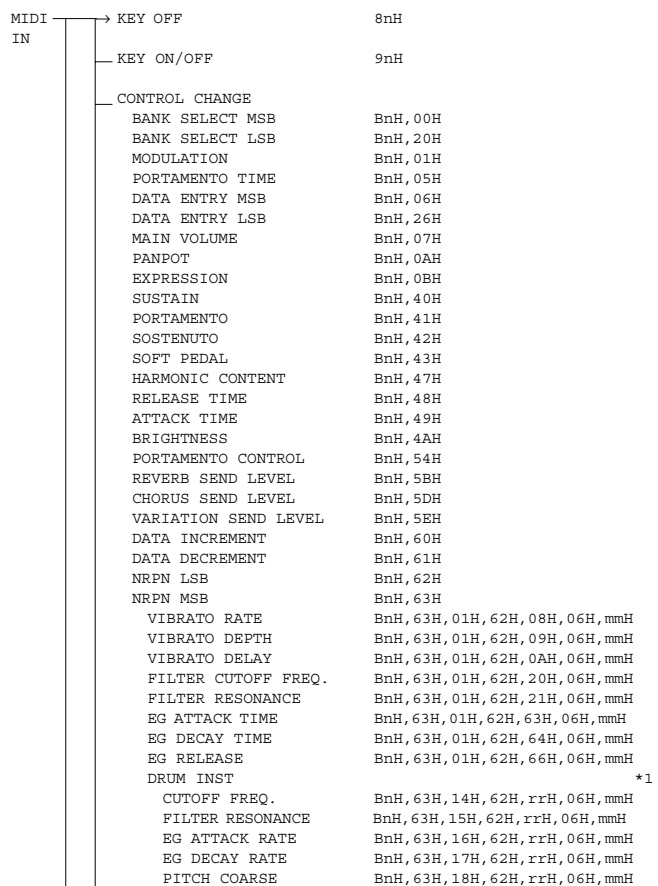

PITCH FINE	BnH, 63H, 19H, 62H, rrH, 06H, mmH
LEVEL	BnH, 63H, 1AH, 62H, rrH, 06H, mmH
PANPOT	BnH, 63H, 1CH, 62H, rrH, 06H, mmH
REVERB SEND	BnH, 63H, 1DH, 62H, rrH, 06H, mmH
CHORUS SEND	BnH, 63H, 1EH, 62H, rrH, 06H, mmH
VARIATION SEND	BnH, 63H, 1FH, 62H, rrH, 06H, mmH
RPN LSB	BnH, 64H
RPN MSB	BnH, 65H
PITCH BEND SENS.	BnH, 65H, 00H, 64H, 00H, 06H, mmH
FINE TUNING	BnH, 65H, 00H, 64H, 01H, 06H, mmH, 26H, 11H
COARSE TUNING	BnH, 65H, 00H, 64H, 02H, 06H, mmH
NULL	BnH, 65H, 7FH, 64H, 7FH
ALL SOUND OFF	BnH, 78H, 00H
RESET ALL CONTROLLERS	BnH, 79H, 00H
LOCAL CONTROL	BnH, 7AH
ALL NOTES OFF	BnH, 7BH, 00H
OMNI OFF	BnH, 7CH, 00H
OMNI ON	BnH, 7DH, 00H
MONO	BnH, 7EH
POLY	BnH, 7FH
PROGRAM CHANGE	CnH
CHANNEL AFTER TOUCH	DnH
PITCH BEND CHANGE	EnH
SYSTEM EXCLUSIVE MESSAGE	
<YAMAHA MIDI FORMAT>	
<UNIVERSAL>	
UNIVERSAL REALTIME	F0H 7FH....F7H
UNIVERSAL NON-REALTIME	F0H 7EH....F7H
<XG STANDARD>	
XG PARAMETER CHANGE	F0H 43H 1nH 4CH aaH aaH aaH ddHddH F7H
XG BULK DUMP	F0H 43H 0nH 4CH bbH bbH aaH aaH aaH ddH....ddH ccH F7H
PARAMETER REQUEST	F0H 43H 3nH 4CH aaH aaH aaH F7H
DUMP REQUEST	F0H 43H 2nH 4CH aaH aaH aaH F7H
<CLAVINOVA MIDI COMPLIANCE>	
<SPETIAL OPERATORS>	
<Others>	
SYSTEM REALTIME MESSAGE	
MIDI CLOCK	F8H
START	FAH
STOP	FCH
ACTIVE SENSING	FEH

When DRUM VOICE is selected and program change data for a different DRUM VOICE is received, the currently selected Drum Setup data will be replaced with the new DRUM VOICE DATA.

(3-1-4) CHANNEL AFTER TOUCH (Receive only)

STATUS	1101nnnn (DnH)	n = 0 - 15 VOICE CHANNEL NUMBER
VALUE	0vvvvvvvv	v = 0 - 127 AFTER TOUCH VALUE

(3-1-5) PITCH BEND CHANGE

STATUS	1110nnnn (EnH)	n = 0 - 15 VOICE CHANNEL NUMBER
LSB	0vvvvvvvv	PITCH BEND CHANGE LSB
MSB	0vvvvvvvv	PITCH BEND CHANGE MSB

(3-1-6) CONTROL CHANGE

STATUS	1011nnnn (BnH)	n = 0 - 15 VOICE CHANNEL NUMBER
CONTROL NUMBER	0ccccccc	
CONTROL VALUE	0vvvvvvvv	

* Transmit CONTROL NUMBER.

c = 0	BANK SELECT MSB	; v = 0: XG NORMAL, 64: SFX NORMAL, 126: XG SFX KIT, 127: XG DRUM
c = 32	BANK SELECT LSB	; v = 0 - 127
c = 6	DATA ENTRY MSB	; v = 0 - 127 *1
c = 38	DATA ENTRY LSB	; v = 0 - 127 *1
c = 7	MAIN VOLUME	; v = 0 - 127
c = 10	PANPOT	; v = 0 - 127
c = 11	EXPRESSION	; v = 0 - 127
c = 64	SUSTAIN	; v = 0-63: OFF, 64-127: ON *2
c = 66	SOSTENUTO	; v = 0-63: OFF, 64-127: ON *2
c = 67	SOFT PEDAL	; v = 0-63: OFF, 64-127: ON *2
c = 84	PORTAMENTO CONTROL	; v = 0 - 127
c = 91	REVERB SEND LEVEL	; v = 0 - 127
c = 93	CHORUS SEND LEVEL	; v = 0 - 127
c = 94	VARIATION SEND LEVEL	; v = 0 - 127
		(When only Connection = 1[System])
c = 100	RPN LSB	; v = 0 - 127
c = 101	RPN MSB	; v = 0 - 127

* Receive CONTROL NUMBER.

c = 0	BANK SELECT MSB	; v = 0: XG NORMAL, 64: SFX NORMAL, 126: XG SFX KIT, 127: XG DRUM
c = 32	BANK SELECT LSB	; v = 0 - 127
c = 1	MODULATION	; v = 0 - 127 *2
c = 5	PORTAMENTO TIME	; v = 0 - 127 *2
c = 6	DATA ENTRY MSB	; v = 0 - 127 *1
c = 38	DATA ENTRY LSB	; v = 0 - 127 *1
c = 7	MAIN VOLUME	; v = 0 - 127
c = 10	PANPOT	; v = 0 - 127
c = 11	EXPRESSION	; v = 0 - 127
c = 64	SUSTAIN	; v = 0-63: OFF, 64-127: ON *2
c = 65	PORTAMENTO	; v = 0-63: OFF, 64-127: ON *2
c = 66	SOSTENUTO	; v = 0-63: OFF, 64-127: ON *2
c = 67	SOFT PEDAL	; v = 0-63: OFF, 64-127: ON *2
c = 71	HARMONIC CONTENT	; v = 0:-64 - 64:0 - 127:+63 *2
c = 72	RELEASE TIME	; v = 0:-64 - 64:0 - 127:+63 *2
c = 73	ATTACK TIME	; v = 0:-64 - 64:0 - 127:+63 *2
c = 74	BRIGHTNESS	; v = 0:-64 - 64:0 - 127:+63 *2
c = 84	PORTAMENTO CONTROL	; v = 0 - 127 *2
c = 91	REVERB SEND LEVEL	; v = 0 - 127
c = 93	CHORUS SEND LEVEL	; v = 0 - 127
c = 94	VARIATION SEND LEVEL	; v = 0 - 127
		(When only Connection = 1[System])
c = 96	DATA INCREMENT	; v = 0 - 127 *1
c = 97	DATA DECREMENT	; v = 0 - 127 *1
	RPN MSB/LSB, NRPN MSB/LSB	

*1 Only when setting the appointed parameter with RPN, NRPN.

*2 Does not effect Rhythm Voice.

• Until a PROGRAM CHANGE message is received, the BANK SELECT operation will be suspended. When a Voice, including VOICE BANK, is changed, set the BANK SELECT and Program Change Message, and transmit in the following order, BANK SELECT MSB, LSB, PROGRAM CHANGE.

• MODULATION controls the Vibrato Depth.

• PORTAMENTO TIME controls the Pitch Change Speed when the Portamento Switch = ON. 0 being the shortest time, and 127 being the longest.

• PANPOT changes the value for the melody voice and rhythm voice in relation to the preset value.

(3) TRANSMIT/RECEIVE DATA

(3-1) CHANNEL VOICE MESSAGES

(3-1-1) KEY OFF

STATUS	1000nnnn (8nH)	n = 0 - 15 VOICE CHANNEL NUMBER
NOTE NUMBER	0kkkkkkk	k = 0 (C-2) - 127 (G8)
VELOCITY	0vvvvvvvv	v: ignored

(3-1-2) KEY ON/OFF

STATUS	1001nnnn (9nH)	n = 0 - 15 VOICE CHANNEL NUMBER
NOTE NUMBER	0kkkkkkk	k = 0 (C-2) - 127 (G8)
VELOCITY	0vvvvvvvv	(v ≠ 0) NOTE ON
	00000000	(v = 0) NOTE OFF

(3-1-3) PROGRAM CHANGE

STATUS	1100nnnn (CnH)	n = 0 - 15 VOICE CHANNEL NUMBER
PROGRAM NUMBER	0pppppppp	p = 0 - 127

* PROGRAM NUMBER: XG DRUM VOICE number correspondence

P = 0	Standard Kit
P = 1	Standard2 Kit
P = 8	Room Kit
P = 16	Rock Kit
P = 24	Electro Kit
P = 25	Analog Kit
P = 27	Dance Kit
P = 32	Jazz Kit
P = 40	Brush Kit
P = 48	Classic Kit

* PROGRAM NUMBER: XG SFX KIT number correspondence

P = 0	SFX1 Kit
P = 1	SFX2 Kit

- Portamento time is fixed to 0 when the PORTAMENTO CONTROL is used.
- HARMONIC CONTENT applies adjustment to the resonance value that is set by the voice. This parameter specifies relative change with the value of 64 producing 0 adjustment. As values get higher the sound becomes increasingly eccentric. Note that for some voices the effective parameter range is narrower than the legal parameter range.
- RELEASE TIME applies adjustment to the envelope release time set by the voice. This parameter specifies relative change with the value of 64 producing 0 adjustment.
- ATTACK TIME applies adjustment to the envelope attack time set by the voice. This parameter specifies relative change with the value of 64 producing 0 adjustment.
- BRIGHTNESS applies adjustment to the cut-off frequency set by the voice. This parameter specifies relative change with the value of 64 producing 0 adjustment. Lower voices produce a softer sound. For some voices the effective parameter range is narrower than the legal parameter range.

(3-2) CHANNEL MODE MESSAGES

STATUS 1011nnnn (BnH) n = 0 - 15 VOICE CHANNEL NUMBER
 CONTROL NUMBER 0ccccccc c = CONTROL NUMBER
 CONTROL VALUE 0vvvvvvv v = DATA VALUE

(3-2-1) ALL SOUND OFF (Receive only)

(CONTROL NUMBER = 78H, DATA VALUE = 0)

Switches off all sound from the channel. Reset Note On and Hold On conditions established by Channel Messages.

(3-2-2) RESET ALL CONTROLLERS (Receive only)

(CONTROL NUMBER = 79H, DATA VALUE = 0)

Resets controllers as follows.

PITCH BEND CHANGE 0 (Center)
 AFTER TOUCH 0 (min.)
 MODULATION 0 (min.)
 EXPRESSION 127 (max.)
 SUSTAIN 0 (off)
 SOSTENUTO 0 (off)
 SOFT PEDAL 0 (off)
 NRPN Sets number to null. (Internal data remains unchanged)
 RPN Sets number to null. (Internal data remains unchanged)
 PORTAMENTO CONTROL Resets portamento source note number
 PORTAMENTO 0 (off)

(3-2-3) LOCAL CONTROL (Receive only)

(CONTROL NUMBER = 7AH, DATA VALUE = 0/7FH)

When the DATA VALUE = 7FH, LOCAL ON is activated where playing the keys on the keyboard will produce sound.
 When the DATA VALUE = 0, LOCAL OFF is activated where playing the keys on the keyboard will not produce any sound.

(3-2-4) ALL NOTES OFF (Receive only)

(CONTROL NUMBER = 7BH, DATA VALUE = 0)

Switches off all of the channel's "on" notes. However, any notes being held by SUSTAIN or SOSTENUTO continue to sound until SUSTAIN/SOSTENUTO goes off.

(3-2-5) OMNI OFF (Receive only) (CONTROL NUMBER = 7CH, DATA VALUE = 0)

Same processing as for All Notes Off.

(3-2-6) OMNI ON (Receive only) (CONTROL NUMBER = 7DH, DATA VALUE = 0)

Same processing as for All Notes Off. Omni On is not executed.

(3-2-7) MONO (Receive only) (CONTROL NUMBER = 7EH, DATA VALUE = 0)

Same processing as for All Notes Off. If the 3rd byte is in a range of 0-16 the corresponding channel will be changed to Mode 4 (m=1).

(3-2-8) POLY (Receive only) (CONTROL NUMBER = 7FH, DATA VALUE = 0)

Same processing as for All Sounds Off and the corresponding channel will be changed to Mode 3.

(3-3) REGISTERED PARAMETER NUMBER(RPN)

STATUS 1011nnnn (BnH) n = 0 - 15 VOICE CHANNEL NUMBER
 RPN LSB 01100100 (64H)
 RPN LSB NUMBER 0ppppppp p = RPN LSB (refer to the list below)
 RPN MSB 01100101 (65H)
 RPN MSB NUMBER 0qqqqqqq q = RPN MSB (refer to the list below)
 DATA ENTRY MSB 00000110 (06H)
 DATA VALUE 0mmmmmmm m = Data Value
 DATA ENTRY LSB 00100110 (26H)
 DATA VALUE 01111111 l = Data Value

First appoints the parameter for RPN MSB/LSB, then sets the parameter value for data entry MSB/LSB.

RPN	D. ENTRY	PARAMETER NAME	DATA RANGE
00H 00H	mmH -	PITCH BEND SENSITIVITY	00H - 18H (0 - 24 semitones)
01H 00H	mmH 11H	FINE TUNE	{mmH, 11H} = {00H, 00H} - {40H, 00H} - {7FH, 7FH} (-8192*100/8192) - 0 - (+8192*100/8192)
02H 00H	mmH -	COARSE TUNE	28H - 40H - 58H (-24 - 0 - +24 semitones)
7FH 7FH	- -	NULL	Clears the current RPN number setting. Does not change the internal parameter settings.

(3-4) NON-REGISTERED PARAMETER NUMBER(NRPN) (Receive only)

STATUS 1011nnnn (BnH) n = 0 - 15 VOICE CHANNEL NUMBER
 NRPN LSB 01100010 (62H)
 NRPN LSB NUMBER 0ppppppp p = NRPN LSB (refer to the list below)
 NRPN MSB 01100011 (63H)
 NRPN MSB NUMBER 0qqqqqqq q = NRPN MSB (refer to the list below)
 DATA ENTRY MSB 00000110 (06H)
 DATA VALUE 0mmmmmmm m = Data Value

First appoints the parameter for NRPN MSB/LSB, then sets the parameter value for data entry MSB/LSB.

NRPN	D. ENTRY	PARAMETER NAME	DATA RANGE
01H 08H	mmH -	VIBRATO RATE	00H - 40H - 7FH (-64 - 0 - +63)
01H 09H	mmH -	VIBRATO DEPTH	00H - 40H - 7FH (-64 - 0 - +63)
01H 0AH	mmH -	VIBRATO DELAY	00H - 40H - 7FH (-64 - 0 - +63)
01H 20H	mmH -	FILTER CUTOFF FREQUENCY	00H - 40H - 7FH (-64 - 0 - +63)
01H 21H	mmH -	FILTER RESONANCE	00H - 40H - 7FH (-64 - 0 - +63)
01H 63H	mmH -	EG ATTACK TIME	00H - 40H - 7FH (-64 - 0 - +63)
01H 64H	mmH -	EG DECAY TIME	00H - 40H - 7FH (-64 - 0 - +63)
01H 66H	mmH -	EG RELEASE	00H - 40H - 7FH (-64 - 0 - +63)
14H rrH	mmH -	DRUM FILTER CUTOFF FREQ.	00H - 40H - 7FH (-64 - 0 - +63)
15H rrH	mmH -	DRUM FILTER RESONANCE	00H - 40H - 7FH (-64 - 0 - +63)
16H rrH	mmH -	DRUM AEG ATTACK RATE	00H - 40H - 7FH (-64 - 0 - +63)
17H rrH	mmH -	DRUM AEG DECAY RATE	00H - 40H - 7FH (-64 - 0 - +63)
18H rrH	mmH -	DRUM PITCH COARSE	00H - 40H - 7FH (-64 - 0 - +63)
19H rrH	mmH -	DRUM PITCH FINE	00H - 40H - 7FH (-64 - 0 - +63)
1AH rrH	mmH -	DRUM LEVEL	00H - 7FH (0 - max.)
1CH rrH	mmH -	DRUM PANPOT	00H, 01H - 40H - 7FH (random, left - center - right)
1DH rrH	mmH -	DRUM REVERB SEND LEVEL	00H - 7FH (0 - max.)
1EH rrH	mmH -	DRUM CHORUS SEND LEVEL	00H - 7FH (0 - max.)
1FH rrH	mmH -	DRUM VARIATION SEND LEVEL	00H - 7FH (0 - max.)

The MSB 14H-1FH (for drums) message is received when multi-part parameters PART MODE = DRUMS1...2.
 rrH : drum instrument note number

(3-5) SYSTEM REALTIME MESSAGES

(3-5-1) MIDI CLOCK

STATUS 11111000 (F8H)

Transmission: 96 clocks per measure are transmitted.

Reception: If the instrument's clock is set to external, after FAH is received from the external device the instrument's clock will sync with the 96 beats per measure received from the external device.

Decides whether the internal clock, or Timing Clocks received via the MIDI IN will be used.

(3-5-2) START

STATUS 11111010 (FAH)

Transmission: Transmitted when instrument's Rhythm or Song playback is started.

Reception: Depending upon the condition, Rhythm, Song Playback, or Song Rec will start.

(3-5-3) STOP

STATUS 11111100 (FCH)

Transmission: Transmitted when instrument's Rhythm or Song playback is stopped.

Reception: Depending upon the condition, Rhythm, Song Playback, or Song Rec will stop.

(3-5-4) ACTIVE SENSING

STATUS 11111110 (FEH)

Transmission: Transmitted approximately once every 200msec.

Reception: Sensing is started once this Code is received. If Status or Data is not received within 400ms, the MIDI Receive Buffer will be cleared, and all notes, including those being sustained, will be cut OFF. Also, all control values will be reset to their factory defaults.

(3-6) SYSTEM EXCLUSIVE MESSAGE

(3-6-1) YAMAHA MIDI FORMAT

(3-6-1-1) SECTION CONTROL

binary	hexadecimal	Exclusive status
11110000	F0	Exclusive status
01000011	43	YAMAHA ID
01111110	7E	Style
00000000	00	
0sssssss	SS	Switch No.
	00H	: INTRO A
	01H	: INTRO B
	02H	: INTRO C/D
	03H-07H	: INTRO C/D
	08H	: MAIN A
	09H	: MAIN B
	0AH	: MAIN C
	0BH-0FH	: MAIN D
	10H	: FILL IN A
	11H	: FILL IN B
	12H	: FILL IN C
	13H-17H	: FILL IN D
	18H	: BREAK FILL
	19H	: BREAK FILL
	1AH	: BREAK FILL
	1BH-1FH	: BREAK FILL
	20H	: ENDING A
	21H	: ENDING B
	22H	: ENDING C/D
	23H-27H	: ENDING C/D
0ddddd	DD	Switch On/Off: 00H (Off), 7FH (On)
11110111	F7	End of Exclusive

When an ON code is received, the appointed section will be changed.

(3-6-1-2) TEMPO CONTROL

binary	hexadecimal	Exclusive status
11110000	F0	Exclusive status
01000011	43	YAMAHA ID
01111110	7E	Style
00000000	01	
0ttttttt	TT	Tempo4
0ttttttt	TT	Tempo3
0ttttttt	TT	Tempo2
0ttttttt	TT	Tempo1
11110111	F7	End of Exclusive

The internal clock will be set to the received Tempo value.

Tempo Meta Event is a large data block (24-bit), it is divided into 4 groups with 7-bits going into each of the Tempos 1-4 (4 receives the remaining 3 bits).

(3-6-1-3) CHORD CONTROL type1

binary	hexadecimal	Exclusive status
11110000	F0	Exclusive status
01000011	43	YAMAHA ID
01111110	7E	Style
00000010	02	type 1
0ddddd	dd	chord root (cr)
0ddddd	dd	chord type (ct)
0ddddd	dd	bass note (bn)
0ddddd	dd	bass type (bt)
11111110	F7	End of Exclusive

Chord transmit: Transmitted using type 1 format.

cr	Chord Root	0kkknenn	(kkk:Change symbol, nenn:Note)
Binary	Hex	Change symbol	Binary Hex Note
0000nnnn	0n	bbb (3 flats)	0kkk0000 k0 reserved
0001nnnn	1n	bb (2 flats)	0kkk0001 k1 C
0010nnnn	2n	b (1 flat)	0kkk0010 k2 D
0011nnnn	3n	natural	0kkk0011 k3 E
0100nnnn	4n	# (1 sharp)	0kkk0100 k4 F
0101nnnn	5n	## (2 sharps)	0kkk0101 k5 G
0110nnnn	6n	### (3 sharps)	0kkk0110 k6 A
			0kkk0111 k7 B

ct	Chord Type	0 - 34,127	
Binary	Hex	Dec	Chord type
00000000	00	0	Maj
00000001	01	1	Maj6
00000010	02	2	Maj7
00000011	03	3	Maj7 (#11)
00000100	04	4	Maj (9)
00000101	05	5	Maj7 (9)
00000110	06	6	Maj6 (9)
00000111	07	7	aug
00001000	08	8	min
00001001	09	9	min6
00001010	0A	10	min7
00001011	0B	11	min7b5
00001100	0C	12	min (9)
00001101	0D	13	min7 (9)
00001110	0E	14	min7 (11)
00001111	0F	15	minMaj7
00010000	10	16	minMaj7 (9)
00010001	11	17	dim
bn	On Bass Note	Same as Chord root, 127:No bass chord	
bt	Bass Chord	Same as Chord type 127:No bass chord	

(3-6-2) UNIVERSAL SYSTEM EXCLUSIVE

(3-6-2-1) UNIVERSAL REALTIME MESSAGE

(3-6-2-1-1) MIDI MASTER VOLUME (Receive only)

binary	hexadecimal	Exclusive status
11110000	F0	Exclusive status
01111110	7F	Universal Realtime
01111111	7F	ID of target Device
00001001	04	Sub-ID #1=Device Control Message
00000001	01	Sub-ID #2=Master Volume
0sssssss	SS	Volume LSB
0ttttttt	TT	Volume MSB
11110111	F7	End of Exclusive
or		
11110000	F0	Exclusive status
01111110	7F	Universal Realtime
0xxxxnnn	XN	When N is received N=0-F, whichever is received. When N is transmitted N always=0. X = don't care
00001001	04	Sub-ID #1=Device Control Message
00000001	01	Sub-ID #2=Master Volume
0sssssss	SS	Volume LSB
0ttttttt	TT	Volume MSB
11110111	F7	End of Exclusive

The volume for all channels will be changed simultaneously. The TT value is used as the MIDI Master Volume value. (the SS value is ignored.)

(3-6-2-2) UNIVERSAL NON REALTIME MESSAGE

(3-6-2-2-1) GENERAL MIDI SYSTEM ON

binary	hexadecimal	
11110000	F0	Exclusive status
01111110	7E	Universal Non-Realtime
01111111	7F	ID of target Device
00001001	09	Sub-ID #1=General MIDI Message
00000001	01	Sub-ID #2=General MIDI On
11110111	F7	End of Exclusive
or		
11110000	F0	Exclusive status
01111110	7E	Universal Non-Realtime
0xxxnnnn	XN	When N is received N=0-F, whichever is received. When N is transmitted N always=0. X = don't care
00001001	09	Sub-ID #1=General MIDI Message
00000001	01	Sub-ID #2=General MIDI On
11110111	F7	End of Exclusive

Depending upon the received ON message, the System Mode will be changed to XG.
Except MIDI Master Tuning, all control data be reset to default values.
This message requires approximately 50ms to execute, so sufficient time should be allowed before the next message is sent.

After the GM System ON message is received, message reception of the following will be limited.

- Bank Select MSB-LSB in channel 10 will be ignored and the drum voice will be fixed.
- Bank Select MSB-LSB except in channel 10 will be ignored except 127/0.
- NRPN is not received.

When XG SYSTEM ON is received, these restrictions will be cancelled.

(3-6-3) XG STANDARD

(3-6-3-1) XG PARAMETER CHANGE

(3-6-3-1-1) XG SYSTEM ON

binary	hexadecimal	
11110000	F0	Exclusive status
01000011	43	YAMAHA ID
0001nnnn	1N	Device Number
01001100	4C	Model ID
00000000	00	Address High
00000000	00	Address Mid
01111110	7E	Address Low
00000000	00	Data
11110111	F7	End of Exclusive

Depending upon the received ON message, the SYSTEM MODE will be changed to XG. Controllers will be reset, all values of Multi Part and Effect, and All System values denoted by "XG" data within All System will be reset to default values in the table.
This message requires approximately 50ms to execute, so sufficient time should be allowed before the next message is sent.

(3-6-3-1-2) XG PARAMETER CHANGE

binary	hexadecimal	
11110000	F0	Exclusive status
01000011	43	YAMAHA ID
0001nnnn	1N	Device Number
01001100	4C	Model ID
0aaaaaaaa	AA	Address High
0aaaaaaaa	AA	Address Mid
0aaaaaaaa	AA	Address Low
0ddddddd	DD	Data
11110111	F7	End of Exclusive

For parameters with data size of 2 or 4, transmit the appropriate number of data bytes.
For more information on Address and Parameters, refer to < Table 1-2 > (page 20) and < Table 1-4 > ~ < Table 1-6 > (pages 20-23).

The following Parameter Changes are handled.

XG System Data
Multi Effect 1 Data
Multi Part Data
Drums Setup Data

(3-6-3-2) XG BULK DUMP

binary	hexadecimal	
11110000	F0	Exclusive status
01000011	43	YAMAHA ID
0000nnnn	0N	Device Number
01001100	4C	Model ID
0bbbbbbb	BB	ByteCount
0bbbbbbb	BB	ByteCount
0aaaaaaaa	AA	Address High
0aaaaaaaa	AA	Address Mid
0aaaaaaaa	AA	Address Low
0ddddddd	DD	Data
0ccccccc	CC	Check sum
11110111	F7	End of Exclusive

For more information on Address and Byte Count, refer to < Table 1-2 > ~ < Table 1-6 > (pages 20-23).

The Check Sum value is set such that the sum of Byte Count, Address, Data, and Check Sum has value zero in its seven least significant bits.

If the top of the block is appointed to the Address the XG Bulk Dump, Bulk Request will be received.

The Block is a unit that consists of the data, arranged in the list, as the Total Size.

The following Bulk Dumps are handled.

XG System Data
Multi Effect 1 Data (Individual effect unit)
Multi Part Data (Individual part unit)
Drums Setup Data (Individual note unit)
System Information (Transmit only)

(3-6-3-3) XG PARAMETER REQUEST (Receive only)

binary	hexadecimal	
11110000	F0	Exclusive status
01000011	43	YAMAHA ID
0011nnnn	3n	Device Number
01001100	4C	Model ID
0aaaaaaaa	AA	Address High
0aaaaaaaa	AA	Address Mid
0aaaaaaaa	AA	Address Low
11110111	F7	End of Exclusive

For more information on Address and Byte Count refer to < Table 1-2 > (page 20) and < Table 1-4 > ~ < Table 1-6 > (pages 20-23).

The following Parameter Requests are handled.

XG System Data
Multi Effect 1 Data
Multi Part Data
Drums Setup Data

(3-6-3-4) XG DUMP REQUEST (Receive only)

binary	hexadecimal	
11110000	F0	Exclusive status
01000011	43	YAMAHA ID
0010nnnn	2n	Device Number
01001100	4C	Model ID
0aaaaaaaa	AA	Address High
0aaaaaaaa	AA	Address Mid
0aaaaaaaa	AA	Address Low
11110111	F7	End of Exclusive

For more information on Address and Byte Count refer to < Table 1-2 > ~ < Table 1-6 > (pages 20-23).

The following Dump Requests are handled.

XG System Data
Multi Effect 1 Data (Individual module unit)
Multi Part Data (Individual part unit)
Drums Setup Data (Individual note unit)
System Information

(3-6-4) CLAVINOVA MIDI COMPLIANCE

(3-6-4-1) INTERNAL CLOCK / EXTERNAL CLOCK (Receive only)

binary	hexadecimal	
11110000	F0	Exclusive status
01000011	43	YAMAHA ID
01110011	73	Clavinova ID
00000001	01	Clavinova common ID
0000001n	0N	N: 2 (Internal Clock), 3 (External Clock)
11110111	F7	End of Exclusive

(3-6-4-2) DOC MULTI TIMBRE ON / OFF (Receive only)

binary	hexadecimal	
11110000	F0	Exclusive status
01000011	43	YAMAHA ID
01110011	73	Clavinova ID
00000001	01	Clavinova common ID
00000110	1N	N:3 (DOC Multi Timbre Off), 4 (DOC Multi Timbre On)
11110111	F7	End of Exclusive

(3-6-4-3) PANEL LED ON / OFF (Receive only)

binary	hexadecimal	
11110000	F0	Exclusive status
01000011	43	YAMAHA ID
01110011	73	Clavinova ID
00000001	01	Clavinova common ID
00011010	1A	PANEL LED On/Off
0mmmmmm	MM	MM: 00H (LED Off), 01H (LED On), 02H (The LED flashes) 03H (LED All off), 04H (Panel LED returns to normal operation)
00000000	00	
0nnnnnnn	NN	LED No.
11110111	F7	End of Exclusive

Remotely switches the Panel LED On/Off.

(3-6-4-4) PANEL VOICE SETTING (Receive only)

binary	hexadecimal	
11110000	F0	Exclusive status
01000011	43	YAMAHA ID
01110011	73	Clavinova ID
01000101	01	Clavinova common ID
00100010	22	Piano Live Exclusive Substatus
00000000	00	Panel Voice Setting Substatus
0000nnnn	0n	Panel Part No. 00H (RIGHT 1) 01H (RIGHT 2) 02H (LEFT)
0mmmmmm	mm	Bank Select MSB Bank Select LSB
01111111	11	Bank Select LSB
0ppppppp	pp	Program Change
11110111	F7	End of Exclusive

(3-6-4-5) PANEL VOICE VOLUME SETTING (Receive only)

binary	hexadecimal	
11110000	F0	Exclusive status
01000011	43	YAMAHA ID
01110011	73	Clavinova ID
01000101	01	Clavinova common ID
00100010	22	Piano Live Exclusive Substatus
00000001	01	Panel Voice Volume Setting Substatus
0000nnnn	0n	Panel Part No. 00H (RIGHT 1) 01H (RIGHT 2) 02H (LEFT)
0vvvvvvv	vv	Value (0 - 7FH)
11110111	F7	End of Exclusive

(3-6-4-6) PANEL VOICE REVERB DEPTH SETTING (Receive only)

binary	hexadecimal	
11110000	F0	Exclusive status
01000011	43	YAMAHA ID
01110011	73	Clavinova ID
01000101	01	Clavinova common ID
00100010	22	Piano Live Exclusive Substatus
00000010	02	Panel Voice Reverb Depth Setting Substatus
0000nnnn	0n	Panel Part No. 00H (RIGHT 1) 01H (RIGHT 2) 02H (LEFT)
0vvvvvvv	vv	Value (0 - 7FH)
11110111	F7	End of Exclusive

(3-6-4-7) PANEL VOICE EFFECT DEPTH SETTING (Receive only)

binary	hexadecimal	
11110000	F0	Exclusive status
01000011	43	YAMAHA ID
01110011	73	Clavinova ID
01000101	01	Clavinova common ID
00100010	22	Piano Live Exclusive Substatus
00000011	03	Panel Voice Effect Depth Setting Substatus
0000nnnn	0n	Panel Part No. 00H (RIGHT 1) 01H (RIGHT 2) 02H (LEFT)
0vvvvvvv	vv	Value (0 - 7FH)
11110111	F7	End of Exclusive

(3-6-4-8) MIDI FA CANCEL (Receive only)

binary	hexadecimal	
11110000	F0	Exclusive status
01000011	43	YAMAHA ID
01110011	73	Clavinova ID
01000101	01	Clavinova common ID
01100001	61	MIDI FA Cancel
11110111	F7	End of Exclusive

If this message is received, even if FAH is received the Rhythm will not start.

(3-6-5) SPECIAL OPERATORS

(3-6-5-1) SPLIT POINT

binary	hexadecimal	
11110000	F0	Exclusive status
01000011	43	YAMAHA ID
01110011	73	Clavinova ID
01000101	01	Clavinova common ID
00010001	11	Sub ID
00000000	00	
00010100	14	Split Point
0ddddd	DD	Split Key No.
11110111	F7	End of Exclusive

(3-6-5-2) STYLE NUMBER

binary	hexadecimal	
11110000	F0	Exclusive status
01000011	43	YAMAHA ID
01110011	73	Clavinova ID
01011010	35	CVP-202 ID
00010001	11	Sub ID
00000000	00	Channel No. (always 00)
00010110	16	Style No. Control No.
0mmmmmm	mm	Style No. MSB
01111111	11	Style No. LSB
11110111	F7	End of Exclusive

(3-6-5-3) FINGERING

binary	hexadecimal	
11110000	F0	Exclusive status
01000011	43	YAMAHA ID
01110011	73	Clavinova ID
01000101	01	Clavinova common ID
00010001	11	Sub ID
00000000	00	
01000000	40	Fingering
0000dddd	0D	0D: 00H (Off), 01H (Single Finger), 02H (Fingered 1), 03H (Fingered 2), 04H (Full Keyboard), 07H (Multi Finger)
11110111	F7	End of Exclusive

(3-6-5-4) ACCOMP VOLUME

binary	hexadecimal	
11110000	F0	Exclusive status
01000011	43	YAMAHA ID
01110011	73	Clavinova ID
01000101	01	Clavinova common ID
00010001	11	Sub ID
0000nnnn	0N	Part: 00H (All Part), 05H (Rhythm), 0AH (Bass), 06H (Chord), 0DH (Pad), 07H (Phrase)
01000000	42	Accomp Volume
0ddddd	DD	Volume Data: 00H-7FH
11110111	F7	End of Exclusive

(3-6-5-5) CHANNEL DETUNE

binary	hexadecimal	
11110000	F0	Exclusive status
01000011	43	YAMAHA ID
01110011	73	Clavinova ID
01000101	01	Clavinova common ID
00010001	11	Sub ID
0000nnnn	0N	N = MIDI Channel
01000011	43	Dual Detune
0vvvvvvv	VV	Value VV: 00H - 40H - 7FH (-64 - 0 - +63)
11110111	F7	End of Exclusive

The Channel Detune message only affects the specified channel.

(3-6-5-6) VOLUME ,EXPRESSION AND PAN REALTIME CONTROL OFF

binary	hexadecimal	
11110000	F0	Exclusive status
01000011	43	YAMAHA ID
01110011	73	Clavinova ID
01000101	01	Clavinova common ID
00010001	11	Sub ID
0000nnnn	0N	N = MIDI Channel
01001001	45	Volume and Expression Realtime Control Off
0vvvvvvv	VV	Value VV: off=7FH, on=00H
11110111	F7	End of Exclusive

When "On" is received, subsequent volume, expression, and PAN changes are only valid after the reception of the next key on. Normal operation resumes when "Off" is received.

(3-6-5-7) MIDI KEY LED MODE ON / OFF (Receive only)

binary	hexadecimal	
11110000	F0	Exclusive status
01000011	43	YAMAHA ID
01110011	73	Clavinova ID
01000101	01	Clavinova common ID
00010001	11	Sub ID
0000nnnn	0N	N = MIDI Channel
01000111	47	MIDI Key LED Mode On / Off
0ddddd	DD	DD: 00H(Key LED Mode Off), 01H(Key LED Mode On + no tone), 02H(Key LED Mode On + tone)
11110111	F7	End of Exclusive

(3-6-6) Others

(3-6-6-1) MIDI MASTER TUNING (Receive only)

binary	hexadecimal	
11110000	F0	Exclusive status
01000011	43	YAMAHA ID
0001nnnn	1N	When N is received N=0-F, whichever is received.
00100111	27	Model ID
00110000	30	Sub ID
00000000	00	
00000000	00	
0mmmmmm	MM	Master Tune MSB
01111111	LL	Master Tune LSB
0ccccccc	CC	don't care
11110111	F7	End of Exclusive

Changes tuning of all channels.

MM, LL values are used to define the MIDI Master Tuning value.

$T = M - 128$

T: Tuning value (-99 cents to +99 cents)

M: A single byte value (28-228) that consists of bits 0-3 of MM as MSB, bits 0-3 of LL as LSB.

This setting is not reset when the GM System or XG System is turned on.

MIDI Data Format / MIDI-Datenformat / Format des données MIDI / Formato de datos MIDI ●●●

< Table 1-1 >

Parameter	Basic Address	Parameter Change Address	Description
SYSTEM		(H) (M) (L) 00 00 00	System
		00 00 7D	Drum Setup Reset
		00 00 7E	XG System On
		00 00 7F	All Parameter Reset
INFORMATION		01 00 00	System Information
EFFECT 1		02 01 00	Effect1 (Reverb, Chorus, Variation)
MULTI PART		08 00 00	Multi Part 1
		08 0F 00	Multi Part 16
DRUM		30 0D 00	Drum Setup 1
		31 0D 00	Drum Setup 2
		3n 0D 00	note number 13
		3n 0E 00	note number 14
		:	:
		3n 5B 00	note number 91

< Table 1-2 >

MIDI Parameter Change table (SYSTEM)

Address (H)	Size (H)	Data (H)	Parameter Name	Description	Default Value (H)
00 00 00	4	0000	Master Tune	-102.4...+102.3 [cent]	00 04 00 00
01		..07FF		1st bit3-0 -> bit15-12	(0400)
02				2nd bit3-0 -> bit11-8	
03				3rd bit3-0 -> bit7-4	
04	1	00..7F	Master Volume	0..127	7F
05	1		Not Used		
06	1	28..58	Transpose	-24...+24 [semitones]	40
7D	n		Drum Setup Reset	n=Drum Setup Number	
7E	00		XG System On	00=XG Sytem on	
7F	00		All Parameter Reset	00=on (receive only)	
TOTAL SIZE	6				

< Table 1-3 >

MIDI Parameter table (System information)

Address (H)	Size (H)	Data (H)	Parameter Name	Description
01 00 00	E	20..7F	Model Name	32...127 (ASCII)
:				
0D				
0E	1	00		
0F	1	01		
TOTAL SIZE	10			

(Transmitted by Dump Request. Not received. Bulk Dump Only)

< Table 1-4 >

MIDI Parameter Change table (EFFECT 1)

Address (H)	Size (H)	Data (H)	Parameter Name	Description	Default Value (H)
02 01 00	2	00..7F	Reverb Type MSB	Refer to the Effect Type List	01 (=HALL1)
		00..7F	Reverb Type LSB	00 : basic type	00
02	1	00..7F	Reverb Parameter 1	Refer to the Ef. Parameter List	Depend on Reverb type
03	1	00..7F	Reverb Parameter 2	Refer to the Ef. Parameter List	Depend on Reverb type
04	1	00..7F	Reverb Parameter 3	Refer to the Ef. Parameter List	Depend on Reverb type
05	1	00..7F	Reverb Parameter 4	Refer to the Ef. Parameter List	Depend on Reverb type
06	1	00..7F	Reverb Parameter 5	Refer to the Ef. Parameter List	Depend on Reverb type
07	1	00..7F	Reverb Parameter 6	Refer to the Ef. Parameter List	Depend on Reverb type
08	1	00..7F	Reverb Parameter 7	Refer to the Ef. Parameter List	Depend on Reverb type
09	1	00..7F	Reverb Parameter 8	Refer to the Ef. Parameter List	Depend on Reverb type
0A	1	00..7F	Reverb Parameter 9	Refer to the Ef. Parameter List	Depend on Reverb type
0B	1	00..7F	Reverb Parameter 10	Refer to the Ef. Parameter List	Depend on Reverb type
0C	1	00..7F	Reverb Return	-∞..0...+6dB (0..96...127)	40
0D	1	01..7F	Reverb Pan	L63..C..R63 (1..64...127)	40
TOTAL SIZE	0E				

02	01	10	1	00..7F	Reverb Parameter 11	Refer to the Ef. Parameter List	Depend on Reverb type
		11	1	00..7F	Reverb Parameter 12	Refer to the Ef. Parameter List	Depend on Reverb type
		12	1	00..7F	Reverb Parameter 13	Refer to the Ef. Parameter List	Depend on Reverb type
		13	1	00..7F	Reverb Parameter 14	Refer to the Ef. Parameter List	Depend on Reverb type
		14	1	00..7F	Reverb Parameter 15	Refer to the Ef. Parameter List	Depend on Reverb type
		15	1	00..7F	Reverb Parameter 16	Refer to the Ef. Parameter List	Depend on Reverb type

TOTAL SIZE 6

02	01	20	2	00..7F	Chorus Type MSB	Refer to the Effect Type List	41(=Chorus1)
				00..7F	Chorus Type LSB	00 : basic type	00
		22	1	00..7F	Chorus Parameter 1	Refer to the Ef. Parameter List	Depend on Chorus Type
		23	1	00..7F	Chorus Parameter 2	Refer to the Ef. Parameter List	Depend on Chorus Type
		24	1	00..7F	Chorus Parameter 3	Refer to the Ef. Parameter List	Depend on Chorus Type
		25	1	00..7F	Chorus Parameter 4	Refer to the Ef. Parameter List	Depend on Chorus Type
		26	1	00..7F	Chorus Parameter 5	Refer to the Ef. Parameter List	Depend on Chorus Type
		27	1	00..7F	Chorus Parameter 6	Refer to the Ef. Parameter List	Depend on Chorus Type
		28	1	00..7F	Chorus Parameter 7	Refer to the Ef. Parameter List	Depend on Chorus Type
		29	1	00..7F	Chorus Parameter 8	Refer to the Ef. Parameter List	Depend on Chorus Type
		2A	1	00..7F	Chorus Parameter 9	Refer to the Ef. Parameter List	Depend on Chorus Type
		2B	1	00..7F	Chorus Parameter 10	Refer to the Ef. Parameter List	Depend on Chorus Type
		2C	1	00..7F	Chorus Return	-∞..0..+6dB(0..96..127)	40
		2D	1	01..7F	Chorus Pan	L63..C..R63(1..64..127)	40
		2E	1	00..7F	Send Chorus To Reverb	-∞..0..+6dB(0..96..127)	00

TOTAL SIZE 0F

02	01	30	1	00..7F	Chorus Parameter 11	Refer to the Ef. Parameter List	Depend on Chorus Type
		31	1	00..7F	Chorus Parameter 12	Refer to the Ef. Parameter List	Depend on Chorus Type
		32	1	00..7F	Chorus Parameter 13	Refer to the Ef. Parameter List	Depend on Chorus Type
		33	1	00..7F	Chorus Parameter 14	Refer to the Ef. Parameter List	Depend on Chorus Type
		34	1	00..7F	Chorus Parameter 15	Refer to the Ef. Parameter List	Depend on Chorus Type
		35	1	00..7F	Chorus Parameter 16	Refer to the Ef. Parameter List	Depend on Chorus Type

TOTAL SIZE 6

02	01	40	2	00..7F	Variation Type MSB	Refer to the Effect Type List	"05(=DELAY L,C,R)"
				00..7F	Variation Type LSB	00 : basic type	00
		42	2	00..7F	Vari. Param. 1 MSB	Refer to the Ef. Parameter List	Depend on Vari. Type
				00..7F	Vari. Param. 1 LSB	Refer to the Ef. Parameter List	Depend on Vari. Type
		44	2	00..7F	Vari. Param. 2 MSB	Refer to the Ef. Parameter List	Depend on Vari. Type
				00..7F	Vari. Param. 2 LSB	Refer to the Ef. Parameter List	Depend on Vari. Type
		46	2	00..7F	Vari. Param. 3 MSB	Refer to the Ef. Parameter List	Depend on Vari. Type
				00..7F	Vari. Param. 3 LSB	Refer to the Ef. Parameter List	Depend on Vari. Type
		48	2	00..7F	Vari. Param. 4 MSB	Refer to the Ef. Parameter List	Depend on Vari. Type
				00..7F	Vari. Param. 4 LSB	Refer to the Ef. Parameter List	Depend on Vari. Type
		4A	2	00..7F	Vari. Param. 5 MSB	Refer to the Ef. Parameter List	Depend on Vari. Type
				00..7F	Vari. Param. 5 LSB	Refer to the Ef. Parameter List	Depend on Vari. Type
		4C	2	00..7F	Vari. Param. 6 MSB	Refer to the Ef. Parameter List	Depend on Vari. Type
				00..7F	Vari. Param. 6 LSB	Refer to the Ef. Parameter List	Depend on Vari. Type
		4E	2	00..7F	Vari. Param. 7 MSB	Refer to the Ef. Parameter List	Depend on Vari. Type
				00..7F	Vari. Param. 7 LSB	Refer to the Ef. Parameter List	Depend on Vari. Type
		50	2	00..7F	Vari. Param. 8 MSB	Refer to the Ef. Parameter List	Depend on Vari. Type
				00..7F	Vari. Param. 8 LSB	Refer to the Ef. Parameter List	Depend on Vari. Type
		52	2	00..7F	Vari. Param. 9 MSB	Refer to the Ef. Parameter List	Depend on Vari. Type
				00..7F	Vari. Param. 9 LSB	Refer to the Ef. Parameter List	Depend on Vari. Type
		54	2	00..7F	Vari. Param. 10 MSB	Refer to the Ef. Parameter List	Depend on Vari. Type
				00..7F	Vari. Param. 10 LSB	Refer to the Ef. Parameter List	Depend on Vari. Type
		56	1	00..7F	Variation Return	-∞..0..+6dB(0..96..127)	40
		57	1	01..7F	Variation Pan	L63..C..R63(1..64..127)	40
		58	1	00..7F	Send Vari. To Reverb	-∞..0..+6dB(0..96..127)	00
		59	1	00..7F	Send Vari. To Chorus	-∞..0..+6dB(0..96..127)	00
		5A	1	00..01	Variation Connection	0:insertion,1:system	00
		5B	1	00..1F	Variation Part	part1..32(0..31),off(127)	7F
		5C	1	01..7F	MW Vari. Ctrl Depth	-63..+63	40
		5D	1	01..7F	PB Vari. Ctrl Depth	-63..+63	40
		5E	1	01..7F	CAT Vari. Ctrl Depth	-63..+63	40
		5F	1	01..7F	Not Used		
		60	1	01..7F	Not Used		

TOTAL SIZE 21

02	01	70	1	00..7F	Variation Parameter 11	option Parameter	Depend on Variation Type
		71	1	00..7F	Variation Parameter 12	option Parameter	Depend on Variation Type
		72	1	00..7F	Variation Parameter 13	option Parameter	Depend on Variation Type
		73	1	00..7F	Variation Parameter 14	option Parameter	Depend on Variation Type
		74	1	00..7F	Variation Parameter 15	option Parameter	Depend on Variation Type
		75	1	00..7F	Variation Parameter 16	option Parameter	Depend on Variation Type

TOTAL SIZE 6

MIDI Data Format / MIDI-Datenformat / Format des données MIDI / Formato de datos MIDI ●●●

< Table 1-5 >

MIDI Parameter Change table (MULTI PART)

Address (H)	Size (H)	Data (H)	Parameter Name	Description	Default Value (H)		
08	nn	00	1	00..20	Element Reserve	0..32	0 (Part10), 2 (Others)
	nn	01	1	00..7F	Bank Select MSB	0..127	7F (Part10), 00 (Others)
	nn	02	1	00..7F	Bank Select LSB	0..127	00
	nn	03	1	00..7F	Program Number	1..128	00
	nn	04	1	00..0F, 7F	Rcv Channel	0..16; 1..16, 127; off	Part No.
	nn	05	1	00..01	Mono/Poly Mode	0:mono, 1:poly	01
	nn	06	1	00..02	Same Note Number Key On Assign	0:single 1:multi 2:inst (for DRUM)	01
	nn	07	1	00..02	Part Mode	0:normal 1..3:drum thru, drum1..2	00 (Except Part10) 02 (Part10)
	nn	08	1	28..58	Note Shift	-24..+24 [semitones]	40
	nn	09	2	00..FF	Detune	-12.8..+12.7 [Hz]	08 00
	nn	0A				1st bit3..0 -> bit7..4 2nd bit3..0 -> bit3..0	(80)
	nn	0B	1	00..7F	Volume	0..127	64
	nn	0C	1	00..7F	Velocity Sense Depth	0..127	40
	nn	0D	1	00..7F	Velocity Sense Offset	0..127	40
	nn	0E	1	00..7F	Pan	0:random L63..C..R63 (1..64..127)	40
	nn	0F	1	00..7F	Note Limit Low	C-2..G8	00
	nn	10	1	00..7F	Note Limit High	C-2..G8	7F
	nn	11	1	00..7F	Dry Level	0..127	7F
	nn	12	1	00..7F	Chorus Send	0..127	00
	nn	13	1	00..7F	Reverb Send	0..127	28
	nn	14	1	00..7F	Variation Send	0..127	00
	nn	15	1	00..7F	Vibrato Rate	-64..+63	40
	nn	16	1	00..7F	Vibrato Depth	-64..+63	40
	nn	17	1	00..7F	Vibrato Delay	-64..+63	40
	nn	18	1	00..7F	Filter Cutoff Freq.	-64..+63	40
	nn	19	1	00..7F	Filter Resonance	-64..+63	40
	nn	1A	1	00..7F	EG Attack Time	-64..+63	40
	nn	1B	1	00..7F	EG Decay Time	-64..+63	40
	nn	1C	1	00..7F	EG Release Time	-64..+63	40
	nn	1D	1	28..58	MW Pitch Control	-24..+24 [semitones]	40
	nn	1E	1	00..7F	MW Filter Control	-9600..+9450 [cent]	40
	nn	1F	1	00..7F	MW Amp. Control	-100..+100 [%]	40
	nn	20	1	00..7F	MW LFO PMod Depth	0..127	0A
	nn	21	1	00..7F	MW LFO FMod Depth	0..127	00
	nn	22	1	00..7F	MW LFO AMod Depth	0..127	00
	nn	23	1	28..58	Bend Pitch Control	-24..+24 [semitones]	42
	nn	24	1	00..7F	Bend Filter Control	-9600..+9450 [cent]	40
	nn	25	1	00..7F	Bend Amp. Control	-100..+100 [%]	40
	nn	26	1	00..7F	Bend LFO PMod Depth	0..127	00
	nn	27	1	00..7F	Bend LFO FMod Depth	0..127	00
	nn	28	1	00..7F	Bend LFO AMod Depth	0..127	00
TOTAL SIZE			29				
	nn	30	1		Not Used		
	:	:		:			
	nn	40	1		Not Used		
	nn	41	1	00..7F	Scale Tuning C	-64..+63 [cent]	40
	nn	42	1	00..7F	Scale Tuning C#	-64..+63 [cent]	40
	nn	43	1	00..7F	Scale Tuning D	-64..+63 [cent]	40
	nn	44	1	00..7F	Scale Tuning D#	-64..+63 [cent]	40
	nn	45	1	00..7F	Scale Tuning E	-64..+63 [cent]	40
	nn	46	1	00..7F	Scale Tuning F	-64..+63 [cent]	40
	nn	47	1	00..7F	Scale Tuning F#	-64..+63 [cent]	40
	nn	48	1	00..7F	Scale Tuning G	-64..+63 [cent]	40
	nn	49	1	00..7F	Scale Tuning G#	-64..+63 [cent]	40
	nn	4A	1	00..7F	Scale Tuning A	-64..+63 [cent]	40
	nn	4B	1	00..7F	Scale Tuning A#	-64..+63 [cent]	40
	nn	4C	1	00..7F	Scale Tuning B	-64..+63 [cent]	40
	nn	4D	1	28..58	CAT Pitch Control	-24..+24 [semitones]	40
	nn	4E	1	00..7F	CAT Filter Control	-9600..+9450 [cent]	40
	nn	4F	1	00..7F	CAT Amplitude Control	-100..+100 [%]	40
	nn	50	1	00..7F	CAT LFO PMod Depth	0..127	00

nn	51	1	00..7F	CAT LFO FMod Depth	0..127	00
nn	52	1	00..7F	CAT LFO AMod Depth	0..127	00
nn	53			Not Used		
:				:		
	66			Not Used		
nn	67	1	00..01	Portamento Switch	off/on	00
nn	68	1	00..7F	Portamento Time	0..127	00
nn	69			Not Used		
:				:		
	6E			Not Used		
TOTAL SIZE		3F				
08	nn	70	1	Not Used	Don't care	
	nn	71	1	Not Used	Don't care	
	nn	72	1	Not Used	Don't care	
	nn	73	1	Not Used	Don't care	
TOTAL SIZE		04				
08	nn	74	1	Not Used	Don't care	
		75	1	Not Used	Don't care	
		76	1	Not Used	Don't care	
		77	1	Not Used	Don't care	
		78	1	Not Used	Don't care	
		79	1	Not Used	Don't care	
		7A	1	Not Used	Don't care	
		7B	1	Not Used	Don't care	
		7C	1	Not Used	Don't care	
		7D	1	Not Used	Don't care	
		7E	1	Not Used	Don't care	
		7F	1	Not Used	Don't care	
TOTAL SIZE		0C				

nn = PartNumber

If there is a Drum Voice assigned to the Part, the following parameters are ineffective.

- Bank Select LSB
- Pitch EG
- Portamento
- Soft Pedal
- Mono/Poly
- Scale Tuning

<Table 1-6 >

MIDI Parameter Change table (DRUM SETUP)

Address (H)	Size (H)	Data (H)	Parameter Name (H)	Description	Default Value (H)		
3n	rr	00	1	00..7F	Pitch Coarse	-64..+63	40
3n	rr	01	1	00..7F	Pitch Fine	-64..+63 [cent]	40
3n	rr	02	1	00..7F	Level	0..127	Depend on the Note
3n	rr	03	1	00..7F	Alternate Group	0:off,1..127	Depend on the Note
3n	rr	04	1	00..7F	Pan	0:random L63..C..R63 (1..64..127)	Depend on the Note
3n	rr	05	1	00..7F	Reverb Send Level	0..127	Depend on the Note
3n	rr	06	1	00..7F	Chorus Send Level	0..127	Depend on the Note
3n	rr	07	1	00..7F	Variation Send Level	0..127	7F
3n	rr	08	1	00..01	Key Assign	0:single,1:multi	00
3n	rr	09	1	00..01	Rcv Note Off	off/on	Depend on the Note
3n	rr	0A	1	00..01	Rcv Note On	off/on	01
3n	rr	0B	1	00..7F	Filter Cutoff Freq.	-64..63	40
3n	rr	0C	1	00..7F	Filter Resonance	-64..63	40
3n	rr	0D	1	00..7F	EG Attack Rate	-64..63	40
3n	rr	0E	1	00..7F	EG Decay1 Rate	-64..63	40
3n	rr	0F	1	00..7F	EG Decay2 Rate	-64..63	40
TOTAL SIZE		10					

n:Drum Setup Number(0 - 1)

rr:note number(0DH - 5BH)

If XG SYSTEM ON and/or GM SYSTEM ON message is received, all Drum Setup Parameter will be reset to default values.

According to the Drum Setup Reset message, individual Drum Setup Parameters can be reset to default values.

Effect Type List / Liste der Effekttypen / Liste des types d'effet / Lista de tipos de efecto

Reverb Type List

Type	MSB #	LSB #
HALL1	1	0
HALL2	1	16
HALL3	1	17
HALL4	1	18
HALL5	1	1
ROOM1	2	16
ROOM2	2	17
ROOM3	2	18
ROOM4	2	19
ROOM5	2	0
ROOM6	2	1
ROOM7	2	2
STAGE1	3	16
STAGE2	3	17
STAGE3	3	0
STAGE4	3	1
PLATE1	4	16
PLATE2	4	17
PLATE3	4	0
WHITE ROOM	16	0
TUNNEL	17	0
CANYON	18	0
BASEMENT	19	0

Chorus Type List

Type	MSB #	LSB #
CHORUS1	66	17
CHORUS2	66	8
CHORUS3	66	16
CHORUS4	66	1
CHORUS5	65	2
CHORUS6	65	0
CHORUS7	65	1
CHORUS8	65	8
CELESTE1	66	0
CELESTE2	66	2
FLANGER1	67	8
FLANGER2	67	16
FLANGER3	67	17
FLANGER4	67	1
FLANGER5	67	0

Effect Type List

Type	MSB #	LSB #
HALL1	1	0
HALL2	1	16
HALL3	1	17
HALL4	1	18
HALL5	1	1
ROOM1	2	16
ROOM2	2	17
ROOM3	2	18
ROOM4	2	19
ROOM5	2	0
ROOM6	2	1
ROOM7	2	2
STAGE1	3	16
STAGE2	3	17
STAGE3	3	0
STAGE4	3	1
PLATE1	4	16
PLATE2	4	17
PLATE3	4	0
ER1	9	0
ER2	9	1
GATE REVERB	10	0
REVERS GATE	11	0
KARAOKE1	20	0
KARAOKE2	20	1
KARAOKE3	20	2
CHORUS1	66	17
CHORUS2	66	8
CHORUS3	66	16
CHORUS4	66	1
CHORUS5	65	2
CHORUS6	65	0
CHORUS7	65	1
CHORUS8	65	8
CELESTE1	66	0
CELESTE2	66	2
FLANGER1	67	8
FLANGER2	67	16
FLANGER3	67	17
FLANGER4	67	1
FLANGER5	67	0
SYMPHONIC1	68	16
SYMPHONIC2	68	0
PHASER1	72	0
PHASER2	72	8
EP PHASER1	72	17
EP PHASER2	72	16

Type	MSB #	LSB #
ROTARY SP1	69	16
ROTARY SP2	71	17
ROTARY SP3	71	18
ROTARY SP4	70	17
ROTARY SP5	66	18
ROTARY SP6	69	0
ROTARY SP7	71	22
ROTARY SP8	69	17
ROTARY SP9	66	19
ROTARY SP10	71	25
TREMOLO1	70	16
TREMOLO2	71	19
TREMOLO3	70	0
TREMOLO4	70	20
GT TREMOLO1	71	20
EP TREMOLO	70	18
EP TREMOLO2	70	21
AUTO PAN1	71	16
AUTO PAN2	71	0
AUTO PAN3	71	23
EP AUTOPAN	71	21
EP AUTOPAN2	71	24
AUTO WAH1	78	16
AUTO WAH2	78	0
AUTO WAH3	78	19
AUTO WAH4	78	20
DELAY LCR1	5	16
DELAY LCR2	5	0
DELAY LR	6	0
ECHO	7	0
CROSS DELAY	8	0
DIST HARD (DISTORTION HARD)	75	16
DIST HARD2	75	22
DIST HARD3	75	25
DIST SOFT (DISTORTION SOFT)	75	17
DIST SOFT2	75	23
DIST HEAVY	73	0
OVERDRIVE	74	0
AMP SIM (AMP SIMULATOR)	75	0
ST AMP2	75	21
ST AMP3	75	24
EQ DISCO	76	16
EQ TEL	76	17
2BAND EQ	77	0
3BAND EQ	76	0

Effect Parameter List / Liste der Effektparameter / Liste des paramètres d'effets / Lista de parámetros de efectos •••

If a table has no LSB number specified, the table applies for any LSB numbers.

Parameters marked with a ● in the Control column can be controlled from an AC1 (assignable controller 1) etc. However, this is valid only for a Variation effect (when selected for Insertion).

MSB = 1

MSB = 2

MSB = 3

MSB = 4

No.	Parameter	Display	Value	See Table	Control
1	Reverb Time	0.3 – 30.0s	0 – 69	table#4	
2	Diffusion	0 – 10	0 – 10		
3	Initial Delay	0.1mS – 99.3mS	0 – 63	table#5	
4	HPF Cutoff	Thru – 8.0kHz	0 – 52	table#3	
5	LPF Cutoff	1.0k – Thru	34 – 60	table#3	
6					
7					
8					
9					
10	Dry/Wet Balance	D63>W – D=W – D<W63	1 – 127		●
11	Rev Delay	0.1mS – 99.3mS	0 – 63	table#5	
12	Density	0 – 4 (rev, var)	0 – 4		
13	Er/Rev Balance	E63>R – E=R – E<R63	1 – 127		
14					
15	Feedback Level	-63 – +63	1 – 127		
16					

MSB = 5

No.	Parameter	Display	Value	See Table	Control
1	Lch Delay	0.1 – 715.0ms	1 – 7150		
2	Rch Delay	0.1 – 715.0ms	1 – 7150		
3	Cch Delay	0.1 – 715.0ms	1 – 7150		
4	Feedback Delay	0.1 – 715.0ms	1 – 7150		
5	Feedback Level	-63 – +63	1 – 127		
6	Cch Level	0 – 127	0 – 127		
7	High Damp	0.1 – 1.0	1 – 10		
8					
9					
10	Dry/Wet Balance	D63>W – D=W – D<W63	1 – 127		●
11					
12					
13	EQ Low Frequency	32Hz – 2.0kHz	4 – 40	table#3	
14	EQ Low Gain	-12 – +12dB	52 – 76		
15	EQ High Frequency	500Hz – 16.0kHz	28 – 58	table#3	
16	EQ High Gain	-12 – +12dB	52 – 76		

MSB = 6

No.	Parameter	Display	Value	See Table	Control
1	Lch Delay	0.1 – 715.0ms	1 – 7150		
2	Rch Delay	0.1 – 715.0ms	1 – 7150		
3	Feedback Delay 1	0.1 – 715.0ms	1 – 7150		
4	Feedback Delay 2	0.1 – 715.0ms	1 – 7150		
5	Feedback Level	-63 – +63	1 – 127		
6	High Damp	0.1 – 1.0	1 – 10		
7					
8					
9					
10	Dry/Wet Balance	D63>W – D=W – D<W63	1 – 127		●
11					
12					
13	EQ Low Frequency	32Hz – 2.0kHz	4 – 40	table#3	
14	EQ Low Gain	-12 – +12dB	52 – 76		
15	EQ High Frequency	500Hz – 16.0kHz	28 – 58	table#3	
16	EQ High Gain	-12 – +12dB	52 – 76		

MSB = 7

No.	Parameter	Display	Value	See Table	Control
1	Lch Delay1	0.1 – 355.0ms	1 – 3550		
2	Lch Feedback Level	-63 – +63	1 – 127		
3	Rch Delay1	0.1 – 355.0ms	1 – 3550		
4	Rch Feedback Level	-63 – +63	1 – 127		
5	High Damp	0.1 – 1.0	1 – 10		
6	Lch Delay2	0.1 – 355.0ms	1 – 3550		
7	Rch Delay2	0.1 – 355.0ms	1 – 3550		
8	Delay2 Level	0 – 127	0 – 127		
9					
10	Dry/Wet Balance	D63>W – D=W – D<W63	1 – 127		●
11					
12					
13	EQ Low Frequency	32Hz – 2.0kHz	4 – 40	table#3	
14	EQ Low Gain	-12 – +12dB	52 – 76		
15	EQ High Frequency	500Hz – 16.0kHz	28 – 58	table#3	
16	EQ High Gain	-12 – +12dB	52 – 76		

MSB = 8

No.	Parameter	Display	Value	See Table	Control
1	L→R Delay	0.1 – 355.0ms	1 – 3550		
2	R→L Delay	0.1 – 355.0ms	1 – 3550		
3	Feedback Level	-63 – +63	1 – 127		
4	Input Select	L, R, L&R	0 – 2		
5	High Damp	0.1 – 1.0	1 – 10		
6					
7					
8					
9					
10	Dry/Wet Balance	D63>W – D=W – D<W63	1 – 127		●
11					
12					
13	EQ Low Frequency	32Hz – 2.0kHz	4 – 40	table#3	
14	EQ Low Gain	-12 – +12dB	52 – 76		
15	EQ High Frequency	500Hz – 16.0kHz	28 – 58	table#3	
16	EQ High Gain	-12 – +12dB	52 – 76		

MSB = 9

No.	Parameter	Display	Value	See Table	Control
1	Type	S-H, L-H, Rdm, Rvs, Ptt, Spr	0 – 5		
2	Room Size	0.1 – 7.0	0 – 44	table#6	
3	Diffusion	0 – 10	0 – 10		
4	Initial Delay	0.1mS – 200.0mS	0 – 127	table#5	
5	Feedback Level	-63 – +63	1 – 127		
6	HPF Cutoff	Thru – 8.0kHz	0 – 52	table#3	
7	LPF Cutoff	1.0k – Thru	34 – 60	table#3	
8					
9					
10	Dry/Wet Balance	D63>W – D=W – D<W63	1 – 127		●
11	Liveness	0 – 10	0 – 10		
12	Density	0 – 3	0 – 3		
13	High Damp	0.1 – 1.0	1 – 10		
14					
15					
16					

Effect Parameter List / Liste der Effektparameter / Liste des paramètres d'effets /

MSB = 10
MSB = 11

No.	Parameter	Display	Value	See Table	Control
1	Type	TypeA, TypeB	0 – 1		
2	Room Size	0.1 – 7.0	0 – 44	table#6	
3	Diffusion	0 – 10	0 – 10		
4	Initial Delay	0.1mS – 200.0mS	0 – 127	table#5	
5	Feedback Level	-63 – +63	1 – 127		
6	HPF Cutoff	Thru – 8.0kHz	0 – 52	table#3	
7	LPF Cutoff	1.0k – Thru	34 – 60	table#3	
8					
9					
10	Dry/Wet Balance	D63>W – D=W – D<W63	1 – 127		●
11	Liveness	0 – 10	0 – 10		
12	Density	0 – 3	0 – 3		
13	High Damp	0.1 – 1.0	1 – 10		
14					
15					
16					

MSB = 16
MSB = 17
MSB = 18
MSB = 19

No.	Parameter	Display	Value	See Table	Control
1	Reverb Time	0.3 – 30.0s	0 – 69	table#4	
2	Diffusion	0 – 10	0 – 10		
3	Initial Delay	0.1mS – 99.3mS	0 – 63	table#5	
4	HPF Cutoff	Thru – 8.0kHz	0 – 52	table#3	
5	LPF Cutoff	1.0k – Thru	34 – 60	table#3	
6	Width	0.5 – 10.2m	0 – 37	table#8	
7	Height	0.5 – 20.2m	0 – 73	table#8	
8	Depth	0.5 – 30.2m	0 – 104	table#8	
9	Wall Vary	0 – 30	0 – 30		
10	Dry/Wet Balance	D63>W – D=W – D<W63	1 – 127		●
11	Rev Delay	0.1mS – 99.3mS	0 – 63	table#5	
12					
13					
14					
15					
16					

MSB = 20

No.	Parameter	Display	Value	See Table	Control
1	Delay Time	0.1mS – 400.0mS	0 – 127	table#7	
2	Feedback Level	-63 – +63	1 – 127		
3	HPF Cutoff	Thru – 8.0kHz	0 – 52	table#3	
4	LPF Cutoff	1.0k – Thru	34 – 60	table#3	
5					
6					
7					
8					
9					
10	Dry/Wet Balance	D63>W – D=W – D<W63	1 – 127		●
11					
12					
13					
14					
15					
16					

MSB = 65
MSB = 66

No.	Parameter	Display	Value	See Table	Control
1	LFO Frequency	0.00Hz – 39.7Hz	0 – 127	table#1	
2	LFO Depth	0 – 127	0 – 127		
3	Feedback Level	-63 – +63	1 – 127		
4	Delay Offset	0.0mS – 50mS	0 – 127	table#2	
5					
6	EQ Low Frequency	32Hz – 2.0kHz	4 – 40	table#3	
7	EQ Low Gain	-12 – +12dB	52 – 76		
8	EQ High Frequency	500Hz – 16.0kHz	28 – 58	table#3	
9	EQ High Gain	-12 – +12dB	52 – 76		
10	Dry/Wet Balance	D63>W – D=W – D<W63	1 – 127		●
11	EQ Mid Frequency (*5)	100Hz – 10.0kHz	14 – 54	table#3	
12	EQ Mid Gain (*5)	-12 – +12dB	52 – 76		
13	EQ Mid Width (*5)	1.0 – 12.0	10 – 120		
14					
15	Input Mode	mono/stereo	0 – 1		
16					

MSB = 67

No.	Parameter	Display	Value	See Table	Control
1	LFO Frequency	0.00Hz – 39.7Hz	0 – 127	table#1	
2	LFO Depth	0 – 127	0 – 127		
3	Feedback Level	-63 – +63	1 – 127		
4	Delay Offset	0.0mS – 50mS	0 – 127	table#2	
5					
6	EQ Low Frequency	32Hz – 2.0kHz	4 – 40	table#3	
7	EQ Low Gain	-12 – +12dB	52 – 76		
8	EQ High Frequency	500Hz – 16.0kHz	28 – 58	table#3	
9	EQ High Gain	-12 – +12dB	52 – 76		
10	Dry/Wet Balance	D63>W – D=W – D<W63	1 – 127		●
11					
12					
13					
14	LFO Phase Difference	-180 – +180deg (resolution=3deg.)	4 – 124		
15					
16					

MSB = 68

No.	Parameter	Display	Value	See Table	Control
1	LFO Frequency	0.00Hz – 39.7Hz	0 – 127	table#1	
2	LFO Depth	0 – 127	0 – 127		
3	Delay Offset	0.0mS – 50mS	0 – 127	table#2	
4					
5					
6	EQ Low Frequency	32Hz – 2.0kHz	4 – 40	table#3	
7	EQ Low Gain	-12 – +12dB	52 – 76		
8	EQ High Frequency	500Hz – 16.0kHz	28 – 58	table#3	
9	EQ High Gain	-12 – +12dB	52 – 76		
10	Dry/Wet Balance	D63>W – D=W – D<W63	1 – 127		●
11					
12					
13					
14					
15					
16					

Lista de parámetros de efectos

MSB = 69, LSB = 0, 16, 17

No.	Parameter	Display	Value	See Table	Control
1	LFO Frequency	0.00Hz – 39.7Hz	0 – 127	table#1	●
2	LFO Depth	0 – 127	0 – 127		
3					
4					
5					
6	EQ Low Frequency	32Hz – 2.0kHz	4 – 40	table#3	
7	EQ Low Gain	-12 – +12dB	52 – 76		
8	EQ High Frequency	500Hz – 16.0kHz	28 – 58	table#3	
9	EQ High Gain	-12 – +12dB	52 – 76		
10	Dry/Wet Balance	D63>W – D=W – D<W63	1 – 127		
11					
12					
13					
14					
15					
16					

MSB = 72, LSB = 0, 16, 17, 18

No.	Parameter	Display	Value	See Table	Control
1	LFO Frequency	0.00Hz – 39.7Hz	0 – 127	table#1	
2	LFO Depth	0 – 127	0 – 127		
3	Phase Shift Offset	0 – 127	0 – 127		
4	Feedback Level	-63 – +63	1 – 127		
5					
6	EQ Low Frequency	32Hz – 2.0kHz	4 – 40	table#3	
7	EQ Low Gain	-12 – +12dB	52 – 76		
8	EQ High Frequency	500Hz – 16.0kHz	28 – 58	table#3	
9	EQ High Gain	-12 – +12dB	52 – 76		
10	Dry/Wet Balance	D63>W – D=W – D<W63	1 – 127		●
11	Stage	6, 7, 8, 9, 10	6 – 10		
12					
13					
14					
15					
16					

MSB = 70

No.	Parameter	Display	Value	See Table	Control
1	LFO Frequency	0.00Hz – 39.7Hz	0 – 127	table#1	●
2	AM Depth	0 – 127	0 – 127		
3	PM Depth	0 – 127	0 – 127		
4					
5					
6	EQ Low Frequency	32Hz – 2.0kHz	4 – 40	table#3	
7	EQ Low Gain	-12 – +12dB	52 – 76		
8	EQ High Frequency	500Hz – 16.0kHz	28 – 58	table#3	
9	EQ High Gain	-12 – +12dB	52 – 76		
10					
11					
12					
13					
14	LFO Phase Difference	-180 – +180deg (resolution=3deg.)	4 – 124		
15	Input Mode	mono/stereo	0 – 1		
16					

MSB = 72, LSB = 8

No.	Parameter	Display	Value	See Table	Control
1	LFO Frequency	0.00Hz – 39.7Hz	0 – 127	table#1	
2	LFO Depth	0 – 127	0 – 127		
3	Phase Shift Offset	0 – 127	0 – 127		
4	Feedback Level	-63 – +63	1 – 127		
5					
6	EQ Low Frequency	32Hz – 2.0kHz	4 – 40	table#3	
7	EQ Low Gain	-12 – +12dB	52 – 76		
8	EQ High Frequency	500Hz – 16.0kHz	28 – 58	table#3	
9	EQ High Gain	-12 – +12dB	52 – 76		
10	Dry/Wet Balance	D63>W – D=W – D<W63	1 – 127		●
11	Stage	3, 4, 5	3 – 5		
12					
13	LFO Phase Difference	-180deg – +180deg (resolution=3deg.)	4 – 124		
14					
15					
16					

MSB = 71

No.	Parameter	Display	Value	See Table	Control
1	LFO Frequency	0.00Hz – 39.7Hz	0 – 127	table#1	●
2	L/R Depth	0 – 127	0 – 127		
3	F/R Depth	0 – 127	0 – 127		
4	PAN Direction	L R, L R, L R, Lturn, Rturn, L/R	0 – 5		
5					
6	EQ Low Frequency	32Hz – 2.0kHz	4 – 40	table#3	
7	EQ Low Gain	-12 – +12dB	52 – 76		
8	EQ High Frequency	500Hz – 16.0kHz	28 – 58	table#3	
9	EQ High Gain	-12 – +12dB	52 – 76		
10					
11					
12					
13					
14					
15					
16					

MSB = 73, LSB = 0

No.	Parameter	Display	Value	See Table	Control
1	Drive	0 – 127	0 – 127		●
2	EQ Low Frequency	32Hz – 2.0kHz	4 – 40	table#3	
3	EQ Low Gain	-12 – +12dB	52 – 76		
4	LPF Cutoff	1.0k – Thru	34 – 60	table#3	
5	Output Level	0 – 127	0 – 127		
6					
7	EQ Mid Frequency	100Hz – 10.0kHz	14 – 54	table#3	
8	EQ Mid Gain	-12 – +12dB	52 – 76		
9	EQ Mid Width	1.0 – 12.0	10 – 120		
10	Dry/Wet Balance	D63>W – D=W – D<W63	1 – 127		
11	Edge (Clip Curve)	0 (mild) – 127 (sharp)	0 – 127		
12					
13					
14					
15					
16					

Effect Parameter List / Liste der Effektparameter / Liste des paramètres d'effets / Lista de parámetros de efectos

MSB = 75

No.	Parameter	Display	Value	See Table	Control
1	Drive	0 – 127	0 – 127		●
2	AMP Type	Off, Stack, Combo, Tube	0 – 3		
3	LPF Cutoff	1.0k – Thru	34 – 60	table#3	
4	Output Level	0 – 127	0 – 127		
5					
6					
7					
8					
9					
10	Dry/Wet Balance	D63>W – D=W – D<W63	1 – 127		
11	Edge (Clip Curve)	0 (mild) – 127 (sharp)	0 – 127		
12					
13					
14					
15					
16					

MSB = 78, LSB = 0, 16, 19, 20

No.	Parameter	Display	Value	See Table	Control
1	LFO Frequency	0.00Hz – 39.7Hz	0 – 127	table#1	
2	LFO Depth	0 – 127	0 – 127		
3	Cutoff Frequency Offset	0 – 127	0 – 127		●
4	Resonance	1.0 – 12.0	10 – 120		
5					
6	EQ Low Frequency	32Hz – 2.0kHz	4 – 40	table#3	
7	EQ Low Gain	-12 – +12dB	52 – 76		
8	EQ High Frequency	500Hz – 16.0kHz	28 – 58	table#3	
9	EQ High Gain	-12 – +12dB	52 – 76		
10	Dry/Wet Balance	D63>W – D=W – D<W63	1 – 127		
11					
12					
13					
14					
15					
16					

MSB = 76

No.	Parameter	Display	Value	See Table	Control
1	EQ Low Gain	-12 – +12dB	52 – 76		
2	EQ Mid Frequency	100Hz – 10.0kHz	14 – 54	table#3	
3	EQ Mid Gain	-12 – +12dB	52 – 76		
4	EQ Mid Width	1.0 – 12.0	10 – 120		
5	EQ High Gain	-12 – +12dB	52 – 76		
6	EQ Low Frequency	50Hz – 2.0kHz	8 – 40	table#3	
7	EQ High Frequency	500Hz – 16.0kHz	28 – 58	table#3	
8					
9					
10					
11					
12					
13					
14					
15	Input Mode	mono/stereo	0 – 1		
16					

MSB = 64

No.	Parameter	Display	Value	See Table	Control
1					
2					
3					
4					
5					
6					
7					
8					
9					
10					
11					
12					
13					
14					
15					
16					

MSB = 77

No.	Parameter	Display	Value	See Table	Control
1	EQ Low Frequency	32Hz – 2.0kHz	4 – 40	table#3	
2	EQ Low Gain	-12 – +12dB	52 – 76		
3	EQ High Frequency	500Hz – 16.0kHz	28 – 58	table#3	
4	EQ High Gain	-12 – +12dB	52 – 76		
5					
6					
7					
8					
9					
10					
11					
12					
13					
14					
15					
16					

Parameter 10 Dry/Wet Balance only affects insertion type effects.

Function ...	Transmitted	Recognized	Remarks
Basic Default Channel Changed	1 - 16 1 - 16 *1	1 - 16 1 - 16 *2	Memorized
Mode Default Messages Altered	3 x *****	3 3,4 (m=1) *3 x	
Note Number : True voice	0 - 127 *****	0 - 127 0 - 127	
Velocity Note ON Note OFF	o 9nH,v=1-127 x 9nH,v=0	o 9nH,v=1-127 x	
After Key's Touch Ch's	x x	x o	
Pitch Bend	o	o 0-24 semi	
Control change	0,32 1 x *4 5 x 7,10,11 o 6,38 o 64,66,67 o 65 x 71-74 x *4 84 o 91,93,94 o 96,97 x 98,99 x *4 100,101 o	o o o o o o o o o o o o o	Bank Select Modulation Portamento Time Data Entry Portamento Sound Controller Portamento Cntrl Effect Depth RPN Inc,Dec NRPN LSB,MSB RPN LSB,MSB
Prog Change : True #	o 0 - 127 *****	o 0 - 127	
System Exclusive	o	o	
: Song Pos. Common : Song Sel. : Tune	x x x	x x x	
System :Clock Real Time :Commands	o o	o o	
Aux :All Sound Off :Reset All Cntrls :Local ON/OFF :All Notes OFF Mes- :Active Sense sages:Reset	x x x x o x	o (120,126,127) o (121) o (122) o (123-125) o x	
Notes:			

Mode 1 : OMNI ON, POLY Mode 2 : OMNI ON, MONO o : Yes
 Mode 3 : OMNI OFF, POLY Mode 4 : OMNI OFF, MONO x : No

Notes:

- *1: The send channel for the RIGHT1, RIGHT2, and LEFT parts can be set using the Send Channel (Keyboard) function. The transmission of accompaniment, harmony, and song data can be turned on or off using the Send Channel (Accompaniment/Harmony) and Song Transmission functions.
- *2: Messages received on the channel set by the Remote Keyboard function are handled as operations performed directly on the keyboard or panel. Only the following messages are received on this channel:
- Note On/Off (A-1...C7)
 - Control Changes
 - Bank Select MSB/LSB (RIGHT1 part)
 - Modulation
 - Data Entry MSB (when PITCH BEND SENS. is set by RPN LSB/MSB)
 - Volume
 - Expression
 - Sustain
 - Sostenuto
 - Soft Pedal
 - Data Increment/Decrement (when PITCH BEND SENS. is set by RPN LSB/MSB)
 - RPN LSB/MSB (PITCH BEND SENS. only)
 - All Note Off
 - Program Change (RIGHT1 part)
 - Pitch Bend
- *3: "m" is always treated as "1" regardless of its value.
- *4: Transmitted when ACMP&RHY or HARMONY setting of Send Channel (Accompaniment/Harmony) function is on.

Hinweise:

- *1: Der Sendekanal für die Parts RIGHT1, RIGHT2 und LEFT läßt sich über die Funktion Sendekanal (Keyboard) einstellen. Die Übertragung von Begleitungs-, Harmonie- und Songdaten kann mit den Funktionen Sendekanal (Begleitung/Harmonie) und Song-Übertragung ein- bzw. ausgeschaltet werden.
- *2: Meldungen, die an dem Kanal empfangen werden, der von der Remote Keyboard-Funktion eingestellt wurde, werden als direkt auf dem Keyboard oder Steuerpult ausgeführte Bedienoperationen angesehen. Nur die nachfolgend genannten Meldungen werden auf diesem Kanal empfangen:
- Noten Ein/Aus (A-1...C7)
 - Steuerungsänderungs-
 - Bank. Wählen Sie MSB/LSB (Part RIGHT1)
 - Modulation
 - Dateneintrag MSB (sofern die Option PITCH BEND SENS. (Tonlagenabstastung) von RPN LSB/MSB) eingestellt wurde
 - VOLUME (LAUTSTÄRKE)
 - Expression (Ausdruck)
 - Sustain
 - Sostenuto
 - Soft Pedal
 - Datenerhöhung/-erniedrigung (sofern die Option PITCH BEND SENS. (Tonlagenabstastung) von RPN LSB/MSB eingestellt wurde)
 - RPN LSB/MSB (nur PITCH BEND SENS., TONLAGENABTASTUNG)
 - Alle Noten ausgeschaltet
 - Programmänderung (Part RIGHT1)
 - Pitch Bend (Tonlage)
- *3: "m" wird stets als "1" behandelt, unabhängig von dessen Wert.
- *4: Wird übertragen, wenn die ACMP&RHY- oder HARMONIE-Einstellung der Funktion Sendekanal (Begleitung/Harmonie) aktiviert ist.

Remarques :

- *1 : Le canal d'émission pour les parties RIGHT1, RIGHT2, et LEFT peut être configuré à l'aide de la fonction Send Channel (Keyboard). La transmission des données d'accompagnement, d'harmonie et de morceau peut être activée ou désactivée à l'aide des fonctions Send Channel (Accompaniment/Harmony) et Song Transmission.
- *2 : Les messages reçus sur le canal configuré à l'aide de la fonction Remote Keyboard sont traités comme des opérations réalisées directement sur le clavier ou le panneau. Seuls les messages suivants sont reçus sur ce canal :
- Note On/Off (A-1...C7)
 - Control Changes
 - Bank Select MSB/LSB (partie RIGHT1)
 - Modulation
 - Data Entry MSB (si PITCH BEND SENS. est défini à l'aide de RPN LSB/MSB)
 - Volume
 - Expression
 - Sustain
 - Sostenuto
 - Soft Pedal
 - Data Increment/Decrement (si PITCH BEND SENS. est défini à l'aide de RPN LSB/MSB)
 - RPN LSB/MSB (PITCH BEND SENS. uniquement)
 - All Note Off
 - Program Change (partie RIGHT1)
 - Pitch Bend
- *3 : "m" équivaut toujours à "1" quelle que soit sa valeur.
- *4 : Transmis(e) si le paramètre ACMP&RHY ou HARMONY de la fonction Send Channel (Accompaniment/Harmony) est activé.

Notas:

- *1: El canal de envío para las partes RIGHT1, RIGHT2 y LEFT puede ajustarse utilizando la función Send Channel (teclado). La transmisión del acompañamiento de la armonía y de los datos de canción se pueden activar o desactivar utilizando las funciones Send Channel (Accompaniment/Harmony) y Song Transmission.
- *2: Los mensajes recibidos en el canal ajustado por la función Remote Keyboard se consideran como operaciones realizadas directamente en el teclado o el panel. Sólo los mensajes siguientes se reciben en este canal:
- Note On/Off (A-1...C7)
 - Control Changes
 - Bank Select MSB/LSB (parte RIGHT1)
 - Modulation
 - Data Entry MSB (cuando PITCH BEND SENS. se ajusta con RPN LSB/MSB)
 - Volume
 - Expression
 - Sustain
 - Sostenuto
 - Soft Pedal
 - Data Increment/Decrement (cuando PITCH BEND SENS. se ajusta con RPN LSB/MSB)
 - RPN LSB/MSB (sólo PITCH BEND SENS.)
 - All Note Off
 - Program Change (parte RIGHT1)
 - Pitch Bend
- *3: "m" siempre se considera como "1" independientemente de su valor.
- *4: Transmitido cuando los ajustes ACMP&RHY o HARMONY de la función Send Channel (Accompaniment/Harmony) está activada.

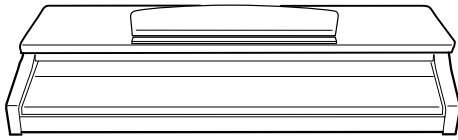
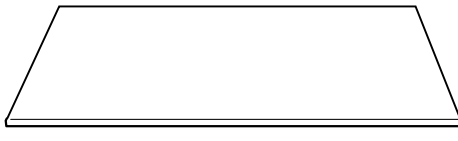
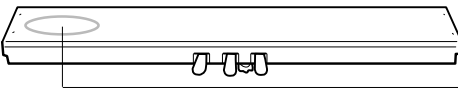
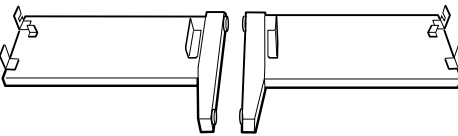
1**A****B****C****D**

- Bundled pedal cord inside
- Gebündeltes Pedalkabel
- Cordon de pédalier enroulé à l'intérieur
- Cable de pedales enrollado en el interior

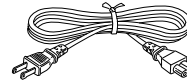

- AC power cord
- Netzkabel
- Cordon d'alimentation
- Cable de alimentación de CA



- Cord holders x 2
- Kabelhalter x 2
- Serre-câble x 2
- Soportes de cable x 2

Assembly

CAUTION

- Be careful not to confuse parts, and be sure to install all parts in the correct direction. Please assemble in accordance with the sequence given below.
- Assembly should be carried out by at least two persons.
- Be sure to use the correct screw size, as indicated above. Use of incorrect screws can cause damage.
- Be sure to tighten up all screws upon completing assembly of each unit.
- To disassemble, reverse the assembly sequence given below.

1 Open the box and remove all the parts.

Remove all parts from the box. Confirm that all parts shown in the illustration above are provided.

2 Attach the side panels (D) to the pedal box (C).

Before installing the pedal box, untie and straighten out the bundled cord attached to the bottom of the pedal box. Don't discard the vinyl tie, you'll need it later in step **5**. Place the pedal box on top of the brackets attached to the side panels (D), and attach using the four 6 x 20 millimeter round-head screws **1** — two screws on each side. Make sure the pedals extend in the same direction as the side panel feet.

Zusammenbau

VORSICHT

- Achten Sie darauf, die Teile nicht zu verwechseln, und installieren Sie alle Teile in der richtigen Ausrichtung. Gehen Sie beim Zusammenbau bitte in der angegebenen Reihenfolge vor.
- Die Montage sollte von mindestens zwei Personen vorgenommen werden.
- Achten Sie darauf, die richtige Schraubengröße zu verwenden, wie es oben gezeigt ist. Die Verwendung der falschen Schrauben kann zu Schäden führen.
- Achten Sie während der Montage darauf, bei jedem Arbeitgang alle Schrauben festzuziehen.
- Für die Demontage muß die angegebene Reihenfolge umgekehrt befolgt werden.

1 Öffnen Sie den Karton und nehmen Sie alle Teile heraus.

Vergewissern Sie sich, daß alle in der obigen Abbildung aufgeführten Teile vollzählig vorhanden sind.

2 Befestigen Sie die Seitenwände (D) am Pedalkasten (C).

Bevor Sie den Pedalkasten montieren, nehmen Sie zunächst das gebündelte Kabel aus dem Pedalkasten, entfernen den Kabelbinder und ziehen das Kabel dann gerade aus. Werfen Sie den Kabelbinder nicht wg, er wird in Schritt **5** wieder gebraucht.

Setzen Sie den Pedalkasten auf die Winkelbleche der beiden Seitenwänden (D), und schrauben Sie ihn dann mit den vier Halbrundschruben (6 x 20 mm) **1** fest (jeweils zwei Schrauben links und rechts). Achten Sie dabei darauf, daß die Pedale in dieselbe Richtung weisen wie die vorspringenden Teile der Füße.



- 6 x 20 mm round-head screws x 4 ①
- 6 x 20 mm Halbrundsrauben x 4 ①
- Vis à tête ronde de 6 x 20 mm x 4 ①
- Tornillos de cabeza redonda de 6 x 20 mm x 4 ①



- 4 x 12 mm round-head screws x 2 ②
- 4 x 12 mm Halbrundsrauben x 2 ②
- Vis à tête ronde de 4 x 12 mm x 2 ②
- Tornillos de cabeza redonda de 4 x 12 mm x 2 ②



- 4 x 20 mm tapping screws x 4 ③
- 4 x 20 mm Schneidschrauben x 4 ③
- Vis auto-taraudeuses 4 x 20 mm x 4 ③
- Tornillos de autoenrosque de 4 x 20 mm x 4 ③



- 6 x 16 mm flat-head screws x 4 ④
- 6 x 16 mm Senkschrauben x 4 ④
- Vis à tête plate de 6 x 16 mm x 4 ④
- Tornillos de cabeza plana de 6 x 16 mm x 4 ④

2

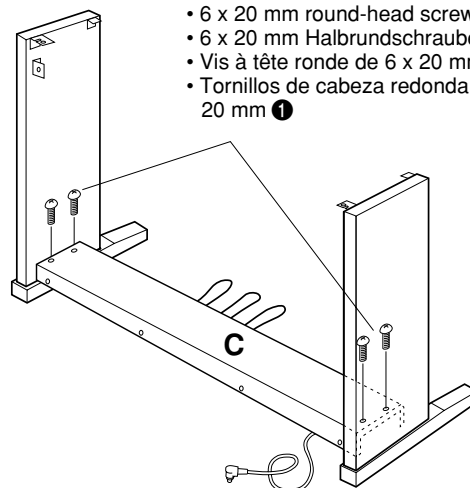

- 6 x 20 mm round-head screws ①
- 6 x 20 mm Halbrundsrauben ①
- Vis à tête ronde de 6 x 20 mm ①
- Tornillos de cabeza redonda de 6 x 20 mm ①

Montage

⚠ PRECAUTION

- Veiller à ne pas mélanger les pièces et à les installer dans le sens correct. Veuillez assembler l'instrument dans l'ordre indiqué ci-dessous.
- La présence de deux personnes minimum est nécessaire pour procéder au montage.
- Toujours utiliser des vis aux dimensions correctes, comme indiqué cidessus. L'utilisation de vis aux dimensions incorrectes pourrait en effet endommager l'instrument.
- Resserrer convenablement toutes les vis après le montage de chaque élément.
- Pour démonter le Clavinova, inverser l'ordre des indications données ci-dessous.

1 Ouvrez le carton et retirez toutes les pièces

Videz le carton de son contenu. Vérifiez que toutes les pièces indiquées sur l'illustration sont bien fournies.

2 Fixez les panneaux latéraux (D) au pédalier (C)

Avant de poser le pédalier, détacher le cordon de la partie inférieure du pédalier et le dérouler. Ne jetez pas l'attache en vinyle, vous la réutiliserez ultérieurement à l'étape 5. Placez le pédalier sur les ferrures fixées aux panneaux latéraux (D) et fixez-le à l'aide des quatre vis à tête ronde de 6 x 20 millimètres ① : deux vis de chaque côté. Veillez à ce que les pédales soient dirigées dans le même sens que les supports inférieurs.

Montaje

⚠ CUIDADO

- Observe cuidado para no confundir las piezas, y asegúrese de montar todas ellas en el sentido correcto. Proceda al montaje en el orden indicado a continuación.
- El montaje deberá realizarse al menos por dos personas.
- Procure utilizar los tornillos del tamaño adecuado, según se indica arriba. El empleo de tornillos inadecuados puede ocasionar daños en el instrumento.
- Asegúrese de apretar bien todos los tornillos después de montar cada unidad.
- Para desmontar las unidades, invierta la secuencia de montaje facilitada a continuación.

1 Abra la caja y extraiga todas las partes.

Extraiga todas las partes de la caja. Confirme que no falte ninguna de las partes mostradas en la ilustración.

2 Acople los paneles laterales (D) en la caja de pedales (C).

Antes de instalar la caja de pedales, desate y enderezca el cable plegado unido a la parte inferior de la caja de pedales. No tire la abrazadera de vinilo, porque la necesitará en el paso 5 de más adelante.

Ponga la caja de pedales en la parte superior de las ménsulas acopladas a los paneles laterales (D), y acople empleando los cuatro tornillos de cabeza redonda de 6 x 20 mm ①; dos tornillos en cada lado. Asegúrese de que el pedal se extiende en la misma dirección que la pata.

3

- 4 x 12 mm round-head screws ②
- 4 x 12 mm Halbrundsrauben ②
- Vis à tête ronde de 4 x 12 mm ②
- Tornillos de cabeza redonda de 4 x 12 mm ②

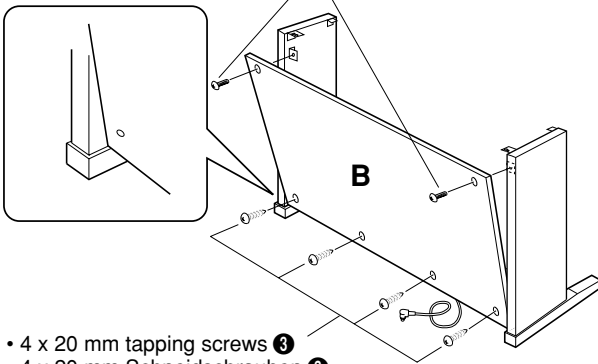

- 4 x 20 mm tapping screws ③
- 4 x 20 mm Schneidschrauben ③
- Vis auto-taraudeuses 4 x 20 mm ③
- Tornillos de autoenrosque de 4 x 20 mm ③

3 Attach the rear panel (B).

With the rear panel slightly angled as shown in the illustration, lower it onto the feet's protruding edge at the rear of the pedal box. Then, while eliminating any gaps between the rear and side panels, secure the top of the rear panel to the side panel brackets using two 4 x 12 mm round-head screws ②. Finally, secure the bottom of the rear panel to the pedal box using four 4 x 20 mm tapping screws ③.

4 Install the main unit (A).

Place the main unit (A) on the side panels (D) with the screws on its bottom panel (toward the rear of the main unit) just behind the grooves in the brackets located at the top of the side panels. Then slide the main unit forward until it stops. **WATCH YOUR FINGERS WHEN DOING THIS!!**

Align the holes on the bottom panel of the main unit with the holes in the brackets on the side panels (also center the main unit to produce equal clearance on the left and right sides, as shown in the illustration), then screw in and securely tighten the four 6 x 16 millimeter flat-head screws ④.

⚠ CAUTION

- Do not hold the keyboard in any position other than the position shown in the above illustration.
- Fingers can become pinched between the main unit and the rear or side panels, be extra careful so as not to drop the main unit.

5 Connect the pedal cord.

The pedal cord from the pedal box must be plugged into the PEDAL connector on the rear of the main unit. Once connected, attach the cord holders to the rear panel as shown, then clip the cord into the holders.

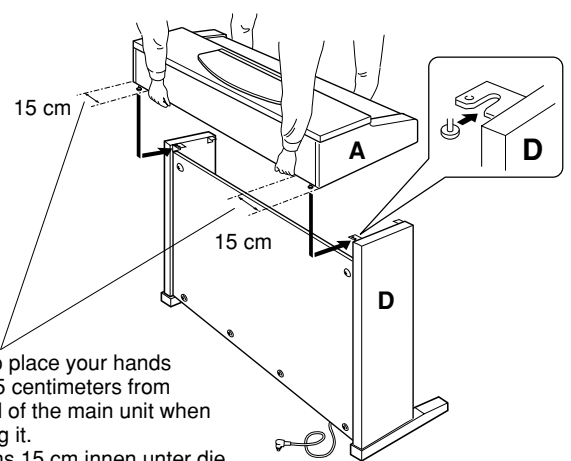
4

- Be sure to place your hands at least 15 centimeters from either end of the main unit when positioning it.
- Mindestens 15 cm innen unter die Tastatureinheit greifen.
- Placez bien vos mains à 15 cm au moins des extrémités du clavier, lors de sa mise en place.
- Asegúrese de colocar las manos por lo menos a 15 centímetros desde los extremos de la unidad principal cuando la sitúe.

3 Montieren Sie die Rückwand (B).

Setzen Sie die Rückwand leicht abgewinkelt, wie in der Abbildung gezeigt, hinter dem Pedalkasten auf die hervorspringenden Teile der FüÙe auf. Schrauben Sie dann die Rückwand oben mit zwei 4 x 12 mm Halbrundschrauben ② so an den Seitenwänden fest, daß kein Spiel zwischen Rückwand und Seitenwänden verbleibt. Schrauben Sie die Rückwand abschließend noch mit vier 4 x 20 mm Schneidschrauben ③ an den Pedalkasten.

4 Montieren Sie die Tastatureinheit (A).

Setzen Sie die Tastatureinheit (A) so auf den fertigen Ständer, daß die beiden Schrauben an ihrer Unterseite hinter den Winkelblechen mit Führungsschlitz an der Hinterseite des Ständers zu liegen kommen. Schieben Sie die Tastatureinheit dann bis zum Anschlag in die Schlitze. **KLEMMEN SIE IHRE FINGER DABEI NICHT EIN!!**

Richten Sie die Schraubenbohrungen an der Unterseite der Tastatureinheit mit den Bohrungen der Winkelbleche aus (achten Sie auch darauf, daß sie mittig auf dem Ständer steht, wie in der Abbildung gezeigt). Schrauben Sie die Tastatureinheit dann mit den vier 6 x 16 mm Senkschrauben ④ am Ständer fest.

⚠ VORSICHT

- Halten Sie die Tastatureinheit nur wie in der obigen Abbildung!
- Achten Sie darauf, daß Sie Ihre Finger nicht zwischen Tastatureinheit und den Seitenwänden bzw. der Rückwand einklemmen — die Tastatureinheit könnte dadurch zu Fall kommen!

5 Schließen Sie das Pedalkabel an.

Das vom Pedalkasten kommende Kabel muß in die PEDAL-Buchse an der Rückwand der Haupteinheit gesteckt werden. Befestigen Sie dann die Kabelhalter an der Rückwand wie in der Abbildung gezeigt, und klemmen Sie das Kabel in diese Halter.

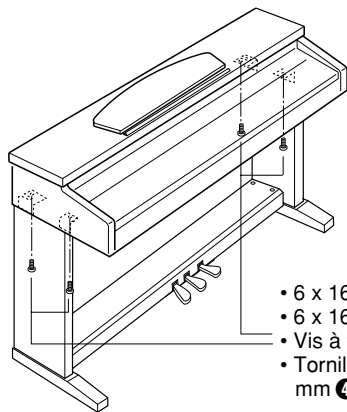

- 6 x 16 mm flat-head screws ④
- 6 x 16 mm Senkschrauben ④
- Vis à tête plate de 6 x 16 mm ④
- Tornillos de cabeza plana de 6 x 16 mm ④

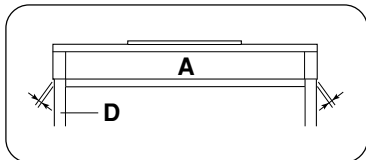

③ Fixez le panneau arrière (B)

En inclinant légèrement en angle le panneau arrière, comme mentionné sur l'illustration, abaissez-le sur le rebord des pieds, à l'arrière du pédalier. Puis, tout en éliminant les espaces entre les panneaux arrière et latéraux, fixez le haut du panneau arrière sur les supports des panneaux latéraux à l'aide de deux vis à tête ronde 4 x 12 mm ②. Et finalement, fixez le bas du panneau arrière au pédalier avec quatre vis auto-taraudeuses 4 x 20 mm ③.

④ Posez le clavier (A)

Placez le clavier sur les panneaux latéraux (D), avec les vis de son panneau inférieur (situées vers l'arrière du clavier) placées immédiatement derrière les rainures des ferrures situées à la partie supérieure des panneaux latéraux (D), puis faites glisser le clavier vers l'avant jusqu'à ce qu'il vienne en butée. **FAITES ATTENTION A VOS DOIGTS EN EXECUTANT CETTE OPERATION!!** Alignez les trous du panneau inférieur du clavier sur les trous des ferrures des panneaux latéraux (centrez également le clavier de manière à avoir un jeu identique de chaque côté) puis posez et serrez à fond les quatre vis à tête plate de 6 x 16 millimètres ④.

⚠ **PRECAUTION**

- Ne tenez pas le clavier d'une autre manière que celle indiquée sur l'illustration ci-dessus.
- Attention car vous risquez de vous faire pincer les doigts entre le clavier et les panneaux arrière ou latéraux de sorte que vous devez veiller à ne pas faire tomber le clavier.

⑤ Raccordez le cordon du pédalier

Le câble qui sort du pédalier doit être branché sur le connecteur PEDAL (PEDALE) à l'arrière du clavier. Une fois raccordé, fixez les serre-fils sur le panneau arrière, comme indiqué, puis faites passer le câble dans les serre-fils.

5

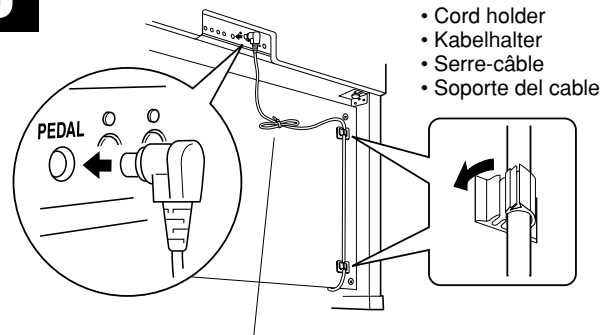

- Cord holder
- Kabelhalter
- Serre-câble
- Soporte del cable

- Use the vinyl tie that was removed from the bundled pedal cord in step ② to tie up any slack in the pedal cord.
- Nehmen Sie überlanges Kabel mit dem in Schritt ② entfernten Kabelbinder auf.
- Utilisez l'attache en vinyle qui a été enlevée du cordon de pédalier à l'étape ② pour attacher le fil excédentaire du cordon de pédalier.
- Emplee la abrazadera de vinilo que se sacó del cable plegado de los pedales en el paso ② para fijar el cable de pedales sobrante.

③ Monte el panel trasero (B).

Con el panel trasero un poco inclinado en ángulo como se muestra en la ilustración, bájelo al borde saliente de las patas de la parte posterior de la caja de pedales. Entonces, mientras elimina los huecos entre los paneles trasero y lateral, fije la parte superior del panel trasero a las ménsulas de panel lateral usando dos tornillos de cabeza redonda de 4 x 12 mm ②. Finalmente, fije la parte inferior del panel trasero a la caja de pedales usando cuatro tornillos de autoenroscado de 4 x 20 mm ③.

④ Instale la unidad principal (A).

Coloque la unidad principal en los paneles laterales (D) con los tornillos de su panel inferior (hacia la parte posterior de la unidad principal) justo detrás de las ranuras de la ménsula ubicada en la parte superior de los paneles laterales (D), después deslice el teclado hacia adelante hasta que se pare. **¡TENGA CUIDADO CON SUS DEDOS MIENTRAS LO HACE!**

Alinee los orificios del panel inferior de la unidad principal con los orificios de las ménsulas de los paneles laterales (también centre la unidad principal para producir una holgura igual en los lados derecho e izquierdo, como se muestra en la ilustración), después enrosque y apriete bien los cuatro tornillos de cabeza plana de 6 x 16 mm ④.

⚠ **CUIDADO**

- No sostenga el teclado en ninguna posición que no sea la posición mostrada en la ilustración de arriba.
- Podría pillarse los dedos ente la unidad principal y los paneles traseros o laterales, por lo que deberá tener mucho cuidado que no se caiga la unidad principal.

⑤ Conecte el cable de los pedales.

El cable de los pedales procedente de la caja de pedales debe conectarse al conector PEDAL (pedales) situado en la parte posterior de la unidad principal. Una vez conectado, coloque los soportes de cable en el panel trasero de la manera mostrada en la figura y enganche el cable en los soportes.

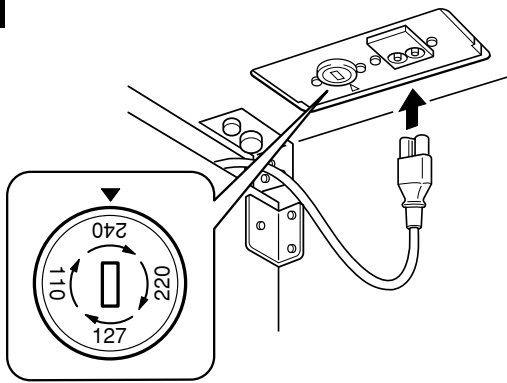
6

- A voltage selector is provided in some areas.
- Spannungswähler (nur in bestimmten Verkaufsgebieten)
- Un sélecteur de tension est prévu pour certaines régions
- El selector de tensión está provisto para ciertos destinos.

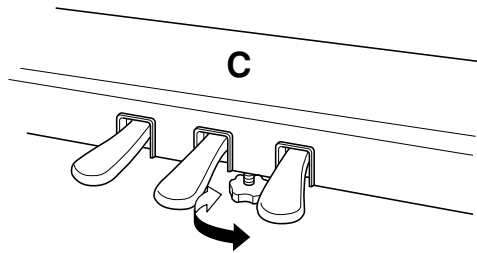
7

6 Voltage Selector

Before connecting the AC power cord, check the setting of the voltage selector which is provided in some areas. To set the selector for 110V, 127V, 220V or 240V main voltages, use a “minus” screwdriver to rotate the selector dial so that the correct voltage for your region appears next to the pointer on the panel. The voltage selector is set at 240V when the unit is initially shipped.

After the proper voltage has been selected, slide the AC power cord over the rear panel and connect the cord to the AC INLET, then connect the other end of the cord to an AC wall outlet. A plug adaptor may be also provided in some areas to match the pin configuration of the AC wall outlets in your area.

⚠ CAUTION

- An improper voltage setting can cause serious damage to the CVP-202 or result in improper operation.

7 Set the adjuster.

For stability, an adjuster is provided on the bottom of the pedal box (C). Rotate the adjuster until it comes in firm contact with the floor surface. The adjuster ensures stable pedal operation and facilitates pedal effect control. If the adjuster is not in firm contact with the floor surface, distorted sound may result.

■ After completing the assembly, please check the following.

- Are there any parts left over?
 - Review the assembly procedure and correct any errors.
- Is the Clavinova clear of doors and other movable fixtures?
 - Move the Clavinova to an appropriate location.
- Does the Clavinova make a rattling noise when you shake it?
 - Tighten all screws.
- Does the pedal box rattle or give way when you step on the pedals?
 - Turn the adjuster so that it is set firmly against the floor.
- Are the pedal and power cords inserted securely into the sockets?
 - Check the connection.
- If the main unit creaks or is otherwise unsteady when you play on the keyboard, refer to the assembly diagrams and retighten all screws.

6 Den Spannungswähler einstellen.

Bevor Sie nun das Netzkabel anschließen, müssen Sie den Spannungswähler (falls vorhanden) auf die örtliche Netzspannung einstellen. Zum Verstellen drehen Sie den Spannungswähler mit einem Schlitzschraubendreher, bis der richtige Spannungswert (110, 127, 220 oder 240) an der Pfeilmarkierung steht. Bei der Auslieferung werden alle Instrumente mit Spannungswähler auf “240” voreingestellt. Wenn Sie die geeignete Spannung ausgewählt haben, führen Sie das Netzkabel über die Rückwand und stecken ein Ende des Netzkabels in die Gerätebuchse AC INLET (Wechselstrom-Anschluß) und das andere Ende in eine Wandsteckdose.

Einigen Geräten ist ein Adapter zum Anschließen an Wandsteckdosen mit einer anderen Anschlußbelegung beigelegt.

⚠ VORSICHT

- Ein falsch eingestellter Spannungswähler kann zur Beschädigung des CVP-202 führen oder zu einem unsachgemäßen Betrieb.

7 Justieren Sie schließlich noch den Höhenversteller.

Zur Stabilisierung ist an der Unterseite des Pedalkastens (C) ein Höhenversteller vorgesehen. Schrauben Sie den Höhenversteller heraus, bis er fest auf dem Fußboden steht. Der Höhenversteller sorgt für stabile Pedalbetätigung und ermöglicht eine präzise Regelung des Betätigungshubs. Wenn er nicht fest auf dem Boden steht, können beim Treten der Pedale Klangverzerrungen auftreten.

■ Wenn der Zusammenbau beendet ist, prüfen Sie bitte folgende Dinge:

- Sind Teile übrig geblieben?
 - Gehen Sie den Vorgang des Zusammenbaus noch einmal durch und korrigieren Sie eventuelle Fehler.
- Befindet sich das Clavinova weit genug von Türen und anderen beweglichen Vorrichtungen entfernt?
 - Bewegen Sie das Clavinova an einen entsprechend sicheren Ort.
- Macht das Clavinova Klappergeräusche, wenn Sie es schütteln?
 - Ziehen Sie alle Schrauben fest.
- Klappert der Pedalkasten oder gibt er nach, wenn Sie das Pedal treten?
 - Drehen Sie den Höhenversteller, bis er fest auf dem Fußboden steht.
- Sind Pedal- und Netzkabel richtig an den Buchsen angeschlossen?
 - Prüfen Sie die Verbindung.
- Wenn die Tastatureinheit knarrt oder beim Spielen wackelt, betrachten Sie die Abbildungen und ziehen Sie alle Schrauben noch einmal nach.

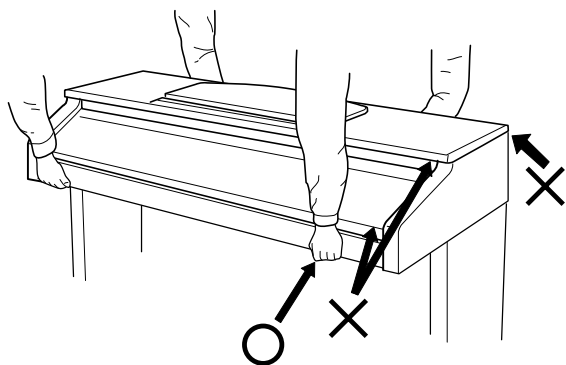

⚠ CAUTION

- When moving the instrument after assembly, always hold the lower surface of the main unit, NEVER the top portion or keyboard cover. Improper handling can result in damage to the instrument or personal injury.

⚠ VORSICHT

- Fassen Sie zum Umstellen des Instruments nach dem Zusammenbau stets unter das Gehäuse; heben Sie es NIEMALS am oberen Teil oder an der Tastaturabdeckung. Bei Nichtbeachtung dieses Punkts kann das Instrument beschädigt und im Extremfall eine Verletzung hervorgerufen werden.

⚠ PRECAUTION

- Pour déplacer l'instrument après le montage, toujours tenir l'instrument par la surface inférieure, JAMAIS par le dessus ou le couvercle. Une mauvaise manipulation peut provoquer des dommages ou des blessures.

⚠ CUIDADO

- Cuando mueva el instrumento después del montaje, sujete siempre la unidad principal por su superficie inferior, NUNCA por la parte superior ni por la cubierta del teclado. La manipulación indebida puede causar daños al instrumento o lesiones al usuario.

6 Sélecteur de tension

Avant de connecter le cordon d'alimentation, vérifiez le réglage du sélecteur de tension qui est prévu pour certaines régions. Pour régler le sélecteur sur 110 V, 127 V, 220 V ou 240 V, utilisez un tournevis à lame plate pour tourner le cadran du sélecteur afin de mettre l'indication correspondant à la tension de votre région vis à vis du repère triangulaire situé sur le panneau. Le sélecteur de tension est réglé sur 240 V au départ d'usine.

Après avoir sélectionné la tension qui convient, faites glisser le câble d'alimentation de CA par dessus le panneau arrière et branchez-le dans l'AC INLET (prise de CA), puis branchez l'autre extrémité dans une prise murale de CA. Vous pouvez également dans certains cas avoir recours à un adaptateur de prise en fonction de la configuration des prises murales de CA de votre pays.

⚠ PRECAUTION

- Un mauvais réglage de la tension peut gravement endommager le CVP-202 ou entraîner des dysfonctionnements.

7 N'oubliez pas de régler la hauteur du pédalier

Pour assurer la stabilité du pédalier (C), un dispositif de réglage a été prévu à sa partie inférieure. Tournez ce dispositif jusqu'à ce qu'il soit en contact ferme avec la surface du sol. Ce dispositif assure la stabilité du pédalier lors de son utilisation et facilite la commande au pied des effets. Si ce dispositif n'est pas en contact ferme avec le sol, il pourra se produire une distorsion du son.

■ Lorsque le montage est terminé, veuillez mener à bien les vérifications suivantes.

- Reste-t-il des pièces non utilisées?
 - Passer en revue la procédure de montage et corriger toute erreur éventuelle.
- Le Clavinova est-il placé à l'écart des portes et de toute autre structure mobile?
 - Déplacer le Clavinova vers un emplacement approprié.
- Lorsque vous secouez quelque peu le Clavinova, entendez-vous un cliquetis?
 - Serrer convenablement toutes les vis.
- Le pédalier fait-il du bruit ou s'écarte-t-il lorsque vous appuyez sur les pédales?
 - Tourner le stabilisateur de sorte que le Clavinova repose fermement sur le sol.
- Les cordons des pédales et d'alimentation sont-ils bien enfoncés dans les prises?
 - Vérifier toutes les connexions.
- Si la partie principale de l'appareil craque ou est instable lorsque vous jouez sur le clavier, consulter les diagrammes de montage et resserrer toutes les vis.

6 Selector de tensión

Antes de conectar el cable de alimentación de CA, compruebe el ajuste del selector de tensión que se incorpora para ciertos destinos. Para ajustar el selector a 110V, 127V, 220V ó 240V de la red de alimentación, emplee un destornillador de cabeza recta "-" para girar el selector de modo que la tensión correcta de su zona aparezca al lado del indicador del panel. El selector de tensión se ajusta a 240V cuando la unidad sale de fábrica.

Cuando haya seleccionado la tensión correcta, deslice el cable de alimentación por encima del panel trasero y conéctelo a la toma AC INLET (entrada de CA); a continuación, conecte el otro extremo del cable a una toma de corriente. En algunos países también podrá suministrarse un adaptador de clavija para permitir su conexión a las tomas de corriente locales.

⚠ CUIDADO

- Un ajuste incorrecto de la tensión podrá ocasionar daños graves al instrumento CVP-202 o provocar un funcionamiento defectuoso.

7 Asegúrese de ajustar el ajustador.

Para la estabilidad del aparato, se proporciona un ajustador en la parte inferior de la caja de pedales (C). Gire el ajustador hasta que contacte firmemente con el suelo. El ajustador asegura una operación estable de los pedales y facilita el control del efecto de los pedales. Si el ajustador no contacta firmemente con el suelo, puede resultar en sonido distorsionado.

■ Cuando haya concluido el montaje, compruebe los siguientes puntos:

- ¿Ha quedado alguna pieza sin instalar?
 - Revise el procedimiento de montaje y corrija cualquier error que se haya podido cometer.
- ¿Está el Clavinova alejado del recorrido de puertas y muebles?
 - Traslade el Clavinova a una posición adecuada.
- ¿Suena algún ruido de holgura cuando se mueve el Clavinova?
 - Apriete con firmeza todos los tornillos.
- ¿Vibra o cede la caja de pedales cuando se pisan los pedales?
 - Gire el estabilizador hasta que apoye firmemente sobre el suelo.
- ¿Están perfectamente insertados los cables de pedal y alimentación en los conectores?
 - Revise las conexiones.
- Si la unidad principal cruje o presenta algún signo de inestabilidad cuando se toca el teclado, consulte los esquemas de montaje y vuelva a apretar todos los tornillos.

Specifications / Technische Daten / Spécifications / Especificaciones

KEYBOARD	88 keys (A-1 — C7)
STONE GENERATOR	AWM (Advanced Wave Memory)
MAXIMUM SIMULTANEOUS POLYPHONY	64
VOICES	Clavinova voices: 243 XG voices: 480 Drum Kits: 14 sets Voice Groups: PIANO&HARPSI., E.PIANO, ORGAN&ACCORDION, PERCUSSION, GUITAR, BASS, BRASS, WOOD WIND, STRINGS, CHOIR&PAD, SYNTH., XG Dual, Split
EFFECTS	Reverb: 23 types Chorus: 15 types Effect: 92 types
ACCOMPANIMENT STYLES	Rhythm Styles: 134 Pianist Styles: 36 Custom Styles: 4 Style Groups: POP&ROCK, POPBALLADS, DANCE, SWING&JAZZ, R&B, COUNTRY, LATIN, MARCH&WORLD, WALTZ, BALLROOM, PIANIST, DISK/CUSTOM Controls: Intro, Main A, Main B, Main C, Main D, Auto-fill, Ending, Fade in/out, Synchro, Start/Stop, Tap, Metronome, Tempo -/+
AUTO ACCOMPANIMENT	Music Database: 463 Single Finger, Multi Finger, Fingered1, Fingered2, Full Keyboard, Harmony, One Touch Setting, Chord Assist, Synchro Stop, Individual Part Volume Control (Mixer)
REGISTRATION	Bank A — E x 4 memory locations (20), Freeze
SONG PLAY MODE	Song Playback, Repeat, Volume control of individual Parts (Mixer) Controls: Song, Play/Stop, Rewind, Fast forward, Pause Guide Control: Easy Play, Next Note, Sound Repeat Lyric Display, Piano Roll Display, Keyboard Guide Lamps
SONG RECORD MODE	Quick Recording, Track Recording, Chord Sequence, Song Name, Track Edit, Initial Edit, Setup Memory
LCD/CONTROLS	240 x 64 dot liquid crystal display, Contrast dial, Beat lamp, Function button, Mixer button, Page ◀ ▶ buttons, Direct Access button, LCD buttons, data dial, -/+ buttons, Exit button
VOLUME CONTROLS	Master volume, Acmp/Song volume
DEMO/HELP	50 Demo Songs; 5 help languages (English, Japanese, German, French, Spanish)
DISK DRIVE	3.5-inch micro floppy disk drive
PEDAL CONTROLS	RIGHT Damper CENTER Sostenuto LEFT Soft, Start/Stop, Harmony, Registration, Registration Freeze, Ending/rit, Break, Break Fill, Bass Hold, Fade In/Out, Effect Variation, Glide
JACKS AND TERMINALS	PHONES jacks x 2, AUX OUT jacks (L/L+R, R), AUX IN jacks (L/L+R, R), TO HOST terminal, MIDI terminals (IN, OUT, THRU)
INPUT/OUTPUT SPECIFICATIONS	AUX OUT: Output Impedance: 600 Ω AUX IN: Input Impedance: 10 kΩ; Input Sensitivity: -10 dBm
MAIN AMPLIFIERS	80W (40W x 2)
SPEAKERS	16cm x 2, 5cm x 2
DIMENSIONS (W x D x H)	Music rest down: 1394mm x 561mm x 845mm (54-7/8" x 22-1/16" x 33-1/4") Music rest up: 1394mm x 561mm x 1017mm (54-7/8" x 22-1/16" x 40-1/16")
WEIGHT	56.0kg (123lbs., 7oz.)

• Specifications and descriptions in this owner's manual are for information purposes only. Yamaha Corp. reserves the right to change or modify products or specifications at any time without prior notice. Since specifications, equipment or options may not be the same in every locale, please check with your Yamaha dealer.

• Die technischen Daten und Beschreibungen in dieser Bedienungsanleitung dienen nur der Information. Yamaha Corp. behält sich das Recht vor, Produkte oder deren technische Daten jederzeit ohne vorherige Ankündigung zu verändern oder zu modifizieren. Da die technischen Daten, das Gerät selbst oder Sonderzubehör nicht in jedem Land gleich sind, setzen Sie sich im Zweifel bitte mit Ihrem Yamaha-Händler in Verbindung.

• Les caractéristiques techniques et les descriptions du mode d'emploi ne sont données que pour information. Yamaha Corp. se réserve le droit de changer ou modifier les produits et leurs caractéristiques techniques à tout moment sans aucun avis. Du fait que les caractéristiques techniques, les équipements et les options peuvent différer d'un pays à l'autre, adressez-vous au distributeur Yamaha le plus proche.

• Las especificaciones y descripciones de este manual del propietario tienen sólo el propósito de servir como información. Yamaha Corp. se reserva el derecho a efectuar cambios o modificaciones en los productos o especificaciones en cualquier momento sin previo aviso. Puesto que las especificaciones, equipos u opciones pueden no ser las mismas en todos los mercados, solicite información a su distribuidor Yamaha.



Clavinova Web site (English only)

<http://www.yamahaclavinova.com/>

Yamaha Manual Library

<http://www2.yamaha.co.jp/manual/english/>

M.D.G., Pro Audio & Digital Musical Instrument Division, Yamaha Corporation
© 2003 Yamaha Corporation

WA54890 3??PO???.?-01A0 Printed in Indonesia