



AV Receiver

HTR-6066
TSR-6750

Owner's Manual

Read the supplied booklet "Safety Brochure" before using the unit.

English

CONTENTS

Accessories	5
-------------------	---

FEATURES 6

What you can do with the unit	6
-------------------------------------	---

Part names and functions	8
--------------------------------	---

Front panel	8
Front display (indicators)	9
Rear panel	10
Remote control	11

PREPARATIONS 12

General setup procedure	12
-------------------------------	----

1 Placing speakers	13
--------------------------	----

2 Connecting speakers	17
-----------------------------	----

Connecting front speakers that support bi-amp connections	19
---	----

Input/output jacks and cables	20
-------------------------------------	----

3 Connecting a TV	21
-------------------------	----

4 Connecting playback devices	26
-------------------------------------	----

Connecting video devices (such as BD/DVD players)	26
---	----

Connecting audio devices (such as CD players)	29
---	----

Connecting to the jacks on the front panel	29
--	----

5 Connecting the FM/AM antennas	30
---------------------------------------	----

6 Connecting to a network	31
---------------------------------	----

7 Connecting other devices	32
----------------------------------	----

Connecting recording devices	32
------------------------------------	----

Connecting a device compatible with the trigger function	32
--	----

8 Connecting the power cable	33
------------------------------------	----

9 Selecting an on-screen menu language	34
--	----

10 Optimizing the speaker settings automatically (YPAO)	35
---	----

Checking the measurement results	37
--	----

Reloading the previous YPAO adjustments	37
---	----

Error messages	38
----------------------	----

Warning messages	39
------------------------	----

PLAYBACK 40

Basic playback procedure	40
--------------------------------	----

Selecting the input source and favorite settings with one touch	
---	--

(SCENE)	41
---------------	----

Configuring scene assignments	41
-------------------------------------	----

Selecting the sound mode	42
--------------------------------	----

Enjoying stereoscopic sound fields (CINEMA DSP 3D)	43
--	----

Enjoying surround sound with headphones (SILENT CINEMA)	43
---	----

Enjoying unprocessed playback	46
-------------------------------------	----

Enjoying pure high fidelity sound (Pure Direct)	47
---	----

Enjoying compressed music with enhanced sound (Compressed Music Enhancer)	47
---	----

Listening to FM/AM radio	48
--------------------------------	----

Selecting a frequency for reception	48
---	----

Registering favorite radio stations (presets)	49
---	----

Radio Data System tuning	50
--------------------------------	----

Operating the radio on the TV	51
-------------------------------------	----

Playing back iPod music	53
-------------------------------	----

Connecting an iPod	53
--------------------------	----

Playback of iPod content	54
--------------------------------	----

Playing back music stored on a USB storage device	57
---	----

Connecting a USB storage device	57
---------------------------------------	----

Playback of USB storage device contents	57
---	----

Playing back music stored on media servers (PCs/NAS)	60
Media sharing setup	60
Playback of PC music contents	60
Listening to Internet radio	63
Playing back iTunes/iPod music via a network (AirPlay)	65
Playback of iTunes/iPod music contents	65
Playing back music in multiple rooms (multi-zone)	67
Preparing Zone2	67
Controlling Zone2	70
Viewing the current status	71
Switching information on the front display	71
Viewing the status information on the TV	71
Configuring playback settings for different playback sources (Option menu)	72
Option menu items	72

CONFIGURATIONS 75

Configuring input sources (Input menu)	75
Input menu items	75
Configuring the SCENE function (Scene menu)	77
Scene menu items	78
Configuring sound programs/surround decoders (Sound Program menu)	79
Sound Program menu items	80
Configuring various functions (Setup menu)	82
Setup menu items	83
Speaker (Manual Setup)	85
Sound	88
Video	89
HDMI	90
Network	92
Multi Zone	93

Function	94
ECO	96
Language	97

Viewing information about the unit (Information menu)	97
Types of information	98
Configuring the system settings (ADVANCED SETUP menu)	99
ADVANCED SETUP menu items	99
Changing the speaker impedance setting (SP IMP.)	99
Selecting the remote control ID (REMOTE ID)	99
Switching the video signal type (TV FORMAT)	100
Removing the limitation on HDMI video output (MON.CHK)	100
Restoring the default settings (INIT)	100
Updating the firmware (UPDATE)	100
Checking the firmware version (VERSION)	101
Controlling external devices with the remote control	102
Registering the remote control code for a TV	102
Registering the remote control codes for playback devices	103
Resetting remote control codes	104
Updating the unit's firmware via the network	105

APPENDIX 106

Frequently asked questions	106
Troubleshooting	107
Power, system and remote control	107
Audio	109
Video	110
FM/AM radio	111
USB and network	112
Error indications on the front display	113
Ideal speaker layout	114
Glossary	115
Audio information	115

HDMI and video information	116
Yamaha technologies	117
Video signal flow	118
Information on HDMI	119
HDMI Control	119
HDMI signal compatibility	120
Trademarks	121
Specifications	122
Index	125

Accessories

Check that the following accessories are supplied with the product.

Remote control

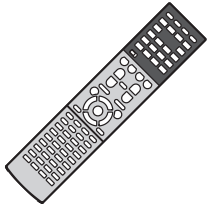

Batteries (AAA, R03, UM-4) (x2)

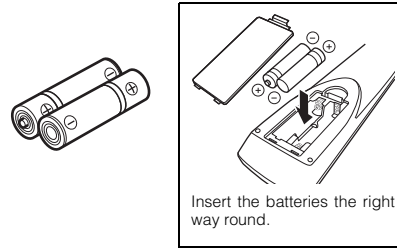

AM antenna



FM antenna

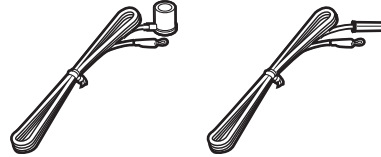

*One of the above is supplied depending on the region of purchase.

YPAO microphone

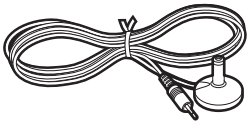

CD-ROM (Owner's Manual)

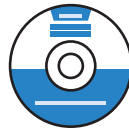

Easy Setup Guide





Safety Brochure

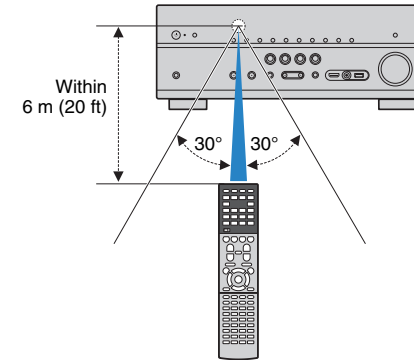

Operating range of the remote control

- Point the remote control at the remote control sensor on the unit and remain within the operating range shown below.



- Some features are not available in certain regions.
- Due to product improvements, specifications and appearance are subject to change without notice.
- This manual explains operations using the supplied remote control.
- This manual describes all the "iPod", "iPhone" and "iPad" as the "iPod". "iPod" refers to "iPod", "iPhone" and "iPad", unless otherwise specified.
-  indicates precautions for use of the unit and its feature limitations.
-  indicates supplementary explanations for better use.

FEATURES

What you can do with the unit

Wide variety of supported content

- iPod/iPhone/iPad ➔ p.53
- USB ➔ p.57
- Media server (PC/NAS) ➔ p.60
- Internet radio ➔ p.63
- AirPlay ➔ p.65

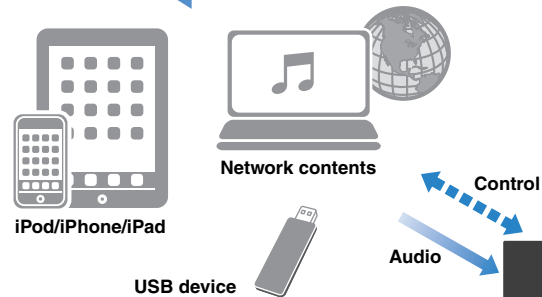

3D and 4K signals supported

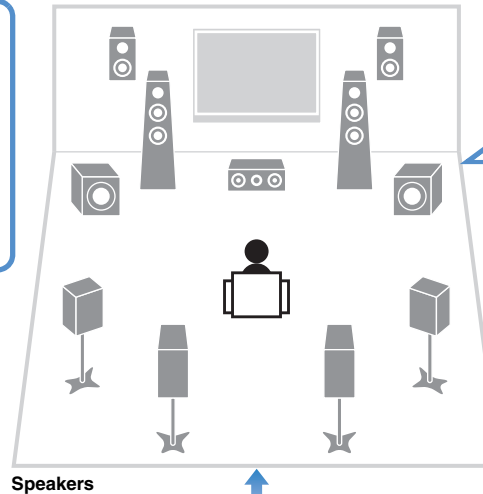
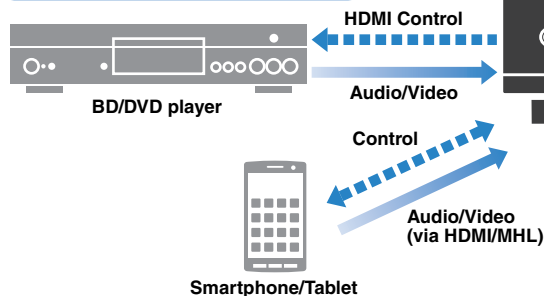

Supports 2- to 7.1-channel (plus presence) speaker system. Allows you to enjoy your favorite acoustic spaces in various styles.

- Automatically optimizing the speaker settings to suit your room (YPAO) ➔ p.35
- Reproducing stereo or multichannel sounds with the sound fields like actual movie theaters and concert halls (CINEMA DSP) ➔ p.43
- Enjoying compressed music with enhanced sound (Compressed Music Enhancer) ➔ p.47
- Playing back music in multiple rooms (multi-zone) ➔ p.67

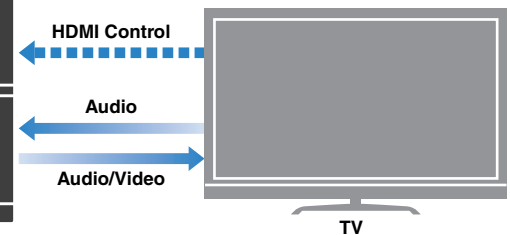
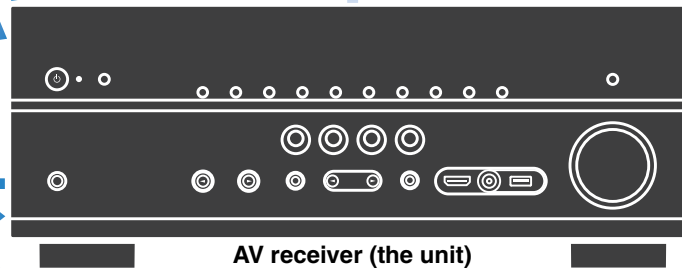

Change the input source and favorite settings with one touch (SCENE)

➔ p.41

Sequential operation of a TV, AV receiver, and BD/DVD player (HDMI Control)

➔ p.119



TV remote control

Full of useful functions!

❑ Connecting various devices (p.26)

A number of HDMI jacks and various input/output jacks on the unit allow you to connect video devices (such as BD/DVD players), audio devices (such as CD players), game consoles, camcorders, and other devices.

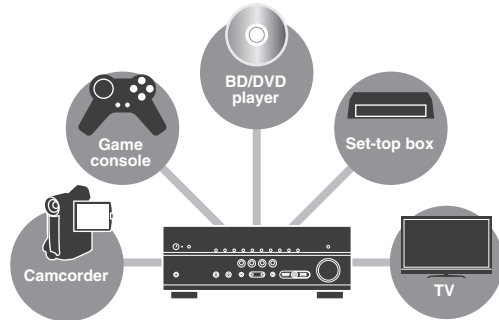

❑ Playing back TV audio in surround sound with a single HDMI cable connection (Audio Return Channel: ARC) (p.21)

When using an ARC-compatible TV, you only need one HDMI cable to enable video output to the TV, audio input from the TV, and the transmission of HDMI Control signals.

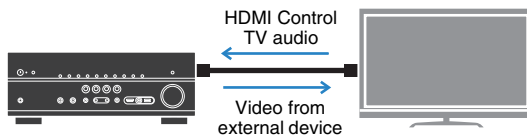

❑ Easy operation and wireless music playback from iPhone or Android device

By using the application for smartphone/tablet "AV CONTROLLER", you can control the unit from an iPhone, iPad, iPod touch or Android devices. Visit the Yamaha website for details.

❑ Creating 3-dimensional sound fields (p.43)

Connecting presence speakers allows you to create a natural 3-dimensional sound field in your own room (CINEMA DSP 3D). Even when no presence speakers are connected, the Virtual Presence Speaker (VPS) function produces 3D surround sound.

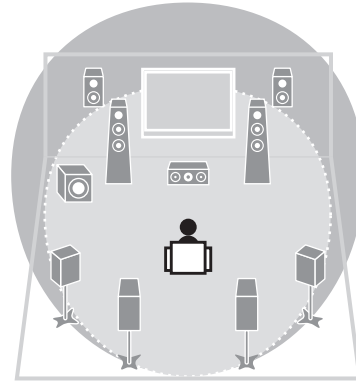

❑ Listening to FM/AM radio (p.48)

The unit is equipped with a built-in FM/AM tuner. You can register up to 40 favorite radio stations as presets.

❑ Enjoying pure high fidelity sound (p.47)

When the Pure Direct mode is enabled, the unit plays back the selected source with the least circuitry, which lets you to enjoy Hi-Fi sound quality.

❑ Easy operation with a TV screen

You can navigate through different types of content (such as iPod, USB, and network), view information, or easily configure the settings using the on-screen menu.

❑ Low power consumption

The ECO mode (power saving function) reduces the unit's power consumption (p.96).

Useful tips

The combination of video/audio input jacks does not match an external device...

Use "Audio In" in the "Input" menu to change the combination of video/audio input jacks so that it matches the output jack(s) of your external device (p.27).

Video and audio are not synchronized...

Use "Lipsync" in the "Setup" menu to adjust the delay between video and audio output (p.88).

I want to hear audio from the TV speakers...

Use "Audio Output" in the "Setup" menu to select the output destination of signals input into the unit (p.91). Your TV speakers may be selected as an output destination.

I want to use the supplied remote control to operate external devices...

Register the remote control codes of the external devices (such as a TV and BD/DVD players) (p.102).

I want to change the on-screen menu language...

Use "Language" in the "Setup" menu to select a language from English, Japanese, French, German, Spanish, Russian, Italian and Chinese (p.34).

I want to update the firmware...

Use "UPDATE" in the "ADVANCED SETUP" menu to update the unit's firmware (p.100). If the unit is connected to the Internet, a message will be displayed on the TV when a firmware update is available (p.105).

Many other settings are available that let you to customize the unit. For details, see the following pages.

- Input settings (p.75)
- SCENE settings (p.78)
- Sound program and surround decoder settings (p.80)
- Various function settings (p.83)
- Information view (such as audio signal and video signal) (p.98)
- System settings (p.99)

Part names and functions

Front panel

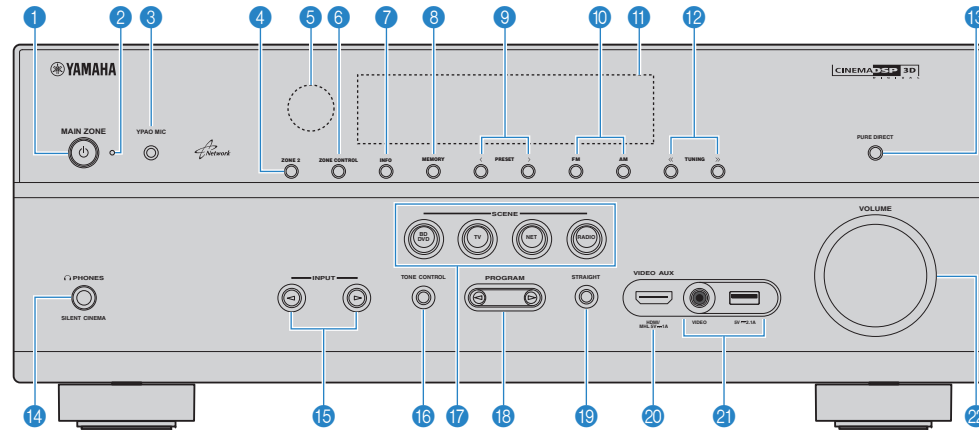

1 MAIN ZONE  key

Turns on/off (standby) the unit.

2 Standby indicator

Lights up when the unit is in standby mode under any of the following conditions.

- HDMI Control is enabled (p.90)
- Standby Through is enabled (p.91)
- Network Standby is enabled (p.92)
- An iPod is being charged (p.53)

3 YPAO MIC jack

For connecting the supplied YPAO microphone (p.35).

4 ZONE 2 key

Enables/disables the audio output to Zone2 (p.70).

5 Remote control sensor

Receives remote control signals (p.5).

6 ZONE CONTROL key

Changes the zone (main zone or the Zone2) that is controlled by the keys and knobs on the front panel (p.70).

7 INFO key

Selects the information displayed on the front display (p.71).

8 MEMORY key

Registers FM/AM radio stations as preset stations (p.49).

9 PRESET keys

Select a preset FM/AM radio station (p.49).

10 FM and AM keys

Switch between FM and AM (p.48).

11 Front display

Displays information (p.9).

12 TUNING keys

Select the radio frequency (p.48).

13 PURE DIRECT key

Enables/disables Pure Direct (p.47).

14 PHONES jack

For connecting headphones.

15 INPUT keys

Select an input source.

16 TONE CONTROL key

Adjusts the high-frequency range and low-frequency range of output sounds (p.73).

17 SCENE keys

Select the registered input source, sound program, and various settings with one touch. Also, turns on the unit when it is in standby mode (p.41).

18 PROGRAM keys

Select a sound program or a surround decoder (p.42).

19 STRAIGHT key

Enables/disables the straight decode mode (p.46).

20 VIDEO AUX (HDMI/MHL IN) jack

For connecting a device, such as a camcorder and a game console (p.29) or a smartphone (p.30).

21 USB jack

For connecting a USB storage device (p.57) or an iPod (p.53).

VIDEO jack

For inputting video when "USB" is selected as the input source (p.53).

22 VOLUME knob

Adjusts the volume.

Front display (indicators)

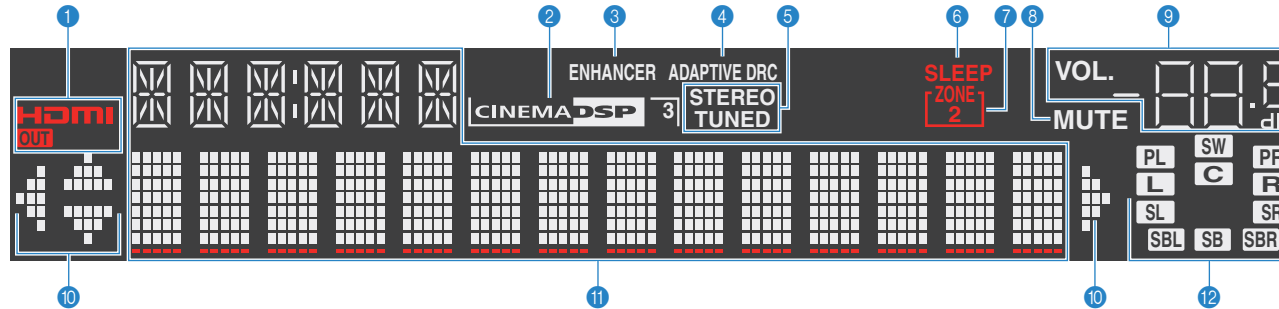

1 HDMI

Lights up when HDMI signals are being input or output.

OUT

Lights up when HDMI signals are being output.

2 CINEMA DSP

Lights up when CINEMA DSP (p.43) is working.

CINEMA DSP 3D

Lights up when CINEMA DSP 3D (p.43) is working.

3 ENHANCER

Lights up when Compressed Music Enhancer (p.47) is working.

4 ADAPTIVE DRC

Lights up when Adaptive DRC (p.73) is working.

5 STEREO

Lights up when the unit is receiving a stereo FM radio signal.

TUNED

Lights up when the unit is receiving an FM/AM radio station signal.

6 SLEEP

Lights up when the sleep timer is on.

7 ZONE 2

Lights up when audio output to Zone2 is enabled (p.70).

8 MUTE

Blinks when audio is muted.

9 Volume indicator

Indicates the current volume.

10 Cursor indicators

Indicate the remote control cursor keys currently operational.

11 Information display

Displays the current status (such as input name and sound mode name). You can switch the information by pressing INFO (p.71).

12 Speaker indicators

Indicate speaker terminals from which signals are output.

L Front speaker (L)

R Front speaker (R)

C Center speaker

SL Surround speaker (L)

SR Surround speaker (R)

SBL Surround back speaker (L)

SBR Surround back speaker (R)

SB Surround back speaker

PL Presence speaker (L)

PR Presence speaker (R)

SW Subwoofer

Rear panel

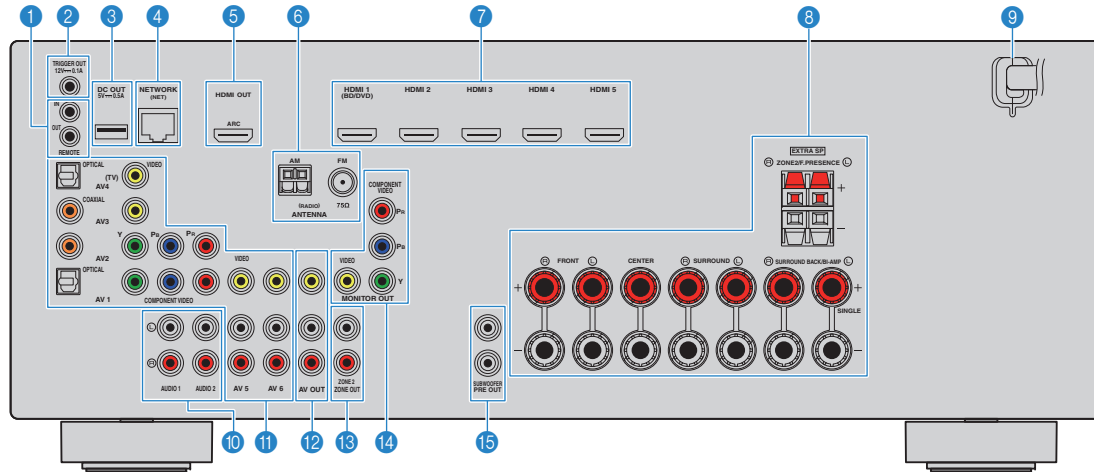

* The area around the video/audio output jacks is marked in white on the actual product to prevent improper connections.

1 REMOTE IN/OUT jacks

For connecting to an infrared signal receiver/emitter that allows you to operate the unit and other devices from another room (p.69).

2 TRIGGER OUT jack

For connecting to a device that supports the trigger function (p.32).

3 DC OUT jack

For connecting to an optional accessory.

4 NETWORK jack

For connecting to a network (p.31).

5 HDMI OUT jack

For connecting to an HDMI-compatible TV and outputting video/audio signals (p.21). When using ARC, TV audio signal can also be input through the HDMI OUT jack.

6 ANTENNA jacks

For connecting to FM and AM antennas (p.30).

7 HDMI 1–5 jacks

For connecting to HDMI-compatible playback devices and inputting video/audio signals (p.26).

8 SPEAKERS terminals

For connecting to speakers (p.17).

9 Power cable

For connecting to an AC wall outlet (p.33).

10 AUDIO 1–2 jacks

For connecting to audio playback devices and inputting audio signals (p.29).

11 AV 1–6 jacks

For connecting to video/audio playback devices and inputting video/audio signals (p.26).

12 AV OUT jacks

For outputting video/audio to a recording device (such as a VCR) (p.32).

13 ZONE2 OUT jacks

For connecting to the external amplifier used in Zone2 and for outputting audio (p.68).

14 MONITOR OUT jacks COMPONENT VIDEO jacks

For connecting to a TV that supports component video and outputting video signals (p.25).

VIDEO jack

For connecting to a TV that supports composite video and outputting video signals (p.25).

15 SUBWOOFER PRE OUT 1–2 jacks

For connecting to a subwoofer with built-in amplifier (p.19).

Remote control

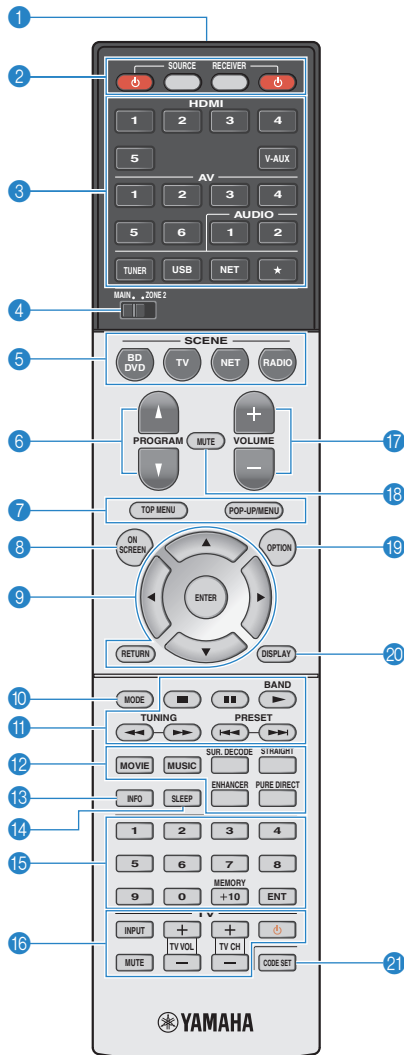

1 Remote control signal transmitter

Transmits infrared signals.

2 SOURCE key

Turns on/off an external device.

SOURCE key

Sets the remote control to operate external devices (p. 103). This key lights up in green after pressed.

RECEIVER key

Sets the remote control to operate the unit (p.103). This key lights up in orange after pressed.

RECEIVER key

Turns on/off (standby) the unit.

3 Input selection keys

Select an input source for playback.

HDMI 1-5 HDMI 1-5 jacks

V-AUX VIDEO AUX jack (on the front panel)

AV 1-6 AV 1-6 jacks

AUDIO 1-2 AUDIO 1-2 jacks

TUNER FM/AM radio

USB USB jack (on the front panel)

NET NETWORK jack (press repeatedly to select a desired network source)

★ Changes the external device to be controlled without switching the input source.

4 MAIN/ZONE2 switch

Changes the zone (main zone or Zone2) that is controlled by the remote control (p.70).

5 SCENE keys

Select the registered input source, sound program, and various settings with one touch. Also, turns on the unit when it is in standby mode (p.41).

6 PROGRAM keys

Select a sound program (p.42).

7 External device operation keys

Select menus for external devices (p.103).

8 ON SCREEN key

Displays the on-screen menu on the TV.

9 Menu operation keys

Cursor keys Select a menu or a parameter.

ENTER Confirms a selected item.

RETURN Returns to the previous screen.

10 MODE key

Switches the iPod operation modes (p.55).

11 Radio keys

Operate the FM/AM radio when "TUNER" is selected as the input source (p.48).

BAND Switches between FM and AM radio.

PRESET Select a preset station.

TUNING Select the radio frequency.

External device operation keys

Let you play back and perform other operations for external devices when an input source other than "TUNER" is selected (p.103).

12 Sound mode keys

Select a sound mode (p.42).

13 INFO key

Selects the information displayed on the front display (p.71).

14 SLEEP key

Switches the unit to standby mode automatically after a specified period of time has elapsed (sleep timer). Press repeatedly to set the time (120 min, 90 min, 60 min, 30 min, off).

15 Numeric keys

Let you enter numerical values, such as radio frequencies.

MEMORY key

Registers FM/AM radio stations as presets (p.49).

16 TV operation keys

Let you select TV input and volume, and perform other TV operations (p.102).

17 VOLUME keys

Adjust the volume.

18 MUTE key

Mutes the audio output.

19 OPTION key

Displays the option menu (p.72).

20 DISPLAY key

Displays status information on the TV (p.71).

21 CODE SET key

Registers remote control codes of external devices on the remote control (p.102).



- To operate external devices with the remote control, register a remote control code for each device before using (p.102).

PREPARATIONS

General setup procedure

- 1 Placing speakers (p.13)** Select the speaker layout for the number of speakers that you are using and place them in your room.
- 2 Connecting speakers (p.17)** Connect the speakers to the unit.
- 3 Connecting a TV (p.21)** Connect a TV to the unit.
- 4 Connecting playback devices (p.26)** Connect video devices (such as BD/DVD players) and audio devices (such as CD players) to the unit.
- 5 Connecting the FM/AM antennas (p.30)** Connect the supplied FM/AM antennas to the unit.
- 6 Connecting to a network (p.31)** Connect the unit to a network.
- 7 Connecting other devices (p.32)** Connect external devices, such as recording devices.
- 8 Connecting the power cable (p.33)** After all the connections are complete, plug in the power cable.
- 9 Selecting an on-screen menu language (p.34)** Select the desired on-screen menu language (default: English).
- 10 Optimizing the speaker settings automatically (YPAO) (p.35)** Optimize the speaker settings, such as volume balance and acoustic parameters, to suit your room (YPAO).

This completes all the preparations. Enjoy playing movies, music, radio and other content with the unit!

1 Placing speakers

Select the speaker layout for the number of speakers that you are using and place the speakers and subwoofer (with built-in amplifier) in your room. This section describes the representative speaker layout examples.

Caution

- Under its default settings, the unit is configured for 8-ohm speakers. When connecting 6-ohm speakers, set the unit's speaker impedance to "6 Ω MIN". In this case, you can also use 4-ohm speakers as the front speakers. For details, see "Setting the speaker impedance" (p.16).

Speaker type	Abbr.	Function	Speaker system (the number of channels)									
			7.1+2	7.1	7.1	6.1	5.1	Front 5.1	4.1	3.1	2.1	
Front (L)	FL	Produce front right/left channel sounds (stereo sounds).	●	●	●	●	●	●	●	●	●	●
Front (R)	FR		●	●	●	●	●	●	●	●	●	●
Center	C	Produces center channel sounds (such as movie dialogue and vocals).	●	●	●	●	●	●		●		
Surround (L)	SL	Produce surround right/left channel sounds. Surround speakers also produce surround back channel sounds when no surround back speakers are connected.	●	●	●	●	●			●		
Surround (R)	SR		●	●	●	●	●			●		
Surround back (L)	SBL	Produce surround back left/right channel sounds.	●	●								
Surround back (R)	SBR		●	●								
Surround back	SB	Produces sounds mixed from surround back left/right channel sounds.				●						
Presence (L)	PL	Produce CINEMA DSP effect sounds. In combination with CINEMA DSP 3D (p.43), the presence speakers create a natural 3-dimensional sound field in your room.	●		●			●				
Presence (R)	PR		●		●			●				
Subwoofer	SW	Produces LFE (low-frequency effect) channel sounds and reinforces the bass parts of other channels. This channel is counted as "0.1". You can connect 2 subwoofers (with built-in amplifier) to the unit.	●	●	●	●	●	●	●	●	●	●



- For information on the ideal speaker layout, see "Ideal speaker layout" (p.114).
- If you have seven speakers, use two of them as surround back speakers or presence speakers. To reinforce the rear right/left sounds, use them as surround back speakers. To create a natural 3-dimensional sound field, use them as presence speakers.
- Two subwoofers connected to the unit output the same sounds.

7.1+2-channel system

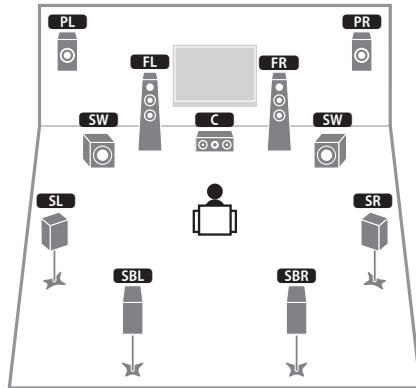

- The surround back speakers and presence speakers do not produce sounds simultaneously. The unit automatically changes the speakers to be used, depending on the selected CINEMA DSP (p.43).

7.1-channel system (using presence speakers)

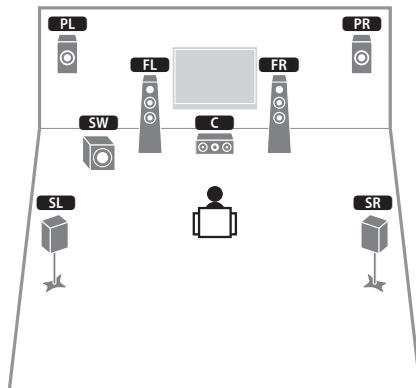

This speaker system uses the front presence speakers to produce a natural 3-dimensional sound field, and is suited for enjoying 5.1-channel contents.

7.1-channel system (using surround back speakers)

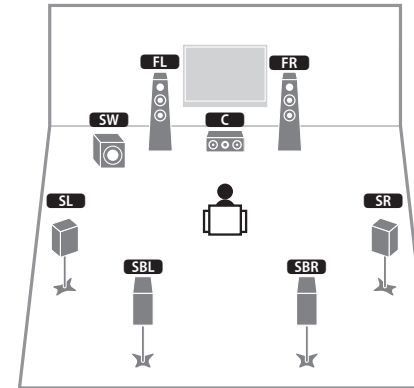

This speaker system creates Virtual Presence Speaker (VPS) using the front, center and surround speakers to produce a 3-dimensional sound field, and also allows you to enjoy extended surround sounds using the surround back speakers.

6.1-channel system

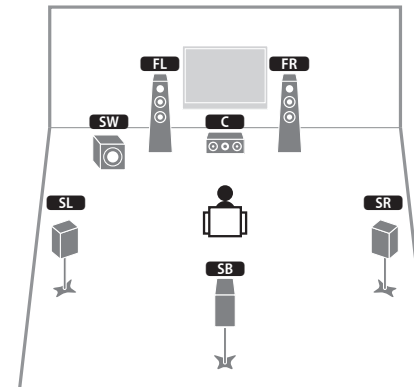

This speaker system creates Virtual Presence Speaker (VPS) using the front, center and surround speakers to produce a 3-dimensional sound field, and also allows you to enjoy extended surround sounds using the surround back speaker.

5.1-channel system

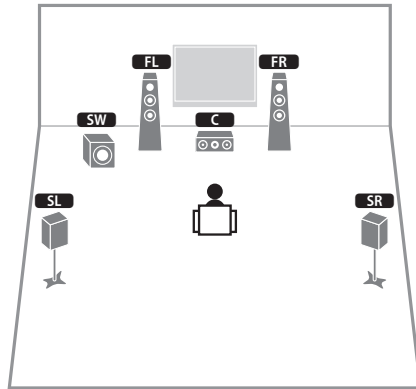

This speaker system creates Virtual Presence Speaker (VPS) using the front, center and surround speakers to produce a 3-dimensional sound field, and is suited for enjoying 5.1-channel contents.

Front 5.1-channel system

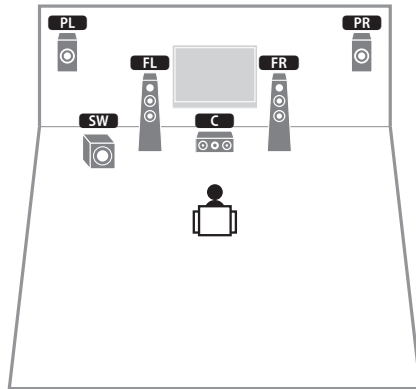

This speaker system uses the front presence speakers to produce a natural 3-dimensional sound field, and creates the virtual surround speakers using the front speakers to allow you to enjoy multi-channel surround sound (Virtual CINEMA DSP).

4.1-channel system

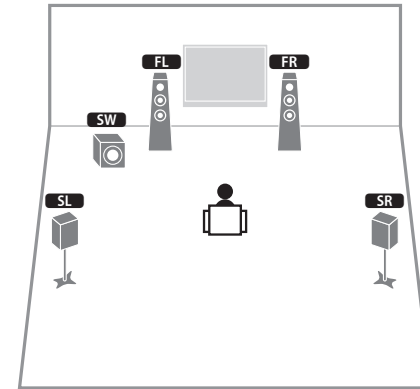

2.1-channel system

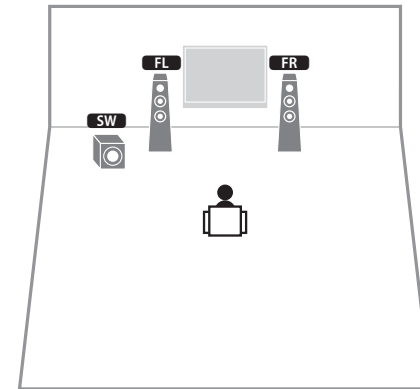

Even when no surround speakers are connected, the unit creates the virtual surround speakers using the front speakers to allow you to enjoy multi-channel surround sound (Virtual CINEMA DSP).



- Add the center speaker to configure a 3.1-channel system.

■ Setting the speaker impedance

Under its default settings, the unit is configured for 8-ohm speakers. When connecting 6-ohm speakers, set the speaker impedance to “6 Ω MIN”. In this case, you can also use 4-ohm speakers as the front speakers.

1 Before connecting speakers, connect the power cable to an AC wall outlet.

2 While holding down STRAIGHT on the front panel, press MAIN ZONE .

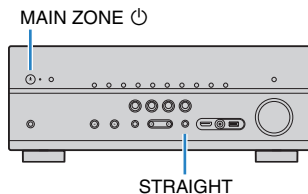

3 Check that “SP IMP.” is displayed on the front display.



4 Press STRAIGHT to select “6 Ω MIN”.

5 Press MAIN ZONE  to set the unit to standby mode and remove the power cable from the AC wall outlet.

You are now ready to connect the speakers.

2 Connecting speakers

Connect the speakers placed in your room to the unit. The following diagrams provide connections for 7.1+2-, 7.1-, and 6.1-channel systems as examples. For other systems, connect speakers while referring to the connection diagram for the 6.1-channel system.

Caution

- Remove the unit's power cable from an AC wall outlet and turn off the subwoofer before connecting the speakers.
- Ensure that the core wires of the speaker cable do not touch one another or come into contact with the unit's metal parts. Doing so may damage the unit or the speakers. If the speaker cables short circuit, "Check SP Wires" will appear on the front display when the unit is turned on.

Cables required for connection (commercially available)

Speaker cables (x the number of speakers)



Audio pin cable (two for connecting two subwoofers)



7.1+2-channel system

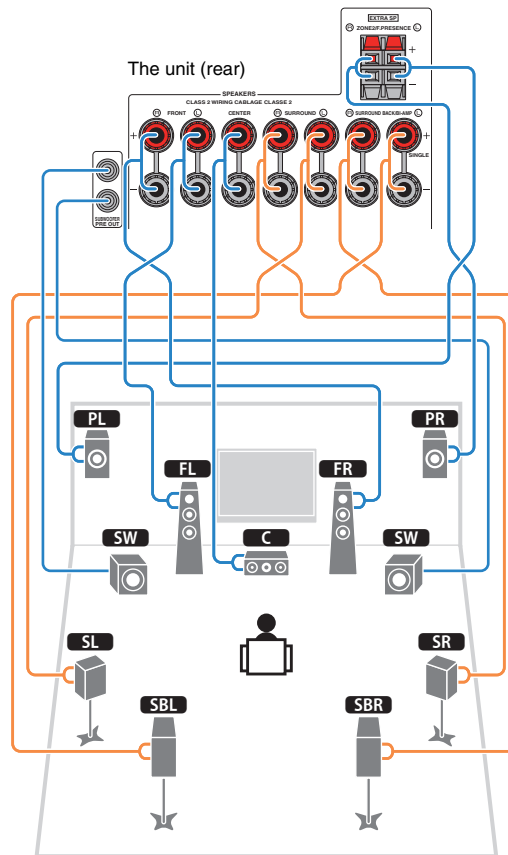

7.1-channel system (using surround back speakers)

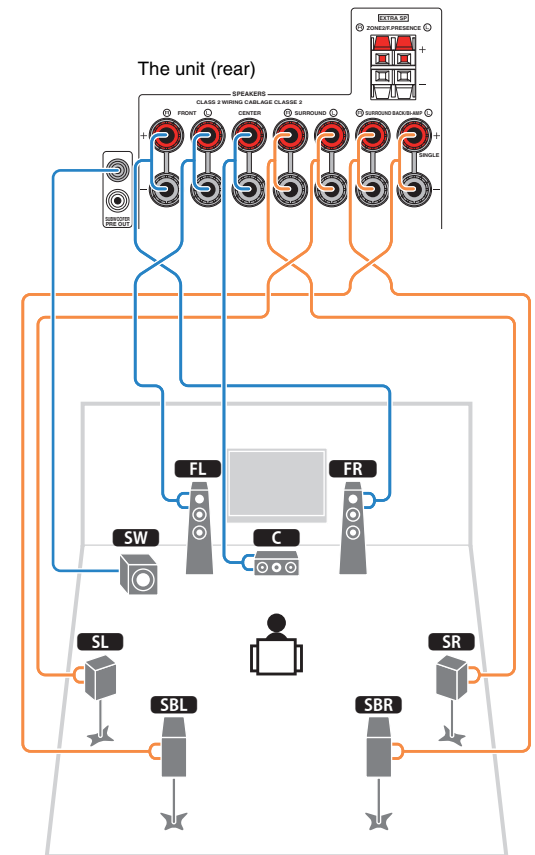

7.1-channel system (using presence speakers)

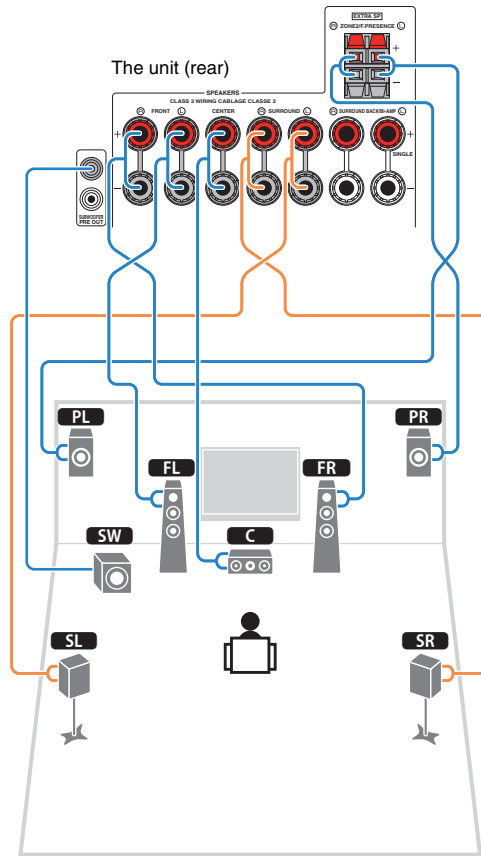

6.1-channel system

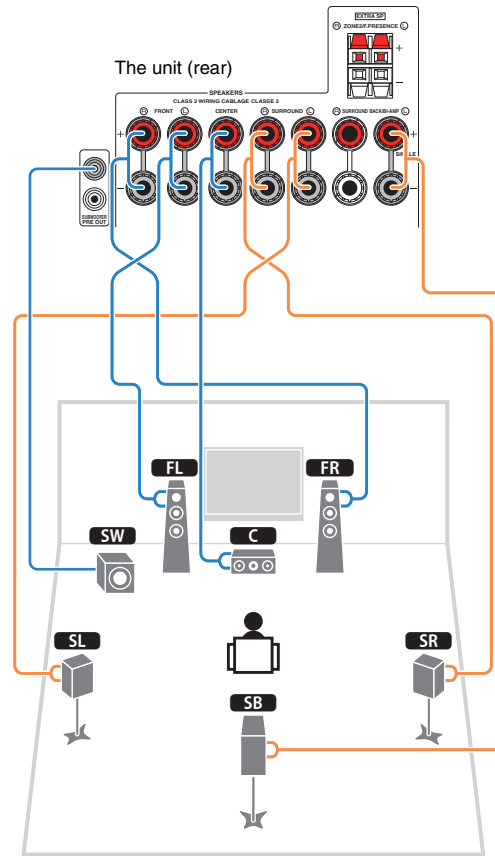

When using only one surround back speaker, connect it to the SINGLE jack (L side).

■ Connecting speaker cables

Speaker cables have two wires. One is for connecting the negative (-) terminal of the unit and the speaker, and the other is for the positive (+) terminal. If the wires are colored to prevent confusion, connect the black wire to the negative and the other wire to the positive terminal.

- ① Remove approximately 10 mm (3/8") of insulation from the ends of the speaker cable and twist the bare wires of the cable firmly together.
- ② Loosen the speaker terminal.
- ③ Insert the bare wires of the cable into the gap on the side (upper right or bottom left) of the terminal.
- ④ Tighten the terminal.

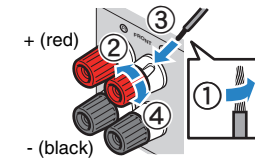

Using a banana plug

(U.S.A. and Australia models only)

- ① Tighten the speaker terminal.
- ② Insert a banana plug into the end of the terminal.

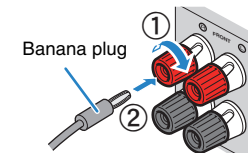

Push-type speaker terminals

- ① Remove approximately 10 mm (3/8") of insulation from the ends of the speaker cable, and twist the bare wires of the cable firmly together.
- ② Press down the tab.
- ③ Insert the bare wires of the cable into the hole in the terminal.
- ④ Release the tab.

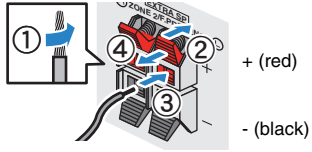

■ Connecting the subwoofer

Use an audio pin cable to connect the subwoofer.

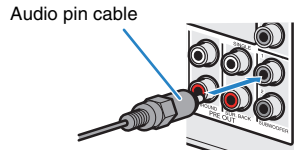

Connecting front speakers that support bi-amp connections

When using front speakers that support bi-amp connections, connect them to the FRONT jacks and SURROUND BACK/BI-AMP jacks.

To enable the bi-amp function, set "Power Amp Assign" (p.85) in the "Setup" menu to "5ch BI-AMP" after connecting the power cable to an AC wall outlet.

Caution

- Before making bi-amp connections, remove any brackets or cables that connect a woofer with a tweeter. Refer to the instruction manual of the speakers for details. If you are not making bi-amp connections, make sure that the brackets or cables are connected before connecting the speaker cables.
- Surround back speakers cannot be used during bi-amp connections.

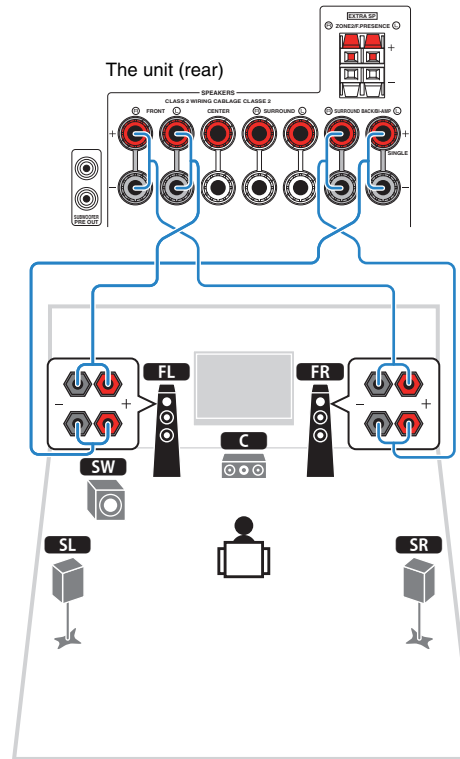

- The FRONT jacks and SURROUND BACK/BI-AMP/ZONE B jacks output the same signals.

Input/output jacks and cables

Video/audio jacks

HDMI jacks

Transmit digital video and digital sound through a single jack. Use an HDMI cable.

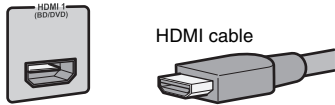

- Use a 19-pin HDMI cable with the HDMI logo. We recommend using a cable less than 5.0 m (16.4 ft) long to prevent signal quality degradation.



- The unit's HDMI jacks support the HDMI Control, Audio Return Channel (ARC), and 3D and 4K video transmission features.
- Use high speed HDMI cables to enjoy 3D or 4K videos.

HDMI/MHL jack

Transmits digital video and digital sound. Use an MHL cable.

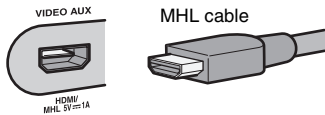

- The VIDEO AUX jack on the front panel of the unit supports both HDMI and MHL connections. Use a cable that matches the jack on your MHL-compatible mobile device. When connecting an HDMI-compatible playback device to the VIDEO AUX jack, use an HDMI cable. For details on an MHL connection, see "MHL connection" (p.30).

Video jacks

COMPONENT VIDEO jacks

Transmit video signals separated into three components: luminance (Y), chrominance blue (Pb), and chrominance red (Pr). Use a component video cable with three plugs.

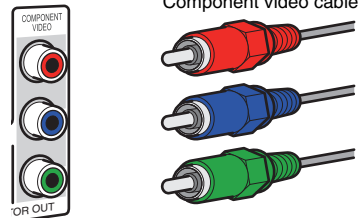

VIDEO jacks

Transmit analog video signals. Use a video pin cable.

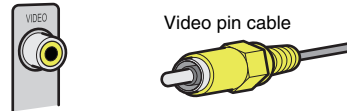

Audio jacks

OPTICAL jacks

Transmit digital audio signals. Use a digital optical cable. Remove the tip protector (if available) before using the cable.



COAXIAL jacks

Transmit digital audio signals. Use a digital coaxial cable.



AUDIO jacks

Transmit analog stereo audio signals. Use a stereo pin cable (RCA cable).

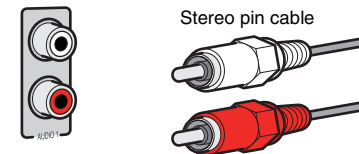

3 Connecting a TV

Connect a TV to the unit so that video input to the unit can be output to the TV. You can also enjoy playback of TV audio on the unit. The connection method varies depending on the functions and video input jacks available on your TV. Refer to the instruction manual of the TV and choose a connection method.

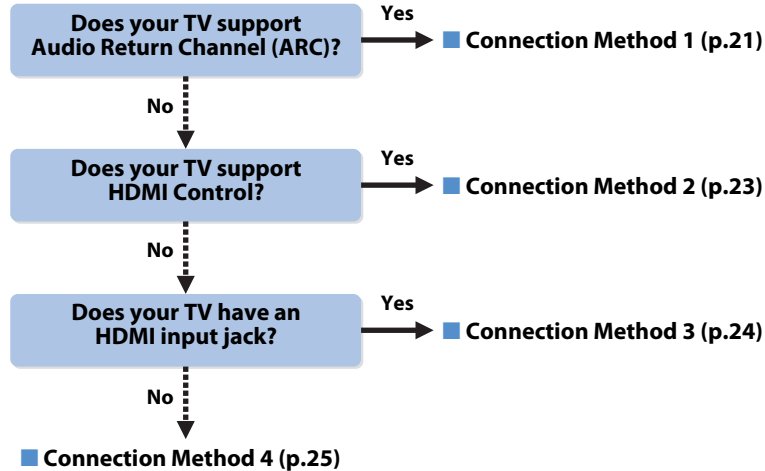

About HDMI Control

HDMI Control allows you to operate external devices via HDMI. If you connect a TV that supports HDMI Control to the unit with an HDMI cable, you can control the unit's power and volume with the TV's remote control. You can also control playback devices (such as an HDMI Control-compatible BD/DVD player) connected to the unit with an HDMI cable. For details, see "HDMI Control" (p.119).

About Audio Return Channel (ARC)

ARC allows audio signals to travel both ways under HDMI Control. If you connect a TV that supports HDMI Control and ARC to the unit with a single HDMI cable, you can output video/audio to the TV or input TV audio to the unit.

Connection Method 1 (HDMI Control/ARC-compatible TV)

Connect the TV to the unit with an HDMI cable.



- The following explanation is based on the assumption that you have not changed the "HDMI" parameters (p.90) in the "Setup" menu.
- Use an HDMI cable that supports ARC.

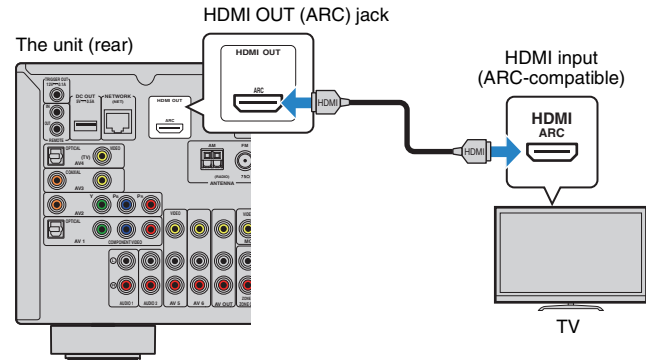

- By connecting a TV to the unit with an HDMI cable, any video input to the unit can be output to the TV (except some component video signals), regardless of the method used to connect the video device to the unit. For details, see "Video signal flow" (p.118).
- By connecting a TV to the unit with an HDMI cable, you can navigate the iPod, USB storage device and network sources, or configure the settings of the unit with the menu displayed on the TV.

□ Necessary settings

To use HDMI Control and ARC, you need to configure the following settings.
For details on settings and operating your TV, refer to the instruction manual for the TV.

1 After connecting external devices (such as a TV and playback devices) and the power cable to the unit, turn on the unit, TV, and playback devices.

2 Configure the settings of the unit.

- ① Check that ARC is enabled on the TV.
- ② Switch the TV input to display video from the unit.
- ③ Press ON SCREEN.

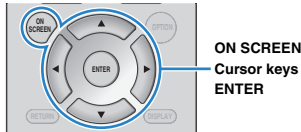

- ④ Use the cursor keys to select “Setup” and press ENTER.

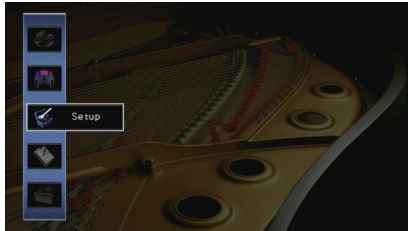

- ⑤ Use the cursor keys (</>) to select “HDMI”.



- ⑥ Use the cursor keys (Δ/▽) to select “HDMI Control” and press ENTER.
- ⑦ Use the cursor keys to select “On”.
- ⑧ Press ON SCREEN.

3 Configure the settings for HDMI Control.

- ① Enable HDMI Control on the TV and playback devices (such as HDMI Control-compatible BD/DVD player).
- ② Turn off the TV's main power and then turn off the unit and playback devices.
- ③ Turn on the unit and playback devices and then turn on the TV's main power.
- ④ Switch the TV input to display video from the unit.
- ⑤ Check the following.

On the unit: The input to which the playback device is connected is selected. If not, select the input source manually.

On the TV: The video from the playback device is displayed.

- ⑥ Check that the unit is properly synchronized with the TV by turning off the TV or adjusting the TV volume with the TV remote control.

This completes the necessary settings.

If you select a TV program with the TV remote control, the input source of the unit will be automatically switched to “AV 4” and the TV audio will be played back on the unit.

If you cannot hear the TV's audio, check that “ARC” (p.91) in the “Setup” menu is set to “On”.



- If HDMI Control does not work properly, try turning off and on (or unplugging and then plugging in again) the devices. It may solve the problem.
- If the unit is not synchronized to the TV's power operations, check the priority of the audio output setting on the TV.
- If the audio is interrupted while using ARC, set “ARC” (p.91) in the “Setup” menu to “Off” and use a digital optical cable to input TV audio to the unit (p.23).



- “AV 4” is set as TV audio input at the factory. If you have connected any external device to the AV 4 jacks, use “TV Audio Input” (p.90) in the “Setup” menu to change the TV audio input assignment. To use the SCENE function (p.41), you also need to change the input assignment for SCENE(TV).

■ Connection Method 2 (HDMI Control-compatible TV)

Connect the TV to the unit with an HDMI cable and a digital optical cable.



- The following explanation is based on the assumption that you have not changed the “HDMI” parameters (p.90) in the “Setup” menu.

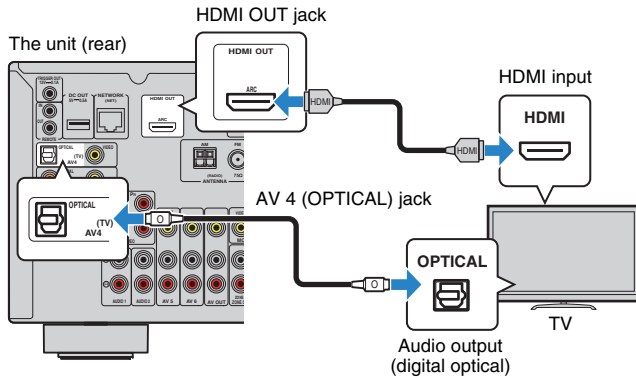

- By connecting a TV to the unit with an HDMI cable, any video input to the unit can be output to the TV (except some component video signals), regardless of the method used to connect the video device to the unit. For details, see “Video signal flow” (p.118).
- By connecting a TV to the unit with an HDMI cable, you can navigate the iPod, USB storage device and network sources, or configure the settings of the unit with the menu displayed on the TV.

□ Necessary settings

To use HDMI Control, you need to configure the following settings.

For details on settings and operating your TV, refer to the instruction manual for the TV.

1 After connecting external devices (such as a TV and playback devices) and power cable of the unit, turn on the unit, TV, and playback devices.

2 Configure the settings of the unit.

- ① Switch the TV input to display video from the unit.
- ② Press ON SCREEN.

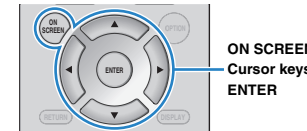

- ③ Use the cursor keys to select “Setup” and press ENTER.

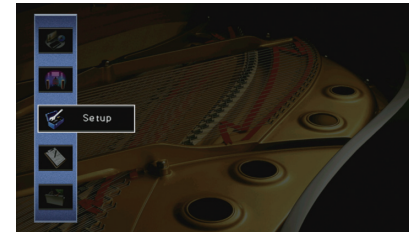

- ④ Use the cursor keys (</>) to select “HDMI”.



- ⑤ Use the cursor keys (Δ/▽) to select “HDMI Control” and press ENTER.
- ⑥ Use the cursor keys to select “On”.
- ⑦ Press ON SCREEN.

3 Configure the settings for HDMI Control.

- ① Enable HDMI Control on the TV and playback devices (such as a HDMI Control-compatible BD/DVD player).
- ② Turn off the TV's main power and then turn off the unit and playback devices.
- ③ Turn on the unit and playback devices and then turn on the TV.
- ④ Switch the TV input to display video from the unit.
- ⑤ Check the following.

On the unit: The input to which the playback device is connected is selected. If not, select the input source manually.

On the TV: The video from the playback device is displayed.

- ⑥ Check that the unit is properly synchronized with the TV by turning off the TV or adjusting the TV volume with the TV remote control.

This completes the necessary settings.

If you select a TV program with the TV remote control, the input source of the unit will be automatically switched to "AV 4" and the TV audio will be played back on the unit.



- If HDMI Control does not work properly, try turning off and on (or unplugging and then plugging in again) the devices. It may solve the problem.
- If the unit is not synchronized to the TV's power operations, check the priority of the audio output setting on the TV.



- "AV 4" is set as TV audio input at the factory. If you have connected any external device to the AV 4 jacks or if you want to use another input jack (other than OPTICAL) for connecting the TV, use "TV Audio Input" (p.90) in the "Setup" menu to change the TV audio input assignment. To use the SCENE function (p.41), you also need to change the input assignment for SCENE(TV).

■ Connection Method 3 (TV with HDMI input jacks)

Connect the TV to the unit with an HDMI cable and a digital optical cable.

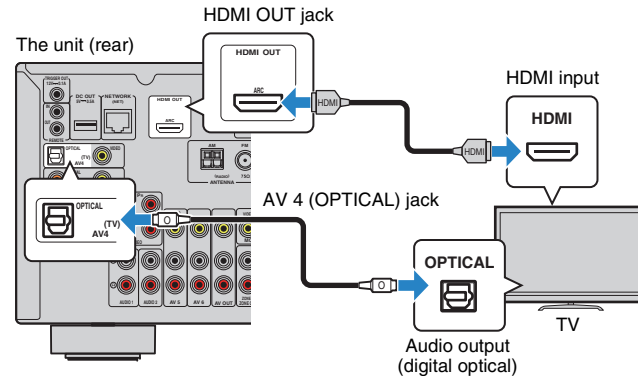

If you switch the input source of the unit to "AV 4" using the AV 4 or SCENE(TV) keys, the TV audio will be played back on the unit.



- By connecting a TV to the unit with an HDMI cable, any video input to the unit can be output to the TV (except some component video signals), regardless of the method used to connect the video device to the unit. For details, see "Video signal flow" (p.118).
- By connecting a TV to the unit with an HDMI cable, you can navigate the iPod, USB storage device and network sources, or configure the settings of the unit with the menu displayed on the TV.
- If you have connected any external device to the AV 4 jacks or if you want to use another input jack (other than OPTICAL) for connecting the TV, connect the TV to one of the AV 1–6 and AUDIO 1–2 jacks. To use the SCENE function (p.41), you also need to change the input assignment for SCENE(TV).

■ Connection Method 4 (TV without HDMI input jacks)

When connecting any video device to the AV 1–2 (COMPONENT VIDEO) jacks of the unit, connect the TV to the MONITOR OUT (COMPONENT VIDEO) jacks.

When connecting any video device to the AV 3–6 (VIDEO) jacks or the front VIDEO jack of the unit, connect the TV to the MONITOR OUT (VIDEO) jack.

If you select “AV 4” as the input source by pressing AV 4 or SCENE(TV), the TV audio will be played back on the unit.



- If you connect your TV to the unit with a cable other than HDMI, video input to the unit via HDMI cannot be output to the TV.
- Operations with TV screen are available only when your TV is connected to the unit via HDMI.



- If you have connected any external device to the AV 4 jacks or if you want to use another input jack (other than OPTICAL) for connecting the TV, connect the TV to one of the AV 1–6 and AUDIO 1–2 jacks. To use the SCENE function (p.41), you also need to change the input assignment for SCENE(TV).

□ COMPONENT VIDEO connection (with a component video cable)

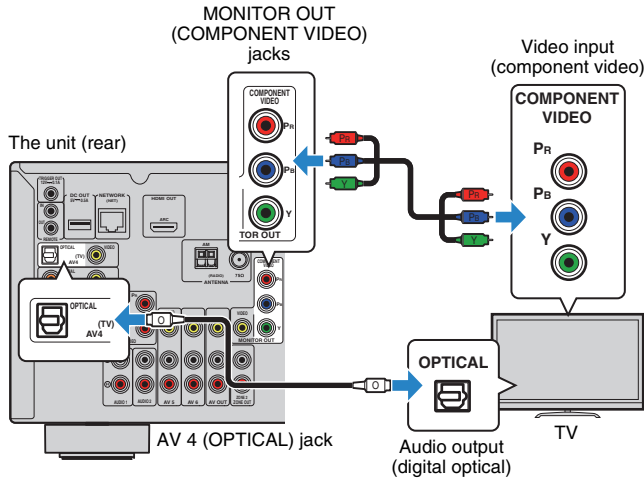

□ VIDEO (composite video) connection (with a video pin cable)

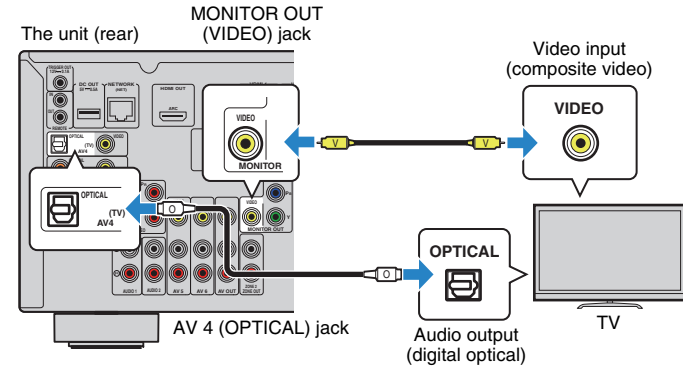

4 Connecting playback devices

The unit is equipped with a variety of input jacks including HDMI input jacks to allow you to connect different types of playback devices. For information on how to connect an iPod or a USB storage device, see the following pages.

- Connecting an iPod (p.53)
- Connecting a USB storage device (p.57)

Connecting video devices (such as BD/DVD players)

Connect video devices such as BD/DVD players, set-top boxes (STBs) and game consoles to the unit. Depending on the video/audio output jacks available on your video device, choose one of the following connections. We recommend using an HDMI connection if the video device has an HDMI output jack.



- If the combination of video/audio input jacks available on the unit does not match your video device, change its combination according to the output jacks of your device (p.27).

HDMI connection

Connect a video device to the unit with an HDMI cable.

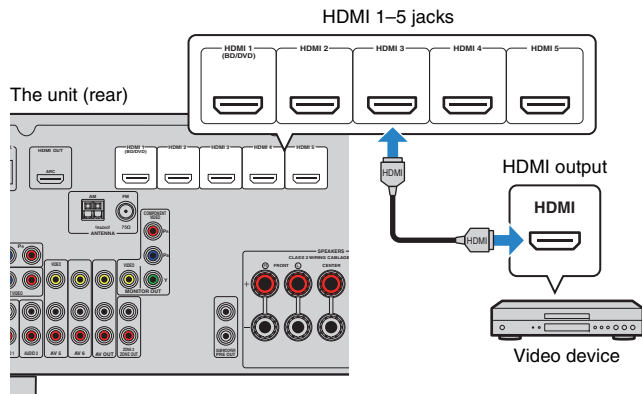

If you select the input source by pressing HDMI 1-5, the video/audio played back on the video device will be output from the unit.



- To watch videos input to the HDMI 1-5 jacks, you need to connect your TV to the HDMI OUT jack of the unit (p.21 to 24).

Component video connection

Connect a video device to the unit with a component video cable and an audio cable (digital optical or digital coaxial). Choose a set of input jacks (on the unit) depending on the audio output jacks available on your video device.

Output jacks on video device		Input jacks on the unit
Video	Audio	
Component video	Digital optical	AV 1 (COMPONENT VIDEO + OPTICAL)
	Digital coaxial	AV 2 (COMPONENT VIDEO + COAXIAL)

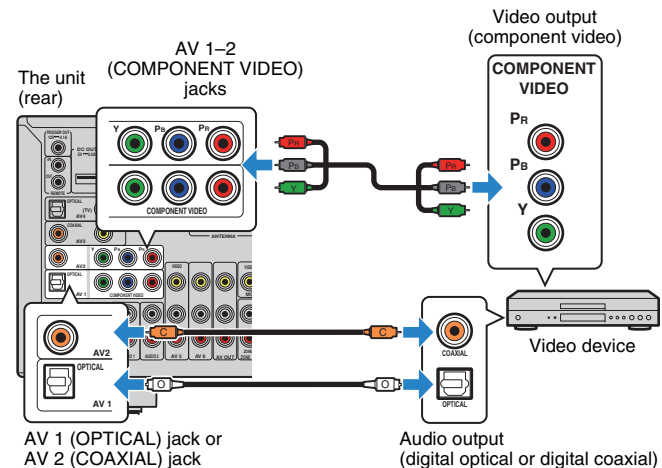

If you select the input source by pressing AV 1-2, the video/audio played back on the video device will be output from the unit.



- The component video signals (other than 480i/576i signals) input to AV 1-2 jacks of the unit can be output from the MONITOR OUT (COMPONENT VIDEO) jacks only. To watch those videos, you need to connect your TV to the MONITOR OUT (COMPONENT VIDEO) jacks of the unit (p.25).

■ Composite video connection

Connect a video device to the unit with a video pin cable and an audio cable (digital coaxial, digital optical, or stereo pin cable). Choose a set of input jacks (on the unit) depending on the audio output jacks available on your video device.

Output jacks on video device		Input jacks on the unit
Video	Audio	
Composite video	Digital coaxial	AV 3 (VIDEO + COAXIAL)
	Digital optical	AV 4 (VIDEO + OPTICAL)
	Analog stereo	AV 5-6 (VIDEO + AUDIO)

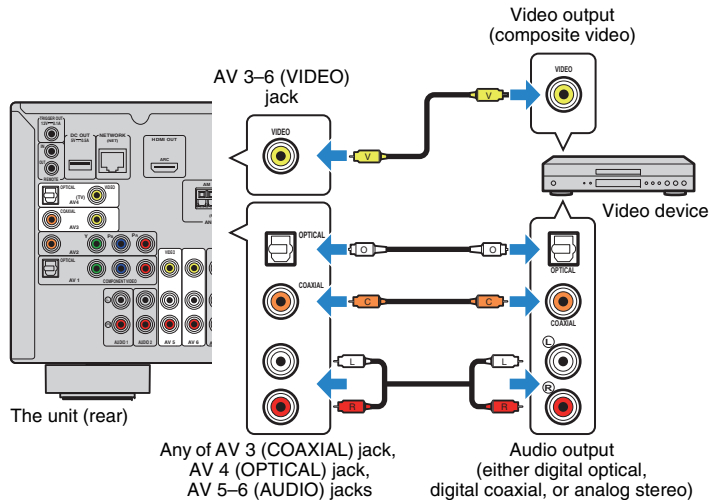

If you select the input source by pressing AV 3-6, the video/audio played back on the video device will be output from the unit.



- To watch videos input to the AV 3-6 (VIDEO) jacks, you need to connect your TV to the HDMI OUT jack (p.21 to 24) or to the MONITOR OUT (VIDEO) jack (p.25) of the unit.

■ Changing the combination of video/audio input jacks

If the combination of video/audio input jacks available on the unit does not match your video device, change its combination according to the output jacks of your device. You can connect a video device that has the following video/audio output jacks.

Output jacks on video device		Input jacks on the unit	
Video	Audio	Video	Audio
HDMI	Digital optical	HDMI 1-5	AV 1 (OPTICAL) AV 4 (OPTICAL)
	Digital coaxial	HDMI 1-5	AV 2-3 (COAXIAL)
	Analog stereo	HDMI 1-5	AV 5-6 (AUDIO) AUDIO 1-2
Component video	Analog stereo	AV 1-2 (COMPONENT VIDEO)	AV 5-6 (AUDIO) AUDIO 1-2

□ Necessary setting

For example, if you have connected a video device to AV 2 (COMPONENT VIDEO) and AV 5 (AUDIO) jacks of the unit, change the combination setting as follows.

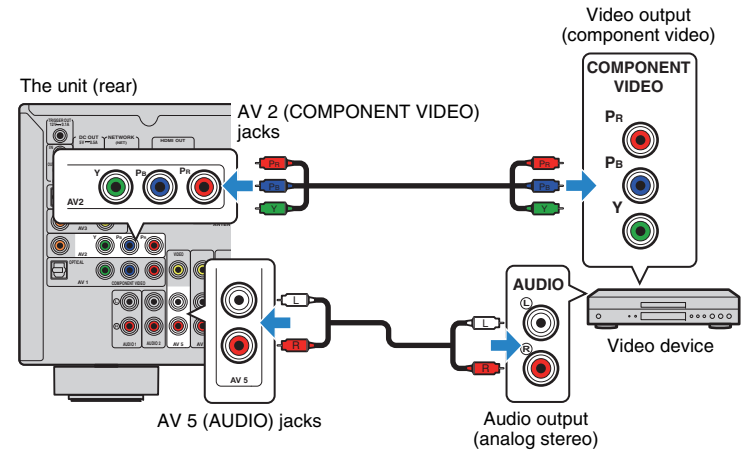



• The following operation is available only when your TV is connected to the unit via HDMI.

- 1 After connecting external devices (such as a TV and playback devices) and power cable of the unit, turn on the unit.
- 2 Press AV 2 to select “AV 2” (video input jack to be used) as the input source.

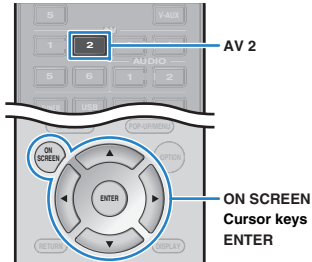

- 3 Press ON SCREEN.
- 4 Use the cursor keys to select “Input” and press ENTER.
- 5 Use the cursor keys (</>) to select “AV2” (video input jack to be used) and press the cursor key (Δ).

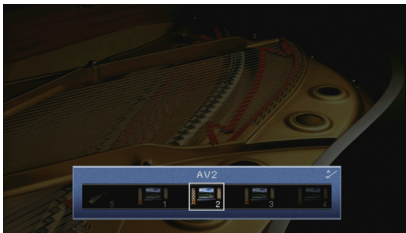

- 6 Use the cursor keys to select “Audio In” and press ENTER.
- 7 Use the cursor keys to select “AV5” (audio input jack to be used).

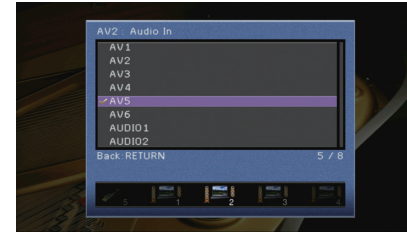

- 8 Press ON SCREEN.

This completes the necessary settings.

If you select “AV 2” as the input source by pressing AV 2, the video/audio played back on the video device will be output from the unit.

Connecting audio devices (such as CD players)

Connect audio devices such as CD players and MD players to the unit. Depending on the audio output jacks available on your audio device, choose one of the following connections.

Audio output jacks on audio device	Audio output jacks on the unit
Digital optical	AV 1 (OPTICAL) AV 4 (OPTICAL)
Digital coaxial	AV 2-3 (COAXIAL)
Analog stereo	AV 5-6 (AUDIO) AUDIO 1-2

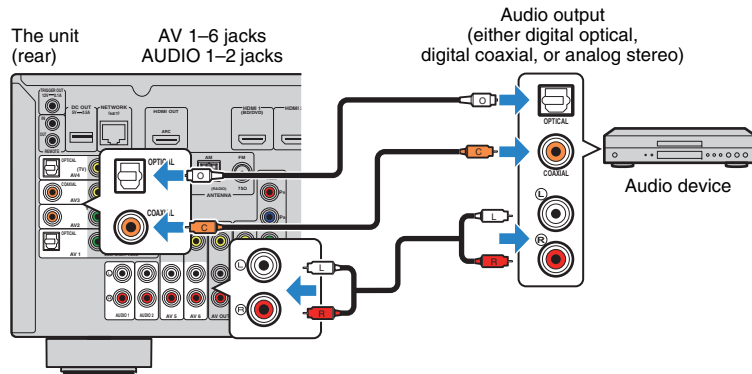

If you select the input source by pressing AV 1-6, AUDIO 1-2 or PHONO*, the audio played back on the audio device will be output from the unit.

Connecting to the jacks on the front panel

Use the VIDEO AUX jack to temporarily connect a playback device to the unit.

Use the USB jack to connect an iPod or a USB storage device. For details, see “Connecting an iPod” (p.53) or “Connecting a USB storage device” (p.57).

Before making a connection, stop playback on the device and turn down the volume on the unit.

□ HDMI connection

Connect an HDMI-compatible device (such as game consoles and camcorders) to the unit with an HDMI cable.

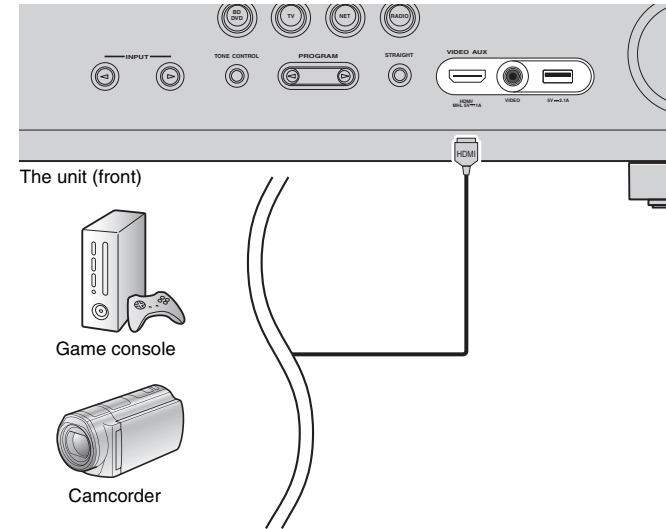

If you select “V-AUX” as the input source by pressing V-AUX, the video/audio played back on the device will be output from the unit.



- To watch videos input to the VIDEO AUX (HDMI/MHL IN) jack, you need to connect your TV to the HDMI OUT jack of the unit (p.21 to 24).
- You need to prepare an HDMI cable that match the output jacks on your device.



- When “USB” is selected as the input source, video signals input to the VIDEO jack are output from the HDMI OUT and MONITOR OUT (VIDEO) jacks.

❑ MHL connection

Connect an MHL-compatible mobile device (such as smartphones) to the unit with an MHL cable. You can enjoy full HD videos and multichannel audio sources stored on the mobile device. The VIDEO AUX jack of the unit enables you to input videos and audio directly from the mobile device to the unit.

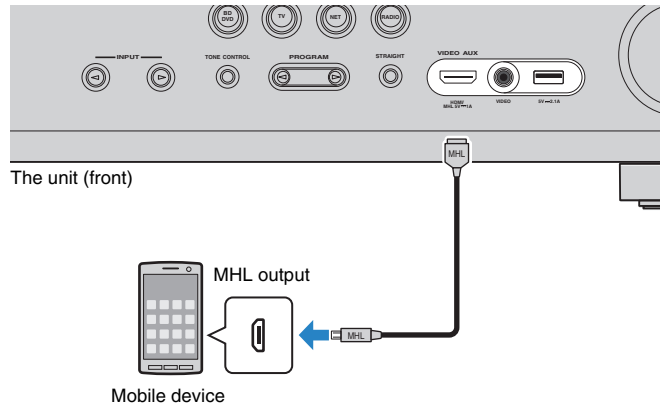

If you select "V-AUX" as the input source by pressing V-AUX, the video/audio played back on the mobile device will be output from the unit.



- To watch videos input to the VIDEO AUX jack, you need to connect your TV to the HDMI OUT jack of the unit (p.21 to 24).
- You need to prepare an MHL cable that match the jack on your mobile device.



- You can operate the mobile device using the menu operation keys, external device operation keys and numeric keys on the remote control. However, some features may not be compatible, depending on the mobile device or its application. In this case, operate the mobile device itself.
- If "Standby Through" (p.91) in the "Setup" menu is set to "On", you can output mobile device videos/audio to the TV or operate the mobile device using the remote control of the unit even when the unit is in standby mode.
- The unit supplies power to the mobile device in the following conditions.
 - The unit is turned on.
 - The unit is in standby mode while "Standby Through" (p.91) in the "Setup" menu is set to "On".

5 Connecting the FM/AM antennas

Connect the supplied FM/AM antennas to the unit.

Fix the end of the FM antenna to a wall, and place the AM antenna on a flat surface.

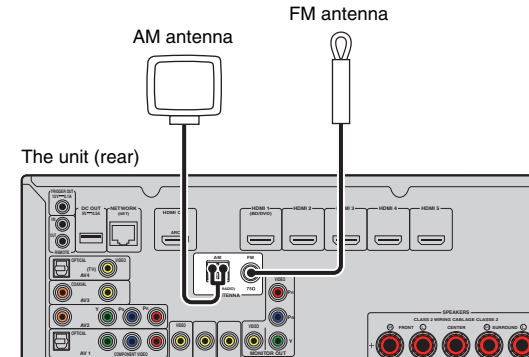

Assembling and connecting the AM antenna

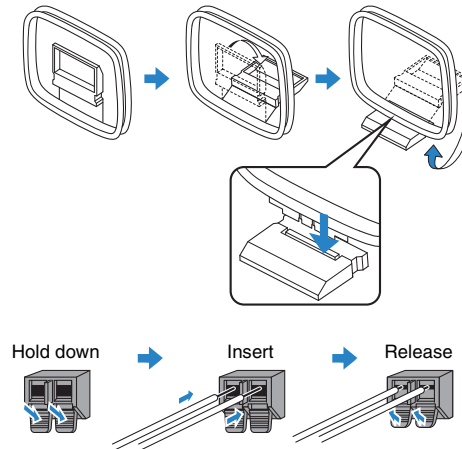

- Unwind only the length of cable needed from the AM antenna unit.
- The wires of the AM antenna have no polarity.

6 Connecting to a network

Connect the unit to your router with a commercially-available STP network cable (CAT-5 or higher straight cable).

You can enjoy Internet radio or music files stored on media servers, such as PCs and Network Attached Storage (NAS), on the unit.

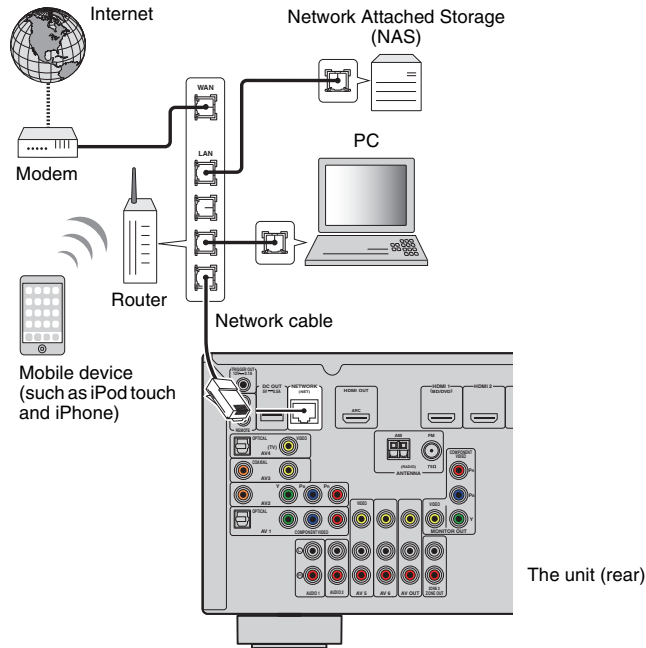

- If you are using a router that supports DHCP, you do not need to configure any network settings for the unit, as the network parameters (such as the IP address) will be assigned automatically to it. You only need to configure the network settings if your router does not support DHCP or if you want to configure the network parameters manually (p.92).
- You can check whether the network parameters (such as IP address) are properly assigned to the unit in "Network" (p.98) in the "Information" menu.



- Some security software installed on your PC or the firewall settings of network devices (such as a router) may block the access of the unit to the network devices or the Internet. In these cases, configure the security software or firewall settings appropriately.
- Each server must be connected to the same subnet as the unit.
- To use the service via the Internet, broadband connection is strongly recommended.

7 Connecting other devices

Connecting recording devices

You can connect video/audio recording devices to the AV OUT jacks. These jacks output analog video/audio signals selected as the input.



- To copy video/audio from a video device, connect the video device to the AV 5–6 jacks of the unit.
- To copy audio from an audio device, connect the audio device to the AV 5–6 jacks or AUDIO 1–2 jacks of the unit.
- Be sure to use the AV OUT jacks only for connecting recording devices.

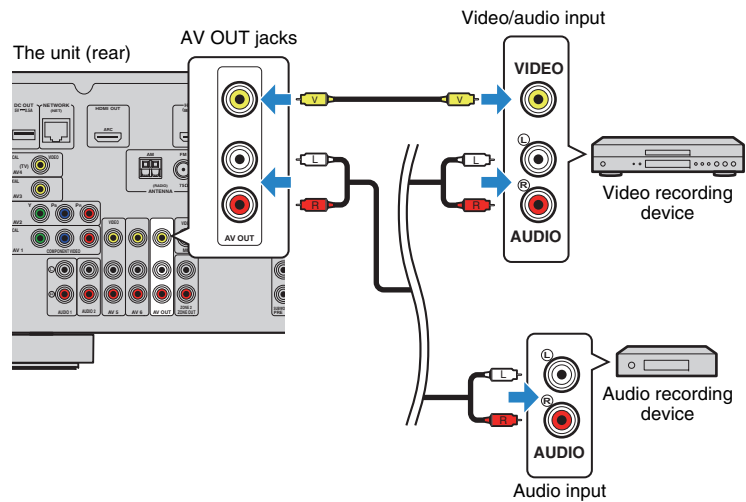

Connecting a device compatible with the trigger function

The trigger function can control an external device in conjunction with operating the unit (such as powering on/off and input selection). If you have a Yamaha subwoofer that supports a system connection or a device with a trigger input jack, you can use the trigger function by connecting the external device to the TRIGGER OUT jack.

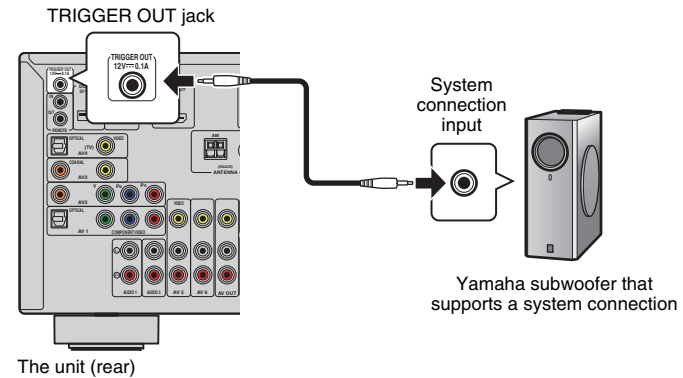

- You can configure the trigger function settings in "Trigger Output" (p.95) in the "Setup" menu.

8 Connecting the power cable

After all the connections are complete, plug in the power cable.

The unit (rear)

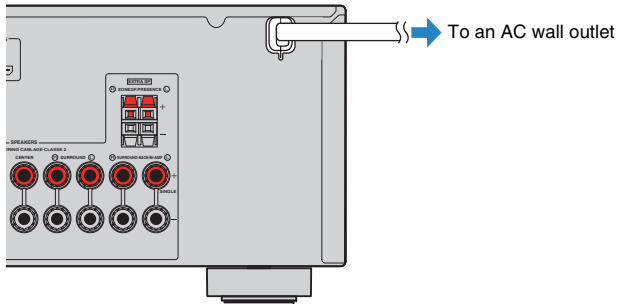

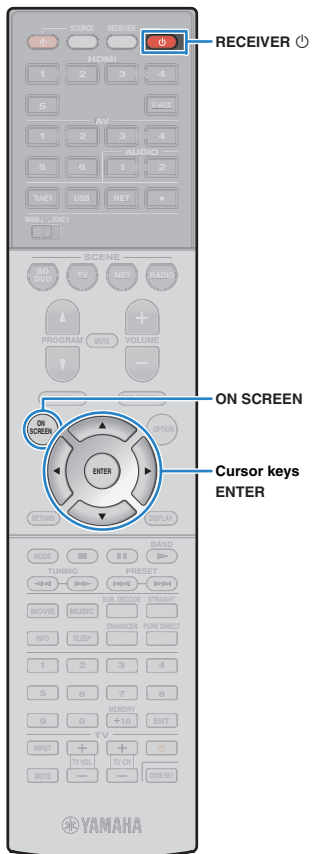

9 Selecting an on-screen menu language

Select the desired on-screen menu language from English (default), Japanese, French, German, Spanish, Russian, Italian and Chinese.

- 1 Press **RECEIVER** to turn on the unit.
- 2 Turn on the TV and switch the TV input to display video from the unit (HDMI OUT jack).
- 3 Press **ON SCREEN**.
- 4 Use the cursor keys to select “Setup” and press **ENTER**.

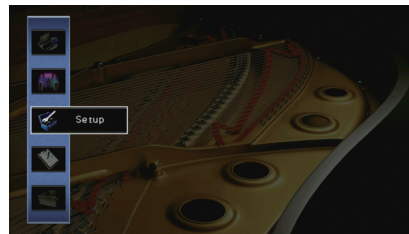

- 5 Use the cursor keys (</>) to select “Language” and the cursor keys (Δ/▽) to select the desired language.



6 To confirm the setting, press **ENTER**.

7 To exit from the menu, press **ON SCREEN**.



• The information on the front display is provided in English only.



10 Optimizing the speaker settings automatically (YPAO)

The Yamaha Parametric room Acoustic Optimizer (YPAO) function detects speaker connections, measures the distances from them to your listening position(s), and then automatically optimizes the speaker settings, such as volume balance and acoustic parameters, to suit your room.



The YPAO function of the unit adopts the YPAO-R.S.C. (Reflected Sound Control) technology that enables to create natural sound fields like a room specifically designed for acoustic perfection.



- Please note the following when using YPAO.
 - Use YPAO after connecting a TV and speakers to the unit.
 - During the measuring process, test tones are output at high volume. Ensure that the test tones do not frighten small children. Also, refrain from using this function at night when it may be a nuisance to others.
 - During the measuring process, you cannot adjust the volume.
 - During the measuring process, keep the room as quiet as possible.
 - Do not connect headphones.

- 1 Press **RECEIVER** to turn on the unit.
- 2 Turn on the TV and switch the TV input to display video from the unit (HDMI OUT jack).
- 3 Turn on the subwoofer and set the volume to half. If the crossover frequency is adjustable, set it to maximum.

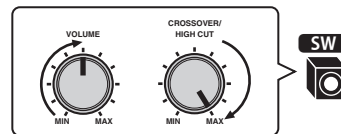

If you are using bi-amp connection or Zone2 speakers, set "Power Amp Assign" (p.85) in the "Setup" menu to the appropriate setting before starting YPAO.

- 4 Place the YPAO microphone at your listening position (same height as your ears) and connect it to the YPAO MIC jack on the front panel.

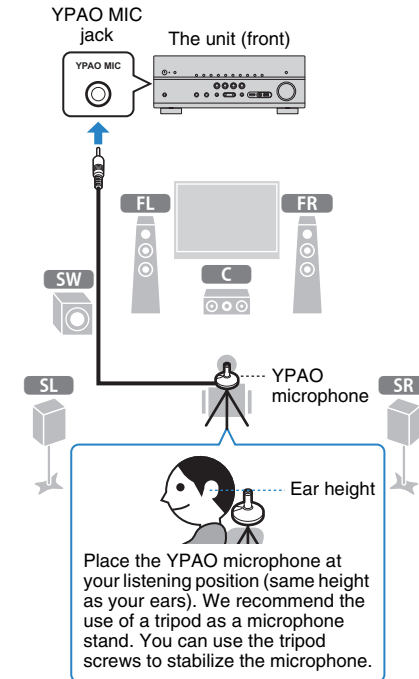

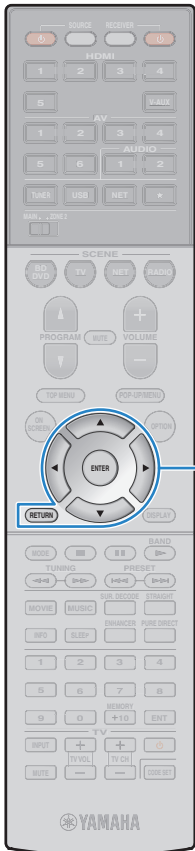

Cursor keys
ENTER
RETURN

The following screen appears on the TV.

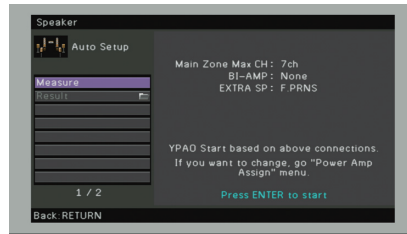

- To cancel the operation, disconnect the YPAO microphone before starting the measurement.
- To configure the power amplifier assignment setting, press RETURN and select "Manual Setup" (p.85).



- Do not stand between the speakers and the YPAO microphone during the measurement process (about 3 minutes).
- Move to the corner of the room or leave the room.

5 To start the measurement, use the cursor keys to select "Measure" and press ENTER.

The measurement will start in 10 seconds. Press ENTER again to start the measurement immediately.



- To cancel the measurement temporarily, press RETURN.

The following screen appears on the TV when the measurement finishes.

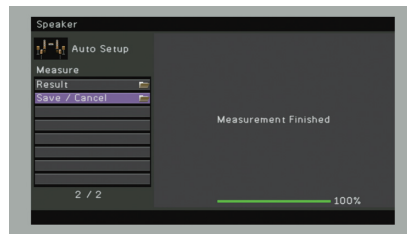

- If any error message (such as E-1) or warning message (such as W-1) appears, see "Error messages" (p.38) or "Warning messages" (p.39).



- To check the measurement results, select "Result". For details, see "Checking the measurement results" (p.37).

6 Use the cursor keys to select "Save/Cancel" and press ENTER.

7 To save the measurement results, use the cursor keys (◀/▶) to select "SAVE" and press ENTER.

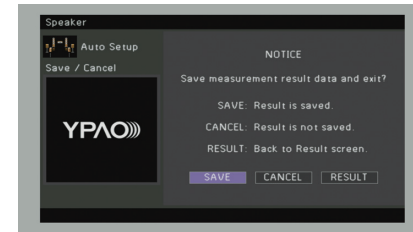

The adjusted speaker settings are applied.



- To finish the measurement without saving the result, select "CANCEL".

8 Disconnect the YPAO microphone from the unit.

This completes optimization of the speaker settings.

Caution

- The YPAO microphone is sensitive to heat, so should not be placed anywhere where it could be exposed to direct sunlight or high temperatures (such as on top of AV equipment).

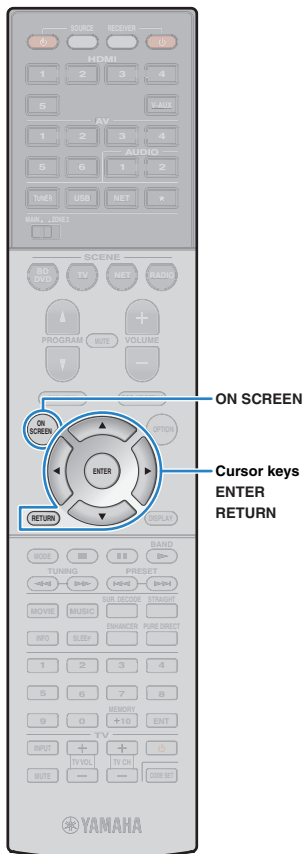

Checking the measurement results

You can check the YPAO measurement results.

- 1 After the measurement, use the cursor keys to select “Result” and press ENTER.



- You can also select “Result” from “Auto Setup” (p.83) in the “Setup” menu, which displays the previous measurement results.

The following screen appears.

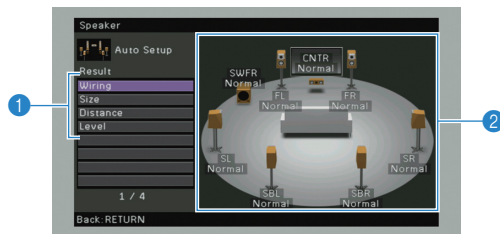

- 1 Measurement result items
- 2 Measurement result details

- 2 Use the cursor keys to select an item.

	<p>Polarity of each speaker</p> <p>Normal: The speaker cable is connected with the correct polarity (+/-).</p> <p>Reverse: The speaker cable may be connected with the reverse polarity (+/-).</p>
Wiring	
	<p>Size of each speaker (cross-over frequency of the subwoofer)</p> <p>Large: The speaker can reproduce low-frequency signals effectively.</p> <p>Small: The speaker cannot reproduce low-frequency signals effectively.</p>
Size	
Distance	Distance from the listening position to each speaker
Level	Output level adjustment for each speaker



- A speaker with a problem is indicated with a message enclosed in a red box.

- 3 To finish checking the results and return to the previous screen, press RETURN.

Reloading the previous YPAO adjustments

When the speaker settings you have configured manually are not suitable, follow the procedure below to discard the manual settings and reload the previous YPAO adjustments.

- 1 In the “Setup” menu, select “Speaker”, “Auto Setup”, and then “Result” (p.82).
- 2 Use the cursor keys to select “Setup Reload” and press ENTER.



- 3 To exit from the menu, press ON SCREEN.

Error messages

If any error message is displayed during the measurement, resolve the problem and perform YPAO again.

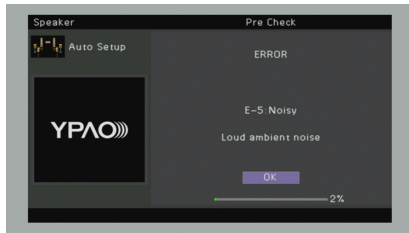

Error message	Cause	Remedy
E-1: No Front SP	Front speakers are not detected.	
E-2: No Sur. SP	One of the surround speakers cannot be detected.	Follow the on-screen instructions to exit YPAO, turn off the unit, and then check the speaker connections.
E-3: No F.PRNS SP	One of the presence speakers cannot be detected.	
E-4: SBR → SBL	A surround back speaker is connected to the R side only.	When using only one surround back speaker, you need to connect it to the SINGLE jack (L side). Follow the on-screen instructions to exit YPAO, turn off the unit, and then reconnect the speaker.
E-5: Noisy	The noise is too loud.	Keep the room quiet and follow the on-screen instructions to start the measurement again. If you select "PROCEED", YPAO takes the measurement again and ignores any noise detected.
E-6: Check Sur.	Surround back speakers are connected, but no surround speakers are connected.	Surround speakers need to be connected in order to use surround back speakers. Follow the on-screen instructions to exit YPAO, turn off the unit, and then reconnect the speakers.
E-7: No MIC	The YPAO microphone has been removed.	Connect the YPAO microphone to the YPAO MIC jack firmly and follow the on-screen instructions to start the measurement again.
E-8: No Signal	The YPAO microphone cannot detect test tones.	Connect the YPAO microphone to the YPAO MIC jack firmly and follow the on-screen instructions to start the measurement again. If this error occurs repeatedly, contact the nearest authorized Yamaha dealer or service center.
E-9: User Cancel	The measurement has been canceled.	Follow the on-screen instructions to start the measurement again. To cancel the measurement, select "EXIT".
E-10: Internal Error	An internal error has occurred.	Follow the on-screen instructions to exit YPAO, turn off and on the unit. If this error occurs repeatedly, contact the nearest authorized Yamaha dealer or service center.

Warning messages

If a warning message is displayed after the measurement, you can still save the measurement results by following on-screen instructions. However, we recommend you perform YPAO again in order to use the unit with the optimal speaker settings.

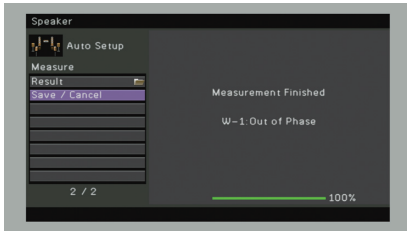

Warning message	Cause	Remedy
W-1: Out of Phase	A speaker cable may be connected with the reverse polarity (+/-).	Select "Wiring" in "Result" (p.37) and check the cable connections (+/-) of the speaker identified by "Reverse". If the speaker is connected incorrectly, turn off the unit and then reconnect the speaker cable. Depending on the type of speakers or room environment, this message may appear even if the speakers are connected correctly. In this case, you can ignore the message.
W-2: Over Distance	A speaker is placed more than 24 m (80 ft) from the listening position.	Select "Distance" in "Result" (p.37) and move the speaker identified by ">24.00m (>80.0ft)" within 24 m (80 ft) of the listening position.
W-3: Level Error	There are significant volume differences between the speakers.	Check the usage environment and cable connections (+/-) of each speaker, and the volume of the subwoofer. We recommend using the same speakers or speakers with specifications that are as similar as possible.

PLAYBACK

Basic playback procedure

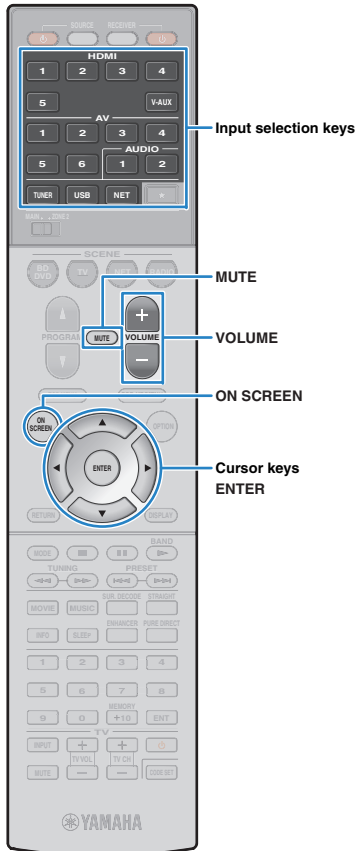

- 1 Turn on the external devices (such as a TV or BD/DVD player) connected to the unit.
- 2 Use the input selection keys to select an input source.
- 3 Start playback on the external device or select a radio station.

Refer to the instruction manual for the external device.

For details on the following operations, see the corresponding pages.

- Listening to FM/AM radio (p.48)
- Playing back iPod music (p.53)
- Playing back music stored on a USB storage device (p.57)
- Playing back music stored on media servers (PCs/NAS) (p.60)
- Listening to Internet radio (p.63)
- Playing back iTunes/iPod music via a network (AirPlay) (p.65)

- 4 Press **VOLUME** to adjust the volume.



- To mute the audio output, press MUTE. Press MUTE again to unmute.
- To adjust the treble/bass settings, use the "Option" menu or TONE CONTROL on the front panel (p.73).



On-screen input selection

- ① Press ON SCREEN.
- ② Use the cursor keys to select "Input" and press ENTER.
- ③ Use the cursor keys to select the desired input source and press ENTER.

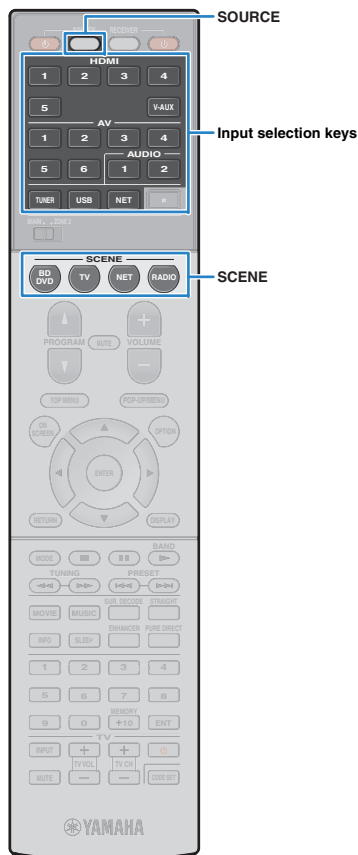

Selecting the input source and favorite settings with one touch (SCENE)

The SCENE function allows you to select the assigned input source, sound program, Compressed Music Enhancer on/off with just one touch.

1 Press SCENE.

The input source and settings registered to the corresponding scene are selected. The unit turns on automatically when it is in standby mode.

By default, the following settings are registered for each scene.

SCENE	Input	Sound program	Compressed Music Enhancer
BD/DVD	HDMI 1	MOVIE (Sci-Fi)	Off
TV	AV 4	STRAIGHT	On
NET	NET RADIO	MUSIC (7ch Stereo)	On
RADIO	TUNER	MUSIC (7ch Stereo)	On

Configuring scene assignments

1 Perform the following operations to prepare the settings you want to assign to a scene.

- Select an input source (p.40)
- Select a sound program (p.42)
- Enable/disable Compressed Music Enhancer (p.47)

2 Hold down the desired SCENE key until “SET Complete” appears on the front display.



3 If you want to control the corresponding playback device after selecting the scene, hold down the corresponding SCENE key and input selection key together for more than 3 seconds.

Once the setting is completed successfully, SOURCE blinks twice.



- If you have not registered the remote control code of the playback device yet, see “Registering the remote control codes for playback devices” (p.103) to register it.
- You can also configure scene assignments in the “Scene” menu (p.77).
- The SCENE link playback function allows you to start playback of an external device connected to the unit via HDMI. To enable SCENE link playback, specify the device type in “Device Control” (p.78) in the “Scene” menu.

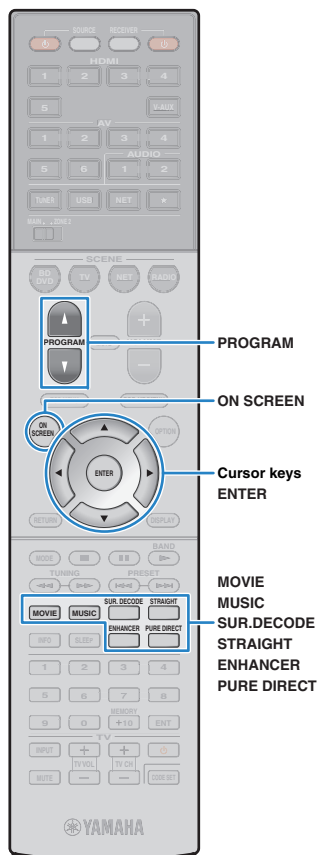

Selecting the sound mode

The unit is equipped with a variety of sound programs and surround decoders that allow you to enjoy playback sources with your favorite sound mode (such as sound field effect or stereo playback).

❑ Selecting a sound program suitable for movies

- Press MOVIE repeatedly.

This mode lets you enjoy sound field effects optimized for viewing video sources, such as movies, TV programs, and games (p.44).

❑ Selecting a sound program suitable for music or stereo playback

- Press MUSIC repeatedly.

This mode lets you enjoy sound field effects optimized for listening music sources or stereo playback (p.45).

❑ Selecting a surround decoder

- Press SUR.DECODE repeatedly.

This mode lets you enjoy unprocessed multichannel playback from 2-channel sources (p.46).

❑ Switching to the straight decode mode

- Press STRAIGHT.

This mode lets you enjoy unprocessed sounds in original channels (p.46).

❑ Switching to the Pure Direct mode

- Press PURE DIRECT.

This mode lets you enjoy pure high fidelity sound by reducing the electrical noise from other circuitry (p.47).

❑ Enabling Compressed Music Enhancer

- Press ENHANCER.

This mode lets you enjoy compressed music with additional depth and breadth (p.47).

📺 On-screen sound program/surround decoder selection

- ① Press ON SCREEN.
- ② Use the cursor keys to select "Sound Program" and press ENTER.
- ③ Use the cursor keys to select a sound program/surround decoder and press ENTER.



- You can also switch the sound programs and surround decoder by pressing PROGRAM.
- You can change the settings of the surround programs and surround decoders in the "Sound Program" menu (p.79).
- The sound mode can be applied separately to each input source.
- When you play back audio signals with a sampling rate of higher than 96 kHz, the straight decode mode (p.46) is automatically selected.
- You can check which speakers are currently outputting sound by looking at the speaker indicators on the unit's front panel (p.9) or at the "Audio Signal" screen in the "Information" menu (p.97).

Enjoying stereoscopic sound fields (CINEMA DSP 3D)



The unit is equipped with a variety of sound programs that utilize Yamaha's original DSP technology (CINEMA DSP 3D). It allows you to easily create sound fields like actual movie theaters or concert halls in your room and enjoy natural stereoscopic sound fields.

Sound program category



- To use the conventional CINEMA DSP, set "CINEMA DSP 3D Mode" (p.73) in the "Option" menu to "Off".
- We recommend using presence speakers in order to experience the full effect of the stereoscopic sound fields. However, even when no presence speakers are connected, the unit creates Virtual Presence Speaker (VPS) using the front, center, and surround speakers to produce stereoscopic sound fields.

■ Enjoying sound field effects without surround speakers (Virtual CINEMA DSP)

If you select one of the sound programs (except 2ch Stereo and 7ch Stereo) when no surround speakers are connected, the unit utilizes Yamaha's original virtual surround technology to reproduce up to 7-channel surround sound and enable you to enjoy the well-oriented sound field only with the front-side speakers. We recommend using presence speakers in order to enjoy more effective stereoscopic sound field.

Enjoying surround sound with headphones (SILENT CINEMA)



You can enjoy surround or sound field effects, like a multichannel speaker system, with stereo headphones by connecting the headphones to the PHONES jack and selecting a sound program or a surround decoder.

■ Sound programs suitable for movies (MOVIE)

The following sound programs are optimized for viewing video sources, such as movies, TV programs, and games.

□ MOVIE THEATER

Standard	This program creates a sound field that emphasizes the surround feeling without disturbing the original acoustic positioning of multichannel audio, such as Dolby Digital and DTS. Its design is based on the concept of the ideal movie theater, in which the audience is surrounded by beautiful reverberations from the left, right, and rear.
Spectacle	This program delivers the scale and grandeur of spectacular movie productions. It delivers an expansive sound space to match the cinemascope wide-screen, and boasts a broad dynamic range, providing everything from small delicate sounds to powerful loud booms.
Sci-Fi	This program clearly reproduces the finely elaborated sound design of the latest Sci-Fi and SFX movies. You can enjoy a variety of cinematographically created virtual spaces reproduced with clear separation between dialogue, sound effects, and background music.
Adventure	This program is ideal for reproducing the sound design of action and adventure movies precisely. The sound field restrains reverberations, but puts emphasis on reproducing a sensation of expansiveness on both sides, powerful space expanded widely to the left and right. The restrained depth creates a clear and powerful space, while also maintaining the articulation of the sounds and the separation of the channels.
Drama	This program features stable reverberations that match a wide range of movie genres, from serious dramas to musicals and comedies. The reverberations are modest, but suitably stereophonic. The sound effects and background music are reproduced with a gentle echo that does not impinge on the articulation of the dialogue. You'll never get tired listening for long periods.
Mono Movie	This program reproduces monaural video sources, such as classic movies, in an atmosphere of a good old movie theater. The program creates a pleasant space with depth, by adding breadth and the appropriate reverberation to the original audio.

□ ENTERTAINMENT

Sports	This program allows listeners to enjoy the rich vividness of sport broadcasts and light entertainment programs. In sports broadcasts, the commentators' voices are positioned clearly at the center, while the atmosphere inside the stadium is realistically conveyed by the peripheral delivery of the sounds of the fans in a suitable space.
Action Game	This program is suitable for action games, such as car racing and fighting games. The reality of, and emphasis on, various effects makes the player feel like they are right in the middle of the action, allowing for greater concentration. Use this program in combination with Compressed Music Enhancer for a more dynamic and strong sound field.
Roleplaying Game	This program is suitable for role-playing and adventure games. This program adds depth to the sound field for natural and realistic reproduction of background music, special effects, and dialogue from a wide variety of scenes. Use this program in combination with Compressed Music Enhancer for a clearer and more spatial sound field.
Music Video	This program allows you to enjoy videos of pop, rock, and jazz concerts, as if you were there yourself. Immerse yourself in the hot concert atmosphere thanks to the vividness of the singers and solos on stage, a presence sound field that emphasizes the beat of rhythm instruments, and a surround sound field that reproduces the space of a big live hall.

■ Sound programs suitable for music/stereo playback (MUSIC)

The following sound programs are optimized for listening to music sources.

You can also select stereo playback.

□ CLASSICAL

Hall in Munich	This program simulates a Munich concert hall with approximately 2,500 seats that uses stylish wood for the interior finishing. Fine, beautiful reverberations spread richly, creating a calming atmosphere. The listener's virtual seat is at the center left of the arena.
Hall in Vienna	This program simulates a 1,700-seat, middle-sized concert hall with a shoebox shape that is traditional in Vienna. Pillars and ornate carvings create extremely complex reverberations from all around the audience, producing a very full, rich sound.
Chamber	This program creates a relatively wide space with a high ceiling, like an audience hall in a palace. It offers pleasant reverberations that are suitable for courtly music and chamber music.

□ LIVE/CLUB

Cellar Club	This program simulates an intimate concert venue with a low ceiling and homey atmosphere. A realistic, live sound field delivers powerful sounds that make you feel as if you are sitting in the front row in front of a small stage.
The Roxy Theatre	This program creates the sound field of a 460-seat rock music concert venue in Los Angeles. The listener's virtual seat is at the center left of the hall.
The Bottom Line	This program creates the sound field at stage front in The Bottom Line, a famous New York jazz club once. The floor can seat 300 people to the left and right in a sound field offering real and vibrant sound.

□ STEREO

2ch Stereo	Use this program to mix down multichannel sources to 2 channels. When multichannel signals are input, they are down mixed to 2 channels and output from the front speakers (this program does not utilize CINEMA DSP).
7ch Stereo	Use this program to output sound from all speakers. When you play back multichannel sources, the unit mixes down the source to 2 channels, and then outputs the sound from all speakers. This program creates a larger sound field and is ideal for background music at parties.



- CINEMA DSP 3D (p.43) and Virtual CINEMA DSP (p.43) do not work when "2ch Stereo" or "7ch Stereo" is selected.

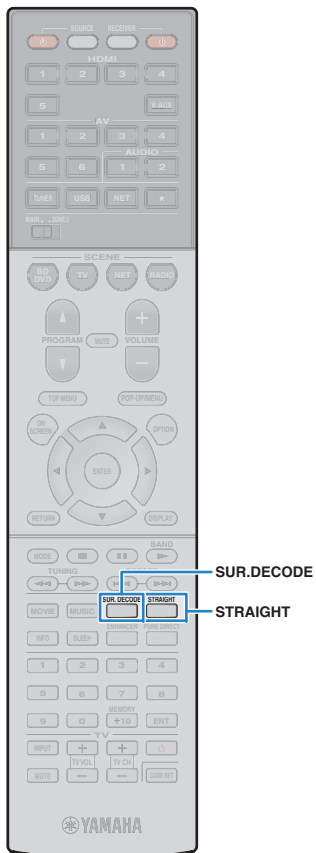

Enjoying unprocessed playback

You can play back input sources without any sound field effect processing.

■ Playing back in original channels (straight decode)

When the straight decode mode is enabled, the unit produces stereo sound from the front speakers for 2-channel sources such as CDs, and produces unprocessed multichannel sounds for multichannel sources.

1 Press STRAIGHT.

Each time you press the key, the straight decode mode is enabled or disabled.



- To enable 6.1/7.1-channel playback from 5.1-channel sources when surround back speakers are used, set "Extended Surround" (p.74) in the "Option" menu to a setting other than "Off".

■ Playing back 2-channel sources in multichannel (surround decoder)

The surround decoder enables unprocessed multichannel playback from 2-channel sources. When a multichannel source is input, it works the same way as the straight decode mode.

For details on each decoder see "Glossary" (p.115).

1 Press SUR.DECODE to select a surround decoder.

Each time you press the key, the surround decoder changes.



Dolby Pro Logic	Uses the Dolby Pro Logic decoder suitable for all sources.
Dolby PLIIX Movie	Use the Dolby Pro Logic IIX decoder (or Dolby Pro Logic II decoder) suitable for movies.
Dolby PLII Movie	Use the Dolby Pro Logic II decoder suitable for movies.
Dolby PLIIX Music	Use the Dolby Pro Logic IIX decoder (or Dolby Pro Logic II decoder) suitable for music.
Dolby PLII Music	Use the Dolby Pro Logic II decoder suitable for music.
Dolby PLIIX Game	Use the Dolby Pro Logic IIX decoder (or Dolby Pro Logic II decoder) suitable for games.
Dolby PLII Game	Use the Dolby Pro Logic II decoder suitable for games.
Neo:6 Cinema	Uses the DTS Neo:6 decoder suitable for movies.
Neo:6 Music	Uses the DTS Neo:6 decoder suitable for music.



- You cannot select the Dolby Pro Logic IIX decoders when headphones are connected or when "Surround Back" in the "Setup" menu is set to "None".



Enjoying pure high fidelity sound (Pure Direct)

When the Pure Direct mode is enabled, the unit plays back the selected source with the least circuitry in order to reduce the electrical noise from other circuitry (such as the front display). It allows you to enjoy Hi-Fi sound quality.

1 Press PURE DIRECT.

Each time you press the key, the Pure Direct mode is enabled or disabled.



- When the Pure Direct mode is enabled, the following functions are not available.
 - Some settings for the speakers or sound programs
 - Operating the on-screen and “Option” menus
 - Using the multi-zone function
 - Output from the AV OUT jacks
 - Viewing information on the front display (when not in operation)

Enjoying compressed music with enhanced sound (Compressed Music Enhancer)

compressed music ENHANCER

Compressed Music Enhancer adds depth and breadth to the sound, allowing you to enjoy a dynamic sound close to the original sound before it was compressed. This function can be used along with any other sound modes.

1 Press ENHANCER.

Each time you press the key, Compressed Music Enhancer is enabled or disabled.

“ENHANCER” lights up



- Compressed Music Enhancer does not work on signals whose sampling rate is over 48 kHz.



- You can also use “Enhancer” (p.74) in the “Option” menu to enable/disable Compressed Music Enhancer.

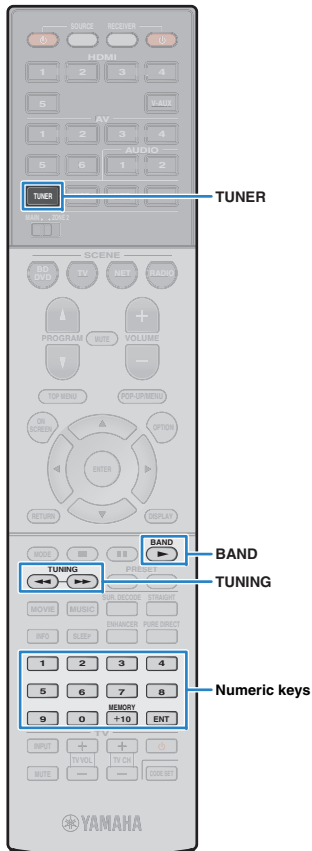

Listening to FM/AM radio

You can tune into a radio station by specifying its frequency or selecting from registered radio stations.



- The radio frequencies differ depending on the country or region where the unit is being used. The explanation of this section uses a display with frequencies used in Europe model.
- If you cannot obtain good reception on the radio, adjust the direction of the FM/AM antennas.

Selecting a frequency for reception

- 1 Press **TUNER** to select “TUNER” as the input source.
- 2 Press **BAND** to select a band (FM or AM).



- 3 Use the following keys to set a frequency.

TUNING: Increase/decrease the frequency. Hold down the key for about a second to search stations automatically.

Numeric keys: Enter a frequency directly. For example, to select 98.50 MHz, press “9”, “8”, “5” and “0” (or ENT).

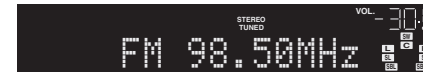

“TUNED” lights up when a signal is received from a radio station.

“STEREO” also lights up when a stereo signal is received.



- “Wrong Station!” appears when you enter a frequency that is out of reception range.



- You can switch between “Stereo” (stereo) and “Mono” (monaural) for FM radio reception in “FM Mode” (p.74) in the “Option” menu. When the signal reception for an FM radio station is unstable, switching to monaural may improve it.

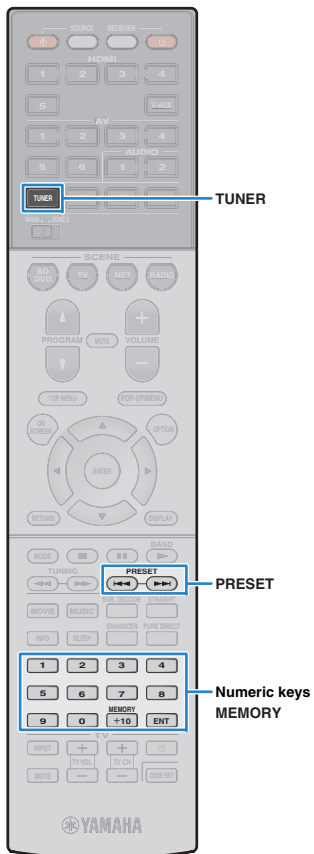

Registering favorite radio stations (presets)

You can register up to 40 radio stations as presets. Once you have registered stations, you can easily tune into them by selecting their preset numbers.



- You can automatically register FM radio stations that have strong signals by using “Auto Preset” (p.52).

■ Registering a radio station

Select a radio station manually and register it to a preset number.

1 Follow “Selecting a frequency for reception” (p.48) to tune into the desired radio station.

2 Hold down MEMORY for more than 2 seconds.

The first time that you do register a station, the selected radio station will be registered to the preset number “01”. Thereafter, each radio station you select will be registered to the next empty (unused) preset number after the most recently registered number.



Preset number



- To select a preset number for registering, press MEMORY once after tuning into the desired radio station, press PRESET to select a preset number, and then press MEMORY again.



“Empty” (not in use) or the frequency currently registered

■ Selecting a preset station

Tune into a registered radio station by selecting its preset number.

1 Press TUNER to select “TUNER” as the input source.

2 Press PRESET repeatedly to select the desired radio station.

You can also enter a preset number (01 to 40) directly by using the numeric keys after pressing PRESET once.

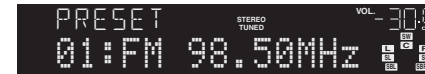

- “No Presets” appears when no radio stations are registered.
- “Wrong Num.” appears when an invalid number is entered.
- “Empty” appears when a preset number not in use is entered.



- To clear preset stations, use “Clear Preset” or “Clear All Preset” (p.52).

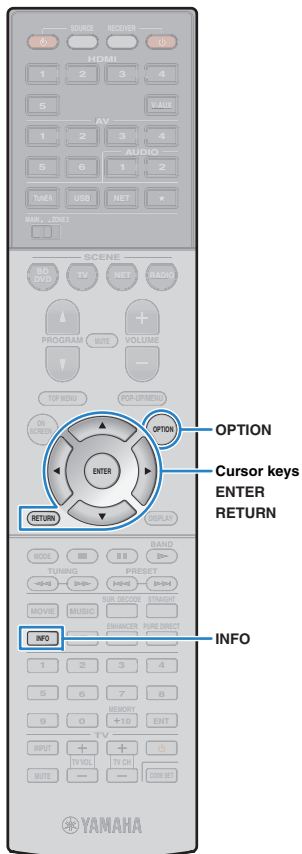

Radio Data System tuning

(Europe model only)

Radio Data System is a data transmission system used by FM stations in many countries. The unit can receive various types of Radio Data System data, such as “Program Service”, “Program Type,” “Radio Text” and “Clock Time”, when it is tuned into a Radio Data System broadcasting station.

■ Displaying the Radio Data System information

1 Tune into the desired Radio Data System broadcasting station.



- We recommend using “Auto Preset” to tune into the Radio Data System broadcasting stations (p.52).

2 Press INFO.

Each time you press the key, the displayed item changes.

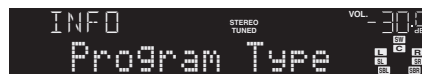

Item name

About 3 seconds later, the corresponding information for the displayed item appears.



Information

Program Service	Program service name
Program Type	Current program type
Radio Text	Information on the current program
Clock Time	Current time
DSP Program	Sound mode name
Audio Decoder	Decoder name
Frequency	Frequency



- “Program Service”, “Program Type”, “Radio Text”, and “Clock Time” are not displayed if the radio station does not provide the Radio Data System service.

■ Receiving traffic information automatically

When “TUNER” is selected as the input source, the unit automatically receives traffic information. To enable this function, follow the procedure below to set the traffic information station.

1 When “TUNER” is selected as the input source, press OPTION.

2 Use the cursor keys to select “Traffic Program” (TrafficProgram) and press ENTER.

The traffic information station search will start in 5 seconds. Press ENTER again to start the search immediately.



- To search upward/downward from the current frequency, press the cursor keys (Δ/▽) while “READY” is displayed.
- To cancel the search, press RETURN.
- Texts in parentheses denote indicators on the front display.

The following screen appears for about 3 seconds when the search finishes.



Traffic information station (frequency)



- “TP Not Found” appears for about 3 seconds when no traffic information stations are found.

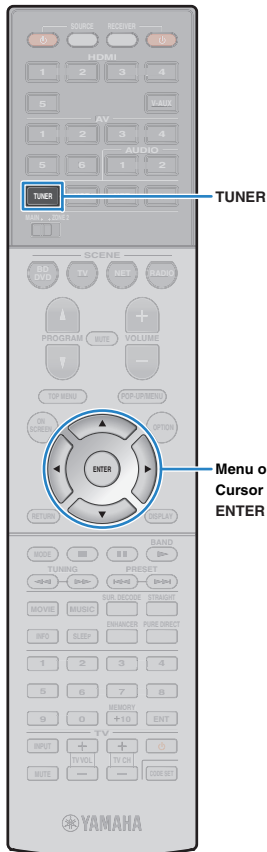

Operating the radio on the TV

You can view the radio information or select a radio station on the TV.

1 Press TUNER to select “TUNER” as the input source.

The playback screen is displayed on the TV.

■ Playback screen



1 Radio station information

Displays the information of the selected radio station such as the selected band (FM/AM) and frequency.

(Europe model only)

When tuning into a Radio Data System broadcasting station (p.50), the Radio Data System information (“Program Service”, “Program Type,” “Radio Text” and “Clock Time”) is also displayed.

2 Band icon

(Except for U.K. and Europe models)

Select this icon and press ENTER to switch between FM and AM.

3 TUNED/STEREO indicators

“TUNED” lights up when a signal is received from a radio station.

“STEREO” lights up when a stereo signal is received.

4 Operation menu

Press the cursor key (▷) and then use the cursor keys (△/▽) to select an item. Press ENTER to confirm the selection.

Menu	Submenu	Function
	FM	(U.K. and Europe models only)
	AM	Switches to FM/AM.
Manual Tuning	Tuning (+/-)	Selects a frequency.
	Auto (+/-)	Selects a radio station automatically.
	Memory	Registers the selected station as presets.
	Direct	Enters a frequency directly.
Browse		Moves to the browse screen (preset station list).
Screen Off		Closes the screen display and shows the background. Press one of the menu operation keys to redisplay it.



Menu operation keys
Cursor keys
ENTER

Browse screen

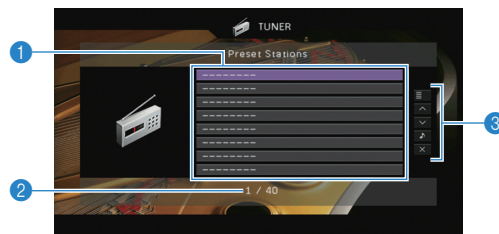

1 Preset station list

Displays the list of preset stations. Use the cursor keys to select a preset station and press ENTER to tune into it.

2 Preset number

3 Operation menu

Press the cursor key (▷) and then use the cursor keys (△/▽) to select an item. Press ENTER to confirm the selection.

Menu	Submenu	Function
Utility	Memory	Registers the current station to the preset number selected in the list.
	Auto Preset	Automatically registers FM radio stations with strong signals (up to 40 stations).
	Clear Preset	Clear the preset station selected in the list.
	Clear All Preset	Clear all the preset stations.
1 Page Up		Moves to the previous/next page of the list.
1 Page Down		
Now Playing		Moves to the playback screen.
Screen Off		Closes the screen display and shows the background. Press one of the menu operation keys to redisplay it.



- (Europe model only)
Only Radio Data System broadcasting stations are stored automatically by "Auto Preset".

Playing back iPod music

You can play back iPod music on the unit using a USB cable supplied with the iPod.



- An iPod may not be detected by the unit or some features may not be compatible, depending on the model or software version of the iPod.
- To play back iPod videos on the unit, an Apple Composite AV Cable (not supplied) is required. Connect the USB and composite video plugs of the Apple Composite AV cable to the USB jack and VIDEO jack on the front panel. To select a video, operate the iPod itself in the simple play mode (p.55).

Supported iPod (as of February 2013)

- iPod touch (1st, 2nd, 3rd and 4th generation)
- iPod nano (2nd, 3rd, 4th, 5th and 6th generation)
- iPhone 4S, iPhone 4, iPhone 3GS, iPhone 3G, iPhone
- iPad (3rd generation), iPad 2, iPad

Connecting an iPod

Connect your iPod to the unit with the USB cable supplied with the iPod.

1 Connect the USB cable to the iPod.

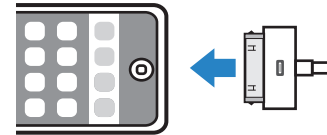

2 Connect the USB cable to the USB jack.

The unit (front)

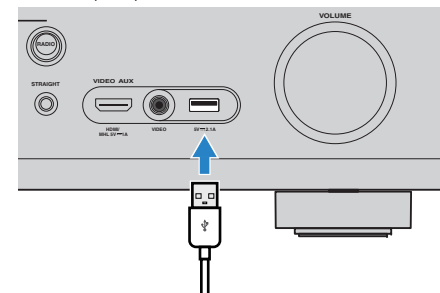

- The iPod charges while it is connected to the unit. If you set the unit to standby mode while the iPod is charging, the iPod continues to charge up to 4 hours. If "Network Standby" (p.92) in the "Setup" menu is set to "On", it continues to charge without limit.



- Disconnect the iPod from the USB jack when it is not in use.

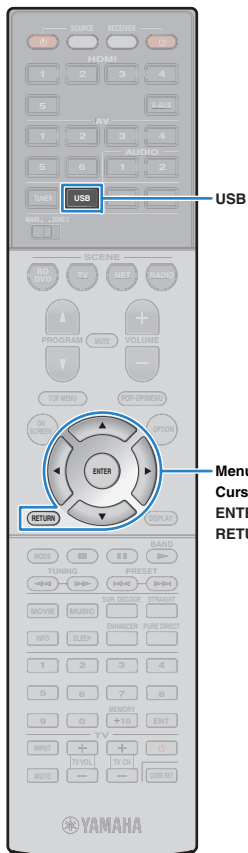

Playback of iPod content

Follow the procedure below to operate the iPod contents and start playback.

You can control the iPod with the menu displayed on the TV screen.

1 Press USB to select “USB” as the input source.

The browse screen is displayed on the TV.

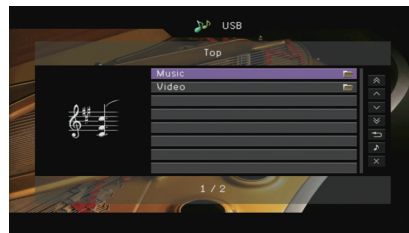

- If playback is ongoing on your iPod, the playback screen is displayed.

2 Use the cursor keys to select an item and press ENTER.

If a song is selected, playback starts and the playback screen is displayed.

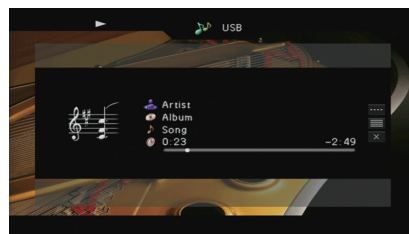

- To return to the previous screen, press RETURN.
- To operate the iPod manually to select content or control playback, switch to the simple play mode (p.55).

Browse screen

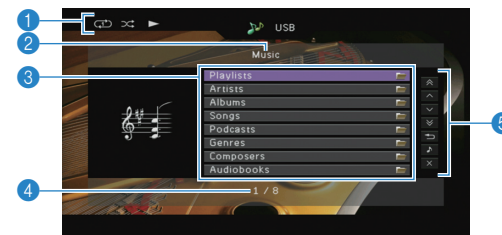

1 Status indicators

Display the current repeat/shuffle settings (p.56) and playback status (such as play/pause).

2 List name

3 Contents list

Displays the list of iPod content. Use the cursor keys to select an item and press ENTER to confirm the selection.

4 Item number/total

5 Operation menu

Press the cursor key (▷) and then use the cursor keys (△/▽) to select an item. Press ENTER to confirm the selection.

Menu	Function
1 Page Up	Moves to the previous/next page of the list.
1 Page Down	
10 Pages Up	Moves 10 pages forward/backward.
10 Pages Down	
Return	Returns to the higher-level list.
Now Playing	Moves to the playback screen.
Screen Off	Closes the screen display and shows the background. Press one of the menu operation keys to redisplay it.

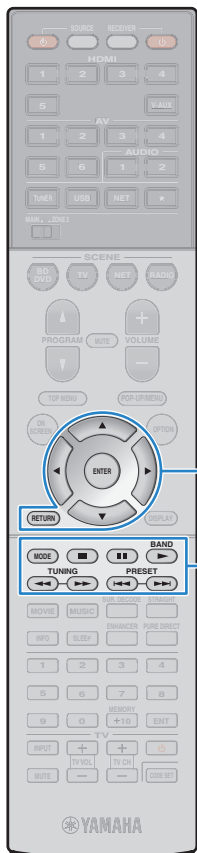

Menu operation keys
 Cursor keys
 ENTER
 RETURN

External device operation keys
 MODE

■ Playback screen

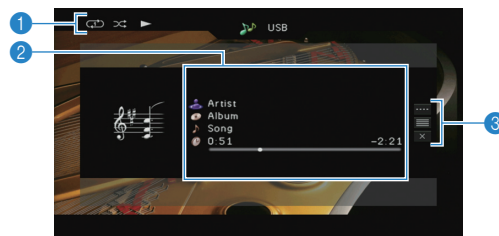

1 Status indicators

Display the current repeat/shuffle settings (p.56) and playback status (such as play/pause).

2 Playback information

Displays the artist name, album name, song title, and elapsed/remaining time.

Use the cursor keys to select scrollable information.

3 Operation menu

Press the cursor key (▷) and then use the cursor keys (△/▽) to select an item. Press ENTER to confirm the selection.

To close the submenu, press RETURN.

Menu	Submenu	Function
	▶	Resumes playback from pause.
	■	Stops playback.
	▮▮	Stops playback temporarily.
Play Control	⏮	Skips forward/backward.
	⏭	Skips forward/backward.
	⏪	Searches forward/backward (by holding down).
	⏩	Searches forward/backward (by holding down).
Browse		Moves to the browse screen.
Screen Off		Closes the screen display and shows the background. Press one of the menu operation keys to redisplay it.



- You can also use the external device operation keys on the remote control to control playback.

■ Operating the iPod itself or remote control (simple play)

1 Press MODE to switch to the simple play mode.

The TV menu screen turns off and iPod operations are enabled.

To display the TV menu screen, press MODE again.

2 Operate your iPod itself or the remote control to start playback.

Operational remote control keys	Function	
Cursor keys	Select an item.	
ENTER	Confirms the selection.	
RETURN	Returns to the previous screen.	
	▶	Starts playback or stops playback temporarily.
	▮▮	Stops playback.
External device operation keys	⏮	Skips forward/backward.
	⏭	Skips forward/backward.
	⏪	Searches forward/backward (by holding down).
	⏩	Searches forward/backward (by holding down).

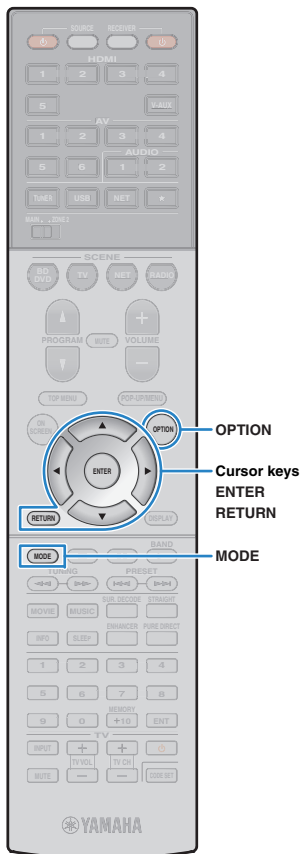

Repeat/shuffle settings

You can configure the repeat/shuffle settings of your iPod.



- During simple play, configure the repeat/shuffle settings directly on your iPod or press MODE to display the TV menu screen and then follow the procedure below.

1 When “USB” is selected as the input source, press **OPTION**.

2 Use the cursor keys to select “Shuffle” (Shuffle) or “Repeat” (Repeat) and press **ENTER**.



- To return to the previous screen during menu operations, press RETURN.
- Texts in parentheses denote indicators on the front display.

3 Use the cursor keys (</>) to select a setting.

Item	Setting	Function
Shuffle (Shuffle)	Off (Off)	Turns off the shuffle function.
	Songs (Songs)	Plays back songs in random order. “⌘” appears in the TV screen.
	Albums (Albums)	Plays back albums in random order. “⌘” appears in the TV screen.
Repeat (Repeat)	Off (Off)	Turns off the repeat function.
	One (One)	Plays back the current song repeatedly. “↺” appears in the TV screen.
	All (All)	Plays back all songs repeatedly. “↻” appears in the TV screen.

4 To exit from the menu, press **OPTION**.

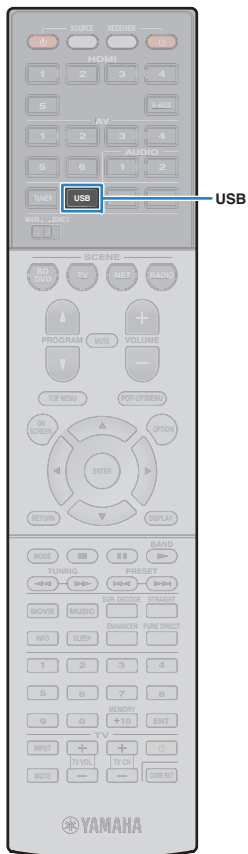

Playing back music stored on a USB storage device

You can play back music files stored on a USB storage device on the unit. Refer to the instruction manuals for the USB storage device for more information.

The unit supports USB mass storage class devices (FAT16 or FAT32 format).



- The unit supports WAV (PCM format only), MP3, WMA, MPEG-4 AAC and FLAC files (1- or 2-channel audio only).
- The unit is compatible with sampling rate of up to 192 kHz for WAV and FLAC files, and 48 kHz for other files.
- Some features may not be compatible, depending on the model or manufacturer of the USB storage device.
- Digital Rights Management (DRM) contents cannot be played back.

Connecting a USB storage device

1 Connect the USB storage device to the USB jack.

The unit (front)

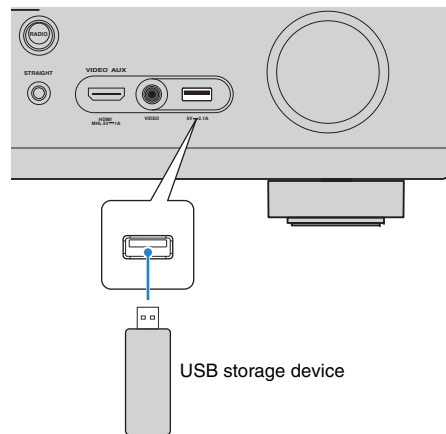

- If the USB storage device contains many files, it may take time to load the them. In this case, "Loading..." appears in the front display.



- Stop playback of the USB storage device before disconnect it from the USB jack.
- Disconnect the USB storage device from the USB jack when it is not in use.
- You cannot connect the PC to the USB jack of the unit.

Playback of USB storage device contents

Follow the procedure below to operate the USB storage device contents and start playback.

You can control the USB memory device with the menu displayed on the TV screen.

1 Press USB to select "USB" as the input source.

The browse screen is displayed on the TV.



- If playback is ongoing on your USB storage device, the playback screen is displayed.

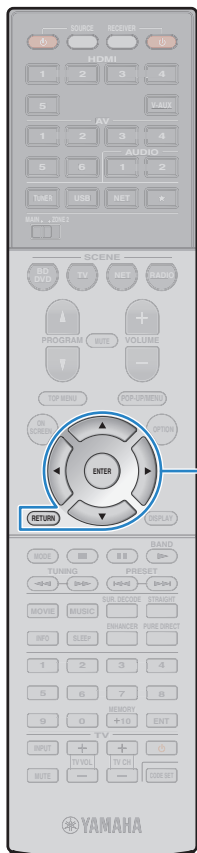

Menu operation keys
Cursor keys
ENTER
RETURN

2 Use the cursor keys to select an item and press ENTER.

If a song is selected, playback starts and the playback screen is displayed.

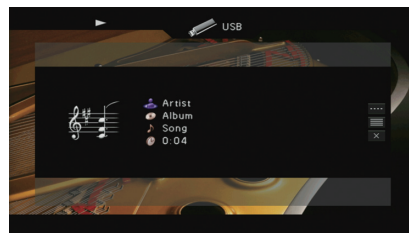

- To return to the previous screen, press RETURN.
- Files not supported by the unit cannot be selected.
- If the unit detects a series of unsupported files (such as images and hidden files) during playback, playback stops automatically.

Browse screen



1 Status indicators

Display the current repeat/shuffle settings (p.59) and playback status (such as play/pause).

2 List name

3 Contents list

Displays the list of USB storage device contents. Use the cursor keys to select an item and press ENTER to confirm the selection.

4 Item number/total

5 Operation menu

Press the cursor key (▷) and then use the cursor keys (△/▽) to select an item. Press ENTER to confirm the selection.

Menu	Function
1 Page Up	Moves to the previous/next page of the list.
1 Page Down	
10 Pages Up	Moves 10 pages forward/backward.
10 Pages Down	
Return	Returns to the higher-level list.
Now Playing	Moves to the playback screen.
Screen Off	Closes the screen display and shows the background. Press one of the menu operation keys to redisplay it.

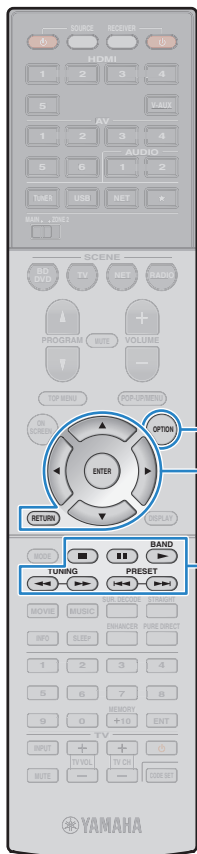

■ Playback screen

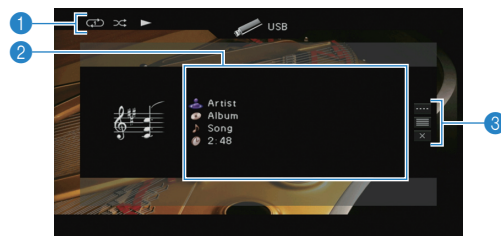

1 Status indicators

Display the current repeat/shuffle settings (p.59) and playback status (such as play/pause).

2 Playback information

Displays the artist name, album name, song title, and elapsed time. Use the cursor keys (Δ/∇) to select scrollable information.

3 Operation menu

Press the cursor key (\triangleright) and then use the cursor keys (Δ/∇) to select an item. Press ENTER to confirm the selection. To close the submenu, press RETURN.

Menu	Submenu	Function
	\blacktriangleright	Resumes playback from pause.
	\blacksquare	Stops playback.
Play Control	\blacksquare	Stops playback temporarily.
	\lll	Skips forward/backward.
	\ggg	
Browse		Moves to the browse screen.
Screen Off		Closes the screen display and shows the background. Press one of the menu operation keys to redisplay it.



- You can also use the external device operation keys (\blacktriangleright , \blacksquare , \blacksquare , \lll , \ggg) on the remote control to control playback.

■ Repeat/shuffle settings

You can configure the repeat/shuffle settings for playback of USB storage device contents.

1 When “USB” is selected as the input source, press **OPTION**.

2 Use the cursor keys to select “Shuffle” (Shuffle) or “Repeat” (Repeat) and press **ENTER**.



- To return to the previous screen during menu operations, press RETURN.
- Texts in parentheses denote indicators on the front display.

3 Use the cursor keys ($\triangleleft/\triangleright$) to select a setting.

Item	Setting	Function
Shuffle (Shuffle)	Off (Off)	Turns off the shuffle function.
	On (On)	Plays back songs in the current album (folder) in random order. “ \times ” appears on the TV screen.
Repeat (Repeat)	Off (Off)	Turns off the repeat function.
	One (One)	Plays back the current song repeatedly. “ C ” appears on the TV screen.
	All (All)	Plays back all songs in the current album (folder) repeatedly. “ C ” appears on the TV screen.

4 To exit from the menu, press **OPTION**.

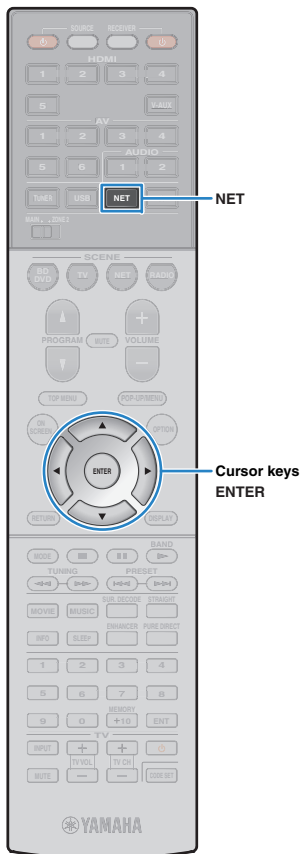

Playing back music stored on media servers (PCs/NAS)

You can play back music files stored on your PC or DLNA-compatible NAS on the unit.



- To use this function, the unit and your PC must be connected to the same router (p.31). You can check whether the network parameters (such as the IP address) are properly assigned to the unit in "Network" (p.98) in the "Information" menu.
- The unit supports playback of WAV (PCM format only), MP3, WMA, MPEG-4 AAC and FLAC files (1- or 2-channel audio only).
- The unit is compatible with sampling rates of up to 192 kHz for WAV and FLAC files, and 48 kHz for other files.
- To play back FLAC files, you need to install server software that supports sharing of FLAC files via DLNA on your PC or use a NAS that supports FLAC files.

Media sharing setup

To play back music files stored on your PC or DLNA-compatible NAS, first you need to configure the media sharing setting on each music server.

■ For a PC with Windows Media Player installed

- 1 Check that Windows Media Player 11 or later is installed on your PC.
- 2 In the media sharing settings, enable media sharing and allow media to be shared with the device.

■ For a PC or a NAS with other DLNA server software installed

Refer to the instruction manual for the device or software and configure the media sharing settings.

Playback of PC music contents

Follow the procedure below to operate the PC music contents and start playback.

You can control the PC/NAS with the menu displayed on the TV screen.

- 1 Press NET repeatedly to select "SERVER" as the input source.

The browse screen is displayed on the TV.

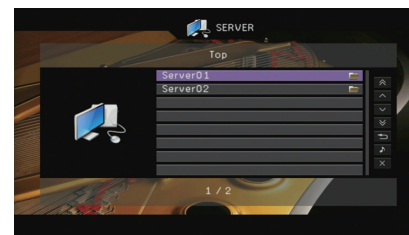

- If playback of a music file selected from the unit is ongoing on your PC, the playback screen is displayed.

- 2 Use the cursor keys to select a music server and press ENTER.

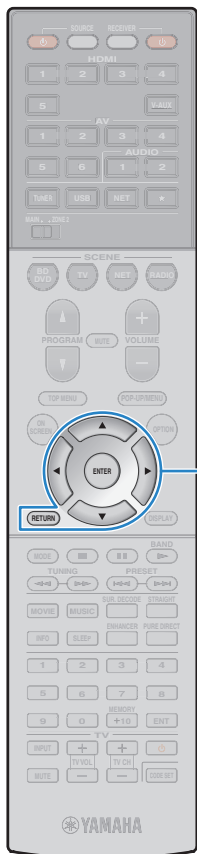

Menu operation keys
Cursor keys
ENTER
RETURN

3 Use the cursor keys to select an item and press ENTER.

If a song is selected, playback starts and the playback screen is displayed.

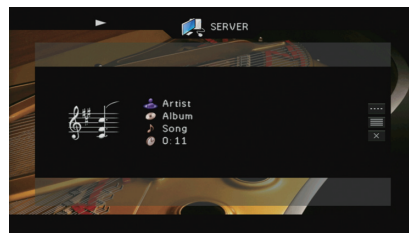

- To return to the previous screen, press RETURN.
- Files not supported by the unit cannot be selected.
- If the unit detects a series of unsupported files (such as images and hidden files) during playback, playback stops automatically.

■ Browse screen

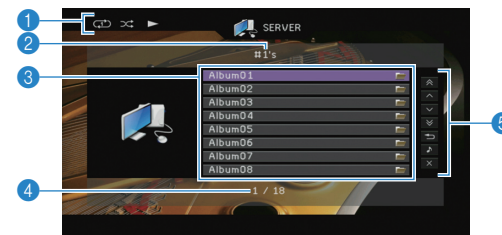

1 Status indicators

Display the current repeat/shuffle settings (p.62) and playback status (such as play/pause).

2 List name

3 Contents list

Displays the list of PC content. Use the cursor keys to select an item and press ENTER to confirm the selection.

4 Item number/total

5 Operation menu

Press the cursor key (▷) and then use the cursor keys (△/▽) to select an item. Press ENTER to confirm the selection.

Menu	Function
1 Page Up	Moves to the previous/next page of the list.
1 Page Down	
10 Pages Up	Moves 10 pages forward/backward.
10 Pages Down	
Return	Returns to the higher-level list.
Now Playing	Moves to the playback screen.
Screen Off	Closes the screen display and shows the background. Press one of the menu operation keys to redisplay it.

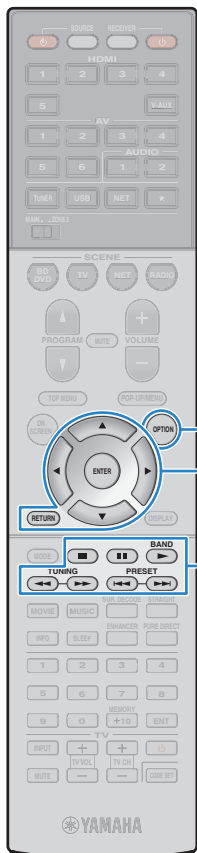

■ Playback screen

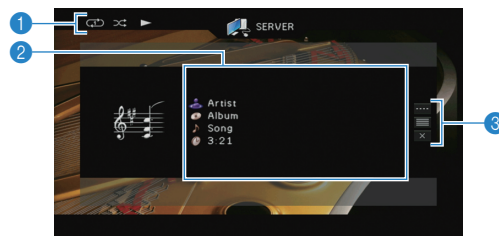

1 Status indicators

Display the current repeat/shuffle settings (p.62) and playback status (such as play/pause).

2 Playback information

Displays the artist name, album name, song title, and elapsed time. Use the cursor keys (Δ/∇) to select scrollable information.

3 Operation menu

Press the cursor key (\triangleright) and then use the cursor keys (Δ/∇) to select an item. Press ENTER to confirm the selection. To close the submenu, press RETURN.

Menu	Submenu	Function
		Resumes playback from pause.
		Stops playback.
Play Control		Stops playback temporarily.
		Skips forward/backward.
Browse		Moves to the browse screen.
Screen Off		Closes the screen display and shows the background. Press one of the menu operation keys to redisplay it.



- You can also use the external device operation keys (, , , ,) on the remote control to control playback.
- You can also use a DLNA-compatible Digital Media Controller (DMC) to control playback. For details, see "DMC Control" (p.77).

■ Repeat/shuffle settings

You can configure the repeat/shuffle settings for the playback of PC music content.

1 When "SERVER" is selected as the input source, press **OPTION**.

2 Use the cursor keys to select "Shuffle" (Shuffle) or "Repeat" (Repeat) and press **ENTER**.



- To return to the previous screen during menu operations, press RETURN.
- Text in parentheses denotes indicators on the front display.

3 Use the cursor keys ($\triangleleft/\triangleright$) to select a setting.

Item	Setting	Function
Shuffle (Shuffle)	Off (Off)	Turns off the shuffle function.
	On (On)	Plays back songs in the current album (folder) in random order. " " appears on the TV screen.
Repeat (Repeat)	Off (Off)	Turns off the repeat function.
	One (One)	Plays back the current song repeatedly. " " appears on the TV screen.
	All (All)	Plays back all songs in the current album (folder) repeatedly. " " appears on the TV screen.

4 To exit from the menu, press **OPTION**.

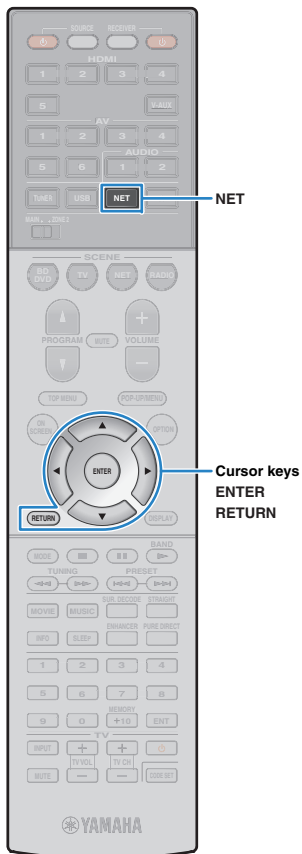

Listening to Internet radio

You can listen to Internet radio stations from all over the world. You can control the Internet radio with the menu displayed on the TV screen.



- To use this function, the unit must be connected to the Internet (p.31). You can check whether the network parameters (such as the IP address) are properly assigned to the unit in "Network" (p.98) in the "Information" menu.
- You may not be able to receive some Internet radio stations.
- The unit uses the vTuner Internet radio station database service.
- This service may be discontinued without notice.

1 Press NET repeatedly to select "NET RADIO" as the input source.

The browse screen is displayed on the TV.

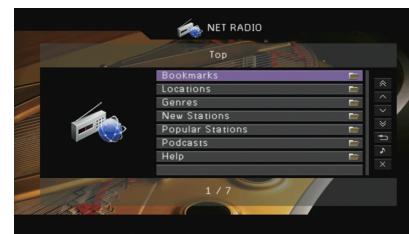

2 Use the cursor keys to select an item and press ENTER.

If an Internet radio station is selected, playback starts and the playback screen is displayed.

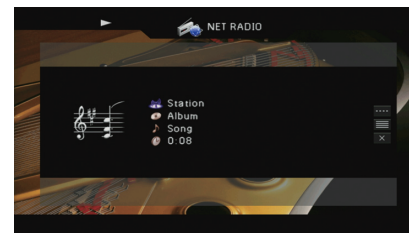

- To return to the previous screen, press RETURN.

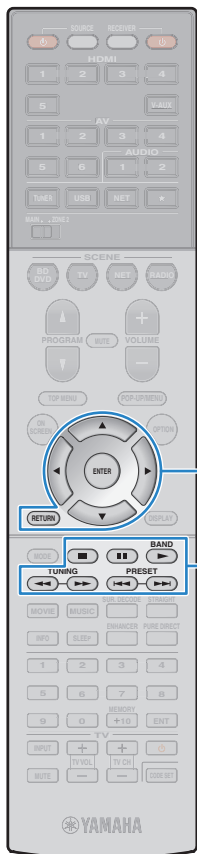

Menu operation keys
Cursor keys
ENTER
RETURN

External device
operation keys

Browse screen

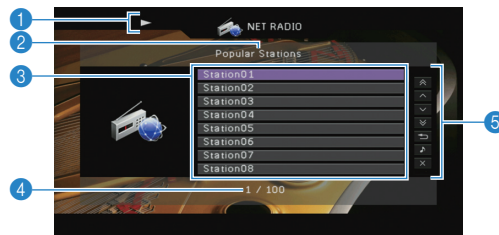

1 Playback indicator

2 List name

3 Contents list

Displays the list of Internet radio content. Use the cursor keys to select an item and press ENTER to confirm the selection.

4 Item number/total

5 Operation menu

Press the cursor key (▷) and then use the cursor keys (Δ/▽) to select an item. Press ENTER to confirm the selection.

Menu	Function
1 Page Up	Moves to the previous/next page of the list.
1 Page Down	
10 Pages Up	Moves 10 pages forward/backward.
10 Pages Down	
Return	Returns to the higher-level list.
Now Playing	Moves to the playback screen.
Screen Off	Closes the screen display and shows the background. Press one of the menu operation keys to redisplay it.



- You can register your favorite Internet radio stations to the "Bookmarks" folder by selecting "NET RADIO" as the input source on the unit and then accessing the following website with the web browser on your PC. To use this feature, you need the vTuner ID of the unit and your e-mail address to create your personal account. You can check the vTunerID (MAC address of the unit) in "Network" (p.98) in the "Information" menu.
<http://yradio.vtuner.com/>

Playback screen

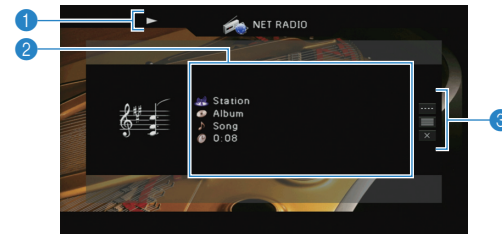

1 Playback indicator

2 Playback information

Displays the station name, album name, song title, and elapsed time. Use the cursor keys (Δ/▽) to select scrollable information.

3 Operation menu

Press the cursor key (▷) and then use the cursor keys (Δ/▽) to select an item. Press ENTER to confirm the selection.

To close the submenu, press RETURN.

Menu	Submenu	Function
Play Control	■	Stops playback.
Browse		Moves to the browse screen.
Screen Off		Closes the screen display and shows the background. Press one of the menu operation keys to redisplay it.



- You can also use the external device operation key (■) on the remote control to stop playback.
- Some information may not be available depending on the station.

Playing back iTunes/iPod music via a network (AirPlay)

The AirPlay function allows you to play back iTunes/iPod music on the unit via network.

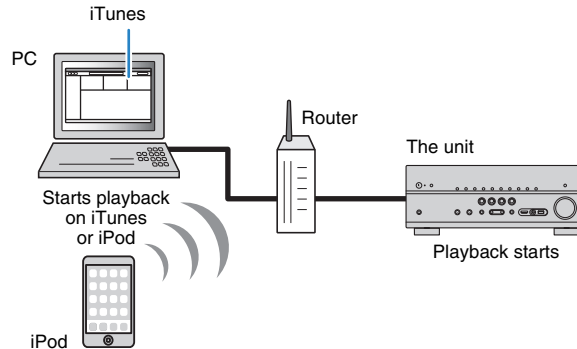

- To use this function, the unit and your PC or iPod must be connected to the same router (p.31). You can check whether the network parameters (such as the IP address) are properly assigned to the unit in "Network" (p.98) in the "Information" menu.

Supported iTunes/iPod (as of February 2013)

- iTunes 10.2.2 or later (Windows/Mac)
- iPod touch, iPhone or iPad with iOS 4.3.3 or later

Playback of iTunes/iPod music contents

Follow the procedure below to play back iTunes/iPod music contents on the unit.

1 Turn on the unit, and start iTunes on the PC or display the playback screen on the iPod.

If the iTunes/iPod recognizes the unit, the AirPlay icon () appears.

iTunes (example)



iPod (example)

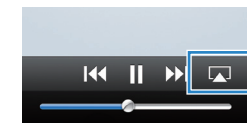

- If the icon does not appear, check whether the unit and PC/iPod are connected to the router properly.

2 On the iTunes/iPod, click (tap) the AirPlay icon and select the unit (network name of the unit) as the audio output device.

iTunes (example)

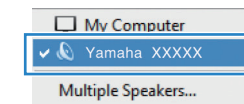

iPod (example)

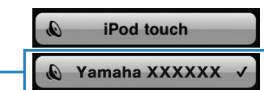

Network name of the unit

3 Select a song and start playback.

The unit automatically selects "AirPlay" as the input source and starts playback.

The playback screen is displayed on the TV.

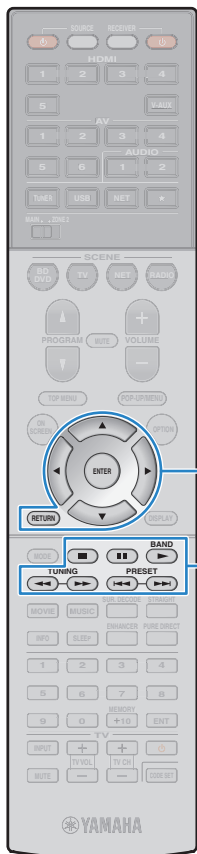

Menu operation keys
Cursor keys
ENTER
RETURN

External device
operation keys



- The playback screen is available only when your TV is connected to the unit via HDMI.



- You can turn on the unit automatically when starting playback on iTunes or iPod by setting "Network Standby" (p.92) in the "Setup" menu to "On".
- You can edit the network name (the unit's name on the network) displayed on iTunes/iPod in "Network Name" (p.93) in the "Setup" menu.
- If you select the other input source on the unit during playback, playback on the iTunes/iPod stops automatically.
- You can adjust the unit's volume from the iTunes/iPod during playback. To disable volume controls from iTunes/iPod, set "Volume Interlock" (p.77) in the "Input" menu to "Off".

Caution

- When you use iTunes/iPod controls to adjust volume, the volume may be unexpectedly loud. This could result in damage to the unit or speakers. If the volume suddenly increases during playback, stop playback on the iTunes/iPod immediately.

■ Playback screen

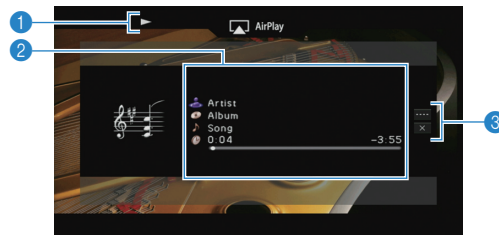

1 Playback indicator

2 Playback information

Displays the artist name, album name, song title, and elapsed/remaining time.

Use the cursor keys (Δ/∇) to select scrollable information.

3 Operation menu

Press the cursor key (\triangleright) and then use the cursor keys (Δ/∇) to select an item. Press ENTER to confirm the selection.

To close the submenu, press RETURN.

Menu	Submenu	Function
Play Control		Resumes playback from pause.
		Stops playback temporarily.
		Skips forward/backward.
Screen Off		Closes the screen display and shows the background. Press one of the menu operation keys to redisplay it.



- You can also use the external device operation keys (\blacktriangleright , \blacksquare , \blacksquare , \blacktriangleleft , \blacktriangleright) on the remote control to control playback.



- To control iTunes playback with the remote control of the unit, you need to configure the iTunes preferences to enable iTunes control from remote speakers in advance.

iTunes (example of English version)

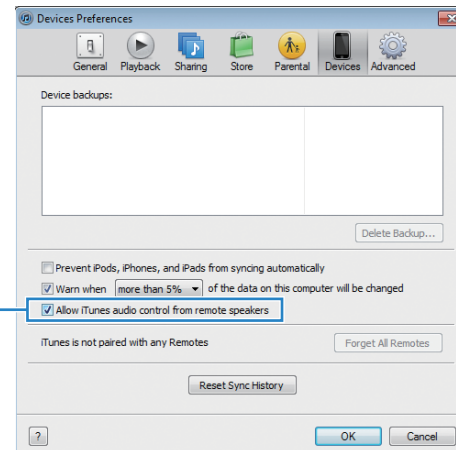

Check this box

Playing back music in multiple rooms (multi-zone)

The multi-zone function allows you to play back different input sources in the room where the unit is installed (main zone) and in another room (Zone2).

For example, while you are watching TV in the living room (main zone), another person can listen to radio in the study room (Zone2).

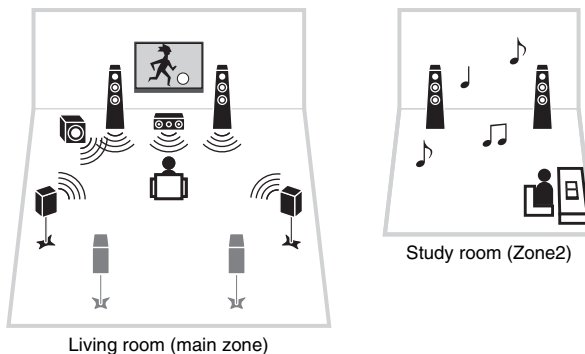

- Analog audio sources (including FM/AM radio), and USB and network sources can be output to Zone2. To listen to the playback of an external device in Zone2, you need to connect the device to the AUDIO jacks (AV 5–6 or AUDIO 1–2 jacks) of the unit.

Preparing Zone2

Connect the device that will be used in Zone2 to the unit. The connection method varies depending on the amplifier being used (the unit or an external amplifier).

Caution

- Remove the unit's power cable from the AC wall outlet before connecting speakers or an external amplifier.
- Ensure that the core wires of the speaker cable do not touch one another or come into contact with the unit's metal parts. Doing so may damage the unit or the speakers. If the speaker cables short circuit, "Check SP Wires" will appear on the front display when the unit is turned on.

■ Using the unit's internal amplifier

Connect the speakers placed in Zone2 to the unit with speaker cables.

To utilize the EXTRA SP terminals for Zone2 speakers, set "Power Amp Assign" (p.85) in the "Setup" menu to "7ch + 1ZONE" after connecting the power cable to an AC wall outlet.

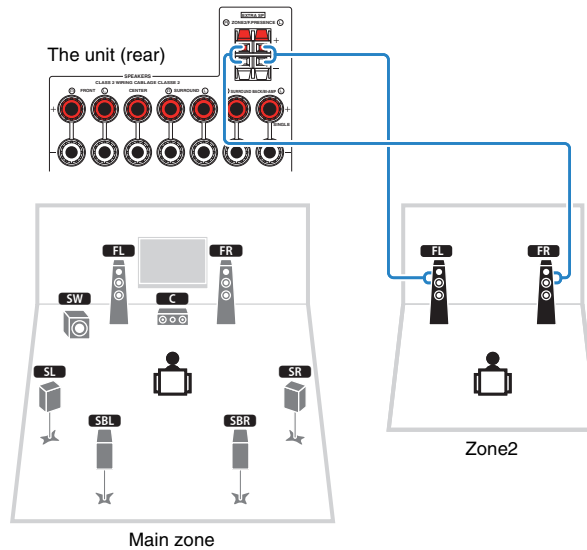

- When Zone2 output is enabled (p.70), the surround back speakers in the main zone do not output sound.

■ Using an external amplifier

Connect the external amplifier (with volume control) placed in Zone2 to the unit with a stereo pin cable.

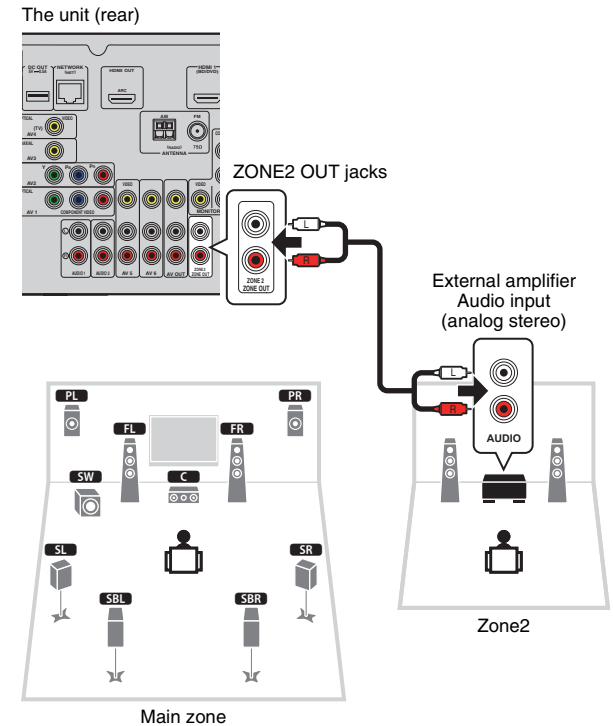

■ Operating the unit from Zone2 (remote connection)

You can operate the unit and external devices from Zone2 using the supplied remote control if you connect an infrared signal receiver/emitter to the unit's REMOTE IN/OUT jacks.



- To operate external devices with the supplied remote control, you must register a remote control code for each device before using (p.102).

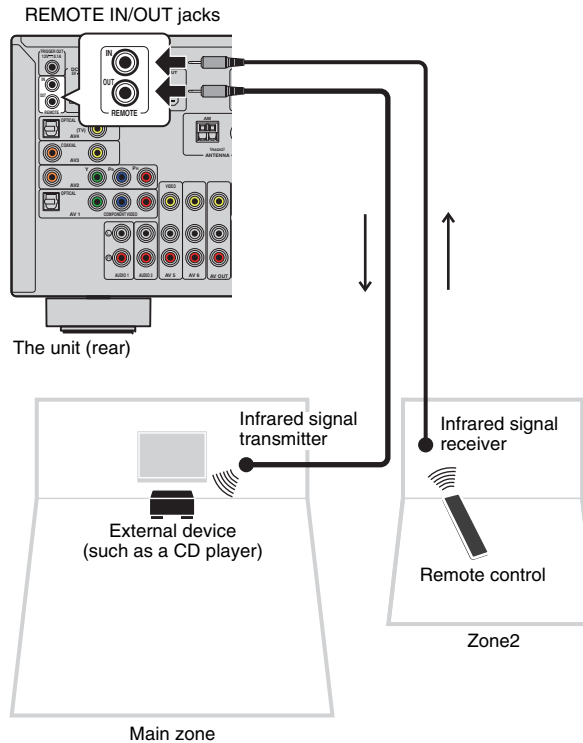

Remote connections between Yamaha products

An infrared signal transmitter is not required if you are using Yamaha products that support remote connections, as the unit does. You can transmit remote control signals by connecting the REMOTE IN/OUT jacks with monaural mini-jack cables and an infrared signal receiver.

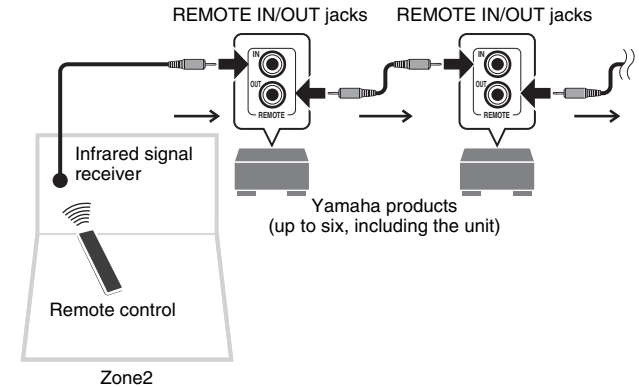

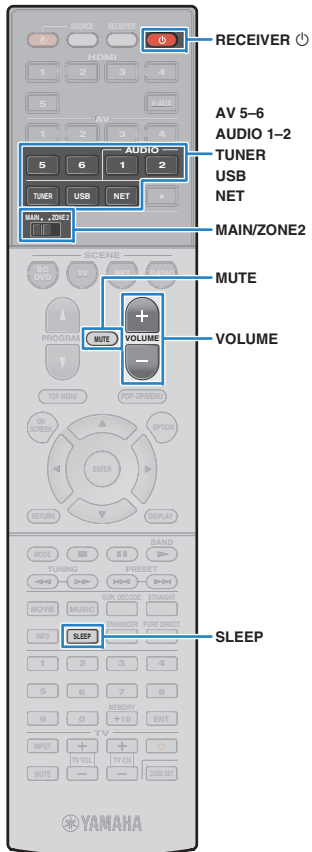

Controlling Zone2

1 Set MAIN/ZONE2 to “ZONE2”.

2 Press RECEIVER .

Each time you press the key, Zone2 output is enabled or disabled.

When Zone2 output is enabled, “ZONE2” lights up in the front display.

3 Use the following keys to select an input source.

AV 5–6: AV 5–6 (AUDIO) jacks

AUDIO 1–2: AUDIO 1–2 jacks

TUNER: FM/AM radio

USB: USB jack (on the front panel)

NET: NETWORK jack (press repeatedly to select a desired network source)



- You cannot select USB and network sources exclusively for each zone. For example, if you select “SERVER” for Zone2 when “USB” is selected for the main zone, the input source for the main zone also switches to “SERVER”.

4 Start playback on the external device or select a radio station.

Refer to the instruction manual for the external device.

For details on the following operations, see the corresponding pages.

- Listening to FM/AM radio (p.48)
- Playing back iPod music (p.53)
- Playing back music stored on a USB storage device (p.57)
- Playing back music stored on media servers (PCs/NAS) (p.60)
- Listening to Internet radio (p.63)
- Playing back iTunes/iPod music via a network (AirPlay) (p.65)



- The on-screen operations are not available for Zone2. Use the front display to control Zone2.
- AirPlay is available in Zone2 only when AirPlay playback is ongoing in the main zone.



- To set the sleep timer (120 min, 90 min, 60 min, 30 min, off), press SLEEP repeatedly. The Zone2 output will be disabled after a specified period of time.
- To adjust the Zone2 volume, press VOLUME or MUTE (when using the unit’s internal amplifier). When using an external amplifier, use the volume control on it.

Caution

- To avoid unexpected noise, never play back DTS-CDs in Zone2.

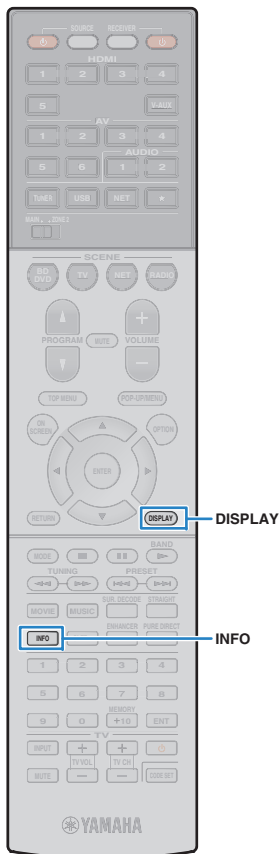

Viewing the current status

Switching information on the front display

- 1 **Press INFO.**
Each time you press the key, the displayed item changes.



About 3 seconds later, the corresponding information for the displayed item appears.

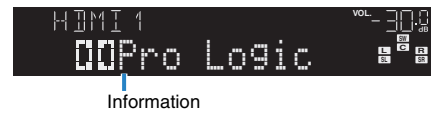

- Available items vary depending on the selected input source. The displayed item can also be applied separately to each input source group.

Input source group	Item
HDMI 1-5 V-AUX AV 1-6 AUDIO 1-2	Input (input source name), DSP Program (sound mode name), Audio Decoder (decoder name*)
TUNER	Frequency (frequency), DSP Program (sound mode name), Audio Decoder (decoder name*) * (Europe model only) Radio Data System data is also available when the unit is tuned into a Radio Data System broadcasting station (p.50).
USB SERVER AirPlay	Song (song title), Artist (artist name), Album (album name), DSP Program (sound mode name), Audio Decoder (decoder name*) * During simple playback of iPod: Input (input source name), DSP Program (sound mode name), Audio Decoder (decoder name*)
NET RADIO	Song (song title), Album (album name), Station (station name), DSP Program (sound mode name), Audio Decoder (decoder name*)

* The name of the audio decoder currently activated is displayed. If no audio decoder is activated, "Decoder Off" appears.

Viewing the status information on the TV

- 1 **Press DISPLAY.**
The following information is displayed on the TV.

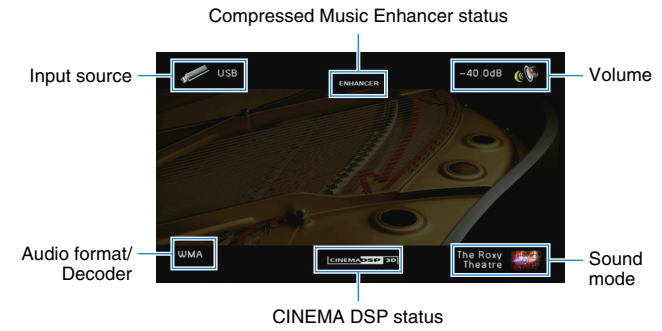

- 2 **To close the information display, press DISPLAY.**

Configuring playback settings for different playback sources (Option menu)

You can configure separate playback settings for different playback sources. This menu is available on the front panel (or on the TV screen), allowing you to easily configure settings during playback.

1 Press **OPTION**.



Front display

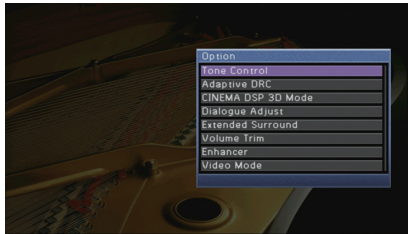

TV screen

2 Use the cursor keys to select an item and press **ENTER**.



- To return to the previous screen during menu operations, press **RETURN**.

3 Use the cursor keys (**</>**) to select a setting.

4 To exit from the menu, press **OPTION**.

Option menu items



- Available items vary depending on the selected input source.
- Text in parentheses denotes indicators on the front display.

Item	Function	Page	
Tone Control (Tone Control)	Adjusts the high-frequency range and low-frequency range of sounds.	73	
Adaptive DRC (Adaptive DRC)	Sets whether the dynamic range (from maximum to minimum) is automatically adjusted when the volume is adjusted.	73	
CINEMA DSP 3D Mode (CINEMA DSP 3D)	Enables/disables CINEMA DSP 3D.	73	
Dialogue Adjust (Dialog Adjust)	Dialogue Level (Dialog Lvl)	Adjusts the volume of dialogue sounds.	73
	Dialogue Lift (Dialog Lift)	Adjusts the perceived height of dialogue sounds.	73
Extended Surround (EXTD Surround)	Selects how to play back 5.1- to 7.1-channel sources when surround back speakers are used.	74	
Volume Trim (Volume Trim)	Input Trim (In.Trim)	Corrects volume differences between input sources.	74
	Subwoofer Trim (SW.Trim)	Fine-adjusts the subwoofer volume.	74
Enhancer (Enhancer)	Enables/disables Compressed Music Enhancer.	74	
Video Mode (Video Mode)	Enables/disables the video signal processing settings configured in the "Setup" menu.	74	
FM Mode (FM Mode)	Switches between stereo and monaural for FM radio reception.	74	
Traffic Program (TrafficProgram)	(Europe model only) Automatically searches for a traffic information station.	50	
Repeat (Repeat)	Configures the repeat setting for the iPod (p.56), USB storage device (p.59), or media server (p.62).	—	
Shuffle (Shuffle)	Configures the shuffle setting for the iPod (p.56), USB storage device (p.59), or media server (p.62).	—	

■ Tone Control (Tone Control)

Adjusts the high-frequency range (Treble) and low-frequency range (Bass) of sounds.

Choices

Treble (Treble), Bass (Bass)

Setting range

-6.0 dB to Bypass (Bypass) to +6.0 dB, *0.5 dB increments

Default

Bypass (Bypass)



- If you set an extreme value, sounds may not match those from other channels.

Adjusting with the front panel controls

- ① Press TONE CONTROL to select "Treble" or "Bass".
- ② Press PROGRAM to make an adjustment.

■ Adaptive DRC (Adaptive DRC)

Sets whether the dynamic range (from maximum to minimum) is automatically adjusted when the volume level is adjusted. When it is set to "On", it is useful for listening to playback at a low volume at night.

Settings

On (On)	Automatically adjusts the dynamic range.
Off (Off) (default)	The dynamic range is not automatically adjusted.

If "On" is selected, the dynamic range becomes narrow at a low volume and wide at a high volume.

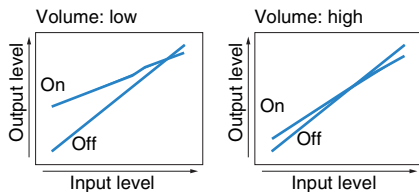

■ CINEMA DSP 3D Mode (CINEMA DSP 3D)

Enables/disables CINEMA DSP 3D (p.43). If this function is set to "On", CINEMA DSP 3D functions with the selected sound programs (except 2ch Stereo and 7ch Stereo).

Settings

On (On) (default)	Enables CINEMA DSP 3D.
Off (Off)	Disables CINEMA DSP 3D.

■ Dialogue Adjust (Dialogue Adjust)

Adjusts the volume or perceive height of dialogue sounds.

□ Dialogue Level (Dialogue Lvl)

Adjusts the volume of dialogue sounds. If dialogue sounds cannot be heard clearly, you can turn up its volume by increasing this setting.

Setting range

0 to 3

Default

0

□ Dialogue Lift (Dialogue Lift)

Adjusts the perceived height of dialogue sounds. If the dialogue sounds as if it is coming from below the TV screen, you can raise its perceived height by increasing this setting.



- This setting is available only when one of the following conditions is met.
 - One of the sound programs (except for 2ch Stereo and 7ch Stereo) is selected when presence speakers are used.
 - Virtual Presence Speaker (VPS) (p.43) is working.
(You may hear dialogue sounds from the surround speakers depending on the listening position.)

Setting range

0 to 5 (The bigger the value the higher the position)

Default

0

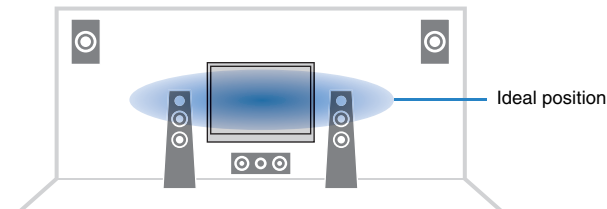

Extended Surround (EXTD Surround)

Selects how to play back 5.1- to 7.1-channel sources when surround back speakers are used.

Settings

Auto (Auto) (default)	Automatically selects the most suitable decoder if signals that contain surround back channel signals are input, and reproduces the signals in 6.1- or 7.1-channel. If two surround back speakers are connected, the unit reproduces the 5.1-channel signals in 7.1-channel.
<input checked="" type="checkbox"/> PLIIx Movie <input checked="" type="checkbox"/> PLIIxMo	Always reproduces signals in 7.1-channel using the Dolby Pro Logic IIx Movie decoder. This setting is available only when two surround back speakers are connected.
<input checked="" type="checkbox"/> PLIIx Music <input checked="" type="checkbox"/> PLIIxMu	Always reproduces signals in 6.1- or 7.1-channel using the Dolby Pro Logic IIx Music decoder. This setting is available only when one or two surround back speakers are connected.
EX/ES (EX/ES)	Automatically selects the Dolby EX or DTS-ES decoder, and reproduces signals in 6.1- or 7.1-channel.
Off (Off)	Always reproduces signals in their original channels. (Even when DTS-ES or Dolby Digital Surround EX signal is input, the unit reproduces the signal in 5.1-channel.)



- Some early Dolby Digital Surround EX or DTS-ES sources do not contain a flag for reproducing surround back channel. We recommend you set "Extended Surround" to " PLIIx Movie" or "EX/ES" when playing back those sources.

Volume Trim (Volume Trim)

Fine-adjusts volume difference between input sources or subwoofer volume.

Input Trim (In.Trim)

Corrects volume differences between input sources. If you are bothered by volume differences when switching between input sources, use this function to correct it.



- This setting is applied separately to each input source.

Setting range

-6.0 dB to +6.0 dB (0.5 dB increments)

Default

0.0 dB

Subwoofer Trim (SW.Trim)

Fine-adjusts the subwoofer volume.

Setting range

-6.0 dB to +6.0 dB (0.5 dB increments)

Default

0.0 dB

Enhancer (Enhancer)

Enables/disables Compressed Music Enhancer (p.47).



- This setting is applied separately to each input source.
- You can also use ENHANCER on the remote control to enable/disable Compressed Music Enhancer (p.47).

Settings

Off (Off)	Disables Compressed Music Enhancer.
On (On)	Enables Compressed Music Enhancer.

Default

TUNER, USB, (network sources): On (On)

Others: Off (Off)

Video Mode (Video Mode)

Enables/disables the video signal processing (resolution and aspect ratio) settings configured in "Processing" (p.89) in the "Setup" menu.

Settings

Processing (Processing)	Enables the video signal processing.
Direct (Direct) (default)	Disables the video signal processing.

FM Mode (FM Mode)

Switches between stereo and monaural for FM radio reception.

Settings

Stereo (Stereo) (default)	Receives FM radio in stereo sounds.
Mono (Mono)	Receives FM radio in monaural sounds.

CONFIGURATIONS

Configuring input sources (Input menu)

You can change the input source settings using the TV screen.

- 1 Press ON SCREEN.
- 2 Use the cursor keys to select “Input” and press ENTER.

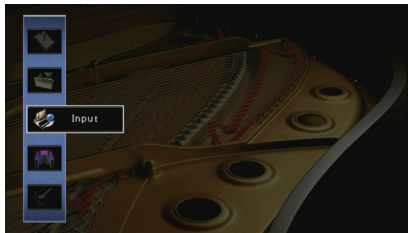

- 3 Use the cursor keys (</>) to select an input source to be configured and press the cursor key (Δ).

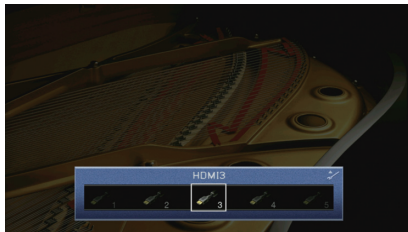

The input source of the unit also changes.



- You can still switch the input source by using cursor keys (</>) after Step 3.

- 4 Use the cursor keys (Δ/▽) to select an item and press ENTER.



- To return to the previous screen during menu operations, press RETURN.

- 5 Use the cursor keys to select a setting and press ENTER.

- 6 To exit from the menu, press ON SCREEN.

Input menu items



- Available items vary depending on the selected input source.

Item	Function	Page
Rename/Icon Select	Changes the input source name and icon.	76
Audio In	Combines the video jack of the selected input source with an audio jack of others.	76
Decoder Mode	Sets the format of digital audio playback to DTS.	76
Volume Interlock	Enables/disables volume controls from iTunes/iPod via AirPlay.	77
Video Out	Selects a video to be output with the audio input source.	77
DMC Control	Selects whether to allow a DLNA-compatible Digital Media Controller (DMC) to control playback.	77

Rename/Icon Select

Changes the input source name and icon displayed on the front display or TV screen.

Input sources

HDMI 1–5, V-AUX, AV 1–6, AUDIO 1–2, USB

Setup procedure

- 1 Use the cursor keys (</>) to select a template and press the cursor key (▽).



- You cannot change the template or icon for “USB” when an iPod is connected.

- 2 Use the cursor keys (</>) to select an icon and press the cursor key (▽).
- 3 Press ENTER to enter the name edit screen.
- 4 Use the cursor keys and ENTER to rename and select “ENTER” to confirm the entry.

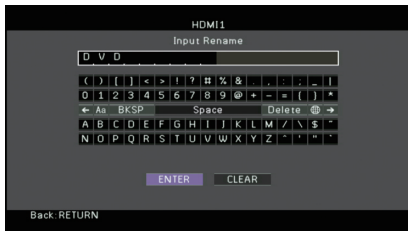

- To clear the entry, select “CLEAR”.

- 5 Use the cursor keys to select “OK” and press ENTER.



- To restore the default setting, select “RESET”.

- 6 To exit from the menu, press ON SCREEN.

Audio In

Combines the video jack of the selected input source with an audio jack of others. For example, use this function in the following cases.

- Connecting a playback device that supports HDMI video output, but not HDMI audio output
- Connecting a playback device that has component video jacks and analog stereo jacks (such as game consoles)

Input sources

HDMI 1–5, AV 1–2

Setup procedure

(To input audio through a digital optical jack)

Select “AV1” or “AV4” and connect the device to the unit’s corresponding audio jacks with a digital optical cable.

(To input audio through a digital coaxial jack)

Select “AV2” or “AV3” and connect the device to the unit’s corresponding audio jacks with a digital coaxial cable.

(To input audio through analog audio jacks)

Select “AV5”, “AV6”, “AUDIO1”, or “AUDIO2”, and connect the device to the unit’s corresponding audio jacks with a stereo pin cable.

Decoder Mode

Sets the format of digital audio playback to “DTS”.

For example, if the unit does not detect DTS audio and outputs noise, set “Decoder Mode” to “DTS”.

Input sources

HDMI 1–5, V-AUX, AV 1–4

Settings

Auto (default)	Automatically selects an audio format to match the input audio signal.
DTS	Selects DTS only. (Other audio signals are not reproduced.)

■ Volume Interlock

Enables/disables volume controls from iTunes/iPod via AirPlay.

Input sources

AirPlay

Settings

Off	Disables volume controls from iTunes/iPod.
Limited (default)	Enables volume controls from iTunes/iPod within the limited range (-80 dB to 0 dB and mute).
Full	Enables volume controls from iTunes/iPod in the full range (-80 dB to +16.5 dB and mute).

■ Video Out

Selects a video to be output with the audio input source.

Input sources

TUNER, (network sources)

Settings

Off (default)	Does not output video.
HDMI 1–5, AV 1–6, V-AUX	Outputs video input through the corresponding video input jacks.

■ DMC Control

Selects whether to allow DLNA-compatible Digital Media Controller (DMC) to control playback.

Input source

SERVER

Settings

Disable	Does not allow DMCs to control playback.
Enable (default)	Allows DMCs to control playback.



- A Digital Media Controller (DMC) is a device that can control other network devices through the network. When this function is enabled, you can control playback of the unit from DMCs (such as Windows Media Player 12) on the same network.

Configuring the SCENE function (Scene menu)

You can change the settings of the SCENE function (p.41) using the TV screen.

- 1 Press ON SCREEN.
- 2 Use the cursor keys to select “Scene” and press ENTER.

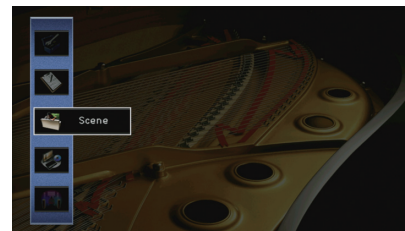

- 3 Use the cursor keys (</>) to select a scene to be configured and press the cursor key (Δ).

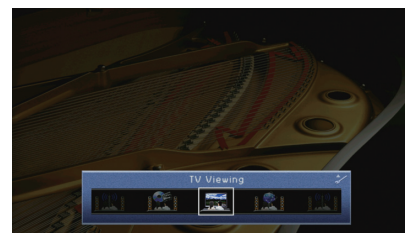

- You can still switch the scene by using cursor keys (</>) after Step 3.

4 Use the cursor keys (Δ/∇) to select an item and press ENTER.



5 Use the cursor keys and ENTER to change the setting.

6 To exit from the menu, press ON SCREEN.

Scene menu items

Item	Function	Page
Save	Registers the current settings in the selected scene.	78
Load	Loads the settings registered for the selected scene. You can also configure the SCENE link playback setting or view the scene assignments.	78
Rename/Icon Select	Changes the scene name and icon.	79
Reset	Restores the default settings for the selected scene.	79

Save

Registers the unit's current settings (input source, sound program/surround decoder, and Compressed Music Enhancer on/off in the selected scene.



- If you have changed the input assignment for a scene, you also need to change the external device assigned to the corresponding SCENE key (p.41).

Load

Loads the settings registered for the selected scene.

Select "DETAIL" to configure the SCENE link playback setting or view the scene assignments.

Device Control

Recalls a selected scene and starts its playback on an external device connected to the unit via HDMI. (SCENE link playback)

Settings

Off	Disables the SCENE link playback function.
HDMI Control	Enables SCENE link playback using HDMI Control signals. Select this if an HDMI Control-compatible device (such as a BD/DVD player) is connected to the unit via HDMI. It also turns on the TV if it supports HDMI Control.

Default

SCENE1 (BD/DVD), SCENE2 (TV): HDMI Control
SCENE3 (NET), SCENE4 (RADIO): Off



- To control playback of an HDMI Control-compatible device by SCENE link playback, you need to set "HDMI Control" in the "Setup" menu to "On" and perform the HDMI Control link setup (p.119).

Detail

Displays the assignments of the selected scene.

Input	Input source to be used
Mode	Sound program/surround decoder to be used
Enhancer	Compressed Music Enhancer on/off

Rename/Icon Select

Changes the scene name and icon displayed on the front display or TV screen.

Setup procedure

- 1 Use the cursor keys (</>) to select an icon and press the cursor key (▽).



- 2 Press ENTER to enter the name edit screen.
- 3 Use the cursor keys and ENTER to rename and select "ENTER" to confirm the entry.



- To clear the entry, select "CLEAR".

- 4 Use the cursor keys to select "OK" and press ENTER.



- To restore the default setting, select "RESET".

- 5 To exit from the menu, press ON SCREEN.

Reset

Restores the default settings (p.41) for the selected scene.

Configuring sound programs/surround decoders (Sound Program menu)

You can change the settings of the sound programs and surround decoders using the TV screen.

- 1 Press ON SCREEN.
- 2 Use the cursor keys to select "Sound Program" and press ENTER.

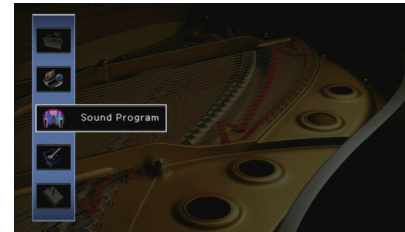

- 3 Use the cursor keys (</>) to select a sound program to be configured and press the cursor key (△).

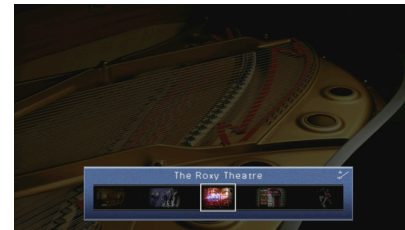

- You can still switch the sound program by using cursor keys (</>) after Step 3.

4 Use the cursor keys (Δ/▽) to select an item and press ENTER.



- To return to the previous screen during menu operations, press RETURN.
- To restore the default settings for the selected sound program, select "Reset".

5 Use the cursor keys to select a setting and press ENTER.

6 To exit from the menu, press ON SCREEN.

Sound Program menu items



- Available items vary depending on the selected sound program or surround decoder.

Settings for sound programs

Item	Function	Settings
Decode Type	Selects a surround decoder to be used in combination with the selected sound program.	<input type="checkbox"/> Pro Logic*, <input type="checkbox"/> PLIIx Movie (<input type="checkbox"/> PLII Movie), <input type="checkbox"/> PLIIx Music* (<input type="checkbox"/> PLII Music*), <input type="checkbox"/> PLIIx Game* (<input type="checkbox"/> PLII Game*), Neo:6 Cinema, Neo:6 Music* (* Available only when "SURROUND DECODER" is selected)
DSP Level	Adjusts the sound field effect level.	-6 dB to +3 dB (default: 0 dB) Higher to enhance the sound field effect, and lower to reduce it.
Initial Delay	Adjusts the delay between the direct sound and presence sound field generation.	1 ms to 99 ms Higher to enhance the delay effect, and lower to reduce it.
Surround Initial Delay	Adjusts the delay between the direct sound and surround sound field generation.	1 ms to 49 ms Higher to enhance the delay effect, and lower to reduce it.
Surround Back Initial Delay	Adjusts the delay between the direct sound and surround back sound field generation.	1 ms to 49 ms Higher to enhance the delay effect, and lower to reduce it.
Room Size	Adjusts the broadening effect of the presence sound field.	0.1 to 2.0
Surround Room Size	Adjusts the broadening effect of the surround sound field.	Higher to enhance the broadening effect, and lower to reduce it.
Surround Back Room Size	Adjusts the broadening effect of the surround back sound field.	Higher to enhance the broadening effect, and lower to reduce it.
Liveness	Adjusts the loss of the presence sound field.	0 to 10
Surround Liveness	Adjusts the loss of the surround sound field.	Higher to enhance the reflectivity, and lower to reduce it.
Surround Back Liveness	Adjusts the loss of the surround back sound field.	Higher to enhance the reflectivity, and lower to reduce it.

Item	Function	Settings
Reverb Time	Adjust the decay time of the rear reverberant sound.	1.0 s to 5.0 s Higher to enrich the reverberant sound and lower to have clear sound.
Reverb Delay	Adjusts the delay between the direct sound and reverberant sound generation.	0 ms to 250 ms Higher to enhance the delay effect, and lower to reduce it.
Reverb Level	Adjusts the volume of the reverberant sound.	0% to 100% Higher to strengthen the reverberant sound, and lower to weaken it.

The following items are available when you select “2ch Stereo” or “7ch Stereo”.

Sound program	Item	Function	Settings
2ch Stereo	Direct	Selects whether to automatically bypass the DSP circuit when an analog audio source is played back.	Auto (default), Off
	Level	Adjusts the entire volume.	-5 to +5 (default: 0)
	Front / Rear Balance	Adjusts the front and rear volume balance.	-5 to +5 (default: 0) Higher to enhance the front side, and lower to enhance the rear side.
7ch Stereo	Left / Right Balance	Adjusts the right and left volume balance.	-5 to +5 (default: 0) Higher to enhance the right side, and lower to enhance the left side.
	Height Balance	Adjust the height volume balance using the presence speakers.	0 to 10 (default: 5) Higher to enhance the upside, and lower to enhance the downside. (The presence speakers do not produce sounds when “Height Balance” is set to “0”.)
	Monaural Mix	Enables/disables monaural sound output.	Off (default), On



- Available items in “7ch Stereo” vary depending on the speaker system being used.

Settings for decoders

The following items are available when you set “Decode Type” of “Surround Decoder” to “ PLIIx Music” or “Neo:6 Music”.

Decode Type	Item	Function	Settings
PLIIx Music	Panorama	Adjusts the broadening effect of the front sound field.	Off (default), On Select “On” to wrap front right/left channel sounds around the field and generate a spacious sound field in combination with the surround sound field.
	Center Width	Adjusts the broadening effect of the center sound field.	0 to 7 (default: 3) Higher to enhance the broadening effect, and lower to reduce it (closer to center).
	Dimension	Adjusts the difference in level between the front and surround sound fields.	-3 to +3 (default: 0) Higher to strengthen the front sound field and lower to strengthen the surround sound field.
Neo:6 Music	Center Image	Adjusts the center orientation level (broadening effect) of the front sound field.	0.0 to 1.0 (default: 0.3) Higher to strengthen the center orientation level (less broadening effect) and lower to weaken (more broadening effect).

Configuring various functions (Setup menu)

You can configure the unit's various function with the menu displayed on the TV screen.

- 1 Press ON SCREEN.
- 2 Use the cursor keys to select "Setup" and press ENTER.

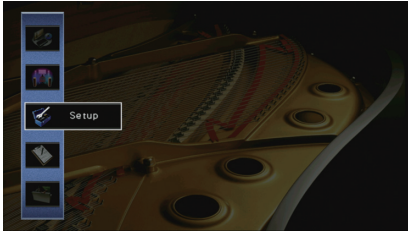

- 3 Use the cursor keys (</>) to select a menu.



- 4 Use the cursor keys (Δ/▽) to select an item and press ENTER.



- To return to the previous screen during menu operations, press RETURN.

- 5 Use the cursor keys to select a setting and press ENTER.
- 6 To exit from the menu, press ON SCREEN.

Setup menu items

Menu	Item	Function	Page		
Speaker	Auto Setup	Automatically optimizes the speaker settings (YPAO).	35		
	Manual Setup	Power Amp Assign	Selects a speaker system.	85	
		Configuration	Front	Selects the size of the front speakers.	85
			Center	Selects whether or not a center speaker is connected and its size.	85
			Surround	Selects whether or not surround speakers are connected and their size.	85
			Surround Back	Selects whether or not surround back speakers are connected and their size.	86
			Front Presence	Selects whether or not presence speakers are connected.	86
			Subwoofer	Selects whether or not a subwoofer is connected and its phase.	86
		Extra Bass	Sets the speakers to produce the front channel low-frequency components.	86	
		Bass Cross Over	Sets the lower limit of the low-frequency component that can be output from speakers whose size is set to "Small".	86	
		Distance	Sets the distance between each speaker and listening position.	87	
	Level	Adjusts the volume of each speaker.	87		
	Parametric EQ	Adjusts the tone with an equalizer.	87		
	Test Tone	Enables/disables the test tone output.	88		
	Sound	Delay Enable	Enables/disables the Lipsync adjustment for each input source.	88	
Lipsync		Auto/Manual Select	Selects the method to adjust the delay between video and audio output.	88	
		Adjustment	Adjusts the delay between video and audio output manually.	88	
Dynamic Range		Selects the dynamic range adjustment method for bitstream audio (Dolby Digital and DTS signals) playback.	88		
Max Volume		Sets the maximum volume to prevent excessive loudness.	89		
Initial Volume	Sets the initial volume for when this receiver is turned on.	89			
Adaptive DSP Level	Selects whether to automatically adjust the CINEMA DSP effect level when the volume is adjusted.	89			
Video	Video Mode	Enables/disables the video signal processing (resolution and aspect ratio).	89		
HDMI	HDMI Control	Enables/disables HDMI Control. You can also configure the relevant settings (such as ARC and TV audio input).	90		
	Audio Output	Selects a device to output audio.	91		
	Standby Through	Select whether to output videos/audio (input through HDMI jacks) to the TV when the unit is in standby mode.	91		

Menu	Item	Function	Page	
Network	IP Address	Configures the network parameters (such as IP address).	92	
	Network Standby	Selects whether to enable/disable the function that turns on the unit from other network devices.	92	
	MAC Address Filter	Sets the MAC address filter to limit access to the unit from other network devices.	92	
	Network Name	Edits the network name (the unit's name on the network) displayed on other network devices.	93	
Multi Zone	Main Zone Set	Zone Rename	Changes the zone name (for main zone) displayed on the TV screen.	93
	Zone2 Set	Max Volume	Sets the Zone2 maximum volume to prevent excessive loudness in the second zone.	94
		Initial Volume	Sets the Zone2 initial volume for when the unit is turned on.	94
		Zone Rename	Changes the zone name (for Zone2) displayed on the TV screen.	94
Function	Display Set	Dimmer (Front Display)	Adjusts the brightness of the front display.	94
		Short Message	Selects whether to display short messages on the TV screen when the unit is operated.	94
		Wallpaper	Selects the image to be used as wallpaper on the TV.	95
	Trigger Output	Trigger Mode	Specifies the condition for the TRIGGER OUT jack to function.	95
		Target Zone	Specifies the zone with which the TRIGGER OUT jack functions are synchronized.	95
	DC OUT	Power Mode	Selects how to supply power through the DC OUT jack.	95
	Memory Guard		Prevents accidental changes to the settings.	96
ECO	Auto Power Standby	Sets the amount of time for the auto-standby function.	96	
	ECO Mode	Enables/disables the eco mode (power saving mode).	96	
Language		Select an on-screen menu language.	97	

Speaker (Manual Setup)

Configures the speaker settings manually.

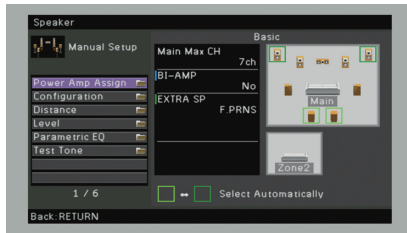

Power Amp Assign

Selects a speaker system.

In addition to the 5.1- or 7.1-channel speaker system, various speaker configurations are possible using the presence speakers, Zone2 speakers, or bi-amp connection.

Settings

Basic (default)	Select this option when you use a normal speaker system (not using Zone2 speakers or a bi-amp connection).
7ch +1ZONE	Select this option when you use Zone2 speakers (p.68) in addition to the speaker system in the main zone.
5ch BI-AMP	Select this option when you connect front speakers that support bi-amp connections (p.19).

Configuration

Configures the output characteristics of the speakers.



- When you configure the speaker size, select "Large" if the woofer diameter of your speaker is 16 cm (6-1/4") or larger or "Small" if it is smaller than 16 cm (6-1/4").

Front

Selects the size of the front speakers.

Settings

Large	Select this option for large speakers. The front speakers will produce all of the front channel frequency components.
Small (default)	Select this option for small speakers. The subwoofer will produce front channel low-frequency components (configurable in "Bass Cross Over").



- "Front" is automatically set to "Large" when "Subwoofer" is set to "None".

Center

Selects whether or not a center speaker is connected and its size.

Settings

Large	Select this option for large speakers. The center speaker will produce all of the center channel frequency components.
Small (default)	Select this option for small speakers. The subwoofer or front speakers will produce center channel low-frequency components (configurable in "Bass Cross Over").
None	Select this option when no center speaker is connected. The front speakers will produce center channel audio.

Surround

Selects whether or not surround speakers are connected and their sizes.

Settings

Large	Select this option for large speakers. The surround speakers will produce all of the surround channel frequency components.
Small (default)	Select this option for small speakers. The subwoofer or front speakers will produce surround channel low-frequency components (configurable in "Bass Cross Over").
None	Select this option when no surround speakers are connected. The front speakers will produce surround channel audio. Virtual CINEMA DSP works when you select a sound program.

❑ Surround Back

Selects whether or not surround back speakers are connected and their sizes.

Settings

Large x1	Select this option when one large speaker is connected. The surround back speaker will produce all of the surround back channel frequency components.
Large x2	Select this option when two large speakers are connected. The surround back speakers will produce all of the surround back channel frequency components.
Small x1	Select this option when one small speaker is connected. The subwoofer or front speakers will produce surround back channel low-frequency components (configurable in "Bass Cross Over").
Small x2 (default)	Select this option when two small speakers are connected. The subwoofer or front speakers will produce surround back channel low-frequency components (configurable in "Bass Cross Over").
None	Select this option when no surround back speakers are connected. The surround speakers will produce surround back channel audio.



- This setting is not available when "Power Amp Assign" is set to "5ch BI-AMP", or when "Surround" is set to "None".

❑ Front Presence

Selects whether or not presence speakers are connected.

Settings

Use (default)	Select this option when presence speakers are connected.
None	Select this option when no presence speakers are connected.

❑ Subwoofer

Selects whether or not a subwoofer is connected and its phase.

Settings

Use	Normal (default)	Select this option when a subwoofer is connected (phase not reversed). The subwoofer will produce LFE (low-frequency effect) channel audio and low-frequency components from other channels.
	Reverse	Select this option when a subwoofer is connected (phase reversed). The subwoofer will produce LFE (low-frequency effect) channel audio and low-frequency components from other channels.
None		Select this option when no subwoofer is connected. The front speakers will produce LFE (low-frequency effect) channel audio and low-frequency components from other channels.



- When the bass sound is lacking or unclear, switch the subwoofer phase.

❑ Extra Bass

Sets the speakers to produce the front channel low-frequency components.

Settings

Off (default)	Depending on the size of the front speakers, either the subwoofer or front speakers produce the front channel low-frequency components.
On	Both the front speakers and subwoofer produce the front channel low-frequency components.



- This setting is not available when "Subwoofer" is set to "None", or when "Front" is set to "Small".

❑ Bass Cross Over

Sets the lower limit of the low-frequency components that can be output from a speaker whose size is set to "Small". A frequency sound lower than the specified value will be produced from the subwoofer or front speakers.

Settings

40 Hz, 60 Hz, 80 Hz (default), 90 Hz, 100 Hz, 110 Hz, 120 Hz, 160 Hz, 200 Hz



- If the volume and crossover frequency are adjustable on your subwoofer, set the volume to half and crossover frequency to maximum.

Distance

Sets the distance between each speaker and listening position so that sounds from the speakers reach the listening position at the same time. First, select the unit of distance from "Meter" or "Feet".

Choices

Front L, Front R, Center, Surround L, Surround R, Surround Back L, Surround Back R, Front Presence L, Front Presence R, Subwoofer

Setting range

0.30 m to 24.00 m (1.0 ft to 80.0 ft), *0.05 m (0.2 ft) increments

Default

3.00 m (10.0 ft)

Level

Adjusts the volume of each speaker.

Choices

Front L, Front R, Center, Surround L, Surround R, Surround Back L, Surround Back R, Front Presence L, Front Presence R, Subwoofer

Setting range

-10.0 dB to +10.0 dB (0.5 dB increments)

Default

0.0 dB

Parametric EQ

Adjusts the tone with an equalizer.

Settings

Manual	Select this option when you want to adjust the equalizer manually. For details, see "Manual equalizer adjustment".
YPAO:Flat	Adjusts individual speakers to achieve the same characteristics.
YPAO:Front	Adjusts individual speakers to achieve the same characteristics as the front speakers.
YPAO:Natural	Adjusts all speakers to achieve a natural sound.
Through	Does not use the equalizer.



- "YPAO:Flat", "YPAO:Front", and "YPAO:Natural" are available only when the measurement results of "Auto Setup" have already been saved (p.35). Press ENTER again to view the measurement results.

Manual equalizer adjustment

- 1 Set "Parametric EQ" to "Manual" and press ENTER.
- 2 Press ENTER again to enter the edit screen.
- 3 Use the cursor keys to select a speaker and press ENTER.



- To restore the default settings for all speakers, select "PEQ Data Clear" and then "OK".
- To copy the parametric equalizer values acquired with "Auto Setup" (p.35) to the "Manual" fields for fine adjustment, select "PEQ Data Copy" and then an equalizer type.

- 4 Use the cursor keys (</>) to select a center frequency from the 7 preset bands and the cursor keys (Δ/▽) to adjust the gain.

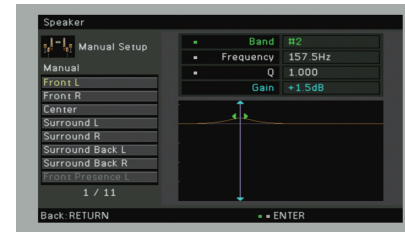

Setting range

Gain: -20.0 dB to +6.0 dB

- 5 To fine-adjust the center frequency or Q factor (bandwidth), press ENTER repeatedly to select an item.

Frequency: Use the cursor keys (</>) to adjust the center frequency of the selected band and the cursor keys (Δ/▽) to adjust the gain.

Q: Use the cursor keys (</>) to adjust the Q factor (bandwidth) of the selected band and the cursor keys (Δ/▽) to adjust the gain.

Setting range

Center frequency: 31.3 HZ to 16.0 kHz

Q factor: 0.500 to 10.080

- 6 To exit from the menu, press ON SCREEN.

■ Test Tone

Enables/disables the test tone output. Test tone output helps you to adjust the speaker balance or equalizer while confirming its effect.

Settings

Off (default)	Does not output test tones.
On	Outputs test tones automatically when you adjust the speaker balance or equalizer.

Sound

Configures the audio output settings.



■ Lipsync

Adjusts the delay between video and audio output.

□ Delay Enable

Enables/disables the Lipsync adjustment for each input source.

Choices

HDMI 1-5, AV 1-6, V-AUX, AUDIO 1-2

Settings

Disable	Disable the Lipsync adjustment for the selected input source.
Enable (default)	Enables the Lipsync adjustment for the selected input source.

□ Auto/Manual Select

Selects the method to adjust the delay between video and audio output.

Setting range

Auto (default)	Adjusts the delay between video and audio output automatically when a TV that supports an automatic lipsync function is connected to the unit via HDMI. If necessary, you can fine-adjust the audio output timing in "Adjustment".
Manual	Select this option when you want to adjust the delay between video and audio output manually. Adjust the audio output timing in "Adjustment".



- Even if "Auto/Manual Select" is set to "Auto", the automatic adjustment does not work depending on the TV connected to the unit. In this case, adjust the delay manually in "Adjustment".

□ Adjustment

Adjusts the delay between video and audio output manually when "Auto/Manual Select" is set to "Manual". You can fine-adjust the audio output timing when "Auto/Manual Select" is set to "Auto".

Setting range

0 ms to 500 ms (1 ms increments)

Default

0 ms



- "Offset" shows the difference between automatic adjustment and fine adjustment.

■ Dynamic Range

Selects the dynamic range adjustment method for bitstream audio (Dolby Digital and DTS signals) playback.

Settings

Maximum (default)	Produces audio without adjusting the dynamic range.
Standard	Optimizes the dynamic range for regular home use.
Minimum/Auto	Sets the dynamic range for clear sound even at night or at low volumes. When playing back Dolby TrueHD signals, the dynamic range is automatically adjusted based on the input signal information.

■ Max Volume

Sets the maximum volume to prevent excessive loudness.

Setting range

-30.0 dB to +15.0 dB (5.0 dB increments), +16.5 dB

Default

+16.5 dB

■ Initial Volume

Sets the initial volume when the receiver is turned on.

Settings

Off (default)	Sets the level to the volume level of the unit when it last entered standby mode.
On	Sets at Mute or the specified volume level (-80 dB to +16.5 dB, 0.5 dB increments). (This setting works only when the initial volume is set lower than "Max Volume".)

■ Adaptive DSP Level

Selects whether to automatically adjust the CINEMA DSP effect level when the volume is adjusted.

Settings

Off	Does not adjust the effect level automatically.
On (default)	Adjusts the effect level automatically.

Video

Configures the video output settings.

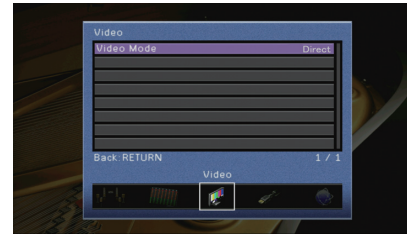

■ Video Mode

Enables/disables the video signal processing (resolution and aspect ratio).

Settings

Direct (default)	Disables the video signal processing.
Processing	Enables the video signal processing. Select a resolution and an aspect ratio in "Resolution" and "Aspect".



- When "Video Mode" is set to "Direct", the unit transmits video signals with the least circuitry in order to reduce video output delay.
- When "Video Mode" is set to "Processing" and the resolution is being converted, short messages are not displayed on the TV screen.

□ Resolution

Selects a resolution to output HDMI video signals when "Video Mode" is set to "Processing".

Settings

Through	Does not convert the resolution.
Auto (default)	Selects a resolution automatically in accordance with TV resolution.
480p/576p, 720p, 1080i, 1080p, 4K	Output video signals with a selected resolution. (Only the resolutions supported by your TV are selectable.)



- If you need to select a resolution that is not supported by your TV, set "MON.CHK" (p.100) in the "ADVANCED SETUP" menu to "SKIP" and try again. (Note that the output video may not be displayed on your TV normally.)

Aspect

Selects an aspect ratio to output HDMI video signals when "Video Mode" is set to "Processing".

Settings

Through (default)	Does not convert the aspect ratio.
16:9 Normal	Outputs 4:3 video signals to a 16:9 TV with black bands on either side of the screen.



- This setting functions only when 480i/576i or 480p/576p signals are converted into 720p, 1080i, 1080p, or 2160p (4K) signals.

HDMI

Configures the HDMI settings.



HDMI Control

Enables/disables HDMI Control (p.119).

Settings

Off (default)	Disables HDMI Control.
On	Enables HDMI Control. Configure the settings in "TV Audio Input", "ARC" and "Standby Sync".



- To use HDMI control, you need to perform the HDMI Control link setup (p.119) after connecting HDMI Control-compatible devices.

TV Audio Input

Selects an audio input jack of the unit to be used for TV audio input when "HDMI Control" is set to "On". The unit's input source automatically switches to TV audio when the TV input is switched to its built-in tuner.

Settings

AV 1-6, AUDIO 1-2

Default

AV 4



- When using ARC to input TV audio to the unit, you cannot use the input jacks selected here for connecting an external device because the input will be used for TV audio input.

❑ ARC

Enables/disables ARC (p.21) when “HDMI Control” is set to “On”.

Settings

Off	Disables ARC.
On (default)	Enables ARC.



- You do not need to change this setting normally. In case noises are produced from the speakers connected to the unit because TV audio signals input to the unit via ARC are not supported by the unit, set “ARC” to “Off” and use the TV’s speakers.

❑ Standby Sync

Select whether to use HDMI control to link the standby behavior of the TV and the unit when “HDMI Control” is set to “On”.

Settings

Off	Does not set the unit to standby mode when the TV is turned off.
On	Sets the unit to standby mode when the TV is turned off.
Auto (default)	Sets the unit to standby mode when the TV is turned off only when the unit is receiving TV audio or HDMI signals.

■ Audio Output

Selects a device to output audio.



- This setting is available only when “HDMI Control” is set to “Off”.

❑ Amp

Enables/disables the audio output from the speakers connected to the unit.

Settings

Off	Disables the audio output from the speakers.
On (default)	Enables the audio output from the speakers.

❑ HDMI OUT

Enables/disables the audio output from a TV connected to the HDMI OUT jack.

Settings

Off (default)	Disables the audio output from the TV.
On	Enables the audio output from the TV.

■ Standby Through

Select whether to output videos/audio (input through HDMI jacks) to the TV when the unit is in standby mode. If this function is set to “On”, you can use the input selection keys (HDMI 1–5, V-AUX) to select an HDMI input even when the unit is in standby mode (the standby indicator on the unit blinks).

Settings

Off (default)	Does not output videos/audio to the TV.
On	Outputs videos/audio to the TV. (The unit consumes more power than when “Off” is selected.)



- This setting is available only when “HDMI Control” is set to “Off”.

Network

Configures the network settings.



■ IP Address

Configures the network parameters (such as IP address).

□ DHCP

Select whether to use a DHCP server.

Settings

Off	Does not use a DHCP server. Configure the network parameters manually. For details, see “Manual network settings”.
On (default)	Uses a DHCP server to automatically obtain the unit’s network parameters (such as IP address).

■ Manual network settings

- 1 Set “DHCP” to “Off”.
- 2 Use the cursor keys (Δ/∇) to select a parameter type and press ENTER.

IP Address	Specifies an IP address.
Subnet Mask	Specifies a subnet mask.
Default Gateway	Specifies the IP address of the default gateway.
DNS Server (P)	Specifies the IP address of the primary DNS server.
DNS Server (S)	Specifies the IP address of the secondary DNS server.

- 3 Use the cursor keys (\leftarrow/\rightarrow) to move the edit position and the cursor keys (Δ/∇) to select a value.
- 4 To confirm the setting, press ENTER.
- 5 To configure another network parameter, repeat steps 2 to 4.

- 6 To save the changes, use the cursor keys to select “OK” and press ENTER.
- 7 To exit from the menu, press ON SCREEN.

■ Network Standby

Selects whether the unit can be turned on from other network devices (network standby).

Settings

Off (default)	Disables the network standby function.
On	Enables the network standby function. (The unit consumes more power than when “Off” is selected.)

■ MAC Address Filter

Sets the MAC address filter to limit access to the unit from other network devices.

□ Filter

Enables/disables the MAC address filter.

Settings

Off (default)	Disables the MAC address filter.
On	Enables the MAC address filter. In “MAC Address 1–10”, specify the MAC addresses of the network devices that will be permitted access to the unit.

□ MAC Address 1–10

Specifies the MAC addresses (up to 10) of the network devices that will be permitted access to the unit when “Filter” is set to “On”.

■ Procedure

- 1 Use the cursor keys (Δ/∇) to select “MAC Address 1–5” or “MAC Address 6–10” and press ENTER.
- 2 Use the cursor keys (Δ/∇) to select an MAC address number and press ENTER.
- 3 Use the cursor keys (\leftarrow/\rightarrow) to move the edit position and the cursor keys (Δ/∇) to select a value.
- 4 To confirm the setting, press ENTER.
- 5 To save the changes, use the cursor keys to select “OK” and press ENTER.
- 6 To exit from the menu, press ON SCREEN.

Network Name

Edits the network name (the unit's name on the network) displayed on other network devices.

Procedure

- 1 Press **ENTER** to enter the name edit screen.
- 2 Use the cursor keys and **ENTER** to rename and select **"ENTER"** to confirm the entry.

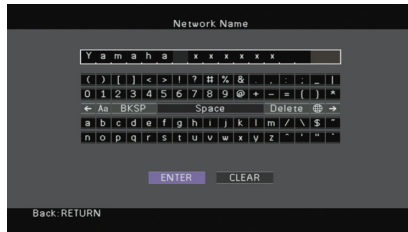

- To clear the entry, select **"CLEAR"**.

- 3 Use the cursor keys to select **"OK"** and press **ENTER**.



- To restore the default setting, select **"RESET"**.

- 4 To exit from the menu, press **ON SCREEN**.

Multi Zone

Configures the multi zone settings.



Main Zone Set

Configures the main zone setting.

Zone Rename

Changes the zone name (for main zone) displayed on the TV screen.

Procedure

- 1 Press **ENTER** to enter the name edit screen.
- 2 Use the cursor keys and **ENTER** to rename and select **"ENTER"** to confirm the entry.



- To clear the entry, select **"CLEAR"**.

- 3 Use the cursor keys to select **"OK"** and press **ENTER**.



- To restore the default setting, select **"RESET"**.

- 4 To exit from the menu, press **ON SCREEN**.

■ Zone2 Set

Configures the Zone2 settings.

□ Max Volume

Sets the Zone2 maximum volume to prevent excessive loudness.

Setting range

-30.0 dB to +15.0 dB (5.0 dB increments), +16.5 dB

Default

+16.5 dB



- This setting is available only when "Power Amp Assign" (p.85) is set to "7ch +1ZONE".

□ Initial Volume

Sets the Zone2 initial volume for when the unit is turned on.

Settings

Off (default)	Sets the level at the volume level of the unit when it last entered standby mode.
On	Sets at Mute or the specified volume level (-80 dB to +16.5 dB, 0.5 dB increments). (This setting works only when the initial volume is set lower than "Max Volume".)



- This setting is available only when "Power Amp Assign" (p.85) is set to "7ch +1ZONE".

□ Zone Rename

Changes the zone name (for Zone2) displayed on the TV screen.

You can change the zone name in the same manner as "Zone Rename" in "Main Zone Set" (p.93).

Function

Configures the functions that make the unit easier to use.



■ Display Set

Configures the settings related to the front display and TV screen display.

□ Dimmer (Front Display)

Adjusts the brightness of the front display.

Setting range

-4 to 0 (higher to brighten)

Default

0



- The front display may become dark when "ECO Mode" (p.96) is set to "On".

□ Short Message

Selects whether to display short messages on the TV screen when the unit is operated (such as input selection and volume adjustment).

Settings

On (default)	Displays short messages on the TV screen.
Off	Does not display short messages on the TV screen.

❑ Wallpaper

Selects the image to be used as wallpaper on the TV.

Settings

Picture 1 (default), Picture 2, Picture 3	Displays the selected image on the TV screen when there is no video signal.
Gray	Displays a gray background on the TV screen when there is no video signal.

■ Trigger Output

Sets the TRIGGER OUT jack to function in sync with the power status of each zone or input switching.

❑ Trigger Mode

Specifies the condition for the TRIGGER OUT jack to function.

Settings

Power (default)	The TRIGGER OUT jack functions in sync with the power status of the zone specified with "Target Zone."
Source	The TRIGGER OUT jack functions in sync with the input switching in the zone specified with "Target Zone." An electronic signal is transmitted according to the setting made in "Source."
Manual	Select this to manually switch the output level for electronic signal transmission with "Manual."

Source

Specifies the output level of the electronic signal transmitted with each input, switching when "Trigger Mode" is set to "Source".

Choices

HDMI 1-5, AV 1-6, V-AUX, AUDIO 1-2, TUNER, (network sources), USB

Settings

Low	Stops the electronic signal transmission when you switch to the input source specified in this option.
High (default)	Transmits the electronic signal when you switch to the input source specified in this option.

Manual

Switches the output level for electronic signal transmission manually when "Trigger Mode" is set to "Manual". This setting can also be used to confirm proper function of the external device connected via the TRIGGER OUT jack.

Choices

Low	Stops the electronic signal transmission.
High (default)	Transmits the electronic signal.

❑ Target Zone

Specifies the zone with which the TRIGGER OUT jack functions are synchronized.

Settings

Main	When "Trigger Mode" is set to "Power," electronic signal transmission is synchronized with the power status of the main zone. When "Trigger Mode" is set to "Source," electronic signal transmission is synchronized with the input switching in the main zone.
Zone2	When "Trigger Mode" is set to "Power," electronic signal transmission is synchronized with the power status of Zone2. When "Trigger Mode" is set to "Source," electronic signal transmission is synchronized with the input switching in Zone2.
All (default)	When "Trigger Mode" is set to "Power," electronic signal transmission is synchronized with the power status of the main zone or Zone2. When "Trigger Mode" is set to "Source," electronic signal transmission is synchronized with the input switching in the main zone or Zone2.

■ DC OUT

Configures the DC OUT jack setting.

❑ Power Mode

Selects how to supply power to the Yamaha AV accessory connected to the DC OUT jack.

Settings

Continuous (default)	Supplies power through the DC OUT jack continuously regardless of the power state (on/standby) of the unit.
Main Zone Power Sync.	Supplies power through the DC OUT jack only when the main zone is turned on. (This setting may not work properly on some accessories.)

Memory Guard

Prevents accidental changes to the settings.

Settings

Off (default)	Does not protect the settings.
On	Protects the settings until "Off" is selected.



- When "Memory Guard" is set to "On", the lock icon (🔒) is displayed on the menu screen.

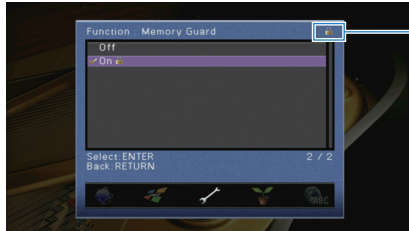

Icon

ECO

Configures the power supply settings.



Auto Power Standby

Sets the amount of time for the auto-standby function. If you do not operate the unit for the specified time, the unit will automatically go into standby mode.

Settings

Off	Does not set the unit to standby mode automatically.
2 hours, 4 hours, 8 hours, 12 hours	Sets the unit to standby mode when you have not operated the unit for the specified time. For example, when "2 hours" is selected, the unit will switch to standby mode if you do not operate it for 2 hours.

Default

U.K. and Europe models: 8 hours
Other models: Off



- Just before the unit enters standby mode, "AutoPowerStdby" appears and then countdown starts in the front display.

ECO Mode

Enables/disables the eco (power saving) mode.

When the eco mode is enabled, you can reduce the unit's power consumption.

Settings

Off (default)	Disables the eco mode.
On	Enables the eco mode.



- The new setting will take effect after the unit is restarted.
- When "ECO Mode" is set to "On", the front panel display may become dark.
- If you want to play audio at high volume, set "ECO Mode" to "Off".

Language

Select an on-screen menu language.

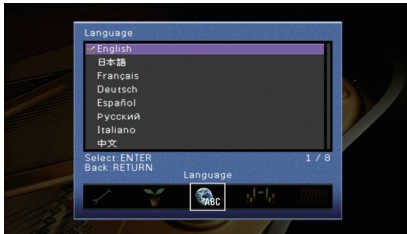

Settings

English (default)	English
日本語	Japanese
Français	French
Deutsch	German
Español	Spanish
Русский	Russian
Italiano	Italian
中文	Chinese



- The information on the front display is provided in English only.

Viewing information about the unit (Information menu)

You can view information about the unit using the TV screen.

- 1 Press ON SCREEN.
- 2 Use the cursor keys to select “Information” and press ENTER.

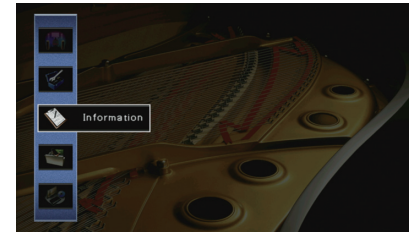

- 3 Use the cursor keys (</>) to select an information type.

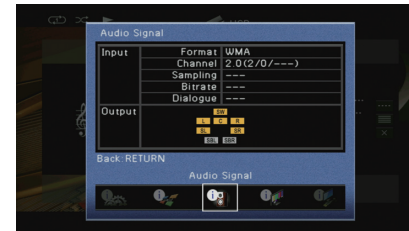

- 4 To exit from the menu, press ON SCREEN.

Types of information

■ Audio Signal

Displays information about the current audio signal.

Input	Format	Audio format of the input signal
	Channel	The number of source channels in the input signal (front/surround/LFE) For example, "5.1 (3/2/0.1)" means 5.1ch in total (3 front channels, 2 surround channels, and LFE).
	Sampling	The number of samples per second of the input digital signal
	Bitrate	The amount of data per second of the input bitstream signal
	Dialogue	The dialogue normalization level of the input bitstream signal
Output	The speaker terminals from which signals are output	



- Even when the unit is set to output bitstream signals directly, the signal may be converted depending on the specifications and settings of the playback device.

■ Video Signal

Displays information about the current video signal.

HDMI Signal	Presence or absence of HDMI signal input/output
HDMI Resolution	Resolutions of input signal (analog or HDMI) and output signal (HDMI)
Analog Resolution	Resolutions of input signal (analog) and signal output at the MONITOR OUT jacks (analog)

■ HDMI Monitor

Displays information about the TV connected to the HDMI OUT jacks.

Interface	TV interface
Video Resolution	Resolutions supported by the TV

■ Network

Displays the network information on the unit.

IP Address	IP address
Subnet Mask	Subnet mask
Default Gateway	The IP address of the default gateway
DNS Server (P)	The IP address of the primary DNS server
DNS Server (S)	The IP address of the secondary DNS server
MAC Address	MAC address
Network Name	Network name (the unit's name on the network)
Status	The connection status of the NETWORK jack

■ System

Displays the system information on the unit.

Remote ID	The unit's remote control ID setting (p.99)
TV Format	The unit's video signal type (p.100)
Speaker Impedance	The speaker impedance setting of the unit (p.99)
System ID	System ID number
Firmware Version	The version of firmware installed on the unit



- If the unit detects a newer firmware over the network, "!" (exclamation mark) appears at the upper right of the "Information" and "System" icons, and the corresponding message will be displayed in this screen. You can update the unit's firmware by pressing ENTER in this screen and following the procedure in "Updating the unit's firmware via the network" (p.105).

■ Multi Zone

Displays information about Zone2.

Input	The input source selected for Zone2
Volume	The volume setting for Zone2

Configuring the system settings (ADVANCED SETUP menu)

Configure the system settings of the unit while viewing the front display.

- 1 **Set the unit to standby mode.**
- 2 **While holding down STRAIGHT on the front panel, press MAIN ZONE .**

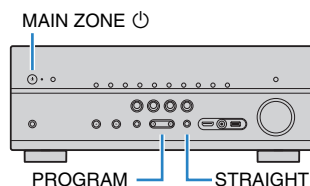

- 3 **Press PROGRAM to select an item.**
- 4 **Press STRAIGHT to select a setting.**
- 5 **Press MAIN ZONE  to set the unit to standby mode and turn it on again.**

The new settings take effect.

ADVANCED SETUP menu items

Item	Function	Page
SP IMP.	Changes the speaker impedance setting.	99
REMOTE ID	Selects the unit's remote control ID.	99
TV FORMAT	Switches the video signal type.	100
MON.CHK	Removes the limitation on HDMI video output.	100
INIT	Restores the default settings.	100
UPDATE	Updates the firmware.	100
VERSION	Checks the version of firmware currently installed on the unit.	101

Changing the speaker impedance setting (SP IMP.)



Change the unit's speaker impedance settings depending on the impedance of the speakers connected.

Settings

6 Ω MIN	Select this option when you connect 6-ohm speakers to the unit. You can also use 4-ohm speakers as the front speakers.
8 Ω MIN (default)	Select this option when you connect 8-ohm or higher speakers to the unit.

Selecting the remote control ID (REMOTE ID)



Change the unit's remote control ID so that it matches the remote control's ID (default: ID1). When using multiple Yamaha AV receivers, you can set each remote control with a unique remote control ID for its corresponding receiver.

Settings

ID1 (default), ID2

■ Changing the remote control ID of the remote control

Perform each of the following steps within 1 minute. Otherwise, the setting will be automatically canceled.

- 1 **Press CODE SET on the remote control.**
- 2 **Press RECEIVER.**
- 3 **Use the numeric keys to enter "5019" (ID1) or "5020" (ID2).**

Once the remote control ID is registered successfully, SOURCE blinks twice. If it blinks six times, registration failed. Repeat from Step 1.



- The registered remote control codes (p.102) are not cleared even if you change the remote control ID.

Switching the video signal type (TV FORMAT)

TV FORMAT • NTSC

Switch the video signal type of the unit so that it matches to the format of your TV.

Settings

NTSC, PAL

Default

U.S.A. model: NTSC

Other models: PAL

Removing the limitation on HDMI video output (MON.CHK)

MON.CHK • • • • YES

The unit automatically detects resolutions supported by a TV connected to the HDMI OUT jack.

Disable the monitor check function if you want to specify a resolution in “Resolution” (p.89) when the unit cannot detect the TV’s resolution or when you want to specify a different resolution than the detected resolution.

Settings

YES (default)	Enables the monitor check function. (Outputs video signals with a resolution supported by the TV only.)
SKIP	Disables the monitor check function. (Outputs video signals with a specified resolution regardless of compatibility with the TV.)



- Reset to “YES” if the unit becomes inoperable because video from the unit cannot be displayed on the TV after “MON.CHK” has been set to “SKIP”.

Restoring the default settings (INIT)

INIT • • • • CANCEL

Restores the default settings for the unit.

Choices

VIDEO	Restores the default settings for video configurations.
ALL	Restores the default settings for the unit.
CANCEL	Does not perform an initialization.

Updating the firmware (UPDATE)

UPDATE • • • • USB

New firmware that provides additional features or product improvements will be released as needed. Updates can be downloaded from the Yamaha website. If the unit is connected to the Internet, you can download the firmware via the network. For details, refer to the information supplied with updates.

■ Firmware update procedure

Do not perform this procedure unless firmware update is necessary. Also, make sure you read the information supplied with updates before updating the firmware.

- 1 Press **STRAIGHT** repeatedly to select “USB” or “NETWORK” and press **INFO** to start firmware update.

Choices

USB	Update the firmware using a USB memory device.
NETWORK	Update the firmware via the network.



- If the unit detects newer firmware over the network, the corresponding message will be displayed after ON SCREEN is pressed. In this case, you can also update the unit’s firmware by following the procedure in “Updating the unit’s firmware via the network” (p.105).

Checking the firmware version (VERSION)



VERSION ■ ■ xx.xx

Check the version of firmware currently installed on the unit.



- You can also check the firmware version in “System” (p.98) in the “Information” menu.
- It may take a while until the firmware version is displayed.



Controlling external devices with the remote control

You can use the unit's remote control to operate external devices (such as BD/DVD players) if you have registered the remote control code of the external device.



- You cannot control an external device that does not have a remote control sensor.
- Ensure that the remote control ID of the external device is set to "ID1". If any other ID is selected, the remote control operations may not work properly.
- If the unit's remote control is without batteries for more than 2 minutes, the registered codes may be cleared. If this happens, insert new batteries and register the codes again.



- Under the unit's default settings, the amplifier code (Yamaha: 5098) is set for all the input selection keys. With this setting, you can control HDMI Control-compatible devices connected to the unit with the remote control. (This function may not work depending on the specification of the external device.)

Registering the remote control code for a TV

You can use the unit's remote control to operate a TV if you have registered its remote control code.



- You can also register your TV's remote control code to the unit's input selection keys (p.103). This would allow you to use the cursor keys or numeric keys to operate the TV (this function may not be available on some TV models).

1 Use "Remote Control Code Search" in the CD-ROM to find your TV's remote control code.



- If there are multiple remote control codes, register the first code in the list. If that does not work, try the other codes.

2 Press CODE SET.

SOURCE blinks twice.

Perform each of the following steps within 1 minute. Otherwise, the setting will be canceled. If this happens, repeat from Step 2.

3 Press TV .

4 Use the numeric keys to enter the 4-digit remote control code.

Once the remote control code is successfully registered, SOURCE blinks twice.

If it blinks six times, registration has failed. Repeat from Step 2.

TV operations

Once you have registered the remote control code for your TV, you can control it using the TV operation keys, regardless of the input source selected on the unit.

	INPUT	Switches the video inputs of the TV.
	MUTE	Mutes the audio output of the TV.
TV operation keys	TV VOL	Adjust the volume of the TV.
	TV CH	Switch the channels of the TV
	TV 	Turns on/off the TV.

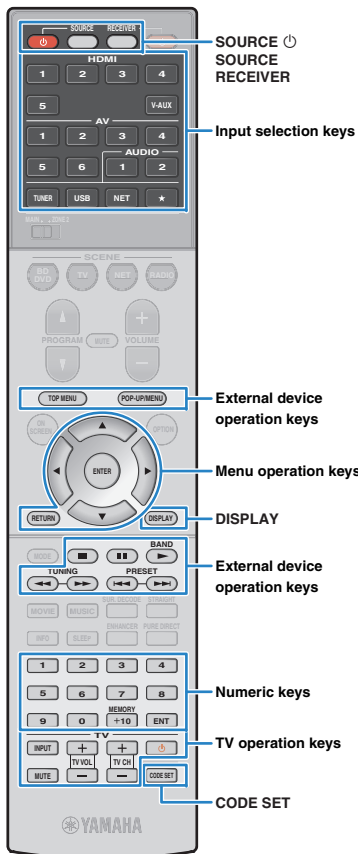

Registering the remote control codes for playback devices

You can use the unit's remote control to operate playback devices if you have registered their remote control codes. You can also use the input selection keys to change the playback devices that are controlled by the remote control, because their remote control codes are assigned to the input selection keys.



- If you assign the remote control code for an external device to the star (★) key, you can operate the device with the remote control without switching the input source after pressing the star key.

1 Use “Remote Control Code Search” in the CD-ROM to find the remote control code for your playback device.



- If there are multiple remote control codes, register the first code in the list. If that does not work, try the other codes.

2 Press CODE SET.

SOURCE blinks twice.

Perform each of the following steps within 1 minute. Otherwise, the setting will be canceled. If this happens, repeat from Step 2.

3 Press the input selection key.

For example, press HDMI 1 to set the remote control code for the playback device connected to the HDMI 1 jack.

4 Use the numeric keys to enter the 4-digit remote control code.

Once the remote control code is registered successfully, SOURCE blinks twice.

If it blinks six times, registration has failed. Repeat from Step 2.



- For details on how to register a remote control code to a SCENE key, refer to “Configuring scene assignments” (p.41).

Playback device operations

Once you have registered the remote control code for your playback device, you can control it using the following keys after selecting the input source or scene.



- By pressing SOURCE or RECEIVER, you can switch the devices (the unit or external device) that are operated by the menu operation keys, DISPLAY and numeric keys. You can operate the unit after pressing RECEIVER (lights up in orange), and an external device after pressing SOURCE (lights up in green). For example, if you register the remote control code of your external device on TUNER, you can operate the unit's built-in FM/AM radio after pressing RECEIVER and the external device after pressing SOURCE.

SOURCE		Turns on/off the playback device.
Menu operation keys	Cursor keys	Select an item.
	ENTER	Confirms a selected item.
	RETURN	Returns to the previous screen.
DISPLAY		Switches information on the display.
	TOP MENU	Displays the top menu.
	POP-UP/MENU	Displays the pop-up menu.
External device operation keys		Stops playback.
		Stops playback temporarily.
		Starts playback of the selected song/video.
		Searches forward/backward (by holding down).
		Searches forward/backward (by holding down).
		Skips forward/backward.
Numeric keys		Enter numerical values.
TV operation keys		Control the TV (p.102).



- These keys work only if the corresponding function is available on your playback device and if the device can be operated with an infrared remote control.

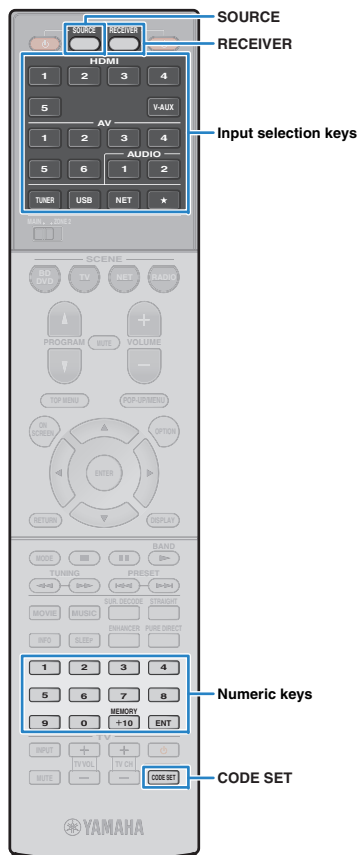

Resetting remote control codes

You can reset a remote control code registered to each input selection key.

1 Press CODE SET.

SOURCE blinks twice.

Perform each of the following steps within 1 minute. Otherwise, the setting will be canceled. If this happens, repeat from Step 1.

2 Press the input selection key.

3 Use the numeric keys to enter “5098”.

Once the remote control code is reset successfully, SOURCE blinks twice.

If it blinks six times, resetting has failed. Repeat from Step 1.

To reset the remote control to factory default settings

- 1 Press CODE SET.
- 2 Press RECEIVER.
- 3 Use the numeric keys to enter “9981”.



Cursor keys
ENTER

Updating the unit's firmware via the network

New firmware that provides additional features or product improvements will be released as needed. If the unit is connected to the Internet, you can download the firmware via the network and update it.

Note

- Do not operate the unit or disconnect the power cable or network cable during firmware update. Firmware update takes about 20 minutes or more (depending on your Internet connection speed).
- If the unit is connected to the wireless network via a wireless network adapter, network update may not be possible depending on the condition of the wireless connection. In this case, update the firmware using the USB memory device (p.100).



- You can also update the firmware using the USB memory device from the "ADVANCED SETUP" menu (p.100).

A firmware update is available if the following message is displayed after ON SCREEN is pressed.

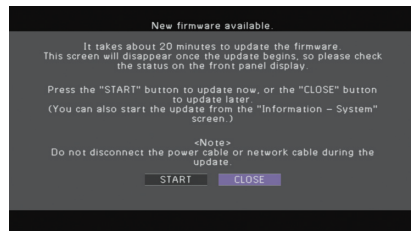

1 Read the on-screen description.

2 To start the firmware update, use the cursor keys to select "START" and press ENTER.

The on-screen display turns off.

3 If "Update Success Please Power Off!" appears on the front display, press MAIN ZONE  on the front panel.

The firmware update is complete.



- If you want to update the firmware later, select "CLOSE" in Step 2. "!" (exclamation mark) appears at the upper right of the "Information" and "System" icons, and a message will be displayed in the "System" screen (p.98). You can update the unit's firmware by pressing ENTER in the "System" screen.

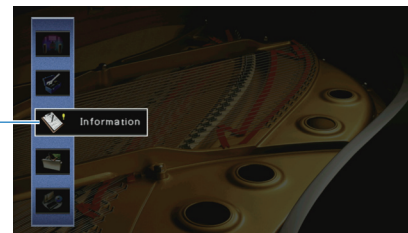

Information icon

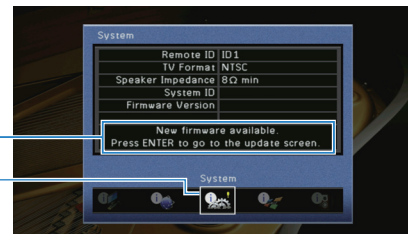

Message

System Icon

APPENDIX

Frequently asked questions

The new speaker system does not provide an ideal sound balance...

If you have changed speakers or have a new speaker system, use “Auto Setup” to optimize the speaker settings again (p.35). If you want to adjust the speaker settings manually, use “Manual Setup” in the “Setup” menu (p.85).

Since we have small children, we want to set limitations on the volume control...

If a small child accidentally operates the controls on the main unit or remote control, the volume may suddenly increase. This may also cause injury or damage the unit or speakers. We recommend using “Max Volume” in the “Setup” menu to set the maximum volume level for the unit in advance (p.89). You can also set the maximum volume for Zone2 (p.94).

I am occasionally startled by a sudden loud sound when turning on the unit...

By default, the volume level when the unit last entered standby mode is automatically applied. If you want to fix the volume, use “Initial Volume” in the “Setup” menu to set the volume to be applied when the receiver is turned on (p.89). You can also set the initial volume for Zone2 (p.94).

We are bothered by volume differences when switching between input sources...

You can correct volume differences between input sources by utilizing “Input Trim” in the “Option” menu (p.74).

I made HDMI connections but HDMI Control does not work at all...

To use HDMI Control, you need to perform the HDMI Control link setup (p.119). After connecting HDMI Control-compatible devices (such as BD/DVD players) to the unit,

enable HDMI Control on each device and perform the HDMI Control link setup. This setup is required every time you add a new HDMI Control-compatible device to your system. For information on how HDMI Control works between your TV and playback devices, refer to the instruction manuals for each device.

I want to turn off the on-screen messages displayed during operations...

By default, short messages are displayed on the TV screen when the unit is operated (such as input selection and volume adjustment). If the short messages bother you when you are watching movies or sports, configure “Short Message” (p.94) in the “Setup” menu to turn off the short messages.

I want to prevent accidental changes to the settings...

You can protect the settings configured on the unit (such as speaker settings) by utilizing “Memory Guard” in the “Setup” menu (p.96).

The unit’s remote control is simultaneously controlling another Yamaha product as well as the unit...

When using multiple Yamaha products, the remote control may work on another Yamaha product or another remote control may work on the unit. If this happens, register different remote control IDs for the devices that you want to control with each remote control (p.99).

I want to enjoy videos/audio played back on the video device even when the unit is in standby mode...

If you have connected a video device to the unit with HDMI, you can output videos/audio played back on the video device to the TV even when the unit is in standby mode. To use this function, set “Standby Through” (p.91) in the “Setup” menu to “On”. You can also switch the input source using the remote control of the unit when this function is enabled.

Troubleshooting



Refer to the table below when the unit does not function properly.

If the problem you are experiencing is not listed below or if the instructions below do not help, turn off the unit, disconnect the power cable, and contact the nearest authorized Yamaha dealer or service center.

First, check the following:

- ① **The power cables of the unit, TV and playback devices (such as BD/DVD players) are connected to AC wall outlets securely.**
- ② **The unit, subwoofer, TV and playback devices (such as BD/DVD players) are turned on.**
- ③ **The connectors of each cable are securely inserted in to jacks on each device.**

Power, system and remote control

Problem	Cause	Remedy
The power does not turn on.	The protection circuitry has been activated three times consecutively. When the unit is in this condition, the standby indicator on the unit blinks if you try to turn on the power.	As a safety precaution, capability to turn on the power is disabled. Contact your nearest Yamaha dealer or service center to request repair.
The power does not turn off.	The internal microcomputer has frozen, due to an external electric shock (such as lightning or excessive static electricity) or to a drop in the power supply voltage.	Hold down MAIN ZONE  on the front panel for more than 10 seconds to initialize and reboot the unit. (If the problem persists, disconnect the power cable from the AC wall outlet and plug it again.)
The power turns off (standby mode) immediately.	The unit was turned on while a speaker cable was shorted.	Twist the bare wires of each speaker cable firmly and reconnect to the unit and speakers (p.18).
The unit enters standby mode automatically.	The sleep timer worked.	Turn on the unit and start playback again.
	The auto-standby function kicked in because the unit was not used for the specified time.	To disable the auto-standby function, set "Auto Power Standby" in the "Setup" menu to "Off" (p.96).
	The speaker impedance setting is incorrect.	Set the speaker impedance to match your speakers (p.99).
	The protection circuitry has been activated because of a short circuit.	Twist the bare wires of each speaker cable firmly and reconnect to the unit and speakers (p.18).
The unit is not reacting.	The internal microcomputer is frozen, due to an external electric shock (such as lightning or excessive static electricity) or to a drop in the power supply voltage.	Hold down MAIN ZONE  on the front panel for more than 10 seconds to initialize and reboot the unit. (If the problem persists, disconnect the power cable from the AC wall outlet and plug it again.)

Problem	Cause	Remedy
The unit cannot be controlled using the remote control.	The unit is out of the operating range.	Use the remote control within the operating range (p.5).
	The batteries are weak.	Replace with new batteries.
	The unit's remote control sensor is exposed to direct sunlight or strong lighting.	Adjust the lighting angle, or reposition the unit.
	The remote control is set to control external devices.	Press RECEIVER to set the remote control to control the unit (the key lights up in orange).
	The remote control IDs of the unit and the remote control are not identical.	Change the remote control ID of the unit or the remote control (p.99).
External devices cannot be controlled using the remote control.	The remote control is set to control the unit.	Press SOURCE to set the remote control to control external devices (the key lights up in green).
	The corresponding remote control code is not set properly.	Set the remote control code again (p.102). Even if the remote control code is registered properly, some products may not respond to the remote control.
The MHL-compatible mobile device cannot be controlled using the remote control.	A remote control code for another playback device is assigned to V-AUX.	Reset the remote control code registered to V-AUX (p.104).
	The mobile device or its application is not externally controllable.	Directly operate the mobile device itself.

Audio

Problem	Cause	Remedy
No sound.	Another input source is selected.	Select an appropriate input source with the input selection keys.
	Signals that the unit cannot reproduce are being input.	Some digital audio formats cannot be played back on the unit. To check the audio format of the input signal, use "Audio Signal" in the "Information" menu (p.98).
	The cable connecting the unit and playback device is defective.	If there is no problem with the connection, replace with another cable.
The volume cannot be increased.	The maximum volume is set.	Use "Max Volume" in the "Setup" menu to adjust the maximum volume (p.89).
	A device connected to the output jacks of the unit is not turned on.	Turn on all devices connected to the output jacks of the unit.
No sound is coming from a specific speaker.	The playback source does not contain a signal for the channel.	To check it, use "Audio Signal" in the "Information" menu (p.98).
	The currently selected sound program/decoder does not use the speaker.	To check it, use "Test Tone" in the "Setup" menu (p.88).
	Audio output of the speaker is disabled.	Perform "Auto Setup" (p.35) or use "Configuration" in the "Setup" menu to change the speaker settings (p.85).
	The volume of the speaker is set too low.	Perform "Auto Setup" (p.35) or use "Level" in the "Setup" menu to adjust the speaker volume (p.87).
	The speaker cable connecting the unit and the speaker is defective.	If there is no problem with the connection, replace with another speaker cable.
	The speaker is malfunctioning.	To check it, replace with another speaker. If the problem persists, the unit may be malfunctioning.
No sound is coming from the surround back speaker.	The extended surround is disabled.	Use "Extended Surround" in the "Option" menu to select a decoder to be used (p.74).
No sound is coming from the subwoofer.	The playback source does not contain LFE or low-frequency signals.	To check it, set "Extra Bass" in the "Setup" menu to "On", in order to output the front channel low-frequency components from the subwoofer (p.86).
	Subwoofer output is disabled.	Perform "Auto Setup" (p.35) or set "Subwoofer" in the "Setup" menu to "Use" (p.86).
	The volume of the subwoofer is too low.	Adjust the volume on the subwoofer.
	The subwoofer has been turned off by its auto-standby function.	Disable the auto-standby function of the subwoofer or adjust its sensitivity level.
No sound from the playback device (connected to the unit with HDMI).	The TV does not support HDCP (High-bandwidth Digital Content Protection).	Refer to the instruction manuals for the TV and check the TV's specifications.
	The unit is set not to output audio input through HDMI jacks from the SPEAKERS terminals.	In "Audio Output" in the "Setup" menu, set "Amp" to "On" (p.91).
	The number of devices connected to the HDMI OUT jack exceeds the limit.	Disconnect some of the HDMI devices.

Problem	Cause	Remedy
No sound from the TV (when HDMI Control is used).	The TV is set to output audio from the TV speakers.	Change the audio output setting on your TV so that the TV audio is output from the speakers connected to the unit.
	A TV that does not support ARC is connected to the unit only with an HDMI cable.	Use a digital optical cable to make an audio connection (p.23).
	(If the TV is connected to the unit with an audio cable) The TV audio input setting does not match the actual connection.	Use "TV Audio Input" in the "Setup" menu to select the correct audio input jack (p.90).
	(If you are trying to use ARC) ARC is disabled on the unit or TV.	Set "ARC" in the "Setup" menu to "On" (p.91). Also, enable ARC on the TV.
Only the front speakers work on multichannel audio.	The playback device is set to output 2-channel audio (such as PCM) only.	To check it, use "Audio Signal" in the "Information" menu (p.98). If necessary, change the digital audio output setting on the playback device.
Noise/hum is heard.	The unit is too close to another digital or radio frequency device.	Move the unit further away from the device.
	The cable connecting the unit and playback device is defective.	If there is no problem with the connection, replace with another cable.
The sound is distorted.	The volume of the unit is too high.	Turn down the volume. If "ECO Mode" is set to "On", set it to "Off" (p.96).
	A device connected to the unit's output jacks is not turned on.	Turn on all devices connected to the unit's output jacks.

Video

Problem	Cause	Remedy
No video.	Another input source is selected on the unit.	Select an appropriate input source with the input selection keys.
	Another input source is selected on the TV.	Switch the TV input to display the video from the unit.
	The video signal output from the unit is not supported by the TV.	Set "MON.CHK" in the "ADVANCED SETUP" menu to "YES" (p.100).
	The cable connecting the unit and TV (or playback device) is defective.	If there is no problem with the connection, replace with another cable.
No video from the playback device (connected to the unit with HDMI).	The input video signal (resolution) is not supported by the unit.	To check the information about the current video signal (resolution), use "Video Signal" in the "Information" menu (p.98). For information about video signals supported by the unit, see "HDMI signal compatibility" (p.120).
	The TV does not support HDCP (High-bandwidth Digital Content Protection).	Refer to the instruction manuals for the TV and check the TV's specifications.
	The number of devices connected to the HDMI OUT jack is over the limit.	Disconnect some of the HDMI devices.
The menu of the unit is not displayed on the TV.	The TV is not connected to the unit via HDMI.	You can display the menu of the unit on the TV only when they are connected with an HDMI cable. If necessary, use an HDMI cable to connect them (p.21 to 24).
	Another input source is selected on the TV.	Switch the TV input to display the video from the unit (HDMI OUT jack).

FM/AM radio

Problem	Cause	Remedy
FM radio reception is weak or noisy.	There is multi-path interference.	Adjust the FM antenna height or orientation, or place it in a different location.
	Your area is too far from the FM station transmitter.	Set "FM Mode" in the "Option" menu to "Mono" to select monaural FM radio reception (p.74). Use an outdoor FM antenna. We recommend using a sensitive multi-element antenna.
AM radio reception is weak or noisy.	The noises may be caused by fluorescent lamps, motors, thermostats, or other electrical equipment.	It is difficult to completely eliminate noise. It may be reduced by using an outdoor AM antenna.
Radio stations cannot be selected automatically.	Your area is too far from the FM station transmitter.	Select the station manually (p.48). Use an outdoor antenna. We recommend using a sensitive multi-element antenna.
	The AM radio signal is weak.	Adjust the AM antenna orientation.
		Select the station manually (p.48).
		Use an outdoor AM antenna. Connect it to the ANTENNA (AM) jack together with the supplied AM antenna.
AM radio stations cannot be registered as presets.	Auto Preset has been used.	Auto Preset is for registering FM radio stations only. Register AM radio stations manually (p.49).

USB and network

Problem	Cause	Remedy
The unit does not detect the USB device.	The USB device is not connected to the USB jack securely.	Turn off the unit, reconnect your USB device, and turn the unit on again.
	The file system of the USB device is not FAT16 or FAT32.	Use a USB device with FAT16 or FAT32 format.
Folders and files in the USB device cannot be viewed.	The data in the USB device is protected by the encryption.	Use a USB device without an encryption function.
The network feature does not function.	The network parameters (IP address) have not been obtained properly.	Enable the DHCP server function on your router and set "DHCP" in the "Setup" menu to "On" on the unit (p.92). If you want to configure the network parameters manually, check that you are using an IP address which is not used by other network devices in your network (p.92).
The unit does not detect the PC.	The media sharing setting is not correct.	Configure the sharing setting and select the unit as a device to which music contents are shared (p.60).
	Some security software installed on your PC is blocking the access of the unit to your PC.	Check the settings of security software installed on your PC.
	The unit and PC are not in the same network.	Check the network connections and your router settings, and then connect the unit and the PC to the same network.
	The MAC address filter is enabled on the unit.	In "MAC Address Filter" in the "Setup" menu, disable the MAC address filter or specify the MAC address of your PC to allow it to access to the unit (p.92).
The files in the PC cannot be viewed or played back.	The files are not supported by the unit or the media server.	Use the file format supported by both the unit and the media server. For information about the file formats supported by the unit, see "Playing back music stored on media servers (PCs/NAS)" (p.60).
The Internet radio cannot be played.	The selected Internet radio station is currently not available.	There may be a network problem at the radio station, or the service may have been stopped. Try the station later or select another station.
	The selected Internet radio station is currently broadcasting silence.	Some Internet radio stations broadcast silence at certain of times of the day. Try the station later or select another station.
	Access to the network is restricted by the firewall settings of your network devices (such as the router).	Check the firewall settings of your network devices. The Internet radio can be played only when it passes through the port designated by each radio station. The port number varies depending on the radio station.
The application for smartphone/tablet "AV Controller" does not detect the unit.	The unit and smartphone/tablet are not in the same network.	Check the network connections and your router settings, and then connect the unit and smartphone/tablet to the same network.
	The MAC address filter is enabled on the unit.	In "MAC Address Filter" in the "Setup" menu, disable the MAC address filter or specify the MAC address of your smartphone/tablet to allow it to access to the unit (p.92).
Firmware update via the network is failed.	It may not be possible depending on the condition of the network.	Update the firmware via the network again or use a USB memory device (p.100).

Error indications on the front display

Message	Cause	Remedy
Access denied	Access to the PC is denied.	Configure the sharing settings and select the unit as a device to which music contents are shared (p.60).
Access error	The unit cannot access the USB device.	Turn off the unit and reconnect your USB device. If the problem persists, try another USB device.
	The unit cannot access the iPod.	Turn off the iPod and turn it on again.
	The connected iPod is not supported by the unit.	Use an iPod supported by the unit (p.53).
	There is a problem with the signal path from the network to the unit.	Make sure your router and modem are turned on. Check the connection between the unit and your router (or hub) (p.31).
Check SP Wires	The speaker cables short circuit.	Twist the bare wires of the cables firmly and connect to the unit and speakers properly.
Internal Error	An internal error has occurred.	Contact the nearest authorized Yamaha dealer or service center.
MHL Overloaded	An overcurrent is flowing through the MHL-compatible mobile device.	Turn off the unit and check the connection between the unit and mobile device.
No content	There are no playable files in the selected folder.	Select a folder that contains files supported by the unit.
No device	The unit cannot detect the USB device.	Turn off the unit and reconnect your USB device. If the problem persists, try another USB device.
	The unit cannot detect the iPod.	Turn off the iPod and then turn it on again.
Please wait	The unit is preparing for connecting to the network.	Wait until the message disappears. If the message stays more than 3 minutes, turn off the unit and turn it on again.
RemID Mismatch	The remote control IDs of the unit and the remote control are not identical.	Change the remote control ID of the unit or the remote control (p.99).
Unable to play	The unit cannot play back the songs stored on the iPod for some reason.	Check the song data. If it cannot be played on the iPod itself, the song data or storage area may be defective.
	The unit cannot play back the songs stored on the PC for some reason.	Check if the format of files you are trying to play is supported by the unit. For information about the formats supported by the unit, see "Playing back music stored on media servers (PCs/NAS)" (p.60). If the unit supports the file format, but still cannot play back any files, the network may be overloaded with heavy traffic.
USB Overloaded	An overcurrent is flowing through the USB device.	Turn off the unit and reconnect your USB device. If the problem persists, try another USB device.
Version error	Firmware update is failed.	Update the firmware again.

Ideal speaker layout

Use this diagram as a guide. You do not need to adjust the speaker layout to the following diagram exactly.

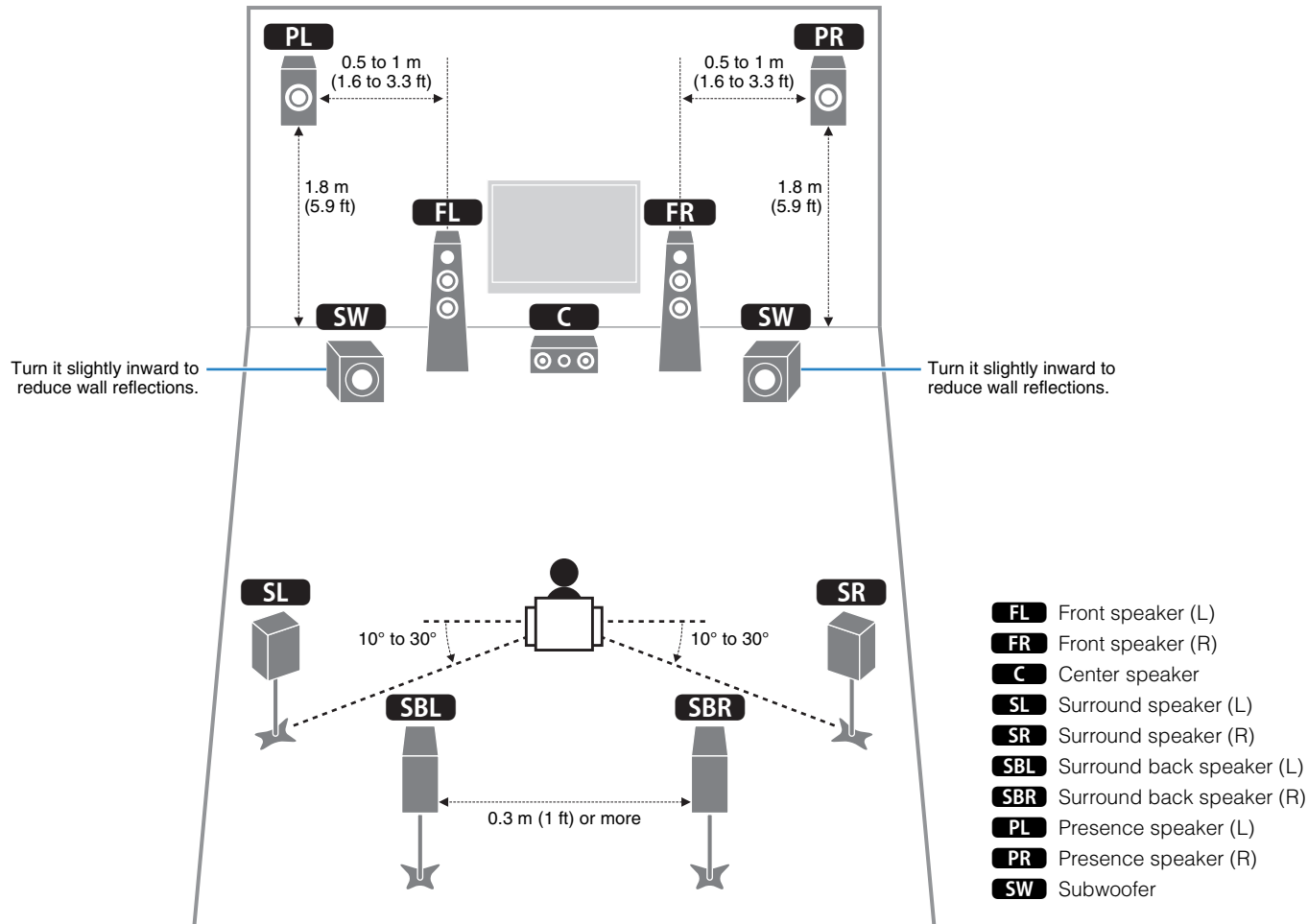

Audio information

■ Audio decoding format

Dolby Digital

Dolby Digital is a compressed digital audio format developed by Dolby Laboratories, Inc. that supports 5.1-channel audio. This technology is used for audio on most DVD discs.

Dolby Digital EX

Dolby Digital EX creates total 6.1-channel audio from 5.1-channel sources that are recorded with Dolby Digital Surround EX. This decoder adds a surround back sound to the original 5.1-channel sound.

Dolby Digital Plus

Dolby Digital Plus is a compressed digital audio format developed by Dolby Laboratories, Inc. that supports 7.1-channel audio. Dolby Digital Plus remains fully compatible with the existing multichannel audio systems that support Dolby Digital. This technology is used for audio on BD (Blu-ray discs).

Dolby Pro Logic II

Dolby Pro Logic II enables 5-channel playback from 2-channel sources. There are three modes available: "Music mode" for music sources, "Movie mode" for movie sources, and "Game mode" for game sources.

Dolby Pro Logic IIx

Dolby Pro Logic IIx enables 7-channel playback from 2-channel or multichannel sources. There are three modes available: "Music mode" for music sources, "Movie mode" for movie sources and "Game mode" for game sources (for 2-channel sources only).

Dolby TrueHD

Dolby TrueHD is an advanced lossless audio format developed by Dolby Laboratories, Inc. to offer a high-definition home theater experience with the quality of the studio master. Dolby TrueHD can carry up to eight channels of 96 kHz/24-bit audio (up to six channels of 192 kHz/24-bit audio) simultaneously. This technology is used for audio on BD (Blu-ray discs).

DTS 96/24

DTS 96/24 is a compressed digital audio format that supports 5.1-channel and 96 kHz/24-bit audio. This format remains fully compatible with the existing multichannel audio systems that support DTS Digital Surround. This technology is used for music DVDs, etc.

DTS Digital Surround

DTS Digital Surround is a compressed digital audio format developed by DTS, Inc. that supports 5.1-channel audio. This technology is used for audio on most DVD discs.

DTS-ES

DTS-ES creates total 6.1-channel audio from 5.1-channel sources that are recorded with DTS-ES. This decoder adds a surround back sound to the original 5.1-channel sound. In the DTS-ES Matrix 6.1 format, a surround back sound is recorded in the surround channels, and in the DTS-ES Discrete 6.1 format, a discrete surround back channel is recorded.

DTS Express

DTS Express is a compressed digital audio format that supports 5.1-channel audio and allows a higher compression rate than the DTS Digital Surround format developed by DTS, Inc. This technology is developed for audio streaming services on the Internet and secondary audio on BD (Blu-ray discs).

DTS-HD High Resolution Audio

DTS-HD High Resolution Audio is a compressed digital audio format developed by DTS, Inc. that supports 7.1-channel and 96 kHz/24-bit audio. DTS-HD High Resolution Audio remains fully compatible with the existing multichannel audio systems that support DTS Digital Surround. This technology is used for audio on BD (Blu-ray discs).

DTS-HD Master Audio

DTS-HD Master Audio is an advanced lossless audio format developed to offer a high-definition home theater experience with the quality of the studio master by DTS, Inc. DTS-HD Master Audio can carry up to eight channels of 96 kHz/24-bit audio (up to six channels of 192 kHz/24-bit audio) simultaneously. This technology is used for audio on BD (Blu-ray discs).

DTS Neo:6

DTS Neo:6 enables 6-channel playback from 2-channel sources. There are two modes available: "Music mode" for music sources and "Cinema mode" for movie sources. This technology provides discrete full-bandwidth matrix channels of surround sound.

DSD (Direct Stream Digital)

DSD (Direct Stream Digital) technology stores audio signals on digital storage media, such as SACD (Super Audio CDs). The signals are stored at a high-frequency sampling rate of 2.8224 MHz. The highest frequency response is equal to or higher than 100 kHz, with a dynamic range of 120 dB. This technology offers better audio quality than that used for CDs.

FLAC

FLAC is a file format for lossless audio data compression. FLAC is inferior to lossy compressed audio formats in compression rate but provides higher audio quality.

MP3

One of the compressed digital audio format used by MPEG. With psychoacoustic technologies, this compression method achieves a high compression rate. Reportedly, it is capable of compressing data quantity by about 1/10 maintaining a certain level of audio quality.

MPEG-4 AAC

An MPEG-4 audio standard. It is used for mobile telephones, portable audio players, and audio streaming services on Internet because it allows a high compression rate of data while maintaining better audio quality than MP3.

PCM (Pulse Code Modulation)

PCM is a signal format under which an analog audio signal is digitized, recorded, and transmitted. This technology is the basis of all other audio format. This technology is used as a lossless audio format called Linear PCM for audio on a variety of media, including CDs and BD (Blu-ray discs).

Sampling frequency/Quantization bit

Sampling frequency and quantization bits indicate the quantity of information when an analog audio signal is digitized. These values are noted as in the following example: "48 kHz/24-bit".

- **Sampling frequency**
Sampling frequency (the number of times the signal is sampled per second) is called the sampling rate. When the sampling frequency is higher, the range of frequencies that can be played back are wider.
- **Quantization bit**
The number of quantization bits indicate the degree of accuracy when converting the sound level into a numeric value. When the number of quantized bits is higher, the expression of the sound level is more accurate.

WAV

Windows standard audio file format, which defines the method of recording the digital data obtained by converting audio signals. By default, the PCM method (no compression) is used, but you can also use other compression methods.

WMA (Windows Media Audio)

One of the compressed digital audio formats developed by Microsoft Corporation. With psychoacoustic technologies, this compression method achieves a high compression rate. Reportedly, it is capable of compressing data quantity by about 1/20 maintaining a certain level of audio quality.

Others

Bi-amplification connection (Bi-amp)

A bi-amplification connection uses two amplifiers for a speaker. When you use the bi-amplification connection, the unit drives the tweeter and woofer in a speaker with the discrete amplifiers. As a consequence, the tweeter and woofer provide clear audio signal without the interference.

LFE (Low Frequency Effects) 0.1 channel

This channel reproduces low-frequency bass signals and has a frequency range from 20 Hz to 120 Hz. This channel is added to the channels for all bands with Dolby Digital or DTS to enhance low frequency audio effects. This channel is labeled 0.1 because it is limited to only low frequency audio.

Lip sync

Video output sometimes lags behind audio output due to the complexity of signal processing caused by an increase in video signal capacity. Lip sync is a technique for automatically correcting the timing lag between audio and video output.

HDMI and video information

Component video signal

With the component video signal system, the video signal is separated into the Y signal for luminance and the Pb and Pr signals for chrominance. Color can be reproduced more faithfully with this system because each of these signals is independent.

Composite video signal

With the composite video signal system, color, brightness, and synchronization data signals are combined and transmitted with a single cable.

Deep Color

Deep Color is a technology that HDMI specification supports. Deep Color increases the number of available colors within the boundaries defined by the RGB or YCbCr color space. Conventional color systems process the color using 8 bits. Deep Color processes the color with 10, 12, or 16 bits. This technology allows HDTVs and other displays to increase from millions of colors to billions of colors and eliminate on-screen color banding for smooth tonal transitions and subtle gradations between colors.

HDMI

HDMI (High-Definition Multimedia Interface) is the world-wide standard interface for digital audio/video signal transmission. This interface transmits both digital audio and digital video signals using a single cable without any loss. HDMI complies with HDCP (High-bandwidth Digital Content Protection) and provides a secure audio/video interface. For further information on HDMI, visit the HDMI website at "<http://www.hdmi.org/>".

MHL

MHL (Mobile High-definition Link) is the interface standard for high-speed digital video signal transmission that is developed for mobile devices. This interface transmits both digital audio and digital video signals from mobile devices (such as smartphones) using a single cable with any loss. As with HDMI, MHL complies with HDCP (High-bandwidth Digital Content Protection).

x.v.Color

"x.v.Color" is a technology that the HDMI specification supports. It is a more extensive color space than sRGB and allows the expression of colors that were not hitherto possible. While remaining compatible with the color gamut of sRGB standards, "x.v.Color" expands the color space, and thus can produce more vivid, natural images.

Yamaha technologies

CINEMA DSP (Digital Sound Field Processor)

Since the Dolby Surround and DTS systems were originally designed for use in movie theaters, their effect is best experienced in a theater that has many speakers designed for acoustic effects. Since home conditions (such as room size, wall material, and number of speakers) can differ so widely, it is inevitable that there are differences in the sound that you hear. Based on a wealth of actually measured data, CINEMA DSP, Yamaha's original DSP technology provides the audiovisual experience of a movie theater in your own home.

CINEMA DSP 3D

The actually measured sound field data contain the information of the height of the sound images. CINEMA DSP 3D mode achieves the reproduction of the accurate height of the sound images so that it creates the accurate and intensive 3D sound fields in a listening room.

Compressed Music Enhancer

The Compressed Music Enhancer feature compensates for missing harmonics in compression music formats (such as MP3). As a result, this technology provides improved performance for the overall sound system.

SILENT CINEMA

Yamaha has developed a natural, realistic sound effect DSP algorithm for headphones. Parameters for headphones have been set for each sound program, so that accurate representations of all the sound programs can be enjoyed on headphones.

Virtual CINEMA DSP

Virtual CINEMA DSP allows the system to virtually reproduce the sound field of the surround speakers with front left and right speakers. Even if the surround speakers are not connected, the unit creates the realistic sound field in a listening room.

Virtual Presence Speaker (VPS)

Virtual Presence Speaker allows the system to virtually reproduce the height of the 3D sound field without front presence speakers. Even if the front presence speakers are not connected, the unit creates the 3D sound field in your room.

Video signal flow

Video signals input from a video device to the unit are output to a TV as shown below.

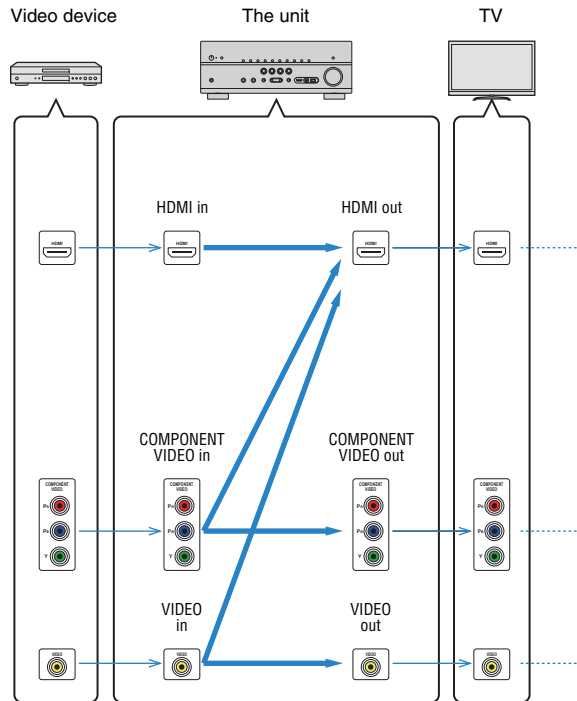

Video conversion table



- You can select the resolution and the aspect ratio applied to HDMI-output video processing in "Video Mode" (p.89) in the "Setup" menu.
- The unit does not convert 480-line and 576-line video signals interchangeably.

Resolution	HDMI out						COMPONENT VIDEO out				VIDEO out
	480i/576i	480p/576p	720p	1080i	1080p	4K	480i/576i	480p/576p	720p	1080i	480i/576i
HDMI in	480i/576i	→	→	→	→	→					
	480p/576p		→	→	→	→					
	720p			→	→	→					
	1080i			→	→	→					
	1080p/50, 60 Hz			→	→	→					
	1080p/24 Hz					→	→				
4K						→					
COMPONENT VIDEO in	480i/576i	→	→	→	→	→	→				
	480p/576p							→			
	720p								→		
	1080i									→	
VIDEO in	480i/576i	→	→	→	→	→					→

→ : Available

Information on HDMI

HDMI Control

HDMI Control allows you to operate external devices via HDMI. If you connect a TV that supports HDMI Control to the unit with an HDMI cable, you can control the unit (such as power and volume) with TV remote control operations. You can also control playback devices (such as HDMI Control-compatible BD/DVD players) connected to the unit with an HDMI cable.

For details on connections, see “Connecting a TV” (p.21) and “Connecting video devices (such as BD/DVD players)” (p.26).

Operations available from the TV's remote control

- Standby synchronization
- Volume control including mute
- Switching to input audio from the TV when the TV input is switched to its built-in tuner
- Switching to input video/audio from the selected playback device
- Switching between audio output devices (the unit or TV speaker)

(Example)

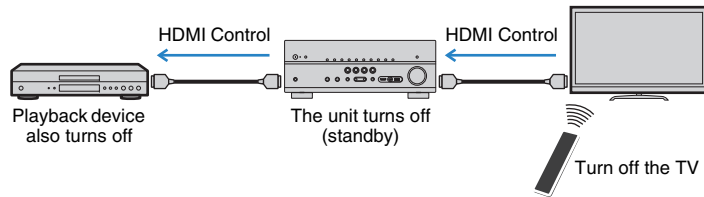

Operations available from the unit's remote control

- Starting playback on the playback device and turning on the TV with a scene selection (p.41)
- Switching the TV input to display the on-screen menu (when ON SCREEN is pressed)
- Controlling the playback device (playback and menu operations) without registering remote control codes (p.103)

(Example)

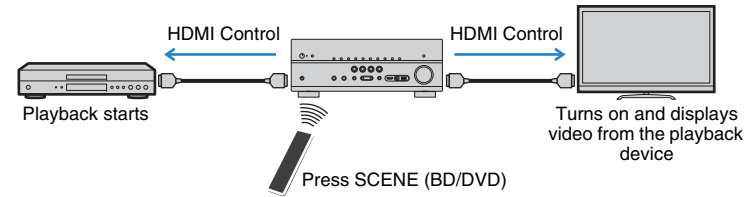

To use HDMI Control, you need to perform the following HDMI Control link setup after connecting the TV and playback devices.



- This setup is required every time you add a new HDMI Control-compatible device to your system.

- 1 Turn on the unit, TV, and playback devices.**
- 2 Enable HDMI Control on the unit, TV, and playback devices (such as HDMI Control-compatible BD/DVD players).**

To enable HDMI Control on the unit, set “HDMI Control” (p.90) in the “Setup” menu to “On” and configure the related items (“TV Audio Input”, “ARC”, and “Standby Sync”).

- 3 Turn off the main power of the TV and then turn off the unit and playback devices.**
- 4 Turn on the unit and playback devices and then turn on the TV.**
- 5 Switch the TV input to display the video from the unit.**
- 6 Check the followings.**

On the unit: The input to which the playback device is connected is selected. If not, select the input source manually.

On the TV: The video from the playback device is displayed.

7 Check that the unit is properly synchronized with the TV by turning off the TV or adjusting the TV volume with the TV remote control.



- If HDMI Control does not work properly, try unplugging the TV in Step 2 and plugging in the TV again in Step 3. It may solve the problem. Also, HDMI Control may not work if the number of connected devices exceeds the limit. In this case, disable HDMI Control on the devices not in use.
- If the unit is not synchronized to the TV's power operations, check the priority of the audio output setting on the TV.
- We recommend using TV and playback devices from the same manufacturer so that HDMI Control works more effectively.

HDMI signal compatibility

Audio signals

Audio signal type	Audio signal format	Compatible media (example)
2ch Linear PCM	2ch, 32 to 192 kHz, 16/20/24 bit	CD, DVD-Video, DVD-Audio
Multichannel Linear PCM	8ch, 32 to 192 kHz, 16/20/24 bit	DVD-Audio, BD (Blu-ray disc), HD DVD
DSD	2 to 5.1ch, 2.8224 MHz, 1 bit	SACD
Bitstream	Dolby Digital, DTS	DVD-Video
Bitstream (High definition audio)	Dolby TrueHD, Dolby Digital Plus, DTS-HD Master Audio, DTS-HD High Resolution Audio, DTS Express	BD (Blu-ray disc), HD DVD

Video signals

The unit is compatible with the video signals of the following resolutions:

- VGA
- 480i/60 Hz
- 576i/50 Hz
- 480p/60 Hz
- 576p/50 Hz
- 720p/60 Hz, 50 Hz
- 1080i/60 Hz, 50 Hz
- 1080p/60 Hz, 50 Hz, 30 Hz, 25 Hz, 24 Hz
- 4K/30 Hz, 25 Hz, 24 Hz



- When CPPM copy-protected DVD-Audio is played back, video/audio signals may not be output, depending on the type of the DVD player.
- The unit is not compatible with HDCP-incompatible HDMI or DVI devices. For details, refer to the instruction manual for each device.
- To decode audio bitstream signals on the unit, set the input source device appropriately so that the device outputs the bitstream audio signals directly (does not decode the bitstream signals on the playback device). For details, refer to the instruction manual for the playback device.

Trademarks



Manufactured under license from Dolby Laboratories. Dolby, Pro Logic, Surround EX and the double-D symbol are trademarks of Dolby Laboratories.



Manufactured under license under U.S. Patent Nos: 5,956,674; 5,974,380; 6,226,616; 6,487,535; 7,212,872; 7,333,929; 7,392,195; 7,272,567 & other U.S. and worldwide patents issued & pending. DTS-HD, the Symbol, & DTS-HD and the Symbol together are registered trademarks & DTS-HD Master Audio is a trademark of DTS, Inc.

Product includes software. © DTS, Inc. All Rights Reserved.



"Made for iPod," "Made for iPhone," and "Made for iPad" mean that an electronic accessory has been designed to connect specifically to iPod, iPhone, or iPad, respectively, and has been certified by the developer to meet Apple performance standards.

Apple is not responsible for the operation of this device or its compliance with safety and regulatory standards.

Please note that the use of this accessory with iPod, iPhone, or iPad may affect wireless performance.

AirPlay, the AirPlay logo, iPad, iPhone, iPod, iPod nano, and iPod touch are trademarks of Apple Inc., registered in the U.S. and other countries.



Fraunhofer Institut
Integrierte Schaltungen

MPEG Layer-3 audio coding technology licensed from Fraunhofer IIS and Thomson.



This receiver supports network connections.



HDMI, the HDMI Logo, and High-Definition Multimedia Interface are trademarks or registered trademarks of HDMI Licensing LLC in the United States and other countries.



MHL and the MHL logo are a trademark, registered trademark or service mark of MHL, LLC in the United States and/or other countries.

x.v.Color™

"x.v.Color" is a trademark of Sony Corporation.



"SILENT CINEMA" is a trademark of Yamaha Corporation.



DLNA™ and DLNA CERTIFIED™ are trademarks or registered trademarks of Digital Living Network Alliance. All rights reserved. Unauthorized use is strictly prohibited.

Windows™

Windows is a registered trademark of Microsoft Corporation in the United States and other countries.

Internet Explorer, Windows Media Audio and Windows Media Player are either registered trademarks or trademarks of Microsoft Corporation in the United States and/or other countries.

Android™

Android is a trademark of Google Inc.

Specifications

Input jacks

- Analog Audio
 - Audio x 4 (AV 5–6, AUDIO 1–2)
- Digital Audio (Supported frequencies: 32 kHz to 96 kHz)
 - Optical x 2 (AV 1, AV 4)
 - Coaxial x 2 (AV 2–3)
- Video
 - Composite x 5 (AV 3–6, VIDEO [Front Panel])
 - Component x 2 (AV 1–2)
- HDMI Input
 - HDMI x 6 (HDMI 1–5, V-AUX*)
 - * V-AUX: MHL input compatible
- Other
 - USB x 1 (USB2.0)
 - NETWORK x 1 (100Base-TX/10Base-T)

Output jacks

- Analog Audio
 - Speaker Out x 9 (7 ch) (FRONT L/R, CENTER, SURROUND L/R, SURROUND BACK L/R^{*1}, EXTRA SP L/R^{*2})
 - *1 Note: Assignment is possible [SURROUND BACK, BI-AMP (FRONT L/R)]
 - *2 Note: Assignment is possible [ZONE2, PRESENCE]
 - Subwoofer Out x 2 (SUBWOOFER 1–2, mono)
 - AV OUT x 1
 - ZONE2 OUT x 1
 - Headphone x 1
- Video
 - MONITOR OUT
 - Component x 1
 - Composite x 1
 - AV OUT
 - Composite x 1
- HDMI Output
 - HDMI OUT x 1

Other jacks

- YPAO MIC x 1
- REMOTE IN x 1
- REMOTE OUT x 1
- TRIGGER OUT x 1
- DC OUT x 1

HDMI

- HDMI features: Deep Color, "x.v.Color," Auto Lip Sync, ARC (Audio Return Channel), 3D, 4K
- Video Format (Repeater Mode)
 - VGA
 - 480i/60 Hz
 - 576i/50 Hz
 - 480p/60 Hz
 - 576p/50 Hz
 - 720p/60 Hz, 50 Hz
 - 1080i/60 Hz, 50 Hz
 - 1080p/60 Hz, 50 Hz, 30 Hz, 25 Hz, 24 Hz
 - 4K/30 Hz, 25 Hz, 24 Hz
- Audio Format
 - Dolby TrueHD
 - Dolby Digital Plus
 - Dolby Digital
 - DTS-HD Master Audio
 - DTS-HD High Resolution Audio
 - DTS Express
 - DTS
 - DSD 2-ch to 6-ch
 - PCM 2-ch to 8-ch (Max. 192 kHz/24-bit)
- Content Protection: HDCP compatible
- Link Function: CEC supported

MHL

- Video Format (Repeater Mode)
 - VGA
 - 480i/60 Hz
 - 576i/50 Hz
 - 480p/60 Hz
 - 576p/50 Hz
 - 720p/60 Hz, 50 Hz
 - 1080i/60 Hz, 50 Hz
 - 1080p/30 Hz, 25 Hz, 24 Hz
- Audio Format
 - PCM 2-ch to 8-ch (Max. 192 kHz/24-bit)
- Current Supply Capacity: 1.0 A

TUNER

- Analog Tuner
 - [Europe models]
 - FM/AM with Radio Data System x 1 (TUNER)
 - [Other models]
 - FM/AM x 1 (TUNER)

USB

- Capable of iPod, Mass Storage Class USB Memory
- Current Supply Capacity: 2.1 A

Network

- PC Client Function
- Compatible with DLNA ver. 1.5
- AirPlay supported
- Internet Radio

Compatible Decoding Formats

- Decoding Format
 - Dolby TrueHD, Dolby Digital Plus
 - Dolby Digital, Dolby Digital EX
 - DTS-HD Master Audio, DTS-HD High Resolution Audio, DTS Express
 - DTS 96/24, DTS-ES Matrix 6.1, DTS-ES Discrete 6.1
 - DTS Digital Surround
- Post Decoding Format
 - Dolby Pro Logic
 - Dolby Pro Logic II Music, Dolby Pro Logic II Movie, Dolby Pro Logic II Game
 - Dolby Pro Logic IIx Music, Dolby Pro Logic IIx Movie, Dolby Pro Logic IIx Game
 - DTS Neo:6 Music, DTS Neo:6 Cinema

Audio Section

- Rated Output Power (2-channel driven)
(20 Hz to 20 kHz, 0.09% THD, 8 Ω)
Front L/R 90 W+90 W
(1 kHz, 0.9% THD, 8 Ω)
Front L/R 105 W+105 W
Center 105 W
Surround L/R 105 W+105 W
Surround Back L/R 105 W+105 W
- Rated Output Power (1-channel driven)
(1 kHz, 0.9% THD, 8 Ω)
Front L/R 125 W/ch
Center 125 W/ch
Surround L/R 125 W/ch
Surround Back L/R 125 W/ch
(1 kHz, 0.9% THD, 4 Ω)
Front L/R [Europe models] 150 W/ch
- Dynamic Power (IHF)
Front L/R (8/6/4/2 Ω) 130/170/200/240 W
- Damping Factor
Front L/R, 20 Hz to 20 kHz, 8 Ω 100 or more

- Input Sensitivity / Input Impedance
AV 5 etc. (1 kHz, 100 W/8 Ω) 200 mV/47 kΩ
- Maximum Input Signal
AV 5 etc. (1 kHz, 0.5% THD, Effect On) 2.3 V
- Output Level / Output Impedance
AV OUT 200 mV/1.2 kΩ
SUBWOOFER 1 V/1.2 kΩ
ZONE2 OUT 200 mV/1.2 kΩ
- Headphone Jack Rated Output / Impedance
AV 5 etc. (1 kHz, 50 mV, 8 Ω) 100 mV/560 Ω
- Frequency Response
AV 5 etc. to Front (10 Hz to 100 kHz) +0/-3 dB
- Total Harmonic Distortion
AV 5 etc. to Front (Pure Direct)
(20 Hz to 20 kHz, 50 W, 8 Ω) 0.06% or less
- Signal to Noise Ratio (IHF-A Network)
AV 5 etc. (Input Shorted 250 mV, Speaker Out)
..... 100 dB or more
- Residual Noise (IHF-A Network)
Front L/R (Speaker Out) 150 μV or less
- Channel Separation
AV 5 etc. (Input 5.1 kΩ Shorted, 1 kHz/10 kHz)
..... 60 dB/45 dB or more
- Volume Control
Range MUTE, -80 dB to +16.5 dB
Step 0.5 dB
- Tone Control Characteristics
Bass Boost/Cut ±6 dB/0.5 dB Step at 50 Hz
Bass Turnover 350 Hz
Treble Boost/Cut ±6 dB/0.5 dB Step at 20 kHz
Treble Turnover 3.5 kHz
- Filter Characteristics
(fc=40/60/80/90/100/110/120/160/200 Hz)
H.P.F. (Front, Center, Surround, Surround Back) 12 dB/oct.
L.P.F. (Subwoofer) 24 dB/oct.

Video Section

- Video Signal Type
[U.S.A. model] NTSC
[Other models] PAL
- Video Signal Type (Video Conversion) NTSC/PAL
- Video Signal Level
Composite 1 Vp-p/75 Ω
Component
Y 1 Vp-p/75 Ω
Pb/Pr 0.7 Vp-p/75 Ω
- Video Maximum Input Level (Video Conversion Off)
..... 1.5 Vp-p or more
- Video Signal to Noise Ratio 50 dB or more
- Monitor Out Frequency Response (Video Conversion Off)
Component 5 Hz to 60 MHz, -3 dB

FM Section

- Tuning Range
[U.S.A. model] 87.5 to 107.9 MHz
[Other models] 87.50 MHz to 108.00 MHz
- 50 dB Quiet Sensitivity (IHF, 1 kHz, 100% MOD.)
Mono 3 μV (20.8 dBf)
- Signal to Noise Ratio (IHF)
Mono 71 dB
Stereo 69 dB
- Harmonic Distortion (IHF, 1 kHz)
Mono 0.3%
Stereo 0.5%
- Antenna Input 75 Ω unbalanced

AM section

- Tuning Range
[U.S.A. model] 530 to 1710 kHz
[Other models] 531 kHz to 1611 kHz

General

- Power Supply
 - [U.S.A. model] AC 120 V, 60 Hz
 - [Australia model] AC 240 V, 50 Hz
 - [Europe model] AC 230 V, 50 Hz
- Power Consumption
 - [U.S.A. model] 400 W/500 VA
 - [Other models] 300 W
- Standby Power Consumption
 - HDMI Control Off, Standby Through Off
 - [U.S.A. model] 0.10 W or less
 - [Other models] 0.15 W or less
 - HDMI Control On, Standby Through On (No Signals)
 - 3 W or less
 - Network Standby On 3 W or less
- Dimensions (W x H x D)
 - 435 x 171 x 364 mm (17-1/8" x 6-3/4" x 14-3/8")
 - * Including legs and protrusions
- Weight 10.0 kg (22.1 lbs)

* Specifications are subject to change without notice.

Index

Symbols

- ★ keys 11
- Exclamation mark (!) 98, 105
- Lock icon (🔒) 96

Numerics

- 16:9 Normal (Aspect, Setup menu) 90
- 2.1-channel system 15
- 2ch Stereo (sound program) 45
- 3.1-channel system 15
- 4.1-channel system 15
- 4K signal (video signal resolution) 120
- 5.1-channel system 15
- 5ch BI-AMP (Power Amp Assign, Setup menu) 85
- 6.1-channel system 14, 18
- 7.1+2-channel system 14, 17
- 7.1-channel system 14, 17, 18
- 7ch +1ZONE (Power Amp Assign, Setup menu) 85
- 7ch Stereo (sound program) 45

A

- Access denied (error indication) 113
- Access error (error indication) 113
- Action Game (sound program) 44
- Adaptive DRC (Option menu) 73
- Adaptive DSP Level (Sound, Setup menu) 89
- Adjustment (Lipsync, Setup menu) 88
- ADVANCED SETUP menu 99
- Adventure (sound program) 44
- AirPlay 65
- AM antenna connection 30
- AM radio listening 48
- Amp (Audio Output, Setup menu) 91
- ARC (Audio Return Channel) 21
- ARC (HDMI Control, Setup menu) 91
- Aspect (Video Mode, Setup menu) 90
- Audio Decoder (front display information) 71
- Audio device connection 29

- Audio file format (PC/NAS) 60
- Audio file format (USB storage device) 57
- Audio In (Input menu) 76
- AUDIO jack 20
- Audio Output (HDMI, Setup menu) 91
- Audio Return Channel (ARC) 21
- Audio Signal (Information menu) 98
- Auto Power Standby (ECO, Setup menu) 96
- Auto Preset (FM radio) 52
- Auto Setup (Speaker, Setup menu) 35
- Auto/Manual Select (Lipsync, Setup menu) 88
- Automatic speaker setting optimization 35
- Automatic station preset (FM radio) 52
- AutoPowerStdby (ECO, Setup menu) 96
- AV OUT jack 10

B

- Banana plug 18
- Basic playback operation 40
- Bass (Tone Control, Option menu) 73
- Bass Cross Over (Speaker, Setup menu) 86
- Bi-amp speaker connection 19
- Bitrate (Audio Signal, Information menu) 98
- Bitstream 120

C

- CAT-5 cable 31
- Cellar Club (sound program) 45
- Center (Speaker, Setup menu) 85
- Center Image (Sound Program menu) 81
- Center Width (Sound Program menu) 81
- Chamber (sound program) 45
- Channel (Audio Signal, Information menu) 98
- Check SP Wires (error indication) 113
- Check Sur. (YPAO error message) 38
- CINEMA DSP 3D 43
- CINEMA DSP 3D Mode (Option menu) 73
- CLASSICAL (sound program subcategory) 45

- Clear Preset (FM/AM radio) 52
- Clock Time (Radio Data System) 50
- COAXIAL jack 20
- Component video cable 20
- Component video connection (video device) 26
- COMPONENT VIDEO jack 20
- Composite video connection (video device) 27
- Compressed Music Enhancer 47
- Configuration (Speaker, Setup menu) 85
- Crossover frequency setting 86
- Crossover frequency setting (subwoofer) 35

D

- DC OUT (Function, Setup menu) 95
- DC OUT jack 10
- Decode Type (Sound Program menu) 80
- Decoder Mode (Input menu) 76
- Decoder Off (front display information) 71
- Default Gateway (IP Address, Setup menu) 92
- Default Gateway (Network, Information menu) 98
- Default setting restoration 100
- Delay Enable (Lipsync, Setup menu) 88
- Detail (Load, Scene menu) 78
- Device Control (Load, Scene menu) 78
- DHCP (IP Address, Setup menu) 92
- Dialog Adjust (Option menu) 73
- Dialog Lift (Dialog Adjust, Option menu) 73
- Dialog Lvl (Dialog Adjust, Option menu) 73
- Dialogue (Audio Signal, Information menu) 98
- Dialogue Adjust (Option menu) 73
- Dialogue Level (Dialogue Adjust, Option menu) 73
- Dialogue Lift (Dialogue Adjust, Option menu) 73
- Dialogue normalization level 98
- Digital coaxial cable 20
- Digital Media Controller (DMC) 77
- Digital optical cable 20
- Dimension (Sound Program menu) 81
- Dimmer (Front Display) (Display Set, Setup menu) 94

- Direct (Sound Program menu) 81
- Direct Stream Digital (DSD) 115
- DISPLAY key 11
- Display Set (Function, Setup menu) 94
- Distance (Speaker, Setup menu) 87
- Distance (YPAO measurement result) 37
- DLNA 60
- DMC (Digital Media Controller) 77
- DMC Control (Input menu) 77
- DNS Server (IP Address, Setup menu) 92
- DNS Server (Network, Information menu) 98
- Dolby Digital EX (Extended Surround) 74
- Dolby Pro Logic (surround decoder) 46
- Dolby Pro Logic II Game (surround decoder) 46
- Dolby Pro Logic II Movie (surround decoder) 46
- Dolby Pro Logic II Music (surround decoder) 46
- Dolby Pro Logic IIx Game (surround decoder) 46
- Dolby Pro Logic IIx Movie (Extended Surround) 74
- Dolby Pro Logic IIx Movie (surround decoder) 46
- Dolby Pro Logic IIx Music (Extended Surround) 74
- Dolby Pro Logic IIx Music (surround decoder) 46
- Drama (sound program) 44
- DSD (Direct Stream Digital) 115
- DSP Level (Sound Program menu) 80
- DSP Program (front display information) 71
- DTS Neo:6 Cinema (surround decoder) 46
- DTS Neo:6 Music (surround decoder) 46
- DTS-ES (Extended Surround) 74
- Dynamic Range (Sound, Setup menu) 88
- E**
- ECO (Setup menu) 96
- ECO Mode (ECO, Setup menu) 96
- Enhancer (Option menu) 74
- ENHANCER (sound mode) 47
- ENTERTAINMENT (sound program subcategory) 44
- Error indication (front display) 113
- EX/ES (Extended Surround, Option menu) 74
- EXTD Surround (Option menu) 74
- Extended Surround (Option menu) 74
- External device control (remote control) 102
- External device operation key (remote control) 11
- Extra Bass (Speaker, Setup menu) 86
- F**
- Filter (MAC Address Filter, Setup menu) 92
- Firmware update 100
- Firmware update (network) 100, 105
- Firmware update (USB) 100
- Firmware Version (System, Information menu) 98
- Firmware version check 101
- FM antenna connection 30
- FM Mode (Option menu) 74
- FM radio listening 48
- FM/AM radio tuning 48
- Format (Audio Signal, Information menu) 98
- Frequency (FM/AM radio) 48
- Front (Speaker, Setup menu) 85
- Front / Rear Balance (Sound Program menu) 81
- Front display (part names and functions) 9
- Front display brightness 94
- Front display information 71
- Front panel (part names and functions) 8
- Front panel jack connection 29
- Front Presence (Speaker, Setup menu) 86
- Function (Setup menu) 94
- H**
- Hall in Munich (sound program) 45
- Hall in Vienna (sound program) 45
- HDMI (Setup menu) 90
- HDMI cable 20
- HDMI connection (video device) 26
- HDMI Control (HDMI, Setup menu) 90
- HDMI jack 20
- HDMI Monitor (Information menu) 98
- HDMI OUT (Audio Output, Setup menu) 91
- HDMI signal compatibility 120
- Headphones 43
- Height Balance (Sound Program menu) 81
- High definition audio 120
- High speed HDMI cable 20
- I**
- In.Trim (Volume Trim, Option menu) 74
- Indicator (part names and functions) 9
- INFO key 8, 11
- Information display (front display) 9
- Information menu 97
- Information switching (front display) 71
- INIT (ADVANCED SETUP menu) 100
- Initial Delay (Sound Program menu) 80
- Initial Volume (Sound, Setup menu) 89
- Initial Volume (Zone2 Set, Setup menu) 94
- Input (Audio Signal, Information menu) 98
- Input (front display information) 71
- Input menu 75
- Input selection key (remote control) 11
- Input Trim (Volume Trim, Option menu) 74
- Internal Error (error indication) 113
- Internal Error (YPAO error message) 38
- Internet radio listening 63
- IP Address (Network, Information menu) 98
- IP Address (Network, Setup menu) 92
- iPod charge 53
- iPod connection 53
- iPod content playback 54
- iPod content playback (AirPlay) 65
- iTunes content playback (AirPlay) 65
- L**
- Language (Setup menu) 97
- Left / Right Balance (Sound Program menu) 81
- Level (Sound Program menu) 81
- Level (Speaker, Setup menu) 87
- Level (YPAO measurement result) 37
- Level Error (YPAO warning message) 39
- LFE (Low Frequency Effects) 116
- Lipsync 116
- Lipsync (Sound, Setup menu) 88
- LIVE/CLUB (sound program subcategory) 45
- Liveness (Sound Program menu) 80

Load (Scene menu) 78
 Low Frequency Effects (LFE) 116

M

MAC Address (MAC Address Filter, Setup menu) 92
 MAC Address (Network, Information menu) 98
 MAC Address Filter (Network, Setup menu) 92
 Main Zone Set (Multi Zone, Setup menu) 93
 Manual Setup (Speaker, Setup menu) 85
 Manual speaker configuration 85
 Manual station preset (FM/AM radio) 49
 Max Volume (Sound, Setup menu) 89
 Max Volume (Zone2 Set, Setup menu) 94
 Measurement result (YPAO) 37
 Media sharing setup 60
 Memory Guard (Function, Setup menu) 96
 Menu language selection 34
 Menu operation key (remote control) 11
 MHL cable 20
 MHL connection 30
 MHL jack 20
 MHL Overloaded (error indication) 113
 MHL-compatible mobile device 30
 MODE key 11
 MON.CHK (ADVANCED SETUP menu) 100
 Monaural Mix (Sound Program menu) 81
 Monaural reception (FM radio) 48
 Monitor check 100
 Mono Movie (sound program) 44
 MOVIE (sound program category) 44
 MOVIE THEATER (sound program subcategory) 44
 Multi Zone (Information menu) 98
 Multi Zone (Setup menu) 93
 Multiple room playback 67
 Multi-zone 67
 MUSIC (sound program category) 45
 Music Video (sound program) 44
 MUTE key 11
 Muting 40

N

NAS (Network Attached Storage) 31
 NAS connection 31
 NAS content playback 60
 Network (Information menu) 98
 Network (Setup menu) 92
 Network Attached Storage (NAS) 31
 Network cable 31
 Network connection 31
 Network information 98
 Network Name (Network, Information menu) 98
 Network Name (Network, Setup menu) 93
 Network Standby (Network, Setup menu) 92
 No content (error indication) 113
 No device (error indication) 113
 No F.PRNS SP (YPAO error message) 38
 No Front SP (YPAO error message) 38
 No MIC (YPAO error message) 38
 No Signal (YPAO error message) 38
 No Sur. SP (YPAO error message) 38
 Noisy (YPAO error message) 38
 Normal (Wiring, YPAO measurement result) 37
 NTSC (TV FORMAT, ADVANCED SETUP menu) 100
 Numeric key (remote control) 11

O

ON SCREEN key 11
 OPTICAL jack 20
 OPTION key 11
 Option menu 72
 Out of Phase (YPAO warning message) 39
 Output (Audio Signal, Information menu) 98
 Over Distance (YPAO warning message) 39

P

PAL (TV FORMAT, ADVANCED SETUP menu) 100
 Panorama (Sound Program menu) 81
 Parametric EQ (Speaker, Setup menu) 87
 PC connection 31
 PC content playback 60

PHONES jack 8
 Playback device connection 26
 Playback device operation (remote control) 103
 Please wait (error indication) 113
 Power Amp Assign (Speaker, Setup menu) 85
 Power cable connection 33
 Power management 96
 Power Mode (DC OUT, Setup menu) 95
 Preset station selection (FM/AM radio) 49
 Program Service (Radio Data System) 50
 Program Type (Radio Data System) 50
 Pure Direct 47
 PURE DIRECT (sound mode) 47

Q

Q factor 87

R

Radio Data System (FM radio) 50
 Radio Data System information 50
 Radio Data System tuning 50
 Radio Text (Radio Data System) 50
 Rear panel (part names and functions) 10
 Recording device connection 32
 RemID Mismatch (error indication) 113
 Remote connection 69
 Remote control (part names and functions) 11
 Remote control code registration (playback device) 103
 Remote control code registration (TV) 102
 Remote Control Code Search 102, 103
 Remote control ID setting 99
 Remote control ID setting (remote control) 99
 Remote control sensor 8
 Remote control signal transmitter (remote control) 11
 REMOTE ID (ADVANCED SETUP menu) 99
 Remote ID (System, Information menu) 98
 REMOTE IN jack 10
 REMOTE OUT jack 10
 Rename (input name) 76
 Rename (network name) 93

- Rename (scene name) 79
- Rename/Icon Select (Input menu) 76
- Rename/Icon Select (Scene menu) 79
- Repeat (iPod, Option menu) 56
- Repeat (PC/NAS, Option menu) 62
- Repeat (USB storage device, Option menu) 59
- Reset (remote control) 104
- Reset (Scene menu) 79
- Resolution (Video Mode, Setup menu) 89
- Reverb Delay (Sound Program menu) 81
- Reverb Level (Sound Program menu) 81
- Reverb Time (Sound Program menu) 81
- Reverse (Wiring, YPAO measurement result) 37
- Roleplaying Game (sound program) 44
- Room Size (Sound Program menu) 80
- Router connection 31

S

- Sampling (Audio Signal, Information menu) 98
- Save (Scene menu) 78
- SBR → SBL (YPAO error message) 38
- Scene configuration 41
- SCENE function 41
- SCENE link playback 41
- Scene menu 77
- Sci-Fi (sound program) 44
- Setup menu 82
- Short Message (Display Set, Setup menu) 94
- Shuffle (iPod, Option menu) 56
- Shuffle (PC/NAS, Option menu) 62
- Shuffle (USB storage device, Option menu) 59
- Signal information 98
- SILENT CINEMA 43
- Simple play (iPod) 55
- Size (YPAO measurement result) 37
- SLEEP key 11
- Sleep timer 11
- Sleep timer (Zone2) 70
- Sound (Setup menu) 88
- Sound field effect 43

- Sound mode selection 42
- Sound program 44, 45
- Sound Program menu 79
- SP IMP. (ADVANCED SETUP menu) 99
- Speaker (Setup menu) 85
- Speaker cable connection 18
- Speaker connection 17
- Speaker impedance 13
- Speaker Impedance (System, Information menu) 98
- Speaker impedance setting 16, 99
- Speaker indicator (front display) 9
- Speaker placement 13
- Spectacle (sound program) 44
- Sports (sound program) 44
- Standard (sound program) 44
- Standby indicator (front panel) 8
- Standby Sync (HDMI Control, Setup menu) 91
- Standby Through (HDMI, Setup menu) 91
- Station preset (FM/AM radio) 49
- Status (Network, Information menu) 98
- STEREO (sound program subcategory) 45
- Stereo pin cable (RCA cable) 20
- Stereo reception (FM radio) 48
- STP network cable 31
- STRAIGHT (sound mode) 46
- Straight decode 46
- Subnet Mask (IP Address, Setup menu) 92
- Subnet Mask (Network, Information menu) 98
- Subwoofer (Speaker, Setup menu) 86
- Subwoofer connection 19
- Subwoofer Trim (Volume Trim, Option menu) 74
- SUR.DECODE (sound mode) 46
- Surround (Speaker, Setup menu) 85
- Surround Back (Speaker, Setup menu) 86
- Surround Back Initial Delay (Sound Program menu) 80
- Surround Back Liveness (Sound Program menu) 80
- Surround Back Room Size (Sound Program menu) 80
- Surround decoder 46
- Surround Initial Delay (Sound Program menu) 80
- Surround Liveness (Sound Program menu) 80

- Surround Room Size (Sound Program menu) 80
- SW.Trim (Volume Trim, Option menu) 74
- System (Information menu) 98
- System ID (System, Information menu) 98

T

- Target Zone (Trigger Output, Setup menu) 95
- Test Tone (Speaker, Setup menu) 88
- The Bottom Line (sound program) 45
- The Roxy Theatre (sound program) 45
- Tone Control (Option menu) 73
- TONE CONTROL key 8
- TP (Traffic Program) 50
- Traffic information (Radio Data System) 50
- Traffic Program (FM radio, Option menu) 50
- Treble (Tone Control, Option menu) 73
- Trigger function 32
- Trigger Mode (Trigger Output, Setup menu) 95
- TRIGGER OUT jack 10
- Trigger Output (Function, Setup menu) 95
- TV Audio Input (HDMI Control, Setup menu) 90
- TV connection 21
- TV connection (ARC-compatible TV) 21
- TV connection (HDMI Control-compatible TV) 23
- TV connection (TV with HDMI input jacks) 24
- TV connection (TV without HDMI input jacks) 25
- TV FORMAT (ADVANCED SETUP menu) 100
- TV Format (System, Information menu) 98
- TV operation (remote control) 102
- TV operation key (remote control) 11

U

- Unable to play (error indication) 113
- UPDATE (ADVANCED SETUP menu) 100
- USB jack 8
- USB mass storage class device 57
- USB Overloaded (error indication) 113
- USB storage device connection 57
- USB storage device content playback 57
- User Cancel (YPAO error message) 38

V

- VERSION (ADVANCED SETUP menu) 101
- Version error (error indication) 113
- Video (Setup menu) 89
- VIDEO AUX jack 8
- Video device connection 26
- VIDEO jack 20
- Video Mode (Option menu) 74
- Video Mode (Video, Setup menu) 89
- Video Out (Input menu) 77
- Video pin cable 20
- Video Signal (Information menu) 98
- Video signal flow 118
- Video signal type setting 100
- Video/audio input jack combination 27
- Virtual CINEMA DSP 43
- Virtual Presence Speaker (VPS) 7
- Volume Interlock (Input menu) 77
- Volume Trim (Option menu) 74
- VPS (Virtual Presence Speaker) 7

W

- Wallpaper (Display Set, Setup menu) 95
- Wiring (YPAO measurement result) 37

Y

- Yamaha Parametric room
 - Acoustic Optimizer (YPAO) 35
- YPAO
 - (Yamaha Parametric room Acoustic Optimizer) 35
- YPAO error message 38
- YPAO MIC jack 8
- YPAO microphone 35
- YPAO warning message 39

Z

- Zone Rename (Main Zone Set, Setup menu) 93
- Zone Rename (Zone2 Set, Setup menu) 94
- Zone2 Set (Multi Zone, Setup menu) 94
- Zone2 speaker connection 68



YAMAHA CORPORATION

© 2013 Yamaha Corporation YF237A0/EN