



PORTATONE

PSR-160

Owner's Manual



SPECIAL MESSAGE SECTION

This product utilizes batteries or an external power supply (adapter). DO NOT connect this product to any power supply or adapter other than one described in the manual, on the name plate, or specifically recommended by Yamaha.

This product should be used only with the components supplied or; a cart, rack, or stand that is recommended by Yamaha. If a cart, etc., is used, please observe all safety markings and instructions that accompany the accessory product.

SPECIFICATIONS SUBJECT TO CHANGE:

The information contained in this manual is believed to be correct at the time of printing. However, Yamaha reserves the right to change or modify any of the specifications without notice or obligation to update existing units.

This product, either alone or in combination with an amplifier and headphones or speaker/s, may be capable of producing sound levels that could cause permanent hearing loss. DO NOT operate for long periods of time at a high volume level or at a level that is uncomfortable. If you experience any hearing loss or ringing in the ears, you should consult an audiologist.

IMPORTANT: The louder the sound, the shorter the time period before damage occurs.

NOTICE:

Service charges incurred due to a lack of knowledge relating to how a function or effect works (when the unit is operating as designed) are not covered by the manufacturer's warranty, and are therefore the owners responsibility. Please study this manual carefully and consult your dealer before requesting service.

ENVIRONMENTAL ISSUES:

Yamaha strives to produce products that are both user safe and environmentally friendly. We sincerely believe that our products and the production methods used to produce them, meet these goals. In keeping with both the letter and the spirit of the law, we want you to be aware of the following:

Battery Notice:

This product MAY contain a small non-rechargeable battery which (if applicable) is soldered in place. The average life span of this type of battery is approximately five years. When replacement becomes necessary, contact a qualified service representative to perform the replacement.

This product may also use "household" type batteries. Some of these may be rechargeable. Make sure that the battery being charged is a rechargeable type and that the charger is intended for the battery being charged.

When installing batteries, do not mix batteries with new, or with batteries of a different type. Batteries MUST be installed correctly. Mismatches or incorrect installation may result in overheating and battery case rupture.

Warning:

Do not attempt to disassemble, or incinerate any battery. Keep all batteries away from children. Dispose of used batteries promptly and as regulated by the laws in your area. Note: Check with any retailer of household type batteries in your area for battery disposal information.

Disposal Notice:

Should this product become damaged beyond repair, or for some reason its useful life is considered to be at an end, please observe all local, state, and federal regulations that relate to the disposal of products that contain lead, batteries, plastics, etc. If your dealer is unable to assist you, please contact Yamaha directly.

NAME PLATE LOCATION:

The name plate is located on the bottom of the product. The model number, serial number, power requirements, etc., are located on this plate. You should record the model number, serial number, and the date of purchase in the spaces provided below and retain this manual as a permanent record of your purchase.

Model _____

Serial No. _____

Purchase Date _____

92-BP (bottom)

PLEASE KEEP THIS MANUAL

FCC INFORMATION (U.S.A.)

1. IMPORTANT NOTICE: DO NOT MODIFY THIS UNIT!

This product, when installed as indicated in the instructions contained in this manual, meets FCC requirements. Modifications not expressly approved by Yamaha may void your authority, granted by the FCC, to use the product.

2. IMPORTANT: When connecting this product to accessories and/or another product use only high quality shielded cables. Cable/s supplied with this product MUST be used. Follow all installation instructions. Failure to follow instructions could void your FCC authorization to use this product in the USA.

3. NOTE: This product has been tested and found to comply with the requirements listed in FCC Regulations, Part 15 for Class "B" digital devices. Compliance with these requirements provides a reasonable level of assurance that your use of this product in a residential environment will not result in harmful interference with other electronic devices. This equipment generates/uses radio frequencies and, if not installed and used according to the instructions found in the users manual, may cause interference harmful to the operation of other electronic devices. Compliance

with FCC regulations does not guarantee that interference will not occur in all installations. If this product is found to be the source of interference, which can be determined by turning the unit "OFF" and "ON", please try to eliminate the problem by using one of the following measures:

Relocate either this product or the device that is being affected by the interference.

Utilize power outlets that are on different branch (circuit breaker or fuse) circuits or install AC line filter/s.

In the case of radio or TV interference, relocate/reorient the antenna. If the antenna lead-in is 300 ohm ribbon lead, change the lead-in to co-axial type cable.

If these corrective measures do not produce satisfactory results, please contact the local retailer authorized to distribute this type of product. If you can not locate the appropriate retailer, please contact Yamaha Corporation of America, Electronic Service Division, 6600 Orangethorpe Ave, Buena Park, CA90620

The above statements apply ONLY to those products distributed by Yamaha Corporation of America or its subsidiaries.

* This applies only to products distributed by YAMAHA CORPORATION OF AMERICA.

(class B)

OBSERVERA!

Apparaten kopplas inte ur växelströmskällan (nätet) så länge som den är ansluten till vägguttaget, även om själva apparaten har stängts av.

ADVARSSEL: Netspændingen til dette apparat er IKKE afbrudt, så længe netledningen sidder i en stikkontakt, som er tændt — også selvom der er slukket på apparatets afbryder.

VAROITUS: Laitteen toisiopiiriin kytketty käyttökytkin ei irroita koko laitetta verkosta.

(standby)

Entsorgung leerer Batterien (nur innerhalb Deutschlands)

Leisten Sie einen Beitrag zum Umweltschutz. Verbrauchte Batterien oder Akkumulatoren dürfen nicht in den Hausmüll. Sie können bei einer Sammelstelle für Altbatterien bzw. Sondermüll abgegeben werden. Informieren Sie sich bei Ihrer Kommune.

(battery)

PRECAUTIONS

PLEASE READ CAREFULLY BEFORE PROCEEDING

* Please keep these precautions in a safe place for future reference.



WARNING

Always follow the basic precautions listed below to avoid the possibility of serious injury or even death from electrical shock, short-circuiting, damages, fire or other hazards. These precautions include, but are not limited to, the following:

- Do not open the instrument or attempt to disassemble the internal parts or modify them in any way. The instrument contains no user-serviceable parts. If it should appear to be malfunctioning, discontinue use immediately and have it inspected by qualified Yamaha service personnel.
- Do not expose the instrument to rain, use it near water or in damp or wet conditions, or place containers on it containing liquids which might spill into any openings.
- If the AC adaptor cord or plug becomes frayed or damaged, or if there is a sudden loss of sound during use of the instrument, or if any unusual smells or smoke should appear to be caused by it, immediately turn off the power switch, disconnect the adaptor plug from the outlet, and have the instrument inspected by qualified Yamaha service personnel.
- Use the specified adaptor (PA-3B or an equivalent recommended by Yamaha) only. Using the wrong adaptor can result in damage to the instrument or overheating.
- Before cleaning the instrument, always remove the electric plug from the outlet. Never insert or remove an electric plug with wet hands.
- Check the electric plug periodically and remove any dirt or dust which may have accumulated on it.



CAUTION

Always follow the basic precautions listed below to avoid the possibility of physical injury to you or others, or damage to the instrument or other property. These precautions include, but are not limited to, the following:

- Do not place the AC adaptor cord near heat sources such as heaters or radiators, and do not excessively bend or otherwise damage the cord, place heavy objects on it, or place it in a position where anyone could walk on, trip over, or roll anything over it.
- When removing the electric plug from the instrument or an outlet, always hold the plug itself and not the cord.
- Do not connect the instrument to an electrical outlet using a multiple-connector. Doing so can result in lower sound quality, or possibly cause overheating in the outlet.
- Unplug the AC power adaptor when not using the instrument, or during electrical storms.
- Always make sure all batteries are inserted in conformity with the +/- polarity markings. Failure to do so might result in overheating, fire, or battery fluid leakage.
- Always replace all batteries at the same time. Do not use new batteries together with old ones. Also, do not mix battery types, such as alkaline batteries with manganese batteries, or batteries from different makers, or different types of batteries from the same maker, since this can cause overheating, fire, or battery fluid leakage.
- Do not dispose of batteries in fire.
- Do not attempt to recharge batteries that are not intended to be charged.
- When the batteries run out, or if the instrument is not to be used for a long time, remove the batteries from the instrument to prevent possible leakage of the battery fluid.
- Keep batteries away from children.
- If the batteries do leak, avoid contact with the leaked fluid. If the battery fluid should come in contact with your eyes, mouth, or skin, wash immediately with water and consult a doctor. Battery fluid is corrosive and may possibly cause loss of sight or chemical burns.
- Before connecting the instrument to other electronic components, turn off the power for all components. Before turning the power on or off for all components, set all volume levels to minimum. Also, be sure to set the volumes of all components at their minimum levels and gradually raise the volume controls while playing the instrument to set the desired listening level.
- Do not expose the instrument to excessive dust or vibrations, or extreme cold or heat (such as in direct sunlight, near a heater, or in a car during the day) to prevent the possibility of panel disfiguration or damage to the internal components.
- Do not use the instrument near other electrical products such as televisions, radios, or speakers, since this might cause interference which can affect proper operation of the other products.
- Do not place the instrument in an unstable position where it might accidentally fall over.
- Before moving the instrument, remove all connected adaptor and other cables.
- When cleaning the instrument, use a soft, dry cloth. Do not use paint thinners, solvents, cleaning fluids, or chemical-impregnated wiping cloths. Also, do not place vinyl, plastic or rubber objects on the instrument, since this might discolor the panel or keyboard.
- Do not rest your weight on, or place heavy objects on the instrument, and do not use excessive force on the buttons, switches or connectors.
- Use only the stand specified for the instrument. When attaching the stand or rack, use the provided screws only. Failure to do so could cause damage to the internal components or result in the instrument falling over.
- Do not operate the instrument for a long period of time at a high or uncomfortable volume level, since this can cause permanent hearing loss. If you experience any hearing loss or ringing in the ears, consult a physician.

■SAVING USER DATA

- Always save data to an external device such as the Yamaha MIDI data filer MDF3 frequently, in order to help prevent the loss of important data due to a malfunction or user operating error.

Yamaha cannot be held responsible for damage caused by improper use or modifications to the instrument, or data that is lost or destroyed.

Always turn the power off when the instrument is not in use.

Make sure to discard used batteries according to local regulations.

* The illustrations and LCD screens as shown in this owner's manual are for instructional purposes only, and may be different from the ones on your instrument.

Congratulations on your purchase of the Yamaha PSR-160 PortaTone!

You now own a portable keyboard that combines advanced functions, great sound and exceptional ease-of-use in a highly compact package. Its outstanding features also make it a remarkably expressive and versatile instrument.

Read this Owner's Manual carefully while playing your new PSR-160 in order to take full advantage of its various features.

Main Features

The PSR-160 is a sophisticated yet easy-to-use keyboard with the following features and functions:



■ Yamaha Education Suite

The PSR-160 features the new Yamaha Education Suite — a set of learning tools that utilize the latest technology to make studying and practicing music more fun and fulfilling than ever before!

The Yamaha Education Suite includes:

● **Lesson page 34**

The convenient and easy-to-use Lesson feature, guides you through the parts of a song — just like a patient teacher! Select from any one of 100 songs on the PSR-160, and learn the left- and right-hand parts independently at first, then together. Lesson features four easy steps that help you master each song: Timing, Waiting, Minus One, and Both Hands.

● **Grade & Talking pages 39, 40**

The PSR-160 also has the Grade and Talking features. Grade is a virtual “teacher,” evaluating your practice sessions and rating your performance. The convenient Talking function “announces” each Lesson step and your “grades,” among other things.

● **Dictionary page 41**

Dictionary is a built-in “chord encyclopedia” that teaches you how to play specific chords by showing you the appropriate notes in the display — perfect for when you know the name of a chord and want to quickly learn how to play it!



■ Portable Grand page 20

The PSR-160 also has a **Portable Grand** function for realistic piano performance. Pressing the [Piano] button instantly calls up the stunningly authentic “Stereo Sampled Piano” voice and configures the entire PSR-160 for optimum piano play. Special Pianist styles — with piano-only accompaniment — are also provided.



■ DJ page 22

The DJ feature is an exciting new addition to the PSR-160, that puts a wealth of contemporary sounds and rhythms at your fingertips. Pressing the [DJ] button instantly calls up one of the special DJ songs (“DJ GAME”) and a DJ style, and provides the appropriate voice and sound effects to match.

Other powerful features include:

- Exceptionally realistic and dynamic sounds with 100 voices, utilizing digital recordings of actual instruments.
- 100 dynamic auto accompaniment Styles, each with different Intro, Main A and B, and Ending sections. All styles (except for the Piano styles) also have their own two Fill-in patterns.
- Large custom LCD gives you easy, at-a-glance confirmation of all important settings, as well as chord and note indications.
- 100 songs, for your listening enjoyment — or for use with the sophisticated learning tools of the Yamaha Education Suite.
- Convenient control over accompaniment Styles — including Tempo, Tap Tempo and independent Accompaniment Volume.
- Four Multi Pads, for instantly adding special instrumental breaks, fills, and phrases to your performance.
- One Touch Setting (OTS), for automatically calling up an appropriate voice for playing with the selected Style and Song.
- MIDI terminals for interfacing with other MIDI devices.
- Built-in, high-quality stereo amplifier/speaker system.

Contents

Panel Controls and Terminals	6	Talking	40
Setting Up	8	Dictionary	41
Power Requirements	8	Selecting and Playing Styles	42
Turning On the Power.....	8	Selecting and Playing a Style.....	42
Accessory Jacks	9	Playing the Accompaniment.....	43
		Changing the Tempo.....	46
		Style Sections (Main A, Main B) and Fill-ins	46
		Adjusting the Accompaniment Volume	47
		Using Auto Accompaniment	
		— Multi Fingering.....	48
		Multi Pads	51
		MIDI	52
		Troubleshooting	53
		Voice List	54
		Drum Kit List	56
		Style List & Multi pads	57
		MIDI Implementation Chart	58
		Specifications	60
		Index	61
Getting Started			
— Playing the Demo Songs	18		
Panel Display Indications	19		
Portable Grand	20		
Playing the Portable Grand.....	20		
Using the Metronome.....	20		
DJ	22		
Playing the DJ.....	22		
Selecting and Playing Voices	23		
Selecting and Playing a Voice	23		
One Touch Setting	26		
Transpose and Tuning.....	27		
Selecting and Playing Songs	29		
Selecting and Playing a Song	29		
Melody Voice Change.....	30		
Changing the Tempo	31		
Adjusting the Song Volume.....	32		
Song Controls	32		
A-B Repeat	33		
Song Lesson	34		
Using the Lesson Feature	34		
Lesson 1 — Timing	36		
Lesson 2 — Waiting.....	37		
Lesson 3 — Minus One	37		
Lesson 4 — Both Hands	38		
Grade	39		



Panel Controls and Terminals

■ Front Panel

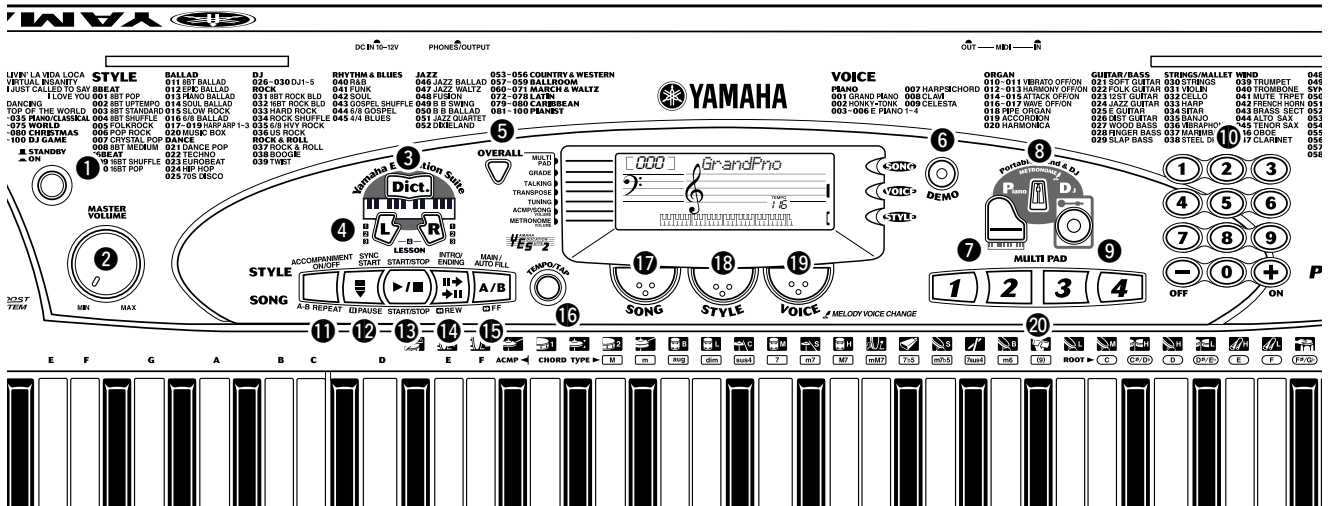

1 Power switch ([STANDBY/ON])

2 [MASTER VOLUME] dial

This determines the overall volume of the PSR-160.

3 [Dict.] (DICTIONARY) button

This calls up the Dictionary function (See page 41).

4 LESSON [L] (Left) and [R] (Right) buttons

These call up the Lesson exercises for the corresponding hand (left or right) for the selected song. (See page 35.)

5 [OVERALL] button

This is for selecting the various “overall” functions. (See page 21.)

6 [DEMO] button

This is used to play the Demo songs. (See page 18.)

7 [Piano] button

This instantly calls up the Grand Piano voice, plus a special piano song and style. (See page 20.)

8 [METRONOME] button

This turns the metronome on and off. (See page 20.)

9 [DJ] button

This instantly calls up a special DJ voice, song and style. (See page 22.)

10 Numeric keypad, [+ / ON] and [- / OFF] buttons

These are used for selecting songs, voices, and styles. (See page 24.) They are also used for entering values and adjusting or making certain settings.

11 [ACCOMPANIMENT ON/OFF] ([A-B REPEAT]) button

When the Style mode is selected, this turns the auto accompaniment on and off. (See page 43.) When the Song mode is selected, this controls the A-B Repeat function. (See page 33.)

12 [SYNC START] ([PAUSE]) button

When the Style mode is selected, this turns the Sync Start function on and off. (See page 44.) When the Song mode is selected, this alternately pauses and starts song playback. (See page 32.)

13 [START/STOP] button

When the Style mode is selected, this alternately starts and stops the auto accompaniment. (See page 43.) When the Song mode is selected, this alternately starts and stops song playback. (See page 32.)

14 [INTRO/ENDING] ([REW]) button

When the Style mode is selected, this is used to control the Intro and Ending functions. (See page 45.)

When the Song mode is selected, this is used to rewind during song playback. When song playback is stopped, it is used to reverse to specific measure numbers in the song. (See page 32.)

15 [MAIN/AUTO FILL] ([FF]) button

When the Style mode is selected, this is used to change auto accompaniment sections and control the Auto Fill function. (See page 46.) When the Song mode is selected, this is used to fast forward during song playback. When song playback is stopped, it is used to advance to specific measure numbers in the song. (See page 32.)

16 [TEMPO/TAP] button

This button allows you to tap out the tempo and automatically start a selected song or style at that tapped speed. (See page 44.) It also is used to call up the Tempo setting, letting you set the Tempo with the numeric keypad or [+]/[-] buttons. (See page 31.)

17 [SONG] button

This is for enabling song selection. (See page 29.)

18 [STYLE] button

This is for enabling style selection. (See page 42.)

19 [VOICE] button

This is for enabling voice selection. (See page 23.) Holding down this button calls up the Melody Voice Change function. (See page 30.)

20 [MULTI PAD] buttons

These are used to automatically play pre-programmed musical phrases. (See page 51.)

■ Rear Panel

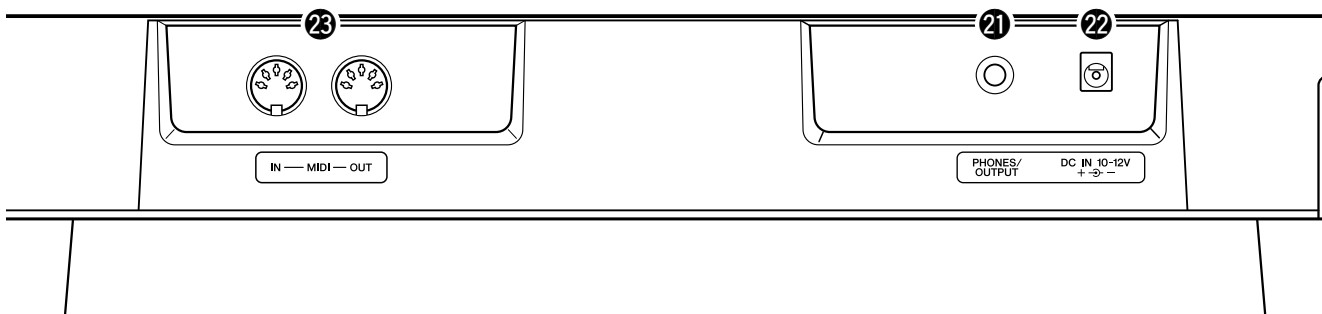

21 PHONES/OUTPUT jack

This is for connection to a set of stereo headphones or to an external amplifier/speaker system. (See page 9.)

22 DC IN 10-12V jack

This is for connection to a PA-3B AC power adaptor. (See page 8.)

23 MIDI IN, OUT terminals

These are for connection to other MIDI instruments and devices. (See pages 9, 52.)



Setting Up

This section contains information about setting up your PSR-160 for playing. Make sure to read this section carefully before using the instrument.

Power Requirements

Although the PSR-160 will run either from an optional AC adaptor or batteries, Yamaha recommends use of an AC adaptor whenever possible. An AC adaptor is more environmentally friendly than batteries and does not deplete resources.

■ Using an AC Power Adaptor

To connect your PSR-160 to a wall socket, you will need the optionally available Yamaha PA-3B Power Adaptor. Use of other AC adaptors could result in damage to the instrument, so be sure to ask for the right kind. Connect one end of the adaptor to the DC IN 10-12V jack on the rear panel of your PSR-160, and the other end to a suitable electrical outlet.

⚠ **WARNING**

- Use **ONLY** a Yamaha PA-3B AC Power Adaptor (or other adaptor specifically recommended by Yamaha) to power your instrument from the AC mains. The use of other adaptors may result in irreparable damage to both the adaptor and the PSR-160.
- Unplug the AC Power Adaptor when not using the PSR-160, or during electrical storms.

■ Using Batteries

● Inserting Batteries

Turn the instrument upside-down and remove the battery compartment lid. Insert six 1.5-volt size “D” (SUM-1, R-20 or equivalent) batteries as shown in the illustration, making sure that the positive and negative terminals are properly aligned, and replace the lid.

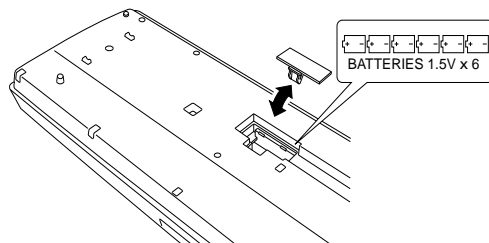

⚠ **CAUTION**

- Never mix old and new batteries or different types of batteries (e.g., alkaline and manganese).
- To prevent possible damage from battery leakage, remove the batteries from the instrument if it is not to be used for a long time.

● When the Batteries Run Down

When the batteries run low and the battery voltage drops below a certain level, the PSR-160 may not sound or function properly. As soon as this happens, replace them with a complete set of six new batteries.

Turning On the Power

With the AC power adaptor connected or with batteries installed, simply press the STANDBY switch until it locks in the ON position. When the instrument is not in use, be sure to turn the power off. (Press the switch again so that it pops up.)



⚠ **CAUTION**

- Even when the switch is in the “STANDBY” position, electricity is still flowing to the instrument at the minimum level. When you are not using the PSR-160 for a long time, make sure you unplug the AC power adaptor from the wall AC outlet, and/or remove the batteries from the instrument.

Accessory Jacks

■ Using Headphones •••••

For private practicing and playing without disturbing others, connect a set of stereo headphones to the rear panel PHONES/OUTPUT jack. Sound from the built-in speaker system is automatically cut off when you insert a headphone plug into this jack.

■ Connecting a Keyboard Amplifier or Stereo System •••••

Though the PSR-160 is equipped with a built-in speaker system, you can also play it through an external amplifier/speaker system. First, make sure the PSR-160 and any external devices are turned off, then connect one end of a stereo audio cable to the LINE IN or AUX IN jack(s) of the other device and the other end to the rear panel PHONES/OUTPUT jack on the PSR-160.

⚠ CAUTION

- To prevent damage to the speakers, set the volume of the external devices at the minimum setting before connecting them. Failure to observe these cautions may result in electric shock or equipment damage. Also, be sure to set the volumes of all devices at their minimum levels and gradually raise the volume controls while playing the instrument to set the desired listening level.

■ Using the MIDI Terminals •••••

The PSR-160 also features MIDI terminals, allowing you to interface the PSR-160 with other MIDI instruments and devices. (For more information, see page 52.)

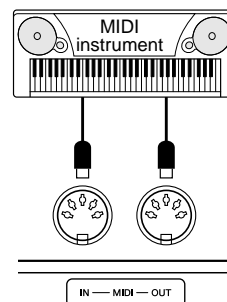

Music Stand

Insert the bottom edge of the included music stand into the slot located at the top rear of the PSR-160 control panel.

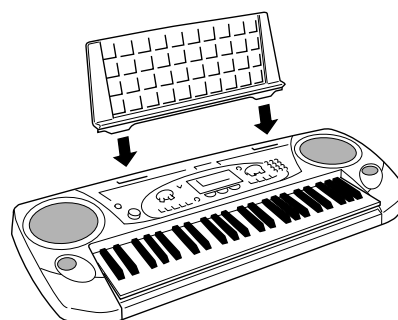

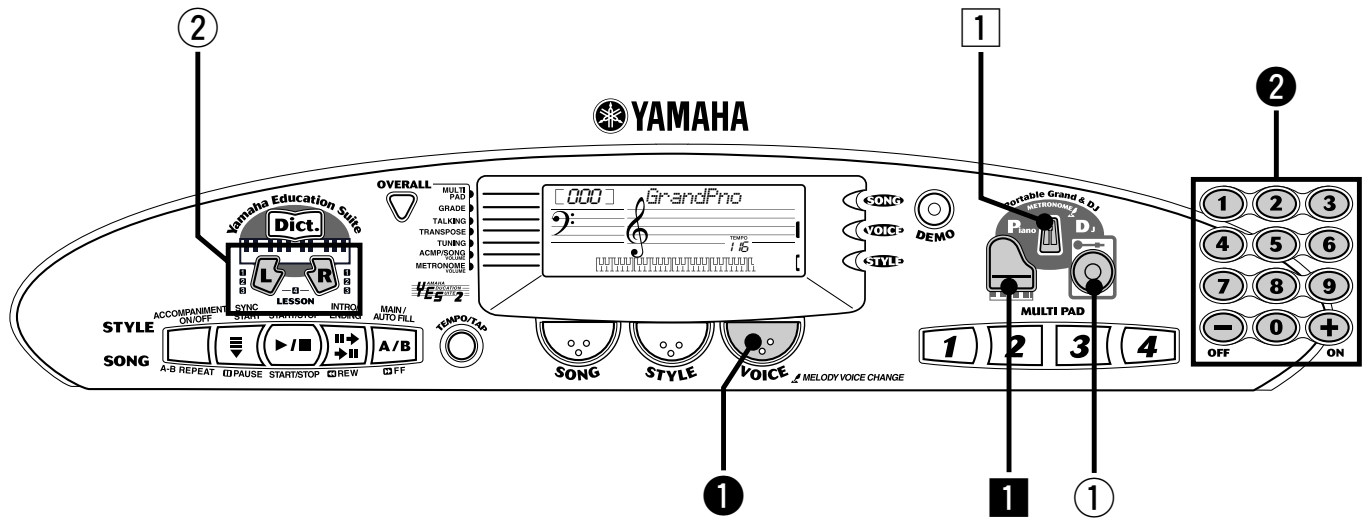

Playing the Piano

Simply by pressing the [Piano] button, you can automatically reset the entire PSR-160 for piano play.

1 Press the [Piano] button.

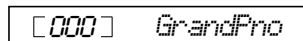

2 Play the keyboard.

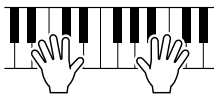

Want to find out more? See page 20.

Playing along with the Metronome

1 Press the [METRONOME] button.



Want to find out more? See page 21.

● Panel Voice List

No.	Voice Name	No.	Voice Name	No.	Voice Name	No.	Voice Name	No.	Voice Name
PIANO									
001	GRAND PIANO	011	VIBRATO ON	022	FOLK GUITAR	033	HARP	044	ALTO SAX
002	HONKY-TONK	012	HARMONY OFF	023	12ST GUITAR	034	SITAR	045	TENOR SAX
003	E PIANO 1	013	HARMONY ON	024	JAZZ GUITAR	035	BANJO	046	OBOE
004	E PIANO 2	014	ATTACK OFF	025	E GUITAR	036	VIBRAPHONE	047	CLARINET
005	E PIANO 3	015	ATTACK ON	026	DIST GUITAR	037	MARIMBA	048	FLUTE
006	E PIANO 4	016	WAVE OFF	027	WOOD BASS	038	STEEL DRUMS	049	PAN FLUTE
007	HARPSICHORD	017	WAVE ON	028	FINGER BASS	WIND			
008	CLAVI	018	PIPE ORGAN	029	SLAP BASS	039	TRUMPET	SYNTHESIZER	
009	CELESTA	019	ACCORDION	STRINGS/MALLET		040	TROMBONE	050	THICK LEAD
ORGAN		020	HARMONICA	030	STRINGS	041	MUTE TRPET	051	SIMPLE LEAD
GUITAR/BASS		GUITAR/BASS		031	VIOLIN	042	FRENCH HORN	052	THICK SAW
010	VIBRATO OFF	021	SOFT GUITAR	032	CELLO	043	BRASS SECT	053	SIMPLE SAW
								054	SYNTH BASS

Selecting and Playing Other Voices

The PSR-160 has a total of 100 dynamic and realistic instrument voices. Let's try a few of them out now...

1 Press the [VOICE] button.

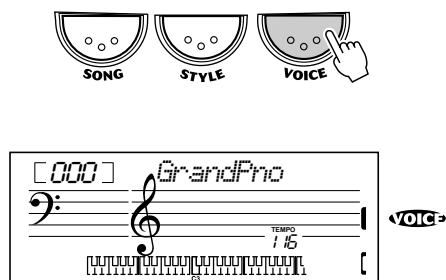

2 Select a voice.

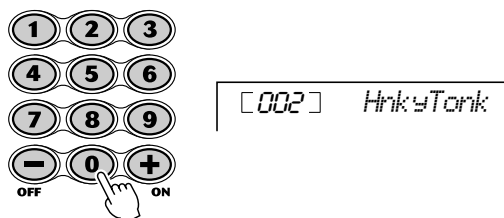

3 Play the keyboard.



Want to find out more? See page 23.

Playing with the DJ Feature

The exciting new DJ feature gives you a full variety of dance and DJ sounds — letting you create your own real-time mixes and groove along with various contemporary rhythms.

1 Press the [DJ] button.

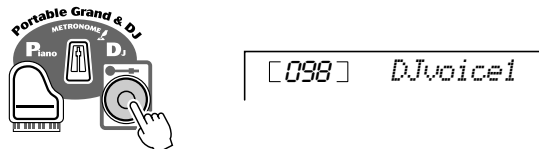

2 Press the Lesson [L] or [R] button.



3 Play the DJ GAME voice.

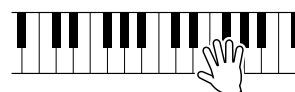

Want to find out more? See page 22.

No.	Voice Name
055	SY STRINGS
056	SY BRASS
057	SLOW STRS
058	CHORUS
HARMONY	
059	PIANO TRIO
060	PNO COUNTRY
061	E PNO TRIO
062	HARPSI TRIO
063	E ORG TRIO
064	VIBES DUET
065	TRP DUET

No.	Voice Name
066	HORN DUET
067	CLARINET TR
068	FLUTE DUET
SPLIT	
069	WD BASS/PNO
070	STRINGS/PNO
071	FN BA/E PNO
072	HARP/VIOLIN
073	HORN/TRP
SUSTAIN	
074	SUS PIANO
075	SUS E PNO1

No.	Voice Name
076	SUS E PNO2
077	SUS VIBRAPHONE
078	SUS STRINGS
ECHO	
079	PIANO
080	E PIANO
081	HARPSICHORD
082	CELESTA
083	FOLK GUITAR
084	BANJO
085	VIBRAPHONE
086	MARIMBA

No.	Voice Name
087	STEEL DRUMS
088	DRUM KIT
DUAL	
089	PNO CONCE
090	E PNO CONCE
091	FAIRY LAND
092	MOOD GUITAR
093	RICH GUITAR
094	HOT ORGAN
095	EXCEL VIOLIN
096	CRYSTAL
097	STAR SHIP

No.	Voice Name
DJ Voice	
098	DJ VOICE 1
099	DJ VOICE 2
DRUMS	
100	DRUM KIT

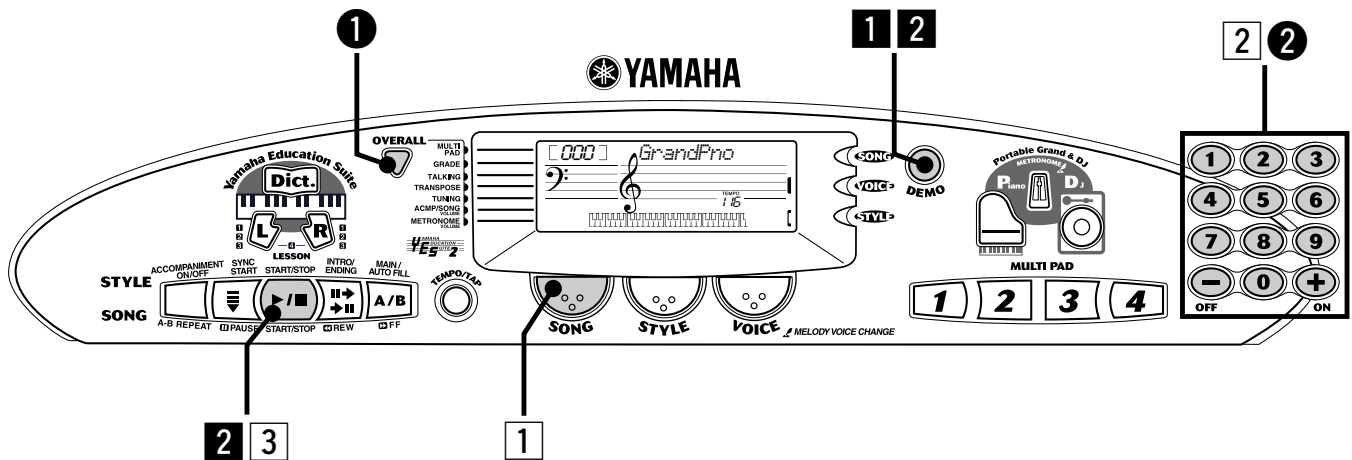

Playing the Songs

The PSR-160 is packed with 100 songs, including 5 special Demo songs.

Playing the Demo songs

Demo songs (001 - 005) showcase the sophisticated features and stunning sound of the PSR-160. Let's play the Demo songs now, starting with 001...

- 1 Press the [DEMO] button.



[001] Livin'La

- 2 Stop the Demo song.



OR

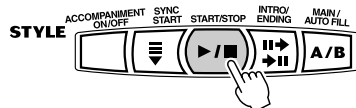

Playing a single song

Naturally, you can also individually select and play back any of the PSR-160's songs (001 - 100).

- 1 Press the [SONG] button.



[001] Livin'La [SONG]

- 2 Select a song.

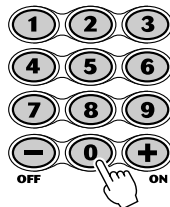

[002] Virtual

- 3 Start (and stop) the song.



Want to find out more? See page 29.

Changing the volume of the song

This lets you adjust the volume balance between the song and your keyboard performance.

- 1 Press the [OVERALL] button, until **ACMP/SONG VOLUME** is indicated by the dark arrow in the display.

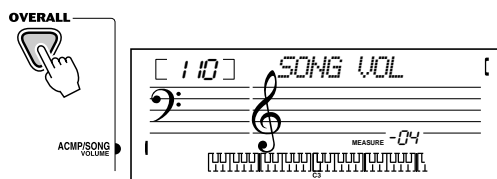

- 2 Use the [+]/[-] buttons to adjust the song volume. You can also use the numeric keypad to directly enter the value.

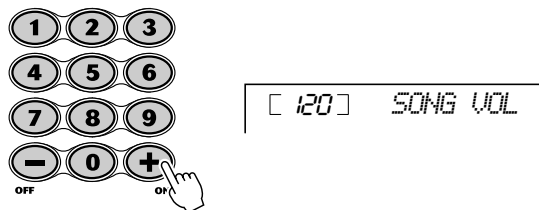

Want to find out more? See page 32.

● Song List

No.	Song Name	No.	Song Name
Demo			
001	Livin' La Vida Loca	049	Auld Lang Syne
002	Virtual Insanity	050	Carry Me Back To Old Virginny
003	I Just Called To Say I Love You	051	The Yellow Rose Of Texas
004	Dancing (original)	052	Long, Long Ago
005	Top Of The World	053	London Bridge
Piano/Classic			
006	Für Elise	054	Old Folks At Home
007	Menuett	055	O Du Lieber Augustin
008	Turkish March	056	My Darling Clementine
009	Marcia Alla Turca	057	Hamabe No Uta
010	Valse op.64-1 "Petit chien"	058	Furusato
011	Etude op.10-3 "Chanson De L'adieu"	059	Oh! Susanna
012	Jesu, Joy Of Man's Desiring	060	Jeanie With The Light Brown Hair
013	Symphonie Nr.9	061	I've Been Working On The Railroad
014	Gavotte	062	Loch Lomond
015	Fröhlicher Landmann	063	My Bonnie
016	Polonaise	064	Yankee Doodle
017	Canon	065	Turkey In The Straw
018	Heidenröslein	066	Annie Laurie
019	Träumerei	067	Close Your Hands, Open Your Hands
020	From The New World	068	Muss I Denn
021	Frühlingslied	069	The Cuckoo
022	Menuett	070	Battle Hymn Of The Republic
023	Liebesträume Nr.3	071	Camptown Races
024	Blumenlied	072	Romance De L'amour
025	Valse Des Fleurs (From "The Nutcracker")	073	American Patrol
026	Air On The G String	074	Little Brown Jug
027	Die Forelle	075	The Entertainer
028	Marche (From "The Nutcracker")	Christmas	
029	Humoreske	076	Jingle Bells
030	Pizzicato Polka	077	Silent Night
031	Ave Maria	078	Joy To The World
032	Ave Maria	079	O Christmas Tree
033	Wiegenlied	080	Deck The Halls
034	Wiegenlied	DJ Game	
035	Wiegenlied	081	Euro Techno
World			
036	Twinkle Twinkle Little Star	082	Flares
037	Grandfather's Clock	083	Grind
038	Beautiful Dreamer	084	Acid House
039	Greensleeves	085	Pop Reggae
040	Believe Me, If All Those Endearing Young Charms	086	Ragga
041	I'm Mai	087	Shakin'
042	Home Sweet Home	088	Digital Rock
043	Amazing Grace	089	SupaBad
044	Aura Lee	090	Ambient
045	My Old Kentucky Home	091	Acid Techno
046	Aloha Oe	092	Souful
047	Die Lorelei	093	Drums & Bass 1
048	Londonderry Air	094	Drums & Bass 2
		095	Hard Step 8th
		096	Funky Trip Hop
		097	Hype
		098	Beatbox
		099	Funked Up
		100	All That

Step 3 Auto Accompaniment

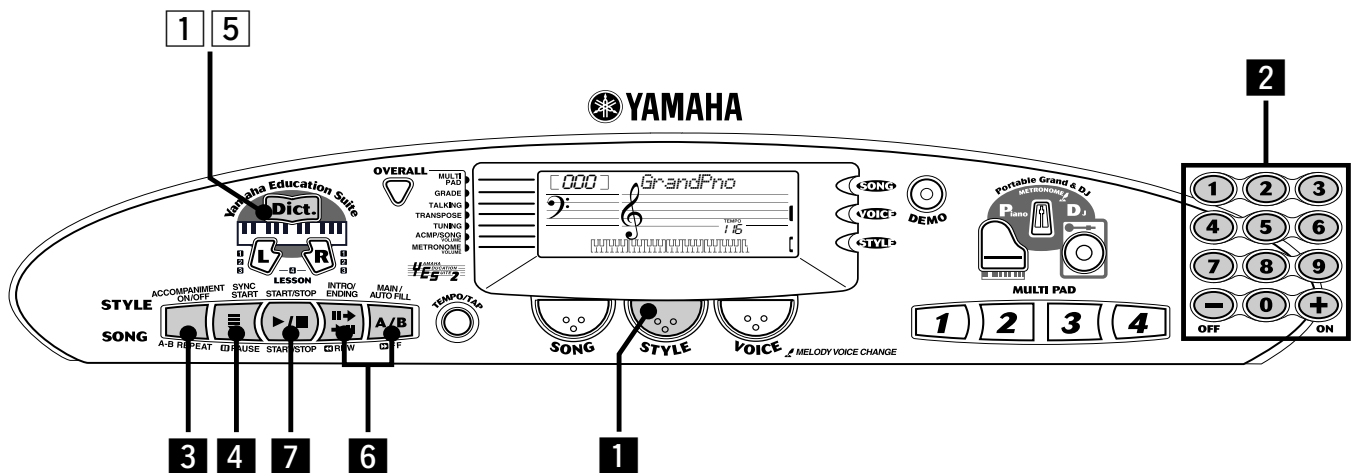

Using the Auto Accompaniment

The powerful yet easy-to-use Auto Accompaniment features give you professional instrumental backing for your performances. Simply play chords with your left hand — and the PSR-160 automatically produces appropriate bass, chord and rhythm backing. Use your right hand to play melodies, and you'll sound like an entire band!

NOTE

- For more information on playing proper chords for the auto accompaniment, see "Using Auto Accompaniment — Multi Fingering" on page 48 and "Looking up Chords in the Dictionary" on page 41.

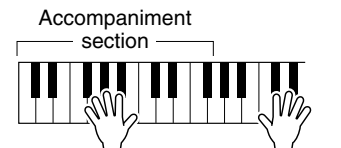

Left hand + Right hand
Auto accompaniment + **Melody**
 (for example, bass + guitar + drums)

1 Press the [STYLE] button.

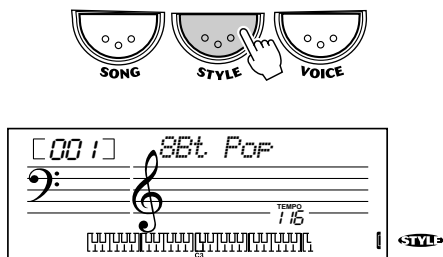

2 Select a style.

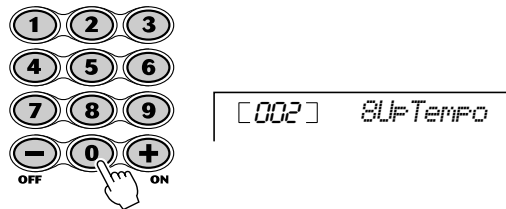

3 Turn the auto accompaniment on.

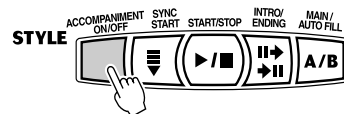

Looking up Chords in the Dictionary

The convenient Dictionary function teaches you how to play chords by showing you the individual notes. In the example below, we'll learn how to play a GM7 chord...

Keys for entering the chord type (C3 — B4) Keys for entering the chord root (C5 — B5)

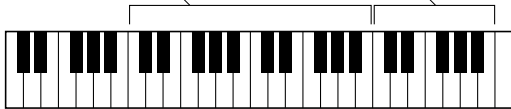

Learning how to play a specific chord

Example: **G M7**
Root note Chord type

1 Press the [Dict.] button.

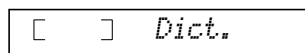

2 Specify the root note of the chord (in this case, G).

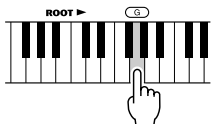

3 Specify the chord type of the chord (in this case, M7).

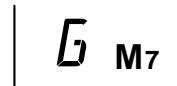
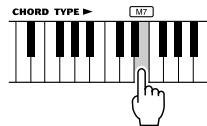

4 Play the notes of the chord as indicated in the keyboard diagram in the display. The chord name flashes when the chord is played properly.

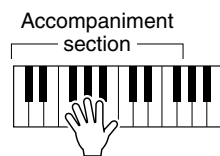
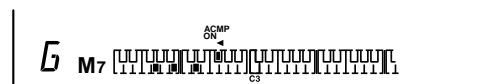

5 To leave the Dictionary function, press the [Dict.] button again.



Want to find out more? See page 41.

4 Turn the Sync Start function on.

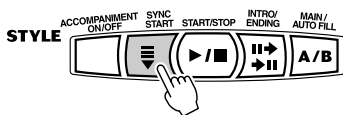

5 Play a chord with your left hand.

The auto accompaniment starts as soon as you play the keyboard. For more on chords, see "Looking up Chords in the Dictionary" above.

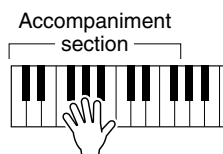

6 Select a section.

The auto accompaniment has four sections: Intro, Main A/B, and Ending.

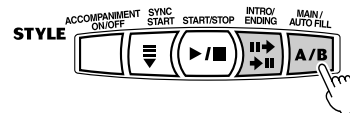

7 Stop the auto accompaniment.

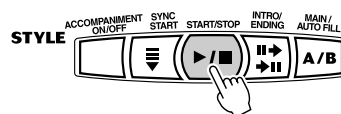

Want to find out more? See page 43.

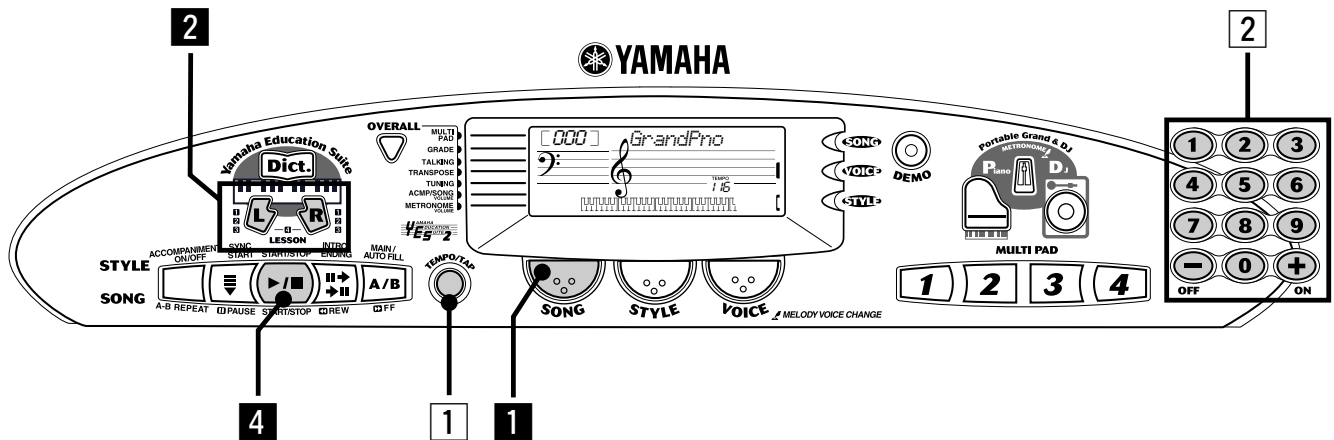

Using the Lesson Feature

All of the PSR-160's songs can be used with the educational Lesson feature. Lesson makes it fun and easy to master these songs. You can practice the left- and right-hand parts of each song individually: simply press the appropriate button, [L] (left) or [R] (right). The practice steps below apply to either hand.

- Lesson 1 — Timing** This lesson step lets you practice just the timing of the notes.
- Lesson 2 — Waiting** In this lesson step, the PSR-160 waits for you to play the correct notes before continuing playback of the song.
- Lesson 3 — Minus One** This lesson step plays back the song with one part muted — letting you play and master the missing part yourself.
- Lesson 4 — Both Hands** This lesson step is the same as “Minus One,” except in that both the left- and right-hand parts are muted — letting you play and master both hands.

1 Select one of the Lesson songs.
For instructions on selecting songs, see page 29.



2 Select the part you wish to work on (left or right) and the Lesson step.
If you want to work on the right-hand part, press the [R] button; to work on the left, press the [L] button.

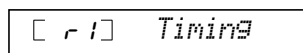

NOTE

- Each press of the corresponding button ([L] or [R]) alternately selects Lessons 1 - 3. Pressing both buttons simultaneously calls up Lesson 4, Both Hands.

3 Start the Lesson.

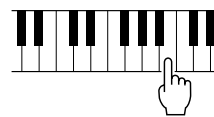

4 When you're finished, stop the Lesson.

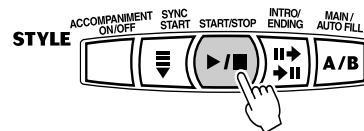

NOTE

- You can also exit from the Lesson by pressing one of the LESSON buttons ([L] or [R]) repeatedly until “OFF” is shown in the display.

Lesson 1 — Timing

This step lets you work on the timing of the notes. In Lesson 1, the particular note you play on the keyboard is unimportant. The PSR-160 checks your timing and how rhythmically “tight” your playing is.

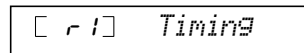
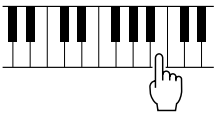

Want to find out more? See page 36.

Lesson 2 — Waiting

In Lesson 2, you practice playing the notes correctly as they appear in the display notation. The accompaniment pauses and waits for you to play the notes correctly before it continues.

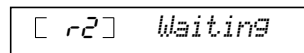
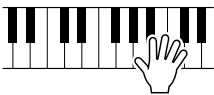

Want to find out more? See page 37.

Lesson 3 — Minus One

In Lesson 3, one of the parts is muted, and you practice the missing part in time with the rhythm.

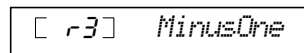
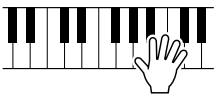

Want to find out more? See page 37.

Lesson 4 — Both Hands

Lesson 4 is just like Lesson 3, except that the parts for both hands are muted, letting you practice the missing parts in time with the rhythm.

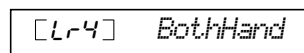
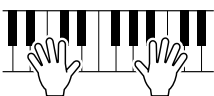

Want to find out more? See page 38.

Grade

The PSR-160 has a built-in evaluation function that monitors your practicing and — like a real teacher — tells you how well you did each exercise. Four grades are assigned, depending on your performance: “OK,” “Good,” “Very Good,” and “Excellent.”

Want to find out more? See page 39.

Talking

This feature “talks” to you through the speakers, “announcing” the Grade comments as well as the titles of the Lesson steps.

Want to find out more? See page 40.

Changing the Tempo

Naturally, you can change the tempo (speed) of the song to your liking, letting you slow down difficult passages and bring up the tempo gradually until you master them at normal speed.

- 1 Press the [TEMPO/TAP] button.

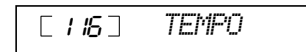

- 2 Use the numeric keypad to set the desired tempo.

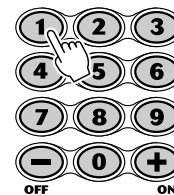

NOTE

- The PSR-160 also has a convenient Tap Tempo function that allows you to “tap” a new tempo in real time. (See page 44.)



Getting Started — Playing the Demo Songs

The PSR-160 has a variety of Demo songs, specially recorded to showcase the dynamic sounds and rhythms and give you an idea of what you can do with the instrument.

1 First, turn on the power.

Press the [STANDBY/ON] button.



2 Set the Volume.

Initially, turn the [MASTER VOLUME] control about a third of the way up. You can adjust the control for optimum level once the songs start playing.

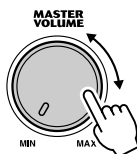

3 Press the [DEMO] button.

All five songs will play back in sequence. You can play along on the keyboard with the songs.



The current song name and number appear at the left of the display. Notice also that the display indicates both the chords and the melody notes (in the music staves and the keyboard diagram) as they change during the song.

To stop playback, press the [START/STOP] button.

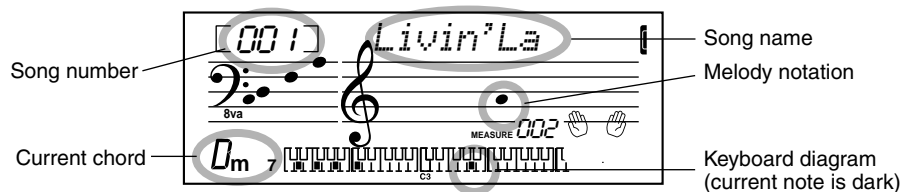

NOTE

• The PSR-160 has a Demo Cancel function that allows you to disable the Demo feature. To use this, simultaneously hold down the [DEMO] button and turn the power on ([STANDBY/ON] button). While the power is on in this condition, pressing the [DEMO] button has no effect. To turn Demo Cancel off, simply turn the power off and back on again normally.

While the Demo song is playing...

Many features of the PSR-160 can be used while the Demo songs are playing. These include:

- Tempo (page 31)
- Song volume (page 32)
- Tuning (page 27)
- Pause, Rewind, Fast Forward (page 32)



Panel Display Indications

The PSR-160 features a large multi-function display that shows all important settings for the instrument. The section below briefly explains the various icons and indications in the display.

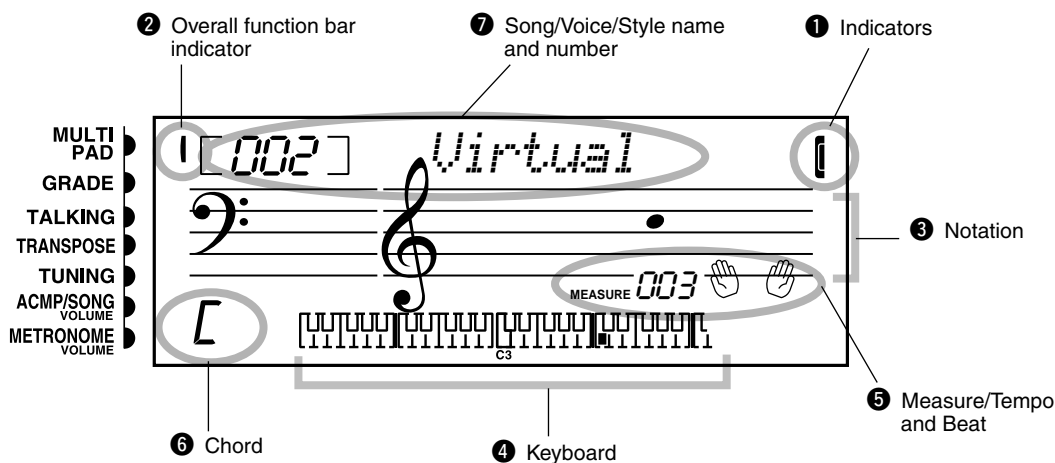

1 Indicator

These bars indicate the operating condition of the PSR-160, as shown below:

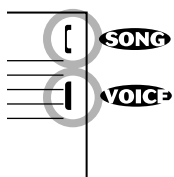

Using the numeric keypad selects **voice** numbers. Pressing the [START/STOP] button starts **song** playback.

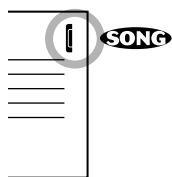

Using the numeric keypad selects **song** numbers. Pressing the [START/STOP] button starts **song** playback.

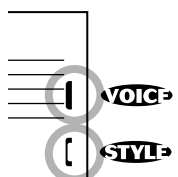

Using the numeric keypad selects **voice** numbers. Pressing the [START/STOP] button starts **style** playback.

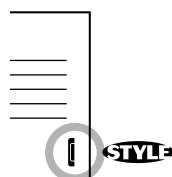

Using the numeric keypad selects **style** numbers. Pressing the [START/STOP] button starts **style** playback.

2 Overall function bar indicator

The PSR-160 has seven Overall functions or controls. The currently selected function is indicated by a dark bar that appears next to its name (printed on the panel).

3 Notation / 4 Keyboard

These two portions of the display conveniently indicate notes currently played on the keyboard. When a song is being played back, they show the single notes of the melody in succession. When the Style mode

and auto accompaniment are active, the display also shows the specific notes of the current chord.

The indication “8va” appears at the lower or upper part of the notation staff for a note or notes that are respectively an octave lower or higher than notated.

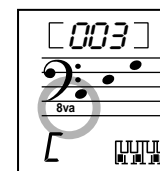

NOTE

- For a few specific chords (such as BM7), not all notes may be shown in the notation section of the display. This is due to space limitations in the display.

5 Measure/Tempo and beat

This shows either the current measure (when the Song mode is selected) or the current Tempo value (when the Style mode is selected). The hand clap icons also flash to indicate the beats in the measure during song or style playback. (See page 31.)

6 Chord

When a song is being played back, this indicates the current chord root and type. It also indicates chords played in the ACMP section of the keyboard when the Style mode and auto accompaniment are on.

7 Song/Voice/Style name and number

This portion of the display indicates the name and number of the currently selected song, voice, or style. When other functions of the PSR-160 are selected, it briefly shows the function name and current value or setting.



Portable Grand

This convenient function lets you instantly call up the Grand Piano voice.

Playing the Portable Grand

Press the piano-shaped [Piano] button.



Doing this automatically cancels any other mode or function, and resets the entire instrument for playing the special “Stereo Sampled Piano” Grand Piano voice. It automatically selects the Song mode, calling up song #006, “Für Elise” — which can be played instantly by pressing the [START/STOP] button.

NOTE

- When the [Piano] button is pressed, One Touch Setting (page 26) is automatically turned on, and special Multi Pad sounds for piano are automatically called up as well. (For more on Multi Pads, see page 51.)

The Portable grand setting is designed also for playing with the special Pianist styles (#081 - #100). When auto accompaniment is turned on, these provide piano-only accompaniment in a variety of music styles.

Using the Metronome

- 1 Call up the Tempo setting.**
Press the [TEMPO/TAP] button.

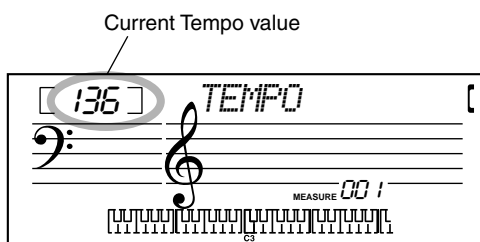

- 2 Change the value.**

Use the numeric keypad to set the desired Tempo value, or use the [+]/[-] buttons to increase or decrease the value.

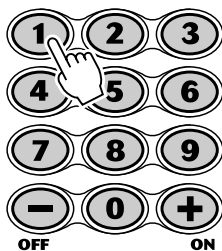

3 Turn on the Metronome.

Press the [METRONOME] button.

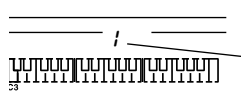

Indicates the beat number in the tempo/measure.

To turn the Metronome off, press the [METRONOME] button again.

Setting the Metronome Time Signature

The time signature of the Metronome can be set to various quarter-note based meters.



- The time signature changes automatically when a style or song is selected.

Hold down the [METRONOME] button (until "TIME SIG" appears in the display), then press the button on the numeric keypad that corresponds to the desired time signature (see chart at right).

Number. button	Time signature
1	1/4 — Plays only "1" beats (all high clicks)
2	2/4
3	3/4
4	4/4
5	5/4
6	6/4
7	7/4
8	8/4
9	9/4
0	Plays no "1" beats (all low clicks)

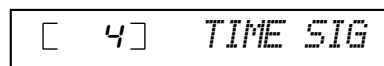

Adjusting the Metronome Volume

You can adjust the volume of the Metronome sound independently of the other PSR-160 sounds. The volume range is 000 - 127.

1 Select the Metronome Volume function in the Overall menu.

Press the [OVERALL] button, repeatedly if necessary, until "MTR VOL" appears in the display.

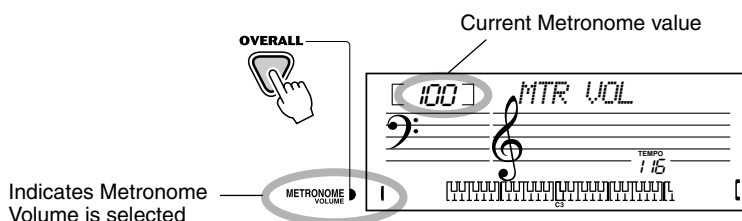

2 Change the value.

Use the numeric keypad to set the desired Metronome Volume value, or use the [+]/[-] buttons to increase or decrease the value.

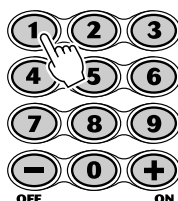

Restoring the Default Metronome Volume Value

To restore the default Metronome Volume value of "100," press both [+]/[-] buttons simultaneously (when Metronome Volume is selected).



DJ

This exciting feature lets you instantly call up a dynamic DJ voice, style and DJ GAME for playing contemporary dance music.

Playing the DJ

1 Press the [DJ] button.

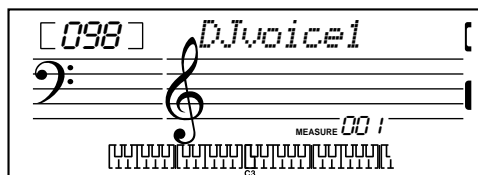
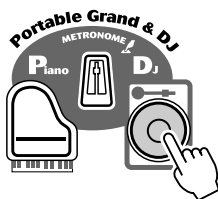

Doing this automatically resets the entire instrument for playing the specially programmed DJ song and voice.

2 Turn on the Lesson feature, and select a Lesson step.

Lesson steps 1 - 3 can be used with DJ play. Press either the [L] or [R] button, repeatedly if necessary, until the desired Lesson step is called up.

The DJ voice is divided into “blocks” (as shown below). Each block has a different sound.

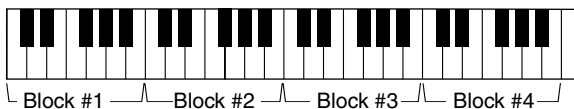

For Lesson 1, any note on the keyboard can be played. For the other Lesson steps, play the appropriate octave block.

Once the song starts playing and the DJ “teacher” says “Go,” play the appropriate block as indicated in the display. (When Talking is on, the blocks are also “announced” in Lesson 2.)



When the DJ “teacher” is playing, the block numbers appear in the display one after another according to the rhythm.

3 Press the [START/STOP] button to stop the song.

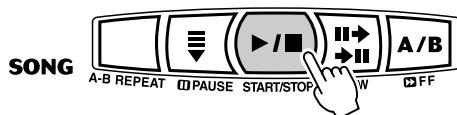

NOTE

- If two sixteenth notes are to be played, the appropriate block numbers appear successively at the same position. If the same block is to be played twice as sixteenth notes, an equal sign appears after the block number (as shown below).

3 → 1
Indicates that the third block and first block are to be played as successive sixteenth notes.

3 → =
Indicates that the third block is to be played as two sixteenth notes.

NOTE

- Since there are no left or right parts in the DJ song, the [L] and [R] buttons can be used interchangeably. Also for the same reason, Lesson 3 and Lesson 4 are identical.

NOTE

- In the DJ Lesson, you can play the Multi Pads as well as the keyboard.

HINT

- Try playing one of the special DJ voices (#098, #099) with the DJ song. (See page 24.)



Selecting and Playing Voices

The PSR-160 features 100 authentic voices that have been created with Yamaha's sophisticated AWM (Advanced Wave Memory) tone generation system. Many of these voices also have special preset characteristics or embellishments. The voices are divided into various categories depending on their characteristics or the effects used.

Selecting and Playing a Voice

1 Press the [VOICE] button.

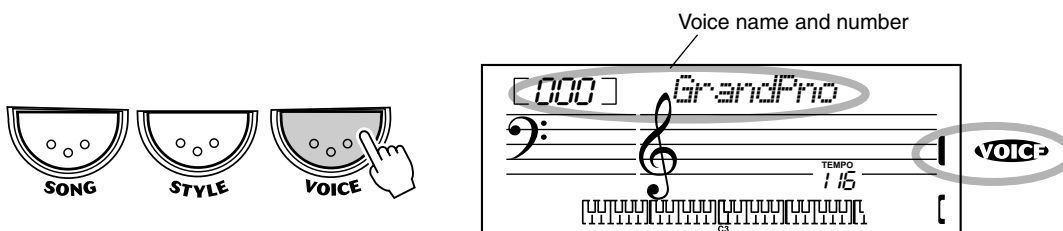

2 Select the desired voice number.

Use the numeric keypad. The basic categories of voices and their numbers are shown on the panel.

VOICE

PIANO
001 GRAND PIANO
002 HONKY-TONK
003~006 E PIANO 1~4
007 HARPSICHORD
008 CLAVI
009 CELESTA

ORGAN
010~011 VIBRATO OFF/ON
012~013 HARMONY OFF/ON
014~015 ATTACK OFF/ON
016~017 WAVE OFF/ON
018 PIPE ORGAN
019 ACCORDION
020 HARMONICA

GUITAR/BASS
021 SOFT GUITAR
022 FOLK GUITAR
023 12ST GUITAR
024 JAZZ GUITAR
025 E GUITAR
026 DIST GUITAR
027 WOOD BASS
028 FINGER BASS
029 SLAP BASS
STRINGS
030 STR
031 VIOL
032 CEL
033 HAR
034 SITA
035 BAN
036 VIBR
037 MAF
038 STEI

There are two ways to select voices: 1) directly entering the voice number with the numeric keypad, or 2) using the [+]/[-] buttons to step up and down through the voices.

Selecting and Playing Voices

■ Using the numeric keypad

Enter the digits of the voice number as printed on the panel. For example, to select voice #042, press “0” on the numeric keypad, then “4.”, “2.” For voice numbers beginning with zeroes (such as #042 or #006), the initial zeroes may be omitted.

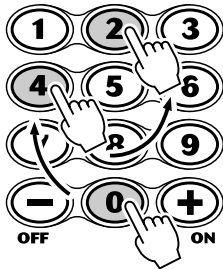

■ Using the [+]/[-] buttons

Press the [+] button to select the next voice number, and press the [-] button to select the previous voice. Holding down either key continuously scrolls up or down through the numbers.

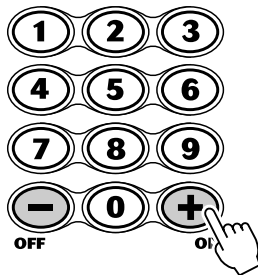

3 Play the selected voice.

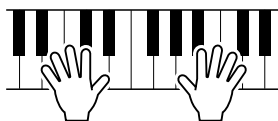

NOTE

- Each voice is automatically called up with the most suitable octave range setting. Thus, playing middle C with one voice may sound higher or lower than another voice at the same key.

NOTE

- Four of the Organ voices are effect “pairs.” Switching between each of the paired voices (with the [+]/[-] buttons) turns the effect of the voice on or off. For example, for the Vibrato pair (#010 and #011), selecting #010 turns the vibrato effect off, while selecting #011 turns vibrato on. The same applies to the Harmony, Attack and Wave voices (#012 - #017).

ORGAN
010-011 VIBRATO OFF/ON
012-013 HARMONY OFF/ON
014-015 ATTACK OFF/ON
016-017 WAVE OFF/ON

NOTE

- The PSR-160 is polyphonic up to a maximum of 16 notes. (Depending on the voice selected — such as split voices and dual voices — fewer notes may be available.) This includes not only the notes played from the keyboard, but also the notes in a style pattern, the notes played by a Pad (page 51), and so on. Thus, if you play too many notes at one time, some may not sound and/or others may be cancelled.

Harmony voices (#059 - #068) automatically add a one-, two- or three-note harmony to the original voice. **Split voices** (#069 - #073) feature two separate voices, each playable from opposite sections of the keyboard — the lower voice playable up to B2 and the upper voice from C3 (middle C). **Sustain voices** (#074 - #078) have a special sustained release for playing slower or legato passages. **Echo voices** (#079 - #088) provide an echo effect that adds delayed repeats to the original voice. **Dual voices** (#089 - #097) blend two voices together for a rich, layered sound.

There's even a dynamic set of **DJ voices** (#098 - #099) that provides a wealth of exciting sounds for playing many of today's popular music styles. The PSR-160 also features special **Drum Kit voices** — #088 (with Echo) and #100 — that let you play a variety of drum and percussion sounds from the keyboard. (Refer to the Drum Kit Voice Chart below.) Icons representing each sound are printed above the keyboard, conveniently indicating which sounds are played from which keys.

NOTE

About the Harmony voices

- Since Harmony voices are designed to automatically play two or more notes with the notes you play on the keyboard, only one note can be played on the keyboard at a time. If several notes are played together, only the last note or highest note played will be used for the harmony effect.

DJ Voice Chart (voices #098 and #099)

• #098

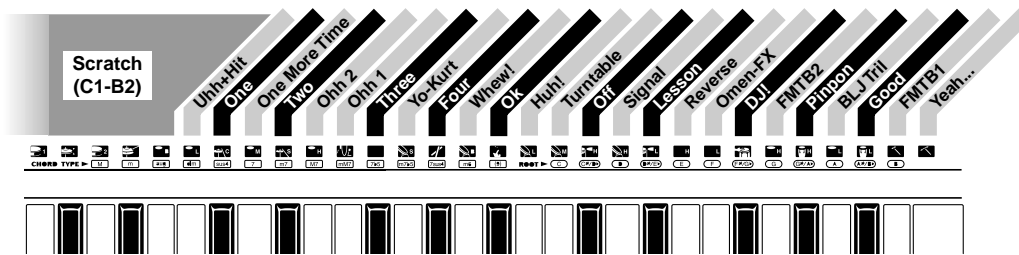

• #099

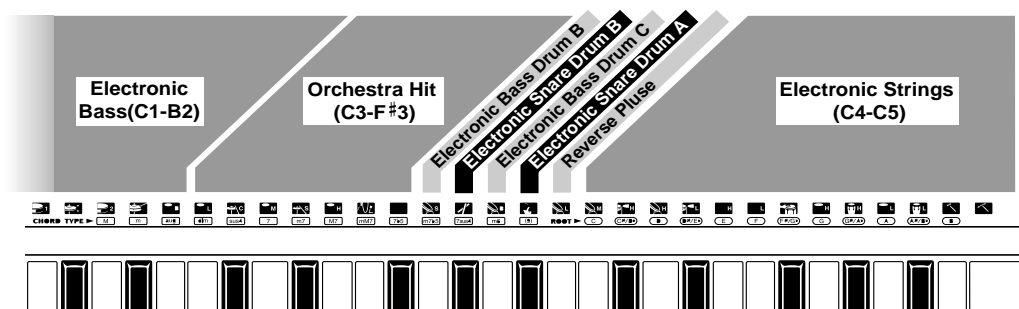

Drum Kit Voice Chart (voices #088 and #100)

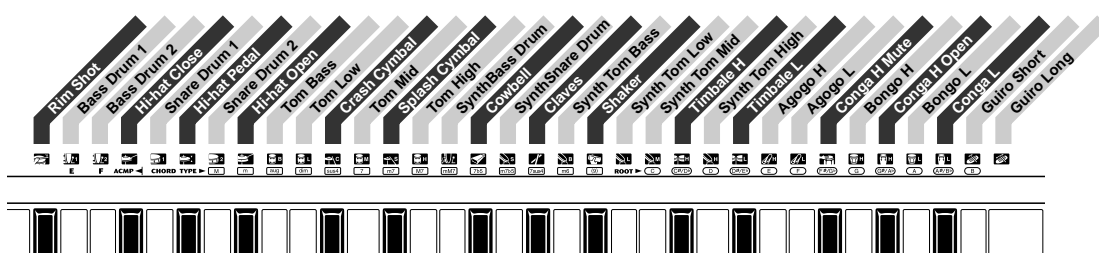

Selecting and Playing Voices

One Touch Setting

The powerful One Touch Setting (OTS) feature lets you instantly and automatically call up an appropriate voice and other settings when you select a style or song. In other words, when One Touch Setting is active, selecting a desired style or song also automatically selects the best suited voice and Multi Pad bank.

1 Press the [VOICE] button.

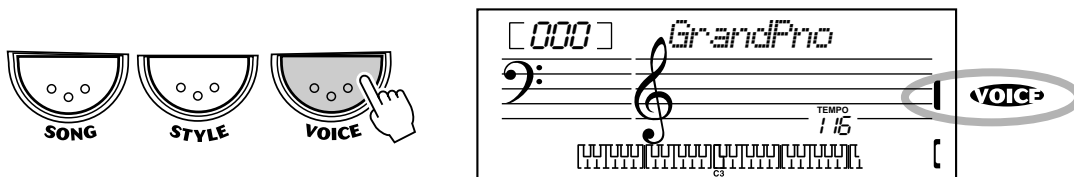

2 Select the One Touch Setting voice (#000).

Use the numeric keypad or [+]/[-] buttons.

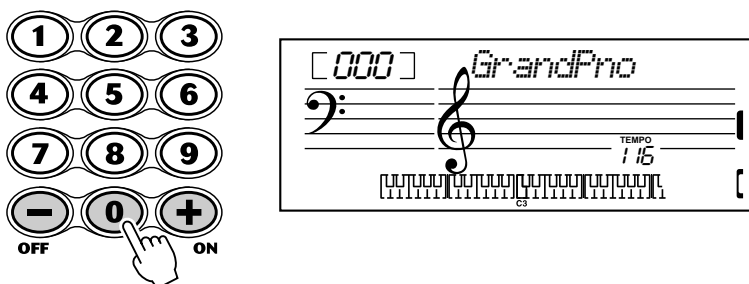

To turn One Touch Setting off, select a voice other than #000.

Transpose and Tuning

You can also adjust the tuning and change the transposition (key) of the PSR-160 with the Transpose and Tuning functions.

■ Transpose

Transpose determines the key of both the main voice and the bass/chord accompaniment of the selected style. It also determines the pitch of the songs and the Multi Pads. This allows you to easily match the pitch of the PSR-160 to other instruments or singers, or play in a different key without changing your fingering. The Transpose settings can be adjusted over a range of ± 12 semitones (± 1 octave).

1 Select the Transpose function in the Overall menu.

Press the [OVERALL] button, repeatedly if necessary, until "TRANSPOS" appears in the display.

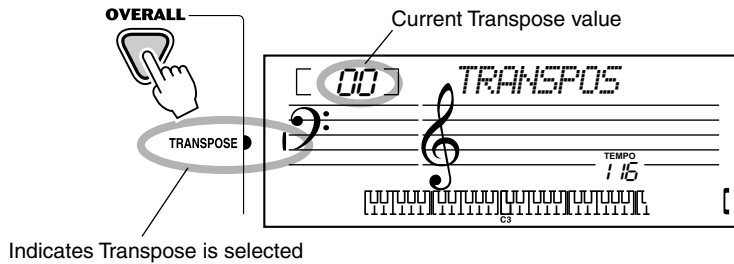

2 Change the value.

Use the numeric keypad to set the desired Transpose value (-12 - +12). To transpose the pitch down, simultaneously press the [-] button and use the numeric keypad to type in the (negative) value. You can also use the [+]/[-] buttons to increase or decrease the value. Holding down either button continuously increases or decreases the value.

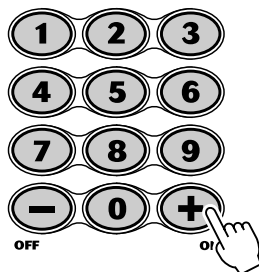

Restoring the Default Transpose Value

If you've changed the Transpose setting, you can instantly restore the default setting of "00" by pressing both [+]/[-] buttons simultaneously (when Transpose is selected).

NOTE

- Transpose has no effect on voices #088 (Echo Drum Kit), #098 and #099 (DJ), or #100 (Drum Kit). Also, this setting cannot be changed during song playback.

Selecting and Playing Voices

■ Tuning

Tuning determines the fine pitch setting of both the main voice and the bass/chord accompaniment of the selected style. It also determines the pitch of the songs and the Multi Pads. This allows you to accurately match the tuning with that of other instruments. The Tuning settings can be adjusted over a range of ± 50 (approx. ± 0.5 semitones).

1 Select the Tuning function in the Overall menu.

Press the [OVERALL] button, repeatedly if necessary, until "TUNING" appears in the display.

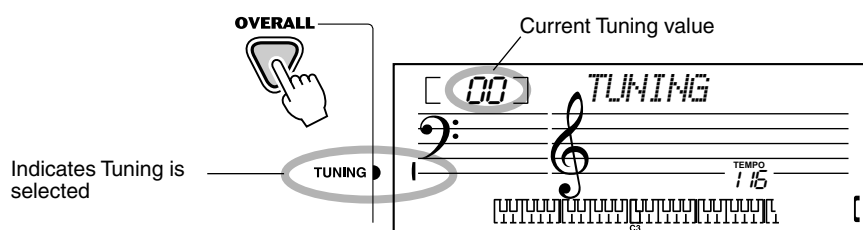

2 Change the value.

Use the numeric keypad to set the desired Tuning value (-50 - +50). To tune the pitch down, simultaneously press the [-] button and use the numeric keypad to type in the (negative) value. You can also use the [+]/[-] buttons to increase or decrease the value. Holding down either button continuously increases or decreases the value.

Restoring the Default Tuning Value

If you've changed the Tuning setting, you can instantly restore the default setting of "00" by pressing both [+]/[-] buttons simultaneously (when Tuning is selected).

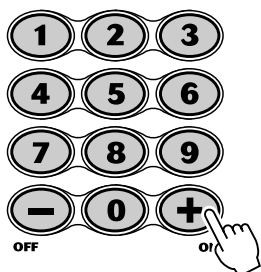



Selecting and Playing Songs

The Song mode features 100 special songs that have been created using the rich and dynamic sounds of the PSR-160.

The songs are generally for your listening enjoyment; however, you can also play along with them on the keyboard. The songs of the PSR-160 can also be used with the powerful Lesson feature (page 34), a convenient tool that makes learning songs fun and easy.

Selecting and Playing a Song

1 Press the [SONG] button.

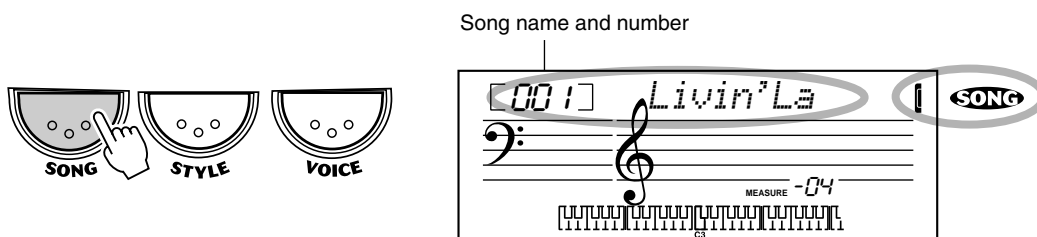

2 Select the desired song number.

Use the numeric keypad. The basic categories of songs and their numbers are shown at the left of the panel.

Song numbers can be selected in the same way as with the voices (see page 24). You can use the numeric keypad to directly enter the song number, or use the [+]/[-] buttons to step up and down through the songs.

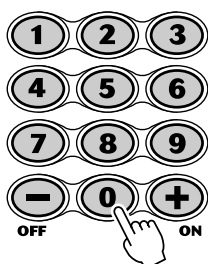

3 Start the selected song.

Press the [START/STOP] button. As the song plays back, the measure number, chords and melody notes are shown in the display.

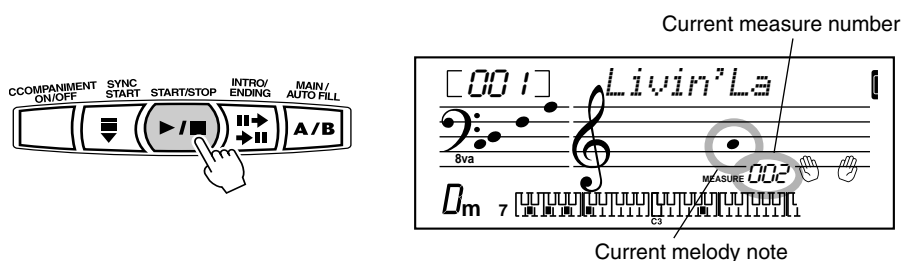

NOTE

- You can play along with the song using the currently selected voice, or even select a different voice for playing along. Simply press the [VOICE] button while the song is playing back and select the desired voice. There's also a Melody Voice Change function (below) that lets you change the song's melody voice to the one currently selected voice.
- The PSR-160 also has a convenient Tap Tempo function that allows you to "tap" a new tempo in real time. (See page 44.)

Selecting and Playing Songs

4 Stop the song.

Press the [START/STOP] button.

Melody Voice Change

The PSR-160 lets you play a melody on the keyboard along with each of the songs, either with the original melody voice or one of your own selection. The convenient Melody Voice Change feature takes this one step further — it lets you replace the original voice used for the melody of the song with the panel voice of your own selection. For example, if the current voice selected on the panel is piano but the song's melody is being played by a flute voice, using Melody Voice Change will change the flute melody voice to piano.

1 Select the desired song.

Press the [SONG] button, then use the numeric keypad or [+]/[-] buttons to select the desired song.

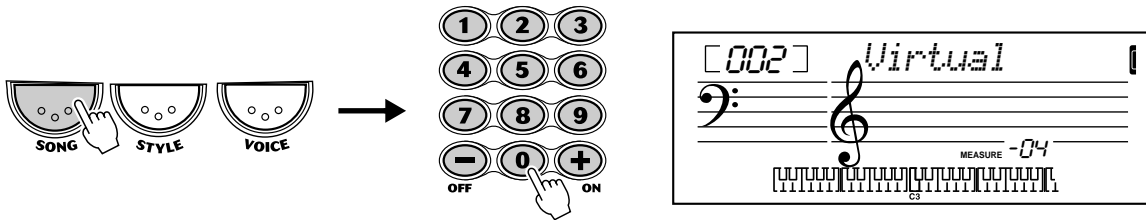

2 Select the desired voice.

Press the [VOICE] button, then use the numeric keypad or [+]/[-] buttons to select the desired voice.

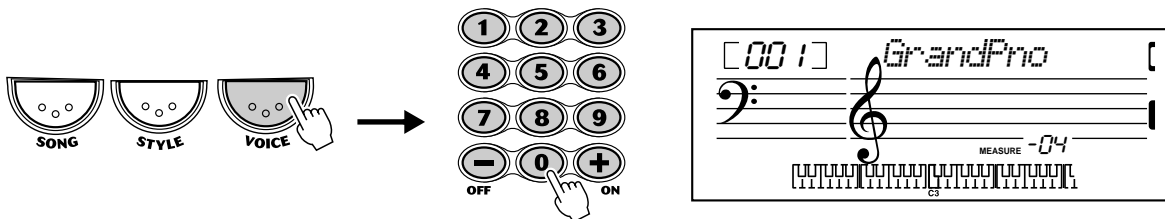

3 Press and hold down the [VOICE] button for at least one second.

“MELODY VOICE CHANGE” appears in the display, indicating that the selected panel voice has replaced the song's original melody voice.

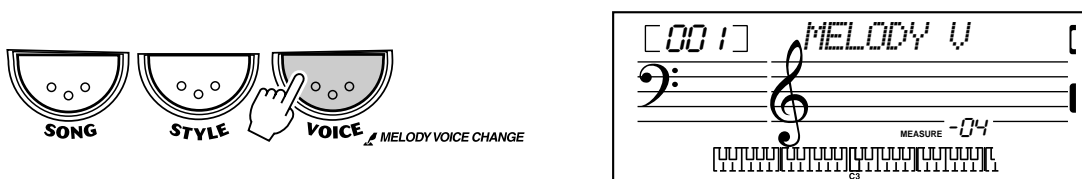

Changing the Tempo

The tempo of song playback can be adjusted over a range of 40 - 240 bpm (beats per minute).

1 Press the [TEMPO/TAP] button.

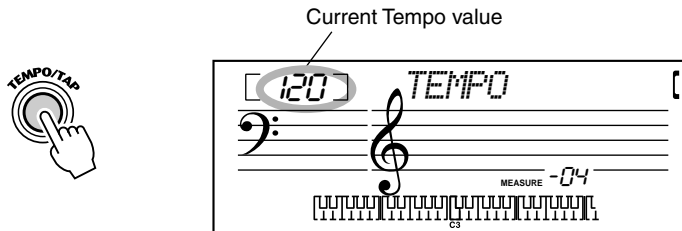

2 Change the value.

Use the numeric keypad to set the desired Tempo value, or use the [+]/[-] buttons to increase or decrease the value.

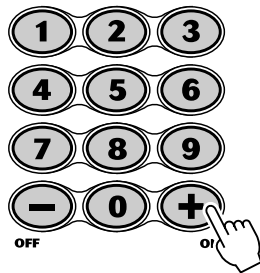

Restoring the Default Tempo Value

Each song and style has been given a default or standard Tempo setting. You can instantly restore this default Tempo setting by pressing both [+]/[-] buttons simultaneously (when Tempo is selected).

Also, the tempo of a song or style returns to the default setting when selecting a different song or style. (The set tempo remains, however, when switching styles during playback except when OTS is on.)

When you turn on the power of the PSR-160, the tempo is automatically set to 116 bpm.

The PSR-160 also has a convenient Tap Tempo function that allows you to “tap” a new tempo in real time. (See page 44.)

About the Beat Display

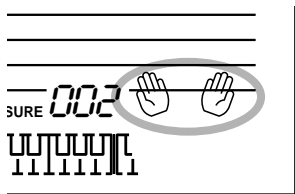

This section of the display provides a convenient, easy-to-understand indication of the rhythm — for song and style playback. The flashing “handclap” icons indicate both the downbeats and upbeats of a measure as follows:

	Indicates the first beat of the measure (downbeat)
	Indicates an upbeat
	Indicates a downbeat (other than the first beat)

Selecting and Playing Songs

Adjusting the Song Volume

The playback volume of the song can be adjusted. This volume control affects only the song volume. The volume range is 000 - 127.

1 Select the Song Volume function in the Overall menu.

Press the [OVERALL] button, repeatedly if necessary, until "SONG VOL" appears in the display.

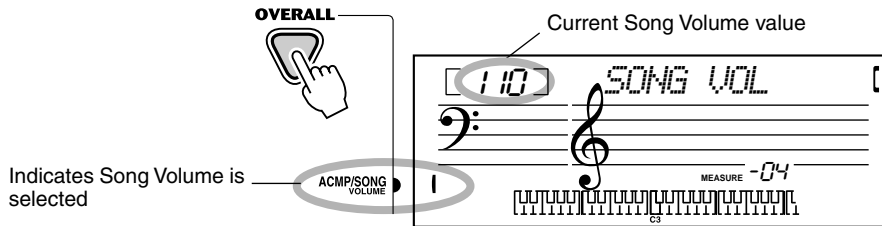

2 Change the value.

Use the numeric keypad to set the desired Song Volume value (000 - 127). You can also use the [+]/[-] buttons to increase or decrease the value. Holding down either button continuously increases or decreases the value.

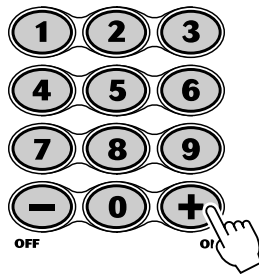

Restoring the Default Song Volume Value

If you've changed the Song Volume setting, you can instantly restore the default setting of "110" by pressing both [+]/[-] buttons simultaneously (when Song Volume is selected).

Song Controls

The panel buttons below the display function as song controls.

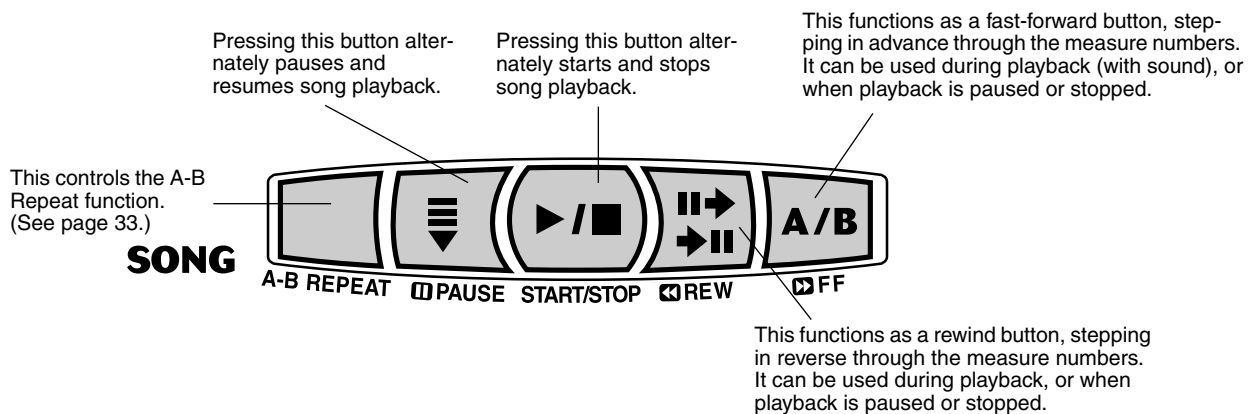

A-B Repeat

This useful function is ideal for practicing and learning purposes. It allows you to specify any phrase of a song (between point A and point B) and repeat it — while you play or practice along with it.

1 While playing back a song, set point A (the start point).

Select and play back the desired song. (See page 29.) Then, while the song is playing back, press the [A-B REPEAT] button once at the start point of the phrase to be repeated.

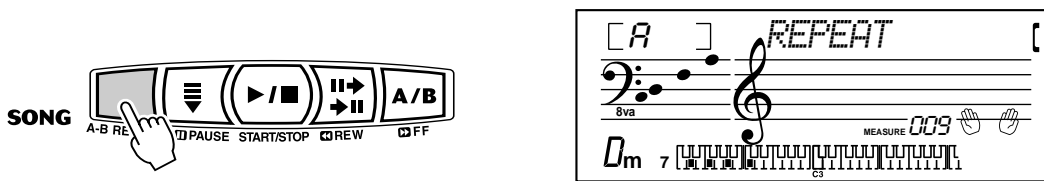

2 Set point B (the end point).

Press the [A-B REPEAT] button once again, at the ending point of the phrase to be repeated. The selected phrase repeats indefinitely until stopped.

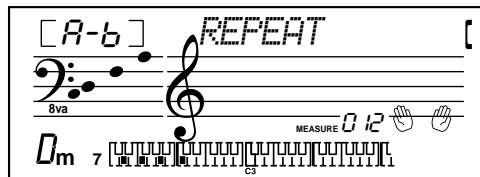

3 Pause or stop playback as needed.

Use the [PAUSE] and [START/STOP] buttons. Stopping playback does not cancel the set A/B points or the A-B Repeat function.

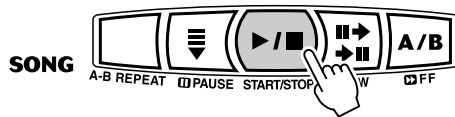

4 Turn off the A-B Repeat function.

Press the [A-B REPEAT] button. This can be done either when the song is stopped or during playback.

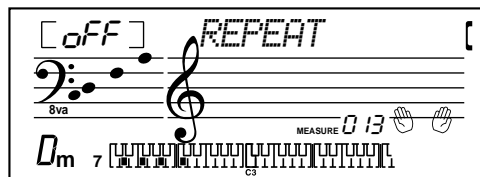

HINT

- You can also set the A-B Repeat function while the song is stopped. Simply use the [REW]/[FF] buttons to select the measures for the A and B points in the song, then start playback.
- While the song is playing back (but before setting the A/B points), try slowing down the Tempo (page 31). This makes it easier to accurately set the A and B points. Slowing down the Tempo also makes it easier to practice the parts you want to learn.
- To set the A point at the beginning of a song, press the [A-B REPEAT] button before starting song playback.

NOTE

- Selecting a different song number (or changing to the Style mode) automatically cancels the A-B Repeat function.



Song Lesson

The Lesson feature provides an exceptionally fun and easy-to-use way to learn how to read music and play the keyboard. All of the 100 songs of the PSR-160 can be used with these educational features. Lesson lets you practice the left- and right-hand parts of each song independently, step by step, until you've mastered them and are ready to practice with both hands together. These practices are divided into four Lesson steps, as described below. Lessons 1 - 3 apply to each hand; press the appropriate button, L (left) or R (right) to select the desired part for practice.

■ Lesson 1 — Timing

This lesson step lets you practice just the timing of the notes — any note can be used, as long as you play in rhythm.

■ Lesson 2 — Waiting

In this lesson step, the PSR-160 waits for you to play the correct notes before continuing playback of the song.

■ Lesson 3 — Minus One

This lesson step plays back the song with one part muted, letting you play and master the missing part yourself — in rhythm and at the proper tempo.

■ Lesson 4 — Both Hands

Lesson 4 is a “Minus One” practice essentially the same as Lesson 3, except that both the left- and right-hand parts are muted — letting you play and master both hands at the same time.

Using the Lesson Feature

1 Select one of the Lesson songs.

Press the [SONG] button, then use the numeric keypad or [+]/[-] buttons to select the desired song (from 001 - 100).

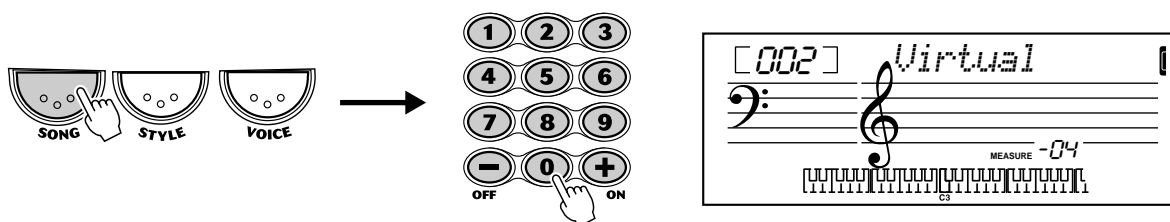

Many of the songs are divided into different categories or music genres, including Piano/Classical, World and Christmas, plus a special set of DJ Game songs.

SONG

- 001 LIVIN' LA VIDA LOCA
- 002 VIRTUAL INSANITY
- 003 I JUST CALLED TO SAY
I LOVE YOU
- 004 DANCING
- 005 TOP OF THE WORLD
- 006~035 PIANO/CLASSICAL
- 036~075 WORLD
- 076~080 CHRISTMAS
- 081~100 DJ GAME

2 Select the part you wish to work on (left or right) and the Lesson step.

If you want to work on the right-hand part, press the [R] button; to work on the left, press the [L] button. Pressing either button repeatedly cycles through the available Lesson steps in order: Lesson 1 → Lesson 2 → Lesson 3 → Off → Lesson 1, etc. The selected Lesson step is indicated in the display.

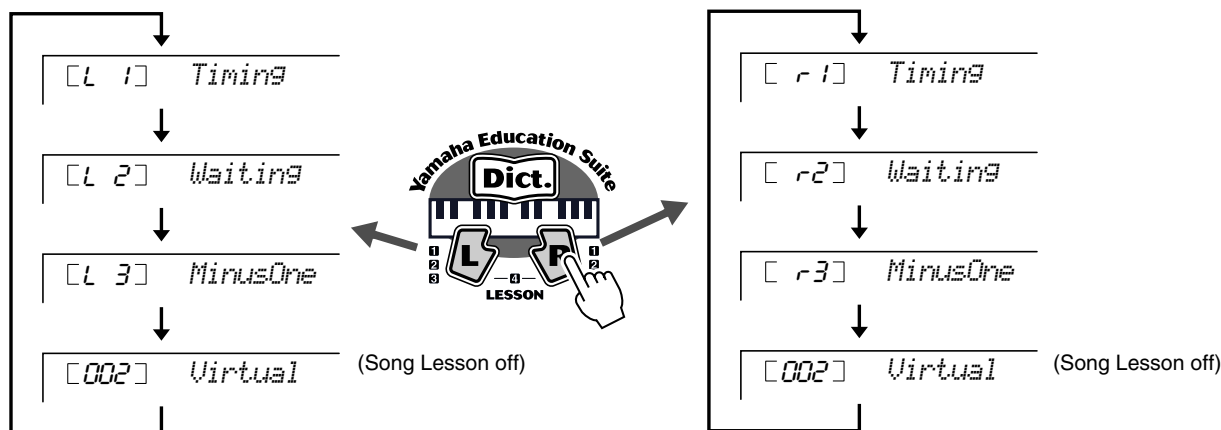

To select Lesson 4, press both [L] and [R] buttons simultaneously.



[Lr4] BothHand

NOTE

- When the Talking function (page 40) is on, the PSR-160 “announces” the current Lesson step.
- When a DJ song is selected, the left (L) and right (R) lessons are identical.

3 Start the Lesson.

The Lesson and song playback start automatically (following a lead-in count) as soon as the Lesson step is selected. When the Lesson is finished, your performance “grade” is shown in the display (if the Grade function is turned on; page 39). After a short pause, the Lesson begins again automatically.

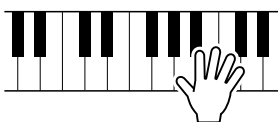

Asterisks appear indicating the timing at which you should play the notes. The line of asterisks represents one full measure. Sixteenth notes are indicated by an alternating asterisk and sharp sign.

* → # Indicates that the timing is to be played as two sixteenth notes.

4 Press the [START/STOP] button to stop the Lesson.

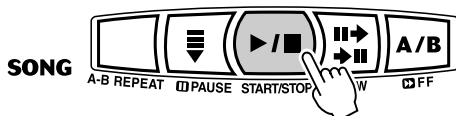

The PSR-160 exits from the Lesson feature automatically when the [START/STOP] button is pressed.

Lesson 1 — Timing

This lesson step lets you practice just the timing of the notes — any note can be used, as long as you play in rhythm. Pick a note to play. For the left hand, use a note in the auto accompaniment section or play the appropriate left-hand note; for the right, play a note above F#2. Simply concentrate on playing each note in time with the rhythmic accompaniment.

NOTE

- The melody note does not sound unless your playing is in time with the rhythm.

1 Select one of the songs.

2 Select Lesson 1.

Press the [L] or [R] button (repeatedly, if necessary) until Lesson 1 is indicated.

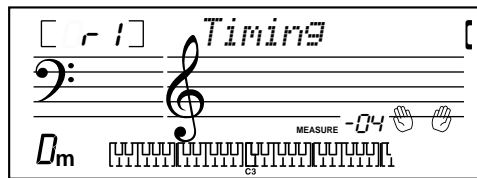

3 Play the appropriate melody or chord with the song.

After the lead-in, the song starts automatically, and the appropriate notes appear in the display. In Lesson 1, simply play one note repeatedly in time with the music.

Regarding chords and the use of the left hand, the PSR-160 actually has two different types of songs: 1) songs with normal left-hand chords, and 2) songs in which the left hand plays arpeggios or melodic figures in combination with the right.

In the case of the first type, play the chords with your left hand in the auto accompaniment section of the keyboard.

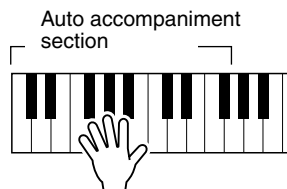

Lesson 2 — Waiting

In this lesson step, the PSR-160 waits for you to play the correct notes before continuing playback of the song. This lets you practice reading the music at your own pace. The notes to be played are shown in the display, one after another, as you play them correctly.

1 Select one of the songs.

2 Select Lesson 2.

Press the [L] or [R] button (repeatedly, if necessary) until Lesson 2 is indicated.

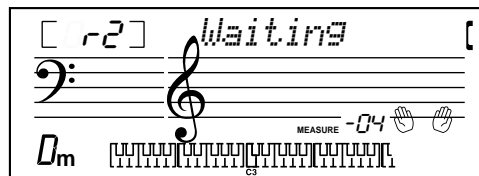

NOTE

- Depending on the selected song, the rhythm part may be muted for Lesson 2.

3 Play the appropriate melody or chord with the song.

After the lead-in, the song starts automatically, and the appropriate notes appear in the display. In Lesson 2, play the correct notes at your own pace, until you can master playing them in rhythm.

Lesson 3 — Minus One

This lesson step lets you practice one part of the song in rhythm at the proper tempo. The PSR-160 plays back the song accompaniment with one part muted (either the left part or the right)— letting you play and master the missing part yourself. The notes you are to play are shown continuously in the display as the song plays back.

1 Select one of the songs.

2 Select Lesson 3.

Press the [L] or [R] button (repeatedly, if necessary) until Lesson 3 is indicated.

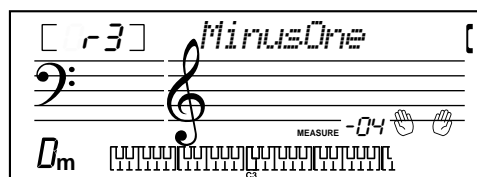

Song Lesson

3 Play the appropriate part with the song.

After the lead-in, the song starts automatically, and the appropriate notes appear in the display. In Lesson 3, listen carefully to the un-muted part, and play the muted part yourself.

Lesson 4 — Both Hands

Lesson 4 is a “Minus One” practice essentially the same as Lesson 3, except that both the left- and right-hand parts are muted — letting you play and master both hands at the same time. Go on to this lesson step after you’ve mastered each hand’s part in the previous three lesson steps. Practice both hands in time with the rhythm along with the notation in the display.

1 Select one of the songs.

2 Select Lesson 4.

Press the [L] and [R] buttons simultaneously, so that Lesson 4 is indicated.

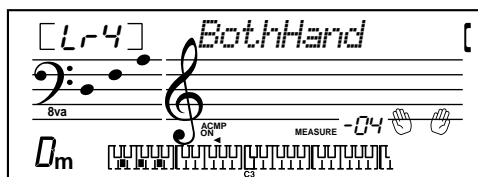

3 Play both the left- and right-hand parts with the song.

After the lead-in, the song starts automatically, and the appropriate notes appear in the display. In Lesson 4, both parts (left and right) are muted, letting you play the entire song by yourself.

Grade

The Lesson feature has a built-in evaluation function that monitors your practicing of the Lesson songs, and just like a real teacher, it tells you how well you did each exercise. Four grades are assigned, depending on your performance: “OK,” “Good,” “Very Good,” and “Excellent.” When the Talking function (page 40) is on, the PSR-160 also “announces” your grade.

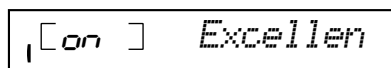

1 Select the Grade function.

Press the [OVERALL] button, repeatedly if necessary, until “GRADE” appears in the display.

NOTE

- Grade is automatically set to on as the default setting.

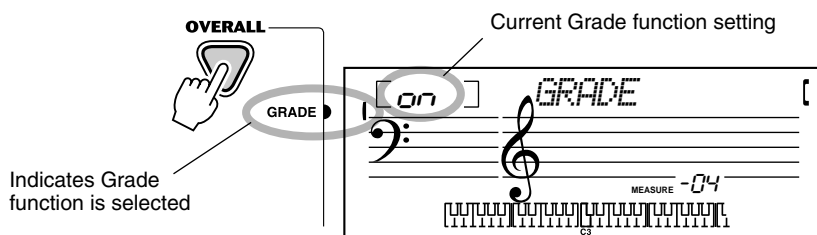

2 Set Grade to on or off as desired.

Use the [+]/[-] buttons to set Grade to on or off.

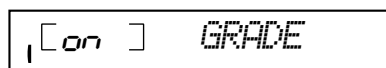
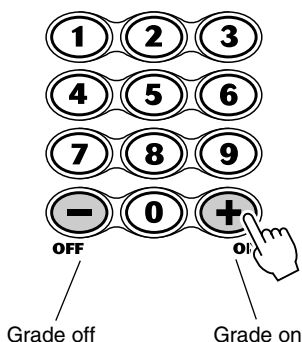



Talking

This feature “talks” to you through the speakers, “announcing” the Grade comments as well as the titles of the Lesson steps and the names of certain functions.

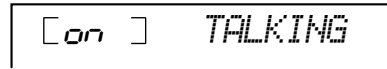

1 Select the Talking function.

Press the left Overall button, repeatedly if necessary, until “TALKING” appears in the display.

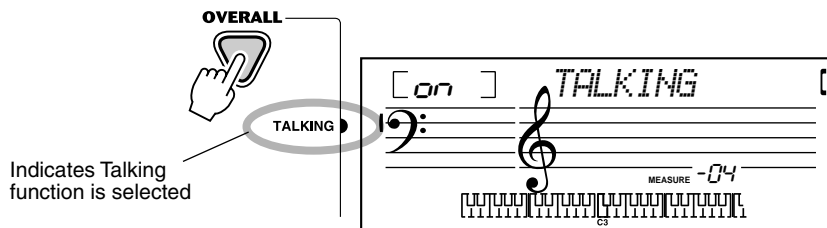

2 Set Talking to on or off as desired.

Use the [+]/[-] buttons to set Talking to on or off.

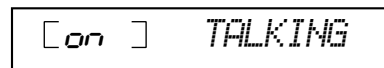
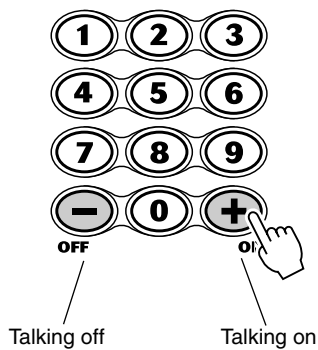

NOTE

- Talking is automatically set to on as the default setting.

The Talking function includes the following “announcements”:

- DJ
- LESSON 1
- LESSON 2
- LESSON 3
- LESSON 4
- OK
- Good
- Very Good
- Excellent
- Dictionary



Dictionary

The Dictionary feature is essentially a built-in “chord book” that shows you the individual notes of chords. It is ideal when you know the name of a certain chord and want to quickly learn how to play it.

1 Press the [Dict.] button.

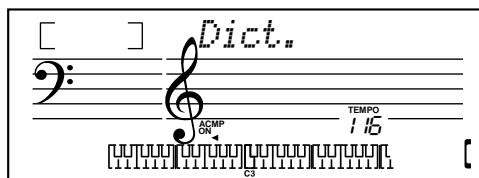

2 Specify the root of the chord.

Press the key on the keyboard that corresponds to the desired chord root (as printed on the panel).

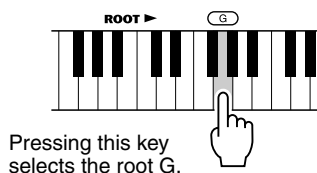

Pressing this key selects the root G.



3 Specify the type of the chord (major, minor, seventh, etc.).

Press the key on the keyboard that corresponds to the desired chord type (as printed on the panel).

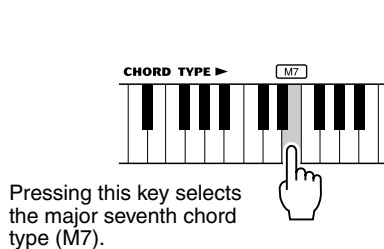

Pressing this key selects the major seventh chord type (M7).

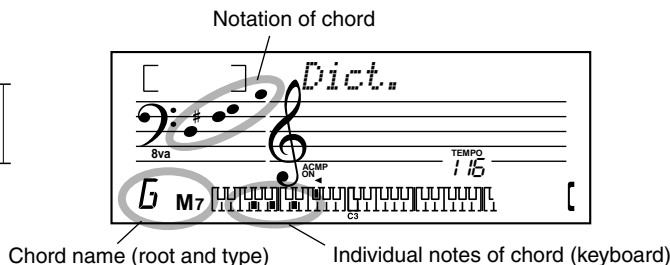

The display shows the name of the chord, and the individual notes — both in notation and on the keyboard diagram.

4 Play the chord.

Play the chord (as indicated in the display) in the ACMP section of the keyboard. The chord name flashes in the display (and a “congratulations” melody is played) when the correct notes are held down. (Inversions for many of the chords are also recognized.)

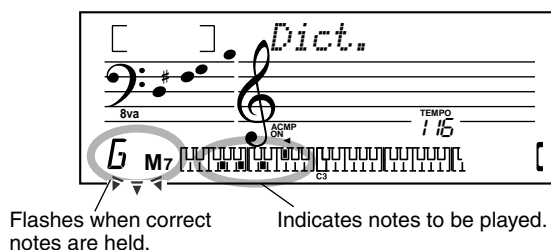
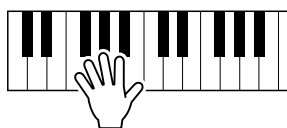

To leave the Dictionary function, press the [Dict.] button again.



Selecting and Playing Styles

The PSR-160 provides dynamic rhythm/accompaniment patterns — as well as voice settings appropriate for each pattern — for various popular music styles.

A total of 100 different styles are available, in several different categories. Each style is made up of separate “sections” — Intro, Main A and B (with 2 Fill-ins), and Ending — letting you call up different accompaniment patterns as you perform.

The auto accompaniment features that are built into the rhythms add the excitement of instrumental backing to your performance, letting you control the accompaniment by the chords you play. Auto accompaniment effectively splits the keyboard into two sections: The upper is used for playing a melody line, and the lower (labeled “ACMP” in green above the keyboard, at F#2) is for the auto accompaniment function.

The PSR-160 also features the convenient Dictionary function. Dictionary provides you with a built-in “chord encyclopedia” that teaches you how to play any chord you specify by showing you the appropriate notes in the display.

Selecting and Playing a Style

1 Press the [STYLE] button.

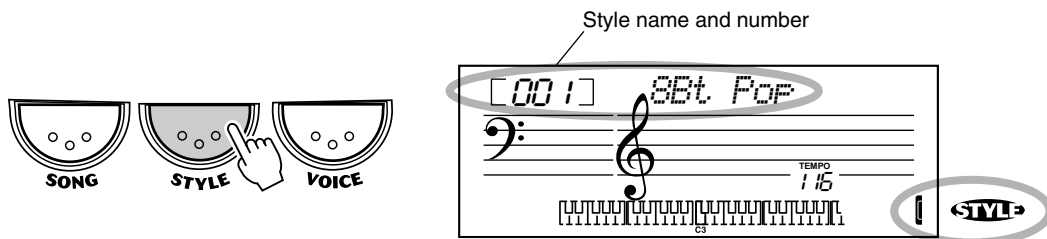

2 Select the desired style number.

Use the numeric keypad. Available styles are listed at the center of the panel.

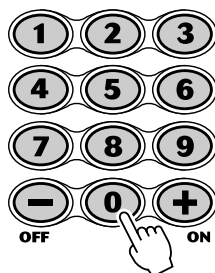

STYLE	BALLAD	DJ
8BEAT	011 8BT BALLAD	026~030 DJ1~5
001 8BT POP	012 EPIC BALLAD	ROCK
002 8BT UPTEMPO	013 PIANO BALLAD	031 8BT ROCK BLD
003 8BT STANDARD	014 SOUL BALLAD	032 16BT ROCK BLD
004 8BT SHUFFLE	015 SLOW ROCK	033 HARD ROCK
005 FOLKROCK	016 6/8 BALLAD	034 ROCK SHUFFLE
006 POP ROCK	017-019 HARP ARP 1~3	035 6/8 HVY ROCK
007 CRYSTAL POP	020 MUSIC BOX	036 US ROCK
008 8BT MEDIUM	DANCE	ROCK & ROLL
16BEAT	021 DANCE POP	037 ROCK & ROLL
009 16BT SHUFFLE	022 TECHNO	038 BOOGIE
010 16BT POP	023 EUROBEAT	039 TWIST
	024 HIP HOP	
	025 70S DISCO	

Style numbers can be selected in the same way as with the voices (see page 23). You can use the numeric keypad to directly enter the style number, or use the [+]/[-] buttons to step up and down through the style numbers.

Playing the Accompaniment

When the Style mode is active, the panel buttons below the function as style controls.

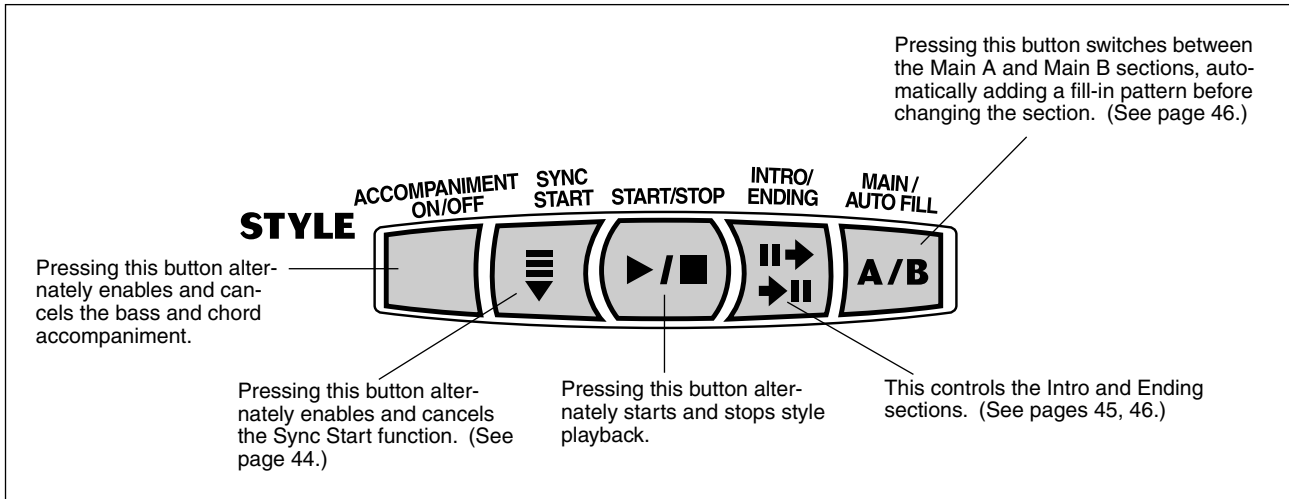

1 Press the [ACCOMPANIMENT ON/OFF] button.

This enables the auto accompaniment.

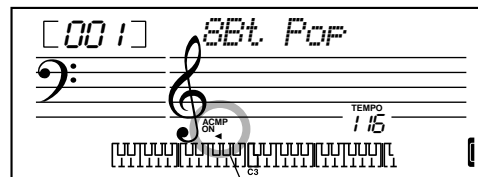
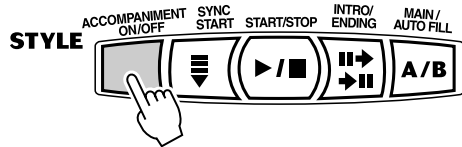

Indicates that auto accompaniment is on.

2 Start the accompaniment.

You can do this in one of the following ways:

■ Pressing the [START/STOP] button

The rhythm starts playing immediately without bass and chord accompaniment. The currently selected Main A or B section will play. (You can select either by repeatedly pressing the [MAIN/AUTO FILL] button, before pressing the [START/STOP] button.)

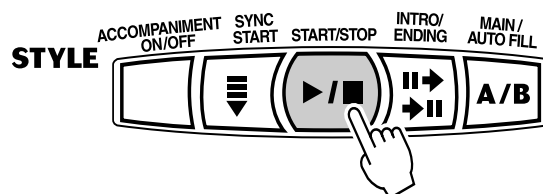

Selecting and Playing Styles

■ Using Tap Tempo to start

This useful feature lets you tap out the speed (tempo) of the auto accompaniment and automatically start the accompaniment at that tapped speed.



Simply tap the [TEMPO/TAP] button four times (or three times for a 3/4 time style), and the accompaniment starts automatically at the tempo you tapped. You can also change the tempo while the accompaniment is playing by tapping the [TEMPO/TAP] button twice at the desired tempo.

■ Using Sync Start

The PSR-160 also has a Sync Start function that allows you to start the rhythm/accompaniment by simply pressing a key on the keyboard. To use Sync Start, first press the [SYNC START] button (the handclap icon flashes to indicate Sync Start stand-by), then press any key in the ACMP section of the keyboard (or any key when accompaniment is off).

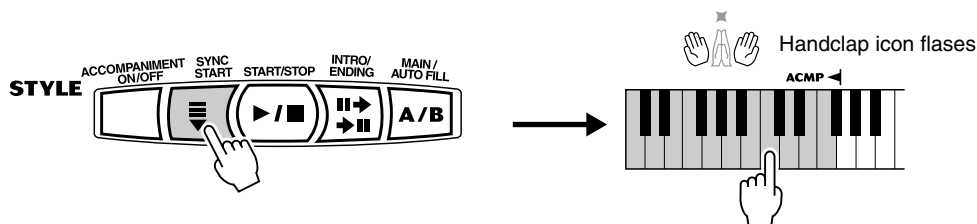

About the Beat Display

The handclap icon in the display flashes in time with the current tempo during playback of a style (or song). The flashing pattern provides a visual indication of both the tempo and time signature of the style or song. (For more information, see page 31.)

Starting with an section

First, press the [MAIN/AUTO FILL] button, repeatedly if necessary, to select which section (A or B) is to follow the Intro. Next, press the [INTRO/ENDING] button to set the Intro to standby.

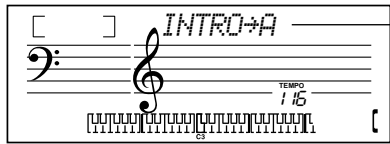

Indicates that Intro is on, and will be followed by the Main A section.

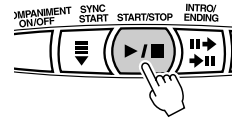

To actually start the Intro section and accompaniment, press the [START/STOP] button.

Using Sync Start with an Intro section

First, press the [MAIN/AUTO FILL] button, repeatedly if necessary, to select which section (A or B) is to follow the Intro. Next, press the [INTRO/ENDING] button.

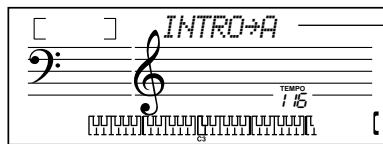

Indicates that Intro will be followed by the Main A section.

Finally, press the [SYNC START] button to enable Sync Start, and start the Intro section and style by playing any key in the ACMP section of the keyboard.

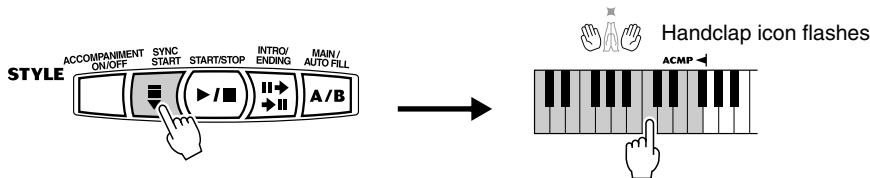

3 Change chords using the auto accompaniment feature.

Try playing a few successive chords with your left hand, and notice how the bass and chord accompaniment change with each chord you play.

HINT

- The [ACCOMPANIMENT ON/OFF] button can also be used to turn off and on the bass/chord accompaniment while playing — allowing you to create dynamic rhythmic breaks in your performance.

NOTE

- Chords played in the ACMP section of the keyboard are also detected and played when the accompaniment is stopped. In effect, this gives you a “split keyboard,” with bass and chords in the left hand and the normally selected voice in the right.

Selecting and Playing Styles

4 Stop the style.

You can do this in one of three ways:

■ Pressing the [START/STOP] button

The rhythm/accompaniment stops playing immediately.

■ Using an Ending section

Press the [INTRO/ENDING] button. The style stops after the Ending section is finished.

■ Pressing the [SYNC START] button

This stops the style and automatically enables Sync Start, letting you re-start the style by simply playing a chord or key in the ACMP section of the keyboard (or any key when accompaniment is off).

NOTE

- To have the Ending section gradually slow down (*ritardando*) as it is playing, press the [INTRO/ENDING] button twice quickly.

Changing the Tempo

The Tempo of song (and style) playback can be adjusted over a range of 40 - 240 bpm (beats per minute). For instructions on changing the Tempo, see page 31.

NOTE

- Each style has been given a default or standard tempo. When style playback is stopped and a different style is selected, the tempo returns to the default setting of the new style. When switching styles during playback, the last tempo setting is maintained. (This allows you to keep the same tempo, even when changing styles.)

HINT

- You can also use the convenient Tap Tempo function to change the tempo by "tapping" a new one in real time. (See page 44.)

Style Sections (Main A, Main B) and Fill-ins

While the style is playing you can create dynamic variation in the rhythm and accompaniment by pressing the [MAIN/AUTO FILL] button. This switches between the Main A and Main B sections, automatically playing a fill-in pattern to smoothly lead into the next section. For example, if the Main A section is currently playing, pressing this button automatically plays a fill-in pattern, followed by the Main B section.

You can also select either the Main A or B section to start by pressing the [MAIN/AUTO FILL] button before starting the style.

NOTE

- Fill-in patterns are not available when one of the Pianist styles (#081 - #100) are selected.

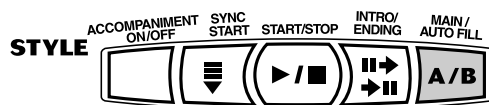

About the Fill-in Patterns

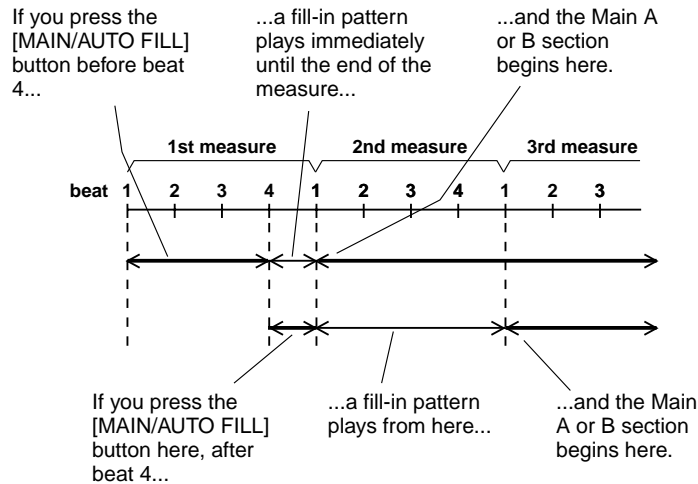

Adjusting the Accompaniment Volume

The playback volume of the accompaniment can be adjusted. This volume control affects only the style volume. The volume range is 000 - 127.

1 Select the Accompaniment Volume function in the Overall menu.

Press the [OVERALL] button, repeatedly if necessary, until "ACMP VOL" appears in the display.

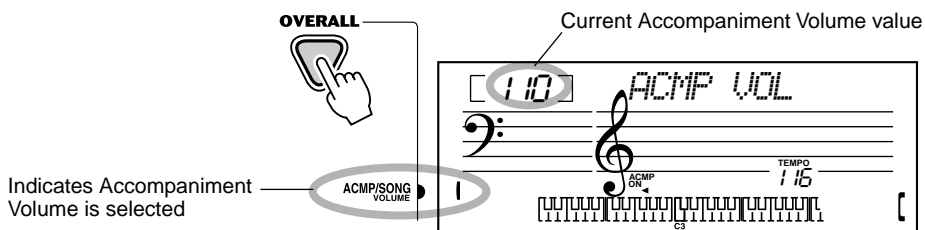

2 Change the value.

Use the numeric keypad to set the desired Accompaniment Volume value (000 - 127). You can also use the [+]/[-] buttons to increase or decrease the value. Holding down either button continuously increases or decreases the value.

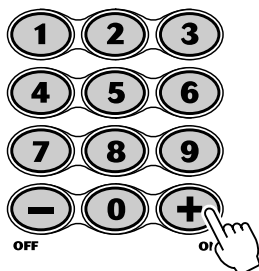

NOTE

- Accompaniment Volume cannot be changed unless the Style mode is active.

Restoring the Default Accompaniment Volume Value

If you've changed the Accompaniment Volume setting, you can instantly restore the default setting of "110" by pressing both [+]/[-] buttons simultaneously (when Accompaniment Volume is selected).





Selecting and Playing Styles

Using Auto Accompaniment — Multi Fingering

The auto accompaniment function automatically generates bass and chord accompaniment for you to play along with, by using Multi Fingering operation. You can change the chords of the accompaniment by playing keys in the ACMP section of the keyboard using either the “Single Finger” or “Fingered” method. With Single Finger you can simply play a one-, two- or three-finger chord indication (see Single Finger Chords below). The Fingered technique is that of conventionally playing all the notes of the chord. Whichever method you use, the PSR-160 “understands” what chord you indicate and then automatically generates the accompaniment.

■ Single Finger Chords







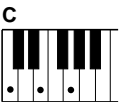
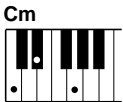

Chords that can be produced in Single Finger operation are major, minor, seventh and minor seventh. The illustration below shows how to produce the four chord types. (The key of C is used here as an example; other keys follow the same rules. For example, B \flat 7 is played as B \flat and A.)

 <p>C</p>	 <p>Cm</p>	 <p>C7</p>	 <p>Cm7</p>
<p>To play a major chord: Press the root note of the chord.</p>	<p>To play a minor chord: Press the root note together with the nearest black key to the left of it.</p>	<p>To play a seventh chord: Press the root note together with the nearest white key to the left of it.</p>	<p>To play a minor seventh chord: Press the root note together with the nearest white and black keys to the left of it (three keys altogether).</p>

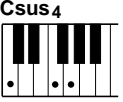
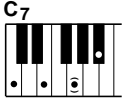
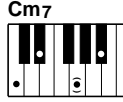
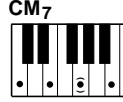
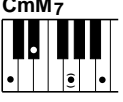
■ Fingered Chords

Using the key of C as an example, the chart below shows the types of chords that can be recognized in the Fingered mode.

Fingered Chords in the Key of C

 <p>C</p>	 <p>Cm</p>	 <p>Caug (7aug)</p>	 <p>Cdim (dim7)</p>
 <p>Csus4</p>	 <p>C7</p>	 <p>Cm7</p>	 <p>CM7</p>
 <p>CmM7</p>	 <p>C7\flat5</p>	 <p>Cm7\flat5</p>	 <p>C7sus4</p>
 <p>Cm6</p>	 <p>C(9)</p>		

* Notes enclosed in parentheses are optional; the chords will be recognized without them.

NOTE

If the chord is inverted (i.e., C-E-G is played as G-C-E), the PSR-160 will still recognize it as a C chord. The chord recognition system also has the following rules and exceptions:

- Minor 6th chords are recognized only in root position, however; all other inversions are interpreted as minor 7th/flatted 5th.
- If augmented and diminished 7th chords are inverted, the lowest note will be recognized as the root.
- 7th flatted 5th chords may be played with the lowest note as the root or the flatted 7th.
- Augmented 7th and diminished 7th chords are interpreted as simple augmented and diminished.

NOTE

- The following chords are not recognized: B minor 6, B \flat minor 6, and B augmented.

..... What is a Chord?

The simple answer: Three or more notes played simultaneously is a chord. (Two notes played together is an “interval” — an interval being the distance between two different notes. This is also referred to as a “harmony.”) Depending on the intervals between the three or more notes, a chord can sound beautiful or muddy and dissonant.

The organization of notes in the example at left — a triad chord — produces a pleasant, harmonious sound. Triads are made up of three notes and are the most basic and common chords in most music.



In this triad, the lowest note is the “root.” The root is the most important note in the chord, because it anchors the sound harmonically by determining its “key” and forms the basis for how we hear the other notes of the chord.

The second note of this chord is four semitones higher than the first, and the third is three semitones higher than the second. Keeping our root note fixed and changing these notes by a semitone up or down (sharp or flat), we can create four different chords.

<p>Major chord (ex. C)</p> <p>Minor 3rd Major 3rd</p>	<p>Minor chord (ex. Cm)</p> <p>Major 3rd Minor 3rd</p>	<p>Augmented chord (ex. Caug)</p> <p>Major 3rd Major 3rd</p>	<p>Diminished chord (ex. Cdim)</p> <p>Minor 3rd Minor 3rd</p>
---	--	--	---

Keep in mind that we can also change the “voicing” of a chord — for example, change the order of the notes (called “inversions”), or play the same notes in different octaves — without changing the basic nature of the chord itself.

Inversion examples for the key of C



Beautiful sounding harmonies can be built in this manner. The use of intervals and chords is one of the most important elements in music. A wide variety of emotions and feelings can be created depending on the types of chords used and the order in which they are arranged.

Selecting and Playing Styles

..... Writing Chord Names

Knowing how to read and write chord names is an easy yet invaluable skill. Chords are often written in a kind of shorthand that makes them instantly recognizable (and gives you the freedom to play them with the voicing or inversion that you prefer). Once you understand the basic principles of harmony and chords, it's very simple to use this shorthand to write out the chords of a song.

First, write the root note of the chord in an uppercase letter. If you need to specify sharp or flat, indicate that to the right of the root. The chord type should be indicated to the right as well. Examples for the key of C are shown below.

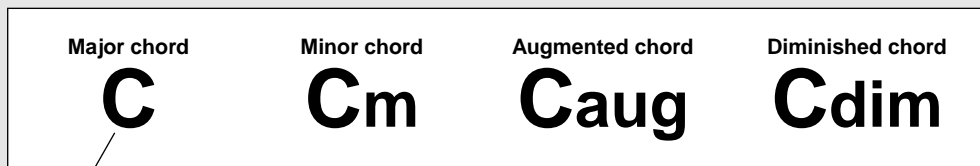

For simple major chords, the type is omitted.

One important point: Chords are made up of notes “stacked” on top of each other, and the stacked notes are indicated in the chord name of the chord type as a number — the number being the distance of the note from the root. (See the keyboard diagram below.) For example, the minor 6th chord includes the 6th note of the scale, the major 7th chord has the 7th note of the scale, etc.

The Intervals of the Scale

To better understand the intervals and the numbers used to represent them in the chord name, study this diagram of the C major scale:

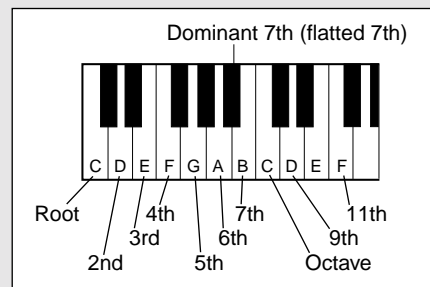

Other Chords

Csus4

C7

Cm7

CM7

Cm7b5

Cm6

C(9)

Multi Pads

These convenient pads let you instantly trigger various musical and rhythmic phrases as you play the PSR-160. There are a total of 40 different sounds or phrases (10 banks, with four pad sounds for each bank). The phrases play back at the same speed as the Tempo setting, and they also change harmonically along with the accompaniment chords (both in the Style and Song modes).

1 Select the Pad function in the Overall menu.

Press the [OVERALL] button, repeatedly if necessary, until MULTI PAD is selected in the display.

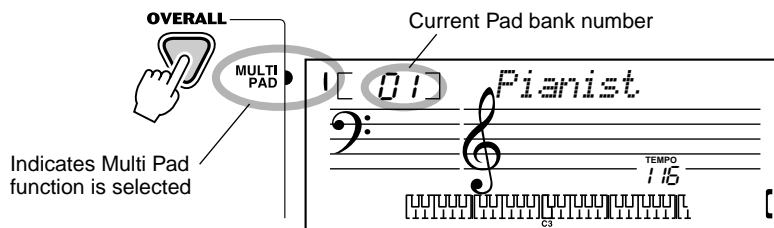

2 Select the desired bank.

Use the numeric keypad to select the desired bank number (1 - 10). You can also use the [+]/[-] buttons to increase or decrease the value. Holding down either button continuously increases or decreases the value. For a complete list of the available banks and their contents, see page 57.

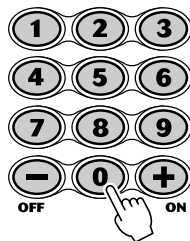

3 Play the Multi Pads.

Press one of the Pads. The phrase plays uninterrupted until it is finished. Pressing it repeatedly (before the phrase completely plays back) creates a “stutter” effect.



In the Style mode, melodic-type sounds correctly follow the chord changes. All sounds play back in perfect time with the current Tempo setting. When One Touch Setting (page 26) is on, appropriate Multi Pad banks for the selected style are automatically called up. This applies to the DJ and Portable Grand features as well.

NOTE

- In the DJ GAME, you can play the Multi Pads as well as the keyboard.



MIDI

The PSR-160 also features MIDI terminals, allowing you to interface the PSR-160 with other MIDI instruments and devices.

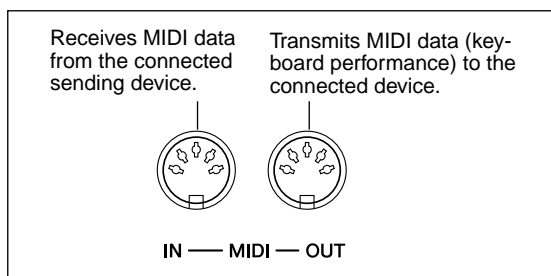

■ About MIDI

MIDI (Musical Instrument Digital Interface) is a worldwide standard that is built into many electronic musical instruments and other digital music related devices, allowing them to be connected and “communicate” with each other.

For two MIDI instruments to communicate, they must be connected by MIDI cables. In a basic example, the MIDI IN and MIDI OUT terminals of the PSR-160 could be connected to the MIDI OUT and MIDI IN terminals of a sequencer, allowing you to record and play back performance data from the PSR-160.

The instruments communicate with each other by sending “messages” or MIDI data. The sending instrument usually assigns the data to one of sixteen MIDI channels, then transmits it over the MIDI cable. The cable itself, however, is not divided up into sixteen channels. Just as with a television set that receives programs on different channels, it is up to the receiving instrument to “tune into” the proper MIDI channel. If the sending and receiving channels on the respective instruments do not match, the receiving instrument may not understand or respond to the one sending.

■ How Can MIDI be Used?

In the simple, yet powerful MIDI application example below, the Yamaha QY-70 Music Sequencer is used to record and play back performance data played on the PSR-160 keyboard.

Before actually recording to the sequencer, press the [ACCOMPANIMENT ON/OFF] button once or twice to make sure that the current settings are sent.

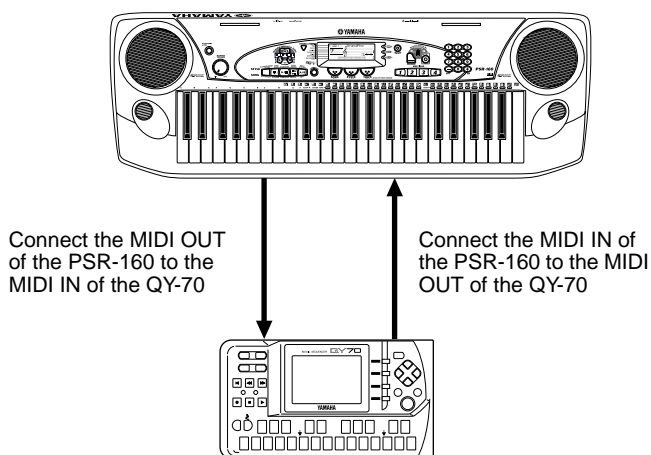

- NOTE**
- On the PSR-160, the following channels (eight total) are enabled for MIDI reception: 1, 2, 3, 4, 5, 6, 7, 10. The MIDI transmit channels are fixed to the following data:
 - Ch. 1 : Keyboard, harmony
 - Ch. 2 : Bass
 - Ch. 3 : Chord
 - Ch. 4 - 7 : Other
 - Ch. 10 : Rhythm
 - Parts that have been recorded using the PSR-160 should also be played back from the PSR-160. Data may not play back as expected when using other sound sources (such as the internal sounds of the QY-70). Also, a connected sound source may sound at a different octave from that originally played on the PSR-160.
 - MIDI data cannot be transmitted during song playback.
 - Avoid using MIDI cables 15 meters or longer, since doing so can result in MIDI errors.

- NOTE**
- Viewing the Notation for MIDI Channel 1**
- The PSR-160 has a special function that lets you view the notes of the MIDI data (channel 1 only) on the display.



Troubleshooting

Problem	Possible Cause and Solution
When the PSR-160 is turned on or off, a popping sound is temporarily produced.	This is normal and indicates that the PSR-160 is receiving electrical power.
When using a mobile phone, noise is produced.	Using a mobile phone in close proximity to the PSR-160 may produce interference. To prevent this, turn off the mobile phone or use it further away from the PSR-160.
The sound of the voices or rhythms seems unusual or strange.	The battery power is too low. Replace the batteries. (See page 8.)
There is no sound even when the keyboard is played or when a Song is being played back.	Check that nothing is connected to the PHONES/OUTPUT jack on the rear panel. When a set of headphones is plugged into this jack, no sound is output.
When playing back one of the Pianist styles (#081 - #100), the rhythm cannot be heard.	This is normal. The Pianist styles have no drums or bass — only piano accompaniment. The accompaniment of the style can only be heard when accompaniment is set to ON and keys are played in the auto accompaniment section of the keyboard.
The auto accompaniment doesn't turn on, even when pressing the [ACCOMPANIMENT ON/OFF] button.	Make sure the Style mode is active before using the auto accompaniment. Press the [STYLE] button to enable style operations.
Not all notes are heard when playing a number of notes simultaneously.	Too many keys are pressed at the same time. The PSR-160 is polyphonic up to a maximum of 16 notes.
Playing keys in the right hand section of the keyboard does not produce any sound.	When using the Dictionary function (page 41), the keys in the right hand section are used only for entering the chord root and type.
The accompaniment does not sound properly.	Make sure that the Accompaniment Volume (page 47) is set to an appropriate level.
The Multi Pad sound is cut off or sounds unusual.	The PSR-160 is polyphonic up to a maximum of 16 notes. If a style or song is playing back at the same time a Multi Pad is played, some notes/sounds of the Multi Pad may be omitted (or "stolen") from the accompaniment or song.
The sound of the voice changes from note to note.	The AWM tone generation method uses multiple recordings (samples) of an instrument across the range of the keyboard; thus, the actual sound of the voice may be slightly different from note to note.
The notes shown in the music staves and keyboard diagram in the display do not match the keys actually played.	When auto accompaniment is on, the display shows the specific notes of the chords you play in the auto accompaniment section of the keyboard. If you play a single finger chord, or an inversion of a chord, the corresponding chord will be appropriately displayed — even if the display does not exactly match the pressed keys.



Voice List

The following voices can be selected when the Voice mode is active, or when the Voice Change function is on. They can also be selected by a connected MIDI device; the corresponding bank select messages are: MSB = 00H, LSB = 70H.

When selecting voices via MIDI:

* The Harmony voices (#059 - #068) and Echo voices (#079 - #088) are sounded without the respective harmony and echo effects.

● Panel Voice List

Voice#	MIDI Program Change#	Voice Name	Used Notes
PIANO			
001	0	GRAND PIANO	2
002	1	HONKY-TONK	2
003	2	E PIANO 1	2
004	3	E PIANO 2	2
005	4	E PIANO 3	2
006	5	E PIANO 4	2
007	6	HARPSICHORD	2
008	7	CLAVI	1
009	8	CELESTA	1
ORGAN			
010	9	VIBRATO OFF	2
011	10	VIBRATO ON	2
012	11	HARMONY OFF	2
013	12	HARMONY ON	2
014	13	ATTACK OFF	2
015	14	ATTACK ON	2
016	15	WAVE OFF	2
017	16	WAVE ON	2
018	17	PIPE ORGAN	2
019	18	ACCORDION	2
020	19	HARMONICA	1
GUITAR/BASS			
021	20	SOFT GUITAR	1
022	21	FOLK GUITAR	1
023	22	12ST GUITAR	2
024	23	JAZZ GUITAR	1
025	24	E GUITAR	2
026	25	DIST GUITAR	2
027	26	WOOD BASS	1
028	27	FINGER BASS	1
029	28	SLAP BASS	1
STRINGS/MALLET			
030	29	STRINGS	1
031	30	VIOLIN	1
032	31	CELLO	1
033	32	HARP	1
034	33	SITAR	1
035	34	BANJO	1
036	35	VIBRAPHONE	1
037	36	MARIMBA	1
038	37	STEEL DRUMS	1
WIND			
039	38	TRUMPET	1
040	39	TROMBONE	1
041	40	MUTE TRPET	1
042	41	FRENCH HORN	1
043	42	BRASS SECT	1
044	43	ALTO SAX	1
045	44	TENOR SAX	1
046	45	OBOE	1
047	46	CLARINET	1
048	47	FLUTE	1
049	48	PAN FLUTE	1
SYNTHESIZER			
050	49	THICK LEAD	2
051	50	SIMPLE LEAD	1
052	51	THICK SAW	2

Voice#	MIDI Program Change#	Voice Name	Used Notes
053	52	SIMPLE SAW	1
054	53	SYNTH BASS	1
055	54	SY STRINGS	1
056	55	SY BRASS	2
057	56	SLOW STRS	1
058	57	CHORUS	1
HARMONY			
059	58	PIANO TRIO	3
060	59	PNO COUNTRY	2
061	60	E PNO TRIO	3
062	61	HARPSI TRIO	3
063	62	E ORG TRIO	3
064	63	VIBES DUET	2
065	64	TRP DUET	2
066	65	HORN DUET	2
067	66	CLARINET TR	3
068	67	FLUTE DUET	2
SPLIT			
069	68	WD BASS/PNO	1
070	69	STRINGS/PNO	1
071	70	FN BA/E PNO	1
072	71	HARP/VIOLIN	1
073	72	HORN/TRP	1
SUSTAIN			
074	73	SUS PIANO	1
075	74	SUS E PNO1	1
076	75	SUS E PNO2	1
077	76	SUS VIBRAPHONE	1
078	77	SUS STRINGS	1
ECHO			
079	78	PIANO	1
080	79	E PIANO	1
081	80	HARPSICHORD	1
082	81	CELESTA	1
083	82	FOLK GUITAR	1
084	83	BANJO	1
085	84	VIBRAPHONE	1
086	85	MARIMBA	1
087	86	STEEL DRUMS	1
088	*1	DRUM KIT	1
DUAL			
089	88	PNO CONCE	2
090	89	E PNO CONCE	2
091	90	FAIRY LAND	2
092	91	MOOD GUITAR	2
093	92	RICH GUITAR	2
094	93	HOT ORGAN	2
095	94	EXCEL VIOLIN	2
096	95	CRYSTAL	2
097	96	STAR SHIP	2
DJ Voice			
098	97	DJ VOICE 1	1
099	98	DJ VOICE 2	1
DRUMS			
100	*2	DRUM KIT	1

*1 MSB=7FH, LSB=00H, Prg Ch#=1

*2 MSB=7FH, LSB=00H, Prg Ch#=2

The following voices cannot be directly selected from the panel controls; they are special voices programmed into the songs of the PSR-160 and are selected automatically in song playback. However, they can be selected by a connected MIDI device; the corresponding bank select messages are: MSB = 00H, LSB = 00H.

MIDI Program Change#	Voice Name	Used Notes
0	Piano	1
3	Honky-tonk Piano	2
4	Electric Piano 1	2
5	Electric Piano 2	2
6	Harpsichord	1
7	Clavi	1
8	Celesta	1
11	Vibraphone	1
12	Marimba	1
16	Electric Organ 1	2
17	Electric Organ 2	2
19	Pipe Organ	2
21	Accordion	1
22	Harmonica	1
23	Wave Organ	2
24	Soft Guitar	1
25	Folk Guitar	1
26	Jazz Guitar	1
27	Electric Guitar	1
28	12Strings Guitar	2
29	Rich Guitar	2
30	Distortion Guitar	1
32	Wood Bass	1
33	Finger Bass	1
34	Mute Bass	1
36	Slap Bass	1
38	Synth Bass	1
40	Violin	1
42	Cello	1
46	Harp	1
49	Strings	1
51	Synth Strings	1

MIDI Program Change#	Voice Name	Used Notes
52	Choir	1
56	Trumpet	1
57	Trombone	1
59	Muted Trumpet	1
60	French Horn	1
61	Brass Section	1
63	Synth Brass	1
65	Alto Sax	1
66	Tenor Sax	1
68	Oboe	1
71	Clarinet	1
73	Flute	1
75	Pan Flute	1
80	Lead	1
81	Sawtooth	1
88	Piano Concerto	2
89	Electric Piano Concerto	2
90	Fairy land	2
91	Hot Organ	2
92	Mood Guitar	2
93	Excel Violin	2
94	Star ship	2
95	Slow Strings	1
98	Crystal	2
104	Sitar	1
105	Banjo	1
114	Steel Drums	1
123	Wood Bass / Piano	1
124	Strings / Piano	1
125	Finger Bass / Electric Piano	1
126	Harp / Violin	1
127	Horn / Trumpet	1



Drum Kit List

- Each percussion voice uses one note.
- The MIDI Note # and Note are actually one octave lower than listed. For example, the "Bass Drum 2" (Note# 36/Note C1) corresponds to (Note# 24/Note C0).
- Voices with the same Alternate Note Number (*1 ... 2) cannot be played simultaneously. (They are designed to be played alternately with each other.)

Bank MSB#		127	
Bank LSB#		0	
Program Change#			
0			
Keyboard		Alternate	Drum Kit
Note#	Note	assign	
12	C	-1	
13	C#	-1	
14	D	-1	
15	D#	-1	Hi Q
16	E	-1	
17	F	-1	Scratch H
18	F#	-1	Scratch L
19	G	-1	
20	G#	-1	
21	A	-1	
22	A#	-1	
23	B	-1	
24	C	0	
25	C#	0	
26	D	0	
27	D#	0	Brush Slap
28	E	0	Reverse Cymbal
29	F	0	
30	F#	0	Electronic Bass Drum
31	G	0	
32	G#	0	Electronic Snare Drum
33	A	0	
34	A#	0	
35	B	0	Bass Drum 1
36	C	1	Bass Drum 2
37	C#	1	Rim Shot
38	D	1	Snare Drum 1
39	D#	1	Electronic Floor Tom
40	E	1	Snare Drum 2
41	F	1	Floor Tom
42	F#	1	1 Hi-hat Closed
43	G	1	Electronic Low Tom
44	G#	1	1 Hi-Hat Pedal
45	A	1	Low Tom
46	A#	1	1 Hi-Hat Open
47	B	1	Electronic Mid Tom
48	C	2	Mid Tom
49	C#	2	Crash Cymbal
50	D	2	High Tom
51	D#	2	Ride Cymbal 1
52	E	2	Electronic High Tom
53	F	2	Ride Cymbal Cup
54	F#	2	Tambourine
55	G	2	Splash Cymbal
56	G#	2	Cowbell
57	A	2	
58	A#	2	
59	B	2	Ride Cymbal 2
60	C	3	Bongo H
61	C#	3	Bongo L
62	D	3	Conga H Mute
63	D#	3	Conga H Open
64	E	3	Conga L
65	F	3	Timbale H
66	F#	3	Timbale L
67	G	3	Agogo H
68	G#	3	Agogo L
69	A	3	
70	A#	3	
71	B	3	
72	C	4	
73	C#	4	Guiro Short
74	D	4	Guiro Long
75	D#	4	Claves
76	E	4	
77	F	4	
78	F#	4	
79	G	4	
80	G#	4	2 Triangle Mute
81	A	4	2 Triangle Open
82	A#	4	Shaker
83	B	4	
84	C	5	Bell Tree
85	C#	5	Electronic Bass Drum A
86	D	5	Electronic Bass Drum B
87	D#	5	Electronic Bass Drum C
88	E	5	Electronic Snare Drum A
89	F	5	Electronic Snare Drum B
90	F#	5	Electronic Rim Shot
91	G	5	Reverse Pulse
92	G#	5	Hand Clap
93	A	5	Orchestra Hit
94	A#	5	Scratch 1
95	B	5	Scratch 2
96	C	6	Scratch 3



Style List & Multi pads

● Style List

No.	Style Name
8BEAT	
1	8Beat Pop
2	8Beat Uptempo
3	8Beat Standard
4	8Beat Shuffle
5	Folkrock
6	Pop Rock
7	Crystal Pop
8	8Beat Medium
16BEAT	
9	16Beat Shuffle
10	16Beat Pop
BALLAD	
11	8Beat Ballad
12	Epic Ballad
13	Piano Ballad
14	Soul Ballad
15	Slow Rock
16	6/8 Ballad
17	Harp Arpeggio 1
18	Harp Arpeggio 2
19	Harp Arpeggio 3
20	Music Box
DANCE	
21	Dance Pop
22	Techno
23	Eurobeat
24	Hip Hop
25	70s Disco

No.	Style Name
DJ	
26	Euro Techno
27	Funky Trip Hop
28	Pop Reggae
29	Acid House
30	Shakin'
ROCK	
31	8Beat Rock Ballad
32	16Beat Rock Ballad
33	Hard Rock
34	Rock Shuffle
35	6/8 Heavy Rock
36	US Rock
ROCK & ROLL	
37	Rock & Roll
38	Boogie
39	Twist
RHYTHM & BLUES	
40	R&B
41	Funk
42	Soul
43	Gospel Shuffle
44	6/8 Gospel
45	4/4 Blues
JAZZ	
46	Jazz Ballad
47	Jazz Waltz
48	Fusion
49	Big Band Swing

No.	Style Name
50	Big Band Ballad
51	Jazz Quartet
52	Dixieland
COUNTRY & WESTERN	
53	Bluegrass
54	2/4 Country
55	Country Ballad
56	Country Shuffle
BALLROOM	
57	Rhumba
58	Tango Continental
59	Jive
MARCH & WALTZ	
60	March
61	6/8 March
62	Light March
63	Crystal March
64	Polka
65	Standard Waltz
66	German Waltz
67	Viennese Waltz
68	Crystal Waltz
69	Orchestra Waltz 1
70	Orchestra Waltz 2
71	Music Box Waltz
LATIN	
72	Bossa Nova
73	Salsa
74	Samba

No.	Style Name
75	Mambo
76	Beguine
77	Merengue
78	Bolero Lento
CARIBBEAN	
79	Reggae 1
80	Reggae 2
PIANIST	
81	2beat
82	Stride
83	Concerto
84	8beat
85	Honky-Tonk
86	Piano Ballad
87	Pop Ballad
88	Arpeggio 1
89	Arpeggio 2
90	Dance Pop
91	Rock & Roll
92	Tight Rock
93	Swing
94	Jazz Waltz
95	Ragtime
96	Beguine
97	Cha Cha
98	March
99	6/8 March
100	Galop

● Multi pads

Bank No.	Bank Name
1	Pianist
2	Twinkle
3	Organ Play
4	Guitar Play
5	Percussion
6	Drums
7	DJ Drums
8	DJ
9	Techno
10	1234



MIDI Implementation Chart

YAMAHA [PSR-160]

Model PSR-160 MIDI Implementation Chart

Date:26-JAN-2000

Version : 1.0

Function...	Transmitted	Recognized	Remarks
Basic Default Channel Changed	1 - 7,10 x	1 - 7,10 x	
Mode Default Messages Altered	3 x *****	3 x x	
Note Number : True voice	0 - 127 *****	0 - 127 0 - 127	
Velocity Note ON Note OFF	o 9nH,v=1-127 *1 x 9nH,v=0	o 9nH,v=1-127 x 9nH,v=0 or 8nH	
After Key's Touch Ch's	x x	x x	
Pitch Bend	x	x	
Control Change	0,32 o *2 7 o 10 o 6,38 x 64 o 71-74 x 84 o 91,93,94 x 96-97 x 98,99 x 100-101 x	0,32 o *2 7 o 10 o 6,38 x 64 o 71-74 x 84 o 91,93,94 x 96-97 x 98,99 x 100-101 x	Bank Select LSB,MSB Volume Pan Data Entry Sustain Portamento Cntrl RPN Inc,Dec NRPN LSB,MSB RPN LSB,MSB
Prog Change : True #	o 0 - 127 *3 *****	o 0 - 127 *3 *3	
System Exclusive	o *4	o *4	
Common : Song Pos. : Song Sel. : Tune	x x x	x x x	
System : Clock Real Time: Commands	x x	x x	
Aux : All Sound OFF : Reset All Cntrls : Local ON/OFF : All Notes OFF Mes- : Active Sense sages: Reset	x x x x o x	x x x x o x	

Mode 1 : OMNI ON , POLY
Mode 3 : OMNI OFF, POLY

Mode 2 : OMNI ON , MONO
Mode 4 : OMNI OFF, MONO

o : Yes
x : No

NOTE:

- *1 Depending on the selected voice, the transmitted velocity value may differ, even for notes played with identical strength.
- *2 MSB can be used to change the voice for the Melody or Rhythm.
MSB=00H :Melody Voice
MSB=7FH : Rhythm Voice
LSB: Refer to Voice list.
- *3 For program change values, refer to the voice list.
Program change and other like channel messages received will not affect the PSR-160 panel settings or what is being played on the keyboard.
- *4 < GM System on > F0H,7EH,7FH, 09H, 01H, F7H
All data is restored to the default values.
- *5 MIDI does not function (transmit/receive) in the Song mode.



Specifications

Keyboard

49 standard-size keys (C1 - C5)

Display

Large multi-function LCD display (backlit)

Setup

STANDBY/ON
MASTER VOLUME : MINI-MAX

Panel controls

Overall, SONG, VOICE, STYLE, DEMO, POTABLE
GRAND, DJ, METRONOME, Dict., L, R, TEMPO/TAP
numeric keypad (0 - 9, +,-)

Voices

100 panel voices (max. polyphony: 16)

Effects

Dual (Included in Voice),
Harmony/Echo (Included in Voice),
Split (Included in Voice),
Sustain (Included in Voice)

Auto Accompaniment

100 styles

Fingering: Multi Fingering

Sections: Intro, Main A, B, Ending, Fill

Overall controls

Multi Pad, Grade, Talking, Transpose, Tuning, Accompaniment Volume, Song Volume, Metronome Volume

Style controls

Acmp On/Off, Sync-Start, Start, Stop, Intro/Ending, Main A, B (Auto Fill)

Song controls

Start, Stop, Pause, A-B Repeat, Fast Forward, Rewind, Melody Voice Change

One Touch Setting

1/style, 1/song

Multi Pads

4 pads x 10 banks

Yamaha Education Suite

Dictionary, Lesson 1-4

Preset songs

100 songs

Amplifier

2.0W + 2.0W

MIDI

IN/OUT

Auxiliary jacks

PHONES/OUTPUT, DC IN 10-12V, MIDI IN/OUT

Speakers

10cm x 2

Power consumption

9W (when using PA-3B power adaptor)

Power supply

Adaptor: Yamaha PA-3B AC power adaptor
Batteries: Six "D" size, SUM-1, R-20 or equivalent batteries

Dimensions

924 x 317 x 107 mm
(36-3/8" x 12-1/2" x 4-1/4")

Weight

4kg (8 lbs., 13 oz.)

Supplied accessories

Music Stand, Owner's Manual, Song Book

Optional accessories

Headphones: HPE-150
AC power adaptor: PA-3B
Keyboard stand: L-2L, L-2C

* Specifications and descriptions in this owner's manual are for information purposes only. Yamaha Corp. reserves the right to change or modify products or specifications at any time without prior notice. Since specifications, equipment or options may not be the same in every locale, please check with your Yamaha dealer.



Index

Misc.

+/- buttons 24

A

A-B Repeat 33

AC adaptor 8

accessory jacks 9

Accompaniment Volume 47

auto accompaniment 48

B

batteries 8

beat display 31

Both hand 34

C

chord names 50

chord type 41

chords 49

chords, Fingered 48

chords, Single Finger 48

D

DEMO button 18

Dictionary 41

display indications 19

DJ 22

DJ Voice Chart 25

Drum Kit 25

Drum Kit List 56

Dual voices 25

E

Ending 46

F

Fill-in 46

Fingered chords 48

H

Harmony voices 25

headphones 9

I

Indicator 19

Interval 50

Intro 43

inversion 48

L

LESSON 34

M

Main A/B 46

Melody voice change 30

Metronome 21

MIDI 52

MIDI Implementation Chart 58

MIDI, about 52

Minus One 34

Multi Fingering 48

Multi Pads 51

music stand 9

N

numeric keypad 24

O

One Touch Setting (OTS) 26

Overall button 21

Overall function bar 19

P

PHONES/OUTPUT jack 9

Portable Grand 20

R

root 41, 48

S

sections (Style) 46

Single Finger chords 48

song controls 32

Song Volume 32

songs, selecting and playing 29

Specifications 60

Split voices 25

Style List 57

styles, selecting and playing 42

Sync Start 44

T

Talking 40

Tap Tempo 44

Tempo (song) 31

Tempo (style) 46

Time Signature 21

Timing 34

Transpose 27

Troubleshooting 53

Tuning 28

V

Voice List 54

voices, selecting and playing 23

W

Waiting 34

Limited Warranty

90 DAYS LABOR

1 YEAR PARTS

Yamaha Corporation of America, hereafter referred to as Yamaha, warrants to the original consumer of a product included in the categories listed below, that the product will be free of defects in materials and/or workmanship for the periods indicated. This warranty is applicable to all models included in the following series of products:

PSR SERIES OF PORTATONE ELECTRONIC KEYBOARDS

If during the first 90 days that immediately follows the purchase date, your new Yamaha product covered by this warranty is found to have a defect in material and/or workmanship, Yamaha and/or its authorized representative will repair such defect without charge for parts or labor.

If parts should be required after this 90 day period but within the one year period that immediately follows the purchase date, Yamaha will, subject to the terms of this warranty, supply these parts without charge. However, charges for labor, and/or any miscellaneous expenses incurred are the consumers responsibility. Yamaha reserves the right to utilize reconditioned parts in repairing these products and/or to use reconditioned units as warranty replacements.

THIS WARRANTY IS THE ONLY EXPRESS WARRANTY WHICH YAMAHA MAKES IN CONNECTION WITH THESE PRODUCTS. ANY IMPLIED WARRANTY APPLICABLE TO THE PRODUCT, INCLUDING THE WARRANTY OF MERCHANT ABILITY IS LIMITED TO THE DURATION OF THE EXPRESS WARRANTY. YAMAHA EXCLUDES AND SHALL NOT BE LIABLE IN ANY EVENT FOR INCIDENTAL OR CONSEQUENTIAL DAMAGES.

Some states do not allow limitations that relate to implied warranties and/or the exclusion of incidental or consequential damages. Therefore, these limitations and exclusions may not apply to you.

This warranty gives you specific legal rights. You may also have other rights which vary from state to state.

CONSUMERS RESPONSIBILITIES

If warranty service should be required, it is necessary that the consumer assume certain responsibilities:

1. Contact the Customer Service Department of the retailer selling the product, or any retail outlet authorized by Yamaha to sell the product for assistance. You may also contact Yamaha directly at the address provided below.
2. Deliver the unit to be serviced under warranty to: the retailer selling the product, an authorized service center, or to Yamaha with an explanation of the problem. Please be prepared to provide proof purchase date (sales receipt, credit card copy, etc.) when requesting service and/or parts under warranty.
3. Shipping and/or insurance costs are the consumers responsibility.* Units shipped for service should be packed securely.

*Repaired units will be returned PREPAID if warranty service is required within the first 90 days.

IMPORTANT: Do NOT ship anything to ANY location without prior authorization. A Return Authorization (RA) will be issued that has a tracking number assigned that will expedite the servicing of your unit and provide a tracking system if needed.

4. Your owners manual contains important safety and operating instructions. It is your responsibility to be aware of the contents of this manual and to follow all safety precautions.

EXCLUSIONS

This warranty does not apply to units whose trade name, trademark, and/or ID numbers have been altered, defaced, exchanged removed, or to failures and/or damages that may occur as a result of:

1. Neglect, abuse, abnormal strain, modification or exposure to extremes in temperature or humidity.
2. Improper repair or maintenance by any person who is not a service representative of a retail outlet authorized by Yamaha to sell the product, an authorized service center, or an authorized service representative of Yamaha.
3. This warranty is applicable only to units sold by retailers authorized by Yamaha to sell these products in the U.S.A., the District of Columbia, and Puerto Rico. This warranty is not applicable in other possessions or territories of the U.S.A. or in any other country.

Please record the model and serial number of the product you have purchased in the spaces provided below.

Model _____ Serial # _____ Sales Slip # _____

Purchased from _____ Date _____
(Retailer)

YAMAHA CORPORATION OF AMERICA
Electronic Service Division
6600 Orangethorpe Avenue
Buena Park, CA 90620

KEEP THIS DOCUMENT FOR YOUR RECORDS. DO NOT MAIL!

For details of products, please contact your nearest Yamaha or the authorized distributor listed below.

Pour plus de détails sur les produits, veuillez-vous adresser à Yamaha ou au distributeur le plus proche de vous figurant dans la liste suivante.

Die Einzelheiten zu Produkten sind bei Ihrer unten aufgeführten Niederlassung und bei Yamaha Vertragshändlern in den jeweiligen Bestimmungsländern erhältlich.

Para detalles sobre productos, contacte su tienda Yamaha más cercana o el distribuidor autorizado que se lista debajo.

NORTH AMERICA

CANADA

Yamaha Canada Music Ltd.
135 Milner Avenue, Scarborough, Ontario,
M1S 3R1, Canada
Tel: 416-298-1311

U.S.A.

Yamaha Corporation of America
6600 Orangethorpe Ave., Buena Park, Calif. 90620,
U.S.A.
Tel: 714-522-9011

CENTRAL & SOUTH AMERICA

MEXICO

**Yamaha de Mexico S.A. De C.V.,
Departamento de ventas**
Javier Rojo Gomez No.1149, Col. Gpe Del
Moral, Deleg. Iztapalapa, 09300 Mexico, D.F.
Tel: 686-00-33

BRAZIL

Yamaha Musical do Brasil LTDA.
Av. Rebouças 2636, São Paulo, Brasil
Tel: 011-853-1377

ARGENTINA

Yamaha Music Argentina S.A.
Viamonte 1145 Piso2-B 1053,
Buenos Aires, Argentina
Tel: 1-371-7021

PANAMA AND OTHER LATIN AMERICAN COUNTRIES/ CARIBBEAN COUNTRIES

Yamaha de Panama S.A.
Torre Banco General, Piso 7, Urbanización Marbella,
Calle 47 y Aquilino de la Guardia,
Ciudad de Panamá, Panamá
Tel: 507-269-5311

EUROPE

THE UNITED KINGDOM

Yamaha-Kemble Music (U.K.) Ltd.
Sherbourne Drive, Tilbrook, Milton Keynes,
MK7 8BL, England
Tel: 01908-366700

IRELAND

Danfay Ltd.
61D, Sallynoggin Road, Dun Laoghaire, Co. Dublin
Tel: 01-2859177

GERMANY/SWITZERLAND

Yamaha Europa GmbH.
Siemensstraße 22-34, 25462 Rellingen,
F.R. of Germany
Tel: 04101-3030

AUSTRIA

Yamaha Music Austria
Schleiergasse 20, A-1100 Wien Austria
Tel: 01-60203900

THE NETHERLANDS

Yamaha Music Nederland
Kanaalweg 18G, 3526KL, Utrecht, The Netherlands
Tel: 030-2828411

BELGIUM

Yamaha Music Belgium
Keiberg Imperiastraat 8, 1930 Zaventem, Belgium
Tel: 02-7258220

FRANCE

**Yamaha Musique France,
Division Claviers**
BP 70-77312 Marne-la-Vallée Cedex 2, France
Tel: 01-64-61-4000

ITALY

**Yamaha Musica Italia S.P.A.,
Home Keyboard Division**
Viale Italia 88, 20020 Lainate (Milano), Italy
Tel: 02-935-771

SPAIN/PORTUGAL

Yamaha-Hazen Electronica Musical, S.A.
Jorge Juan 30, 28001, Madrid, Spain
Tel: 91-577-7270

GREECE

Philippe Nakas S.A.
Navarinou Street 13, P.Code 10680, Athens, Greece
Tel: 01-364-7111

SWEDEN

Yamaha Scandinavia AB
J. A. Wettergrens Gata 1
Box 30053
S-400 43 Göteborg, Sweden
Tel: 031 89 34 00

DENMARK

YS Copenhagen Liaison Office
Generatorvej 8B
DK-2730 Herlev, Denmark
Tel: 44 92 49 00

FINLAND

F-Musiikki Oy
Kluuvikatu 6, P.O. Box 260,
SF-00101 Helsinki, Finland
Tel: 09 618511

NORWAY

Norsk filial av Yamaha Scandinavia AB
Grini Næringspark 1
N-1345 Østerås, Norway
Tel: 67 16 77 70

ICELAND

Skeifan HF
Skeifan 17 P.O. Box 8120
IS-128 Reykjavik, Iceland
Tel: 525 5000

OTHER EUROPEAN COUNTRIES

Yamaha Europa GmbH.
Siemensstraße 22-34, 25462 Rellingen,
F.R. of Germany
Tel: 04101-3030

AFRICA

**Yamaha Corporation,
International Marketing Division**
Nakazawa-cho 10-1, Hamamatsu, Japan 430-8650
Tel: 053-460-2312

MIDDLE EAST

TURKEY/CYPRUS

Yamaha Europa GmbH.
Siemensstraße 22-34, 25462 Rellingen,
F.R. of Germany
Tel: 04101-3030

OTHER COUNTRIES

Yamaha Music Gulf FZE
LB21-128 Jebel Ali Freezone
P.O.Box 17328, Dubai, U.A.E.
Tel: 971-4-81-5868

ASIA

HONG KONG

Tom Lee Music Co., Ltd.
11/F., Silvercord Tower 1, 30 Canton Road,
Tsimshtsui, Kowloon, Hong Kong
Tel: 2737-7688

INDONESIA

**PT. Yamaha Music Indonesia (Distributor)
PT. Nusantik**
Gedung Yamaha Music Center, Jalan Jend. Gatot
Subroto Kav. 4, Jakarta 12930, Indonesia
Tel: 21-520-2577

KOREA

Cosmos Corporation
1461-9, Seocho Dong, Seocho Gu, Seoul, Korea
Tel: 02-3486-0011

MALAYSIA

Yamaha Music Malaysia, Sdn., Bhd.
Lot 8, Jalan Perbandaran, 47301 Kelana Jaya,
Petaling Jaya, Selangor, Malaysia
Tel: 3-703-0900

PHILIPPINES

Yupangco Music Corporation
339 Gil J. Puyat Avenue, P.O. Box 885 MCPO,
Makati, Metro Manila, Philippines
Tel: 819-7551

SINGAPORE

Yamaha Music Asia Pte., Ltd.
11 Ubi Road #06-00, Meiban Industrial Building,
Singapore
Tel: 65-747-4374

TAIWAN

Yamaha KHS Music Co., Ltd.
10F, 150, Tun-Hwa Northroad,
Taipei, Taiwan, R.O.C.
Tel: 02-2713-8999

THAILAND

Siam Music Yamaha Co., Ltd.
121/60-61 RS Tower 17th Floor,
Ratchadaphisek RD., Dindaeng,
Bangkok 10320, Thailand
Tel: 02-641-2951

THE PEOPLE'S REPUBLIC OF CHINA AND OTHER ASIAN COUNTRIES

**Yamaha Corporation,
International Marketing Division**
Nakazawa-cho 10-1, Hamamatsu, Japan 430-8650
Tel: 053-460-2317

OCEANIA

AUSTRALIA

Yamaha Music Australia Pty. Ltd.
17-33 Market Street, South Melbourne, Vic. 3205,
Australia
Tel: 3-699-2388

NEW ZEALAND

Music Houses of N.Z. Ltd.
146/148 Captain Springs Road, Te Papapa,
Auckland, New Zealand
Tel: 9-634-0099

COUNTRIES AND TRUST TERRITORIES IN PACIFIC OCEAN

**Yamaha Corporation,
International Marketing Group**
Nakazawa-cho 10-1, Hamamatsu, Japan 430-8650
Tel: 053-460-2312

HEAD OFFICE Yamaha Corporation, Electronic Musical Instrument Division
Nakazawa-cho 10-1, Hamamatsu, Japan 430-8650
Tel: 053-460-3273

