

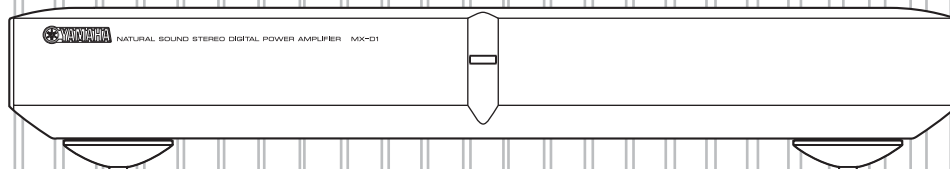



# MX-D1

## STEREO POWER AMPLIFIER



**OWNER'S MANUAL**

# IMPORTANT SAFETY INSTRUCTIONS

	<b>CAUTION</b> RISK OF ELECTRIC SHOCK DO NOT OPEN	
<b>CAUTION: TO REDUCE THE RISK OF ELECTRIC SHOCK, DO NOT REMOVE COVER (OR BACK). NO USER-SERVICEABLE PARTS INSIDE. REFER SERVICING TO QUALIFIED SERVICE PERSONNEL.</b>		

• Explanation of Graphical Symbols

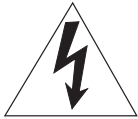

The lightning flash with arrowhead symbol, within an equilateral triangle, is intended to alert you to the presence of uninsulated “dangerous voltage” within the product’s enclosure that may be of sufficient magnitude to constitute a risk of electric shock to persons.



The exclamation point within an equilateral triangle is intended to alert you to the presence of important operating and maintenance (servicing) instructions in the literature accompanying the appliance.

**IMPORTANT!**

Please record the serial number of this unit in the space below.

Model:

Serial No.:

The serial number is located on the rear of the unit.

Retain this Owner’s Manual in a safe place for future reference.

- 1 Read these instructions.
- 2 Keep these instructions.
- 3 Heed all warnings.
- 4 Follow all instructions.
- 5 Do not use this apparatus near water.
- 6 Clean only with dry cloth.
- 7 Do not block any ventilation openings. Install in accordance with the manufacturer’s instructions.
- 8 Do not install near any heat sources such as radiators, heat registers, stoves, or other apparatus (including amplifiers) that produce heat.
- 9 Do not defeat the safety purpose of the polarized or grounding-type plug. A polarized plug has two blades with one wider than the other. A grounding type plug has two blades and a third grounding prong. The wide blade or the third prong are provided for your safety. If the provided plug does not fit into your outlet, consult an electrician for replacement of the obsolete outlet.
- 10 Protect the power cord from being walked on or pinched particularly at plugs, convenience receptacles, and the point where they exit from the apparatus.
- 11 Only use attachments/accessories specified by the manufacturer.
- 12 Use only with the cart, stand, tripod, bracket, or table specified by the manufacturer, or sold with the apparatus. When a cart is used, use caution when moving the cart/apparatus combination to avoid injury from tip-over. 
- 13 Unplug this apparatus during lightning storms or when unused for long periods of time.
- 14 Refer all servicing to qualified service personnel. Servicing is required when the apparatus has been damaged in any way, such as power-supply cord or plug is damaged, liquid has been spilled or objects have fallen into the apparatus, the apparatus has been exposed to rain or moisture, does not operate normally, or has been dropped.

## FCC INFORMATION (for US customers)

### 1. IMPORTANT NOTICE: DO NOT MODIFY THIS UNIT!

This product, when installed as indicated in the instructions contained in this manual, meets FCC requirements. Modifications not expressly approved by Yamaha may void your authority, granted by the FCC, to use the product.

### 2. IMPORTANT:

When connecting this product to accessories and/or another product use only high quality shielded cables. Cable/s supplied with this product MUST be used. Follow all installation instructions. Failure to follow instructions could void your FCC authorization to use this product in the USA.

### 3. NOTE:

This product has been tested and found to comply with the requirements listed in FCC Regulations, Part 15 for Class "B" digital devices. Compliance with these requirements provides a reasonable level of assurance that your use of this product in a residential environment will not result in harmful interference with other electronic devices.

This equipment generates/uses radio frequencies and, if not installed and used according to the instructions found in the users manual, may cause interference harmful to the operation of other electronic devices.

Compliance with FCC regulations does not guarantee that interference will not occur in all installations. If this product is found to be the source of interference, which can be determined by turning the unit "OFF" and "ON", please try to eliminate the problem by using one of the following measures:

Relocate either this product or the device that is being affected by the interference.

Utilize power outlets that are on different branch (circuit breaker or fuse) circuits or install AC line filter/s.

In the case of radio or TV interference, relocate/reorient the antenna. If the antenna lead-in is 300 ohm ribbon lead, change the lead-in to coaxial type cable.

If these corrective measures do not produce satisfactory results, please contact the local retailer authorized to distribute this type of product. If you can not locate the appropriate retailer, please contact Yamaha Electronics Corp., U.S.A. 6660 Orangethorpe Ave, Buena Park, CA 90620.

The above statements apply ONLY to those products distributed by Yamaha Corporation of America or its subsidiaries.

## We Want You Listening For A Lifetime

YAMAHA and the Electronic Industries Association's Consumer Electronics Group want you to get the most out of your equipment by playing it at a safe level. One that lets the sound come through loud and clear without annoying blaring or distortion – and, most importantly, without affecting your sensitive hearing. Since hearing damage from loud sounds is often undetectable until it is too late, YAMAHA and the Electronic Industries Association's Consumer Electronics Group recommend you to avoid prolonged exposure from excessive volume levels.



# CAUTION: READ THIS BEFORE OPERATING THIS UNIT

- To assure the finest performance, please read this manual carefully. Keep it in a safe place for future reference.
- Install this unit in a well ventilated, cool, dry, clean place – away from direct sunlight, heat sources, vibration, dust, moisture, and/or cold. Avoid ventilation space of at least 30 cm on the top, 20 cm on the left and right, and 10 cm on the back of this unit.
- Locate this unit away from other electrical appliances, motors, or transformers to avoid humming sounds.
- Do not expose this unit to sudden temperature changes from cold to hot, and do not locate this unit in an environment with high humidity (i.e. a room with a humidifier) to prevent condensation inside this unit, which may cause an electrical shock, fire, damage to this unit, and/or personal injury.
- Avoid installing this unit where foreign object may fall onto this unit and/or this unit may be exposed to liquid dripping or splashing. On the top of this unit, do not place:
  - Other components, as they may cause damage and/or discoloration on the surface of this unit.
  - Burning objects (i.e. candles), as they may cause fire, damage to this unit, and/or personal injury.
  - Containers with liquid in them, as they may fall and liquid may cause electrical shock to the user and/or damage to this unit.
- Do not cover the top panel of this unit with a newspaper, tablecloth, curtain, etc. in order not to obstruct heat radiation. If the temperature inside this unit rises, it may cause fire, damage to this unit, and/or personal injury.
- Do not plug in this unit to a wall outlet until all connections are complete.
- Do not operate this unit upside-down. It may overheat, possibly causing damage.
- Do not use force on switches, knobs and/or cords.
- When disconnecting the power cord from the wall outlet, grasp the plug; do not pull the cord.
- Do not clean this unit with chemical solvents; this might damage the finish. Use a clean, dry cloth.
- Only voltage specified on this unit must be used. Using this unit with a higher voltage than specified is dangerous and may cause fire, damage to this unit, and/or personal injury. YAMAHA will not be held responsible for any damage resulting from use of this unit with a voltage other than specified.
- To prevent damage by lightning, disconnect the power cord from the wall outlet during an electrical storm.
- Do not attempt to modify or fix this unit. Contact qualified YAMAHA service personnel when any service is needed. The cabinet should never be opened for any reasons.
- When not planning to use this unit for long periods of time (i.e. vacation), disconnect the AC power plug from the wall outlet.
- Be sure to read the “TROUBLESHOOTING” section on common operating errors before concluding that this unit is faulty.
- Before moving this unit, first check that there is no disc in the disc tray. Finally, press the STANDBY/ON switch to turn off this unit, and disconnect the AC power plug from the wall outlet.

This unit is not disconnected from the AC power source as long as it is connected to the wall outlet, even if this unit itself is turned off. This state is called standby mode. In this state, this unit is designed to consume a very small quantity of power.

## WARNING

TO REDUCE THE RISK OF FIRE OR ELECTRIC SHOCK, DO NOT EXPOSE THIS UNIT TO RAIN OR MOISTURE.

## SPECIAL INSTRUCTIONS FOR U.K. MODEL

### IMPORTANT

The wires in this mains lead are coloured in accordance with the following code:

GREEN-and-YELLOW: Earth

BLUE: Neutral

BROWN: Live

As the colours of the wires in the mains lead of this apparatus may not correspond with the coloured markings identifying the terminals in your plug proceed as follows: The wire which is coloured GREEN-and-YELLOW must be connected to the terminal in the plug which is marked by the letter E or by the safety earth symbol  or coloured GREEN or GREEN-and -YELLOW. The wire which is coloured BLUE must be connected to the terminal which is marked with the letter N or coloured BLACK. The wire which is coloured BROWN must be connected to the terminal which is marked with the letter L or coloured RED.

### For U.K. customers

If the socket outlets in the home are not suitable for the plug supplied with this appliance, it should be cut off and an appropriate 3 pin plug fitted. For details, refer to the instructions described above.

**Note:** The plug severed from the mains lead must be destroyed, as a plug with bared flexible cord is hazardous if engaged in a live socket outlet.

### For Canadian Customers

To prevent electric shock, match wide blade of plug to wide slot and fully insert.

This Class B digital apparatus complies with Canadian ICES-003.

# FEATURES

---

- 500 W + 500 W max. (4 to 8  $\Omega$ ) high-power, high-performance digital stereo power amp
- 120 dB dynamic range
- Yamaha-designed LSI chips used in the digital-modulation and power-drive circuits
- Active Power Control System ensures optimum performance under any load (4 to 8  $\Omega$ )
- Constant Gain PLL Modulator provides a fixed, open-loop gain that is unaffected by supply voltage fluctuations
- 0.003% THD (Total Harmonic Distortion)
- 100 dB channel separation
- Yamaha's own high-efficiency, low-noise resonant-type switching power supply
- WBT (German) connectors used for inputs (RCA/phono) and speaker outputs
- Futuristic, super-thin design

# CONTENTS

---

FEATURES .....	1
CONTROLS AND FUNCTIONS.....	2
CONNECTIONS.....	4
BLOCK DIAGRAMS .....	6
TROUBLESHOOTING .....	8
SPECIFICATIONS.....	9

# CONTROLS AND FUNCTIONS

## Front Panel

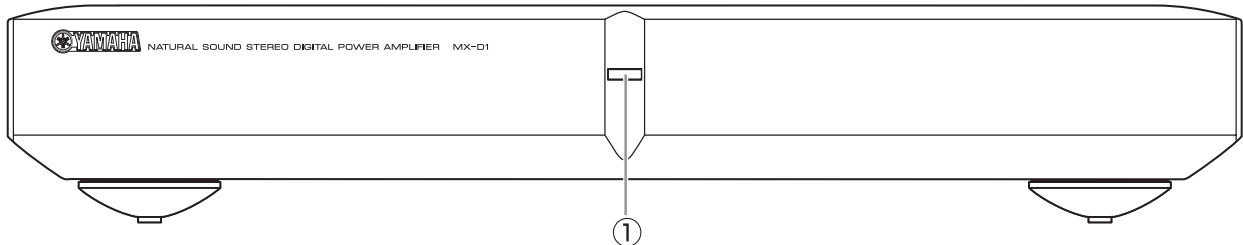

## Rear Panel

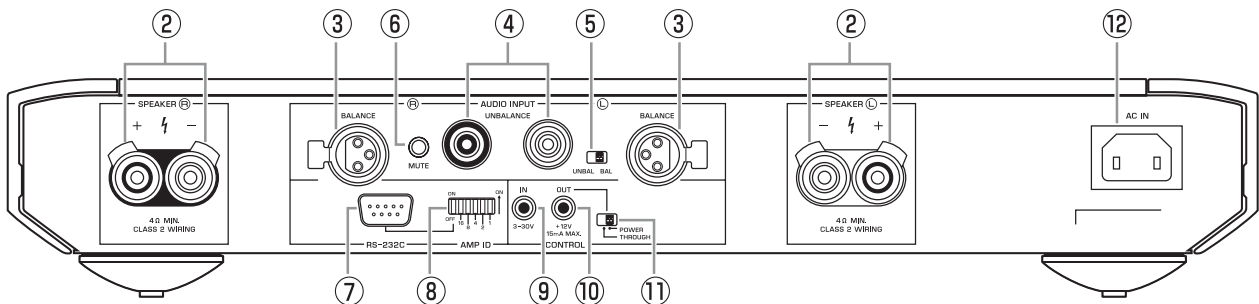

This mark indicates a dangerous electrically live terminal. When connecting to this terminal, it is necessary either to have “a person who have received appropriate guidance on handling” make the connection or to use a cable that have been manufactured in such a way that the connection can be made simply and without problem.

---

① **STANDBY/ON switch/indicator**

This switch is used to set the MX-D1 to on or standby. A small amount of power is used in standby mode. When the MX-D1 is turned on, this indicator lights blue and the MX-D1 is ready for use.

If a fault is detected, the MX-D1's protection system activates and this indicator lights red. If this happens, set the MX-D1 to standby mode immediately.

---

② **SPEAKER terminals**

These terminals are for connecting your speakers. They provide a reliable connection even with really thick cables. Be sure to connect the left and right channels, and the speaker polarities (+/-) correctly. You can connect speakers with impedance of between 4 to 8 ohms.

③ **BALANCE jacks**

If your source component has balanced XLR output jacks, connect them to these jacks using XLR cables.

④ **UNBALANCE jacks**

If your source component has unbalanced RCA/phono jacks (labeled "AUDIO OUTPUT" on the YPC-1), connect them to these jacks using an audio pin cable.

⑤ **UNBAL/BAL switch**

With this switch you can select the BALANCE jacks or the UNBALANCE jacks.

⑥ **MUTE button**

You can temporarily mute the output from the MX-D1 by holding down this button. If you need to change any input connections while the MX-D1 is still on, you can protect your speakers against sudden loud noises, thumps, and clicks by keeping this button pressed while making such changes.

⑦ **RS-232C terminal**

This terminal is for servicing purposes only.

⑧ **AMP ID switch**

This switch is for servicing purposes only.

⑨ **CONTROL IN jack**

The MX-D1 can be turned on or off via this jack. The control range is +3 to +30 volts.

⑩ **CONTROL OUT jack**

When the MX-D1 is turned on, this jack outputs +12 volts. The maximum current is 15 mA.

⑫ **POWER/THROUGH switch**

This switch determines the operation of the CONTROL IN/OUT jacks. When using the MX-D1 as the master component, set this switch to "POWER". When using it as a slave component, set it to "THROUGH".

⑬ **AC IN connector**

Connect the supplied AC power cable here.

# CONNECTIONS

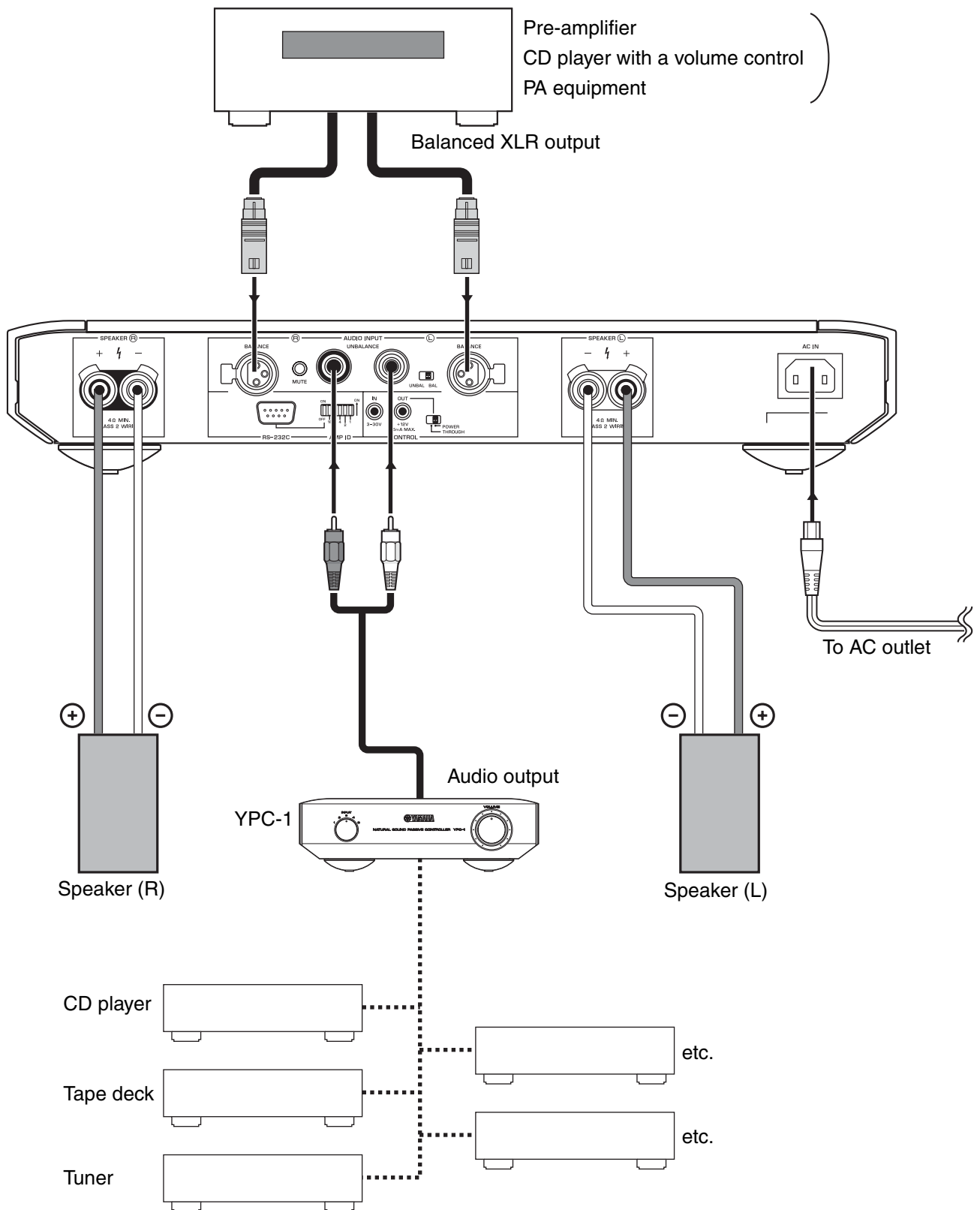



## Connecting Your Speakers

Speaker cables typically consist of two insulated conductors. To ensure that the speakers are connected with the correct polarity (+/-), the insulation on one of the conductors is a different color or is marked with a line.

### ■ Preparing the speaker cables

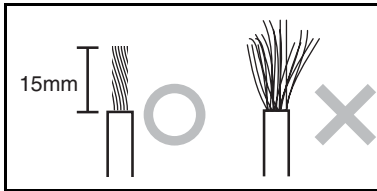

1. Strip about 15 mm of insulation from the ends of the speaker cables.
2. Twist the bare wires tightly.  
To prevent a short circuit, make sure the bare wires are twisted tightly.

### ■ Connecting the speaker cables

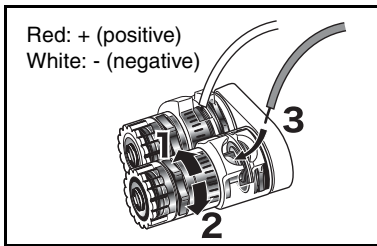

1. Unscrew the SPEAKER terminals.
2. Insert the twisted bare wires into the holes on the SPEAKER terminals.
3. Screw the SPEAKER terminals tight.

## Connecting Your Source Components

### ■ Connecting to the BALANCE jacks

Connect your component with the balanced XLR output jacks.

The pin assignments for these jacks are shown below. Refer to the owner's manual of your component and verify that its output jacks are compatible with the pin assignments for these jacks.

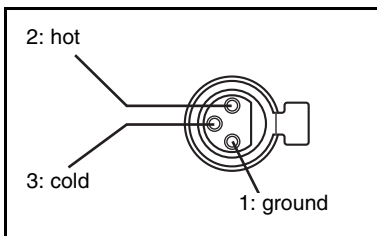

When connecting, match the pins and insert the connector of the XLR cable until you hear a “click.”

When disconnecting, pull out the XLR cable while holding down the lever of the BALANCE jack.

When using this balanced connection, set the UNBAL/BAL switch to “BAL.”

### ■ Connecting to the UNBALANCE jacks

Connect your component with the unbalanced RCA/phono output jacks.

When using this unbalanced connection, set the UNBAL/BAL switch to “UNBAL.”

#### Caution

Note that if you input signals to the BALANCE jacks and UNBALANCE jacks at the same, cross talk may occur between these input jacks.

## Connecting the AC Power Cable

Plug the AC power cable into the AC IN connector when all connections are complete, and then plug in the AC power cable to the AC outlet.

# BLOCK DIAGRAMS

The MX-D1 is a high-power, high-performance PWM (Pulse Width Modulation) digital stereo power amp, utilizing Yamaha's latest digital power amplifier and switching power supply technologies. The following block diagrams show the amplifier and power supply circuits.

## Amplifier Block Diagram

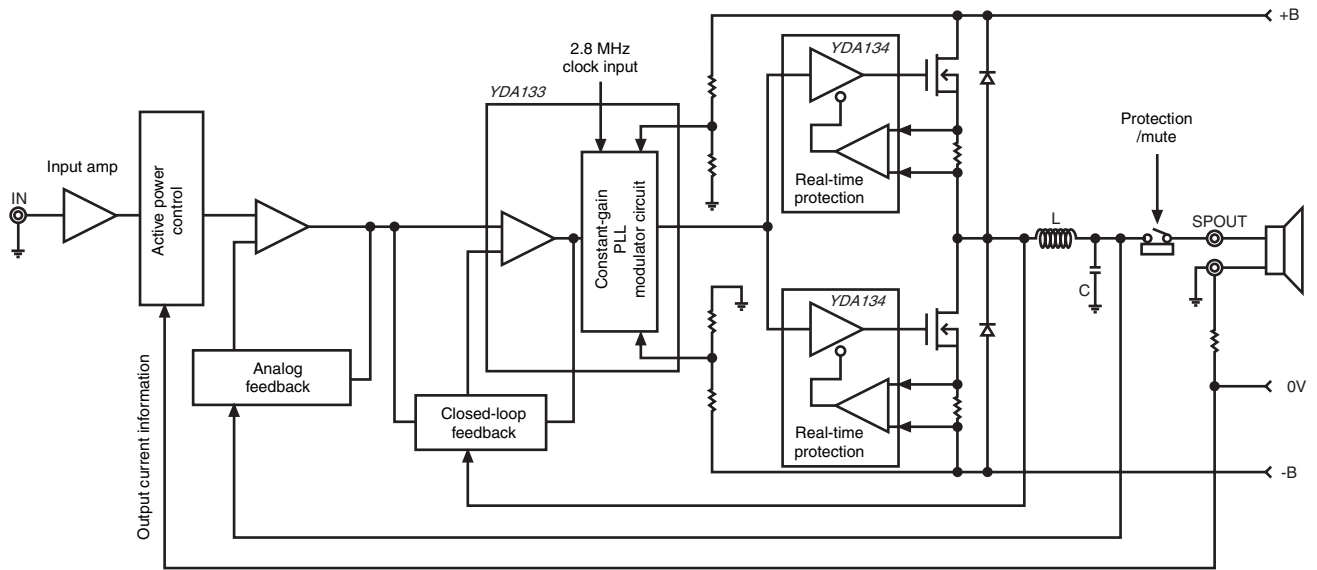

## Power Supply Block Diagram

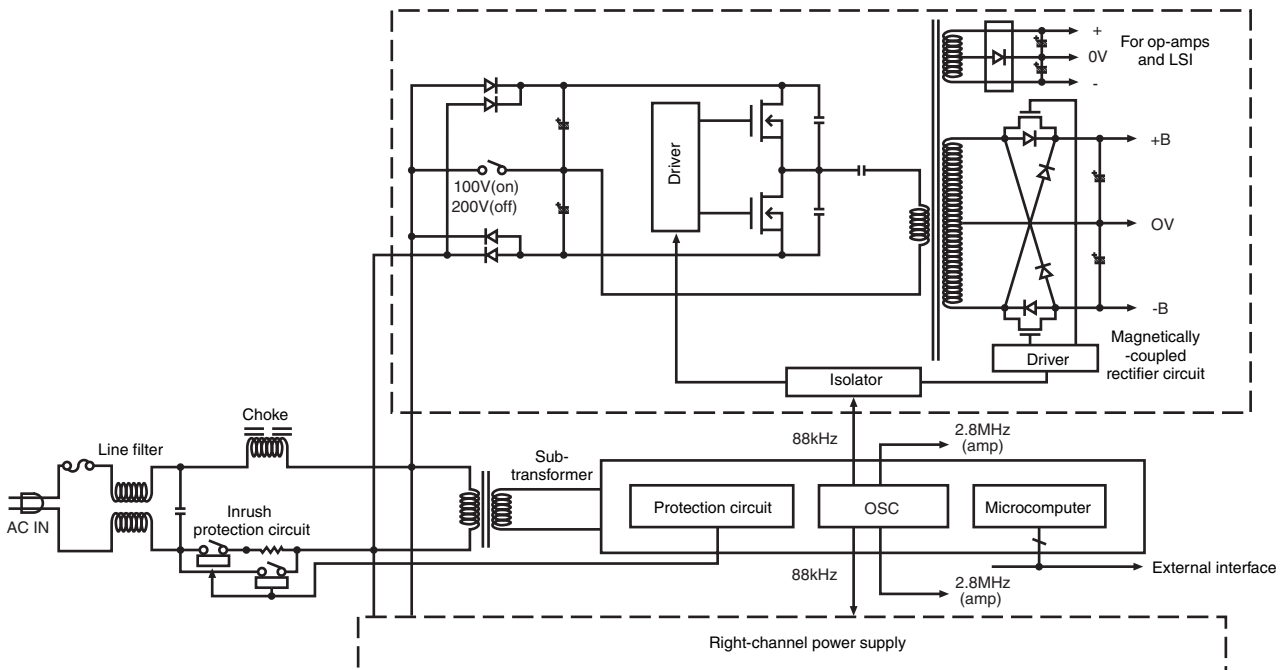

PWM (Pulse Width Modulation), which theoretically produces zero quantization noise, a dynamic range that is dependent only on circuit technology, and feedback all combine to make the MX-D1 a superb high-performance power amp.

In addition, the Yamaha high-performance, high-speed analog and digital LSI chips are designed to optimize the performance of the modulator and MOSFET drive circuits that form the heart of the MX-D1.

---

### ■ Active power control system

By continuously monitoring the amp's output current and controlling the maximum continuous output power and instantaneous dynamic power, the MX-D1 always delivers maximum performance with any load impedance between 2 to 8 ohms.

### ■ Constant-gain PLL modulator circuit

With a conventional digital power amp, the output is adversely affected by fluctuations in power supply voltage as the current demands of the amp change. The MX-D1's modulation circuit, consisting of a PLL (Phase Locked Loop) and modulation circuit, provides a radical solution to this problem.

In response to power supply voltage fluctuations, the constant-gain PLL modulator circuit produces a pulse-width modulated waveform by modulating the input signal at a suitable rate. In this way, linearity is maintained and the open-loop gain is fixed, providing stable feedback.

### ■ Feedback

Digital output pulses are fed back in a closed-loop feedback circuit, which improves the performance of the modulator circuit and the linearity of the output stage, providing very low distortion and a wide dynamic range.

In addition, an analog output signal taken from after the LC output filter is fed back to ensure a high damping factor and a wide frequency response that is unaffected by the load impedance.

---

### ■ Protection system

The protection system, which guarantees safe operation, includes a super-fast current detection circuit that can measure the current of a single pulse. It also includes safe operating sequential logic, DC detection, and over-current protection.

### ■ Switching power supply

Independent, high-efficiency, low noise resonant-type switching power supplies, developed by Yamaha, are used for the left and right channels.

In addition, the secondary rectifier circuit has a magnetically coupled rectifier, which resolves issues normally associated with conventional SEPP (single-ended push-pull) digital amps and allows the MX-D1 to always maintain perfect symmetry between the positive and negative power supply rails regardless of the direction of the output current.

# TROUBLESHOOTING

If your MX-D1 does not appear to be working properly, look up the symptoms in the following table. If the symptoms persist, or are not listed, set the MX-D1 to standby mode, disconnect the AC power cable from the AC outlet, and then contact the nearest Yamaha dealer.

Symptom	Cause	Remedy
Cannot turn on the MX-D1?	The AC power cable is not connected properly.	Make sure the AC power cable is connected properly to the AC IN connector and a suitable AC outlet.
	The component connected to the CONTROL IN jack is not turned on.	Turn on the component that is connected to the CONTROL IN jack.
There is no sound?	The MX-D1 is not connected properly.	Check all connections and correct as necessary.
	The source component connected to the MX-D1's input jacks is not set correctly.	Refer to the owner's manual of the source component.
	The wrong inputs are selected on the MX-D1.	Use the UNBAL/BAL switch to select the correct inputs.
	The MX-D1's protection system is active.	Check the speaker cables for short circuits and correct as necessary.
A hum can be heard?	The audio pin cable connected to the UNBALANCE jacks is not fully inserted.	Fully insert the audio pin cable.
The output sounds unnatural, has a limited bass range, and poor stereo image?	The speaker polarity is wrong.	Check the polarity of the speaker connections and correct as necessary.

# SPECIFICATIONS

Maximum output..... 500 W + 500 W (4 to 8  $\Omega$ )  
Dynamic power..... 1000 W + 1000 W (4 to 8  $\Omega$ )  
Damping factor..... or more 200  
Total harmonic distortion..... or less 0.003% (1 kHz)  
Dynamic range..... or more 120 dB  
(IHF-A, LPF: 20 kHz)  
Frequency response..... 1 Hz to 100 kHz ( $\pm 3$  dB)  
20 Hz to 20 kHz ( $\pm 0.5$  dB)  
Channel separation..... or more 100 dB  
(5.1 k $\Omega$  terminated, 1 kHz)

## Input jacks

UNBALANCE..... Unbalanced 1.3 V/25 k $\Omega$   
BALANCE ..... Balanced XLR 1.3 V  
Pin 2 hot

## Output jacks

SPEAKER..... Supports standard speaker cables,  
banana plugs, and Y plugs

Modulation ..... PWM (Pulse Width Modulation)

Output ..... SEPP (Single-Ended Push-Pull)  
Power source..... Resonant-type switching power supply  
(frequency: 88 kHz)

## CONTROL OUT

Power on ..... +12 V (Max. 15 mA)  
Power off ..... 0 V

## Power supply

U.S.A and Canada models ..... AC 120 V, 60 Hz  
Australia model ..... AC 240 V, 50 Hz  
U.K. and Europe models ..... AC 230 V, 50 Hz  
China and Korea models ..... AC 220 V, 60 Hz  
Asia model ..... AC 110/120/220/240 V, 50/60 Hz  
Power consumption ..... 350 W  
Power consumption in standby mode..... or less 0.1 W  
Dimensions (W x H x D)..... 435 x 75 x 437 mm  
(17-1/8" x 2-7/8" x 17-3/16")  
Weight ..... 10.4 kg (22 lbs. 15 oz)

## Accessory

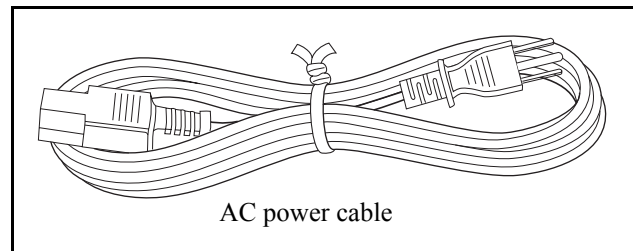

Specifications are subject to change without notice.



---

YAMAHA ELECTRONICS CORPORATION, USA 6660 ORANGETHORPE AVE., BUENA PARK, CALIF. 90620, U.S.A.  
YAMAHA CANADA MUSIC LTD. 135 MILNER AVE., SCARBOROUGH, ONTARIO M1S 3R1, CANADA  
YAMAHA ELECTRONIK EUROPA G.m.b.H. SIEMENSSTR. 22-34, 25462 RELLINGEN BEI HAMBURG, F.R. OF GERMANY  
YAMAHA ELECTRONIQUE FRANCE S.A. RUE AMBROISE CROIZAT BP70 CROISSY-BEAUBOURG 77312 MARNE-LA-VALLÉE CEDEX02, FRANCE  
YAMAHA ELECTRONICS (UK) LTD. YAMAHA HOUSE, 200 RICKMANSWORTH ROAD WATFORD, HERTS WD18 7GQ, ENGLAND  
YAMAHA SCANDINAVIA A.B. J A WETTERGRENS GATA 1, BOX 30053, 400 43 VÄSTRA FRÖLUNDA, SWEDEN  
YAMAHA MUSIC AUSTRALIA PTY, LTD. 17-33 MARKET ST., SOUTH MELBOURNE, 3205 VIC., AUSTRALIA

YAMAHA CORPORATION  
Printed in Japan UP WC01600