

YAMAHA YST-SW500

Active Servo Processing Subwoofer System

Built-in 120W Power Amplifier

2 Way Selectability for Connections

High Frequency Cut-off Point (HIGH CUT) Control

PHASE Switch

VOLUME/HIGH CUT/PHASE Adjustment Data Storing Capability

2 Types of Remote Control Signal Code for Controlling 2 Subwoofers

Thank you for selecting this YAMAHA Subwoofer System.



OWNER'S MANUAL

CONTENTS

Safety Instructions.....	2
Supplied Accessories.....	3
Features	4
Placement	4
Connections	5
Controls and Their Functions ...	8
Adjusting Volume Balance.....	10
Notes about the Remote	
Control Transmitter	13
Troubleshooting	13
Specifications	14
Active Servo Technology	14

IMPORTANT!

Please record the serial number of this unit in the space below.

Model:
Serial No.:

The serial number is located on the rear of the unit.
Retain this Owner's Manual in a safe place for future reference.

WARNING

TO REDUCE THE RISK OF FIRE OR ELECTRIC SHOCK, DO NOT EXPOSE THIS UNIT TO RAIN OR MOISTURE.

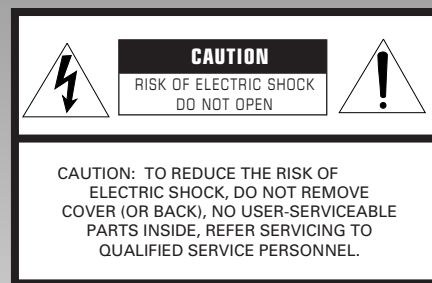

• Explanation of Graphical Symbols



The lightning flash with arrowhead symbol, within an equilateral triangle, is intended to alert you to the presence of uninsulated "dangerous voltage" within the product's enclosure that may be of sufficient magnitude to constitute a risk of electric shock to persons.



The exclamation point within an equilateral triangle is intended to alert you to the presence of important operating and maintenance (servicing) instructions in the literature accompanying the appliance.

SAFETY INSTRUCTIONS

- 1 Read Instructions – All the safety and operating instructions should be read before the unit is operated.
- 2 Retain Instructions – The safety and operating instructions should be retained for future reference.
- 3 Heed Warnings – All warnings on the unit and in the operating instructions should be adhered to.
- 4 Follow Instructions – All operating and other instructions should be followed.
- 5 Water and Moisture – The unit should not be used near water – for example, near a bathtub, washbowl, kitchen sink, laundry tub, in a wet basement, or near a swimming pool, etc.
- 6 Carts and Stands – The unit should be used only with a cart or stand that is recommended by the manufacturer.
- 6A A unit and cart combination should be moved with care. Quick stops, excessive force, and uneven surfaces may cause the unit and cart combination to overturn. 
- 7 Wall or Ceiling Mounting – The unit should be mounted to a wall or ceiling only as recommended by the manufacturer.
- 8 Ventilation – The unit should be situated so that its location or position does not interfere with its proper ventilation. For example, the unit should not be situated on a bed, sofa, rug, or similar surface, that may block the ventilation openings; or placed in a built-in installation, such as a bookcase or cabinet that may impede the flow of air through the ventilation openings.
- 9 Heat – The unit should be situated away from heat sources such as radiators, stoves, or other appliances that produce heat.
- 10 Power Sources – The unit should be connected to a power supply only of the type described in the operating instructions or as marked on the unit.
- 11 Power-Cord Protection – Power-supply cords should be routed so that they are not likely to be walked on or pinched by items placed upon or against them, paying particular attention to cords at plugs, convenience receptacles, and the point where they exit from the unit.
- 12 Cleaning – The unit should be cleaned only as recommended by the manufacturer.
- 13 Nonuse Periods – The power cord of the unit should be unplugged from the outlet when left unused for a long period of time.
- 14 Object and Liquid Entry – Care should be taken so that objects do not fall into and liquids are not spilled into the inside of the unit.
- 15 Damage Requiring Service – The unit should be serviced by qualified service personnel when:
 - A. The power-supply cord or the plug has been damaged; or
 - B. Objects have fallen, or liquid has been spilled into the unit; or
 - C. The unit has been exposed to rain; or
 - D. The unit does not appear to operate normally or exhibits a marked change in performance; or
 - E. The unit has been dropped, or the cabinet damaged.
- 16 Servicing – The user should not attempt to service the unit beyond those means described in the operating instructions. All other servicing should be referred to qualified service personnel.
- 17 Power Lines – An outdoor antenna should be located away from power lines.
- 18 Grounding or Polarization – Precautions should be taken so that the grounding or polarization is not defeated.

CAUTION: READ THIS BEFORE OPERATING YOUR UNIT

- 1 To assure the finest performance, please read this manual carefully. Keep it in a safe place for future reference.
- 2 Install this unit in a cool, dry, clean place – away from windows, heat sources, sources of excessive vibration, dust, moisture and cold. Avoid sources of humming (transformers, motors). To prevent fire or electrical shock, do not expose the unit to rain or water.
- 3 Never open the cabinet. If something drops into the set, contact your dealer.
- 4 Do not use force on switches, controls or connection wires. When moving the unit, first disconnect the power plug and the wires connected to other equipment. Never pull the wire itself.
- 5 Do not attempt to clean the unit with chemical solvents; this might damage the finish. Use a clean, dry cloth.
- 6 Be sure to read the “TROUBLESHOOTING” section regarding common operating errors before concluding that the unit is faulty.
- 7 When not planning to use this unit for long periods of time (ie., vacation, etc.), disconnect the AC power plug from the wall outlet.
- 8 To prevent lightning damage, disconnect the AC power plug when there is an electrical storm.
- 9 Since this unit has a built-in power amplifier, heat will radiate from the rear panel. Therefore, place the unit at least 10 cm (4 inches) away from the wall. Also, do not position with the rear panel facing down on the floor or other surface.
- 10 Super-bass frequencies reproduced by this unit may cause a turntable to generate a howling sound. In such a case, move this unit away from the turntable.
- 11 This unit features a magnetically shielded design, but there is still a chance that placing it too close to a TV set might impair picture color. Should this happen, move this unit away from the TV set.
- 12 This unit may be damaged if certain sounds are continuously output with high volume level. For example, if 20 Hz – 50 Hz sine waves from a test disc, bass sounds from electronic instruments, etc. are continuously output, or when the stylus of a turntable touches the surface of a disc, reduce the volume level to prevent this unit from being damaged.

FCC INFORMATION

1. IMPORTANT NOTICE : DO NOT MODIFY THIS UNIT!

This product, when installed as indicated in the instructions contained in this manual, meets FCC requirements. Modifications not expressly approved by Yamaha may void your authority, granted by the FCC, to use the product.

2. IMPORTANT :

When connecting this product to accessories and/or another product use only high quality shielded cables. Cable/s supplied with this product MUST be used. Follow all installation instructions. Failure to follow instructions could void your FCC authorization to use this product in the USA.

3. NOTE :

This product has been tested and found to comply with the requirements listed in FCC Regulations, Part 15 for Class "B" digital devices. Compliance with these requirements provides a reasonable level of assurance that your use of this product in a residential environment will not result in harmful interference with other electronic devices.

This equipment generates/uses radio frequencies and, if not installed and used according to the instructions found in the users manual, may cause interference harmful to the operation of other electronic devices.

Compliance with FCC regulations does not guarantee that interference will not occur in all installations. If this product is found to be the source of interference, which can be determined by turning the unit "OFF" and "ON", please try to eliminate the problem by using one of the following measures:

Relocate either this product or the device that is being affected by the interference.

Utilize power outlets that are on different branch (circuit breaker or fuse) circuits or install AC line filter/s.

In the case of radio or TV interference, relocate/reorient the antenna. If the antenna lead-in is 300 ohm ribbon lead, change the lead-in to coaxial type cable.

If these corrective measures do not produce satisfactory results, please contact the local retailer authorized to distribute this type of product. If you can not locate the appropriate retailer, please contact Yamaha Electronics Corp., U.S.A. 6660 Orangethorpe Ave, Buena Park, CA 90620.

The above statements apply ONLY to those products distributed by Yamaha Corporation of America or its subsidiaries.

We Want You Listening For A Lifetime

YAMAHA and the Electronic Industries Association's Consumer Electronics Group want you to get the most out of your equipment by playing it at a safe level. One that lets the sound come through loud and clear without annoying blaring or distortion – and, most importantly, without affecting your sensitive hearing. Since hearing damage from loud sounds is

often undetectable until it is too late, YAMAHA and the Electronic Industries Association's Consumer Electronics Group recommend you to avoid prolonged exposure from excessive volume levels.



SUPPLIED ACCESSORIES

After unpacking, check that the following parts are contained.

Remote Control Transmitter

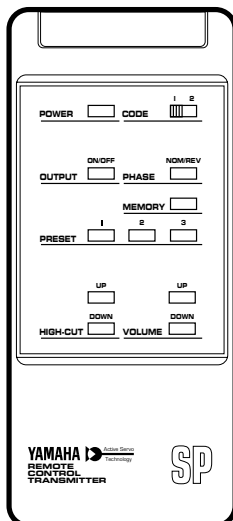

Batteries (size AA, R6, UM-3)

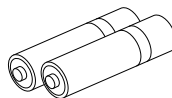

Speaker Cords

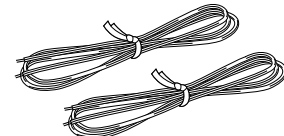

FEATURES

- This subwoofer system employs YAMAHA Active Servo Technology which YAMAHA developed for reproducing higher quality super-bass sound. (Refer to page 14 for details on Active Servo Technology.)
This unit does not only enhance bass frequency response of sound output in your audio system, but, by reproducing the bass frequencies, the subwoofer permits your existing amplifier and speakers to operate under less strenuous conditions, improving overall system performance.
- This unit can be added easily to your existing audio system by connecting to either the speaker terminals or the line output (pin jack) terminals of the amplifier.
- For the effective use of this unit, this unit's super-bass sound must be matched to the sounds on your main speakers. Therefore, this unit employs the continuously variable high frequency cut-off point (HIGH-CUT) control. Moreover, the PHASE switch allows you to select better sound quality according to the listening condition.
- As a utility function for using two subwoofers, this unit has two types of signal code for remote control. By selecting a different code for each subwoofer, you can operate two subwoofers individually with one remote control transmitter.

PLACEMENT

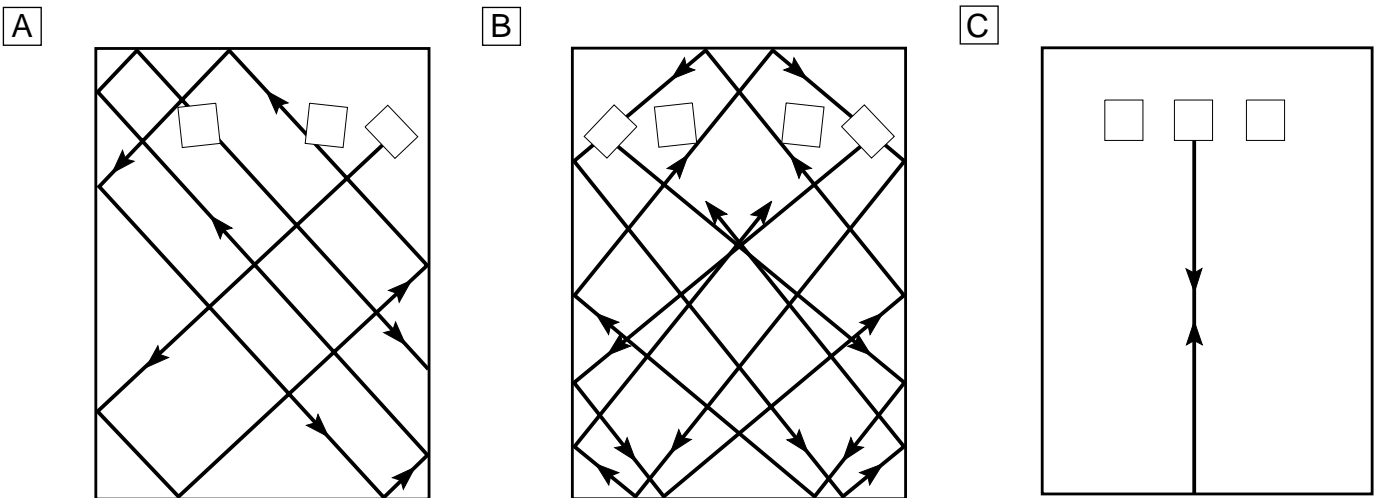

If using one subwoofer system, it is recommended to place it on the outside of either the right or the left main speaker. (See fig. **A**.) If using two systems, it is recommended to place them on the outside of each main speaker. (See fig. **B**.) The placement shown in fig. **C** is also possible, however, if the subwoofer system is placed directly facing the wall, the bass effect may die because the sound from it and the sound reflected by the wall will collide. To prevent this, face the subwoofer system obliquely to the wall as shown in fig. **A** or **B**.

One subwoofer system will have a good effect on your audio system, however, the use of two subwoofer systems is recommended to obtain more presence.

Note

There may be a case that you cannot obtain enough super-bass sounds from this unit when listening at the middle of the room. This is because the "standing waves" occur between two parallel walls and the bass sounds are canceled. In such a case, face the unit obliquely to the wall. It also may be necessary to break up the parallel surfaces by placing bookshelves etc. along the walls.

CONNECTIONS

- Before attempting to make any connections to or from this unit, be sure to first switch OFF the power to this unit and to any other components to which connections are being made.
- When making connections between this unit and other components, be sure all connections are made correctly and consistently, that is to say L (left) to L, R (right) to R, “+” to “+” and “-” to “-”.
- This unit can be connected to either the speaker terminals or the line output (pin jack) terminals of the amplifier. Choose one of the ways shown below according to your audio system. Also, refer to the owner’s manual for each component to be connected to this unit.

CONNECTING TO SPEAKER TERMINALS OF THE AMPLIFIER

- Disconnect your main speakers from the amplifier and connect them to this unit.
- To connect this unit to the amplifier, use the provided speaker cords.

If using one YST-SW500

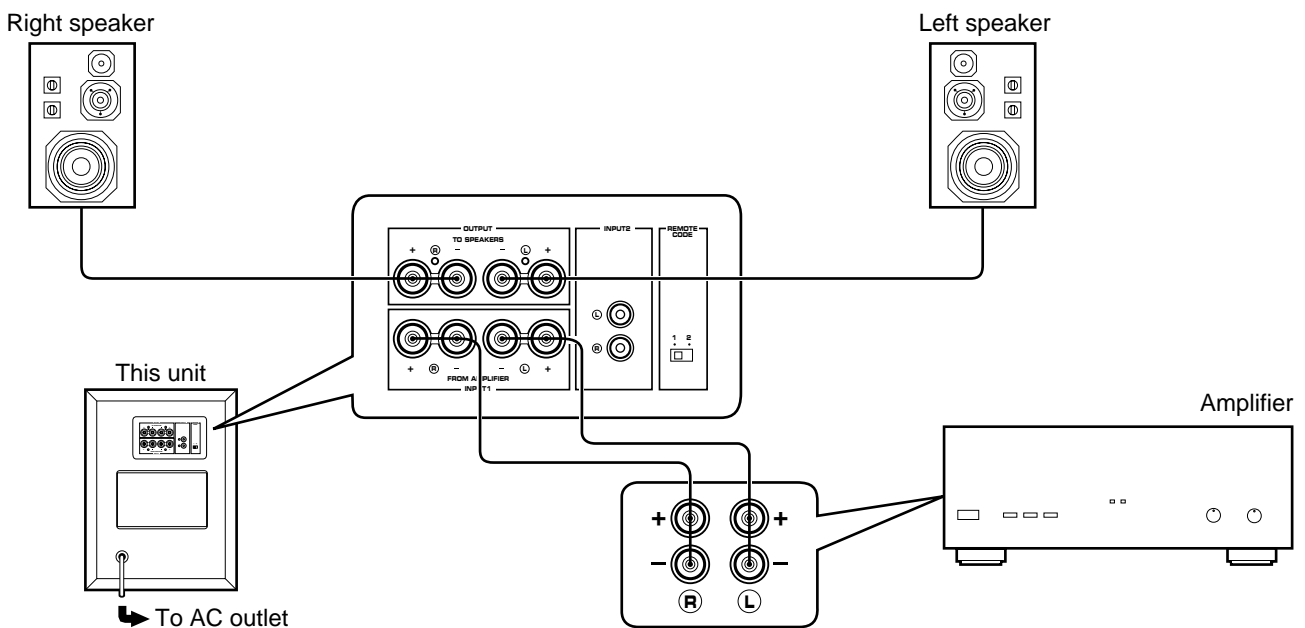

If using two YST-SW500s

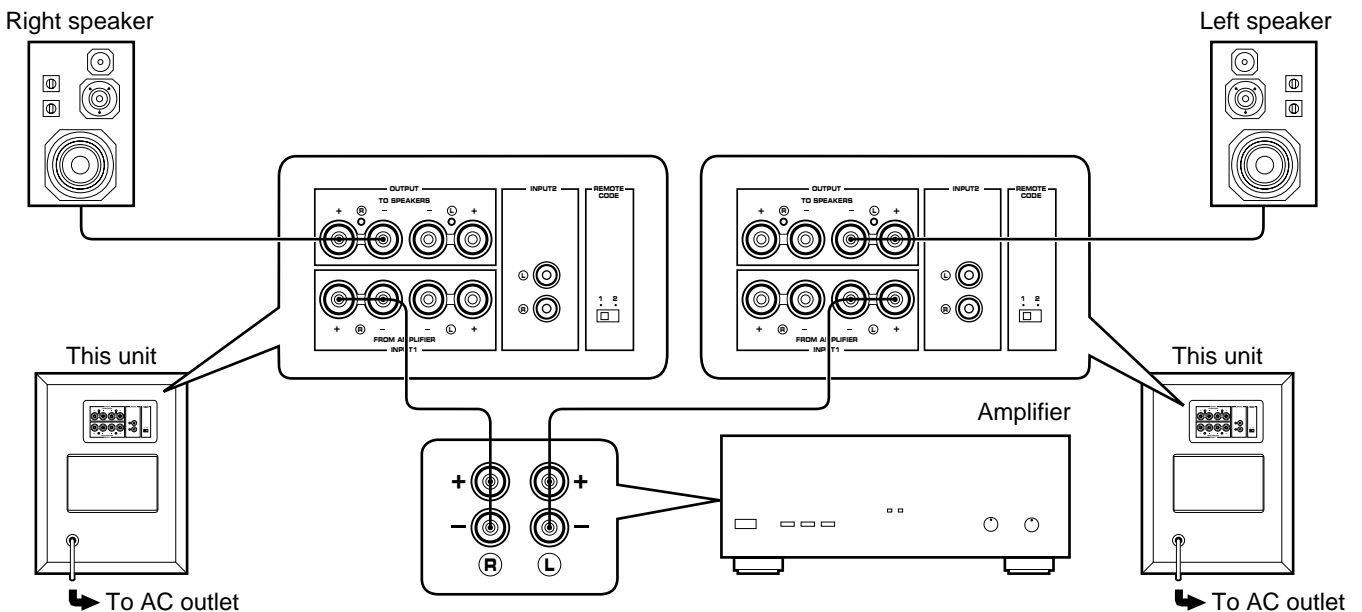

If your amplifier has two sets of speaker terminals

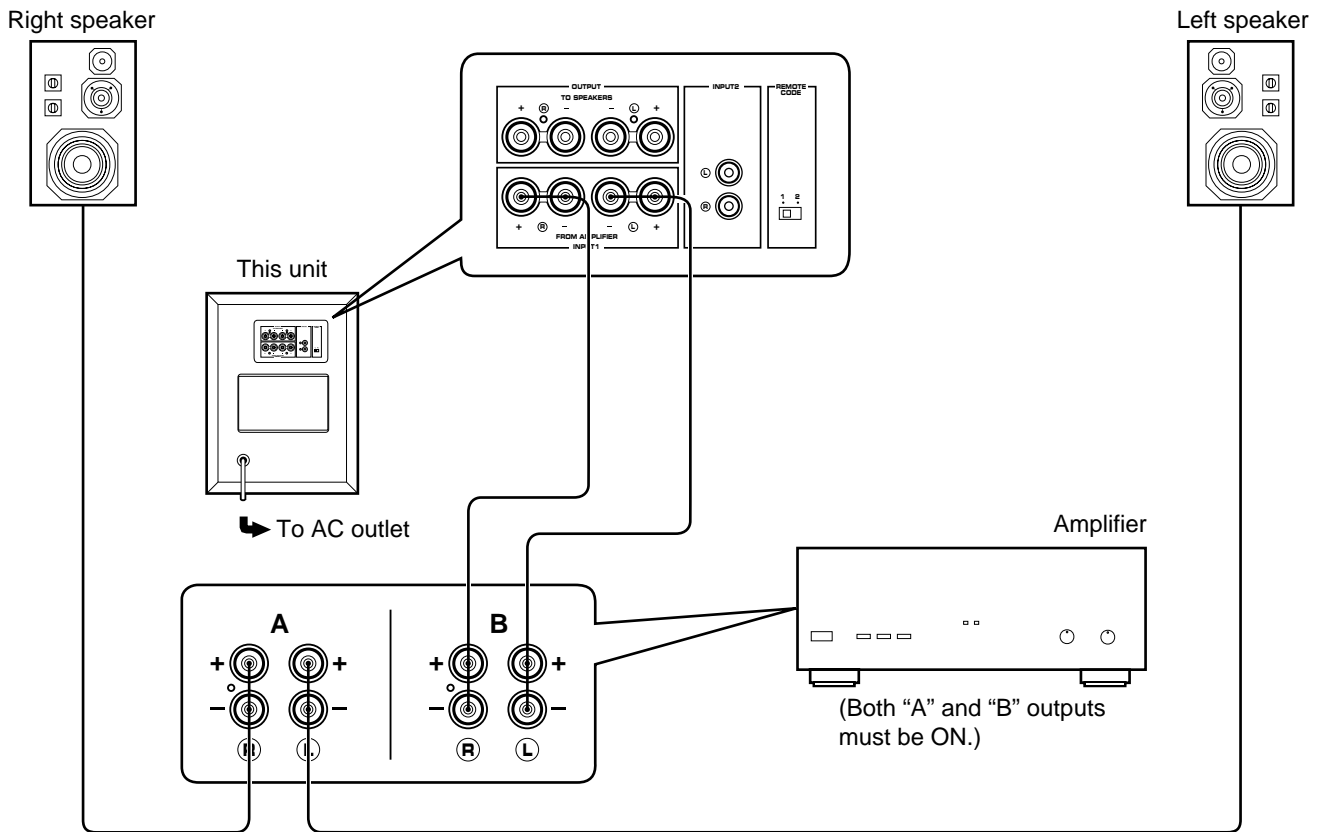

Connecting to this unit's OUTPUT/INPUT terminals

For connections, use speaker wires of the proper gauge, cut as short as possible. If the connections are faulty, no sound will be heard from the speakers. Make sure that the polarity of the speaker wires is correct, that is, + and - markings are observed. If these wires are reversed, the sound will be unnatural and will lack bass. **Do not let the bare speaker wires touch each other and do not let them touch the metal parts of this unit as this could damage this unit, your amplifier and/or speakers.**

* Banana Plug connections are also possible. Simply insert the Banana Plug connector into the corresponding terminal.

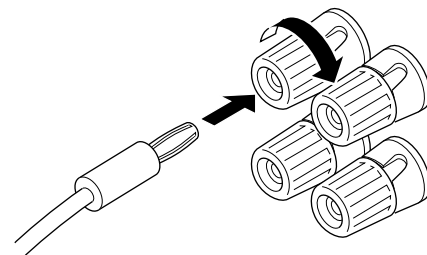

How to Connect:

Red: positive (+)
Black: negative (-)

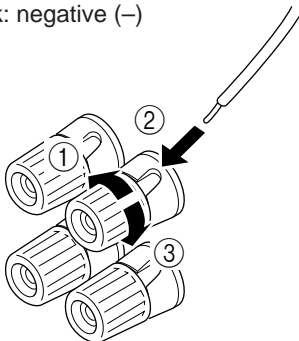

- ① Unscrew the knob.
- ② Insert the bare wire.
[Remove approx. 5mm (1/4") insulation from the speaker wires.]
- ③ Tighten the knob and secure the wire.

CONNECTING TO LINE OUTPUT (PIN JACK) TERMINALS OF THE AMPLIFIER

- Leave the main speakers connected to the amplifier.
- Line output terminals may be labeled PRE OUT, REC OUT or SUBWOOFER OUT.
 - * For PRE OUT terminal connection, the amplifier must possess at least two sets of PRE OUT terminals. With some amplifiers with only one set of PRE OUT terminals, connection can result in no sound from the main left and right speakers. In this case, select an alternative method of connection.

If using one YST-SW500

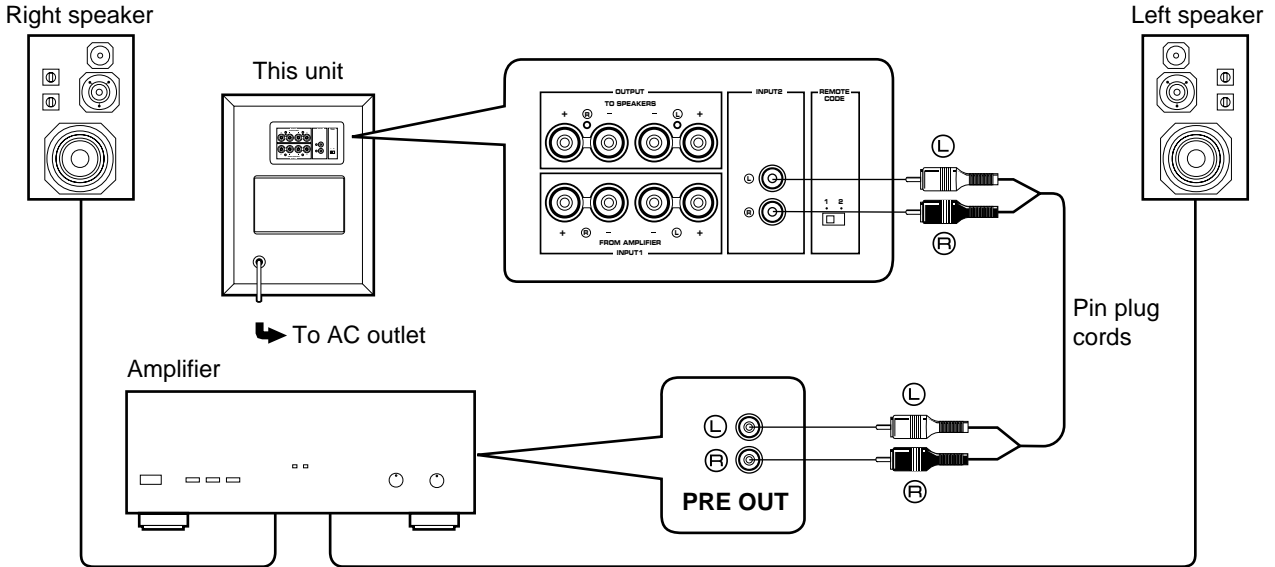

If using two YST-SW500s

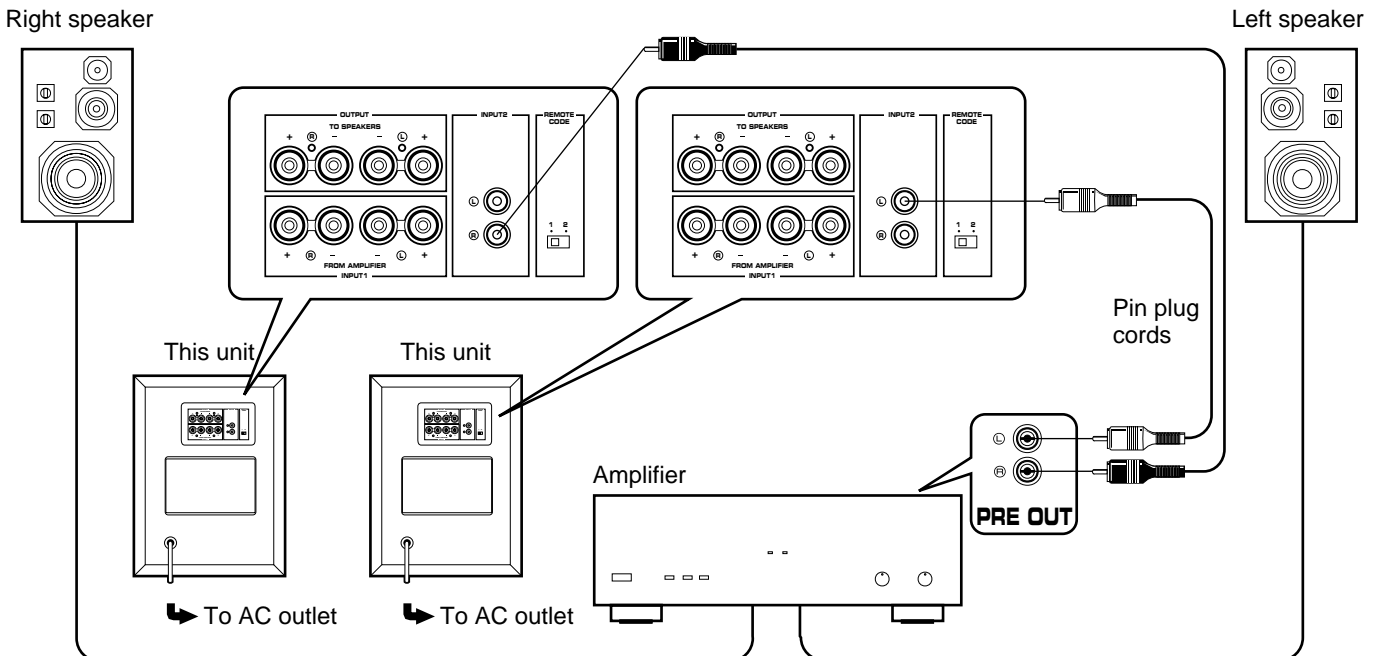

Notes

- When connected to the REC OUT terminals, if the amplifier has a REC OUT selector, be sure to set it for the correct source. For information on its operation, consult the amplifier's owner's manual.
- When connected to line output terminals, other speakers should not be connected to the OUTPUT terminals on the rear panel of this unit. If connected, they will not produce sound.
- When connecting to a monaural line output terminal of the amplifier, connect to either the left or right INPUT 2 terminal.

CONTROLS AND THEIR FUNCTIONS

Front panel

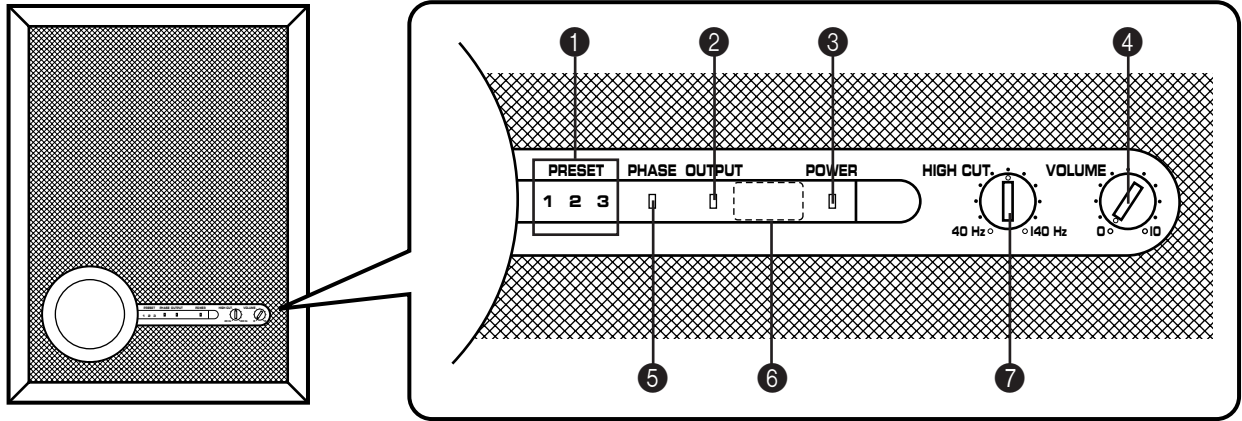

Rear panel

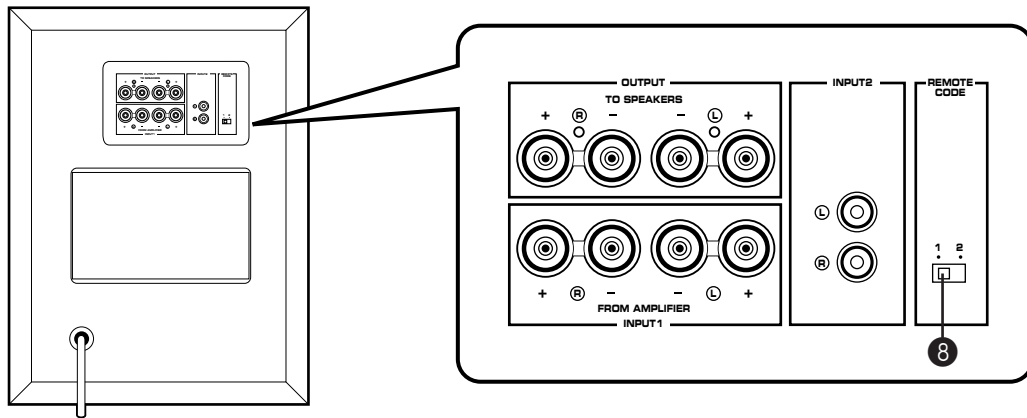

Remote control transmitter

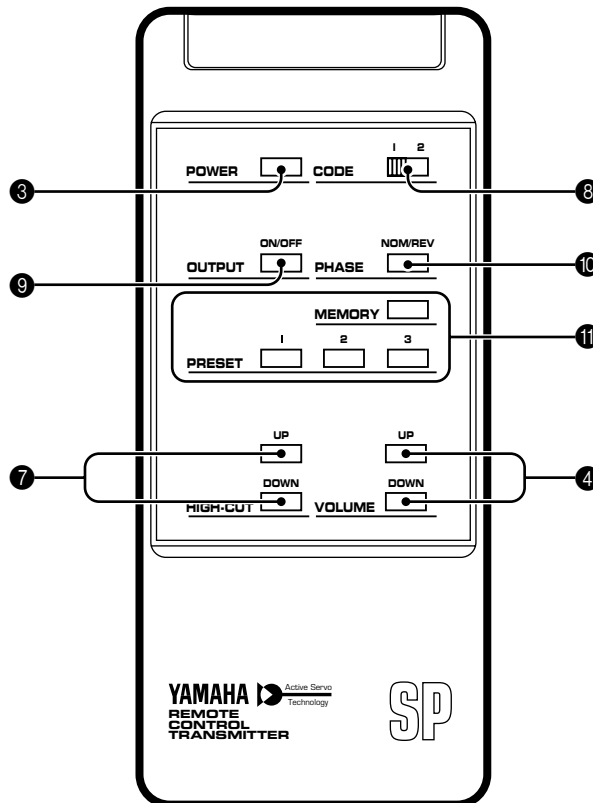

1 **PRESET** number indicator
The number corresponding to the selected **PRESET** key illuminates.

2 **OUTPUT** indicator
Illuminates when the **OUTPUT** switch is turned ON, and goes off when turned OFF.

3 **POWER** switch
Turns the power on/off.

4 **VOLUME** control
Adjusts the volume level.
For easier operation, use the **VOLUME UP/DOWN** keys on the remote control transmitter.

5 **PHASE** indicator
Illuminates in red when the **PHASE** switch is in the normal (NOM) position, and illuminates in green when in the reverse (REV) position.

6 Remote control sensor
Receives the signals from the remote control transmitter.

7 **HIGH CUT** control
Adjusts the high frequency cut off point.
Frequencies higher than the level set by this control are all cut off (and not output).
For easier operation, use the **HIGH-CUT UP/DOWN** keys on the remote control transmitter.

* One graduation of this control indicates

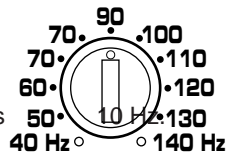

8 **(REMOTE) CODE** switch
Switches the signal codes for remote control. Set both the **CODE** switches on the remote control transmitter and the rear panel of the unit(s) according to the usage of the unit(s) referring to the following descriptions.

If using one YST-SW500;

Set both the **CODE** switches on the remote control transmitter and the rear panel to the **1** position, and the unit can be controlled by the remote control transmitter.

If using two YST-SW500s;

- If you will control two units at the same time with the remote control transmitter, set the **CODE** switches on the remote control transmitter and the rear panels of the two units to the **1** position.
- If you will control two units individually with the remote control transmitter, set the **CODE** switch on the rear panel of one unit to the **1** position and the other to the **2** position. When you control one unit with the remote control transmitter, switch the **CODE** switch on the remote control transmitter to the corresponding position.

9 **OUTPUT** switch
Turns the output of this unit ON and OFF whenever pressed. When this switch is turned ON, the **OUTPUT** indicator on the front panel illuminates.

10 **PHASE** switch
Normally this switch is to be set to the normal (NOM) position. However, according to your speaker systems or the listening condition, there may be a case when better sound quality is obtained by setting this switch to the reverse (REV) position. Select the better position by monitoring the sound.
In the normal position, the **PHASE** indicator on the front panel illuminates in red, and in the reverse position, it illuminates in green.

11 **MEMORY** key/**PRESET** keys
Used to store and recall the data for the **VOLUME** control, the **HIGH CUT** control and the **PHASE** switch adjustments. (See page 12.)

ADJUSTING VOLUME BALANCE

For these operations, use the remote control transmitter at the listening position.

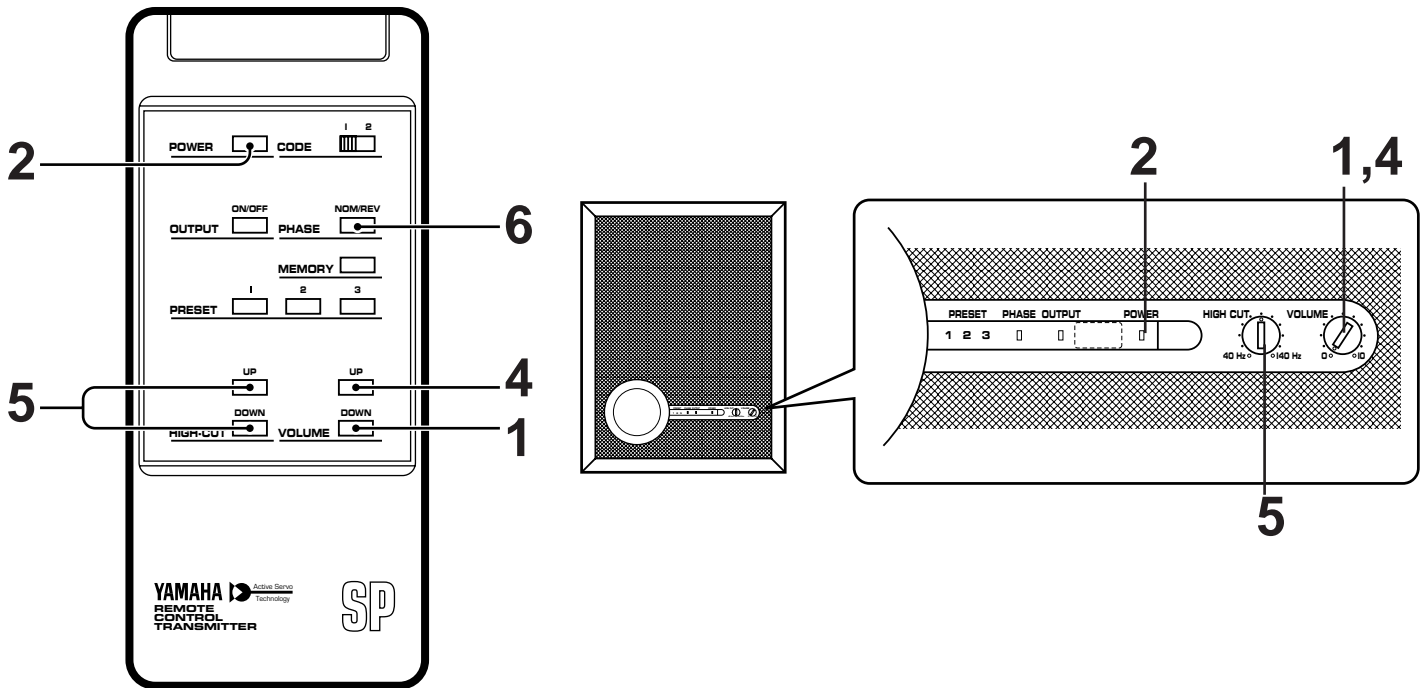

- 1** Set the **VOLUME** control to minimum.
- 2** Turn on the power supply to all the components.
- 3** Play the source and adjust the amplifier's volume control to the desired listening level.
- 4** Turn up the **VOLUME** control gradually to adjust the volume balance between this unit and the main speakers.
- 5** Adjust the **HIGH CUT** control to the position where the desired response can be obtained.
- 6** Set the **PHASE** switch to the position (NOM or REV) where the desired bass effect can be obtained.

Notes

- Once the volume balance between this unit and the main speakers is adjusted, you can adjust the volume of your whole sound system by using only the amplifier's volume control.
 - * However, if this unit is connected to line output terminals (except PRE OUT or SUBWOOFER OUT terminals) of the amplifier, you must adjust the volume controls of this unit and the amplifier individually.
- For adjusting the **VOLUME** control, the **HIGH CUT** control and the **PHASE** switch, refer to "FREQUENCY CHARACTERISTICS" on the next page.

For effective adjustment of the HIGH CUT control

First set this control at about the main speakers' rated minimum reproduceable frequency. Then turn up the **VOLUME** control gradually and set it at a level where you can obtain a little more bass effect than when this unit is not used. On the basis of this setting, if desired, adjust the **VOLUME** control and the **HIGH CUT** control again.

- * The main speakers' minimum reproduceable frequency can be looked up in the speakers' catalog or owner's manual.

FREQUENCY CHARACTERISTICS

Adjustment of the **VOLUME** control, the **HIGH CUT** control and the **PHASE** switch should be changed according to the main speakers, listening condition, the source, etc.

The following figures show the optimum adjusting level of each control and the frequency characteristics on the condition that this unit is combined with a typical speaker system.

This unit's frequency characteristics

- When combined with a 4" or 5" acoustic suspension, 2 way system

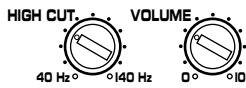

PHASE-Reverse (The **PHASE** indicator on the front panel illuminates in green.)

- When combined with an 8" or 10" acoustic suspension, 2 way system



PHASE-Reverse (The **PHASE** indicator on the front panel illuminates in green.)

- When combined with a 12" acoustic suspension, 3 way system



PHASE-Reverse (The **PHASE** indicator on the front panel illuminates in green.)

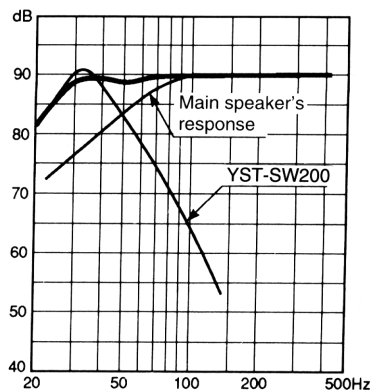
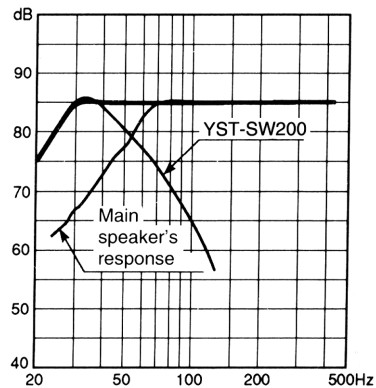
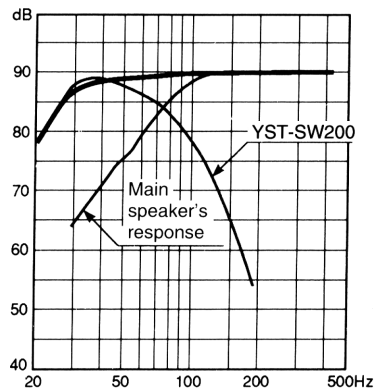
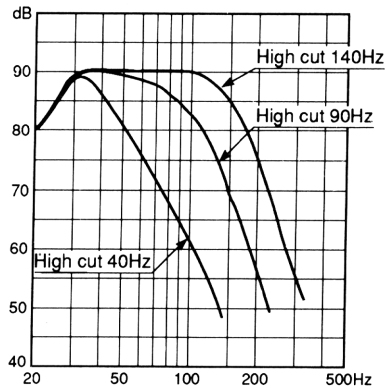

Storing preset data of the VOLUME control etc.

You can store preset data of the **VOLUME** control, the **HIGH CUT** control and the **PHASE** switch as a set. Each of the three **PRESET** keys on the remote control transmitter is used to store (and recall) one set of data. With this function, you can recall any preset data easily according to the source.

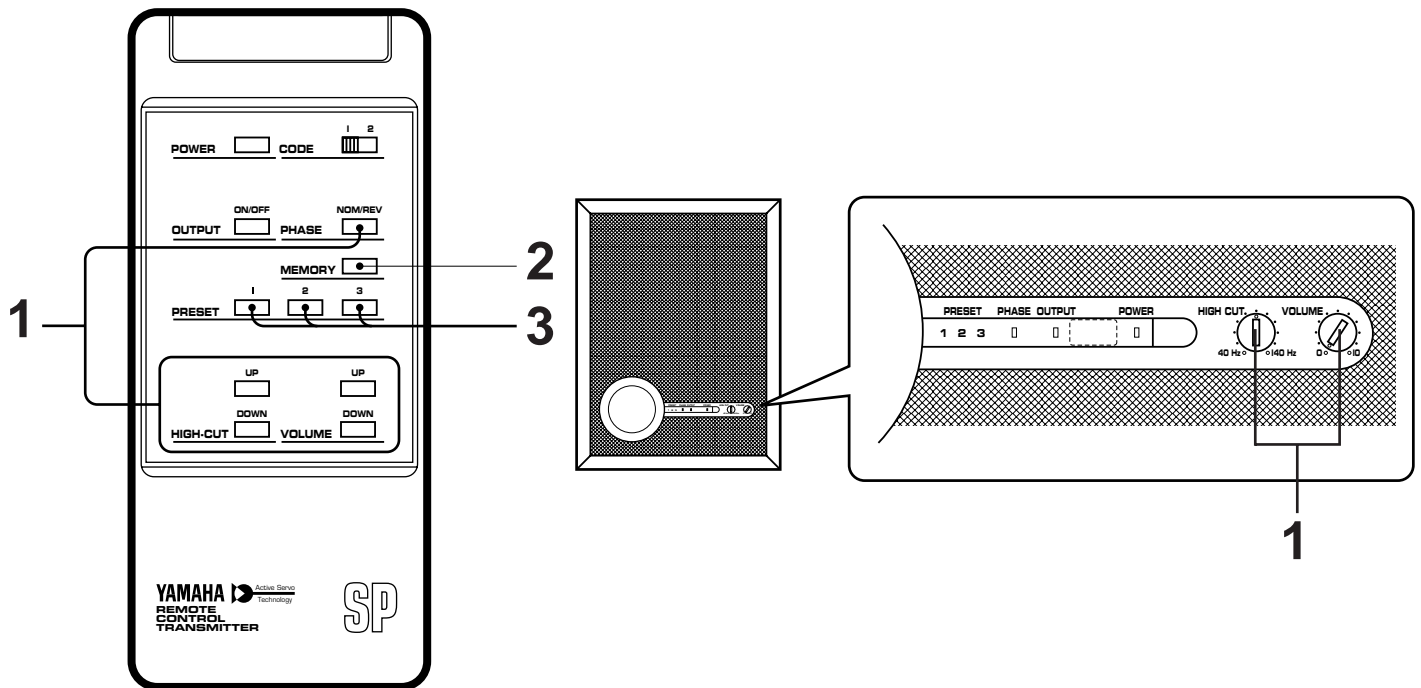

To store

- 1** Adjust the **VOLUME** control, the **HIGH CUT** control and the **PHASE** switch.
- 2** Press the **MEMORY** key. The **PRESET** number indicators on the front panel flash.
- 3** Press the **PRESET 1** key. The corresponding **PRESET** number indicator illuminates. This shows that the data has been stored in **PRESET 1**.

* In the same way, store other sets of data in **PRESET 2** and **3**.

Notes

- A new setting can be stored in place of the former one.
- While the **VOLUME** control or the **HIGH CUT** control is rotating from a **PRESET** key having been pressed, pressing another **PRESET** key is ineffective.

To recall

Simply press the **PRESET (1, 2 or 3)** key where the data you want to recall is stored.

Memory back-up

The memory back-up circuit prevents the stored data from being lost even if the **POWER** switch is set off or the power plug is disconnected from the AC outlet or the power is cut due to temporary power failure. If, however, the power is lost for more than two weeks, the memory may be erased. If so, it can be re-stored by simply following the steps described above.

NOTES ABOUT THE REMOTE CONTROL TRANSMITTER

Battery installation

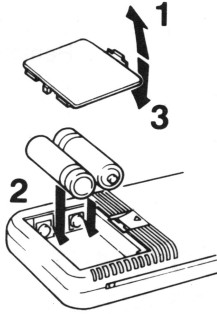

Battery replacement

If you find that the remote control transmitter must be used closer to the main unit, the batteries are weak. Replace both batteries with new ones.

Notes

- Use only AA, R6, UM-3 batteries for replacement.
- Be sure the polarities are correct. (See the illustration inside the battery compartment.)
- Remove the batteries if the remote control transmitter will not be used for an extended period of time.
- If batteries leak, dispose of them immediately. Avoid touching the leaked material or letting it come in contact with clothing, etc. Clean the battery compartment thoroughly before installing new batteries.

Remote control transmitter operation range

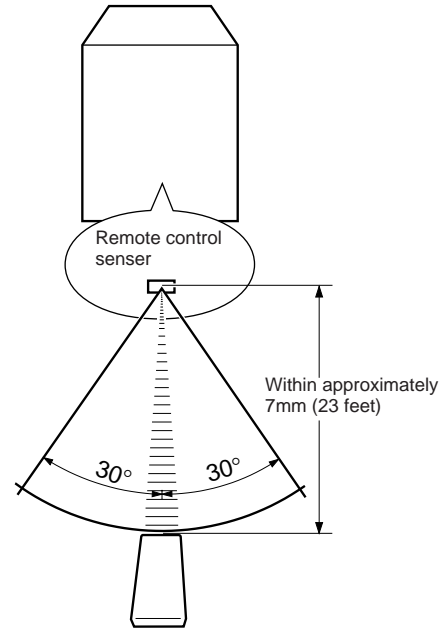

Notes

- There should be no large obstacles between the remote control transmitter and the main unit.
- If the remote control sensor is directly illuminated by strong lighting (especially an inverter type of fluorescent lamp etc.), it might cause the remote control transmitter not to work correctly. In this case, reposition the main unit to avoid direct lighting.

TROUBLESHOOTING

If the unit fails to operate normally, check the following points to determine whether the fault can be corrected by the simple measures suggested. If it cannot be corrected, or if the fault is not listed in the SYMPTOM column, disconnect the power cord and contact your authorized YAMAHA dealer or service center for help.

SYMPTOM	CAUSE	REMEDY
Power is not supplied even though the POWER switch is ON.	The power plug is not securely connected.	Connect it securely.
No sound .	The VOLUME control is set to 0.	Turn the VOLUME control to right.
	The OUTPUT switch is OFF.	Press the OUTPUT switch so that the OUTPUT indicator on the front panel illuminates.
	Speaker cables are not connected securely.	Connect them securely.
Sound level is too low.	Speaker cables are connected incorrectly.	Connect them correctly, that is to say L (left) to L, R (right) to R, “+” to “+” and “-” to “-”.
	Setting of the PHASE switch is not proper.	Set the switch to the other position.
	A source sound with few bass frequencies is played.	Play a source sound with bass frequencies. Set the HIGH-CUT control to a higher position. (Turn the knob to right.)
	It is influenced by the standing waves.	Break up the parallel surface by placing bookshelves etc. along the walls.
The remote control transmitter does not work.	Direct sunlight or lighting (of an inverter type of fluorescent lamp etc.) is striking the remote control sensor of the main unit.	Change position of the main unit.
The distance or range within which the remote control transmitter can be used decreases.	The batteries of this remote control transmitter are too weak.	Replace the batteries with new ones.

SPECIFICATIONS

Speaker Unit25 cm (10") cone woofer (JA2540)
 magnetic-shield type
Amplifier Output120W/5 ohms (THD 0.1%, 100 Hz)
High-Cut Filter40 Hz–140 Hz (–24 dB/oct.)
Frequency Response20 Hz–160 Hz (–10 dB)
Power Supply
 U.S.A. and Canada modelAC 120V, 60 Hz
 General modelAC 110/120/220/240V, 50/60 Hz

Power Consumption130W
Dimensions (W x H x D)330 mm x 440 mm x 380 mm
 (13" x 17-5/16" x 14-15/16")
Weight22 kg (48 lbs. 6 oz.)
AccessoriesRemote control transmitter
 Batteries
 Speaker cords

ACTIVE SERVO TECHNOLOGY

The theory of Active Servo Technology is based upon two major factors, the Helmholtz resonator and negative-impedance drive. Active Servo Processing speakers reproduce the bass frequencies through an "air woofer", which is a port or opening in the speaker's cabinet. This opening is used instead of, and performs the functions of, a woofer in a conventionally designed speaker system. Thus, signals of low amplitude within the cabinet can, according to the Helmholtz resonance theory, be output from this opening as waves of great amplitude if the design is such that the size of the opening and the volume of the cabinet are in the correct proportion to satisfy a certain ratio.

In order to accomplish this, moreover, the amplitudes within the cabinet must be both precise and of sufficient power because these amplitudes must overcome the "load" presented by the air that exists within the cabinet.

Thus it is this problem that is resolved through the employment of a design in which the amplifier functions to supply special signals. If the electrical resistance of the voice coil could be reduced to zero, the movement of the speaker unit would become linear with respect to signal voltage, and, to accomplish this, a special negative-impedance output-drive amplifier for subtracting output impedance of the amplifier is used.

By employing negative-impedance drive circuits, the amplifier is able to generate precise, low-amplitude low-frequency waves with superior damping characteristics, and these waves are then radiated from the cabinet opening as high-amplitude signals. The system can, therefore, by employing the negative-impedance output drive amplifier and a speaker cabinet with the Helmholtz resonator, reproduce an extremely wide range of frequencies with amazing sound quality and less distortion.

The features described above, then, are combined to be the fundamental structure of the Active Servo Technology.

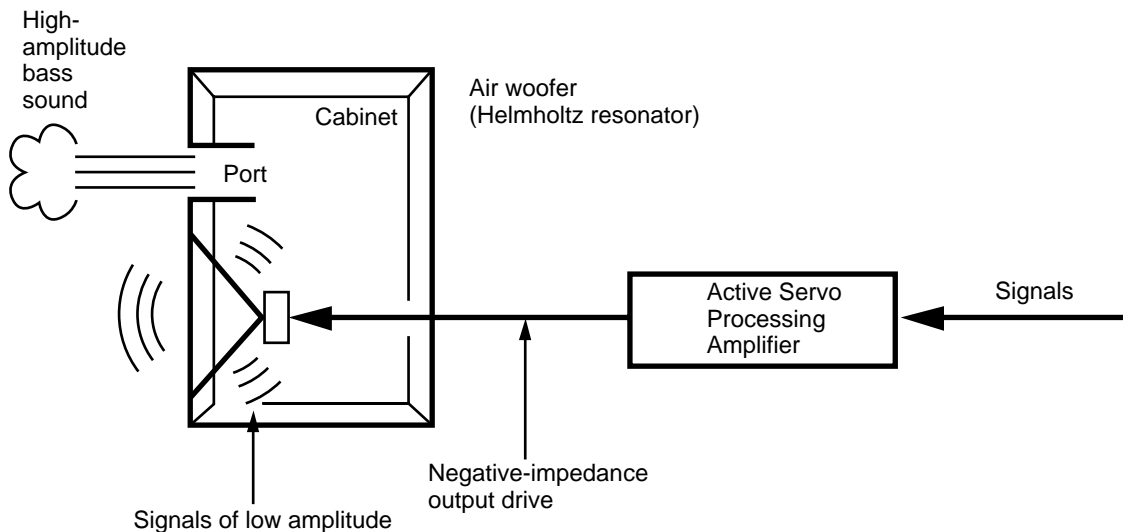

YAMAHA

YAMAHA ELECTRONICS CORPORATION, USA 6660 ORANGETHORPE AVE., BUENA PARK, CALIF. 90620, U.S.A.
YAMAHA CANADA MUSIC LTD. 135 MILNER AVE., SCARBOROUGH, ONTARIO M1S 3R1, CANADA
YAMAHA ELECTRONIK EUROPA G.m.b.H. SIEMENSSTR. 22-34, D-25462 RELLINGEN BEI HAMBURG, F.R. OF GERMANY
YAMAHA ELECTRONIQUE FRANCE S.A. RUE AMBROISE CROIZAT BP70 CROISSY-BEAUBOURG 77312 MARNE-LA-VALLEE CEDEX02, FRANCE
YAMAHA ELECTRONICS (UK) LTD. YAMAHA HOUSE, 200 RICKMANSWORTH ROAD WATFORD, HERTS WD1 7JS, ENGLAND
YAMAHA SCANDINAVIA A.B. J A WETTERGRENS GATA 1, BOX 30053, 400 43 VÄSTRA FRÖLUNDA, SWEDEN
YAMAHA MUSIC AUSTRALIA PTY, LTD. 17-33 MARKET ST., SOUTH MELBOURNE, 3205 VIC., AUSTRALIA

YAMAHA CORPORATION
VP16310-0 BWWB,W Printed in Japan