



home theater

just add your TV

theater

SURROUND SOUND SYSTEM

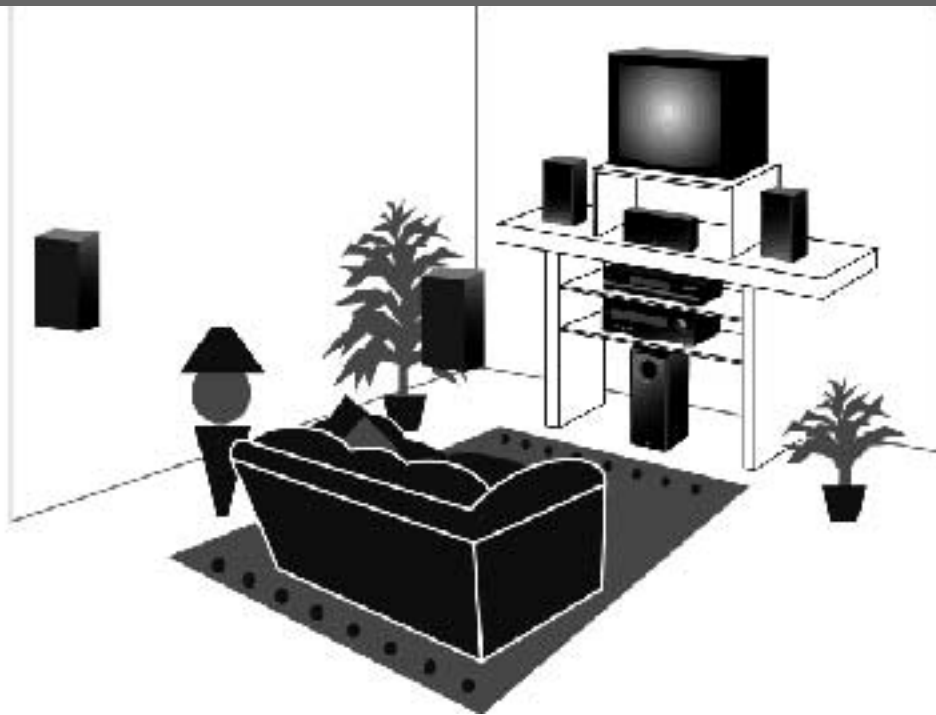

YHT-500

QUICK-CONNECT GUIDE

INTRODUCTION

Yamaha developed the YHT-500 A/V Home Theater package to turn your home into a theater. In addition to enhancing the sound of a video source, like your TV, DVD, or VCR, the YHT-500 also superbly reproduces audio sources, such as a CD player or a cassette deck.

This Quick-Connect Guide will help you get started. Study the speaker system plan (below), and then use the interconnect diagrams (on the following pages) to connect the receiver and speakers to your system.

For the video portion, you will need a television or monitor. Refer to the *Yamaha HTR-5540 Owner's Manual*, as well as those that came with your other components, for complete instructions and cautions. Be sure to turn off all power while making connections.

Save this Quick-Connect Guide for future reference.

NOTE: Label the end of each speaker wire (i.e., left rear, right front, etc.) before connecting them to the A/V receiver. For wire runs over 30 feet, use larger 18- or 16-gauge speaker wire.

TOOLS AND PARTS

The YHT-500 Home Theater package consists of (1) HTR-5540 A/V receiver with (1) remote control, DV-S5450 DVD Player with (1) remote control, (4) 2-way NS-A329 front/rear speakers, (1) NS-AC329 2-way center-channel speaker (includes factory installed rubber feet), (1) 100' of bulk speaker speaker wire, (1) 0.5m optical cable, (1) 10' RCA audio cable, (1) YST-SW005 Powered Subwoofer, and related owner's manuals. You will also need:

Σ Wire strippers (optional) □

Σ Brackets, toggle bolts, molly anchor screws, or sheet metal screws (for securing NS-A329 speakers to □ walls)

NOTE: If you are unsure of how to securely and safely fasten speakers to a wall, please contact a reliable source about the best type of hardware for your particular wall's construction. Secure installation is the purchaser's responsibility.

SPEAKER SYSTEM PLAN

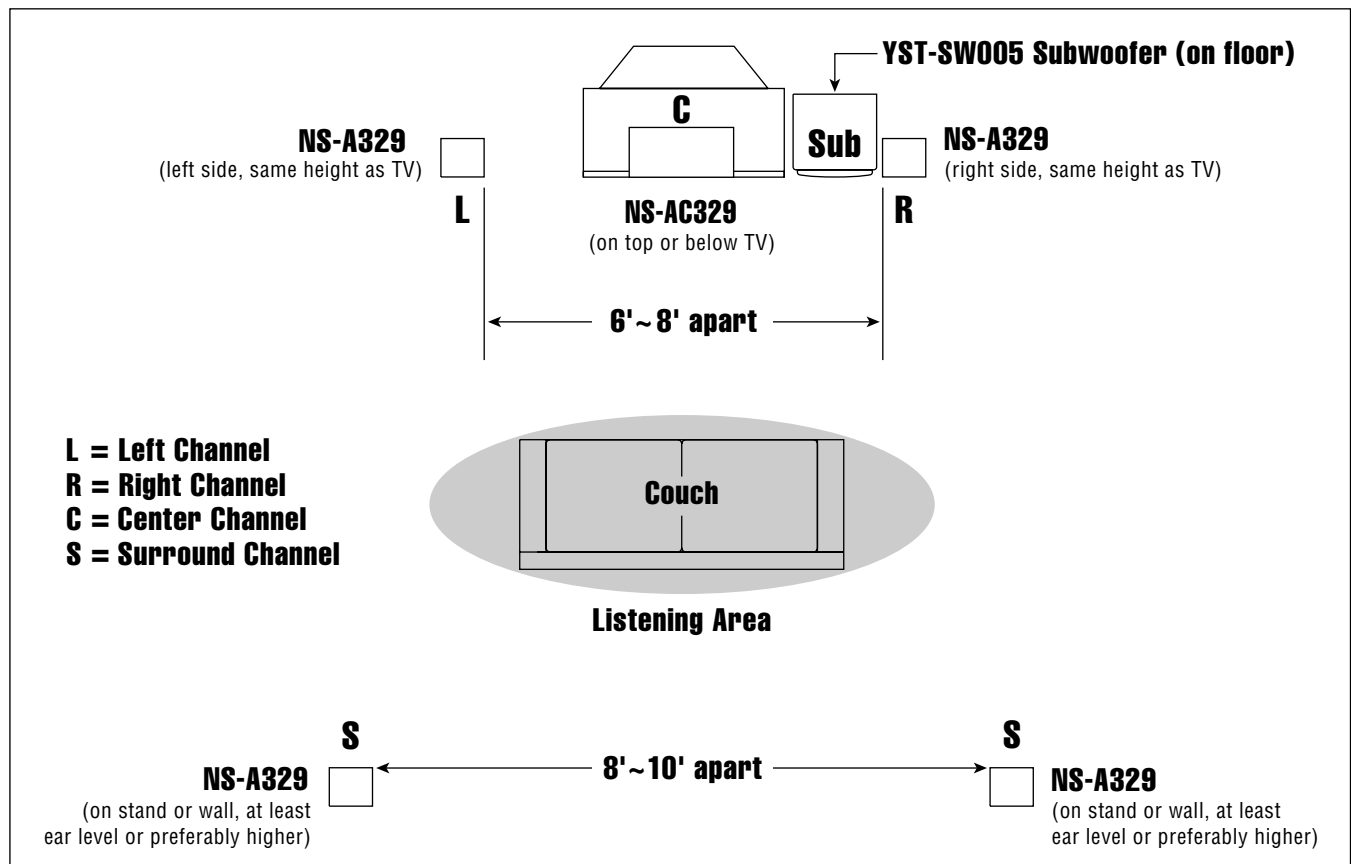

CONNECTING AUDIO COMPONENTS

Yamaha HTR-5540 Receiver (Rear Panel)

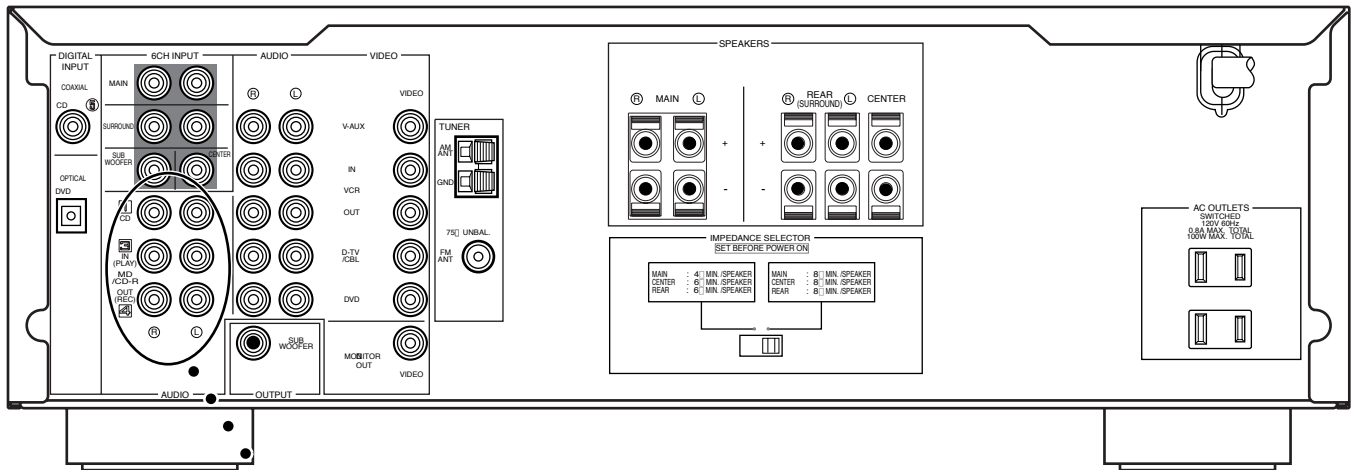

NOTE: For your convenience, the Yamaha HTR-5540 receiver is equipped with two switched AC outlets (100 W max.). If desired, use them to power on connected components (e.g., CD player) each time the receiver is turned on. However, do not use them for components equipped with clocks (e.g., VCR).

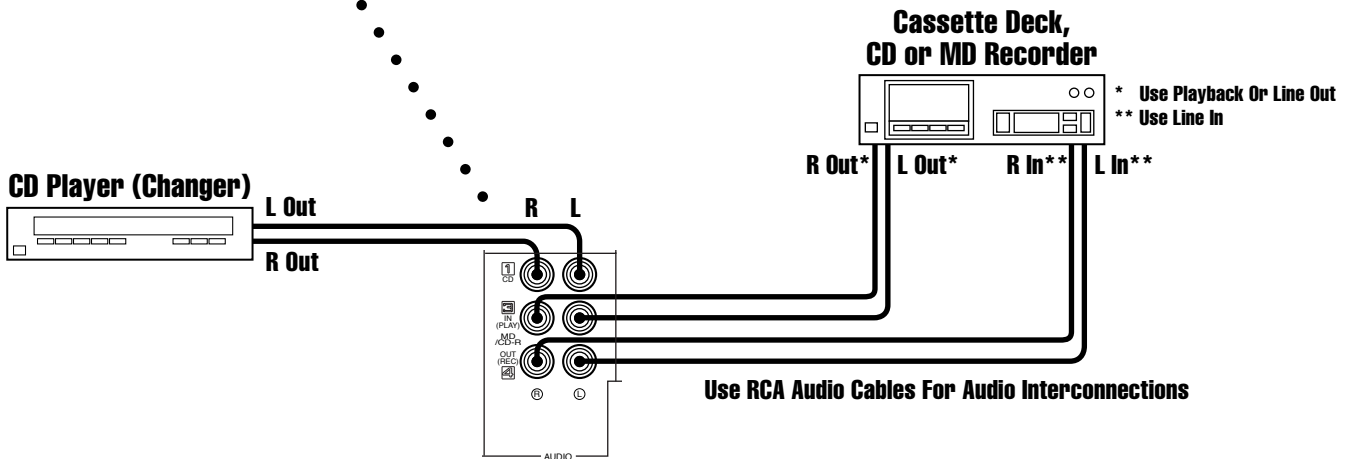

RCA Cable Color Codes

White = Left Audio
Red = Right Audio

CONNECTING THE YHT-500 SPEAKERS

**NS-A329
(Front Right Ch.)**

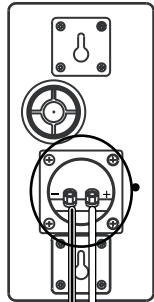

Stripe Wire

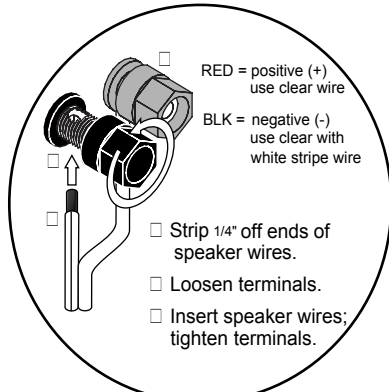

Speaker Wiring

**NS-AC329
(Center Channel)**

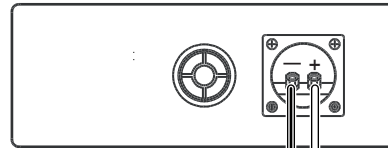

Stripe Wire

**NS-A329
(Front Left Ch.)**

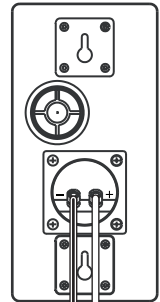

Stripe Wire

**Yamaha HTR-5540
A/V Receiver
(Rear Panel)**

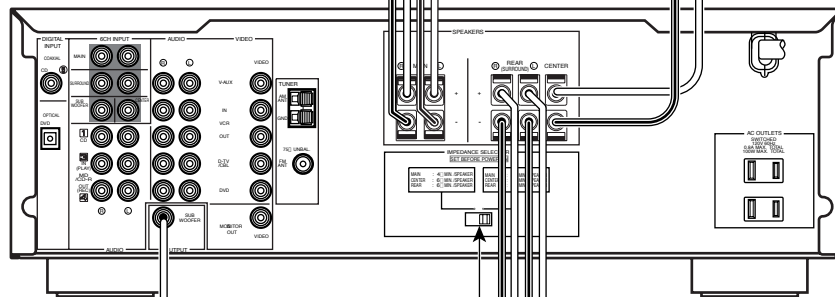

Set IMPEDANCE Selector to right position.

**YST-SW005
(Subwoofer)**

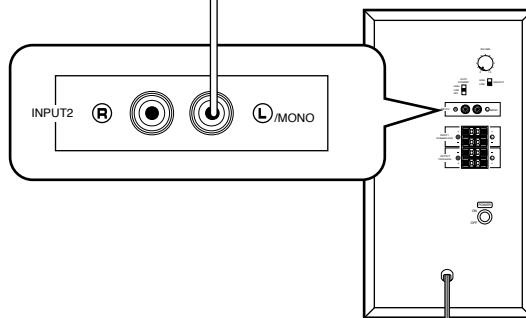

To AC outlet

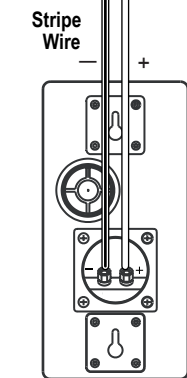

**NS-A329
(Surround Right)**

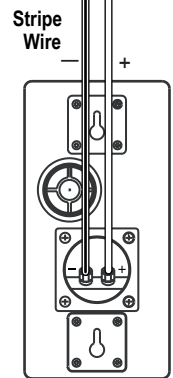

**NS-A329
(Surround Left)**

CONNECTING VIDEO CABLES FOR VIDEO COMPONENTS

Yamaha HTR-5540 Receiver (Rear Panel)

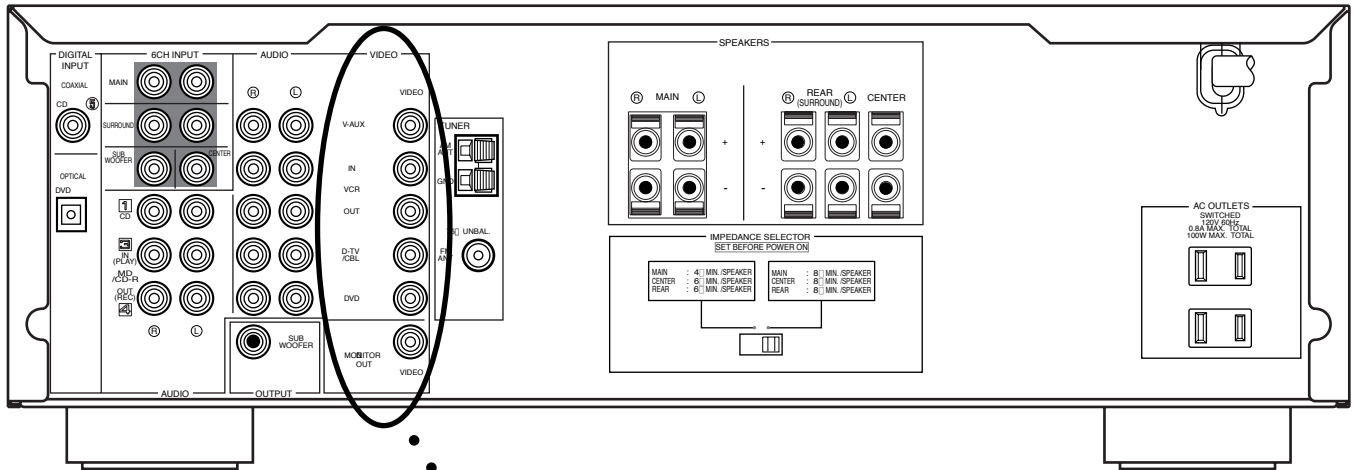

NOTE: When using a hi-fi stereo VCR, set the Tuner/Line switch (on the VCR) to Line position to record from another source connected to the Yamaha HTR-5540 receiver.

Satellite Receiver (or Cable Box)



DVD Player (or Video Game)

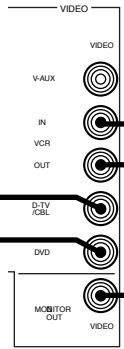
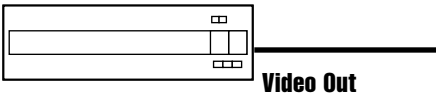

Hi-Fi Stereo VCR

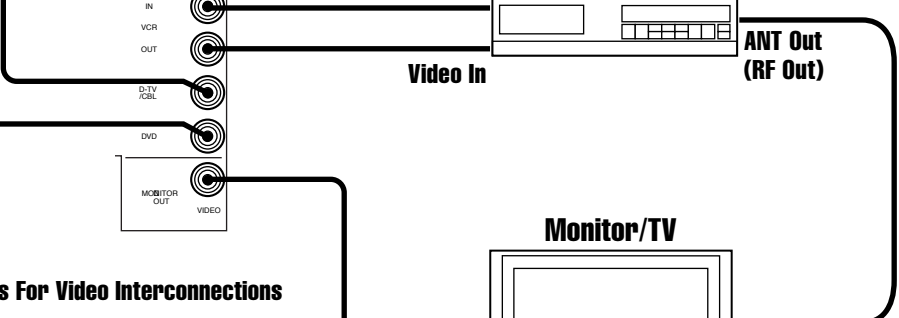

Use RCA Video Cables And Jacks For Video Interconnections

RCA Cable Color Codes
 Yellow = Video
 White = Left Audio
 Red = Right Audio

CONNECTING THE YAMAHA DV-S5450 DVD PLAYER

Yamaha HTR-5540 Receiver (Rear Panel)

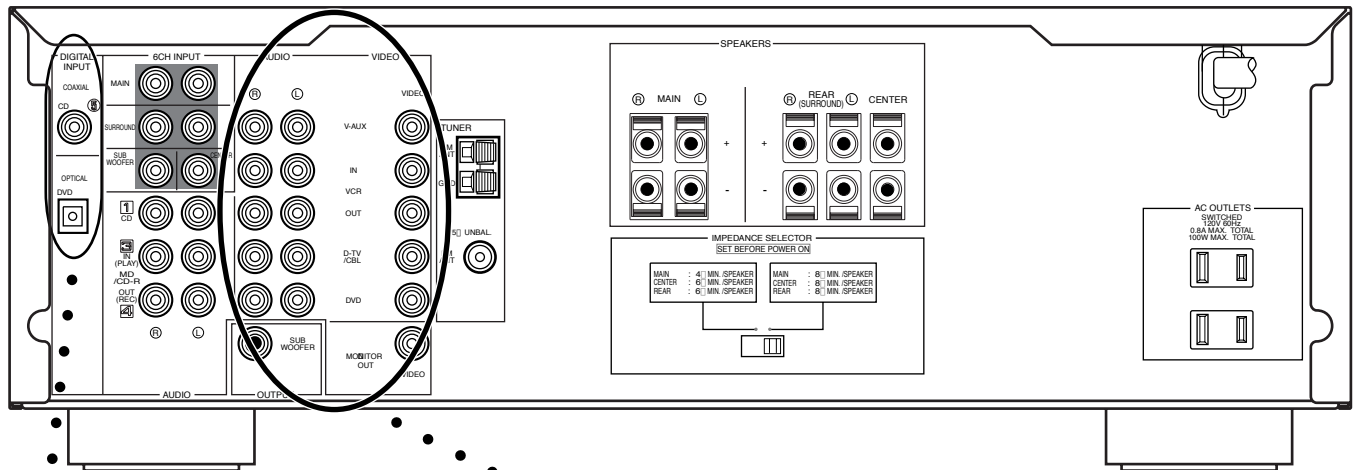

RCA Cable Color Codes
Yellow = Video
White = Left Audio
Red = Right Audio

Use an RCA Video Cable And Jacks For Video Interconnections



Optical Cable (Included)

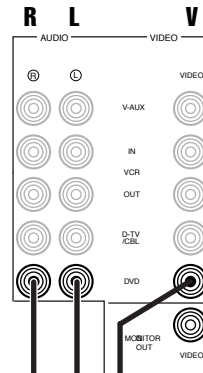

Note: You will need the DVD remote to fully operate this system. Please refer to the DV-S5450 owner's manual for complete remote and DVD player instructions.



Yamaha DV-S5450 DVD Player (Rear Panel)

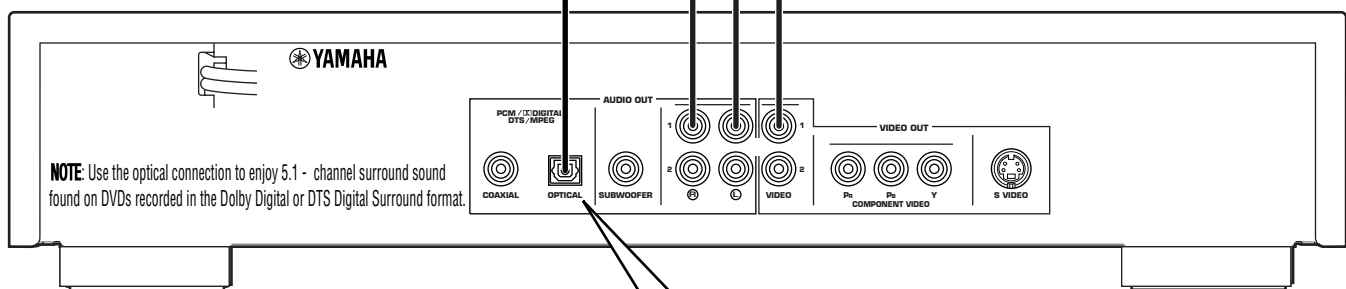

NOTE: Use the optical connection to enjoy 5.1 - channel surround sound found on DVDs recorded in the Dolby Digital or DTS Digital Surround format.

Connecting Optical Cable



Remove dust cap. **Align plug with terminal and insert cable.**

NOTES:

- Σ On both ends of the optical cable, align and firmly insert each plug into its mating terminal.
- Σ During connection, do not bend the optical cable.
- Σ Keep dust caps and reattach them if terminals are not used.

*Analog Audio Out connections are required for playback of CD-Rs and recording from DVD to VCR.

Dolby Digital is a trademark of Dolby Laboratories Licensing Corporation.
 DTS is a trademark of DTS Technology LLC.

CONNECTING AUDIO CABLES FOR VIDEO COMPONENTS

Yamaha HTR-5540 Receiver (Rear Panel)

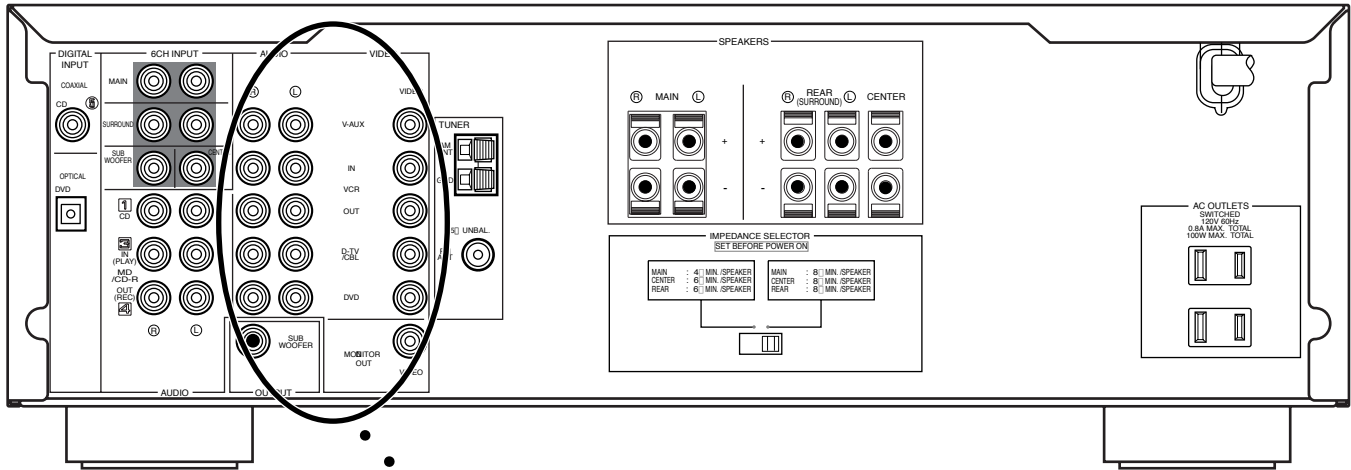

NOTE: When using a hi-fi stereo VCR, set the Tuner/Line switch (on the VCR) to Line position to record from another source connected to the Yamaha HTR-5540 receiver.

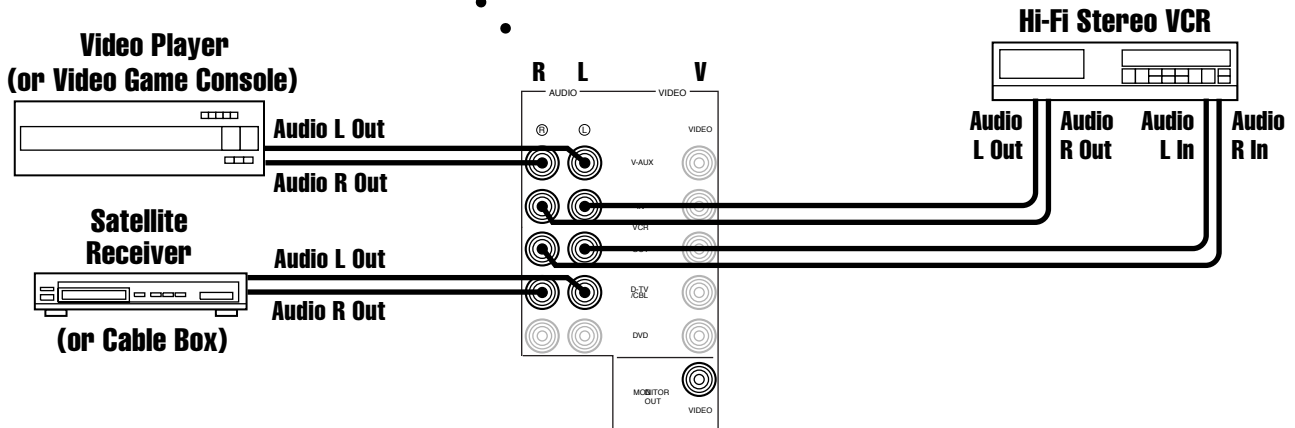

RCA Cable Color Codes
 Yellow = Video
 White = Left Audio
 Red = Right Audio

Use RCA Audio Cables And Jacks For Audio Interconnections

CABLE HOOK-UP (BASIC AND PREMIUM CHANNELS)

Yamaha HTR-5540 Receiver (Rear Panel)

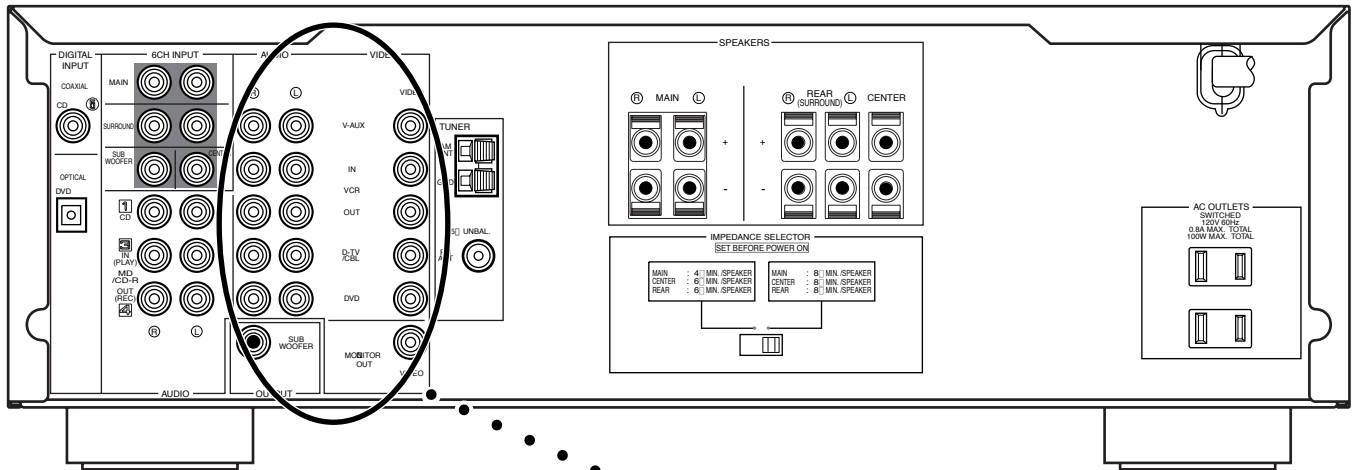

NOTE: When using a hi-fi stereo VCR, set the Tuner/Line switch (on the VCR) to Line position to record from another source connected to the Yamaha HTR-5540 receiver.

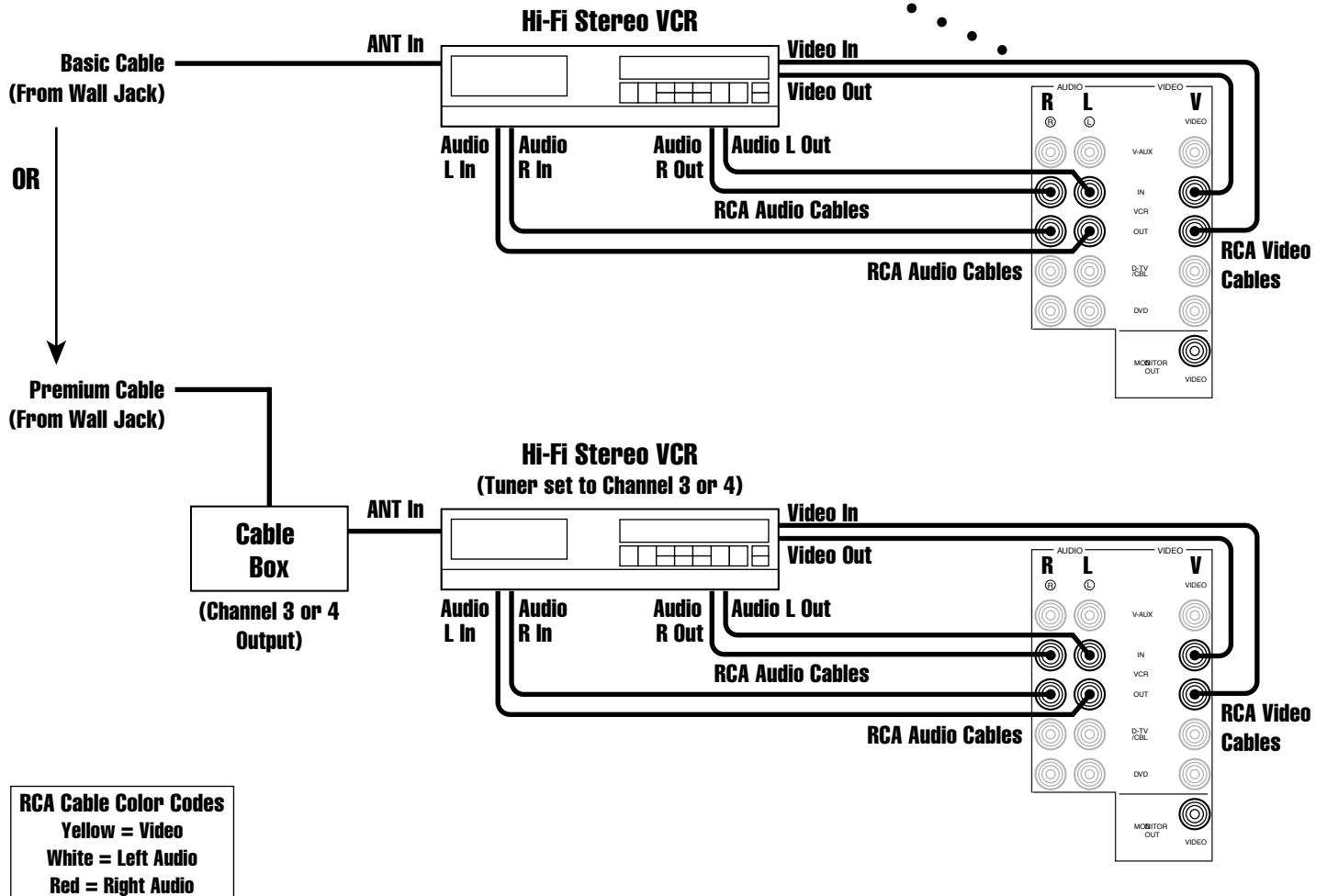

INITIAL ADJUSTMENT OF THE YST-SW005 SUBWOOFER

To achieve the optimum volume balance between the YST-SW005 Subwoofer and the NS-A329 Main Speakers, perform the following procedure:

1. Insert the YST-SW005 power plug into a nearby AC outlet.
2. Set the YST-SW005 VOLUME control to 0 (minimum setting), the AUTO STANDBY switch to HIGH, and the HIGH CUT switch to LOW.
3. Press the YST-SW005 POWER button to ON and power on all other components.
4. Play an audio source and adjust the HTR-5540's VOLUME control to a desired listening level.
5. Increase the YST-SW005 volume control gradually to adjust the balance and volume between the YST-SW005 Subwoofer and the NS-A329 Main Speakers.

NOTE: Once the volume is balanced between the subwoofer and the main speakers, you can adjust the volume of your whole sound system by using the HTR-5540's VOLUME control.

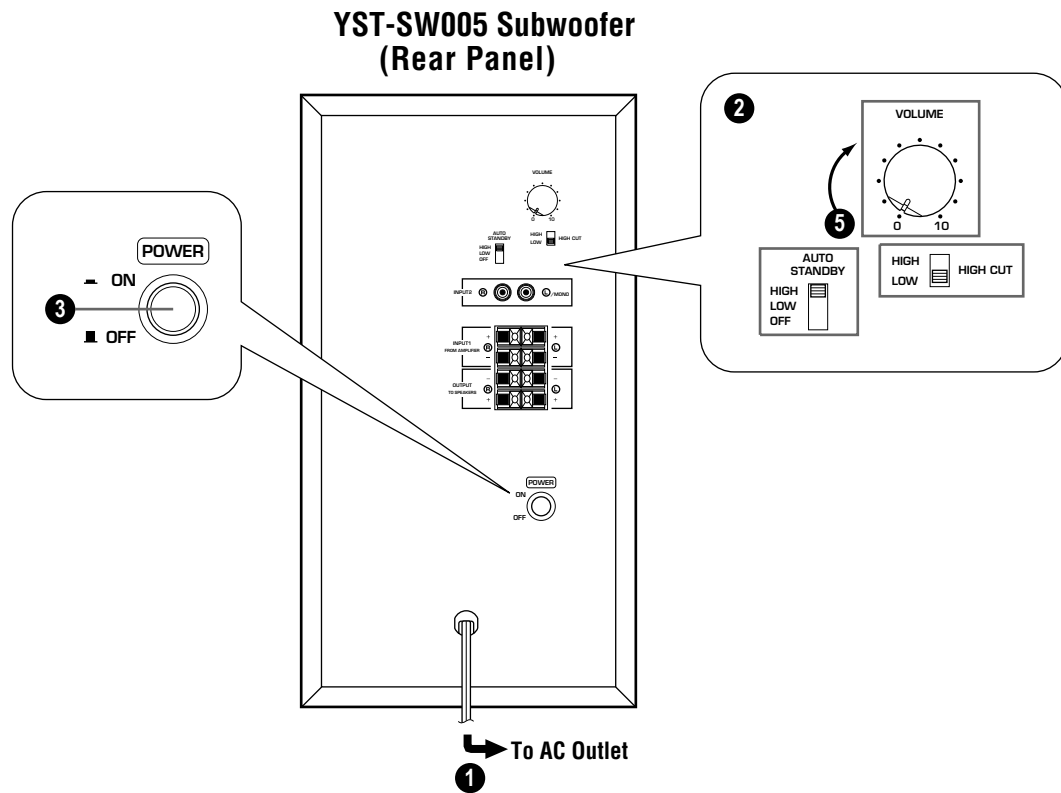

THE REMOTE CONTROL

The YHT-500 Home Theater package includes a remote control. It comes pre-programmed to control your HTR-5440 receiver.

INSTALLING BATTERIES IN THE REMOTE CONTROL

Insert the batteries in the correct direction by aligning the + and - marks on the batteries with the polarity markings (+ and -) inside the battery compartment.

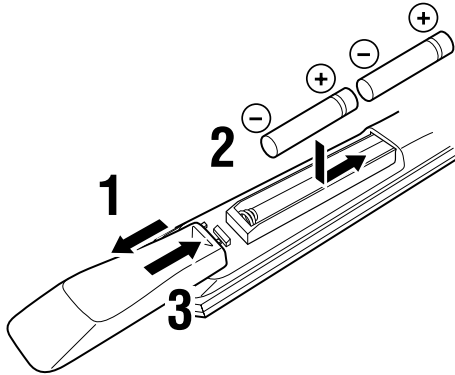

- 1 Press the ▼ part and slide off the battery compartment cover.
- 2 Insert the 2 supplied batteries (AA) according to the polarity markings on the inside of the battery compartment.
- 3 Slide the cover back on so that it snaps into place.

POWER On/Off

1. Aim the remote control at the receiver, press POWER.
2. The receiver should turn on.
3. Press the POWER button again to turn the receiver off.

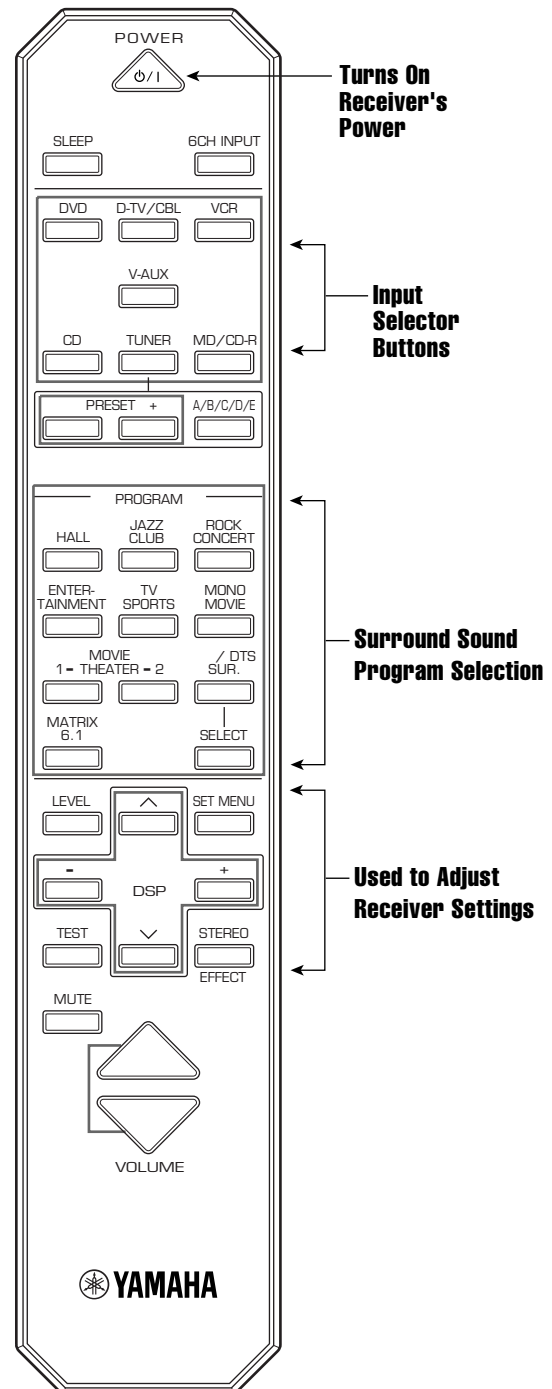



©2002 YAMAHA ELECTRONICS CORPORATION, USA
6660 Orangethorpe Avenue, Buena Park, CA 90620
PH: (714) 522-9105; FAX: (888) 435-7922
<http://www.yamaha.com>