



RX-V2400

AV Receiver

OWNER'S MANUAL

IMPORTANT SAFETY INSTRUCTIONS

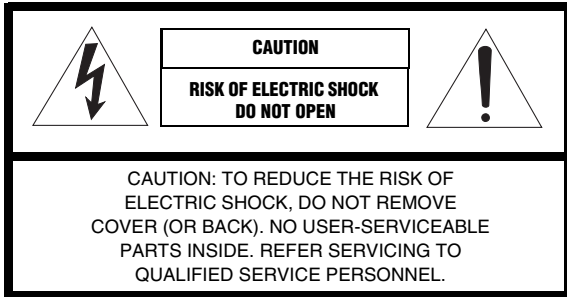

• Explanation of Graphical Symbols

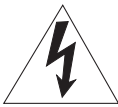

The lightning flash with arrowhead symbol, within an equilateral triangle, is intended to alert you to the presence of uninsulated "dangerous voltage" within the product's enclosure that may be of sufficient magnitude to constitute a risk of electric shock to persons.



The exclamation point within an equilateral triangle is intended to alert you to the presence of important operating and maintenance (servicing) instructions in the literature accompanying the appliance.

- 1 Read Instructions – All the safety and operating instructions should be read before the product is operated.
- 2 Retain Instructions – The safety and operating instructions should be retained for future reference.
- 3 Heed Warnings – All warnings on the product and in the operating instructions should be adhered to.
- 4 Follow Instructions – All operating and use instructions should be followed.
- 5 Cleaning – Unplug this product from the wall outlet before cleaning. Do not use liquid cleaners or aerosol cleaners. Use a damp cloth for cleaning.
- 6 Attachments – Do not use attachments not recommended by the product manufacturer as they may cause hazards.
- 7 Water and Moisture – Do not use this product near water – for example, near a bath tub, wash bowl, kitchen sink, or laundry tub; in a wet basement; or near a swimming pool; and the like.
- 8 Accessories – Do not place this product on an unstable cart, stand, tripod, bracket, or table. The product may fall, causing serious injury to a child or adult, and serious damage to the product. Use only with a cart, stand, tripod, bracket, or table recommended by the manufacturer, or sold with the product. Any mounting of the product should follow the manufacturer's instructions, and should use a mounting accessory recommended by the manufacturer.
- 9 A product and cart combination should be moved with care. Quick stops, excessive force, and uneven surfaces may cause the product and cart combination to overturn.



- 10 Ventilation – Slots and openings in the cabinet are provided for ventilation and to ensure reliable operation of the product and to protect it from overheating, and these openings must not be blocked or covered. The openings should never be blocked by placing the product on a bed, sofa, rug, or other similar surface. This product should not be placed in a built-in installation such as a bookcase or rack unless proper ventilation is provided or the manufacturer's instructions have been adhered to.
- 11 Power Sources – This product should be operated only from the type of power source indicated on the marking label. If you are not sure of the type of power supply to your home, consult your product dealer or local power company. For products intended to operate from battery power, or other sources, refer to the operating instructions.
- 12 Grounding or Polarization – This product may be equipped with a polarized alternating current line plug (a plug having one blade wider than the other). This plug will fit into the power outlet only one way. This is a safety feature. If you are unable to insert the plug fully into the outlet, try reversing the plug. If the plug should still fail to fit, contact your electrician to replace your obsolete outlet. Do not defeat the safety purpose of the polarized plug.
- 13 Power-Cord Protection – Power-supply cords should be routed so that they are not likely to be walked on or pinched by items placed upon or against them, paying particular attention to cords at plugs, convenience receptacles, and the point where they exit from the product.
- 14 Lightning – For added protection for this product during a lightning storm, or when it is left unattended and unused for long periods of time, unplug it from the wall outlet and disconnect the antenna or cable system. This will prevent damage to the product due to lightning and power-line surges.
- 15 Power Lines – An outside antenna system should not be located in the vicinity of overhead power lines or other electric light or power circuits, or where it can fall into such power lines or circuits. When installing an outside antenna system, extreme care should be taken to keep from touching such power lines or circuits as contact with them might be fatal.
- 16 Overloading – Do not overload wall outlets, extension cords, or integral convenience receptacles as this can result in a risk of fire or electric shock.
- 17 Object and Liquid Entry – Never push objects of any kind into this product through openings as they may touch dangerous voltage points or short-out parts that could result in a fire or electric shock. Never spill liquid of any kind on the product.
- 18 Servicing – Do not attempt to service this product yourself as opening or removing covers may expose you to dangerous voltage or other hazards. Refer all servicing to qualified service personnel.
- 19 Damage Requiring Service – Unplug this product from the wall outlet and refer servicing to qualified service personnel under the following conditions:
 - a) When the power-supply cord or plug is damaged,
 - b) If liquid has been spilled, or objects have fallen into the product,
 - c) If the product has been exposed to rain or water,

I CAUTION

IMPORTANT SAFETY INSTRUCTIONS

- d) If the product does not operate normally by following the operating instructions. Adjust only those controls that are covered by the operating instructions as an improper adjustment of other controls may result in damage and will often require extensive work by a qualified technician to restore the product to its normal operation,
- e) If the product has been dropped or damaged in any way, and
- f) When the product exhibits a distinct change in performance - this indicates a need for service.
- 20 Replacement Parts** – When replacement parts are required, be sure the service technician has used replacement parts specified by the manufacturer or have the same characteristics as the original part. Unauthorized substitutions may result in fire, electric shock, or other hazards.
- 21 Safety Check** – Upon completion of any service or repairs to this product, ask the service technician to perform safety checks to determine that the product is in proper operating condition.
- 22 Wall or Ceiling Mounting** – The unit should be mounted to a wall or ceiling only as recommended by the manufacturer.
- 23 Heat** – The product should be situated away from heat sources such as radiators, heat registers, stoves, or other products (including amplifiers) that produce heat.
- 24 Outdoor Antenna Grounding** – If an outside antenna or cable system is connected to the product, be sure the antenna or cable system is grounded so as to provide some protection against voltage surges and built-up static charges. Article 810 of the National Electrical Code, ANSI/NFPA 70, provides information with regard to proper grounding of the mast and supporting structure, grounding of the lead-in wire to an antenna discharge unit, size of grounding conductors, location of antenna discharge unit, connection to grounding electrodes, and requirements for the grounding electrode.

EXAMPLE OF ANTENNA GROUNDING

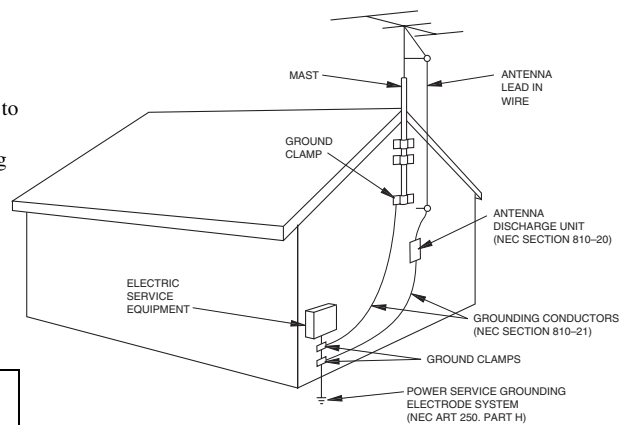

NEC – NATIONAL ELECTRICAL CODE

Note to CATV system installer:

This reminder is provided to call the CATV system installer's attention to Article 820-40 of the NEC that provides guidelines for proper grounding and, in particular, specifies that the cable ground shall be connected to the grounding system of the building, as close to the point of cable entry as practical.

FCC INFORMATION (for US customers)

- 1 IMPORTANT NOTICE : DO NOT MODIFY THIS UNIT!**
This product, when installed as indicated in the instructions contained in this manual, meets FCC requirements. Modifications not expressly approved by Yamaha may void your authority, granted by the FCC, to use the product.
- 2 IMPORTANT :** When connecting this product to accessories and/or another product use only high quality shielded cables. Cable/s supplied with this product **MUST** be used. Follow all installation instructions. Failure to follow instructions could void your FCC authorization to use this product in the USA.
- 3 NOTE :** This product has been tested and found to comply with the requirements listed in FCC Regulations, Part 15 for Class "B" digital devices. Compliance with these requirements provides a reasonable level of assurance that your use of this product in a residential environment will not result in harmful interference with other electronic devices.
- This equipment generates/uses radio frequencies and, if not installed and used according to the instructions found in the users manual, may cause interference harmful to the operation of other electronic devices.

Compliance with FCC regulations does not guarantee that interference will not occur in all installations. If this product is found to be the source of interference, which can be determined by turning the unit "OFF" and "ON", please try to eliminate the problem by using one of the following measures:

Relocate either this product or the device that is being affected by the interference.

Utilize power outlets that are on different branch (circuit breaker or fuse) circuits or install AC line filter/s.

In the case of radio or TV interference, relocate/reorient the antenna. If the antenna lead-in is 300 ohm ribbon lead, change the lead-in to coaxial type cable.

If these corrective measures do not produce satisfactory results, please contact the local retailer authorized to distribute this type of product. If you can not locate the appropriate retailer, please contact Yamaha Electronics Corp., U.S.A. 6660 Orangethorpe Ave, Buena Park, CA 90620.

The above statements apply **ONLY** to those products distributed by Yamaha Corporation of America or its subsidiaries.

CAUTION II

CAUTION: READ THIS BEFORE OPERATING YOUR UNIT.

- 1 To assure the finest performance, please read this manual carefully. Keep it in a safe place for future reference.
- 2 Install this sound system in a well ventilated, cool, dry, clean place — away from direct sunlight, heat sources, vibration, dust, moisture, and/or cold. Allow ventilation space of at least 30 cm on the top, 20 cm on the left and right, and 20 cm on the back of this unit.
- 3 Locate this unit away from other electrical appliances, motors, or transformers to avoid humming sounds.
- 4 Do not expose this unit to sudden temperature changes from cold to hot, and do not locate this unit in a environment with high humidity (i.e. a room with a humidifier) to prevent condensation inside this unit, which may cause an electrical shock, fire, damage to this unit, and/or personal injury.
- 5 Avoid installing this unit where foreign object may fall onto this unit and/or this unit may be exposed to liquid dripping or splashing. On the top of this unit, do not place:
 - Other components, as they may cause damage and/or discoloration on the surface of this unit.
 - Burning objects (i.e. candles), as they may cause fire, damage to this unit, and/or personal injury.
 - Containers with liquid in them, as they may fall and liquid may cause electrical shock to the user and/or damage to this unit.
- 6 Do not cover this unit with a newspaper, tablecloth, curtain, etc. in order not to obstruct heat radiation. If the temperature inside this unit rises, it may cause fire, damage to this unit, and/or personal injury.
- 7 Do not plug in this unit to a wall outlet until all connections are complete.
- 8 Do not operate this unit upside-down. It may overheat, possibly causing damage.
- 9 Do not use force on switches, knobs and/or cords.
- 10 When disconnecting the power cord from the wall outlet, grasp the plug; do not pull the cord.
- 11 Do not clean this unit with chemical solvents; this might damage the finish. Use a clean, dry cloth.
- 12 Only voltage specified on this unit must be used. Using this unit with a higher voltage than specified is dangerous and may cause fire, damage to this unit, and/or personal injury. YAMAHA will not be held responsible for any damage resulting from use of this unit with a voltage other than specified.
- 13 To prevent damage by lightning, disconnect the power cord from the wall outlet during an electrical storm.
- 14 Do not attempt to modify or fix this unit. Contact qualified YAMAHA service personnel when any service is needed. The cabinet should never be opened for any reasons.
- 15 When not planning to use this unit for long periods of time (i.e. vacation), disconnect the AC power plug from the wall outlet.
- 16 Be sure to read the “TROUBLESHOOTING” section on common operating errors before concluding that this unit is faulty.
- 17 Before moving this unit, press STANDBY/ON to set this unit in the standby mode, and disconnect the AC power plug from the wall outlet.
- 18 **VOLTAGE SELECTOR (Asia and General models only)**
The VOLTAGE SELECTOR on the rear panel of this unit must be set for your local main voltage BEFORE plugging into the AC main supply.
Voltages are 110/120/220/230-240 V AC, 50/60 Hz.

WARNING

TO REDUCE THE RISK OF FIRE OR ELECTRIC SHOCK, DO NOT EXPOSE THIS UNIT TO RAIN OR MOISTURE.

This unit is not disconnected from the AC power source as long as it is connected to the wall outlet, even if this unit itself is turned off. This state is called the standby mode. In this state, this unit is designed to consume a very small quantity of power.

FOR CANADIAN CUSTOMERS

To prevent electric shock, match wide blade of plug to wide slot and fully insert.
This Class B digital apparatus complies with Canadian ICES-003.

IMPORTANT

Please record the serial number of this unit in the space below.
MODEL:
Serial No.:
The serial number is located on the rear of the unit.
Retain this Owner's Manual in a safe place for future reference.

We Want You Listening For A Lifetime

YAMAHA and the Electronic Industries Association's Consumer Electronics Group want you to get the most out of your equipment by playing it at a safe level. One that lets the sound come through loud and clear without annoying blaring or distortion - and, most importantly, without affecting your sensitive hearing.

Since hearing damage from loud sounds is often undetectable until it is too late, YAMAHA and the Electronic Industries Association's Consumer Electronics Group recommend you to avoid prolonged exposure from excessive volume levels.



III CAUTION

CONTENTS

INTRODUCTION

| | |
|--|----------|
| FEATURES | 2 |
| GETTING STARTED | 3 |
| Supplied accessories | 3 |
| Installing batteries in the remote control | 3 |
| CONTROLS AND FUNCTIONS | 4 |
| Front panel | 4 |
| Remote control..... | 6 |
| Using the remote control | 7 |
| Front panel display | 8 |
| Rear panel | 10 |

PREPARATION

| | |
|--|-----------|
| SPEAKER SETUP | 11 |
| Speaker placement | 11 |
| Speaker connections | 12 |
| CONNECTIONS | 15 |
| Before connecting components..... | 15 |
| Connecting video components..... | 16 |
| Connecting audio components..... | 19 |
| Connecting the antennas | 21 |
| Connecting the power supply cord | 22 |
| Speaker impedance setting | 23 |
| Turning on the power..... | 23 |
| AUTO SETUP | 24 |
| Introduction..... | 24 |
| Optimizer microphone setup..... | 24 |
| Starting the setup | 25 |
| BASIC SETUP | 28 |
| Using BASIC setup..... | 28 |

BASIC OPERATION

| | |
|--------------------------------------|-----------|
| PLAYBACK | 30 |
| Basic operations..... | 30 |
| Selecting sound field programs | 32 |
| Selecting input modes..... | 34 |
| TUNING | 36 |
| Automatic and manual tuning..... | 36 |
| Presetting stations | 37 |
| Selecting preset stations..... | 39 |
| Exchanging preset stations | 39 |
| RECORDING | 40 |

SOUND FIELD PROGRAMS

| | |
|---|-----------|
| SOUND FIELD PROGRAM DESCRIPTIONS | 41 |
| For movie/video sources..... | 41 |
| For music sources | 43 |

ADVANCED OPERATION

| | |
|--|-----------|
| ADVANCED OPERATIONS | 44 |
| Selecting the OSD mode..... | 44 |
| Using the sleep timer | 44 |
| Manually adjusting speaker levels..... | 45 |
| Using the test tone | 46 |
| SET MENU | 47 |
| Using SET MENU | 48 |
| Manual setup: SOUND..... | 49 |
| Manual setup: INPUT..... | 54 |
| Manual setup: OPTION..... | 56 |
| REMOTE CONTROL FEATURES | 59 |
| Control area | 59 |
| Setting manufacturer codes..... | 60 |
| Programming codes from other remote controls | 61 |
| Changing source names in the display window..... | 62 |
| Using the macro feature..... | 63 |
| Clearing function sets | 65 |
| Clearing individual functions | 66 |
| Controlling each component..... | 67 |
| ZONE 2/ZONE 3 | |
| (U.S.A., Canada and Australia models only) .. | 72 |
| Zone 2/Zone 3 connections..... | 72 |
| Remote controlling Zone 2/Zone 3..... | 73 |

ADDITIONAL INFORMATION

| | |
|---|-----------|
| EDITING SOUND FIELD PARAMETERS | 75 |
| What is a sound field | 75 |
| Changing parameter settings | 75 |
| SOUND FIELD PARAMETER DESCRIPTIONS | 77 |
| TROUBLESHOOTING | 81 |
| GLOSSARY | 86 |
| SPECIFICATIONS | 89 |

INTRODUCTION

PREPARATION

BASIC OPERATION

SOUND FIELD PROGRAMS

ADVANCED OPERATION

ADDITIONAL INFORMATION

English

FEATURES

Built-in 7-channel power amplifier

- ◆ Minimum RMS Output Power
(0.04% THD, 20 Hz – 20 kHz, 8Ω)
Front: 120 W + 120 W
Center: 120 W
Surround: 120 W + 120 W
Surround Back: 120 W + 120 W

Sound field features

- ◆ Proprietary Yamaha technology for the creation of sound fields
- ◆ THX
- ◆ Dolby Digital/Dolby Digital EX Decoder
- ◆ DTS/DTS ES Matrix 6.1, Discrete 6.1, DTS Neo:6 Decoder, DTS 96/24
- ◆ Dolby Pro Logic/Dolby Pro Logic II Decoder
- ◆ Virtual CINEMA DSP
- ◆ SILENT CINEMA™

Sophisticated AM/FM tuner

- ◆ 40-Station Random Access Preset Tuning
- ◆ Automatic Preset Tuning
- ◆ Preset Station Shifting Capability (Preset Editing)

Other features

- ◆ YPAO: Yamaha Parametric Room Acoustic Optimizer for Automatic Speaker Setup
- ◆ 192-kHz/24-bit D/A Converter
- ◆ “SET MENU” which Provides You with Items for Optimizing This Unit for Your Audio/Video System
- ◆ 6 or 8-channel External Decoder Input for Other Future Formats
- ◆ On Screen Display Function Helpful in Controlling This Unit
- ◆ S Video Signal Input/Output Capability
- ◆ Component Video Input/Output Capability
- ◆ Video Signal Conversion (Composite Video ↔ S Video → Component Video) Capability for Monitor Out
- ◆ Optical and Coaxial Digital Audio Signal Jacks
- ◆ Sleep Timer
- ◆ Night Listening Mode
- ◆ Remote Control with Preset Manufacturer Codes and “Learning” Macro Capability
- ◆ Zone 2/Zone 3 Custom Installation Facility (U.S.A., Canada and Australia models only)

- ☼ indicates a tip for your operation.
- Some operations can be performed by using either the buttons on the main unit or on the remote control. In cases when the button names differ between the main unit and the remote control, the button name on the remote control is given in parentheses.
- This manual is printed prior to production. Design and specifications are subject to change in part as a result of improvements, etc. In case of differences between the manual and product, the product has priority.



Manufactured under license from Dolby Laboratories.

“Dolby”, “Pro Logic”, and the double-D symbol are trademarks of Dolby Laboratories.

SILENT CINEMA is a trademark of YAMAHA CORPORATION.



“DTS” and “DTS-ES Digital Surround” and “Neo:6” are trademarks of Digital Theater Systems, Inc.

THX SURROUND EX



THX and the THX logo are registered trademarks of THX Ltd. Surround EX is a jointly developed technology of THX and Dolby Laboratories, Inc. and is a trademark of Dolby Laboratories, Inc. All rights reserved. Used under authorization.

GETTING STARTED

Supplied accessories

Please check that you received all of the following parts.

Remote control

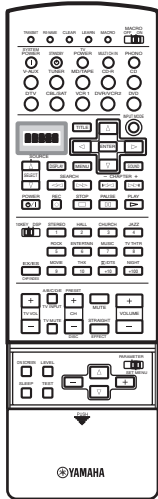

Batteries (3) (R6)

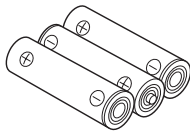

Speaker terminal wrench

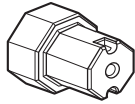

Optimizer microphone*

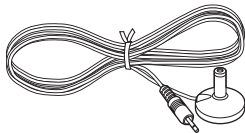

Power Cord (U.S.A., Canada and Europe models)

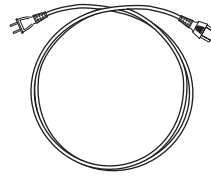

75-ohm/300-ohm antenna adapter (U.K. model only)

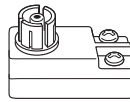

* The optimizer microphone is sensitive to heat.
 – Keep it away from direct sunlight.
 – Do not place it on top of this unit.

AM loop antenna



Indoor FM antenna (U.S.A., Canada, China, Korea, Asia and General models)

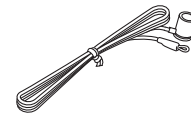

(U.K., Europe and Australia models)

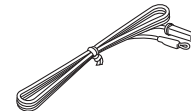

Installing batteries in the remote control

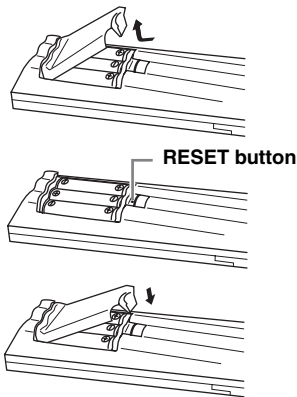

1 Open the battery compartment cover.

2 Insert the three supplied batteries (R6) in the correct direction by aligning the + and – marks on the batteries with the polarity markings (+ and –) on the inside of the battery compartment.

3 After the new batteries are correctly inserted, press the RESET button in the battery compartment using a ball point pen or similar object.

(This does not clear the contents of the memory.)

4 Replace the cover by pressing until it snaps into place.

Notes on batteries

- Change all of the batteries if you notice the condition like; the operation range of the remote control decreases, the indicator does not flash or its light becomes dim.
- Do not use old batteries together with new ones.
- Do not use different types of batteries (such as alkaline and manganese batteries) together. Read the packaging carefully as these different types of batteries may have the same shape and color.
- If the batteries have leaked, dispose of them immediately. Avoid touching the leaked material or letting it come into contact with clothing, etc. Clean the battery compartment thoroughly before installing new batteries.

If the remote control is without batteries for more than 3 minutes, or if exhausted batteries remain in the remote control, the contents of the memory may be cleared. When the memory is cleared, insert new batteries, set up the manufacturer code and program any acquired functions that may have been cleared.

CONTROLS AND FUNCTIONS

Front panel

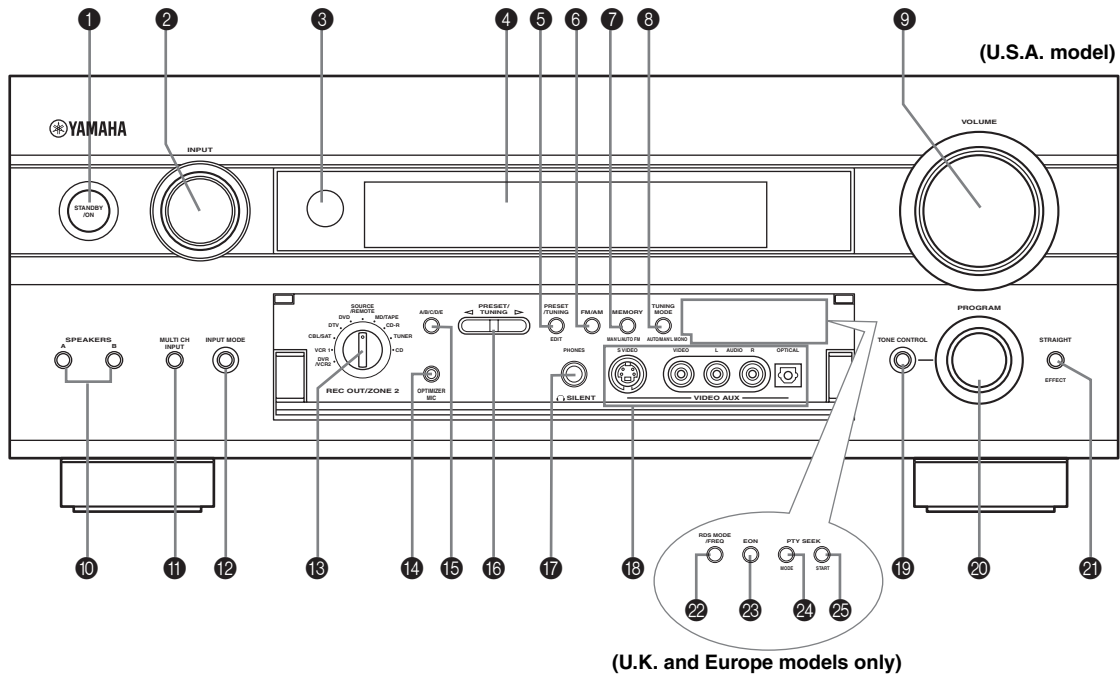

1 STANDBY/ON

Turns on this unit or sets it to the standby mode. When you turn on this unit, you will hear a click and there will be a 4 to 5-second delay before this unit can reproduce sound.

Note

In standby mode, this unit consumes a small amount of power in order to receive infrared-signals from the remote control.

2 INPUT selector

Selects the input source you want to listen to or watch.

3 Remote control sensor

Receives signals from the remote control.

4 Front panel display

Shows information about the operational status of this unit.

5 PRESET/TUNING EDIT

Switches the function of PRESET/TUNING </> between selecting preset station numbers and tuning.

6 FM/AM

Switches the reception band between FM and AM.

7 MEMORY (MAN'L/AUTO FM)

Stores a station in the memory. Hold down this button for more than 3 seconds to start automatic preset tuning.

8 TUNING MODE (AUTO/MAN'L MONO)

Switches the tuning mode between automatic ("AUTO" indicator on) and manual ("AUTO" indicator off).

9 VOLUME

Controls the output level of all audio channels. This does not affect the REC OUT level.

10 SPEAKERS A/B

Turn on or off the set of front speakers connected to the A and/or B terminals on the rear panel at each time the corresponding button is pressed.

11 MULTI CH INPUT

Selects the source connected to the MULTI CH INPUT jacks. When selected, the MULTI CH INPUT source takes priority over the source selected with INPUT (or the input selector buttons on the remote control).

12 INPUT MODE

Sets the priority (AUTO, DTS, ANALOG) for the type of signals received when one component is connected to two or more of this unit's input jacks (see page 34). Priority cannot be set when MULTI CH INPUT is selected as the input source.

13 REC OUT/ZONE 2**(U.S.A., Canada and Australia models)**

Selects the source you want to direct to the audio/video recorder and ZONE 2 outputs independently of the source you are listening to or watching in the main room. When set to the SOURCE/REMOTE position, the input source is directed to all outputs. The source in Zone 2 and the source you record are always identical

REC OUT (other models)

Selects the source you want to direct to the audio/video recorder independent of the source you are listening to or watching. When set to the SOURCE/REMOTE position, the input source is directed to all outputs.

14 OPTIMIZER MIC jack

Use to connect and input audio signals from the supplied microphone for use with the auto setup function (see page 24).

15 A/B/C/D/E

Selects one of the 5 preset station groups (A to E).

16 PRESET/TUNING </>

Selects preset station number 1 to 8 when the colon (:) is displayed next to the band indication in the front panel display.

Selects the tuning frequency when the colon (:) is not displayed.

17 SILENT (PHONES jack)

Outputs audio signals for private listening with headphones. When you connect headphones, no signals are output to the OUTPUT jacks or to the speakers. All Dolby Digital and DTS audio signals are mixed down to the front left and right channels.

18 VIDEO AUX jacks

Input audio and video signals from a portable external source such as a game console. To reproduce source signals from these jacks, select V-AUX as the input source.

19 TONE CONTROL

Use to adjust the bass/treble balance for the front left/right and center channels (see page 31).

20 PROGRAM

Use to select sound field programs or adjust bass/treble balance (in conjunction with TONE CONTROL).

21 STRAIGHT/EFFECT

Switches the sound fields off or on. When STRAIGHT is selected, input signals (2-channel or multi-channel) are output directly from their respective speakers without effect processing.

U.K. and Europe models only**22 RDS MODE/FREQ**

Press this button when the unit is receiving an RDS station to cycle the display mode between the PS mode, PTY mode, RT mode, CT mode (if the station offers those RDS data service) and/or the frequency display mode.

23 EON

Press this button to select a radio program type (NEWS, INFO, AFFAIRS, SPORT) to tune in automatically.

24 PTY SEEK MODE

Press this button to set the unit to the PTY SEEK mode.

25 PTY SEEK START

Press this button to begin searching for a station after the desired program type has been selected in the PTY SEEK mode.

Opening and closing the front panel door

When you want to use the controls behind the front panel door, open the door by gently pressing on the lower part of the panel. Keep the door closed when not using these controls.

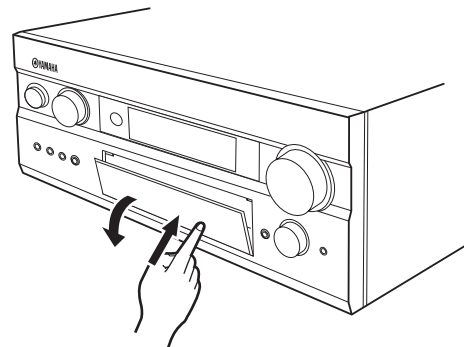

To open, press gently on the lower part of the panel.

CONTROLS AND FUNCTIONS**Remote control**

This section describes the function of each control on the remote control. See "REMOTE CONTROL FEATURES" on page 59 to operate other components with this remote control.

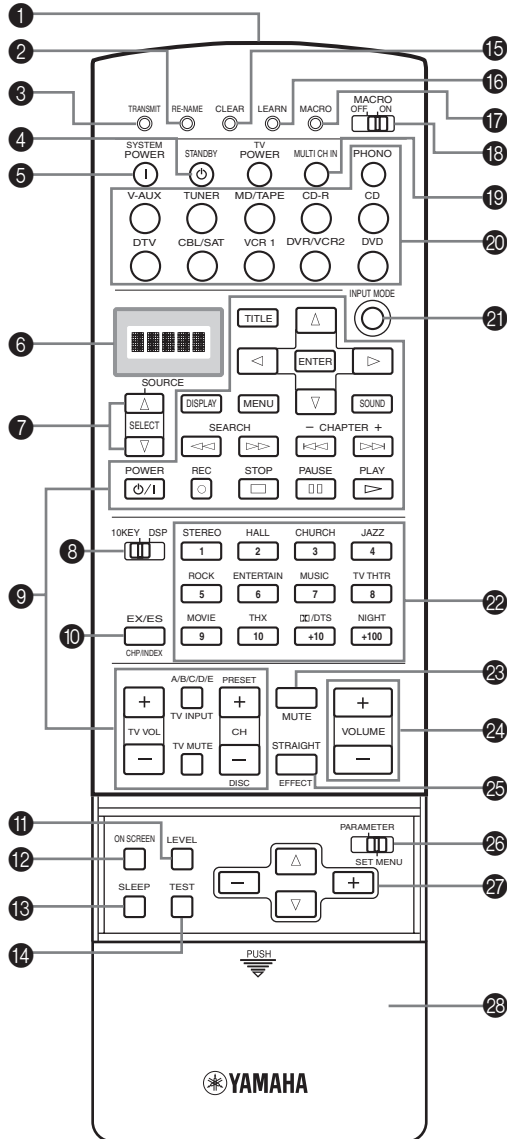
**1 Infrared window**

Outputs infrared control signals. Aim this window at the component you want to operate.

2 RE-NAME

Used for changing the input source name in the display window (see page 62).

3 TRANSMIT indicator

Flashes while the remote control is sending signals.

4 STANDBY

Sets this unit in the standby mode.

5 SYSTEM POWER

Turns on the power of this unit.

6 Display window

Shows the name of the selected source component that you can control.

7 SOURCE SELECT Δ/∇

Selects another component that you can control independently of the input component selected with the input selector buttons.

8 10KEY/DSP

Selects the numeric button (10KEY) or sound field program (DSP) operation mode.

9 Operation buttons

Provide functions such as play, stop, skip, etc. for use when operating other components.

10 EX/ES

Turns the Dolby Digital EX or DTS ES decoder on or off (when 10KEY/DSP is set to DSP).

11 LEVEL

Selects the speaker channel to be adjusted and sets the level.

12 ON SCREEN

Selects the on-screen display (OSD) mode for your video monitor.

13 SLEEP

Sets the sleep timer.

14 TEST

Outputs the test tone to adjust the speaker levels.

15 CLEAR

Used for clearing functions acquired when using the learn and rename features, or setting manufacturer codes (see page 65).

16 LEARN

Used for setting up the manufacturer code or for programming functions from other remote controls (see pages 60 and 61).

17 MACRO

Used to program a series of operations for control by a single button (see page 63).

18 MACRO ON/OFF

Turns the macro function on and off.

19 MULTI CH IN

Selects the MULTI CH INPUT mode when using an external decoder (etc.).

20 Input selector buttons

Select the input source and change the control area.

21 INPUT MODE

Sets the priority (AUTO, DTS, ANALOG) for the type of signals received when one component is connected to two or more of this unit's input jacks (see page 34). Priority cannot be set when MULTI CH INPUT is selected as the input source.

22 DSP program/Numeric buttons

Use to select sound field programs or input numbers according to the position of 10KEY/DSP.

23 MUTE

Mutes the sound. The MUTE indicator turns on when the MUTE function is on. Press again to restore the audio output to the previous volume level.

24 VOLUME +/-

Increases or decreases the volume level.

25 STRAIGHT/EFFECT

Switches the sound fields off or on. When STRAIGHT is selected, input signals (2-channel or multi-channel) are output directly from their respective speakers without effect processing.

26 PARAMETER/SET MENU

Selects the PARAMETER mode or SET MENU mode.

27 Cursor buttons $\Delta/\nabla/-/+$

Use to select and adjust DSP program parameters or SET MENU items according to the position of PARAMETER/SET MENU.

28 Cover

Slide down to use the concealed buttons for various setup and parameter operations.

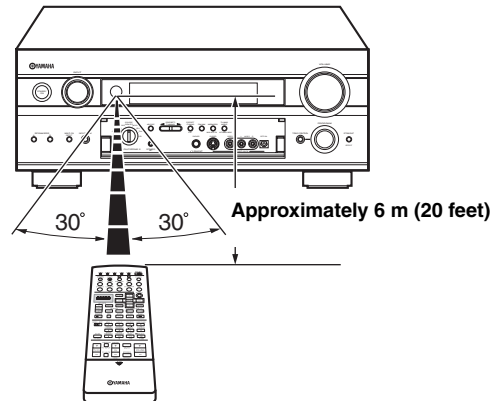
Using the remote control

The remote control transmits a directional infrared beam. Be sure to aim the remote control directly at the remote control sensor on the main unit during operation.

Handling the remote control

- Do not spill water or other liquids on the remote control.
- Do not drop the remote control.
- Do not leave or store the remote control in the following types of conditions:
 - high humidity such as near a bath
 - high temperature such as near a heater or stove
 - extremely low temperature
 - dusty places

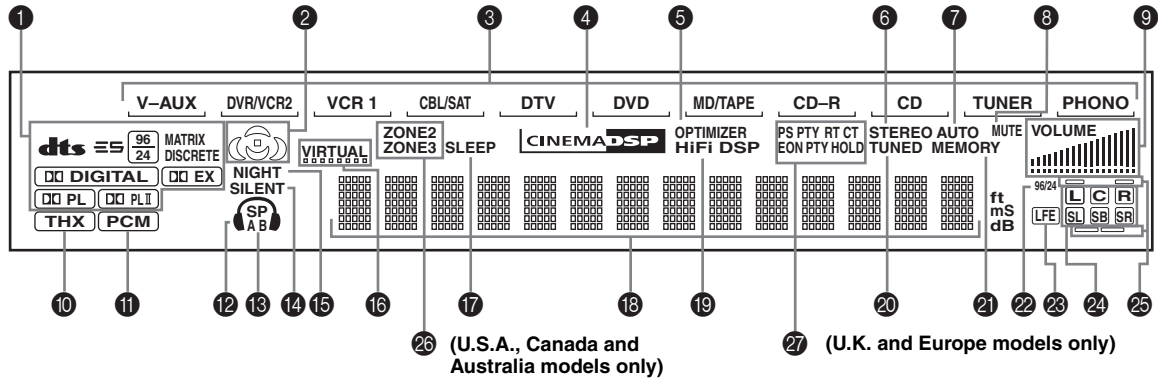
CONTROLS AND FUNCTIONS**Front panel display****1 Decoder indicators**

When any of this unit's decoders function, the respective indicator lights up.

2 Sound field indicators

Light to indicate the active DSP sound fields.

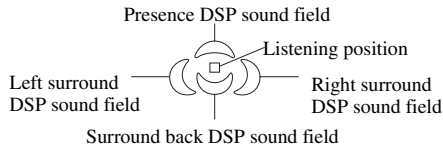
**3 Input source indicators**

A cursor lights to show the current input source.

4 CINEMA DSP indicator

Lights up when you select a CINEMA DSP sound field program.

5 OPTIMIZER indicator

Lights up during the auto setup procedure and when the auto setup speaker settings are used without any modifications.

6 STEREO indicator

Lights up when this unit is receiving a strong signal for an FM stereo broadcast while the "AUTO" indicator is lit.

7 AUTO indicator

Shows that this unit is in the automatic tuning mode.

8 MUTE indicator

Lights up while the MUTE function is on.

9 VOLUME level indicators

Indicate the volume level.

10 THX indicator

Lights up when a THX program is selected.

11 PCM indicator

Lights up when this unit is reproducing PCM (pulse code modulation) digital audio signals.

12 Headphones indicator

Lights up when headphones are connected.

13 SP A B indicators

Light up according to the set of front speakers selected. Both indicators light up when both sets of speakers are selected, or when bi-wiring.

14 SILENT CINEMA indicator

Lights up when headphones are connected and a sound field program is selected (see page 31).

15 NIGHT indicator

Lights up when you select NIGHT mode.

16 VIRTUAL indicator

Lights up when Virtual CINEMA DSP is active (see page 34).

17 SLEEP indicator

Lights up while the sleep timer is on.

18 Multi-information display

Shows the current sound field program name and other information when adjusting or changing settings.

19 HiFi DSP

Lights when you select a HiFi DSP sound field program

20 TUNED indicator

Lights up when this unit is tuned in to a station.

21 MEMORY indicator

Flashes to show a station can be stored.

22 96/24 indicator

Lights up when a DTS 96/24 signal is input to this unit.

23 LFE indicator

Lights up when the input signal contains the LFE signal.

24 Input channel indicators

Indicate the channel components of current digital input signal.

25 Presence and surround back speaker indicators

Indicate the connection of presence and/or surround back speakers when using the SPEAKERS setting (page 29) or SP LEVEL setting (page 50).

**26 ZONE 2/ZONE 3 indicators
(U.S.A., Canada and Australia models only)**

Light up while Zone 2 or Zone 3 signal is output.

**27 RDS indicators
(U.K. and Europe models only)**

The name(s) of the RDS data offered by the currently

received RDS station light(s) up.

EON lights up when an RDS station that offers the EON data service is being received.

PTY HOLD lights up while searching for stations in the PTY SEEK mode.

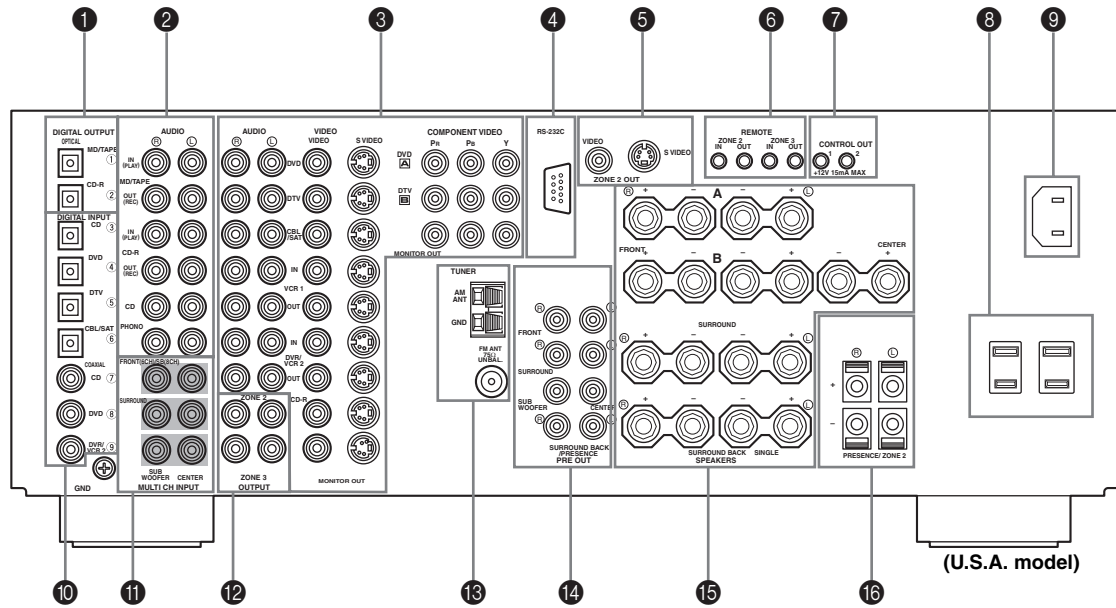
CONTROLS AND FUNCTIONS**Rear panel****1 DIGITAL OUTPUT jacks**

See page 19 for details.

2 Audio component jacks

See page 19 for connection information.

3 Video component jacks

See pages 16 and 18 for connection information.

4 RS-232C terminal

This is a control expansion terminal for commercial use. Consult your dealer for details.

5 ZONE 2 OUT jacks

(U.S.A., Canada and Australia models only)

See page 72 for details.

6 REMOTE IN/OUT jacks

(U.S.A., Canada and Australia models only)

See page 72 for details.

7 CONTROL OUT jacks

(U.S.A., Canada and Australia models only)

These are control expansion terminals for commercial use.

8 AC OUTLET(S)

Use to supply power to your other A/V components (see page 22).

9 AC INLET (U.S.A. and Canada models only)

Use this inlet to plug in the supplied power cable (see page 22).

10 DIGITAL INPUT jacks

See pages 16, 18 and 19 for details.

11 MULTI CH INPUT jacks

See page 17 for connection information.

12 ZONE 2 / ZONE 3 OUTPUT jacks

(U.S.A., Canada and Australia models only)

See page 72 for details.

13 Antenna terminals

See page 21 for connection information.

14 PRE OUT jacks

See page 20 for connection information.

15 Speaker terminals

See page 12 for connection information.

16 PRESENCE/ZONE 2 speaker terminals

(U.S.A., Canada and Australia models)

**PRESENCE speaker terminals
(other models)**

See page 12 for connection information.

< General models only >

FREQUENCY STEP switch

See page 21.

VOLTAGE SELECTOR

See page 22.

SPEAKER SETUP

Speaker placement

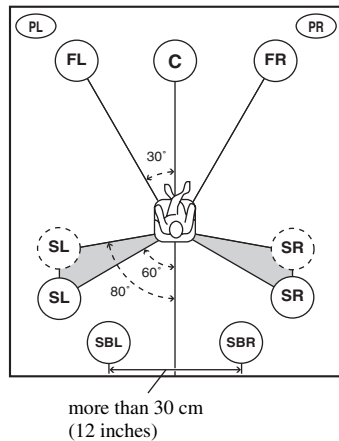

The speaker layout above shows the standard ITU-R speaker setting. You can use it to enjoy CINEMA DSP, multi-channel audio sources and THX.

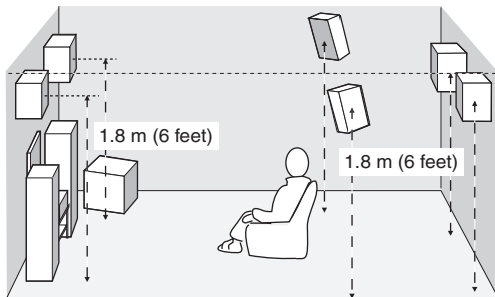

Front speakers (FR and FL)

The front speakers are used for the main source sound plus effect sounds. Place these speakers an equal distance from the ideal listening position. The distance of each speaker from each side of the video monitor should be the same.

Center speaker (C)

The center speaker is for the center channel sounds (dialog, vocals, etc.). If for some reason it is not practical to use a center speaker, you can do without it. Best results, however, are obtained with the full system. Align the front face of the center speaker with the front face of your video monitor. Place the speaker centrally between the front speakers and as close to the monitor as possible, such as directly over or under it.

Surround speakers (SR and SL)

The surround speakers are used for effect and surround sounds. Place these speakers behind your listening position, facing slightly inwards, about 1.8 m (6 feet) above the floor.

Surround back speakers (SBR and SBL)

The surround back speakers supplement the surround speakers and provide for more realistic front-to-back transitions. Place these speakers directly behind the listening position and at the same height as the surround speakers. They should be positioned at least 30 cm (12 inches) apart. Ideally, they should be positioned at the same width as the front speakers.

Subwoofer

The use of a subwoofer, such as the YAMAHA Active Servo Processing Subwoofer System, is effective not only for reinforcing bass frequencies from any or all channels, but also for high fidelity reproduction of the LFE (low-frequency effect) channel included in Dolby Digital and DTS software. The position of the subwoofer is not so critical, because low bass sounds are not highly directional. But it is better to place the subwoofer near the front speakers. Turn it slightly toward the center of the room to reduce wall reflections.

Presence speakers (PR and PL)

Presence speakers supplement the sound from the front speakers with extra ambient effects produced by CINEMA DSP (see page 41). These effects include sounds that filmmakers intend to locate a little farther back behind the screen in order to create more theater-like ambience. Place these speakers at the front of the room about 0.5 - 1 m (1-3 feet) outside the front speakers, facing slightly inwards, and about 1.8 m (6 feet) above the floor.

Di-pole speaker layout

Either di-pole or direct radiating speaker types can be used for THX surround. If you choose di-pole speakers, please place the surround and surround back speakers according to the speaker layout below.

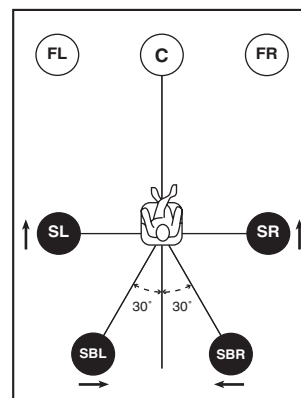

- :Di-pole speaker
- ↑ :Direction of di-pole speaker

SPEAKER SETUP**Speaker connections**

Be sure to connect the left channel (L), right channel (R), “+” (red) and “-” (black) properly. If the connections are faulty, no sound will be heard from the speakers, and if the polarity of the speaker connections is incorrect, the sound will be unnatural and lack bass.

CAUTION

- If you will use 6 ohm speakers, be sure to set this unit’s speaker impedance setting to 6 ohms before using (see page 23).
- Before connecting the speakers, make sure that the power of this unit is off.
- Do not let the bare speaker wires touch each other or do not let them touch any metal part of this unit. This could damage this unit and/or speakers.
- Use magnetically shielded speakers. If this type of speakers still creates the interference with the monitor, place the speakers away from the monitor.

A speaker cord is actually a pair of insulated cables running side by side. One cable is colored or shaped differently, perhaps with a stripe, groove or ridges. Connect the striped (grooved, etc.) cable to the “+” (red) terminals on this unit and your speaker. Connect the plain cable to the “-” (black) terminals.

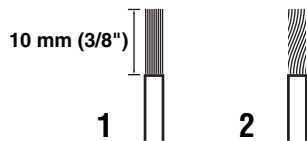

1 Remove approximately 10 mm (3/8") of insulation from each of the speaker cables.

2 Twist the exposed wires of the cable together to prevent short circuits.

3 Unscrew the knob.



Supplied speaker terminal wrench is useful to screw or unscrew knobs.

4 Insert one bare wire into the hole in the side of each terminal.

5 Tighten the knob to secure the wire.

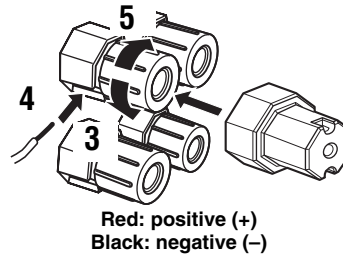

Connecting to PRESENCE/ZONE 2 or PRESENCE speaker terminals

1 Open the tab.

2 Insert one bare wire into the hole of each terminal.

3 Return the tab to secure the wire.

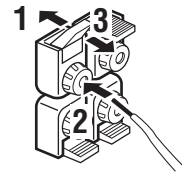
**Banana plug connections**

(With the exception of U.K., Europe and Asia models) First, tighten the knob and then insert the banana plug connector into the end of the corresponding terminal.

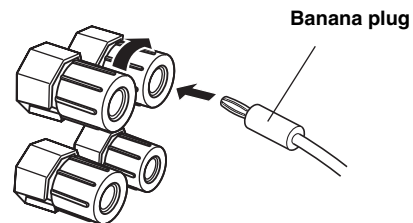

(With the exception of U.K., Europe and Asia models)

SPEAKER SETUP

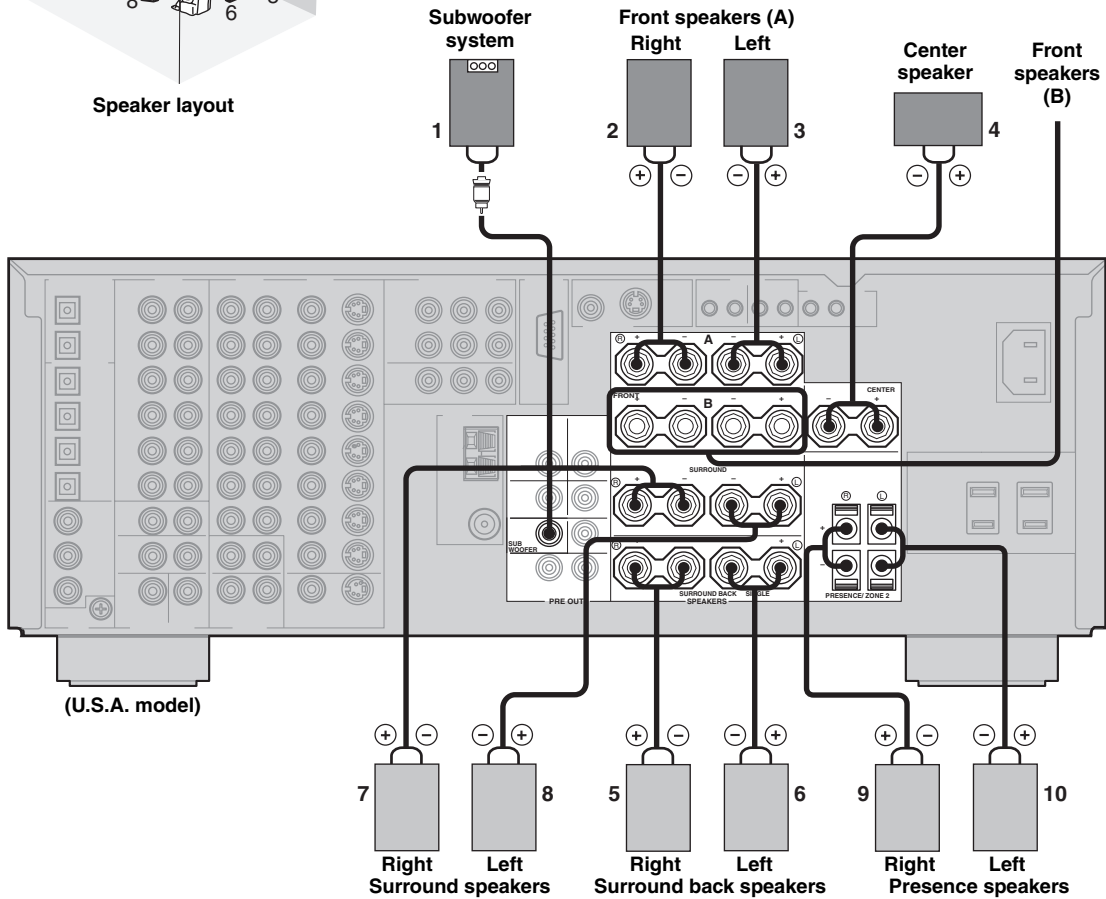
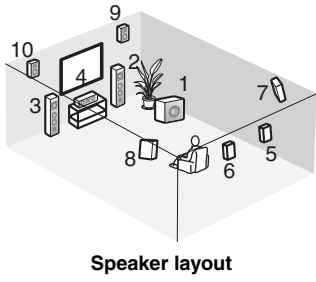

PREPARATION

You can connect both surround back and presence speakers to this unit, but they do not output sound simultaneously.

- The surround back speakers output the surround back channel included in Dolby Digital EX and DTS ES software and only operate when the Dolby Digital EX or DTS ES decoder is turned on.
- The presence speakers output ambient effects created by the DSP sound fields. They do not output sound when other sound fields are selected.

English

SPEAKER SETUP**FRONT terminals**

Connect one or two speaker systems to these terminals. If you use only one speaker system, connect it to either of the FRONT A or B terminals.

Note

The Canada model cannot output to two separate speaker systems simultaneously.

Bi-wired connection

The unit also allows you to make bi-wired connections to one speaker system. Use two pairs of speaker cables for each speaker (one pair for the woofer and one pair for the tweeter/mid-range). To use the bi-wired connections, press **SPEAKERS A** and **SPEAKERS B** on the front panel so that both **SP A** and **B** light up on the front panel display.

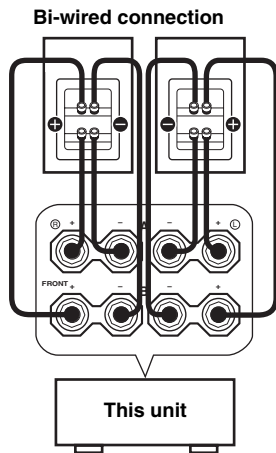
**CENTER terminals**

Connect a center speaker to these terminals.

SURROUND terminals

Connect surround speakers to these terminals.

SUBWOOFER jack

Connect a subwoofer with built-in amplifier, such as the YAMAHA Active Servo Processing Subwoofer System, to this jack.

SURROUND BACK terminals

Connect surround back speakers to these terminals. If you only connect one surround back speaker, connect it to the left (L) terminals.

PRESENCE terminals

Connect presence speakers to these terminals.

* If you are using either U.S.A., Canada or Australia model, you can also use these speakers as Zone 2 speakers (see page 57).

CONNECTIONS

Before connecting components

CAUTION

Do not connect this unit or other components to the mains power until all connections between components are complete.

Signal directions and cable indications

audio signal direction 

video signal direction 

For analog signals

left analog cables 

right analog cables 

For digital signals

optical cables 

coaxial cables 

For video signals

video cables 

S-video cables 

Analog jacks

You can input analog signals from audio components by connecting audio pin cable to the analog jacks on this unit. Connect red plugs to the right jacks and white plugs to the left jacks.

Digital jacks

This unit has digital jacks for direct transmission of digital signals through either coaxial or fiber optic cables. You can use the digital jacks to input PCM, Dolby Digital and DTS bitstreams. When you connect components to both the COAXIAL and OPTICAL jacks, priority is given to the input signals from the COAXIAL jack. All digital input jacks are compatible with 96-kHz sampling digital signals.

Note

This unit handles digital and analog signals independently. Thus audio signals input to the analog jacks are only output to the analog OUT (REC) jacks. Likewise audio signals input to the digital (OPTICAL or COAXIAL) jacks are only output to the DIGITAL OUTPUT jacks.

Dust protection cap

Pull out the cap from the optical jack before you connect the fiber optic cable. Do not discard the cap. When you are not using the optical jack, be sure to put the cap back in place. This cap protects the jack from dust.



Video jacks

This unit has three types of video jacks. Connection depends on the availability of input jacks on your monitor. The signals input through the VIDEO jack on this unit can be output through the S VIDEO and COMPONENT VIDEO jacks (see page 56). The signals input through the S VIDEO jack can be output through the VIDEO jack when V CONV. is set to ON (see page 56).



VIDEO jack

For conventional composite video signals.

S VIDEO jack

For S-video signals, separated into luminance (Y) and color (C) video signals to achieve high-quality color reproduction.

COMPONENT VIDEO jacks

For component signals, separated into luminance (Y) and color difference (Pb, Pr) to provide the best quality in picture reproduction.

Note

When signals are input through both the S VIDEO and VIDEO jacks, signals input through the S VIDEO jack has priority.

CONNECTIONS

Connecting video components

■ **Connections for DVD playback**

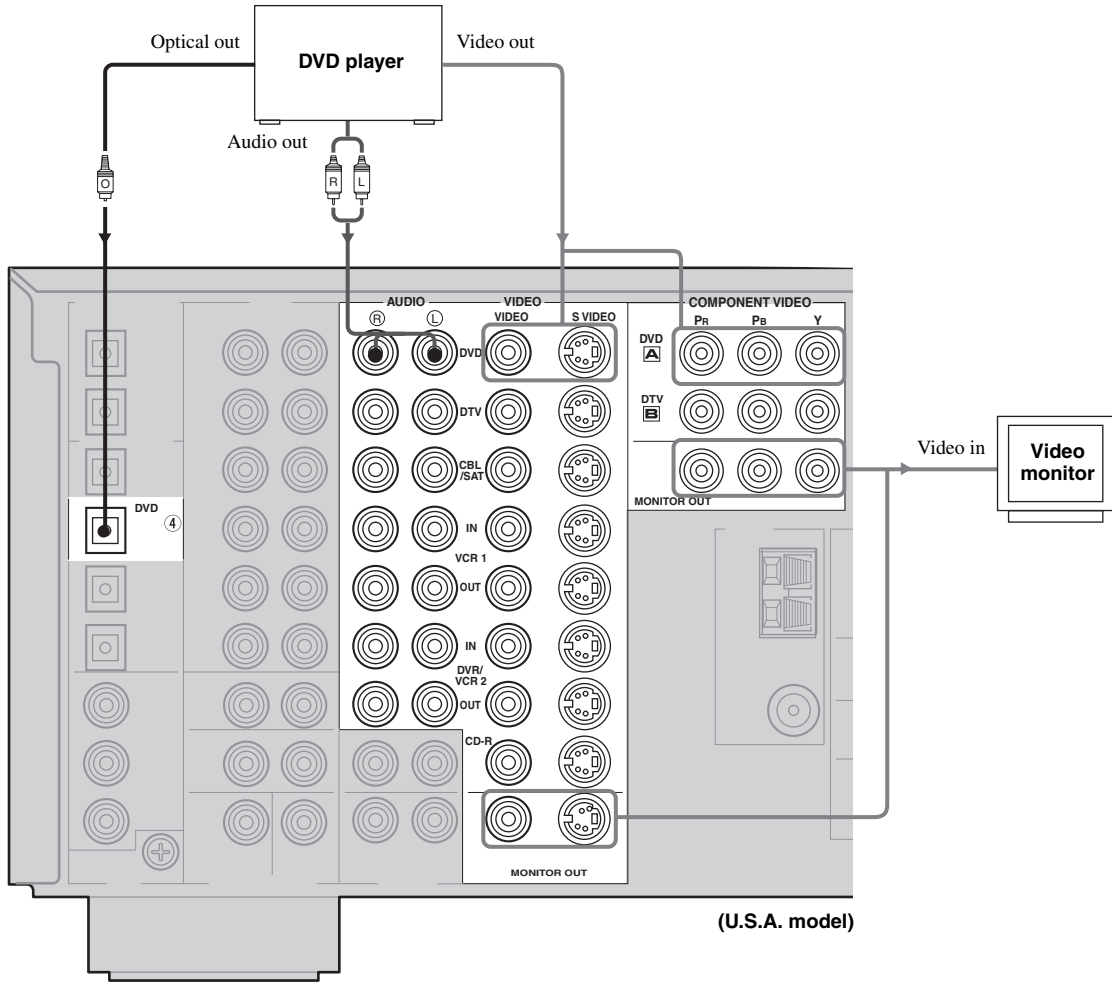

■ Connecting to the MULTI CH INPUT jacks

This unit is equipped with 6 additional input jacks (left and right FRONT, CENTER, left and right SURROUND and SUBWOOFER) for discrete multi-channel input from a multi-disc player, external decoder, sound processor or pre-amplifier.

If you set EXT.INPUT 6ch/8ch to "8ch" (see page 55), you can use input jacks assigned in EXT.INPUT FRONT (page 55) together with the MULTI CH INPUT jacks to input 8 channels.

Connect the output jacks on your multi-disc player or external decoder to the MULTI CH INPUT jacks. Be sure to match the left and right outputs to the left and right input jacks for the front and surround channels.

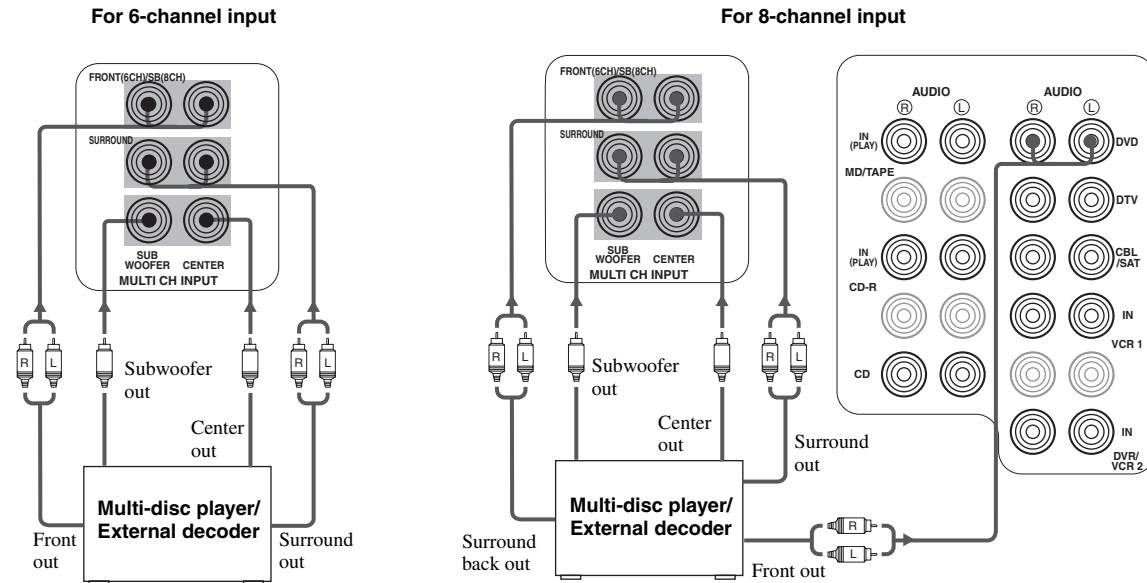

Notes

- When you select MULTI CH INPUT as the input source, this unit automatically turns off the digital sound field processor, and you cannot select sound field programs.
- This unit does not redirect signals input to the MULTI CH INPUT jacks to accommodate for missing speakers. We recommend that you connect at least a 5.1-channel speaker system before using this feature.
- When headphones are used, only front L/R channels are output.

CONNECTIONS

■ Connections for other video components

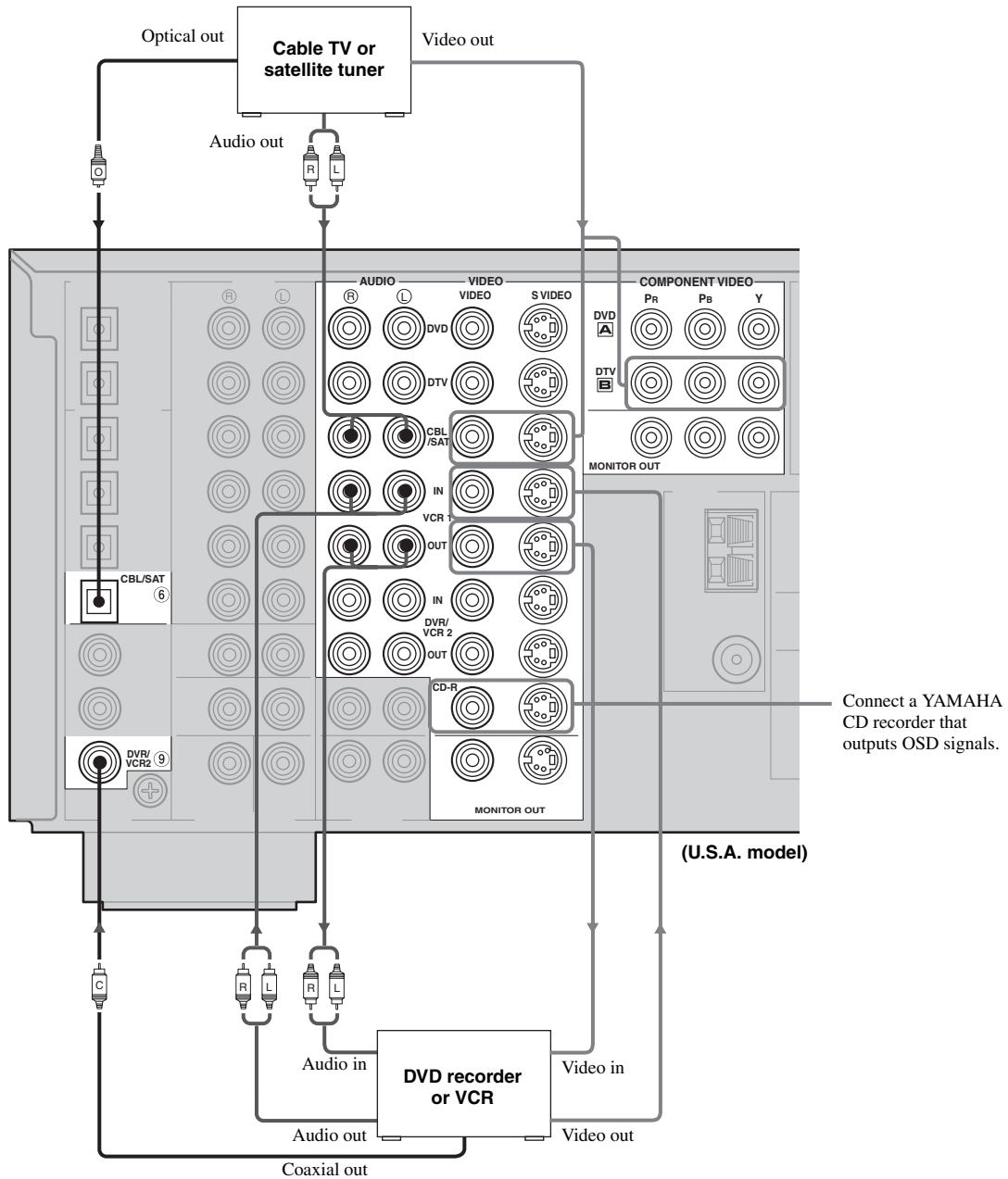

■ VIDEO AUX jacks (on the front panel)

Use these jacks to connect any video source, such as a game console or camcorder, to this unit.

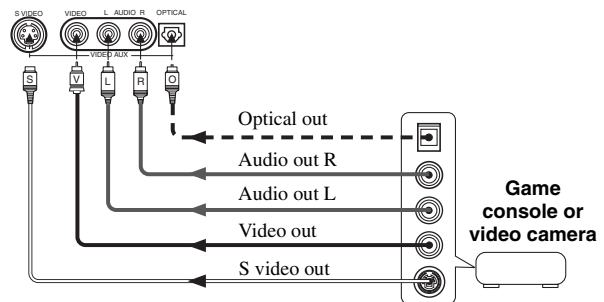

Connecting audio components

■ Connections for audio components

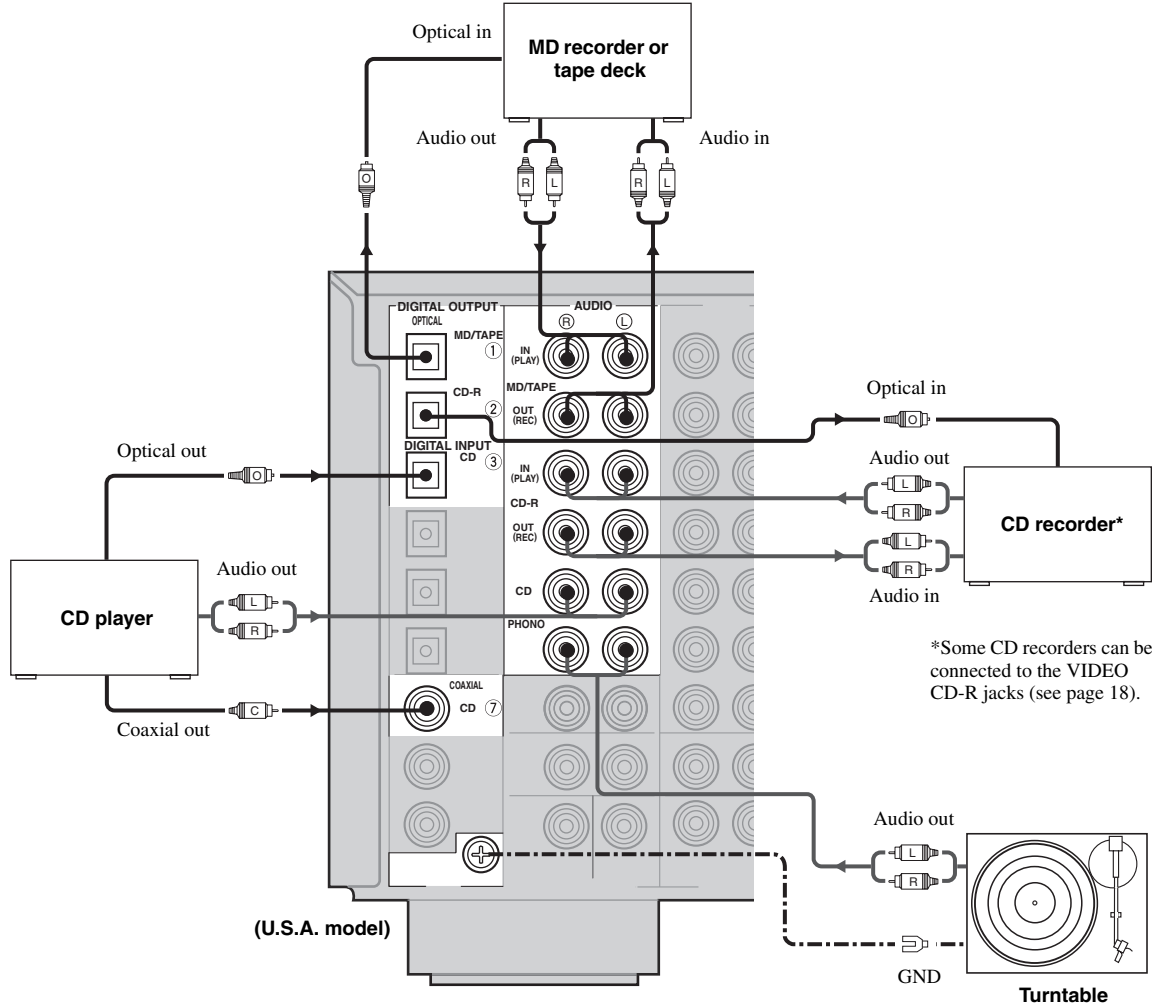

PREPARATION

■ Connecting a turntable

PHONO jacks are for connecting a turntable with an MM or high-output MC cartridge. If you have a turntable with a low-output MC cartridge, use an in-line boosting transformer or MC-head amplifier when connecting to these jacks.



Connect your turntable to the GND terminal to reduce noise in the signal. However you may hear less noise without the connection to the GND terminal for some record players.

English

CONNECTIONS

■ Connecting to an external amplifier

If you want to increase the power output to the speakers, or want to use another amplifier, connect an external amplifier to the PRE OUT jacks as follows.

Notes

- When audio pin plugs are connected to the PRE OUT jacks for output to an external amplifier, it is not necessary to use the corresponding SPEAKERS terminals. Set the volume of the amplifier connected to this unit to the maximum.
- The signal output through the FRONT PRE OUT and CENTER PRE OUT jacks are affected by the TONE CONTROL settings.
- Signals will only be output from the FRONT PRE OUT jacks when SPEAKER A is turned off with ZONE B selected for SP B SET (see page 57).

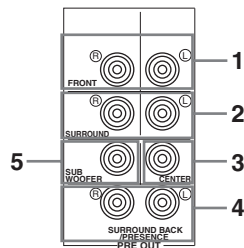

1 FRONT PRE OUT jacks

Front channel line output jacks.

2 SURROUND PRE OUT jacks

Surround channel line output jacks.

3 CENTER PRE OUT jack

Center channel line output jack.

4 SURROUND BACK / PRESENCE PRE OUT jacks

Surround back or presence channel line output jacks.

5 SUBWOOFER PRE OUT jack

Connect a subwoofer with built-in amplifier, such as the YAMAHA Active Servo Processing Subwoofer System, to this jack.

Notes

- Each PRE OUT jack outputs the same channel signal as the corresponding speaker terminals. However, when both surround back and presence speakers are connected to this unit, the channel of the signals output from SURROUND BACK / PRESENCE PRE OUT jacks may not correspond to the location of the speakers connected through SURROUND BACK / PRESENCE PRE OUT jacks.
- Adjust the volume level of the subwoofer with the control on the subwoofer. It is also possible to adjust the volume level by using the remote control of this unit (see "Manually adjusting speaker levels" on page 45.).
- Some signals may not be output from the SUBWOOFER jack depending on the SPEAKER SET (see page 49) and LFE LEVEL (see page 51) settings.

Connecting the antennas

Both AM and FM indoor antennas are included with this unit. In general, these antennas should provide sufficient signal strength. Connect each antenna correctly to the designated terminals.

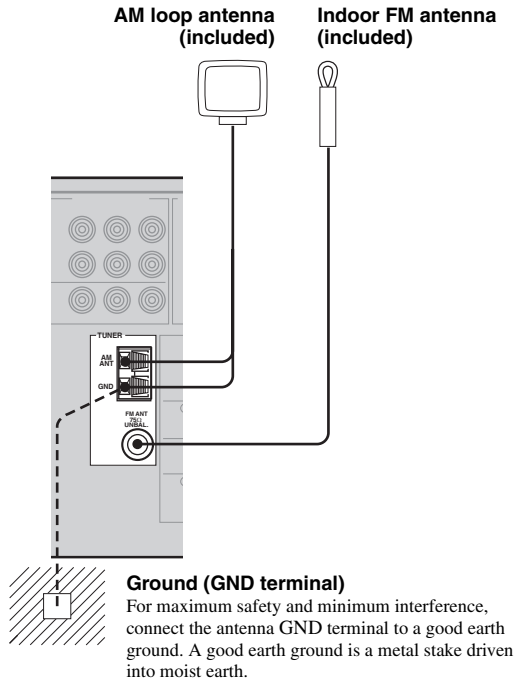

Connecting the AM loop antenna

- 1 Set up the AM loop antenna, then connect it to the terminals on this unit.

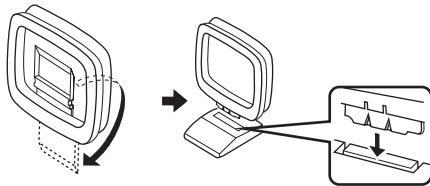

- 2 Press and hold the tab to insert the AM loop antenna lead wires into the AM ANT and GND terminals.



- 3 Orient the AM loop antenna for the best reception.



Notes

- The AM loop antenna should be placed away from this unit.
- The AM loop antenna should always be connected, even if an outdoor AM antenna is connected to this unit.
- A properly installed outdoor antenna provides clearer reception than an indoor one. If you experience poor reception quality, an outdoor antenna may improve the quality. Consult the nearest authorized YAMAHA dealer or service center about outdoor antennas.

75-ohm/300-ohm antenna adapter (U.K. model only)

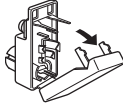
- 1 Open the cover of the included 75-ohm/300-ohm antenna adapter. 
- 2 Cut the external sleeve of the 75-ohm coaxial cable and prepare it for connection.

| | |
|-----------|--------------------|
| 11 (7/16) | Unit: mm (inch) |
| 8 (5/16) | |
| 6 (1/4) | |

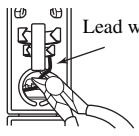
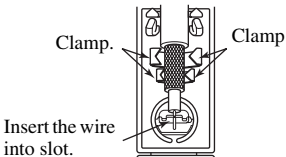
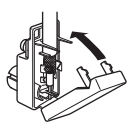
- 3 Cut the lead wire and remove it. 
- 4 Insert the cable wire into the slot, and clamp it with pliers. 
- 5 Snap the cover into place. 

FREQUENCY STEP switch (General models only)

Because the interstation frequency spacing differs in different areas, set the FREQUENCY STEP switch (locating on the rear panel) according to the frequency spacing in your area.

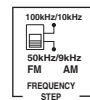

- North, Central and South America: 100 kHz/10 kHz
- Other areas: 50 kHz/9 kHz

Before setting this switch, disconnect this unit's AC power cord from the wall outlet.

CONNECTIONS

Connecting the power supply cord

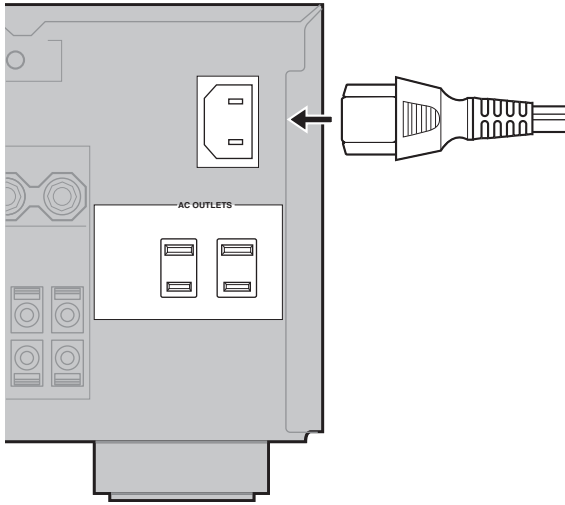

(U.S.A. model)

VOLTAGE SELECTOR

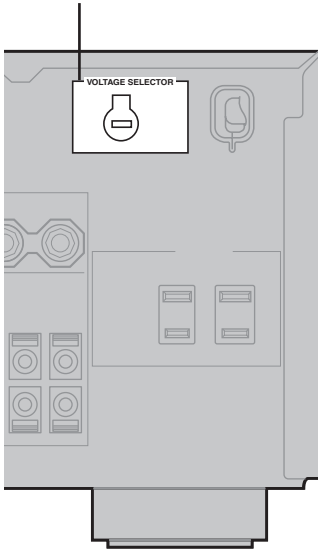

(General models)

■ **Connecting the AC power cord (U.S.A. and Canada models)**

Plug the power cord into the AC inlet after all other connections are complete, then plug the power cord to an AC wall outlet.

CAUTION

Do not use other AC power cords. Use the one provided. Use of other power cords may result in fire hazard or electrical shock.

(Other models)

Plug the power cord into an AC wall outlet.

■ **AC OUTLET(S) (SWITCHED)**

U.K. and Australia models..... 1 OUTLET
 Korea model..... None
 Other models..... 2 OUTLETS

Use these outlets to connect the power cords from your other components to this unit. Power to the AC OUTLETS(S) is controlled by this unit's STANDBY/ON (or SYSTEM POWER and STANDBY). These outlets will supply power to any connected component whenever this unit is turned on. The maximum power (total power consumption of components) that can be connected to the AC OUTLETS(S) is:

Asia and General models 50 W
 Korea model..... N/A
 Other models 100 W

■ **VOLTAGE SELECTOR (Asia and General models only)**

The VOLTAGE SELECTOR on the rear panel of this unit must be set for your local main voltage BEFORE plugging into the AC main supply. Voltages are 110/120/220/230-240 V AC, 50/60 Hz.

■ **Memory back-up**

The memory back-up circuit prevents the stored data from being lost even if this unit is in the standby mode.

However if the power cord is disconnected from the AC wall outlet, or the power supply is cut for more than one week, the stored data will be lost.

Speaker impedance setting

CAUTION

If you are using 6 ohm speakers, set the impedance to 6 ohms as follows before turning on the power.

Be sure this unit is in the standby mode.

- 1 On the front panel, while pressing down **SPEAKERS A**, press **STANDBY/ON**.
“SP IMP.SET” appears on the front panel display for a few seconds, then “Minimum 8ohms” appears.

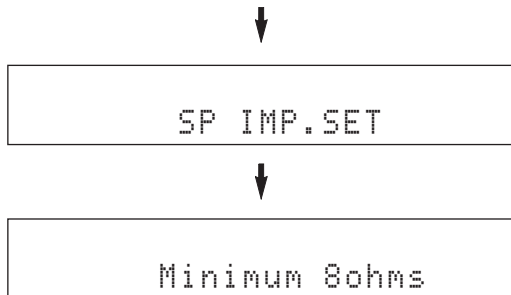

- 2 Press **SPEAKERS A** or **SPEAKERS B** to select the impedance of your speakers.
You can select either 6 ohms or 8 ohms.

- 3 Press **STANDBY/ON** to exit the setting.

This unit will be set to the standby mode.



You can also use SP IMP.SET (see page 57) to set the speaker impedance.

Turning on the power

When all connections are complete, turn on the power of this unit.

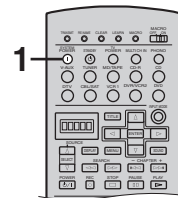
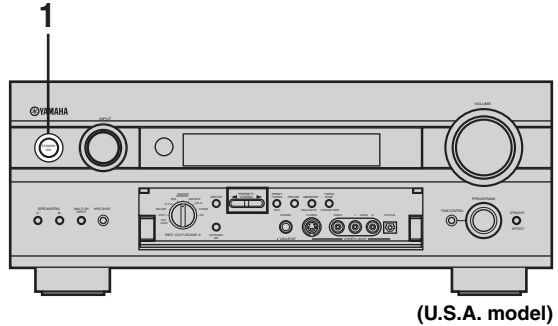

- 1 Press **STANDBY/ON** (**SYSTEM POWER** on the remote control) to turn on the power of this unit.

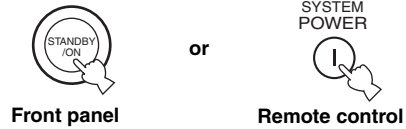

- 2 Turn on the video monitor connected to this unit.

AUTO SETUP

Introduction

This receiver employs Yamaha Parametric Room Acoustic Optimizer (YPAO) technology which lets you avoid troublesome listening-based speaker setup and achieves highly accurate sound adjustments. The supplied optimizer microphone collects and analyzes the sound your speakers produce in your actual listening environment.



The basic setup feature (page 28) is useful if you want to set up your system quickly and with minimal effort. However, we recommend that you come back and perform auto setup later to take advantage of YPAO and enjoy even higher fidelity.

Notes

- Loud test tones are output during the auto setup procedure. Please be ready!
- If auto setup stops and error messages appear on the OSD, follow the troubleshooting on page 27.

YPAO performs the following checks and makes appropriate adjustments to give you the best possible sound from your system.

WIRING

Checks which speakers are connected and the polarity of each speaker.

DISTANCE

Checks the distance of each speaker from the listening position and adjusts the timing of each channel.

SIZE

Checks the speaker's frequency response and sets the appropriate low frequency crossover for each channel.

EQUALIZING

Adjusts frequency and levels of each channel's parametric equalizer to reduce coloration across the channels and create a cohesive sound field. This is particularly important if you use different brands or sizes of speakers for some channels or have a room with unique sonic characteristics.

LEVEL

Checks and adjusts the sound level (volume) of each speaker.

Optimizer microphone setup

- 1 Connect the supplied optimizer microphone to the MIC jack on the front panel.

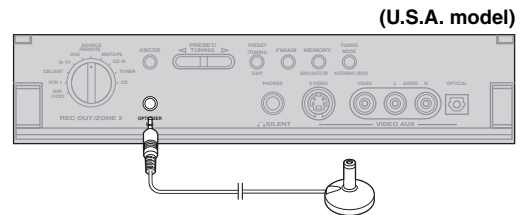

- 2 Place the optimizer microphone on a flat level surface with the omni-directional microphone head upward, at your normal listening position.

- If possible, use a tripod (etc.) to affix the optimizer mic at the same height as your ears would be when you are seated in your listening position.

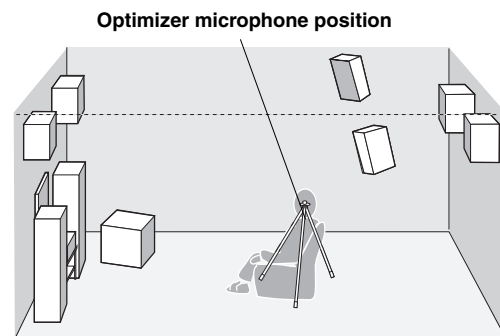

Starting the setup

For best results, make sure the room is as quiet as possible during the auto setup procedure. If there is too much ambient noise, the results may not be satisfactory.



If your subwoofer can adjust the output volume and the crossover frequency, set the volume to about half way (or slightly less) and set the crossover frequency to the maximum.

1 Switch on the receiver and video monitor.

Make sure the OSD is displayed.

2 Set PARAMETER/SET MENU to SET MENU.



3 Press Δ/∇ to select AUTO SETUP, then press + once to enter the main menu.

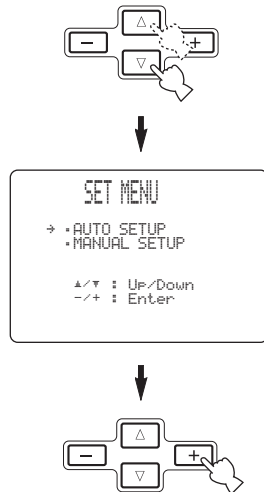

4 Press Δ/∇ repeatedly to select WIRING, DISTANCE, SIZE, EQUALIZING or LEVEL.

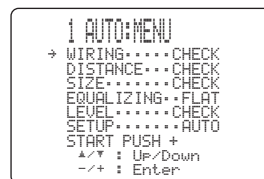

5 When WIRING, DISTANCE, SIZE or LEVEL is selected, press $-/+$ to select:

- CHECK** To automatically check and adjust the selected item.
- SKIP** To skip the selected item and perform no adjustments.



When using THX, select SKIP and make sure that SMALL or SMLx2 is selected in SPEAKER SET (page 49) and that 80Hz is selected in CROSS OVER (page 50).

When EQUALIZING is selected, press $-/+$ to select:

- FRONT** To adjust the frequency response of each speaker in accordance with the sound of your front speakers. Recommended if your front speakers are of much higher quality than your other speakers.
- FLAT** To average the frequency response of all speakers. Recommended if all of your speakers are of similar quality.
- LOW** To average the frequency response of all speakers, giving priority to the accuracy of bass frequencies.
- MID** To average the frequency response of all speakers, giving priority to the accuracy of mid-range frequencies.
- HIGH** To average the frequency response of all speakers, giving priority to the accuracy of high frequencies.
- SKIP** To skip the selected item and perform no adjustments.

6 Press ∇ to select SETUP, then press $-/+$ to select:

- AUTO** To automatically perform the entire auto setup procedure.
- STEP** To pause for confirmation between each check in the auto setup procedure.
- RELOAD** To restore the last auto setup setting.

7 Press ∇ to select Start?, then press +.

Loud test tones will be output from each speaker and WAIT appears during the auto setup procedure.

AUTO SETUP**If you selected AUTO in step 6**

The RESULT display appears for a few seconds after each check, then settings of the next item will start. The RESULT:EXIT display appears after all items are set.



You can display each result by pressing Δ once and pressing + repeatedly before exiting. Pressing ∇ returns to the RESULT:EXIT display.

8 To apply the changes, press -/+ to select SET, then press ∇ to exit.

To cancel the auto setup procedure, press -/+ to select CANCEL, then press ∇ to exit.

If you selected RELOAD in step 6

The RESULT:EXIT display appears.



You can display each result by pressing Δ once and pressing + repeatedly before exiting. Pressing ∇ returns to the RESULT:EXIT display.

8 Press -/+ to select SET, then press ∇ to exit.

If you selected STEP in step 6

The RESULT display appears after each check.

8 Press -/+ to display RESULT:EXIT, then press -/+ to select:

NEXT Then press ∇ to proceed and check the next item.
EXIT Then press ∇ to exit the auto setup.

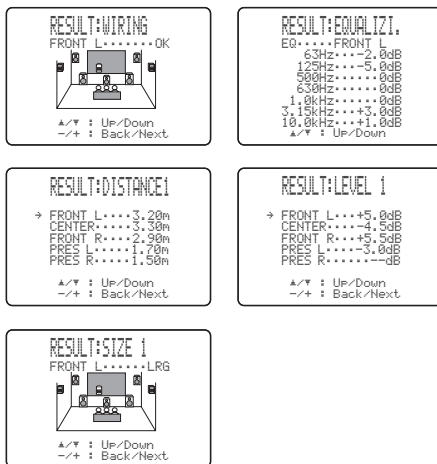

- Press Δ/∇ repeatedly to move between each display.
- If you are not satisfied with the result or want to manually adjust each setup parameter, use the manual setup parameters (see page 49).

Note

If you change speakers, speaker positions, or the layout of your listening environment, perform auto setup again to re-calibrate your system.

■ Troubleshooting for auto setup procedure

Before auto setup

| Error message | Cause | Remedy |
|---------------|--|---|
| Connect MIC! | Optimizer microphone is not connected. | <ul style="list-style-type: none"> Connect the supplied optimizer microphone to the OPTIMIZER MIC jack on the front panel. |
| Unplug HP! | Headphones are connected. | <ul style="list-style-type: none"> Unplug the headphones. |

During auto setup

Press **-/+** to display the detailed information about the individual error. Select **RETRY** to try auto setup procedure again.

| Error message | Cause | Remedy |
|-----------------|---|--|
| E-1:NO FRONT SP | Front L/R channel signal(s) is(are) not detected. | <ul style="list-style-type: none"> Select the front speakers with SPEAKER A or B. Check the front L/R speaker connections. |
| E-2:NO SURR. SP | A surround channel signal is not detected. | <ul style="list-style-type: none"> Check the surround speaker connections. |
| E-3:NO PRES. SP | A presence channel signal is not detected. | <ul style="list-style-type: none"> Check the presence speaker connections. |
| E-4:SBR->SBL | Only right surround back channel signal is detected. | <ul style="list-style-type: none"> Connect the surround back speaker to the LEFT SURROUND BACK SPEAKERS terminal if you only have one surround back speaker. |
| E-5:NOISY | Background noise is too loud. | <ul style="list-style-type: none"> Try auto setup procedure in quiet environment. Turn off noisy electric equipment like air conditioners (etc.) or move it away from this unit. |
| E-6:CHECK SURR. | Surround back speaker(s) is(are) connected, though surround L/R speakers are not. | <ul style="list-style-type: none"> Connect surround speakers when you use (a) surround back speaker(s). |
| E-7:NO MIC | The optimizer microphone was unplugged during the auto setup procedure. | <ul style="list-style-type: none"> Connect the supplied optimizer microphone to OPTIMIZER MIC jack on the front panel. |
| E-8:NO SIGNAL | The optimizer microphone does not detect test tones. | <ul style="list-style-type: none"> Check the microphone setting. Check the speaker connections and placement. |
| E-9:USER CANCEL | The auto setup procedure was cancelled because a setting which affects the auto setup was changed during the procedure. | <ul style="list-style-type: none"> Perform the auto setup procedure again. |

After auto setup

Press **-/+** to display the detailed information about the individual error.

| Warning message | Cause | Remedy |
|---------------------|--|--|
| W-1:OUT OF PHASE | Speaker polarity is not correct. This message may appear depending on the speakers even when the speakers are connected correctly. | <ul style="list-style-type: none"> Check the speaker connections. |
| W-2:OVER 24m (80ft) | The distance between the speaker and the listening position is over 24 meters (80ft). | <ul style="list-style-type: none"> Bring the speaker closer to the listening position. |
| W-3:LEVEL ERROR | The difference of volume level among speakers is excessive. (No level correction is made.) | <ul style="list-style-type: none"> Readjust the speaker installation. Check the speaker connections. Use speakers of similar quality. Adjust the output volume of the subwoofer. |
| W-4:SWFR PHASE | The phase polarity of the subwoofer is not correct. | <ul style="list-style-type: none"> We recommend that you select the opposite phase on the subwoofer if the subwoofer has a phase switch. |
| W-5:VOL ERROR | The result may not be correct because the volume was changed during the auto setup procedure. | <ul style="list-style-type: none"> Perform the auto setup procedure again. Do not change the volume during the auto setup procedure. |

- If the warning message W-2 or W-3 appears on the OSD, no corrections are made. In such cases, correct the problem, select **CHECK** in **DISTANCE** or **LEVEL**, then perform the auto setup procedure again.
- If the message W-1, W-4 or W-5 appears on the OSD, corrections are made. However, the corrections may not be correct. In such cases, correct the problem, then perform the auto setup procedure again on the relevant setting items.

BASIC SETUP

The basic system parameters are set automatically when you run auto setup (page 24). The basic settings are useful if you want to quickly setup your speakers or to manually adjust some of the items set in auto setup.



- If you wish to configure the unit manually using more precise adjustments, use the detailed parameters in the SOUND menu (page 49) instead of using the BASIC menu.
- Altering any parameters in the BASIC menu will reset all parameters in the SOUND menu.

Using BASIC setup

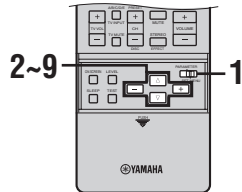

- 1 Set **PARAMETER/SET MENU** to **SET MENU**.



- 2 Press Δ/∇ repeatedly to select **MANUAL SETUP**, then press $-/+$ to enter the selected category.



If Δ is pressed when **AUTO SETUP** is selected, or if ∇ is pressed when **MANUAL SETUP** is selected, **SET MENU** will be closed. Press Δ/∇ to open **SET MENU** again.

- 3 Press ∇ once to select **BASIC MENU**, then press $-/+$ to enter the menu item.

- 4 When **ROOM** is selected, press $-/+$ to change the setting.

Select the size of the room you have installed your speakers in. Roughly speaking, the room sizes are defined as follows:

[U.S.A. and Canada models]

S (small) 16 x 13ft, 200ft² (4.8 x 4.0m, 20m²)

M (medium) 20 x 16ft, 300ft² (6.3 x 5.0m, 30m²)

L (large) 26 x 19ft, 450ft² (7.9 x 5.8m, 45m²)

[Other models]

S (small) 3.6 x 2.8m, 10m²

M (medium) 4.8 x 4.0m, 20m²

L (large) 6.3 x 5.0m, 30m²



- 5 Press ∇ to select **SWFR**, then press $-/+$ to select:

YES If you have a subwoofer in your system.

NONE If you do not have a subwoofer in your system.

- 6 Press ∇ to select **PRESENCE**, then press $-/+$ to select:

YES If you have presence speakers in your system.

NONE If you have presence speakers in your system.

7 Press ∇ to select SPEAKERS, then press $-/+$ to select the number of speakers connected to the unit.

The choices vary as follows depending on the PRESENCE setting:

| Choices | PRESENCE setting | | | |
|---------|------------------|--|----------------|--|
| | YES | | NONE | |
| 2 | — | — | L R | Front L/R |
| 3 | — | — | L C R | Front L/R, Center |
| 4 | L R | Presence L/R, Front L/R | L R SL SR | Front L/R, Surround L/R |
| 5 | L C R | Presence L/R, Front L/R, Center | L C R SL SR | Front L/R, Center, Surround L/R |
| 6 | L R SL SR | Presence L/R, Front L/R, Surround L/R | L C R SL SB SR | Front L/R, Center, Surround L/R, Surround back |
| 7 | L C R SL SR | Presence L/R, Front L/R, Center, Surround L/R | L C R SL SB SR | Front L/R, Center, Surround L/R, Surround back L/R |
| 8 | L C R SL SB SR | Presence L/R, Front L/R, Center, Surround L/R, Surround back | — | — |
| 9 | L C R SL SB SR | Presence L/R, Front L/R, Center, Surround L/R, Surround back L/R | — | — |

8 After you have finished the settings, press ∇ , then press $-/+$ to select:

- SET To apply the changes.
- CANCEL To cancel the setup.



If you select SET, you will hear a test tone from each speaker.

9 Press ∇ to select CHECK OK?, then press $-/+$ to select:

- YES To exit the setup if the test tones were satisfactory.
- NO To adjust each speaker level (see page 50).



(when NO is selected)

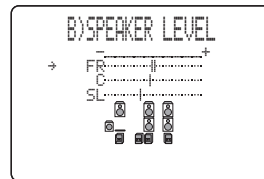

Memory back-up

The memory back-up circuit prevents the stored data from being lost even if this unit is in the standby mode. However, if the power cord is disconnected from the AC outlet, or the power supply is cut for more than one week, the stored data will be lost. If so, adjust the items again.

PLAYBACK

Basic operations

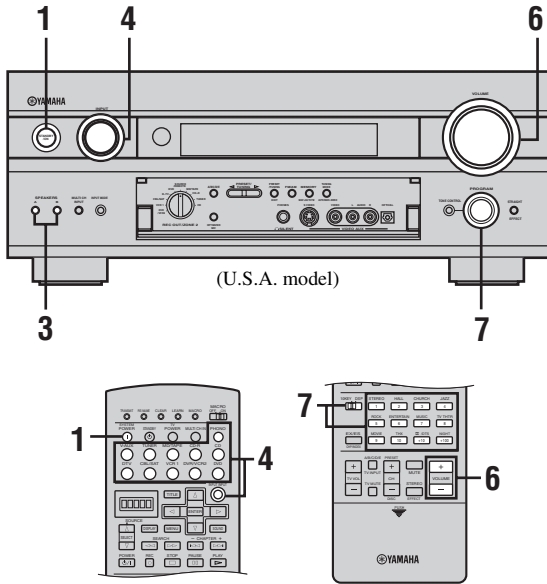

1 Press STANDBY/ON (SYSTEM POWER on the remote control) to turn on the power.

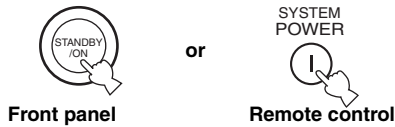

2 Turn on the video monitor connected to this unit.

3 Press SPEAKERS A or B on the front panel.
Each press turns the respective speakers on or off.

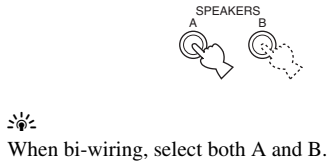

4 Select the input source.

Use INPUT (or press one of the input selector buttons on the remote control) to select the input you desire.

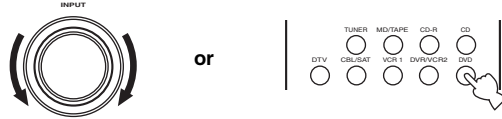

Front panel

Remote control

The current input source name and input mode appear in the front panel display and video monitor for a few seconds.



Selected input source

Input mode

5 Start playback or select a broadcast station on the source component.

Refer to the operation instructions for the component.

6 Adjust the volume to the desired output level.

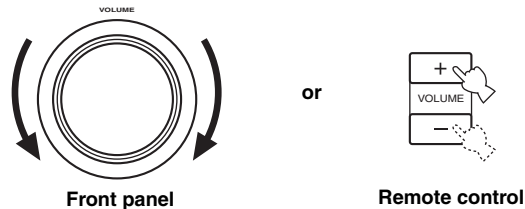

Front panel

Remote control

7 Select a sound field program if desired.

Use PROGRAM (or set 10 KEY/DSP to DSP, then press one of the sound field program buttons repeatedly) to select a sound field program. See page 41 for details about sound field programs.

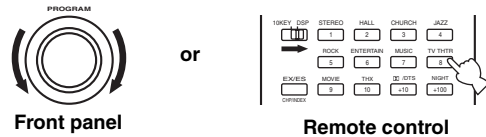

Front panel

Remote control

Note

When this unit detects Dolby Digital signals, the following display appears for a few seconds. This shows how the signal level is being corrected to become -27 dB (THX recommendation).

DialNorm = +4dB

To listen with headphones (SILENT CINEMA)

The SILENT CINEMA mode allows you to enjoy multi-channel music or movie sound, including Dolby Digital and DTS surround, through ordinary headphones. SILENT CINEMA activates automatically whenever you connect headphones to the PHONES jack while listening to CINEMA DSP or HiFi DSP sound field programs. The "SILENT CINEMA" indicator lights up on the front panel display. (If the sound field programs are off, you listen with normal stereo reproduction.)

Note

This unit will not be set to the SILENT CINEMA mode when MULTI CH INPUT is selected as the input source.

To adjust the tone

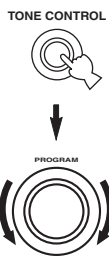

You can adjust the bass/treble balance for the front left/right and center channels. Press TONE CONTROL repeatedly on the front panel to select TREBLE or BASS. Select TREBLE, then rotate PROGRAM to the right or left to increase or decrease the high-frequency response.

Select BASS, then rotate PROGRAM to the right or left to increase or decrease the low-frequency response. To cancel the tone control, press TONE CONTROL repeatedly to select BYPASS.

Notes

- If you increase or decrease the high-frequency or the low-frequency sound to an extreme level, the tonal quality of the surround speakers may not match that of the front left/right and center speakers.
- TONE CONTROL is not effective when THX (page 41) or DIRECT STEREO (page 33) program is selected, or when MULTI CH INPUT is selected.
- TONE CONTROL is not effective for headphones. Use HP TONE CTRL to adjust bass/treble balance for the headphones (page 53).

To mute the sound

Press MUTE on the remote control. "MUTE" blinks in the front panel display.



To resume the audio output, press MUTE again. (or press VOLUME +/-). "MUTE" disappears from the display.



You can adjust muting level (see page 53).

Selecting the MULTI CH INPUT

Press MULTI CH INPUT so that "MULTI CH INPUT" appears in the front panel display and video monitor.

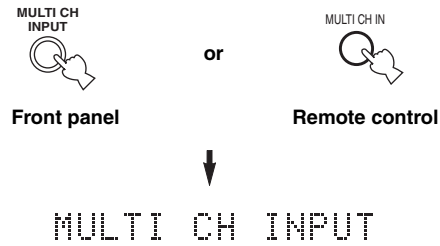

Note

When "MULTI CH INPUT" is shown on the front panel display and/or the video monitor, no other source can be played. To select another input source with INPUT (one of the input selector buttons), press MULTI CH INPUT to turn off "MULTI CH INPUT" from the front panel display and the video monitor.

Playing video sources in the background

You can combine a video image from a video source with a sound from an audio source. For example, you can enjoy listening to classical music while having beautiful scenery from the video source on the video monitor.

Use the input selector buttons to select a video source, then select an audio source.

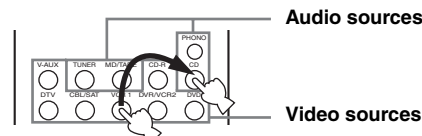

Note

If you want to enjoy an audio source connected to the MULTI CH INPUT jacks together with a video source, first select the video source and then press MULTI CH INPUT.

PLAYBACK

Selecting sound field programs

Front panel operation

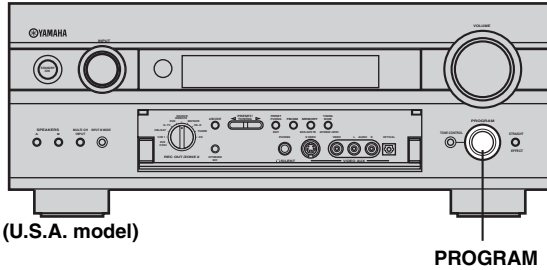

Rotate PROGRAM to select the desired program.
The name of the selected program appears on the front panel display and on the video monitor.

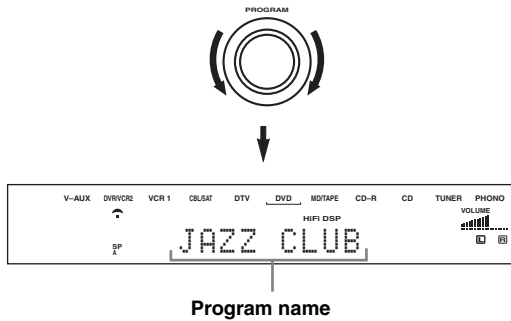

Remote control operation

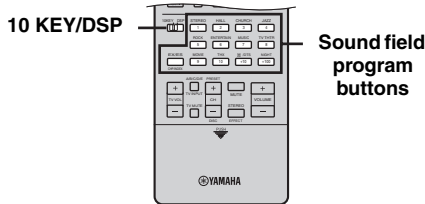

Set 10 KEY/DSP to DSP, then press one of the sound field program buttons repeatedly to select the desired program.

The name of the selected program appears on the front panel display and on the video monitor.

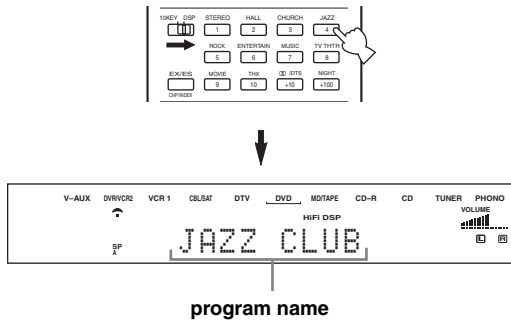

Choose a sound field program based on your listening preference, and not on the name of the program.

Notes

- When you select an input source, this unit automatically selects the last sound field program used with that source.
- Sound field programs cannot be selected when the MULTI CH INPUT is selected.
- Sampling frequencies higher than 48 kHz (except for DTS 96/24 signals) will be sampled down to 48 kHz, then sound field programs will be applied.

Enjoying Dolby Digital EX and DTS ES software

If you connected surround back speakers, press EX/ES to turn on the Dolby Digital EX or DTS ES decoder when playing Dolby Digital EX or DTS ES software.



You can select from the following modes depending on the format of the software you are playing.

- AUTO** This mode automatically switches between Dolby Digital EX/DTS ES Matrix/DTS ES Discrete according to the input signal format this unit detects. Surround back speakers do not work for 5.1-channel sources.
- ON** Select to enjoy 6.1 or 7.1-channel playback by creating one or two surround back channel(s) when playing 5.1-channel sources.
- OFF** Surround back speakers do not work in this mode.



When SURR B L/R SP is set to "LRGx1" or "SMLx1" (see page 49), the surround back channel will be output from the left SURROUND BACK speaker terminals.

Notes

- Some 6.1-channel compatible discs do not have a signal (flag) which this unit can automatically detect. When playing these kinds of discs with 6.1-channel, select "ON".
- 6.1-channel playback is not possible even if EX/ES is pressed in the following cases:
 - When SURR L/R SP is set to "NONE" (see page 49).
 - When the sound effect is turned off.
 - When the source connected to the MULTI CH INPUT jack is being played.
 - When the source being played does not contain surround L/R channel signals.
 - When Dolby Digital KARAOKE source is being played.
 - When headphones are connected.
 - When "7ch Stereo" is selected.
- When the power of this unit is turned off, the input mode will be reset to AUTO.
- When the DTS ES decoder is applied to DTS 96/24 signals, you cannot use the DTS 96/24 decoding feature.

■ Listening to high fidelity stereo sound (Direct Stereo)

Direct Stereo allows you to bypass this unit's decoders and DSP processors to enjoy pure high fidelity sound from 2-channel PCM and analog sources.

Rotate PROGRAM (or set 10 KEY/DSP to DSP, then press STEREO repeatedly) to select DIRECT STEREO.

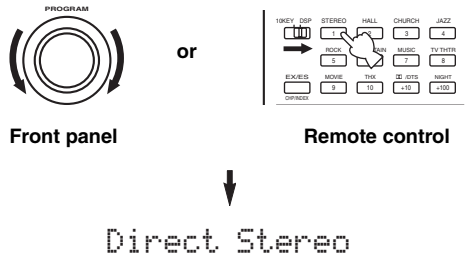

Notes

- To avoid unexpected noise, do not play DTS-encoded CDs in this mode.
- When multi-channel signals (Dolby Digital and DTS) are input, this unit automatically selects an analog signal input.
- No sound will be output from the subwoofer.
- TONE CONTROL (page 31) and SET MENU (page 47) settings are not effective.
- The front panel display automatically dims.

■ Listening at night

This mode reproduces dialogue clearly while reducing the volume of loud sound effects for easier listening at low volumes or at night.

Press NIGHT on the remote control.

The NIGHT indicator in the front panel display lights up.

Press NIGHT again to cancel. The NIGHT indicator goes off.



- You can use the night mode with any sound field programs except Direct Stereo (even though the NIGHT indicator lights up during Direct Stereo mode).
- Night listening mode may vary in effectiveness depending on the input source and surround sound settings you use.

■ Downmixing to 2 channels

You can enjoy 2-channel stereo playback even from multi-channel sources.

Rotate PROGRAM (or press STEREO on the remote control) to select 2ch Stereo.

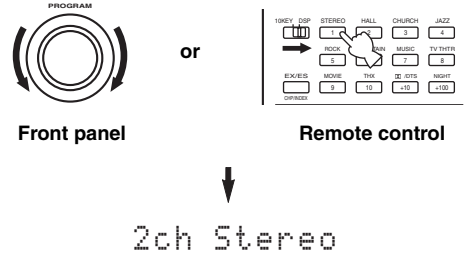

You can use a subwoofer with this program when SWFR or BOTH is selected in LFE/BASS OUT.

■ Listening to unprocessed input signals

Press STRAIGHT/EFFECT to select STRAIGHT.

Two channel stereo sources are output from only the front left and right speakers. Multi-channel sources are decoded straight into the appropriate channels without any additional effect processing.

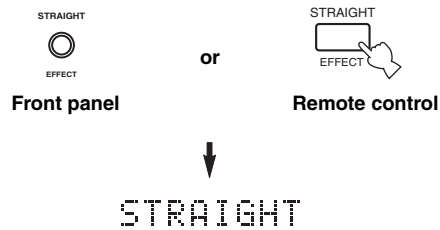

Press STRAIGHT/EFFECT again so that "STRAIGHT" disappears from the display when you want to turn the sound effect back on.

PLAYBACK**Virtual CINEMA DSP**

Virtual CINEMA DSP allows you to enjoy the CINEMA DSP programs without surround speakers. It creates virtual speakers to reproduce the natural sound field. If you do not connect surround speakers, Virtual CINEMA DSP activates automatically whenever you select a CINEMA DSP sound field program.

Note

Virtual CINEMA DSP will not activate, even when SURR L/R SP is set to "NONE" (see page 49) in the following cases:

- When MULTI CH INPUT is selected as the input source.
- When headphones are connected.

Selecting input modes

This unit comes with a variety of input jacks. Do the following to select the type of input signals you want to use.

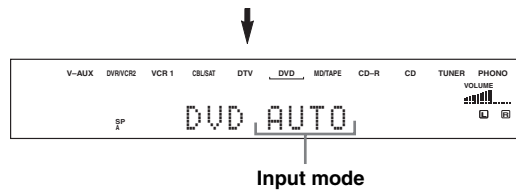
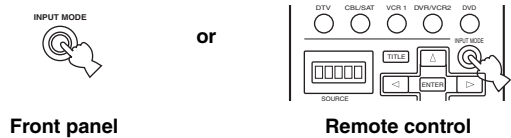
1 Select the input source.**2 Press INPUT MODE to select an input mode. In most cases, use AUTO.**

- AUTO** Automatically selects input signals in the following order:
- 1) Digital signals*
 - 2) Analog signals
- DTS** Selects only digital signals encoded in DTS. If no DTS signals are input, no sound is output.
- ANALOG** Selects only analog signals. If no analog signals are input, no sound is output.

* If this unit detects a Dolby Digital or DTS signal, the decoder automatically switches to the appropriate sound field program.



You can adjust the default input mode this unit selects when the power is turned on (see page 54).

Notes

- When you play DTS encoded sources with the input mode set to AUTO;
 - This unit automatically switches to the DTS decoding mode. The unit remains in DTS mode (and the “**dts**” indicator may flash) for up to 30 second after playback of the DTS source is complete. To manually release the DTS mode, press INPUT MODE to reselect AUTO.
 - The DTS decoding mode may be released if search or skip operations are performed for more than 30 seconds. To prevent this, press INPUT MODE to select DTS.
- If the digital output data of the player has been processed in any way, you may not be able to perform DTS decoding even if you make a digital connection between this unit and the player.

Displaying the information about the input source

You can display the type, format and sampling frequency of the current input signal.

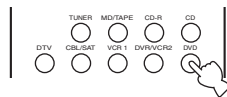
1 Select the input source.**2 Press STRAIGHT/EFFECT so that “STRAIGHT” appears in the display.****3 Set PARAMETER/SET MENU to PARAMETER and press Δ/∇ to display the following information about the input signal.**

| | |
|----------|--|
| (Format) | Signal format display. When the unit cannot detect a digital signal it automatically switches to analog input. |
| in | Number of source channels in the input signal. For example, a multi-channel soundtrack with 3 front channels, 2 surround channels and LFE, is displayed as “3/2/ LFE”. |
| fs | Sampling frequency. When the unit is unable to detect the sampling frequency “Unknown” appears. |
| rate | Bit rate. When the unit is unable to detect the bit rate “Unknown” appears. |
| flg | Flag data encoded with DTS or Dolby Digital signals that cue this unit to automatically switch decoders. |

TUNING

Automatic and manual tuning

There are 2 tuning methods; automatic and manual. Automatic tuning is effective when station signals are strong and there is no interference.

Automatic tuning

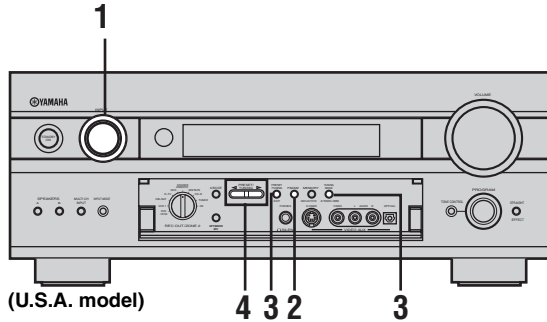

- 1 Rotate INPUT (or press TUNER on the remote control) to select TUNER as the input source.

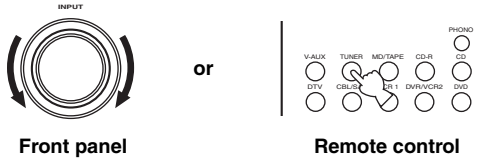

- 2 Press FM/AM to select the reception band. "FM" or "AM" appears on the front panel display.



- 3 Press TUNING MODE (AUTO/MAN'L MONO) so that the "AUTO" indicator lights up on the front panel display.



If a colon (:) appears on the front panel display, press PRESET/TUNING (EDIT) to turn it off.

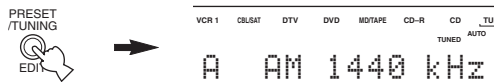

- 4 Press PRESET/TUNING <> once to begin automatic tuning.

Press > to tune in to a higher frequency, or press < to tune in to a lower frequency.

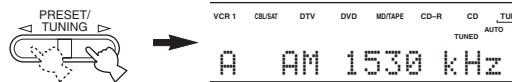

When tuned in to a station, the "TUNED" indicator lights up and the frequency of the received station is shown on the front panel display.

Manual tuning

If the signal from the station you want to select is weak, you must tune in to it manually.

- 1 Select TUNER and the reception band following steps 1 and 2 as described in "Automatic tuning".

- 2 Press TUNING MODE (AUTO/MAN'L MONO) so that the "AUTO" indicator disappears from the front panel display.



If a colon (:) appears on the front panel display, press PRESET/TUNING (EDIT) to turn it off.

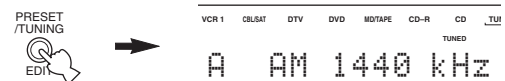

- 3 Press PRESET/TUNING <> to tune in to the desired station manually.

Hold down the button to continue searching.

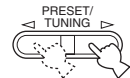

Note

Manually tuning in to an FM station will automatically change the reception mode to monaural to increase the signal quality.

Presetting stations

■ Automatically presetting FM stations

You can use the automatic preset tuning feature to store FM stations. This function enables this unit to automatically tune in to FM stations with strong signals, and to store up to 40 (8 stations x 5 groups) of those stations in order. You can then recall any preset station easily by selecting the preset station number.

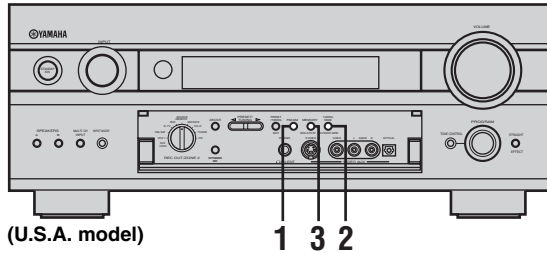

(U.S.A. model)

1 Press FM/AM to select the FM band.



2 Press TUNING MODE (AUTO/MAN'L MONO) so that the "AUTO" indicator lights up on the front panel display.



3 Press and hold MEMORY (MAN'L/AUTO FM) for more than 3 seconds.

The preset number, the "MEMORY" and "AUTO" indicators flash. After about 5 seconds, automatic presetting starts from the frequency currently displayed and proceeds toward the higher frequencies.

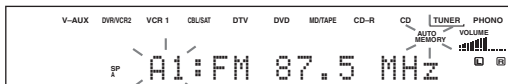

When automatic preset tuning is completed, the front panel display shows the frequency of the last preset station.

Notes

- Any stored station data existing under a preset number is cleared when you store a new station under that preset number.
- If the number of the received stations does not reach E8, automatic preset tuning has automatically stopped after searching all stations.
- Only FM stations with sufficient signal strength are stored automatically by automatic preset tuning. If the station you want to store is weak in signal strength, tune in to it manually in the monaural mode, and store it by following the procedure in "Manually presetting stations".

Automatic preset tuning options

You can select the preset number from which this unit will store FM stations and/or begin tuning toward lower frequencies.

After pressing MEMORY in step 3:

- 1 Press A/B/C/D/E, then PRESET/TUNING <I/> to select the preset number under which the first station will be stored. Automatic preset tuning will stop when stations have all been stored up to E8.
- 2 Press PRESET/TUNING (EDIT) to turn off the colon (:), and then press PRESET/TUNING <I/> to begin tuning toward lower frequencies.

Memory back-up

The memory back-up circuit prevents the stored data from being lost even if this unit is set in the standby mode, the power cord is disconnected from the AC outlet, or the power supply is temporarily cut due to power failure. However, if the power is cut for more than one week, the preset stations may be cleared. If so, store the stations again by using the presetting station methods.

TUNING

Manually presetting stations

You can also store up to 40 stations (8 stations x 5 groups) manually.

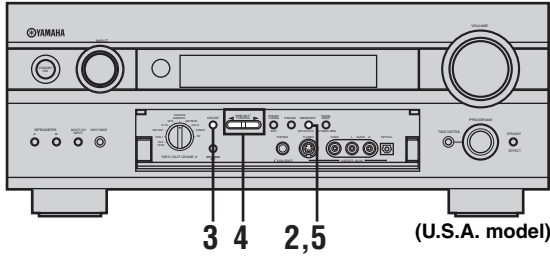

1 Tune in to a station.

See page 36 for tuning instructions.



When tuned in to a station, the front panel display shows the frequency of the station received.

2 Press MEMORY (MAN'L/AUTO FM).

The "MEMORY" indicator flashes for about 5 seconds.



3 Press A/B/C/D/E repeatedly to select a preset station group (A to E) while the "MEMORY" indicator is flashing.

The group letter appears. Check that the colon (:) appears on the front panel display.

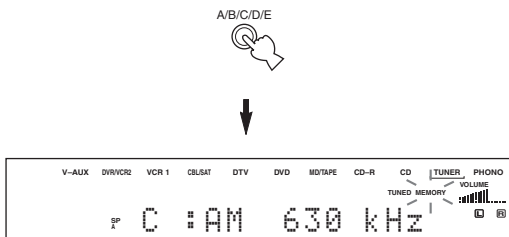

4 Press PRESET/TUNING <=> to select a preset station number (1 to 8) while the "MEMORY" indicator is flashing.

Press > to select a higher preset station number. Press < to select a lower preset station number.

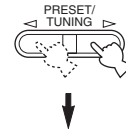

5 Press MEMORY (MAN'L/AUTO FM) on the front panel while the "MEMORY" indicator is flashing.

The station band and frequency appear on the front panel display with the preset group and number you have selected.



Shows the displayed station has been stored as C3.

6 Repeat steps 1 to 5 to store other stations.

Notes

- Any stored station data existing under a preset number is cleared when you store a new station under that preset number.
- The reception mode (stereo or monaural) is stored along with the station frequency.

Selecting preset stations

You can tune any desired station simply by selecting the preset station number under which it was stored.

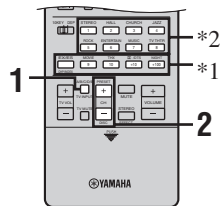
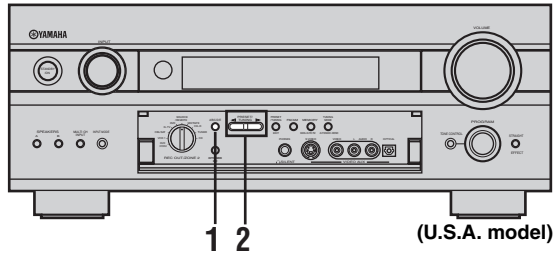

*1 These buttons can be used to directly select the preset group (A to E from left to right).

*2 These buttons can be used to directly select the preset station number 1 to 8.

1 Press A/B/C/D/E to select the preset station group.

The preset group letter appears on the front panel display and changes each time you press the button.

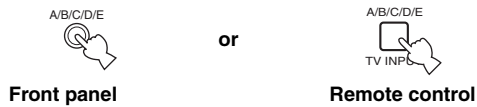

2 Press PRESET/TUNING (PRESET +/-) on the remote control to select a preset station number (1 to 8).

The preset group and number appear on the front panel display along with the station band, frequency and the "TUNED" indicator lights up.

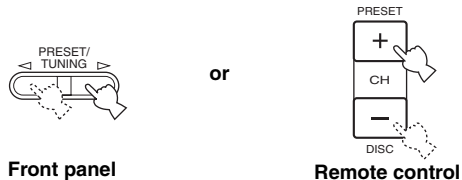

Exchanging preset stations

You can exchange the assignment of two preset stations with each other. The example below describes the procedure for exchanging preset station "E1" with "A5".

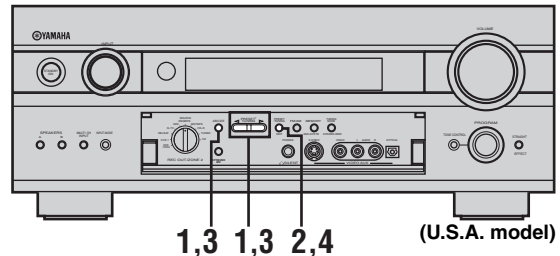

1 Select preset station "E1" by using the A/B/C/D/E and PRESET/TUNING (EDIT).

See "Selecting preset stations".

2 Press and hold PRESET/TUNING (EDIT) for more than 3 seconds.

"E1" and the "MEMORY" indicator flash on the front panel display.

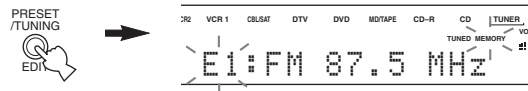

3 Select preset station "A5" by using A/B/C/D/E and PRESET/TUNING (EDIT).

"A5" and the "MEMORY" indicator flash on the front panel display.

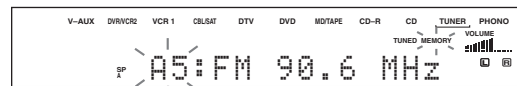

4 Press PRESET/TUNING (EDIT) again.

The stations stored at the two preset assignments are exchanged.

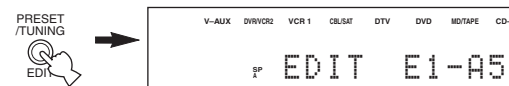

Shows the exchange of stations has been completed.

RECORDING

You can use the REC OUT/ZONE 2 or REC OUT control to record one source while watching and/or listening to another source.

Recording adjustments and other operations are performed from the recording components. Refer to the operation instructions for those components.

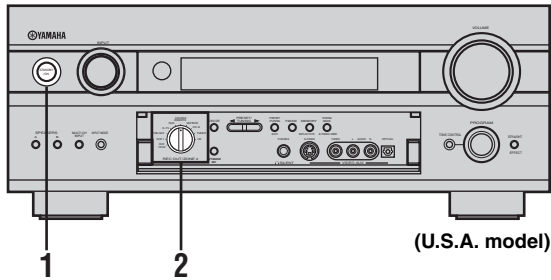

1 Turn on the power of this unit and all connected components.

2 Select the source component you want to record from by using REC OUT/ZONE 2 or REC OUT.

- To record the current input source that you are watching or listening to, set REC OUT/ZONE 2 or REC OUT to SOURCE/REMOTE.

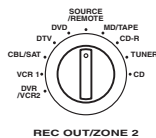

- To record a source other than the one that you are watching or listening to, set REC OUT/ZONE 2 or REC OUT to the source you want to record.

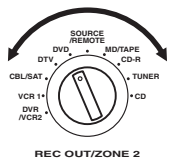

After this setting, you can change the source you are listening to and/or watching without effecting the recording by rotating INPUT (or pressing one of the input selector buttons on the remote control).

Note

The source you record and the source sent to Zone 2 (U.S.A., Canada and Australia models only) are always the same.

3 Start playback (or select a broadcast station) on the source component.

4 Start recording on the recording component.



To record audio and video from different sources, set REC OUT/ZONE 2 or REC OUT to SOURCE/REMOTE, select a video source first then select an audio source (see page 31).

Notes

- Do a test recording before you start an actual recording.
- When this unit is set in the standby mode, you cannot record between other components connected to this unit.
- The setting of TONE CONTROL, VOLUME, "Speaker level" (page 50) and programs does not affect the recorded material.
- A source connected to the MULTI CH INPUT jacks of this unit cannot be recorded.
- S-video and composite video signals pass independently through this unit's video circuits. Therefore, when recording or dubbing video signals, if your video source component is connected to provide only an S-video (or only a composite video) signal, you can record only an S-video (or only a composite video) signal to your VCR.
- A given input source is not output on the same REC OUT channel. (For example, the signal input from VCR 1 IN is not output on VCR 1 OUT.)
- Check the copyright laws in your country to record from records, CDs, radio, etc. Recording of copyrighted material may infringe copyright laws.

If you playback a video source that uses scrambled or encoded signals to prevent it from being dubbed, the picture itself may be disturbed due to those signals.

Special considerations when recording DTS software

The DTS signal is a digital bit stream. Attempting to digitally record the DTS bit stream will result in noise being recorded. Therefore, if you want to use this unit to record sources that have DTS signals recorded on them, the following considerations and adjustments need to be made.

For LDs, DVDs and CDs encoded with DTS, when your player is compatible with the DTS format, follow its operation instruction to make a setting so that the analog signal will be output from the player.

SOUND FIELD PROGRAM DESCRIPTIONS

This unit is equipped with a variety of precise digital decoders that allow you to enjoy multichannel playback from almost any sound source (stereo or multichannel). This unit is also equipped with a Yamaha digital sound field processing (DSP) chip containing several sound field programs which you can use to enhance your playback experience. Most of these sound field programs are precise digital recreations of actual acoustic environments found in famous concert halls, music venues, and movie theaters.



The Yamaha CINEMA DSP modes are compatible with all Dolby Digital, DTS, and Dolby Pro Logic sources. Set INPUT MODE to AUTO (see page 34) to enable this unit to automatically switch to the appropriate digital decoder according to the input signal.

For movie/video sources

You can select from the following sound fields when playing movie or video sources.

■ For multi-channel

You can select from the following sound fields to enjoy multi-channel sources, like DVD, digital TV, etc.

| Program | Features |
|---------------------------------|---|
| STEREO: 2ch Stereo | Downmixes multi-channel sources to 2 (left and right) channels. |
| MOVIE THEATER: Spectacle | CINEMA DSP processing. This program creates the extremely wide sound field of a 70-mm movie theater. It precisely reproduces the source sound in detail, making both the video and the sound field incredibly real. This is ideal for any kind of video source encoded with Dolby Surround, Dolby Digital or DTS (especially large-scale movie productions). |
| MOVIE THEATER: Sci-Fi | CINEMA DSP processing. This program clearly reproduces dialog and sound effects in the latest sound form for science fiction films, thus creating a broad and expansive cinematic space amid silence. You can enjoy science fiction films in a virtual-space sound field that includes Dolby Surround, Dolby Digital and DTS-encoded software employing the most advanced techniques. |
| MOVIE THEATER: Adventure | CINEMA DSP processing. This program is ideal for precisely reproducing the sound design of the newest 70-mm and multichannel soundtrack films. The sound field is made to be similar to that of the newest movie theaters, so the reverberations of the sound field itself are restrained as much as possible. |
| MOVIE THEATER: General | CINEMA DSP processing. This program is for reproducing sounds from 70-mm and multichannel soundtrack films, and is characterized by soft and extensive sound field. The presence sound field. The presence sound field is relatively narrow. It spatially spreads all around and toward the screen, restraining the echo effect of conversations without losing clarity. |
| THX Cinema | THX processing for any multi-channel sources. |
| THX Surr. EX | THX processing for Dolby Digital and Dolby Digital EX sources. This program is available only when surround back L/R speakers are connected to this unit and when the input source contains surround back channel signals. |
| dts ES+THX | THX processing for DTS ES sources. |
| DOLBY DIGITAL: SUR. STANDARD | Standard 5.1 channel processing for Dolby Digital sources. |
| DOLBY DIGITAL: SUR. ENHANCED | CINEMA DSP Enhanced processing for Dolby Digital sources. |
| DOLBY D EX: SUR. STANDARD | Standard 6.1 channel processing for Dolby Digital EX sources. |
| DOLBY D EX: SUR. ENHANCED | CINEMA DSP Enhanced processing for Dolby Digital EX sources. |
| DTS: SUR. STANDARD | Standard 5.1 channel processing for DTS and 96kHz/24-bit DTS sources. |
| DTS: SUR. ENHANCED | CINEMA DSP Enhanced processing for DTS sources. |

SOUND FIELD PROGRAM DESCRIPTIONS

| Program | Features |
|------------------------------------|---|
| DTS ES Mtrx 6.1: SUR. STANDARD | Standard 6.1 channel processing for DTS Matrix 6.1 sources. |
| DTS ES Mtrx 6.1: SUR. ENHANCED | CINEMA DSP Enhanced processing for DTS Matrix 6.1 sources. |
| DTS ES Dscrt 6.1: SUR. STANDARD | Standard 6.1 channel processing for DTS Discrete 6.1 sources. |
| DTS ES Dscrt 6.1: SUR. ENHANCED | CINEMA DSP Enhanced processing for DTS Discrete 6.1 sources. |

■ For 2-channel (stereo)

You can select from the following sound fields to enjoy multi-channel playback from 2-channel (stereo) sources, like TV programs, video tapes, etc.

| Program | Features |
|-------------------------------|---|
| ENTERTAINMENT: Game | CINEMA DSP processing. This program adds a deep and spatial feeling to video game sounds. |
| MUSIC VIDEO | CINEMA DSP processing. This program produces an enthusiastic atmosphere and lets you feel as if you are at an actual jazz or rock concert. |
| TV THEATER: Mono Movie | CINEMA DSP processing. This program is provided for reproducing monaural video sources (such as old movies). The program produces the optimum reverberation to create sound depth using only the presence sound field. |
| TV THEATER: Variety/Sports | CINEMA DSP processing. Though the presence sound field is relatively narrow, the surround sound field employs the sound environment of a large concert hall. With this program, you can enjoy watching various TV programs such as news, variety shows, music programs or sports programs. |
| MOVIE THEATER: Spectacle | CINEMA DSP processing. This program creates the extremely wide sound field of a 70-mm movie theater. It precisely reproduces the source sound in detail, making both the video and the sound field incredibly real. This is ideal for any kind of video source encoded with Dolby Surround, Dolby Digital or DTS (especially large-scale movie productions). |
| MOVIE THEATER: Sci-Fi | CINEMA DSP processing. This program clearly reproduces dialog and sound effects in the latest sound form for science fiction films, thus creating a broad and expansive cinematic space amid silence. You can enjoy science fiction films in a virtual-space sound field that includes Dolby Surround, Dolby Digital and DTS-encoded software employing the most advanced techniques. |
| MOVIE THEATER: Adventure | CINEMA DSP processing. This program is ideal for precisely reproducing the sound design of the newest 70-mm and multichannel soundtrack films. The sound field is made to be similar to that of the newest movie theaters, so the reverberations of the sound field itself are restrained as much as possible. |
| MOVIE THEATER: General | CINEMA DSP processing. This program is for reproducing sounds from 70-mm and multichannel soundtrack films, and is characterized by soft and extensive sound field. The presence sound field is relatively narrow. It spatially spreads all around and toward the screen, restraining the echo effect of conversations without losing clarity. |
| THX Cinema: | THX processing for sources decoded by the PRO LOGIC, PRO LOGIC II or DTS Neo: 6 decoder. You can select the decoder using the sound field parameter described on page 80. |
| PRO LOGIC: SUR. STANDARD | Standard processing for Dolby Surround sources. |
| PRO LOGIC: SUR. ENHANCED | CINEMA DSP Enhanced processing for Dolby Surround sources. |
| PRO LOGIC II: PLII Movie | Dolby Pro Logic II processing for movie software. |
| DTS Neo:6 Cinema | DTS processing for movie software. |

For music sources

You can select from the following sound fields when playing music sources, like CD, FM/AM broadcasting, tapes, etc.

| Program | Features |
|-----------------------------|--|
| STEREO: 2ch Stereo | 2 (left and right) channel playback. |
| STEREO: Direct Stereo | Use to output stereo sources to only the front left and right speakers without any processing. |
| STEREO: 7ch Stereo | Use to increase the output stereo sources (in stereo) from all speakers. This provides a larger sound field and is ideal for background music at parties, etc. |
| HALL: Hall in Munich | HiFi DSP processing. This is a large fan-shaped concert hall which has approximately 2500 seats. Almost the whole interior is made of wood. There is relatively little reflection from the walls, and sound spreads finely and beautifully. |
| HALL: Hall in Vienna | HiFi DSP processing. A large round concert hall with a rich surround effect. Pronounced reflections from all directions emphasize the extension of sounds. The sound field has a great deal of presence, and your virtual seat is near the center, close to the stage. |
| CHURCH | HiFi DSP processing. This program recreates the acoustic environment of a big church with a high dome and columns along each side. The reverberation delay is very long while the early reflections are smaller than with other sound field programs. |
| JAZZ CLUB | HiFi DSP processing. This is the sound field at stage front in "The bottom Line", a famous New York jazz club. The floor can seat 300 people to the left and right in a sound field offering a real and vibrant sound. |
| ROCK CONCERT | HiFi DSP processing. The ideal program for lively, dynamic rock music. The data for this program was recorded at LA's "hottest" rock club. The listener's virtual seat is at the center-left of the hall. |
| ENTERTAINMENT: Disco | HiFi DSP processing. This program recreates the acoustic environment of a lively disco in the heart of a big city. The sound is dense and highly concentrated. It is also characterized by high-energy, "immediate" sound. |
| PRO LOGIC II: PLII Music | Dolby Pro Logic II processing for music software. |
| DTS:Neo:6 Music | DTS processing for music software. |

ADVANCED OPERATIONS

Selecting the OSD mode

You can display this unit's operating information on a video monitor. If you display the SET MENU and sound field program parameter settings on a monitor, it is much easier to see the available options and parameters than it is by reading this information on the front panel display.

- 1 Turn on the video monitor connected to this unit.
- 2 Press ON SCREEN repeatedly to change the OSD mode.
The OSD mode changes in the following order: full display, short display, and display off.

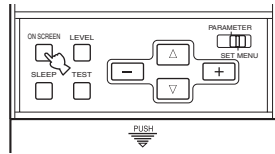

Full display

Always shows the sound field program parameter settings as well as the contents of the front panel display.

Short display

Briefly shows the contents of the front panel display at the bottom of the screen each time you operate this unit.

Display off



Full display

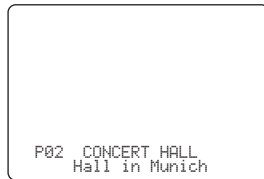

Short display

Notes

- The OSD signal is not output to the REC OUT jack, and will not be recorded.
- You can set the OSD to turn on (gray background) or off when a video source is not being reproduced (or the source component is turned off) by using "Display set" (see page 56).

Using the sleep timer

Use this feature to automatically set this unit in the standby mode after a certain amount of time. The sleep timer is useful when you are going to sleep while this unit is playing or recording a source. The sleep timer also automatically turns off any external components connected to the AC OUTLET(S).

Setting the sleep timer

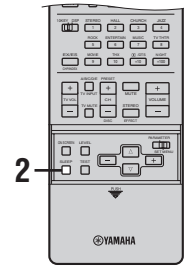

- 1 Select a source and start playback on the source component.
- 2 Press SLEEP repeatedly to set the amount of time.

Each time you press SLEEP, the front panel display changes as shown below. The SLEEP indicator flashes while switching the amount of time for sleep timer.

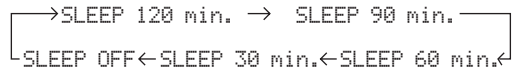

The "SLEEP" indicator lights up on the front panel display after the sleep timer has been set.

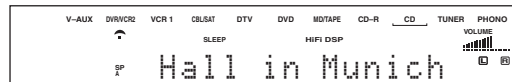

■ Canceling the sleep timer

Press SLEEP repeatedly until "SLEEP OFF" appears on the front panel display.

After a few seconds, "SLEEP OFF" disappears, and the "SLEEP" indicator goes off.



The sleep timer setting can also be canceled by pressing STANDBY on the remote control (or STANDBY/ON on the front panel) to set this unit to the standby mode.

Manually adjusting speaker levels

You can adjust the output level of each speaker while listening to a music source. This is also possible when playing sources through the MULTI CH INPUT jacks. Please note that this operation will override the level adjustments made in "AUTO SETUP" (page 24), "Speaker level" (page 50) and "Using the test tone" (page 46).

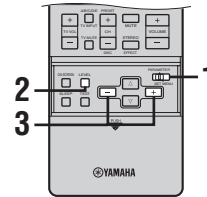

1 Set PARAMETER/SET MENU to PARAMETER.



2 Press LEVEL repeatedly to select the speaker you want to adjust.



| | |
|-----------|-----------------------------------|
| FRONT L | Front left speaker level |
| CENTER | Center speaker level |
| FRONT R | Front right speaker level |
| SUR. R | Surround right speaker level |
| SUR. B. R | Surround back right speaker level |
| SUR. B. L | Surround back left speaker level |
| SUR. L | Surround left speaker level |
| SWFR | Subwoofer level |
| PRES | Presence speaker level |



Once you press LEVEL, you can also select the speaker by pressing Δ/∇ .

1 Press +/- to adjust the speaker output level.

- The control range is from +10 dB to -10 dB.



Notes

- When inputting digital signals with sampling frequencies higher than 48 kHz, only the subwoofer level can be adjusted.
- You can not adjust the speaker level by using LEVEL when PARAMETER/SET MENU is set to SET MENU. However, each time you press LEVEL, the current level of each speaker appears on the front panel display allowing you to check the speaker levels.

ADVANCED OPERATIONS**Using the test tone**

You can use the test tone feature to manually balance your speaker levels. Please note that this operation will override the level adjustments made in “AUTO SETUP” (page 24), “Speaker level” (page 50) and “Manually adjusting speaker levels” (page 45). Use the test tone to set speaker levels so that the volume from each speaker is identical when heard from your listening position.

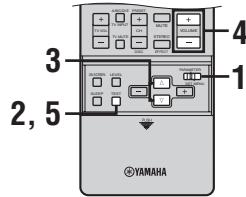

1 Set PARAMETER/SET MENU to PARAMETER.

2 Press TEST.

The unit will output a test tone.

3 Press Δ/∇ repeatedly to select the speaker you want to adjust.

| | |
|----------------|-----------------------------|
| TEST LEFT | Front left speaker |
| TEST CENTER | Center speaker |
| TEST RIGHT | Front right speaker |
| TEST R SUR. | Right surround speaker |
| TEST R SUR. B | Right surround back speaker |
| TEST L SUR. B | Left surround back speaker |
| TEST L SUR. | Left surround |
| TEST SUBWOOFER | Subwoofer |

4 Press $-/+$ to adjust speaker volumes.

5 Press TEST when you have completed your adjustment.

The test tone stops.



- Use a handheld SPL meter, hold at arms length and point upwards so that the meter is in the listening position. With the meter set to the 70 dB scale and to C SLOW, calibrate each speaker to 75 dB.
- Before outputting the test tone, we recommend that you set the output volume to 0 dB.

Note

You cannot enter test mode if headphones are connected to the PHONES jack. Remove the headphones from the PHONES jack.

SET MENU

You can use the following parameters in the set menu to adjust a variety of system settings and customize the way this unit operates. Change the initial settings (indicated in bold under each parameter) to reflect the needs of your listening environment.

■ Auto Setup

Use to specify which speaker parameters auto setup will adjust, and to activate the auto setup procedure (see page 24).

■ Manual Setup

Use to manually adjust speaker and system settings.



Most of the parameters described in the SOUND menu are set automatically when you run auto setup (see page 24). You can use the SOUND menu to make further adjustments, but we recommend running auto setup first.

Basic menu

Use to quickly setup basic system parameters (see page 28).

Sound menu

Use to manually adjust any speaker setting or compensate for video signal processing delays when using LCD monitors or projectors.

| Item | Features | Page |
|----------------|--|------|
| SPEAKER SET | Selects the output mode suitable for each speaker, the speakers for low-frequency signal output, and the cross over frequency. | 49 |
| SP LEVEL | Adjusts the output level of each speaker. | 50 |
| SP DISTANCE | Adjusts the delay time of each speaker. | 51 |
| GRAPHIC EQ | Adjusts the tonal quality of each speaker. | 51 |
| LFE LEVEL | Adjusts the output level of the LFE channel for Dolby Digital or DTS signals. | 51 |
| DYNAMIC RANGE | Adjusts the dynamic range for Dolby Digital or DTS signals. | 52 |
| LOW FRQ. TEST | Matches the subwoofer level with the level of the other speakers. | 52 |
| HP TONE CTRL | Adjusts the tonal balance of the headphones. | 53 |
| AUDIO SET | Customizes overall audio settings of this unit. | 53 |
| FR/SBch SELECT | Selects priority to either surround back or presence speakers when both sets of speakers are connected to this unit. | 53 |

Input menu

Use to reassign digital input/outputs, select the input mode, rename your inputs, or specify external input settings.

| Item | Features | Page |
|--------------|--|------|
| I/O ASSIGN | Assigns jacks according to the component to be used. | 54 |
| INPUT MODE | Selects the initial input mode of the source. | 54 |
| INPUT RENAME | Changes the name of the inputs. | 55 |
| EXT. INPUT | Sets the direction of the signals input into the center, subwoofer and surround channels for the source component connected to the MULTI CH INPUT jacks. | 55 |

SET MENU**Option menu**

Use to adjust the optional system settings.

| Item | Features | Page |
|--------------|---|------|
| DISPLAY SET | Adjusts the OSD and converts video signals. | 56 |
| MEMORY GUARD | Locks sound field program parameters and other SET MENU settings. | 56 |
| PARAM. INI | Initializes the parameters of a group of sound field programs. | 57 |
| SP IMP. SET | Selects the impedance of your speakers. | 57 |
| ZONE SET | Specifies the location of the speakers connected to the SPEAKERS B terminals. | 57 |
| ZONE2 SET | Selects the Zone 2 mode. | 57 |
| ZONE3 SET | Selects the Zone 3 mode. | 58 |

Using SET MENU

Use the remote control to access and adjust each parameter.

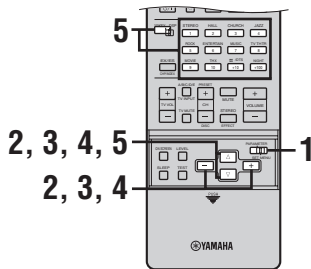

- 1** Set **PARAMETER/SET MENU** to **SET MENU**.



- 2** Press Δ/∇ to select **AUTO SETUP** or **MANUAL SETUP**, then press **-/+** to enter the selected category.

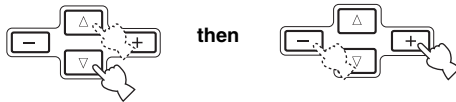

If Δ is pressed when **AUTO SETUP** is selected, or if ∇ is pressed when **MANUAL SETUP** is selected, **SET MENU** will be closed. Press Δ/∇ to open **SET MENU** again.

- 3** Press Δ/∇ repeatedly to select a menu, then press **-/+** to enter the menu item.

Repeat this operation to navigate to and enter the setup mode of the item you want to adjust.

- 4** Press **-/+** repeatedly to change the setting of the item you want to adjust.

- 5** To exit, press Δ/∇ repeatedly until the menu disappears or just press one of the sound field program group buttons.

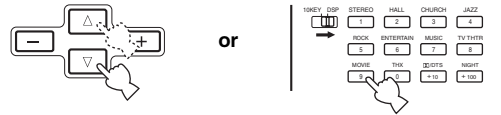
**Memory back-up**

The memory back-up circuit prevents the stored data from being lost even if this unit is in the standby mode. However, if the power cord is disconnected from the AC outlet, or the power supply is cut for more than one week, the stored data will be lost. If so, adjust the items again.

Manual setup: SOUND

Use to manually adjust any speaker setting or compensate for video signal processing delays when using LCD monitors or projectors. Most of the SOUND parameters are set automatically when you run auto setup (See page 24).



Speaker set SPEAKER SET

Use to manually adjust any speaker setting.

Note

Set any THX speakers to SMALL.

MANUAL SETUP > SOUND MENU > SPEAKER SET >

Center speaker CENTER SP

Choices: LARGE, **SMALL**, NONE

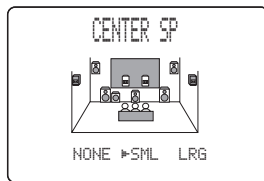

- Select LARGE if you have a large center speaker. The unit directs the entire range of the center channel signal to the center speaker.
- Select SMALL if you have a small center speaker. The unit directs the low-frequency signals of the center channel to the speakers selected with "BASS OUT".
- Select NONE if you do not have a center speaker. The unit directs all of the center channel signal to the front left and right speakers.

Front speakers FRONT SP

Choices: LARGE, **SMALL**

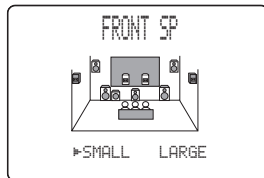

- Select LARGE if you have large front speakers. The unit directs the entire range of the front left and right channel signals to the front left and right speakers.
- Select SMALL if you have small front speakers. The unit directs the low-frequency signals of the front channel to the speakers selected with "BASS OUT".

Surround left/right speakers SURR L/R SP

Choices: LARGE, **SMALL**, NONE

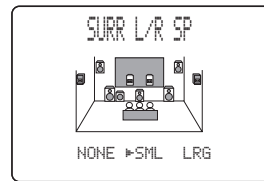

- Select LARGE if you have large surround left and right speakers or if a rear subwoofer is connected to the surround speakers. The entire range of the surround channel signal is directed to the surround left and right speakers.
- Select SMALL if you have small surround left and right speakers. The low-frequency signals of the surround channel are directed to the speakers selected with "BASS OUT".
- Select NONE if you do not have surround speakers. This will set the unit to the Virtual Cinema DSP mode (see page 34) and automatically set the surround back speaker setting (SURR B L/R SP below) to NONE.

Surround back left/right speakers

SURR B L/R SP

Choices: LRGx2, LRGx1, **SMLx2**, SMLx1, NONE

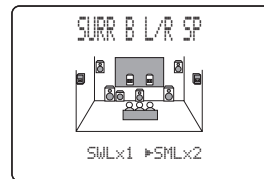

- Select LRGx2 if you have 2 large surround back speakers. The unit directs the entire range of the surround back channel signal to the surround back speakers.
- Select LRGx1 if you have a large surround back speaker. The unit directs the entire range of the surround back channel signal to the left surround back speaker.
- Select SMLx2 if you have 2 small surround back speakers. The low-frequency signals of the surround back channels are directed to the speakers selected with "BASS OUT".
- Select SMLx1 if you have a small surround back speaker. The low-frequency signals of the surround back channel are directed to the speakers selected with "BASS OUT", and the rest of the frequency signals are directed to the left surround back speaker.
- Select NONE if you do not have a surround back speaker. The unit directs all of the surround back channel signal to the surround left and right speakers.

Note

If you select LRGx1 or SMLx1, connect a speaker to the left SURROUND BACK speaker terminals.

SET MENU**Presence speakers** PRESENCE SP

Choices: NONE, YES



- Select YES if you have presence speakers.
- Select NONE if you do not have presence speakers.

LFE/bass out LFE/BASS OUT

LFE signals carry low-frequency effects when this unit decodes a Dolby Digital or DTS signal. The Low-frequency signals can be directed to both front left and right speakers, and to the subwoofer (subwoofer can be used for both stereo reproduction and the sound field program).

Choices: **SWFR** (subwoofer), FRNT, BOTH
THX recommendation: SWFR

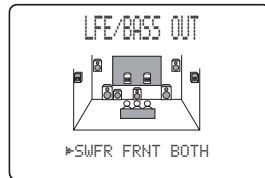

- Select SWFR if you connect a subwoofer. The unit directs all LFE and low-frequency signals to the subwoofer.
- Select FRNT if you do not connect a subwoofer. The unit directs all low-frequency and LFE signals to the front speakers (even if you have previously set FRNT SP to SMALL).
- Select BOTH to direct LFE signals to the subwoofer. Other low-frequency signals are directed to both the subwoofer and the other front channels in accordance with your other speaker settings.

Cross over CROSS OVER

MANUAL SETUP > SOUND MENU > SPEAKER SET > CROSS OVER

Use this feature to select a cross-over (cut-off) frequency for all low-frequency signals. All frequencies below the selected frequency will be sent to the subwoofer.

Choices: 40Hz, 60Hz, **80Hz**, 90Hz, 100Hz, 110Hz, 120Hz, 160Hz, 200Hz

THX recommendation: 80Hz

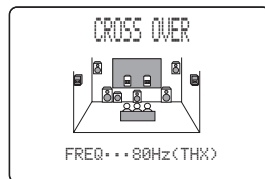
**Speaker level** SP LEVEL

Use these settings to manually balance the speaker levels between the front left or surround left speakers and each speaker selected in SPEAKER SET (page 49).

MANUAL SETUP > SOUND MENU > SP LEVEL >

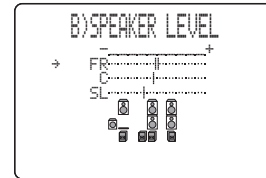

Choices: -10.0 dB to +10.0 dB

- **FR** adjusts the balance of the front left and front right speakers.
- **C** adjusts the balance of the front left and center speakers.
- **SL** adjusts the balance of the front left and surround left speakers.
- **SBL*** adjusts the balance of the surround left and surround back left speakers.
- **SBR*** adjusts the balance of the surround left and surround back right speakers.
- **SR** adjusts the balance of the surround left and surround right speakers.
- **SWFR** adjusts the balance of the front left speaker and subwoofer.
- **PRES** adjusts the balance of the front and presence speakers.

* SB will be displayed if you selected only one surround back speaker in SURR B L/R SP (page 49).



Use a handheld SPL meter, hold at arms length and point upwards so that the meter is in the listening position. With the meter set to the 70 dB scale and to C SLOW, calibrate each speaker to 75 dB.

■ Speaker distance SP DISTANCE

Use this feature to manually input the distance of each speaker and adjust the delay applied to respective channel. Ideally, each speaker should be the same distance from the main listening position. However, this is not possible in most home situations. Thus, a certain amount of delay must be applied to the sound from each speaker so that all sound will arrive at the listening position at the same time. To access these parameters, select:

MANUAL SETUP > SOUND MENU > SP DISTANCE >

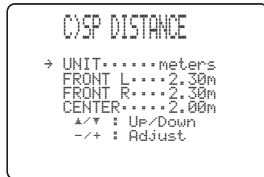

Unit UNIT

Choices: **meters** (m), feet (ft)

- Select meters to input speaker distances in meters.
- Select feet to input speaker distances in feet.

Speaker distances

Choices: 0.3 to 24.00 m (1 to 80 ft)

- **FRONT L** adjusts the distance of the front left speaker. Initial setting: 3.0 m (10.0 feet)
- **FRONT R** adjusts the distance of the front right speaker. Initial setting: 3.0 m (10.0 feet)
- **CENTER** adjusts the distance of the center speaker. Initial setting: 3.0 m (10.0 feet)
- **SURR L** adjusts the distance of the surround left speaker. Initial setting: 3.0 m (10.0 feet)
- **SURR R** adjusts the distance of the surround right speaker. Initial setting: 3.0 m (10.0 feet)
- **SB** adjusts the distance of the surround back left speakers. Initial setting: 2.10 m (7.0 feet)
- **SWFR** adjusts the distance of the subwoofer. Initial setting: 3.0 m (10.0 feet)

■ Graphic equalizer GRAPHIC EQ

Use this feature to select parametric (PEQ) or graphic equalizer (GEQ).

To access these parameters, select:

MANUAL SETUP > SOUND MENU > GRAPHIC EQ >

Equalizer select EQ SELECT

Choices: **PEQ**, GEQ

- Select PEQ to use the equalizer adjusted in auto setup.
- Select GEQ to adjust the built-in 7-band graphic equalizer so that the center, surround L/R and surround back L/R speakers tonal quality matches that of the left and right front speakers.

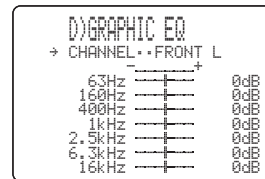

Choices: -6 to +6 (dB)

You can adjust 7 frequency bands: 63Hz, 160Hz, 400Hz, 1kHz, 2.5kHz, 6.3kHz, 16kHz

■ Low-frequency effect level LFE LEVEL

Use to adjust the output level of the LFE (low-frequency effect) channel according to the capacity of your subwoofer or headphones. The LFE channel carries low-frequency special effects which are only added to certain scenes. This setting is effective only when this unit decodes Dolby Digital or DTS signals.

To access these parameters, select:

MANUAL SETUP > SOUND MENU > LFE LEVEL



Choices: -20 to **0** (dB)

Speaker SPEAKER

Select to adjust the speaker LFE level.

Headphone HEADPHONE

Select to adjust the headphone LFE level.

Note

Depending on the settings of LFE LEVEL, some signals may not be output from the SUBWOOFER jack.

SET MENU**Dynamic range** DYNAMIC RANGE

Use to select the amount of dynamic range compression to be applied to your speakers or headphones when using NIGHT (see page 33). This setting is effective only when the unit is decoding Dolby Digital and DTS signals.

To access these parameters, select:

MANUAL SETUP > *SOUND MENU* > *DYNAMIC RANGE* >

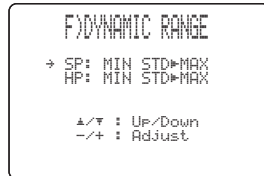

Choices: MIN (minimum), STD (standard), **MAX** (maximum)

SP

Select to adjust the speaker LFE level.

HP

Select to adjust the headphone LFE level.

- Select MAX for feature films.
- Select STD for general use.
- Select MIN for listening to sources at low volume levels.

Low frequency test LOW FRQ. TEST

Use this feature to adjust the output level of the subwoofer so it matches your other speakers.

To access these parameters, select:

MANUAL SETUP > *SOUND MENU* > *LOW FRQ. TEST* >

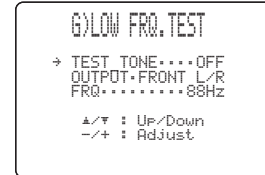

1 Press -/+ to set TEST TONE to ON, and adjust the volume with VOLUME -/+ so you can hear the tone.

Do not turn up the volume too high. If no test tone is heard, turn down the volume, set this unit in the standby mode and make sure all the necessary connections are correct.

- The tone generator produces a narrow-band noise centered on a specified frequency by the band pass filter besides a wide-band noise.

2 Press ▽ to go to "OUTPUT" and press -/+ to select the speaker you want to compare with the subwoofer.

Choices: **FRONT L/R**, FRONT L, CENTER, FRONT R, SUR.R, SBR*, SBL*, SUR.L, SWFR, PRESENCE

* SB will be displayed if you selected only one surround back speaker in SURR B L/R SP (page 49).

3 Press ▽ to go to "FRQ" and press -/+ to select the frequency you want to use.

Choices: 35 to 250 (Hz), Initial: 88 Hz

4 Adjust the volume of the subwoofer with the controls on the subwoofer so it matches that of the speaker you are comparing it to.



You can use the test tone not only for adjusting the subwoofer level, but also for checking the low-frequency characteristics of your listening room. Low-frequency sounds are especially affected by the listener's position, speaker placement, subwoofer polarity and other conditions.

Headphone tone control HP TONE CTRL

Use to adjust the amount of bass and treble output to your headphones.

To access these parameters, select:

MANUAL SETUP > SOUND MENU > HP TONE CTRL
>

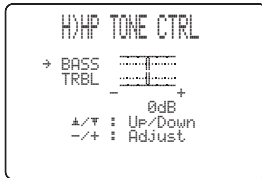

- Use BASS to adjust the headphone bass level.
 - Use TRBL to adjust the headphone treble level.
- Choices: -6 to +6 (dB), Initial: 0 dB

Audio set AUDIO SET

Use to customize this unit's overall audio settings.

To access these parameters, select:

MANUAL SETUP > SOUND MENU > AUDIO SET



Mute MUTE

Use to adjust how much the mute function reduces the output volume.

Choices: **MUTE**, -20dB

- Select MUTE to completely halt all output of sound.
- Select -20dB to reduce the current volume by 20dB.

Delay DELAY

Use to delay the sound output and synchronize it with the video image. This may be necessary when using certain LCD monitors or projectors.

Choices: **0** to 240 (ms)

Dialog lift DIALG.LIFT

Use to turn on/off the DIALG.LIFT parameter (see page 80). This parameter adjusts the height of the front and center channel sounds (dialog, vocals, etc.) by assigning some of the front and center channel elements to the presence speakers.

Choices: ON, **OFF**

- Select ON to turn on DIALG.LIFT effect.
- Select OFF to turn off DIALG.LIFT effect.

Note

DIALG.LIFT appears only when PRESENCE SP is set to PRESENCE (see page 28).

Presence/surround back channel select PR/SBch SELECT

You can select to prioritize either the surround back or presence speakers when playing sources that contain surround back channel signals using CINEMA DSP sound field programs.

MANUAL SETUP > SOUND MENU > PR/SBch SELECT
>

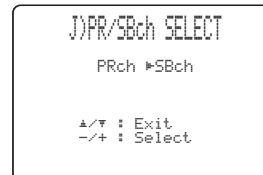

Choices: PRch, **SBch**

- Select SBch to use surround back speakers when a surround back channel signal is detected in a CINEMA DSP program. Presence channel signals will be output from front speakers.
- Select PRch to use presence speakers even when surround back channel signals are input. The signals for the surround back channel will be output from surround speakers.

SET MENU

Manual setup: INPUT

```

3 INPUT MENU
→ A) I/O ASSIGNMENT
  B) INPUT MODE
  C) INPUT RENAME
  D) EXT. INPUT
    ▲/▼ : Up/Down
    -/+ : Enter

```

Input/output assignment I/O ASSIGN

You can assign jacks according to the component to be used if this unit's initial settings do not correspond to your needs. Change the following parameters to reassign the respective jacks and effectively connect more components. Once the inputs have been reassigned, you can select the corresponding component by using INPUT on the front panel or the input selector buttons on the remote control.

MANUAL SETUP > INPUT MENU > I/O ASSIGN >



The default settings are displayed with parentheses on the OSD.

COMPNT-V IN for COMPONENT VIDEO INPUT jacks [A] and [B]

Choices: DVD, V-AUX, DVR/VCR 2, VCR 1, CBL/SAT, DTV, CD-R

```

COMPNT-V INPUT
→ [A]..... DVD
      < DVD >
  [B]..... DTV
      < DTV >

```

OPTICAL OUT for OPTICAL OUTPUT jacks (1) and (2)

Choices: MD/TAPE, CD-R, CD, PHONO, V-AUX, DVR/VCR 2, VCR 1, CBL/SAT, DTV, DVD

```

OPTICAL OUT
→ (1)..... MD/TAPE
      < MD/TAPE >
  (2)..... CD-R
      < CD-R >

```

OPTICAL IN for OPTICAL INPUT jacks (3), (4), (5) and (6)

Choices: CD, PHONO, DVR/VCR 2, VCR 1, CBL/SAT, DTV, DVD, MD/TAPE, CD-R

```

OPTICAL IN
→ (3)..... CD
      < CD >
  (4)..... DVD
      < DVD >
  (5)..... DTV
      < DTV >

```

COAXIAL IN for COAXIAL INPUT jacks (7), (8) and (9)

Choices: CD, PHONO, V-AUX, DVR/VCR 2, VCR 1, CBL/SAT, DTV, DVD, MD/TAPE, CD-R

```

COAXIAL IN
→ (7)..... CD
      < CD >
  (8)..... DVD
      < DVD >
  (9)..... DVR/VCR2
      < DVR/VCR2 >

```

Notes

- You cannot select a specific item more than once for the same type of jack.
- When you connect a component to both the COAXIAL and OPTICAL jacks, priority is given to the input signals from the COAXIAL jack.

Input mode INPUT MODE

Use this feature to designate the input mode for sources connected to the DIGITAL INPUT jacks when you turn on this unit (see page 34 for details about the input mode).

MANUAL SETUP > INPUT MENU > INPUT MODE >

```

B) INPUT MODE
  AUTO ▶ LAST

▲/▼ : Exit
-/+ : Select

```

Choices: **AUTO**, **LAST**

- Select **AUTO** to allow this unit to automatically detect the type of input signal and select the appropriate input mode.
- Select **LAST** to set this unit to automatically select the last input mode used for that source.

Note

Even if **LAST** is selected, the last setting for the EX/ES button will not be recalled.

■ Input rename INPUT RENAME

Use this feature to change the name of the inputs on the OSD and front panel display.

MANUAL SETUP > *INPUT MENU* >
INPUT RENAME >

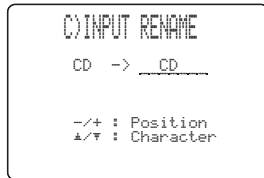

- 1** Press an input selector button to select the input you want to change the name of.
- 2** Press **-/+** to place the **_** (under-bar) under the space or the character you want to edit.
- 3** Press **▲/▼** to select the character you want to use and **-/+** to move to the next one.
 - You can use up to 8 characters for each input.
 - Press **▼** to change the character in the following order, or press **▲** to go in the reverse order: A to Z, a space, 0 to 9, a space, a to z, a space, #, *, +, etc.
 - Repeat steps 1 to 3 to rename each input.
- 4** Press **+** repeatedly to exit from **INPUT RENAME**.

■ External input EXT.INPUT

Use this feature to set the direction of the signals input into the center, subwoofer and surround channels when the source component is connected to the MULTI CH INPUT jacks. If you are inputting 8-channel signals from an external decoder, use this feature to select jacks for the additional front signals.

MANUAL SETUP > *INPUT MENU* >
EXT.INPUT >

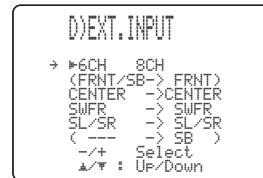

6ch/8ch

This setting is used to select the number of channels input from an external decoder.

Choices: **6ch**, **8ch**

FRONT

If you selected 8ch, you can select analog audio jacks to which front signals from an external decoder will be input. Choices: **DVD**, **DTV**, **CBL/SAT**, **VCR 1**, **DVR/VCR 2**, **MD/TAPE**, **CD-R**, **CD**, **V-AUX**

CENTER

Use to select where the signals input to the CENTER jack will be output.

Choices: **CENTER**, **FRONT**

- Select **CENTER** to output the signals from the center speaker.
- Select **FRONT** to output the signals from the front left and right speakers.

SWFR

Use to select where the signals input to the SUBWOOFER jack will be output.

Choices: **SWFR**, **FRONT**

- Select **SWFR** to output the signals from the subwoofer.
- Select **FRONT** to output the signals from the front left and right speakers.

SL/SR

Use to select where the signals input to the SURROUND jacks will be output.

Choices: **SL/SR**, **FRONT**

- Select **SL/SR** to output the signals from the surround speakers.
- Select **FRONT** to output the signals from the front left and right speakers.

SET MENU**Manual setup: OPTION**

```

4 OPTION MENU
→ A)DISPLAY SET
  B)MEMORY GUARD
  C)PARAM. INI
  D)ZONE SET
  ▲/▼ : Up/Down
  -/+ : Enter

```

■ **Display set** DISPLAY SET
 MANUAL SETUP > OPTION MENU >
 DISPLAY SET >

```

A)DISPLAY SET
→ DIMMER.....0
  OSD SHIFT.....0
  GRAY BACK...AUTO
  V CONU.....ON
  CMPNT OSD....OFF
  ▲/▼ : Up/Down
  -/+ : Select

```

Dimmer DIMMER

Use to adjust the brightness of the front panel display.
 Choices: -4 to 0

OSD shift OSD SHIFT

Use to adjust the vertical position of the OSD.
 Choices: +5 (downward) to -5 (upward)

- Press + to lower the position of the OSD.
- Press - to raise the position of the OSD.

Gray back GRAY BACK

Selecting AUTO for the on-screen display setting displays a gray background when there's no video signal input. Nothing is displayed if OFF is selected.
 Choices: **AUTO**, OFF

Note

If "GRAY BACK" is set to OFF, no information will be displayed on the screen when video signals are not being input.

Video conversion V CONU.

Use this feature to turn on/off the conversion of composite signals to both S-video and component signals. This allows you to output composite signals from the S-video jack or the component video jack when no S-video or component signals are input. This feature also converts S-video signals to component signals when no component signals are input.

Choices: **ON**, OFF

- Select OFF not to convert any signals.
- Select ON to convert composite signals to S-video and component signals, and to convert S-video signals to component signals.

Note

• Converted video signals are only output to the MONITOR OUT jacks. When recording you must make the same type of video connections (composite or S-video) between each component.

Component OSD CMPNT OSD

Use this feature to turn on/off the OSD when you are using COMPONENT VIDEO MONITOR OUT jacks while using the set menu.

Choices: **ON**, OFF

- Select ON to output the OSD signals from COMPONENT VIDEO MONITOR OUT jacks while using the set menu.
- Select OFF if you do not want to output the OSD signals from COMPONENT VIDEO MONITOR OUT jacks while the using set menu.

Note

Set menu functions even when OFF is selected.

Memory guard MEMORY GUARD

Use this feature to prevent accidental changes to DSP program parameter values and other system settings.
 MANUAL SETUP > OPTION MENU >
 MEMORY GUARD >

```

B)MEMORY GUARD
  ►OFF ON
  ▲/▼ : Exit
  -/+ : Select

```

Choices: **ON**, OFF

Select ON to protect:

- DSP program parameters
 - All SET MENU items
 - All speaker levels
 - The on-screen display (OSD) mode
- When MEMORY GUARD is set to ON, you cannot use the test tone or select any other SET MENU items.

■ Parameter initialization PARAM. INI

Use this feature to initialize the parameters for each sound field program within a sound field program group. When you initialize a sound field program group, all of the parameter values within that group revert to their initial settings.

MANUAL SETUP > OPTION MENU >

PARAM. INI >

Press the corresponding numeric button for the sound field program that you want to initialize.

An asterisk (*) next to a program number means that the parameter values have been changed from their initial settings.

```
C)PARAM. INI
  1  2  3 *4
 *5  6  7  8
  9 *10 11
```

Notes

- You cannot automatically revert to the previous parameter settings once you initialize a sound field program group.
- You cannot separately initialize individual sound field programs.
- You cannot initialize any program groups when MEMORY GUARD is set to ON.

■ Speaker impedance setting SP IMP.SET

Use to select the impedance of your speakers.

MANUAL SETUP > OPTION MENU >

SP IMP.SET >

```
D)SP IMP.SET
  Minimum 8ohms

  ▲/▼ : Exit
  -/+ : Select
```

Choices: 6ohms, **8ohms**

■ Zone set ZONE SET

Use to specify the location of speakers connected the SPEAKERS B terminals.

MANUAL SETUP > OPTION MENU >

ZONE SET >

```
E)ZONE SET
  SP_B.....FRONT

  ▲/▼ : Exit
  -/+ : Select
```

SP B

Use this feature to select the location of the front speakers connected to the SPEAKERS B terminals.

Choices: **FRONT**, ZONE B

- Select FRONT to turn on/off SPEAKERS A and B when the speakers connected to the SPEAKERS B terminals are set in the main room.
- Select ZONE B if the speakers connected to the SPEAKERS B terminals are set in another room. If SPEAKERS A is turned OFF and SPEAKERS B is turned ON, all the speakers including the subwoofer in the main room are muted and the unit outputs sound from SPEAKERS B only.

Notes

- If you connect headphones to the PHONES jack on the unit, the sound is output from both headphones and SPEAKERS B.
- When a DSP program is selected, the unit automatically enters the Virtual Cinema DSP mode.

■ Zone 2 set ZONE2 SET

(U.S.A., Canada and Australia models only)

MANUAL SETUP > OPTION MENU >

ZONE2 SET >

```
F)ZONE2 SET
  OUTPUT VOL...VAR.
  ZONE2 AMP...OFF

  ▲/▼ : Up/Down
  -/+ : Select
```

Output volume OUTPUT VOL

Use to select how the volume control will operate with regard to the ZONE 2 OUTPUT jacks.

Choices: **VAR.**, FIX

- Select VAR. to adjust the ZONE 2 OUTPUT volume simultaneously with VOL +/- on the remote control.
- Select FIX to fix the ZONE 2 OUTPUT volume level to a standard line level.

Zone 2 amplifier ZONE2 AMP

Use to select how the ZONE 2 speakers will be amplified.

Choices: ON, **OFF**.

- Select OFF if you do not use Zone 2 speakers or if you connect your Zone 2 speakers through an external amplifiers connected to this unit's ZONE 2 OUTPUT jacks.
- Select ON to use this unit's internal amplifier if you connect your Zone 2 speakers directly to this unit's PRESENCE/ZONE 2 speaker terminals.

SET MENU

■ **Zone 3 set** ZONE3 SET

(U.S.A., Canada and Australia models only)

Output volume OUTPUT VOL

Use to select how the volume control will operate with regard to the ZONE 3 OUT jacks.

MANUAL SETUP > OPTION MENU >

ZONE3 SET >

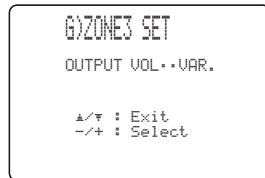

Choices: **VAR.**, FIX

- Select **VAR.** to adjust the ZONE 3 OUT volume simultaneously with VOL +/- on the remote control.
- Select **FIX** to fix the ZONE 3 OUT volume level to a standard line level.

REMOTE CONTROL FEATURES

In addition to controlling this unit, the remote control can also operate other A/V components made by YAMAHA and other manufacturers. To control other components, you must set up remote control with the appropriate manufacturer codes.

This remote control also has two other sophisticated features: Learn and Macro. The Learn feature allows the remote to acquire functions from other remote controls equipped with an infrared remote control receiver. The Macro feature allows you to program a series of operations in sequence for operation by single button, or to use the factory-set macros to operate other YAMAHA components.

Notes

- For the operation distance of the remote control and notes about batteries, see pages 3 and 7.
- For the name and function of each part and button, see page 6.

Control area

■ Controlling this unit

The shaded area below can control this unit no matter which component control area is selected.

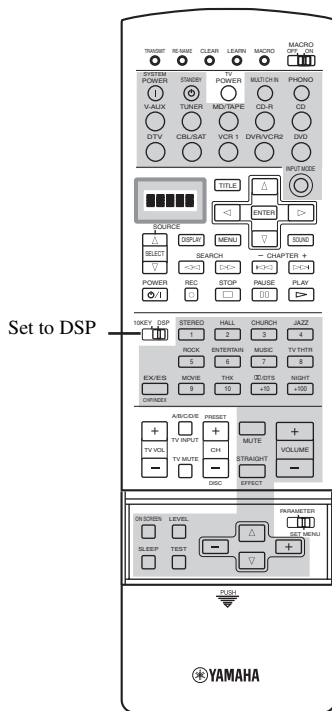

Set to DSP

■ Controlling other components

The shaded areas below can be used to control other components. Each button has a different function depending on the selected components. Select the component you want to control by pressing an input selector button or SOURCE SELECT Δ/∇ . The name of the selected component appears in the display window.

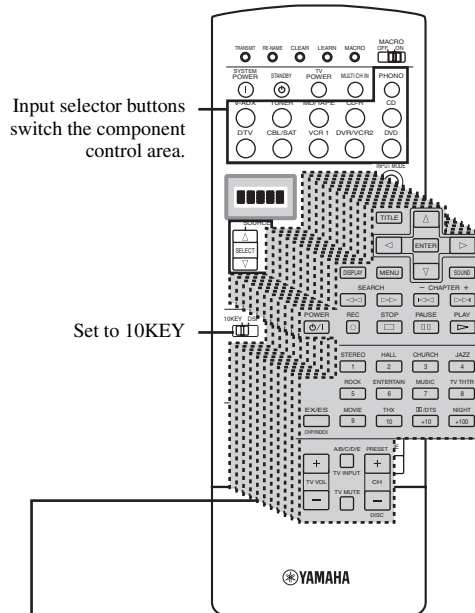

Input selector buttons switch the component control area.

Set to 10KEY

Component control area

You can control up to 11 different components by setting appropriate manufacturer codes (see page 67).

ADVANCED
OPERATION

English

REMOTE CONTROL FEATURES

Setting manufacturer codes

You can control other components by setting the appropriate manufacturer codes. Codes can be set up for each input area.

The following table shows the default component (Library: component category) and the manufacturer code for each area.

| Input area | Component category (Library) | Manufacturer |
|------------|------------------------------|--------------|
| PHONO | TV | – |
| V-AUX | VCR | – |
| TUNER | TUNER | Yamaha-1 |
| MD/TAPE | MD | Yamaha-1 |
| CD-R | CD-R | Yamaha |
| CD | CD | Yamaha-1 |
| DTV | TV | – |
| CBL/SAT | CABLE | – |
| VCR 1 | VCR | – |
| DVR/VCR2 | VCR | – |
| DVD | DVD | Yamaha-1 |

Note

You may not be able to operate your Yamaha component even if Yamaha manufacture code is initially set as listed above. In this case, try to set other Yamaha manufacture code(s).

- 1 Press an input selector button to select the source component you want to set up.

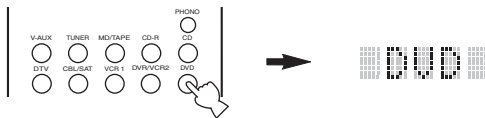

- 2 Press and hold LEARN for about 3 seconds using a ballpoint pen or similar object.

“SETUP” and the selected component name appear alternately in the display window.

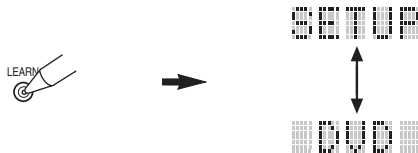

Be sure to press and hold LEARN for at least 3 seconds, otherwise the learning process will start.



Complete each of the following steps in 30 seconds. Otherwise, the learning mode will be automatically canceled. In this case, press LEARN again.

- 3 Press Δ/∇ to select the name of your component's manufacturer.

You will find the names of most worldwide audio-video manufacturers in alphabetical order in the display window.

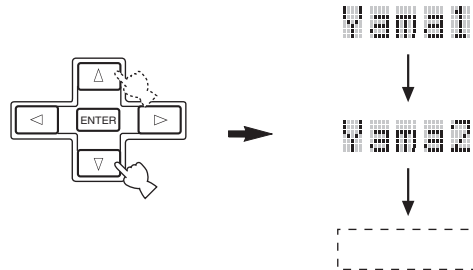

If you want to change a library (component category), press $\triangleleft/\triangleright$. You can set a different type of component.

Library choices: L:DVD, L:LD, L:CD, L:CDR, L:MD, L:TAP (tape), L:TUN, L:AMP*, L:TV, L:CAB (cable), L:DBS, L:SAT, L:VCR

* The amplifier Library (L:AMP) code is preset to “YPC” to operate this unit. However, you can switch between the following four codes if necessary.

- YPC To operate this unit.
 ZONE (U.S.A., Canada and Australia models only)
 To operate ZONE 2 or ZONE 3 features.
 DSP To operate Yamaha DSP amplifiers that cannot be operated with the YPC code.
 NO To operate other manufactures' amplifiers using this unit's remote control.

- 4 Press one of the buttons shaded below to see if you can control your component. If you can, the manufacturer code is correct.

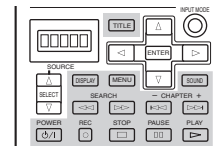

- If the manufacturer of your component has more than one codes, try each of them until you find the correct one.
- If you continuously want to set up another code for another component, press ENTER and repeat steps 1, 3 and 4.

5 Press LEARN again to exit from the setup mode.



Notes

- The supplied remote control does not contain all possible manufacturer codes for commercially available AV components (including Yamaha AV components). If operation is not possible with any of the manufacturer codes, program the new remote control function with the Learn feature (see below) or use the remote control supplied with the component.
- If you have already programmed a remote control function for a button, the function by learning programming takes priority over the setup manufacturer code's function.
- "ERROR" appears in the display window when press any buttons other than indicated in each step, or when you press more than one button at once.

Programming codes from other remote controls

If you want to program functions not included in the basic operations covered by the manufacturer code, or an appropriate manufacturer code is not available, do the following. You can program any of the buttons available in the component control area (see page 59). The buttons can be programmed independently for each component.

Note

This remote control transmits infrared rays. If the other remote control also uses infrared rays, this remote control can learn most of its functions. However, you may not be able to program some special signals or extremely long transmissions. (Refer to the operation instructions for the other remote control.)

1 Set 10KEY/DSP to 10KEY.



It is also possible to program in this unit's control area with 10KEY/DSP set to DSP. However, if you do this, you will not be able to control this unit and select sound field programs.



2 Press an input selector button to select a source component.



3 Place this remote control about 5 to 10 cm apart from the other remote control on a flat surface so that their infrared transmitters are aimed at each other.

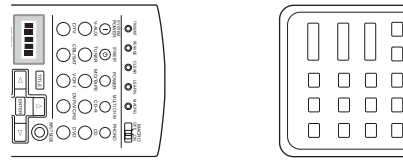

5 to 10 cm (2 to 4 inch)

4 Press LEARN using a ballpoint pen or similar object.

Do not press and hold LEARN. If you hold it down for more than three seconds, the remote enters the manufacturer code setting mode.

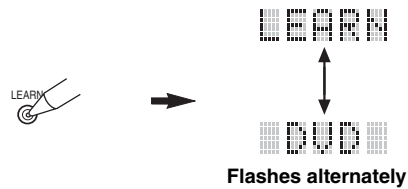

Complete each of the following steps in 30 seconds. Otherwise, the learning mode will be automatically canceled. In this case, press LEARN again.

5 Press the button at which you want to program the new function.

"LEARN" is displayed.

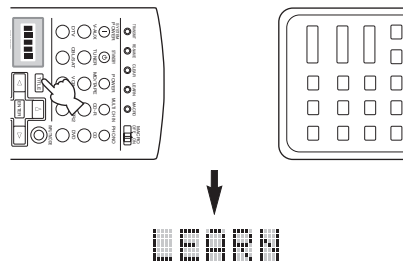

REMOTE CONTROL FEATURES

6 Press and hold the button you want to program on the other remote control until “OK” appears in the display window.

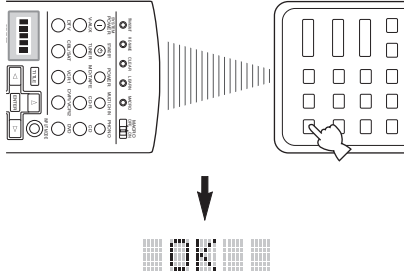

Notes

- “NG” appears in the display window if programming was unsuccessful. In this case, start over from step 5.
- This remote control can learn approximately 120 functions. However depending on the signals learned, “FULL” may appear in the display before you program 120 functions. In this case, clear unnecessary programmed functions to make room for further learning.

7 Repeat steps 5 and 6 to program additional functions.

8 Press LEARN again to exit from the learning mode.



Notes

- Learning may not be possible in the following cases:
 - When the batteries in the remote control for this unit or other components are weak.
 - When the distance between the two remote controls is too great or too small.
 - When the remote control infrared windows are not facing at the appropriate angle.
 - When the remote control is exposed to direct sunlight.
 - When the function to be programmed is continuous or uncommon.
- “ERROR” appears in the display window if you press more than one button at the same time.

Changing source names in the display window

You can change the name that appears in the display window on the remote control if you want to use the different name than the factory preset. This is useful when you have set the input selector to control a different component.

1 Press an input selector button to select the source component you want to rename.
The selected component name appears in the display window.

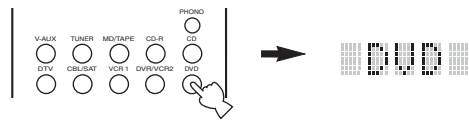

2 Press RE-NAME using a ballpoint pen or similar object.



3 Press Δ/∇ to select and enter a character.
Pressing ∇ changes the character as follows: A to Z, a to z, 0 to 9, space, -(hyphen), and /(slash). (Pressing Δ changes the characters in reverse order.)

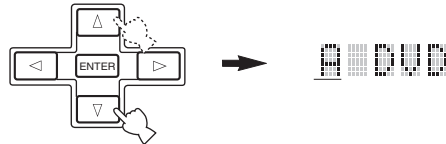

4 Press \leftarrow/\rightarrow to move the cursor to the next position.

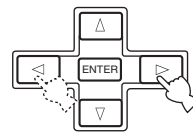

If you want to continue setting up names for other components, press ENTER and repeat steps 1, 3 and 4.

5 Press RE-NAME again to exit from the renaming mode.



Using the macro feature

The Macro feature makes it possible to perform a series of operations by pressing just one button. For example, when you want to play a CD, normally you would turn on the components, select the CD input, and press the play button to start playback. The Macro feature lets you perform all those operations by simply pressing the CD macro button. The buttons listed as macro buttons below are factory set with macro programs. You can also program your own macros (see page 64).

Press a macro button

To automatically transmit these signals in order



(CD area)

| Macro buttons | First | Second | Third |
|-------------------|---------------------------|-----------------|--------------------------------|
| PHONO ○ | | PHONO ○ | — |
| V-AUX ○ | | V-AUX ○ | — |
| TUNER ○ | | TUNER ○ (*3) | — |
| MD/TAPE ○ | | MD/TAPE ○ | PLAY ▶ (MD/TAPE area) (*2) |
| CD-R ○ | | CD-R ○ | PLAY ▶ (CD-R area) (*2) |
| CD ○ | | CD ○ | PLAY ▶ (CD area) (*2) |
| DTV ○ | | DTV ○ | — |
| CBL/SAT ○ | | CBL/SAT ○ | — |
| VCR 1 ○ | | VCR 1 ○ | PLAY ▶ (VCR 1 area) (*2) |
| DVR/VCR2 ○ | | DVR/VCR2 ○ | PLAY ▶ (DVR/VCR2 area) (*2) |
| DVD ○ | | DVD ○ | PLAY ▶ (DVD area) (*2) |
| SYSTEM POWER ① | SYSTEM POWER ① (*1) | | |
| TV POWER ○ | TV POWER ○ | | |
| MULTI CH IN ○ | MULTI CH IN ○ | | |
| STANDBY Ⓞ | STANDBY Ⓞ | | |

*1 You can turn on some components (including YAMAHA components) connected to this unit by connecting them to the AC OUTLET(S) on the rear panel. (Power control may not be synchronized with this unit depending on the component. For details, please refer to the operation instruction for the connected component.)

*2 Playback can be started with any YAMAHA remote control-compatible MD recorder, CD player, CD recorder, DVD player, or LD player. When using macros to operate other components, you will need to program the PLAY button on the control area of that component (see pages 61 and 62) or to set up a manufacturer code (see page 60).

*3 When TUNER is selected as the input source, this unit receives the last station received before the unit was set to the standby mode.

REMOTE CONTROL FEATURES

Macro operations

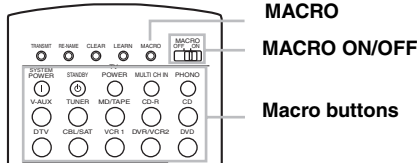

1 Set MACRO ON/OFF to ON.

2 Press a macro button.

Note

- When you have finished using the Macro feature, set MACRO ON/OFF to OFF.
- While the remote is carrying out a macro program, it will not accept any other button's function until the macro operation is complete (the TRANSMIT indicator stops flashing).
- Continue to aim the remote control at the component the macro is operating until the macro operation is complete.

Programing a macro

You can program your own macros and use the Macro feature to transmit several remote control commands in order by pressing a single button. Be sure to set up manufacturer codes or perform learning operations before programming the macro. We do not recommend programming continuous operations such as volume control in a macro.

Notes

- The default macro is not cleared when a new macro is programmed for a button. The default macro can be used again when the programmed macro is cleared.
- It is not possible to add a new signal (macro step) to the default macro. Programming a macro changes all macro contents.

1 Press MACRO using a ballpoint pen or similar object.

"MCR ?" appears in the display window.



Complete each of the following steps in 30 seconds. Otherwise, the learning mode will be automatically cancelled. In this case, press MACRO again.

2 Press the macro button you will use to operate the macro.

The macro button name and the selected component name appear alternately in the display window.

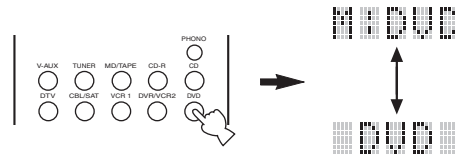

Notes

- "AGAIN" appears in the display window if you press a button other than a macro button.
- To change the selected source component, press SOURCE SELECT Δ/∇ . Pressing the input selector buttons will program a macro step, whereas SOURCE SELECT Δ/∇ only changes the selected component and corresponding component control area.

3 Press the buttons for the functions you want to include in the macro operation in order.

You can set up to 10 steps (10 functions). After you have set 10 steps, "FULL" appears and the remote control automatically exits from the macro mode.

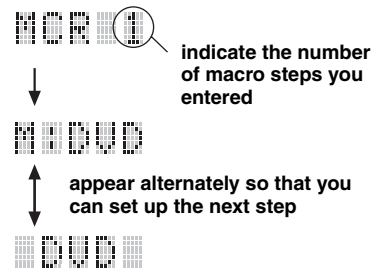
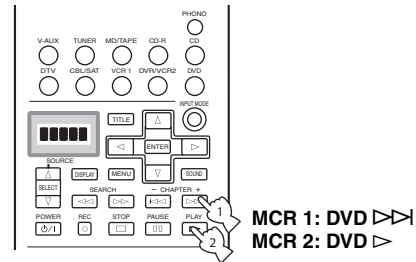

Note

"NG" appears in the display window if programming was unsuccessful. In this case, start over from step 2.

4 Press MACRO again when the operation sequence you want to program is complete.

Memory back-up

If the remote control is without batteries for more than 3 minutes, or if exhausted batteries remain in the remote control, the contents of the memory may be cleared. When the memory is cleared, insert new batteries, set up the manufacturer code and program any acquired functions that may have been cleared.

Clearing function sets

You can clear all changes made in each function set, such as learned functions, macros, renamed source names and setup manufacturer codes.

1 Press CLEAR by using a ballpoint pen or similar object.

Complete each of the following steps in 30 seconds. Otherwise, the learning mode will be automatically canceled. In this case, press CLEAR again.

2 Press Δ/∇ to select the clear mode.

- L: DVD** (L: name of a component)
Clears all learned functions in the respective component control area. Press an input selector button to select the component.
- L: AMP**
Clears all learned functions for this unit's control area.
- L: ALL**
Clears all learned functions.
- M: ALL**
Clears all programmed macros.
- RNAME**
Clears all renamed source names.
- FCTRY**
Clears all remote functions and returns the remote to the factory settings.

3 Press and hold CLEAR again for about 3 seconds.

"C:OK" appears in the display window.

**Note**

"C:NG" appears in the display window if the operation is unsuccessful. In this case, start over from step 2.

4 Press CLEAR to exit from the clearing mode.

Once you have cleared a learned function or macro for a button, the button reverts to the factory setting.

**Note**

"ERROR" appears in the display window under the following circumstances:

- When a button other than the cursor is pressed.
- When more than one button is pressed at once.
- When MACRO ON/OFF or 10KEY/DSP is switched to another position.

REMOTE CONTROL FEATURES**Clearing individual functions****■ Clearing a learned function**

You can clear the function learned in a certain programmed button in each area.

1 Press an input selector button to select the source component containing the function you want to clear.

The selected component name appears in the display window.

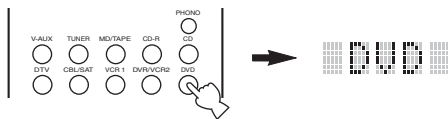

2 Press LEARN using a ballpoint pen or similar object.

“LEARN” and the selected component name appear alternately in the display window.

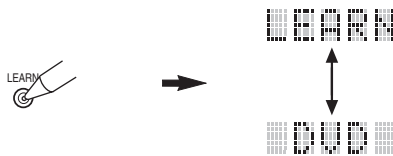

Complete each of the following steps in 30 seconds. Otherwise the learning mode will be automatically canceled. In this case, press LEARN again.

3 Press and hold CLEAR using a ballpoint pen or similar object, then press the button you want to clear for about 3 seconds.

“C:OK” appears in the display window.

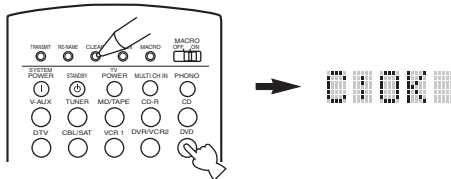

When you clear a learned function, the button reverts to the factory setting (or to the manufacturer setting if you have set manufacturer codes).

4 Repeat step 3 to clear other learned functions.

5 Press LEARN again to exit.

■ Clearing a macro function

1 Press MACRO using a ballpoint pen or a similar object.



Complete each of the following steps in 30 seconds. Otherwise the learning mode will be automatically canceled. In this case, press MACRO again.

2 Press and hold CLEAR using a ballpoint pen or similar object, then press the macro button you want to clear for about 3 seconds.

“C:OK” appears in the display window.

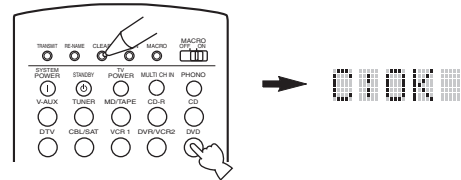

When you clear macro, the button reverts to the factory setting.

3 Repeat step 2 to clear other macro functions.

4 Press MACRO again to exit from the clearing mode.



Controlling each component

Once you set the appropriate manufacturer codes, you can use this remote to control your other components. Note that some buttons may not correctly operate the selected component. Use the input selector buttons to select the component you want to operate. The remote control automatically switches to the appropriate control mode for that component.



- To control a component without changing the receiver's input mode, use SOURCE SELECT Δ/∇ to select the component.
- TV VOL +/-, TV INPUT, and TV MUTE will operate your TV without switching the input if the manufacturer code for your TV is set up in the DTV areas. If a component other than TV is set up in the DTV area, you can control your TV by setting up your TV in the PHONO area. If your TV is set up in both the DTV and PHONO areas, priority is given to the signal in the DTV area.

Operating a DVD player (DVD area)

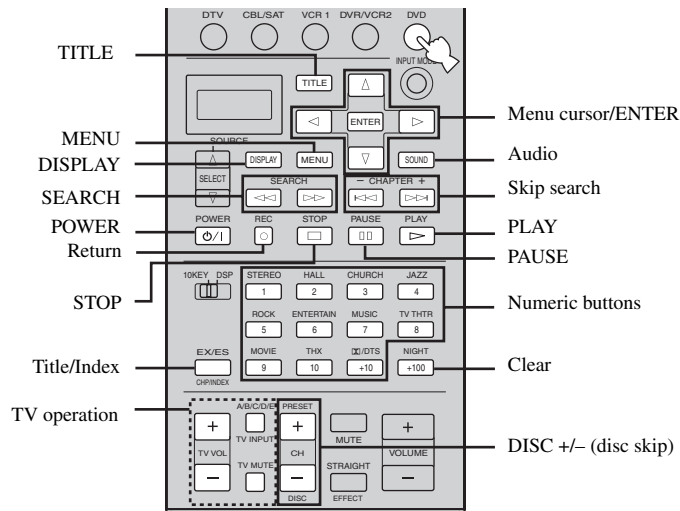

Operating a VCR (VCR 1, DVR/VCR2 and V-AUX areas)

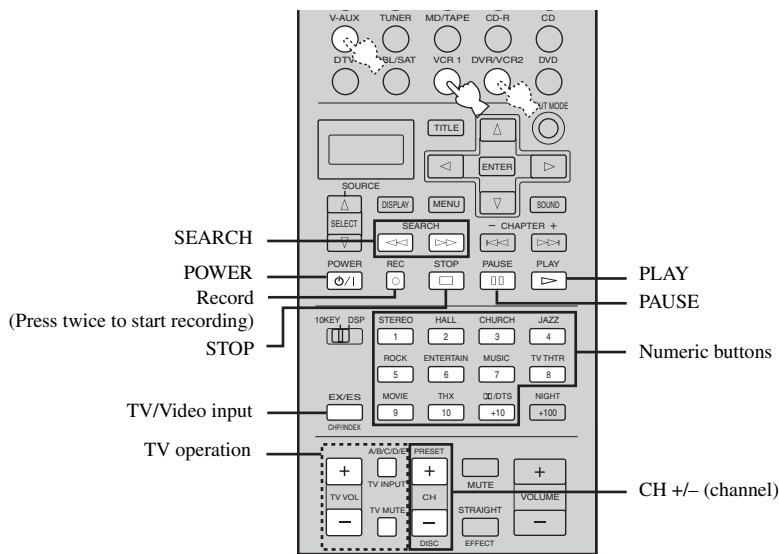

REMOTE CONTROL FEATURES

■ Operating a digital TV (DTV area) or a cable/satellite TV (CBL/SAT area)

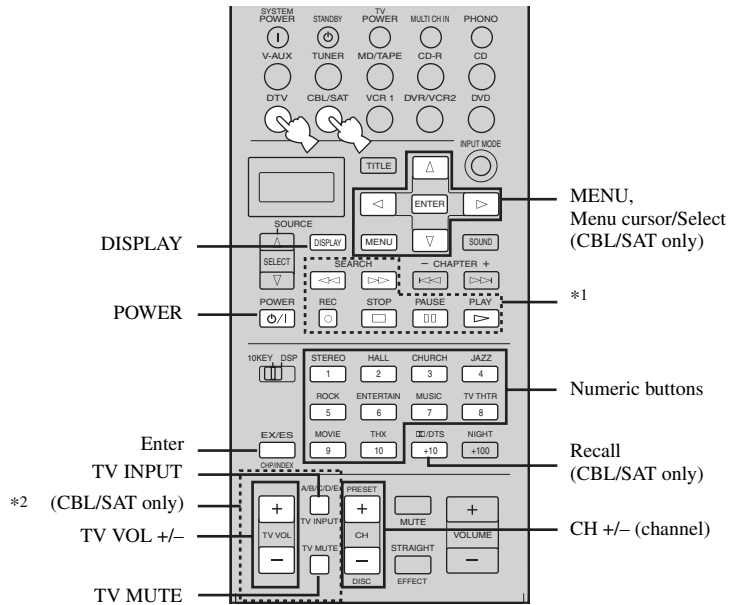

*1 SEARCH, REC, STOP, PAUSE and PLAY will operate your VCR without switching the input to VCR 1 if the manufacturer code for your VCR is set up in the VCR 1.

*2 TV VOL +/-, TV INPUT and TV MUTE will operate your TV without switching the input if the manufacture code for your TV is set up in the DTV area.

■ Operating an LD player

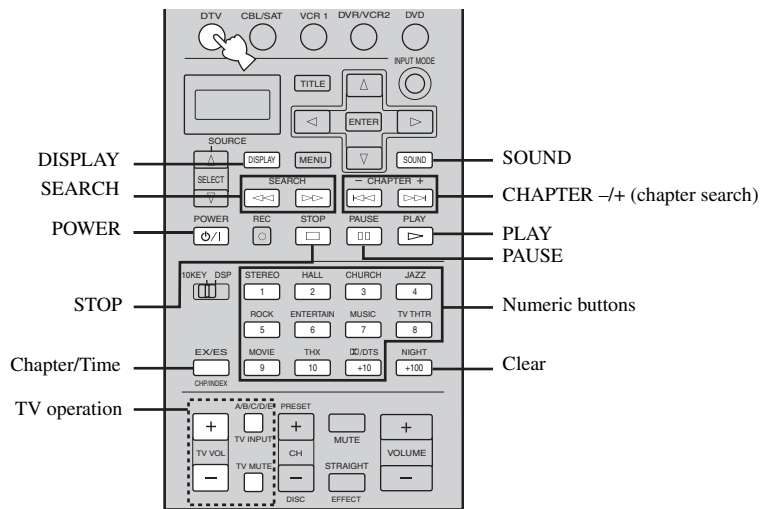

Set the manufacture code for your LD player following the setting procedure described on page 60 because TV is factory-set for this input selector button.

■ Operating a CD player (CD area)

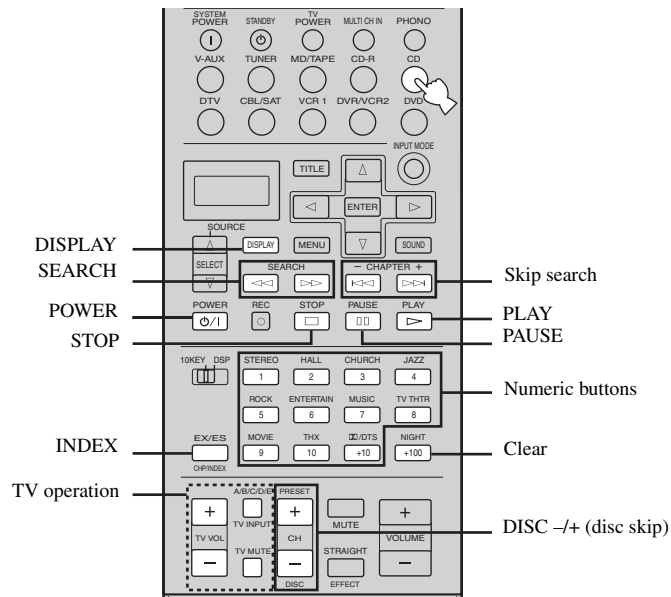

■ Operating a CD recorder (CD-R area) or an MD recorder (MD/TAPE area)

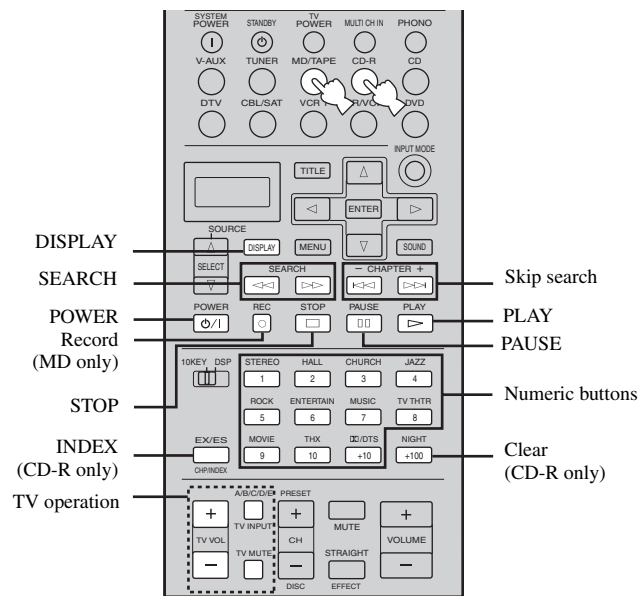

ADVANCED
OPERATION

English

REMOTE CONTROL FEATURES

■ Operating a tape deck (MD/TAPE area)

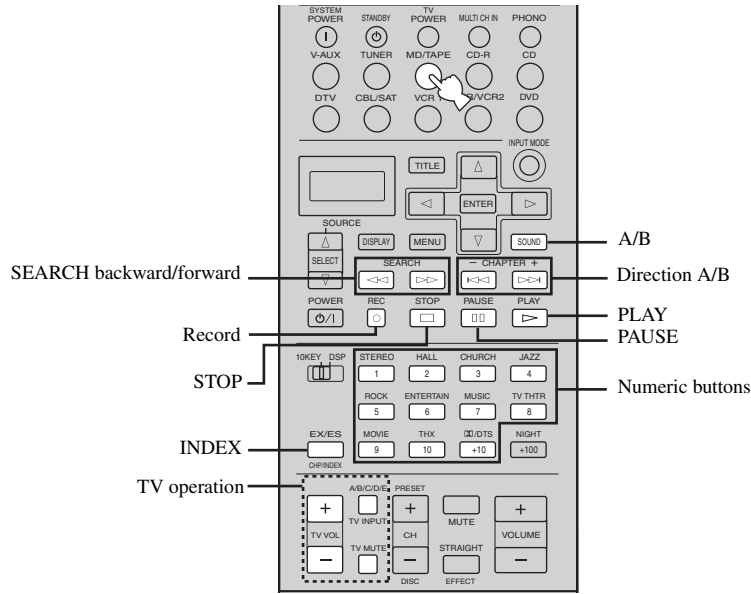

Set the manufacture code for your tape deck following the setting procedure described on page 60 because TV is factory-set for this input selector button.

■ Operating a tuner (TUNER area)

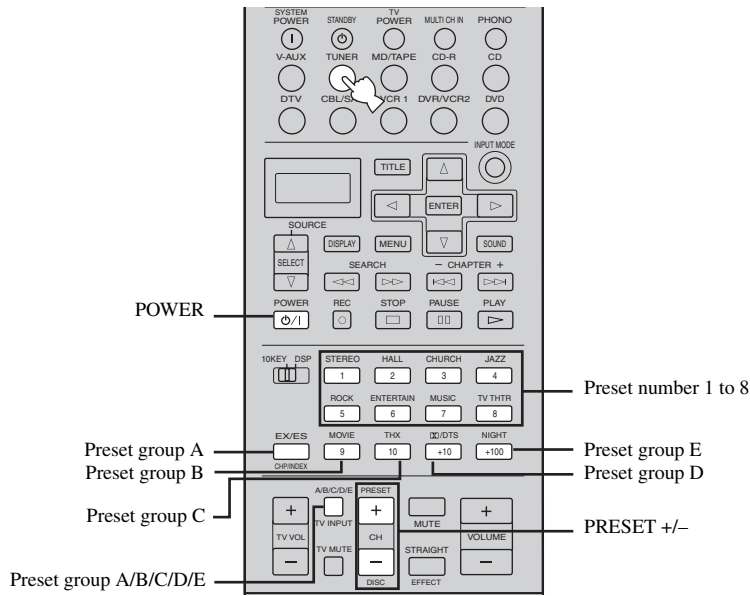

■ **Operating an optional component (OPTN area)**

OPTN is an extra component control area that can be programmed with remote control functions independently from any input source.

Notes

- You cannot set up the manufacturer code in this area. See page 61 to program buttons in this component control area.
- OPTN area cannot be used when ZONE (U.S.A., Canada and Australia models only) is selected in the amplifier Library (page 60).

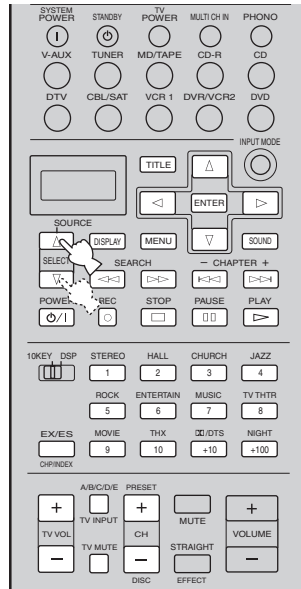

ADVANCED
OPERATION

English

ZONE 2/ZONE 3 (U.S.A., CANADA AND AUSTRALIA MODELS ONLY)

This unit allows you to configure a multi-room audio-video system. The Zone 2 and Zone 3 features enable you to set this unit to reproduce separate input sources in the main room, second room (Zone 2) and third room (Zone 3) using the supplied remote control from the second or third room.

Only analog signals are sent to the second and third rooms. Any source you want to listen to in the second or third room must be connected using the analog (AUDIO L/R) input jacks on this unit.

Zone 2/Zone 3 connections

You need the following additional equipment to use the multi-room functions of this unit:

- An infrared signal receiver in the second and/or third room.
- An infrared emitter in the main room. This emitter transmits the infrared signals from the remote control in the second and/or third room to the main room (to a CD player or LD player, for example).
- An amplifier and speakers for the second and/or third room.
- A video monitor for the second room.

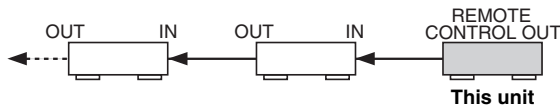

- Since there are many possible ways to connect and use this unit in a multi-room installation, we recommend that you consult with the nearest authorized YAMAHA dealer or service center for the Zone 2/Zone 3 connections which will best meet your requirements.
- Some YAMAHA models are able to connect directly to the REMOTE CONTROL OUT jack of this unit. If you own these products, you may not need to use an infrared emitter. Up to 6 YAMAHA components can be connected as shown.

System configuration and connections example

Using external amplifiers

To use an external amplifier in Zone 2, select OFF in ZONE2 AMP.

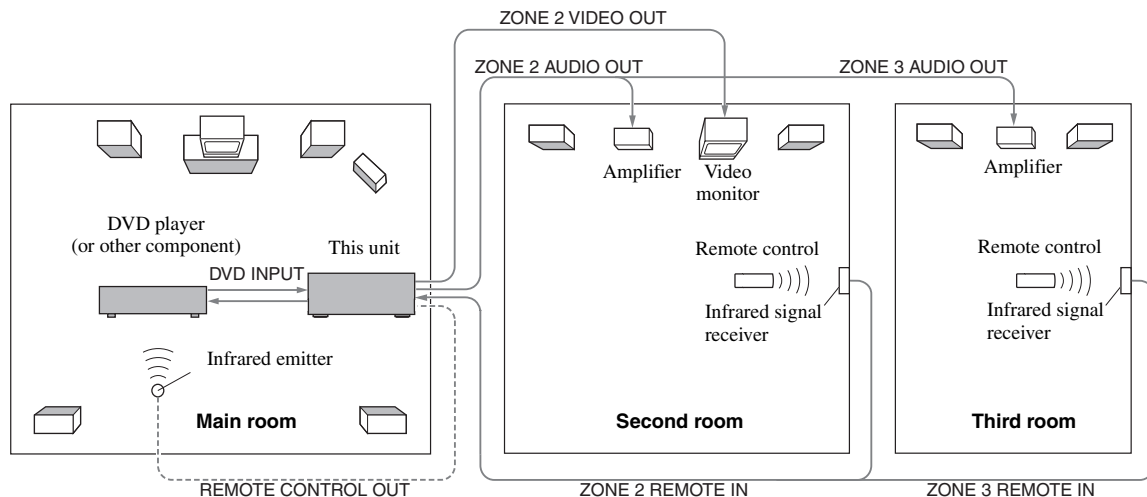

Notes

- When not using the main room, turn down the volume of this unit in the main room. Adjust the Zone 2/Zone 3 volume by using the amplifier in the second/third room.
- To avoid unexpected noise, DO NOT USE the Zone 2/Zone 3 feature with CDs encoded in DTS.

ZONE 2/ZONE 3 (U.S.A., CANADA AND AUSTRALIA MODELS ONLY)

Using this unit's internal amplifier

To use this unit's internal amplifier, select ON in ZONE2 AMP.

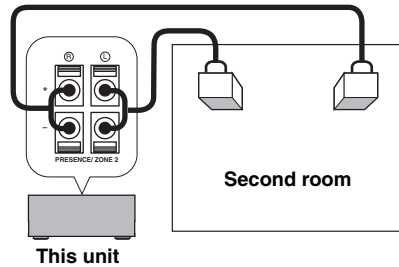

Remote controlling Zone 2/Zone 3

The supplied remote control can be used to control Zone 2/Zone 3. You can even select the input source and control components located in the main room directly from the second/third room regardless of the listening condition in the main room.

To enable Zone mode on the remote control

You will be able to switch the remote control mode from one room to another, and use STANDBY, SYSTEM POWER, MUTE and VOLUME +/- to control the selected room.

5 Press LEARN to complete the Zone setup.

The remote control will be able to operate this unit from Zone 2 or Zone 3.



To control Zone 2/Zone 3

1 Press SOURCE SELECT Δ repeatedly to display "Zone2" or "Zone3" in the display window.

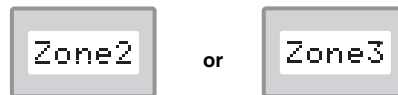
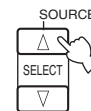

1 Set REC OUT/ZONE 2 on the front panel to SOURCE/REMOTE.

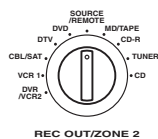

2 Repeat steps 1 and 2 of the procedure in "Setting manufacturer codes" on page 60.

3 Press $\triangleleft/\triangleright$ to select "L:AMP".

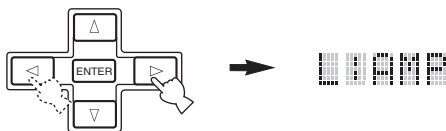

4 Press Δ/∇ to select "Zone".

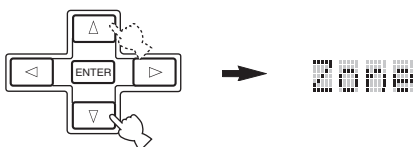

2 Press SYSTEM POWER to turn Zone 2 or Zone 3 power on.

3 Press an input selector button to select the input source you want to listen to in the second/third room.

The display window shows "2: name of selected input" if the remote control is in the Zone 2 mode.

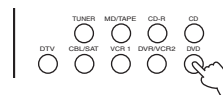

Note

Signals input to V-AUX and PHONO jacks cannot be sent to Zone 2/Zone 3.

ZONE 2/ZONE 3 (U.S.A., CANADA AND AUSTRALIA MODELS ONLY)

- 4 You can control the unit from Zone 2 or Zone 3 by using the input selector, STANDBY, SYSTEM POWER, MUTE and VOLUME +/- buttons.**

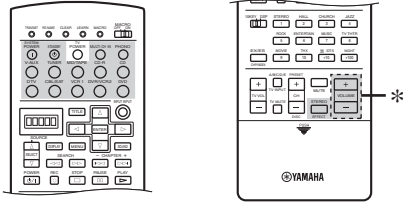

* VOLUME +/- can be used only when VAR. is selected in ZONE2 SET/ZONE3 SET OUTPUT VOL. (page 57).

- 5 Press SOURCE SELECT Δ/∇ to exit from the Zone 2/Zone 3 mode.**

Notes

- The source in Zone 2 and the source available for recording are always the same.
- "Zone2" or "Zone3" will appear in the display window only when Δ is pressed, and SYSTEM only when ∇ is pressed

Turning this unit to either on or standby

SYSTEM POWER and STANDBY work differently depending on the selected mode that appears on the display window.

- When normal, Zone2 or Zone 3 mode is selected, you can turn the main unit, Zone 2 or Zone 3 to on/standby individually.
- When System mode is selected, or when YPC is selected as the amplifier library (L:AMP) code, you can turn on/standby the main unit, Zone 2 and Zone 3 to on/standby all together simultaneously.

| | LCD display | SYSTEM POWER/ STANDBY |
|---------------------|----------------------------------|---|
| Normal mode* | name of component | turns the main unit on/standby |
| Zone 2 mode | "Zone2" or "2:name of component" | turns Zone 2 to on/standby |
| Zone 3 mode | "Zone3" or "3:name of component" | turns Zone 3 to on/standby |
| System mode | "SYSTEM" | turns everything (the main unit, Zone 2, Zone 3) on/standby |

* "MAIN" appears for a few seconds when SYSTEM POWER or STANDBY is pressed.

Special considerations for DTS software

The DTS signal is a digital bitstream. If you attempt to send the DTS signal to the second/third room you will only hear digital noise (that may damage your speakers). Thus, the following considerations and adjustments need to be made when playing DTS encoded discs.

For LDs or DVDs encoded with DTS

Only 2 channel analog audio signals may be sent to the second/third room.

- for LDs: Set your LD player's left and right outputs to the analog soundtrack.
- for DVDs: Use the disc menu to set the DVD player's mixed 2-channel left and right audio outputs to the PCM or Dolby Digital soundtrack.

For CDs encoded in DTS

To avoid unexpected noise, DO NOT USE the Zone 2/Zone 3 feature with CDs encoded in DTS.

EDITING SOUND FIELD PARAMETERS

What is a sound field

What really creates the rich, full tones of a live instrument are the multiple reflections from the walls of the room. In addition to making the sound “live”, these reflections enable us to tell where the player is situated, and the size and shape of the room in which we are sitting.

■ Elements of a sound field

In any environment, in addition to the direct sound coming straight to our ears from the player’s instrument, there are two distinct types of sound reflections that combine to make up the sound field:

Early reflections

Reflected sounds reach our ears extremely rapidly (50 ms – 100 ms after the direct sound), after reflecting from one surface only — for example, from the ceiling or a wall. Early reflections actually add clarity to the direct sound.

Reverberations

These are caused by reflections from more than one surface — walls, ceiling, the back of the room — so numerous that they merge together to form a continuous sonic “afterglow”. They are non-directional, and lessen the clarity of the direct sound.

Direct sound, early reflections and subsequent reverberation taken together help us to determine the subjective size and shape of the room, and it is this information that the digital sound field processor reproduces in order to create sound fields.

If you could create the appropriate early reflections and subsequent reverberations in your listening room, you would be able to create your own listening environment. The acoustics in your room could be changed to those of a concert hall, a dance floor, or virtually any size room at all. This ability to create sound fields at will is exactly what YAMAHA has done with the digital sound field processor.

Changing parameter settings

You can enjoy good quality sound with the factory-set parameters. Although you do not have to change the initial settings, you can change some of the parameters to better suit the input source or your listening room.

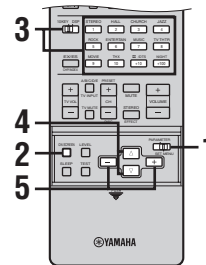

- 1 Set **PARAMETER/SET MENU** to **PARAMETER**.



- 2 Turn on the video monitor and press **ON SCREEN** repeatedly to select the full display mode.



- 3 Select the sound field program you want to adjust.

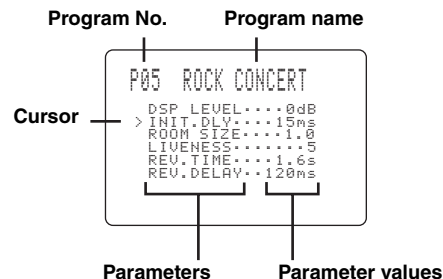

- 4 Press Δ/∇ to select the parameters.



EDITING SOUND FIELD PARAMETERS**5 Press $-/+$ to change the parameter value.**

When you set a parameter to a value other than the factory value, an asterisk mark (*) appears by the parameter name on the video monitor.

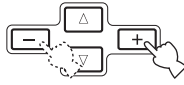
**6 Repeat steps 3 to 5 above as necessary to change other program parameters.****Notes**

- The available parameters may be displayed on more than one OSD page for some of the programs. To scroll through pages, press Δ/∇ .
- You cannot change parameter values when MEMORY GUARD is set to "ON". If you want to change the parameter values, set MEMORY GUARD to "OFF" (see page 56).

Memory back-up

The memory back-up circuit prevents the stored data from being lost even if this unit is set in the standby mode, the power cord is disconnected from the AC outlet, or the power supply is temporarily cut due to power failure. However, if the power is cut for more than one week, the parameter values will return to the factory settings. If this happens, edit the parameter value again.

■ Resetting parameters to the factory values**To reset a certain parameter**

Select the parameter you want to reset, then press $-/+$ repeatedly until the asterisk mark (*) next to the parameter name disappears from the video monitor.

To reset all parameters

Use PARAM.INI (see page 57).

SOUND FIELD PARAMETER DESCRIPTIONS

You can adjust the values of certain digital sound field parameters so the sound fields are recreated accurately in your listening room. Not all of the following parameters are found in every program.

■ DSP LEVEL

Function: This parameter adjusts the level of all the DSP effect sounds within a narrow range.

Description: Depending on the acoustics of your listening room, you may want to increase or decrease the DSP effect level relative to the level of the direct sound.

Control range: -6 dB - +3 dB

■ INIT. DLY/P. INT. DLY (Initial delay)

Function: This parameter changes the apparent distance from the source sound by adjusting the delay between the direct sound and the first reflection heard by the listener.

Description: The smaller the value, the closer the sound source seems to the listener. The larger the value, the farther it seems. For a small room, set to a small value. For a large room, set to a large value.

Control range: 1 - 99 msec

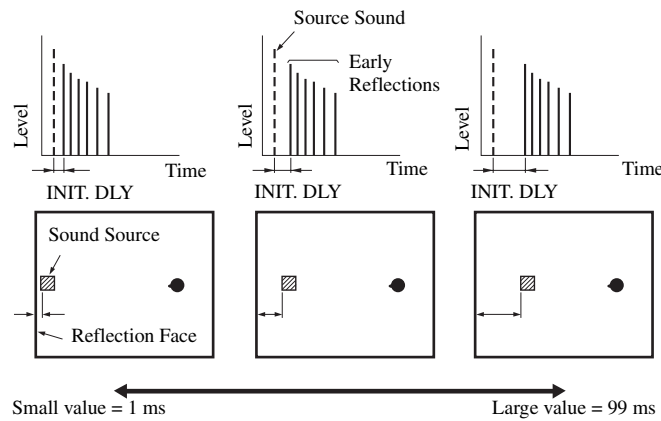

■ ROOM SIZE/P. ROOM SIZE (Room size)

Function: This parameter adjusts the apparent size of the surround sound field. The larger the value, the larger the surround sound field becomes.

Description: As the sound is repeatedly reflected around a room, the larger the hall is, the longer the time between the original reflected sound and the subsequent reflections. By controlling the time between the reflected sounds, you can change the apparent size of the virtual venue. Changing this parameter from one to two, doubles the apparent length of the room.

Control range: 0.1 - 2.0

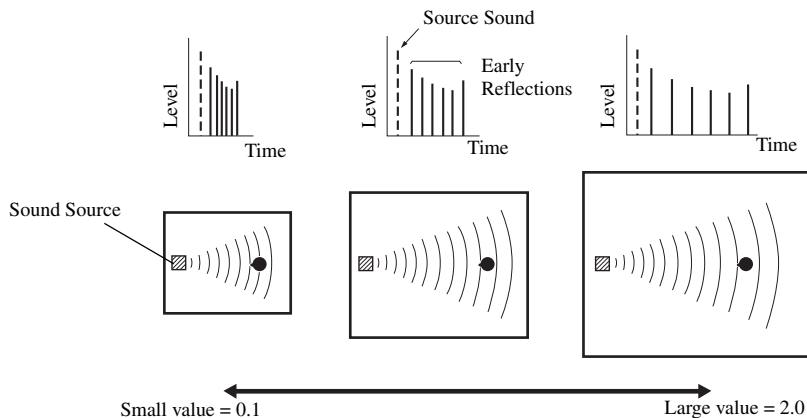

SOUND FIELD PARAMETER DESCRIPTIONS

■ LIVENESS

Function: This parameter adjusts the reflectivity of the virtual walls in the hall by changing the rate at which the early reflections decay.

Description: The early reflections of a sound source decay much faster in a room with acoustically absorbent wall surfaces than in one which has highly reflective surfaces. A room with acoustically absorbent surfaces is referred to as “dead”, while a room with highly reflective surfaces is referred to as “live”. The LIVENESS parameter lets you adjust the early reflection decay rate, and thus the “liveness” of the room.

Control range: -6 dB – +3 dB

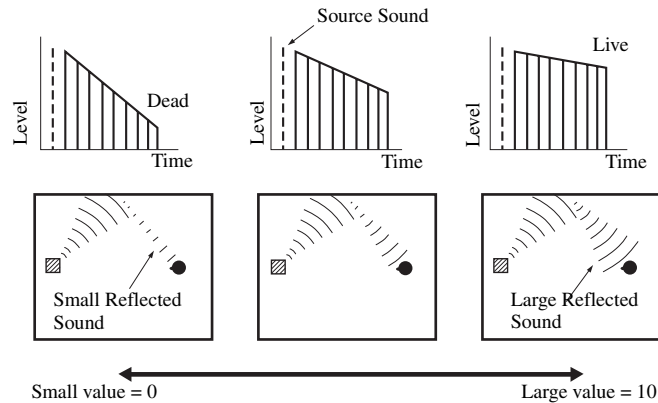

■ S. INIT. DLY (Surround initial delay)

Function: This parameter adjusts the delay between the direct sound and the first reflection on the surround side of the sound field. You can only adjust this parameter when at least two front channels and two surround channels are used.

Control Range: 1 – 49 msec

■ S. ROOM SIZE (Surround room size)

Function: This parameter adjusts the apparent size of the surround sound field.

Control Range: 0.1 – 2.0

■ S. LIVENESS (Surround liveness)

Function: This parameter adjusts the apparent reflectivity of the virtual walls in the surround sound field.

Control Range: 0 – 10

■ SB INIT. DLY (Surround back initial delay)

Function: This parameter adjusts the delay between the direct sound and the first reflection in the surround back sound field.

Control Range: 1 – 49 msec

■ SB ROOM SIZE (Surround back room size)

Function: This parameter adjusts the apparent size of the surround back sound field.

Control Range: 0.1 – 2.0

■ SB LIVENESS (Surround back liveness)

Function: This parameter adjusts the apparent reflectivity of the virtual wall in the surround back sound field.

Control Range: 0 – 10

■ REV.TIME (Reverberation time)

Function: This parameter adjusts the amount of time it takes for the dense, subsequent reverberation sound to decay by 60 dB (at 1 kHz). This changes the apparent size of the acoustic environment over an extremely wide range.

Description: Set a longer reverberation time for “dead” sources and listening room environments, and a shorter time for “live” sources and listening room environments.

Control Range: 1.0 – 5.0 sec

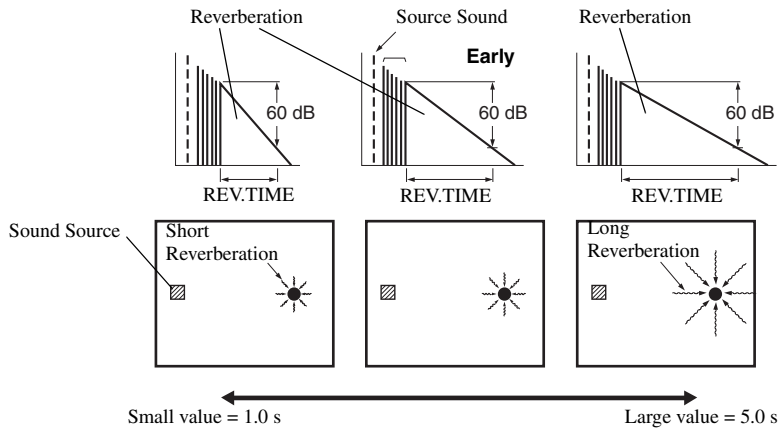

■ REV.DELAY (Reverberation delay)

Function: This parameter adjusts the time difference between the beginning of the direct sound and the beginning of the reverberation sound.

Description: The larger the value, the later the reverberation sound begins. A later reverberation sound makes you feel like you are in a larger acoustic environment.

Control Range: 0 – 250 sec

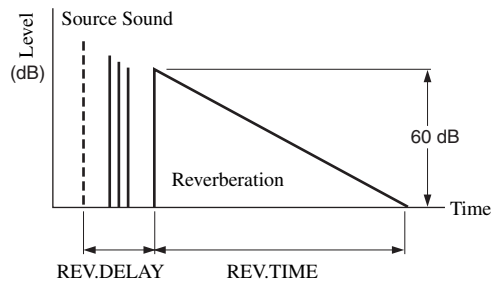

■ REV. LEVEL (Reverberation level)

Function: This parameter adjusts the volume of the reverberation sound.

Description: The larger the value, the stronger the reverberation becomes.

Control Range: 0 – 100 %

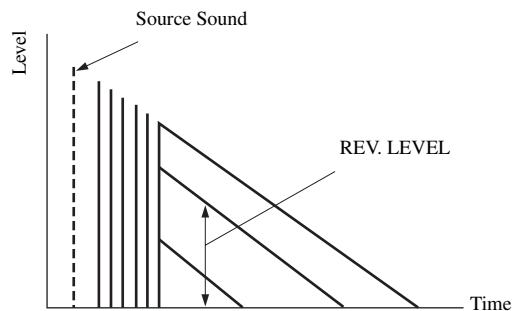

SOUND FIELD PARAMETER DESCRIPTIONS**■ DIALG.LIFT (Dialog lift)**

Function: This parameter adjusts the height of the front and center channel sounds by assigning some of the front and center channel elements to the presence speakers.

Description: The larger the parameter, the higher the position of the front and center channel sounds.

Choices: 0/1/2/3/4/5, initial setting is 3.

For 7ch Stereo

Function: These parameter adjusts the volume level for each channel in 7-channel stereo mode.

Control Range: 0 – 100 %

■ CT LEVEL (Center level)**■ SL LEVEL (Surround left level)****■ SR LEVEL (Surround right level)****■ SB LEVEL (Surround back level)****■ PR LEVEL (Presence level)****For PRO LOGIC II Music****■ PANORAMA**

Function: Extends the front stereo image to include the surround speakers for wraparound effect.

Choices: OFF/ON, initial setting is OFF.

■ DIMENSION

Function: Gradually adjusts the sound field either towards the front or towards the rear.

Control range: -3 (towards the rear) to +3 (towards the front), initial setting is STD (standard).

■ CT WIDTH (Center width)

Function: Adjusts the center image from all three front speakers to varying degrees. A larger value adjusts the center image towards the front left and right speakers.

Control range: 0 (center channel sound is output only from center speaker) to 7 (center channel sound is output only from front left and right speakers), initial setting is 3.

For DTS Neo:6 Music**■ C. IMAGE (Center image)**

Function: This parameter adjusts the center image from all three front speakers to varying degrees.

Control range: 0 – 0.5

For THX Cinema**■ DEC (2ch Decoder Select)**

Function: Selects the decoder used to playback 2-channel sources using THX Cinema.

Choices: PRO LOGIC / PLII Movie / Neo:6 Cinema

TROUBLESHOOTING

Refer to the chart below when this unit does not function properly. If the problem you are experiencing is not listed below or if the instruction below does not help, set this unit to the standby mode, disconnect the power cord, and contact the nearest authorized YAMAHA dealer or service center.

■ General

| Problem | Cause | Remedy | Refer to page |
|---|---|--|---------------|
| This unit fails to turn on when STANDBY/ ON (or SYSTEM POWER) is pressed, or enters in the standby mode soon after the power has been turned on. | The power cord is not connected or the plug is not completely inserted. | Connect the power cord firmly. | — |
| | The impedance setting is incorrect. | Set the impedance to match your speakers. | 23 |
| | The protection circuitry has been activated. | Make sure all speaker wire connections on this unit and on all speakers are secure and that the wire for each connection does not touch anything other than its respective connection. | 12—14 |
| | This unit has been exposed to a strong external electric shock (such as lightning and strong static electricity). | Set this unit in the standby mode, disconnect the power cord, plug it back in after 30 seconds, then use it normally. | — |
| On screen display does not appear. | The setting for the on-screen display is set to "DISPLAY OFF". | Select the full or short display mode. | 44 |
| | GRAY BACK in the SET MENU is set to OFF, and no video signal is currently being received. | Set GRAY BACK to AUTO to always show the OSD. | 56 |
| No sound | Incorrect input or output cable connections. | Connect the cables properly. If the problem persists, the cables may be defective. | 16—19 |
| | INPUT MODE is set to DTS or ANALOG. | Select AUTO. | 34 |
| | No appropriate input source has been selected. | Select an appropriate input source with INPUT, MULTI CH INPUT or the input selector buttons. | 30 |
| | Speaker connections are not secure. | Secure the connections. | 12 |
| | The front speakers to be used have not been selected properly. | Select the front speakers with SPEAKERS A and/or B. | 30 |
| | The volume is turned down. | Turn up the volume. | — |
| | The sound is muted. | Press MUTE or any operation buttons of this unit to cancel a mute and adjust the volume. | 31 |
| | If you are playing an LD source, the player may not output digital signals if the LD source was not digitally recorded. | Set the INPUT MODE to ANALOG. | 34 |
| | The INPUT MODE is set to ANALOG while playing a source encoded with a DTS signal. | Set the INPUT MODE to AUTO or DTS. | 34 |
| | The signals this unit cannot reproduce are being received from a source component e.g.: a CD-ROM. | Play a source whose signals this unit can reproduce. | — |
| No picture | The output and input for the picture are connected to different types of video jacks. | Turn on the video conversion function. | 56 |

TROUBLESHOOTING

| Problem | Cause | Remedy | Refer to page |
|---|--|---|----------------------|
| The sound suddenly goes off. | The protection circuit has been activated because of a short circuit, etc. | Check that the impedance selector setting is correct. | 23 |
| | | Check the speaker wires are not touching each other and then turn this unit back on. | — |
| | The sleep timer has turned the unit off. | Turn on the power, and play the source again. | — |
| | The sound is muted. | Press MUTE to cancel a mute. | 31 |
| Only the speaker on one side can be heard. | Incorrect cable connections. | Connect the cables properly. If the problem persists, the cables may be defective. | 12 |
| | Incorrect balance settings in the SET MENU. | Adjust the SP LEVEL settings. | 50 |
| Only the center speaker outputs substantial sound. | When playing a monaural source with a CINEMA DSP program, the source signal is directed to the center channel, and the front and surround speakers output effect sounds. | | |
| No sound from the effect speakers. | The sound field programs are turned off. | Press STRAIGHT/EFFECT to turn them on. | 33 |
| | A Dolby Surround, Dolby Digital or DTS decoding DSP program is being used with material not encoded with Dolby Surround, Dolby Digital or DTS. | Select another sound field program. | 32 |
| No sound from the center speaker. | The output level of the center speaker is set to minimum. | Raise the level of the center speaker. | 50 |
| | “CENTER SP” in the SET MENU is set to NONE. | Select the appropriate mode for your center speaker. | 49 |
| | One of the Hi-Fi DSP programs (except for 7ch Stereo) has been selected. | Select another sound field program. | 32 |
| No sound from the surround speakers. | The output level of the surround speakers is set to minimum. | Raise the output level of the surround speakers. | 50 |
| | “SURR. LR SP” in the SET MENU is set to NONE. | Select the appropriate speaker mode for the surround L/R speakers. | 49 |
| | A monaural source is being played with STRAIGHT/EFFECT set to STRAIGHT. | Press STRAIGHT/EFFECT to turn on the sound fields. Then select another sound field program. | — |
| No sound from the surround back speakers. | Presence speakers are selected. | Select surround back speakers in PR/SBch SELECT. | 53 |
| | “SURR. LR SP” in the SET MENU is set to NONE. | If the speaker mode for the surround L/R speakers is set to NONE, the speaker mode for the surround back speaker is automatically set to NONE. Select the appropriate speaker mode for the surround L/R speaker mode. | 49 |
| | “SURR B L/R SP” in the SET MENU is set to NONE. | Select LRG or SML. | 49 |
| No sound from the subwoofer. | “LFE/BASS OUT” in the SET MENU is set to FRONT when a Dolby Digital or DTS signal is being played. | Select SWFR or BOTH. | 50 |
| | “LFE/BASS OUT” in the SET MENU is set to SWFR or FRONT when a 2-channel source is being played. | Select BOTH. | 50 |
| | The source does not contain low bass signals. | | |

TROUBLESHOOTING

| Problem | Cause | Remedy | Refer to page |
|--|---|--|---------------|
| Dolby Digital or DTS sources cannot be played. (Dolby Digital or DTS indicator on the front panel display does not light up.) | The connected component is not set to output Dolby Digital or DTS digital signals. | Make an appropriate setting following the operations instructions for your component. | — |
| | INPUT MODE is set to ANALOG. | Set INPUT MODE to AUTO or DSP. | 34 |
| A “humming” sound can be heard. | Incorrect cable connections. | Firmly connect the audio plugs. If the problem persists, the cables may be defective. | — |
| | No connection from the turntable to the GND terminal. | Connect the grounding cord of your turntable to the GND terminal of this unit. | 19 |
| The volume level is low while playing a record. | The record is being played on a turntable with an MC cartridge. | The turntable should be connected to this unit through an MC-head amplifier. | 19 |
| The volume level cannot be increased, or the sound is distorted. | The component connected to the OUT (REC) jacks of this unit is turned off. | Turn on the power to the component. | — |
| The sound effect cannot be recorded. | It is not possible to record the sound effect with a recording component. | | |
| A source cannot be recorded by a digital recording component connected to this DIGITAL OUTPUT jack. | The source component is not connected to this unit’s DIGITAL INPUT jacks. | Connect the source component to the DIGITAL INPUT jacks. | 16—19 |
| | Some components cannot record the Dolby Digital or DTS sources. | | |
| A source cannot be recorded by an analog component connected to the AUDIO OUT jacks. | The source component is not connected to this unit’s analog AUDIO OUT jacks. | Connect the source component to the analog AUDIO IN jacks. | 16—19 |
| The sound field parameters and some other settings on this unit cannot be changed. | “MEMORY GUARD” in the SET MENU is set to ON. | Select OFF. | 56 |
| This unit does not operate properly. | The internal microcomputer has been frozen by an external electric shock (such as lightning or excessive static electricity) or by a power supply with low voltage. | Disconnect the AC power cord from the outlet and then plug it in again after about 30 seconds. | — |
| “CHECK SP WIRES” appears on the front panel display. | Speaker cables are short circuited. | Make sure all speaker cables are connected correctly. | 12 |

TROUBLESHOOTING

| Problem | Cause | Remedy | Refer to page |
|--|---|--|---------------|
| There is noise interference from digital or high-frequency equipment, or this unit. | This unit is too close to the digital or high-frequency equipment. | Move this unit further away from such equipment. | — |
| The picture is disturbed. | The video source uses scrambled or encoded signals to prevent dubbing. | Playing back video software that has an anti-copy signal or video signals with a lot of noise may produce unstable images. | — |
| There is noise when the OSD is displayed. | The OSD may be disturbed when displaying OSD through component video connections. | Select OFF in CMPNT OSD. | 56 |
| This unit suddenly turns into the standby mode. | The internal temperature becomes too high and the overheat protection circuitry has been activated. | Wait until this unit cools down and then turn it back on. | — |

■ Tuner

| Problem | | Cause | Remedy | Refer to page |
|--|---|---|--|---------------|
| FM | FM stereo reception is noisy. | The characteristics of FM stereo broadcasts may cause this problem when the transmitter is too far away or the antenna input is poor. | Check the antenna connections. Try using a high-quality directional FM antenna. | 21 |
| | | | Use the manual tuning method. | 36 |
| | There is distortion, and clear reception cannot be obtained even with a good FM antenna. | There is multipath interference. | Adjust the antenna position to eliminate multipath interference. | — |
| | The desired station cannot be tuned in with the automatic tuning method. | The station is too weak. | Use a high-quality directional FM antenna. | 21 |
| | | | Use the manual tuning method. | 36 |
| Previously preset stations can no longer be tuned in. | This unit has been disconnected for a long period. | Preset the stations again. | 37 | |
| AM | The desired station cannot be tuned in with the automatic tuning method. | The signal is weak or the antenna connections are loose. | Tighten the AM loop antenna connections and orient it for best reception. | — |
| | | | Use the manual tuning method. | — |
| | There are continuous crackling and hissing noises. | Noises result from lightning, fluorescent lamps, motors, thermostats and other electrical equipment. | Use an outdoor antenna and a ground wire. This will help somewhat, but it is difficult to eliminate all noise. | — |
| There are buzzing and whining noises (especially in the evening). | A TV set is being used nearby. | Move this unit away from the TV. | — | |

■ Remote control

| Problem | Cause | Remedy | Refer to page |
|--|---|---|---------------|
| The remote control does not work nor function properly. | Wrong distance or angle. | The remote control will function within a maximum range of 6 m (20 feet) and no more than 30 degrees off-axis from the front panel. | 7 |
| | Direct sunlight or lighting (from an inverter type of fluorescent lamp, etc.) is striking the remote control sensor of this unit. | Reposition this unit. | — |
| | The batteries are weak. | Replace all batteries. | 3 |
| | The manufacture code has not correctly set. | Set the manufacturer code correctly. | 60 |
| | | Try to set the other codes of the same manufacturer. | 60 |
| Even if the manufacturer code is correctly set, there are some models that do not respond to the remote control. | Program the necessary functions independently into the programmable buttons using the Learn feature. | 61 | |
| The remote control does not "learn" new functions. | The batteries of this remote control and/or the other remote control are too weak. | Replace the batteries. | 3 |
| | The distance between the two remote controls is too much or too little. | Place the remote controls at the proper distance. | 61 |
| | The signal coding or modulation of the other remote control is not compatible with this remote control. | Learning is not possible. | — |
| | Memory capacity is full. | Delete other unnecessary functions to make room for the new functions. | 65, 66 |

GLOSSARY

■ **Dolby Surround**

Dolby Surround uses a 4 channel analog recording system to reproduce realistic and dynamic sound effects: 2 front left and right channels (stereo), a center channel for dialog (monaural), and a surround channel for special sound effects (monaural). The surround channel reproduces sound within a narrow frequency range.

Dolby Surround is widely used with nearly all video tapes and laser discs, and in many TV and cable broadcasts as well. The Dolby Pro Logic decoder built into this unit employs a digital signal processing system that automatically stabilizes the volume on each channel to enhance moving sound effects and directionality.

■ **Dolby Digital**

Dolby Digital is a digital surround sound system that gives you completely independent multi-channel audio. With 3 front channels (left, center, and right), and 2 surround stereo channels, Dolby Digital provides 5 full-range audio channels. With an additional channel especially for bass effects, called LFE (low frequency effect), the system has a total of 5.1 channels (LFE is counted as 0.1 channel). By using 2-channel stereo for the surround speakers, more accurate moving sound effects and surround sound environment are possible than with Dolby Surround. The wide dynamic range (from maximum to minimum volume) reproduced by the 5 full-range channels and the precise sound orientation generated using digital sound processing provide listeners with previously unheard of excitement and realism.

With this unit, any sound environment from monaural up to a 5.1-channel configuration can be freely selected for your enjoyment.

Dolby Digital EX creates 6 full-bandwidth output channels from 5.1-channel sources. This is done using a matrix decoder that derives 3 surround channels from the 2 in the original recording. For the best results, Dolby Digital EX should be used with movie sound tracks recorded with Dolby Digital Surround EX. With this additional channel, you can experience more dynamic and realistic moving sound especially with scenes with "flyover" and "fly-around" effects.

■ **Dolby Pro Logic II**

Dolby Pro Logic II is an improved technique used to decode vast numbers of existing Dolby Surround software. This new technology enables a discrete 5-channel playback with 2 front left and right channels, 1 center channel, and 2 surround left and right channels (instead of only 1 surround channel for conventional Pro Logic technology). A music mode is also available for 2-channel sources in addition to the movie mode.

■ **DTS (Digital Theater Systems) Digital Surround**

DTS digital surround was developed to replace the analog soundtracks of movies with a 6-channel digital sound track, and is now rapidly gaining popularity in movie theaters around the world. Digital Theater Systems Inc. has developed a home theater system so that you can enjoy the depth of sound and natural spatial representation of DTS digital surround in your home. This system produces practically distortion-free 6-channel sound (technically, a left, right and center channels, 2 surround channels, plus an LFE 0.1 channel as a subwoofer, for a total of 5.1 channels).

The unit incorporates DTS-ES decoder that enables 6.1-channel reproduction by adding the surround back channel to existing 5.1-channel format.

■ **Neo:6**

Neo:6 decodes the conventional 2-channel sources for 6 channel playback by the specific decoder. It enables playback with the full-range channels with higher separation just like digital discrete signal playback. Two modes are available; "Music mode" for playing music sources and "Cinema mode" for movies.

■ **LFE 0.1 channel**

This channel is for the reproduction of low bass signals. The frequency range for this channel is 20 Hz to 120 Hz. This channel is counted as 0.1 because it only enforces a low frequency range compared to the full-range reproduced by the other 5/6 channels in a Dolby Digital or DTS 5.1/6.1 channel systems.

■ **CINEMA DSP**

Since the Dolby Surround and DTS systems were originally designed for use in movie theaters, their effect is best felt in a theater having many speakers and designed for acoustic effects. Since home conditions, such as room size, wall material, number of speakers, and so on, can differ so widely, it's inevitable that there are differences in the sound heard as well. Based on a wealth of actually measured data, YAMAHA CINEMA DSP uses YAMAHA original sound field technology to combine Dolby Pro Logic, Dolby Digital and DTS systems to provide the visual and audio experience of movie theater in the listening room of your own home.

■ **SILENT CINEMA**

YAMAHA has developed a natural, realistic sound effect DSP algorithm for headphones.

Parameters for headphones have been set for each sound field so that accurate representations of all the sound field programs can be enjoyed on headphones.

■ Virtual CINEMA DSP

YAMAHA has developed a Virtual CINEMA DSP algorithm that allows you to enjoy DSP sound field surround effects even without any surround speakers by using virtual surround speakers.

It is even possible to enjoy Virtual CINEMA DSP using a minimal two-speaker system that does not include a center speaker.

■ Composite Video signal

With the composite video signal system, the video signal is composed of three basic elements of a video picture; color, brightness and synchronization data. A composite video jack on a video component transmits these three elements combined.

■ S VIDEO signal

With the S VIDEO signal system, the video signal normally transmitted using a pin cable is separated and transmitted as the Y signal for the luminance and the C signal for the chrominance through the S VIDEO cable. Using the S VIDEO jack eliminates video signal transmission loss and allows recording and playback of even more beautiful images.

■ Component video signal

With the component video signal system, the video signal is separated into the Y signal for the luminance and the P_b and P_r signals for the chrominance. Color can be reproduced more faithfully with this system because each of these signals is independent. The component signal is also called the “color difference signal” because the luminance signal is subtracted from the color signal. A monitor with component input jacks is required in order to use the component signal for output.

■ PCM (Linear PCM)

Linear PCM is a signal format under which an analog audio signal is digitized, recorded and transmitted without using any compression. This is used as a method of recording CDs and DVD audio. The PCM system uses a technique for sampling the size of the analog signal per very small unit of time. Standing for “pulse code modulation”, the analog signal is encoded as pulses and then modulated for recording.

■ Sampling frequency and number of quantized bits

When digitizing an analog audio signal, the number of times the signal is sampled per second is called the sampling frequency, while the degree of fineness when converting the sound level into a numeric value is called the number of quantized bits.

The range of rates that can be played back is determined based on the sampling rate, while the dynamic range representing the sound level difference is determined by the number of quantized bits. In principle, the higher the sampling frequency, the wider the range of frequencies that can be played back, and the higher the number of quantized bits, the more finely the sound level can be reproduced.

■ THX Cinema processing

THX is an exclusive set of standards and technologies established by the world-renowned film production company, Lucasfilm Ltd. THX grew from George Lucas' personal desire to make your experience of the film soundtrack, in both movie theatres and in your home theatre, as faithful as possible to what the director intended.

Movie soundtracks are mixed in special movie theatres called dubbing stages and are designed to be played back in movie theatres with similar equipment and conditions. This same soundtrack is then transferred directly onto Laserdisc, VHS tape, DVD, etc., and is not changed for playback in a small home theatre environment.

THX engineers developed patented technologies to accurately translate the sound from the movie theatre environment into the home, correcting the tonal and spatial errors that occur. On this product, when the THX indicator is on, THX features are automatically added in Cinema modes (e.g. THX Cinema, THX Surround EX).

■ Re-Equalization

The tonal balance of a film soundtrack will be excessively bright and harsh when played back over audio equipment in the home because film soundtracks were designed to be played back in large movie theatres using very different professional equipment. Re-Equalization restores the correct tonal balance for watching a movie soundtrack in a small home environment.

■ Timbre Matching

The human ear changes our perception of a sound depending on the direction from which the sound is coming. In a movie theatre, there is an array of surround speakers so that the surround information is all around you. In a home theatre, you use only two speakers located to the side of your head. The Timbre Matching feature filters the information going to the surround speakers so that they more closely match the tonal characteristics of the sound coming from the front speakers. This ensures seamless panning between the front and surround speakers.

GLOSSARY**■ Adaptive Decorrelation**

In a movie theatre, a large number of surround speakers help create an enveloping surround sound experience, but in a home theatre there are usually only two speakers. This can make the surround speakers sound like headphones that lack spaciousness and envelopment. The surround sounds will also collapse into the closest speaker as you move away from the middle seating position. Adaptive Decorrelation slightly changes one surround channel's time and phase relationship with respect to the other surround channel. This expands the listening position and creates--with only two speakers--the same spacious surround experience as in a movie theatre.

■ THX Select

Before any home theatre component can be THX Select certified, it must incorporate all the features above and also pass a rigorous series of quality and performance tests. Only then can a product feature the THX Select logo, which is your guarantee that the Home Theatre products you purchase will give you superb performance for many years to come. THX Select requirements cover every aspect of the product including power amplifier and pre-amplifier performance and operation, and hundreds of other parameters in both the digital and analog domain.

■ THX Surround EX

THX Surround EX - Dolby Digital Surround EX is a joint development of Dolby Laboratories and the THX Ltd. In a movie theater, film soundtracks that have been encoded with Dolby Digital Surround EX technology are able to reproduce an extra channel which has been added during the mixing of the program. This channel, called Surround Back, places sounds behind the listener in addition to the currently available front left, front center, front right, surround right, surround left and subwoofer channels. This additional channel provides the opportunity for more detailed imaging behind the listener and brings more depth, spacious ambience and sound localization than ever before.

Movies that were created using the Dolby Digital Surround EX technology, when released into the home consumer market may exhibit wording to that effect on the packaging. A list of movies created using this technology can be found on the Dolby web site at www.dolby.com. A list of available DVD software titles encoded with this technology can be found at www.thx.com.

Only receiver and controller products bearing the THX Surround EX logo, when in the THX Surround EX mode, faithfully reproduce this new technology in the home. This product may also engage the THX Surround EX mode during the playback of 5.1 channel material that is not Dolby Digital Surround EX encoded. In such case the information delivered to the Surround Back channel will be program dependent and may or may not be very pleasing depending on the particular soundtrack and the tastes of the individual listener.

■ ITU-R

ITU-R is the radio communication sector of the ITU (International Telecommunication Union). ITU-R recommends a standard speaker placement which is used in many critical listening rooms, especially for mastering purposes.

SPECIFICATIONS

AUDIO SECTION

- Minimum RMS Output Power for Front, Center, Surround, Surround back
20 Hz to 20 kHz, 0.04% THD, 8 Ω 120 W
- Maximum Power (EIAJ)
[China, Asia, Korea and General models]
1 kHz, 10% THD, 8 Ω 175 W
- Dynamic Power (IHF)
[U.S.A., Canada, China, Australia, Asia, Korea and General models]
8/6/4/2 Ω 155/195/250/330 W
- DIN Standard Output Power [U.K. and Europe models]
1 kHz, 0.7% THD, 4 Ω 180 W
- IEC Output Power [U.K. and Europe models]
1 kHz, 0.04% THD, 8 Ω 135 W
- Damping Factor (IHF)
20 Hz to 20 kHz, 8 Ω 140 or more
- Frequency Response
CD terminal to Front L/R 10 Hz to 100 kHz, -3 dB
- Total Harmonic Distortion
PHONO to REC OUT (20 Hz to 20 kHz, 1 V) 0.02%
CD, etc. to Front L/R (20 Hz to 20 kHz, 60 W, 8 Ω) 0.04%
- Signal to Noise Ratio (IHF-A Network)
Phono (5 mV) to Front L/R
[U.K., Europe and Australia models] 81 dB
[Other models] 86 dB
CD (250 mV) to Front L/R, Effect Off 100 dB
- Residual Noise (IHF-A Network)
Front L/R 150 μ V or less
- Channel Separation (1 kHz/10 kHz)
PHONO (terminated) to Front L/R 60 dB/55 dB
CD (5.1 k Ω terminated) to Front L/R 60 dB/45 dB
- Tone Control (Front L/R)
BASS Boost/Cut \pm 6 dB/50 Hz
BASS Turnover Frequency 350 Hz
TREBLE Boost/Cut \pm 6 dB/20 kHz
TREBLE Turnover Frequency 3.5 kHz
- Phones Output 150 mV/100 Ω
- Input Sensitivity/Input Impedance
PHONO 3.5 mV/47 k Ω
CD, etc 200 mV/47 k Ω
MULTI CH INPUT 200 mV/47 k Ω
- Output Level/Output Impedance
REC OUT 200 mV/1.2 k Ω
PRE OUT 1.0 V/500 Ω
SUBWOOFER 2.0 V/500 Ω
ZONE 2 / ZONE 3 OUTPUT
[U.S.A., Canada and Australia models] 1.0 V/1.2 k Ω

VIDEO SECTION

- Video Signal Type
[U.S.A., Canada and Korea models] NTSC
[Other models] PAL/NTSC
- Signal to Noise Ratio 50 dB
- Frequency Response (MONITOR OUT)
Composite, S-Video 5 Hz to 10 MHz, -3 dB
Component 5 Hz to 60 MHz, -3 dB

FM SECTION

- Tuning Range
[U.S.A. and Canada models] 87.5 to 107.9 MHz
[Asia and General model] 87.5/87.50 to 108.0/108.00 MHz
[Other models] 87.50 to 108.00 MHz
- Usable Sensitivity (IHF) 1.0 μ V (11.2 dBf)
- Signal to Noise Ratio (IHF)
Mono/Stereo 76 dB/70 dB
- Harmonic Distortion (1 kHz)
Mono/Stereo 0.2%/0.3%
- Stereo Separation (1 kHz) 42 dB
- Frequency Response 20 Hz to 15 kHz +0.5, -2 dB

AM SECTION

- Tuning Range
[U.S.A. and Canada models] 530 to 1710 kHz
[Asia and General models] 530/531 to 1710/1611 kHz
[Other models] 531 to 1611 kHz
- Usable Sensitivity 300 μ V/m

GENERAL

- Power Supply
[U.S.A. and Canada models] AC 120 V/60 Hz
[Australia model] AC 240 V/50 Hz
[China model] AC 220 V/50 Hz
[Korea model] AC 220 V/60 Hz
[U.K. and Europe models] AC 230 V/50 Hz
[Asia and General models] AC 110/120/220/230-240 V, 50/60 Hz
- Power Consumption
[U.S.A. and Canada models] 500 W/630 VA
[Other models] 500 W
- Standby Power Consumption
[Asia and General models] (AC 240 V/50 Hz) 0.8 W or less
[Other models] 0.5 W or less
- AC Outlets
[U.S.A. and Canada models] 2 (Total 100 W/0.8 A maximum)
[U.K. and Australia models] 1 (Total 100 W maximum)
[China and Europe models] 2 (Total 100 W maximum)
[Asia and General models] 2 (Total 50 W maximum)
- Dimension (W x H x D) 435 x 171 x 433.5 mm
(17-1/8" x 6-3/4" x 17-1/16")
- Weight 15.5 kg (34.2 lbs)



YAMAHA ELECTRONICS CORPORATION, USA 6660 ORANGETHORPE AVE., BUENA PARK, CALIF. 90620, U.S.A.
YAMAHA CANADA MUSIC LTD. 135 MILNER AVE., SCARBOROUGH, ONTARIO M1S 3R1, CANADA
YAMAHA ELECTRONIK EUROPA G.m.b.H. SIEMENSSTR. 22-34, 25462 RELINGEN BEI HAMBURG, F.R. OF GERMANY
YAMAHA ELECTRONIQUE FRANCE S.A. RUE AMBROISE CROIZAT BP70 CROISSY-BEAUBOURG 77312 MARNE-LA-VALLEE CEDEX02, FRANCE
YAMAHA ELECTRONICS (UK) LTD. YAMAHA HOUSE, 200 RICKMANSWORTH ROAD WATFORD, HERTS WD18 7GQ, ENGLAND
YAMAHA SCANDINAVIA A.B. J A WETTERGRENS GATA 1, BOX 30053, 400 43 VÄSTRA FRÖLUNDA, SWEDEN
YAMAHA MUSIC AUSTRALIA PTY, LTD. 17-33 MARKET ST., SOUTH MELBOURNE, 3205 VIC., AUSTRALIA

YAMAHA CORPORATION
Printed in Malaysia © WB71920