



YAMAHA

UCA

MCR-E810

(RX-E810 + DVD-E810 + NX-E800)

RECEIVER/DVD PLAYER

AMPLI-TUNER/LECTEUR DE DVD

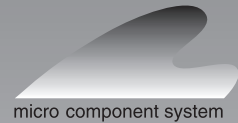

micro component system

PIANOCRAFT

OWNER'S MANUAL
MODE D'EMPLOI

IMPORTANT SAFETY INSTRUCTIONS

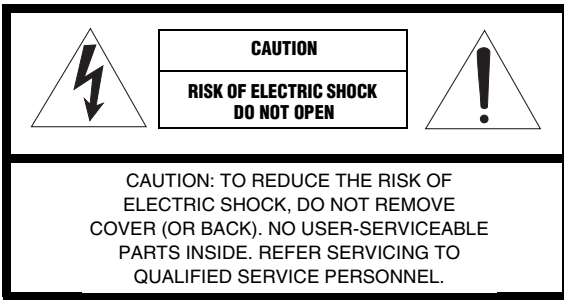

• Explanation of Graphical Symbols



The lightning flash with arrowhead symbol, within an equilateral triangle, is intended to alert you to the presence of uninsulated “dangerous voltage” within the product’s enclosure that may be of sufficient magnitude to constitute a risk of electric shock to persons.



The exclamation point within an equilateral triangle is intended to alert you to the presence of important operating and maintenance (servicing) instructions in the literature accompanying the appliance.

- 1 Read Instructions – All the safety and operating instructions should be read before the product is operated.
- 2 Retain Instructions – The safety and operating instructions should be retained for future reference.
- 3 Heed Warnings – All warnings on the product and in the operating instructions should be adhered to.
- 4 Follow Instructions – All operating and use instructions should be followed.
- 5 Cleaning – Unplug this product from the wall outlet before cleaning. Do not use liquid cleaners or aerosol cleaners.
- 6 Attachments – Do not use attachments not recommended by the product manufacturer as they may cause hazards.
- 7 Water and Moisture – Do not use this product near water – for example, near a bath tub, wash bowl, kitchen sink, or laundry tub; in a wet basement; or near a swimming pool; and the like.
- 8 Accessories – Do not place this product on an unstable cart, stand, tripod, bracket, or table. The product may fall, causing serious injury to a child or adult, and serious damage to the product. Use only with a cart, stand, tripod, bracket, or table recommended by the manufacturer, or sold with the product. Any mounting of the product should follow the manufacturer’s instructions, and should use a mounting accessory recommended by the manufacturer.
- 9 A product and cart combination should be moved with care. Quick stops, excessive force, and uneven surfaces may cause the product and cart combination to overturn.
- 10 Ventilation – Slots and openings in the cabinet are provided for ventilation and to ensure reliable operation of the product and to protect it from overheating, and these openings must not be blocked or covered. The openings should never be blocked by placing the product on a bed, sofa, rug, or other similar surface. This product should not be placed in a built-in installation such as a bookcase or rack unless proper ventilation is provided or the manufacturer’s instructions have been adhered to.
- 11 Power Sources – This product should be operated only from the type of power source indicated on the marking label. If you are not sure of the type of power supply to your home, consult your product dealer or local power company. For products intended to operate from battery power, or other sources, refer to the operating instructions.
- 12 Grounding or Polarization – This product may be equipped with a polarized alternating current line plug (a plug having one blade wider than the other). This plug will fit into the power outlet only one way. This is a safety feature. If you are unable to insert the plug fully into the outlet, try reversing the plug. If the plug should still fail to fit, contact your electrician to replace your obsolete outlet. Do not defeat the safety purpose of the polarized plug.
- 13 Power-Cord Protection – Power-supply cords should be routed so that they are not likely to be walked on or pinched by items placed upon or against them, paying particular attention to cords at plugs, convenience receptacles, and the point where they exit from the product.
- 14 Lightning – For added protection for this product during a lightning storm, or when it is left unattended and unused for long periods of time, unplug it from the wall outlet and disconnect the antenna or cable system. This will prevent damage to the product due to lightning and power-line surges.
- 15 Power Lines – An outside antenna system should not be located in the vicinity of overhead power lines or other electric light or power circuits, or where it can fall into such power lines or circuits. When installing an outside antenna system, extreme care should be taken to keep from touching such power lines or circuits as contact with them might be fatal.
- 16 Overloading – Do not overload wall outlets, extension cords, or integral convenience receptacles as this can result in a risk of fire or electric shock.
- 17 Object and Liquid Entry – Never push objects of any kind into this product through openings as they may touch dangerous voltage points or short-out parts that could result in a fire or electric shock. Never spill liquid of any kind on the product.
- 18 Servicing – Do not attempt to service this product yourself as opening or removing covers may expose you to dangerous voltage or other hazards. Refer all servicing to qualified service personnel.
- 19 Damage Requiring Service – Unplug this product from the wall outlet and refer servicing to qualified service personnel under the following conditions:
 - a) When the power-supply cord or plug is damaged,
 - b) If liquid has been spilled, or objects have fallen into the product,
 - c) If the product has been exposed to rain or water,



- d) If the product does not operate normally by following the operating instructions. Adjust only those controls that are covered by the operating instructions as an improper adjustment of other controls may result in damage and will often require extensive work by a qualified technician to restore the product to its normal operation,
 - e) If the product has been dropped or damaged in any way, and
 - f) When the product exhibits a distinct change in performance - this indicates a need for service.
- 20 Replacement Parts** – When replacement parts are required, be sure the service technician has used replacement parts specified by the manufacturer or have the same characteristics as the original part. Unauthorized substitutions may result in fire, electric shock, or other hazards.
- 21 Safety Check** – Upon completion of any service or repairs to this product, ask the service technician to perform safety checks to determine that the product is in proper operating condition.
- 22 Wall or Ceiling Mounting** – The unit should be mounted to a wall or ceiling only as recommended by the manufacturer.
- 23 Heat** – The product should be situated away from heat sources such as radiators, heat registers, stoves, or other products (including amplifiers) that produce heat.

- 24 Outdoor Antenna Grounding** – If an outside antenna or cable system is connected to the product, be sure the antenna or cable system is grounded so as to provide some protection against voltage surges and built-up static charges. Article 810 of the National Electrical Code, ANSI/NFPA 70, provides information with regard to proper grounding of the mast and supporting structure, grounding of the lead-in wire to an antenna discharge unit, size of grounding conductors, location of antenna discharge unit, connection to grounding electrodes, and requirements for the grounding electrode.

EXAMPLE OF ANTENNA GROUNDING

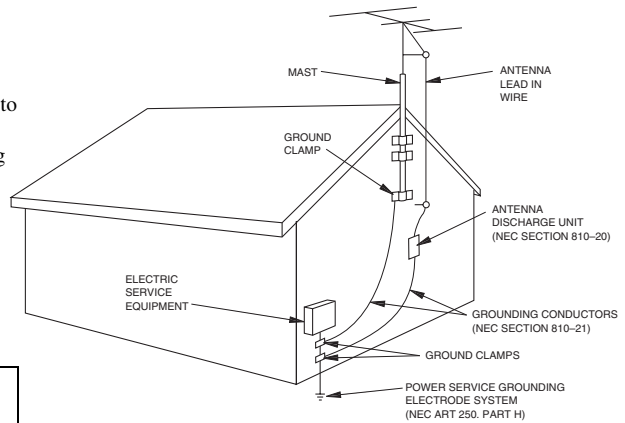

NEC – NATIONAL ELECTRICAL CODE

Note to CATV system installer:

This reminder is provided to call the CATV system installer’s attention to Article 820-40 of the NEC that provides guidelines for proper grounding and, in particular, specifies that the cable ground shall be connected to the grounding system of the building, as close to the point of cable entry as practical.

FCC INFORMATION (for US customers)

1 IMPORTANT NOTICE: DO NOT MODIFY THIS UNIT!

This product, when installed as indicated in the instructions contained in this manual, meets FCC requirements. Modifications not expressly approved by Yamaha may void your authority, granted by the FCC, to use the product.

- 2 IMPORTANT:** When connecting this product to accessories and/or another product use only high quality shielded cables. Cable/s supplied with this product **MUST** be used. Follow all installation instructions. Failure to follow instructions could void your FCC authorization to use this product in the USA.

- 3 NOTE:** This product has been tested and found to comply with the requirements listed in FCC Regulations, Part 15 for Class “B” digital devices. Compliance with these requirements provides a reasonable level of assurance that your use of this product in a residential environment will not result in harmful interference with other electronic devices.

This equipment generates/uses radio frequencies and, if not installed and used according to the instructions found in the users manual, may cause interference harmful to the operation of other electronic devices.

Compliance with FCC regulations does not guarantee that interference will not occur in all installations. If this product is found to be the source of interference, which can be determined by turning the unit “OFF” and “ON”, please try to eliminate the problem by using one of the following measures:

Relocate either this product or the device that is being affected by the interference.

Utilize power outlets that are on different branch (circuit breaker or fuse) circuits or install AC line filter/s.

In the case of radio or TV interference, relocate/reorient the antenna. If the antenna lead-in is 300 ohm ribbon lead, change the lead-in to coaxial type cable.

If these corrective measures do not produce satisfactory results, please contact the local retailer authorized to distribute this type of product. If you can not locate the appropriate retailer, please contact Yamaha Electronics Corp., U.S.A. 6660 Orangethorpe Ave, Buena Park, CA 90620.

The above statements apply **ONLY** to those products distributed by Yamaha Corporation of America or its subsidiaries.

CAUTION: READ THIS BEFORE OPERATING YOUR UNIT.

- 1 To assure the finest performance, please read this manual carefully. Keep it in a safe place for future reference.
- 2 Install this unit (RX-E810 and DVD-E810) in a well ventilated, cool, dry, clean place with at least 10 cm on the top (2.5 cm for DVD-E810), 10 cm on the left and right, and 10 cm at the back of this unit — away from direct sunlight, heat sources, vibration, dust, moisture, and/or cold.
- 3 Locate this unit away from other electrical appliances, motors, or transformers to avoid humming sounds.
- 4 Do not expose this unit to sudden temperature changes from cold to hot, and do not locate this unit in an environment with high humidity (i.e. a room with a humidifier) to prevent condensation inside this unit, which may cause an electrical shock, fire, damage to this unit, and/or personal injury.
- 5 Avoid installing this unit where foreign object may fall onto this unit and/or this unit may be exposed to liquid dripping or splashing. On the top of this unit, do not place:
 - Other components, as they may cause damage and/or discoloration on the surface of this unit.
 - Burning objects (i.e. candles), as they may cause fire, damage to this unit, and/or personal injury.
 - Containers with liquid in them, as they may fall and liquid may cause electrical shock to the user and/or damage to this unit.
- 6 Do not cover this unit with a newspaper, tablecloth, curtain, etc. in order not to obstruct heat radiation. If the temperature inside this unit rises, it may cause fire, damage to this unit, and/or personal injury.
- 7 Do not plug in this unit to a wall outlet until all connections are complete.
- 8 Do not operate this unit upside-down. It may overheat, possibly causing damage.
- 9 Do not use force on switches, knobs and/or cords.
- 10 When disconnecting the power cable from the wall outlet, grasp the plug; do not pull the cable.
- 11 Do not clean this unit with chemical solvents; this might damage the finish. Use a clean, dry cloth.
- 12 Only voltage specified on this unit must be used. Using this unit with a higher voltage than specified is dangerous and may cause fire, damage to this unit, and/or personal injury. YAMAHA will not be held responsible for any damage resulting from use of this unit with a voltage other than specified.
- 13 Do not attempt to modify or fix this unit. Contact qualified YAMAHA service personnel when any service is needed. The cabinet should never be opened for any reasons.
- 14 When not planning to use this unit for long periods of time (i.e. vacation), disconnect the AC power plug from the wall outlet.
- 15 Be sure to read the “Troubleshooting” section on common operating errors before concluding that this unit is faulty.
- 16 Before moving this unit, press STANDBY/ON to set this unit in standby mode, and disconnect the AC power plug from the wall outlet.
- 17 Condensation will form when the surrounding temperature changes suddenly. Disconnect the power cable from the outlet, then leave the unit alone.
- 18 When using the unit for a long time, the unit may become warm. Turn the power off, then leave the unit alone for cooling.
- 19 Install this unit near the wall outlet and where the AC power plug can be reached easily.

DANGER

When this unit is plugged to the wall outlet, do not place your eyes close to the opening of the disc tray and other openings to look into inside.

This unit is not disconnected from the AC power source as long as it is connected to the wall outlet, even if this unit itself is turned off. This state is called the standby mode. In this state, this unit is designed to consume a very small quantity of power.

The laser component in this product is capable of emitting radiation exceeding the limit for Class 1.

WARNING

TO REDUCE THE RISK OF FIRE OR ELECTRIC SHOCK, DO NOT EXPOSE THIS APPLIANCE TO RAIN OR MOISTURE.

FOR CANADIAN CUSTOMERS

To prevent electric shock, match wide blade of plug to wide slot and fully insert.
This Class B digital apparatus complies with Canadian ICES-003.

IMPORTANT

Please record the serial number of this unit in the space below.

MODEL:

Serial No.:

The serial number is located on the rear of the unit. Retain this Owner’s Manual in a safe place for future reference.

We Want You Listening For A Lifetime

YAMAHA and the Electronic Industries Association’s Consumer Electronics Group want you to get the most out of your equipment by playing it at a safe level. One that lets the sound come through loud and clear without annoying blaring or distortion – and, most importantly, without affecting your sensitive hearing. Since hearing damage from loud sounds is often undetectable until it is too late, YAMAHA and the Electronic Industries Association’s Consumer Electronics Group recommend you to avoid prolonged exposure from excessive volume levels.



Contents

INTRODUCTION

Features	2
Supplied Accessories	2
Controls and Functions	3
Receiver (RX-E810)	3
DVD player (DVD-E810).....	6
Remote control.....	8

PREPARATION

Connecting the System	12
Connecting a TV	14
Connecting Antennas	15
Connecting the AM loop antenna	15
Connecting the FM antenna.....	15
Connecting External Components	16
Connecting an MD player or a tape deck	16
Connecting an MD recorder or a CD recorder	16
Connecting a YAMAHA iPod universal dock	17
Connecting the Power Cables	18
Setting the System	19
Step 1: Turn on the power and select the DVD input	19
Step 2: Adjust the clock	19
Step 3: Set the aspect ratio.....	20
Step 4: Set the OSD language.....	20
Step 5: Set the the default audio, subtitle, and disc menu languages	21

BASIC OPERATIONS

Basic Receiver Operations	22
Changing the front panel display settings.....	23
Supported Disc Types	24
Basic Disc Playback Operations	25
Repeating disc playback (Repeat Play)	26
Playing back randomly (Shuffle Play).....	26
Specifying an elapsed time for playback (Time Search)	27
Specifying a preview picture for playback (Scan Search).....	28
Customizing playback order (Program Play)	29
Selecting audio and subtitle languages/ audio channel settings.	30
Zooming the picture.....	30
Selecting a viewing angle	31
Operating the disc menu	31
Playing back MP3/WMA/JPEG/DivX discs	32
Viewing or changing playback settings on the TV (OSD menu)	34
Restricting Disc Playback	35
Setting the parental control level	35
Locking a disc.....	36
Changing the password.....	36

TUNER OPERATIONS

FM/AM Tuning	37
Automatic tuning	37
Manual tuning	37
Automatic preset tuning.....	38
Manual preset tuning	39
Selecting preset stations.....	39
Radio Data System Tuning (U.K. and Europe Models Only)	40
Selecting the Radio Data System program	40
Displaying the Radio Data System information	41

OTHER OPERATIONS

Setting the Timer	43
Setting the clock timer	43
Setting the sleep timer	44
Setting the auto-standby mode	45
Controlling External Components	46
Available operations	46
Setting remote control codes	48
Using iPod	49
Configuring the DVD Player Settings (Setup Menu)	51
Setup menu items.....	52
Resetting the DVD player settings	56

ADDITIONAL INFORMATION

Language Codes	57
Troubleshooting	58
Receiver (RX-E810)	58
DVD player (DVD-E810).....	61
Remote control	62
Notes on Discs	63
Disc information	63
Handling a disc	64
Glossary	65
Audio information	65
Video information.....	66
Copyright and logo marks	66
Specifications	67

Features

Receiver (RX-E810)

- Maximum RMS output power per channel 65W + 65W (6 Ω, 1 kHz, 1%THD)
- 40-station FM/AM preset tuning
- iPod dock terminal
- Pure Direct mode

DVD player (DVD-E810)

- Plays DVDs, Video CDs, Audio CDs, MP3 CDs, WMA CDs, DivX CDs and JPEG CDs.
- Progressive-scan video output
- Optical and coaxial digital output jacks

■ About this manual

- In this manual, “RX-E810” is described as “receiver” and “DVD-E810” is described as “DVD player”.
- This manual describes how to operate the system using a remote control except when it is not available. Some of these operations are also available using the front panel buttons.
- Remote control descriptions and illustrations in this manual are based on the U.K. and Europe models unless otherwise specified.
- ✎ indicates a tip for your operation.
- Notes contain important information about safety and operating instructions.
- This manual is printed prior to production. Design and specifications are subject to change in part as a result of improvements, etc. In case of differences between the manual and the product, the product has priority.

Supplied Accessories

This product includes the following accessories. Before connecting this system, make sure you received all of the following parts.

Remote control

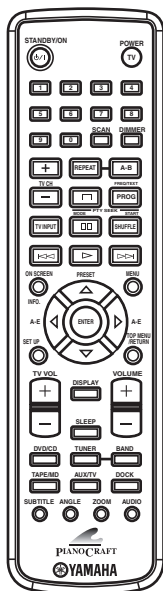

**Batteries (x2)
(AA, R06, UM-3)**

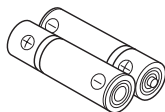

System control cable (0.6 m)

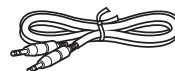

**Indoor FM antenna
(U.S.A., Canada, China, Taiwan,
and Asia models)**

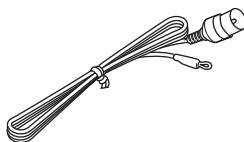

**Indoor FM antenna
(U.K., Europe, Australia,
and Korea models)**

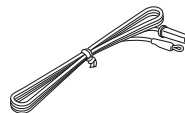

AM loop antenna

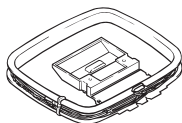

Video pin cable (1.5 m)

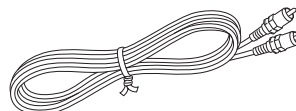

Audio pin cable (1.5 m)

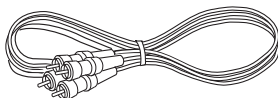

Controls and Functions

Receiver (RX-E810)

■ Front panel

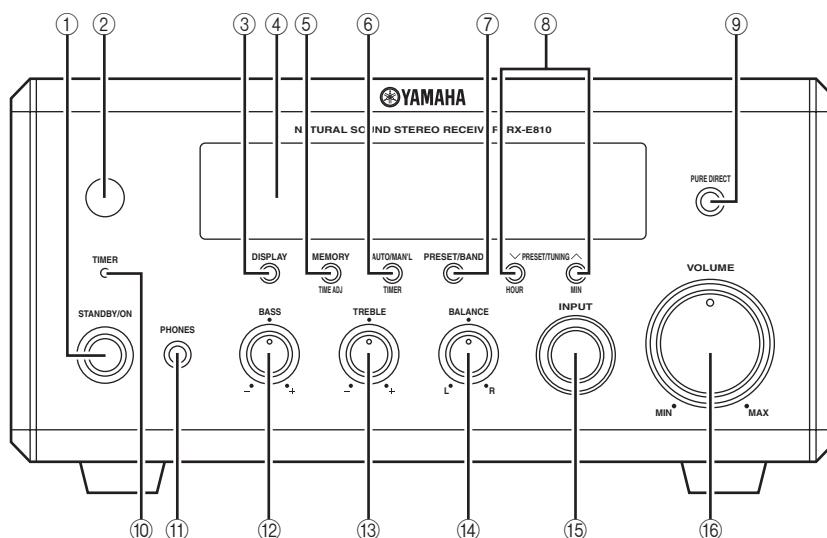

① **STANDBY/ON**

Turns the receiver on or sets it to the standby mode (see page 19).

② **Remote control sensor**

Receives signals from the remote control.

③ **DISPLAY**

Switches the information shown in the front panel display (see page 23).

④ **Front panel display**

Shows the various information such as the clock time or the tuning frequency.

⑤ **MEMORY (TIME ADJ)**

- Stores a preset station in the memory. Hold down this key for more than 2 seconds to preset radio stations automatically (see page 38).
- Sets the clock before using the timer function (see page 19).

⑥ **AUTO/MAN'L (TIMER)**

- Switches between Auto Tuning mode and Manual Tuning mode when tuner is selected as an input source (see page 37).
- Turns the clock timer function on or off (see page 43).

⑦ **PRESET/BAND**

Switches between FM, AM, and the preset mode when tuner is selected as an input source.

⑧ **PRESET/TUNING ∨ / ∧ (HOUR, MIN)**

Selects a tuning frequency when tuner is selected as an input source.

⑨ **PURE DIRECT**

Turns on or off the Pure Direct mode (see page 22).

⑩ **TIMER LED**

Lights up when the clock timer is on (see page 43).

⑪ **PHONES**

Outputs audio signals for private listening with headphones.

⑫ **BASS**

Adjusts the low frequency response (see page 22).

⑬ **TREBLE**

Adjusts the high frequency response (see page 22).

⑭ **BALANCE**

Adjusts the volume level of each left and right speaker channel (see page 22).

⑮ **INPUT**

Selects an input source.

⑯ **VOLUME**

Adjusts the volume level.

■ Rear panel

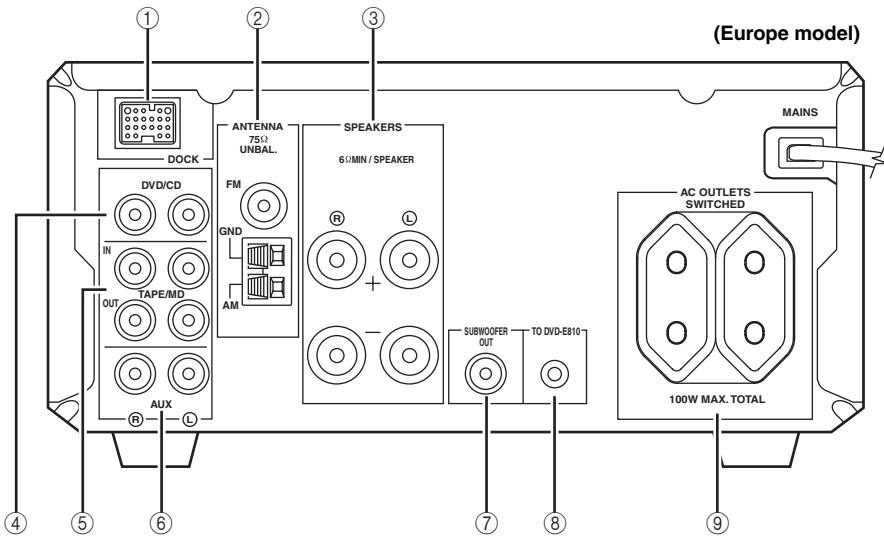

① **DOCK terminal**

Use to connect a YAMAHA iPod universal dock (such as YDS-10 sold separately) where your iPod can be stationed (see page 17).

② **Antenna terminals**

See page 15 for connection information.

③ **Speaker terminals**

See page 13 for connection information.

④ **DVD/CD jacks**

See page 12 for connection information.

⑤ **TAPE/MD IN/OUT jacks**

See page 16 for connection information.

⑥ **AUX jacks**

Use to connect the external components.

⑦ **SUBWOOFER OUT jack**

Use to connect the subwoofer.

⑧ **System connector (TO DVD-E810) jack**

See page 12 for connection information.

⑨ **AC OUTLET(S)**

See page 18 for connection information.

■ Front panel display

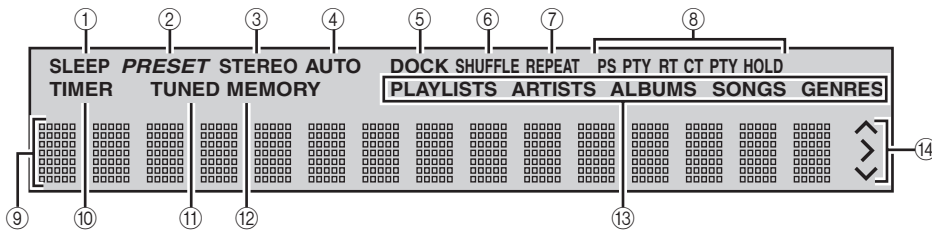

① SLEEP indicator

Lights up when the sleep timer is on (see page 44).

② PRESET indicator

Lights up when you preset radio stations manually (see page 39).

③ STEREO indicator

Lights up when the receiver is receiving a strong signal from an FM stereo broadcast.

④ AUTO indicator

Lights up when the receiver is in the Auto Tuning mode (see page 38).

⑤ DOCK indicator

Lights up when you station your iPod in a YAMAHA iPod universal dock (such as YDS-10 sold separately) connected to the DOCK terminal of the receiver (see page 17).

⑥ SHUFFLE indicator

Lights up when you set your iPod in shuffle mode.

⑦ REPEAT indicator

Lights up when you set your iPod in repeat mode.

⑧ Radio Data System indicators (U.K. and Europe models only)

The name of the Radio Data System data offered by the currently received Radio Data System station lights up.

PTY HOLD indicator

Lights up when the receiver is searching for the Radio Data System stations in the PTY SEEK mode (see page 40).

⑨ Multi-information display

Shows the various information such as the clock time or the tuning frequency.

⑩ TIMER indicator

Flashes when the receiver is in the clock timer setting mode (see page 43).

⑪ TUNED indicator

Lights up when the receiver is tuned into a station.

⑫ MEMORY indicator

Lights up or flashes when you preset radio stations.

⑬ iPod menu indicators

Light up the iPod menu currently selected (see page 49).

⑭ iPod operation indicators

Show operable cursor keys when operating the iPod menu with the menu browse mode (see page 49).

DVD player (DVD-E810)

■ Front panel

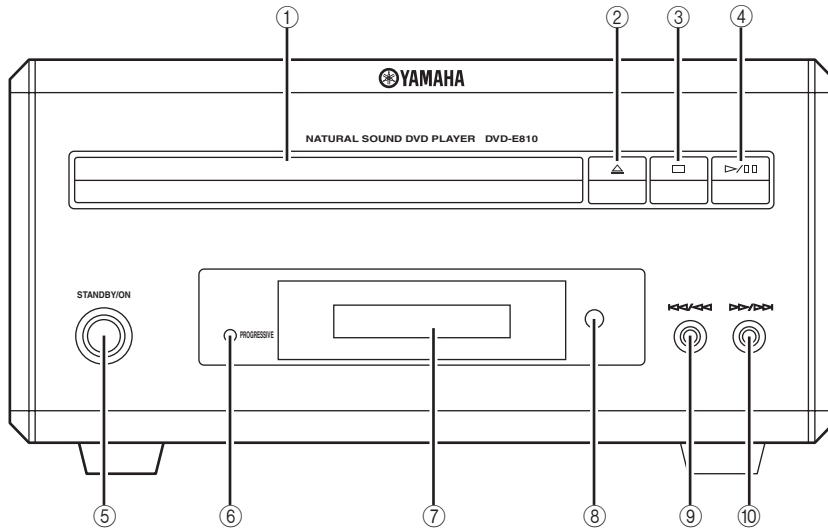

① **Disc tray**

Holds a disc to be played back.



Opens and closes the disc tray.



Stops playback (see page 25).



Starts or pauses playback (see page 25).

⑤ **STANDBY/ON**

Turns the DVD player on or sets it to the standby mode (see page 22).

⑥ **PROGRESSIVE indicator**

Lights up when the progressive scan mode is on (see page 54).

⑦ **Front panel display**

Shows the current status of the DVD player.

⑧ **Remote control sensor**

Receives signals from the remote control.



Skips to the beginning of the current chapter/track. Press and hold to fast reverse (see page 25).



Skips to the next chapter/track. Press and hold to fast forward (see page 25).

■ Rear panel

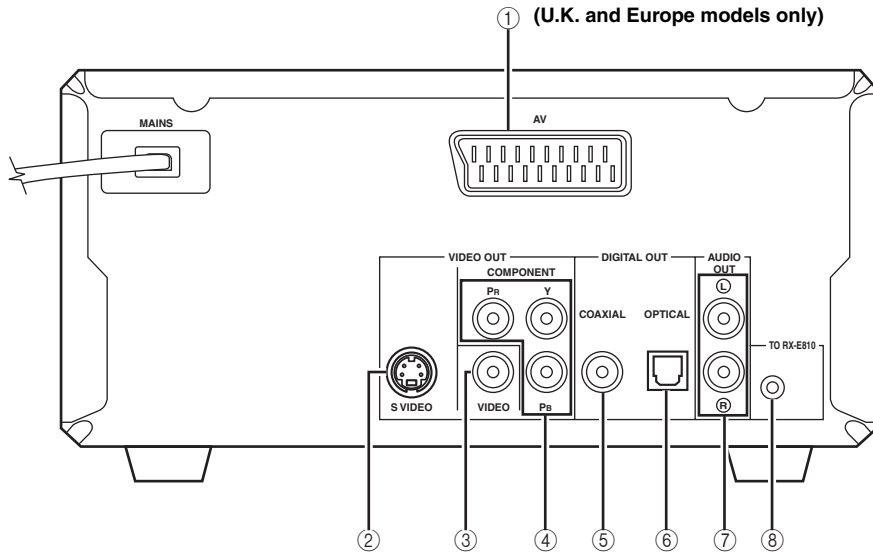

① **AV terminal (U.K. and Europe models only)**

See page 14 for connection information.

② **S VIDEO jack**

See page 14 for connection information.

③ **VIDEO jack**

See page 14 for connection information.

④ **COMPONENT jacks**

See page 14 for connection information.

⑤ **COAXIAL jack**

See page 16 for connection information.

⑥ **OPTICAL jack**

See page 16 for connection information.

⑦ **AUDIO OUT jacks**

See page 12 for connection information.

⑧ **System connector (TO RX-E810) jack**

See page 12 for connection information.

Remote control

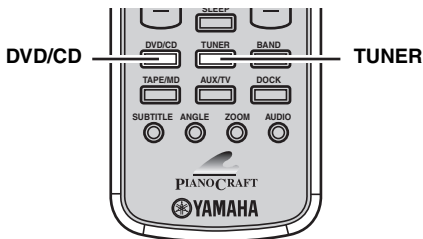
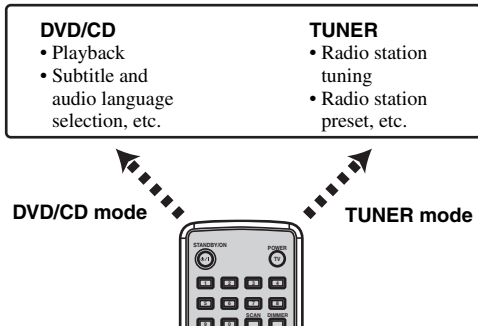

Common functions

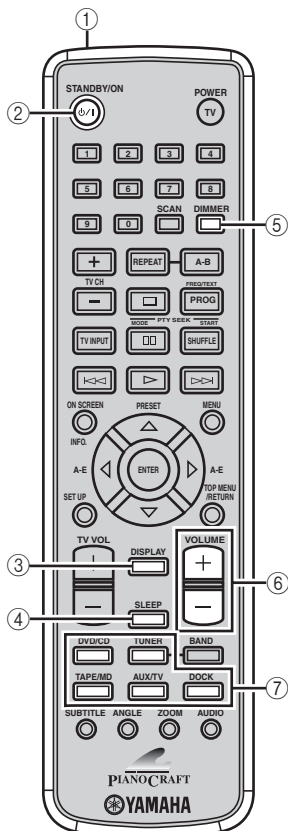

This remote control has two main operation modes to control this system. Before operating functions in each mode, you need to select a mode to change the remote control key assignments.

To switch the operation mode

- **DVD/CD mode:** Press DVD/CD.
- **TUNER mode:** Press TUNER.



You can also operate the TV and other components (such as an iPod) connected to the receiver using the remote control. For details, see “Controlling External Components” on page 46.

Note

Remote control descriptions and illustrations in this manual are based on the U.K. and Europe models unless otherwise specified.

Operations common to all modes

The following operations are available for the receiver when the remote control is in any operation modes.

- ① **Infrared signal transmitter**
Sends signals to the component you want to control.
- ② **STANDBY/ON (⏻/⏻)**
Turns the receiver on or sets it to the standby mode (see page 19).
- ③ **DISPLAY**
Switches the information shown in the front panel display (see page 23).
- ④ **SLEEP**
Sets the sleep timer on the receiver (see page 44).
- ⑤ **DIMMER**
Changes the brightness of the receiver’s front panel display (see page 23).
- ⑥ **VOLUME +/-**
Adjusts the overall volume level on the receiver.
- ⑦ **Input selection keys**
Select the input source on the receiver.



STANDBY/ON, DIMMER and SLEEP operations also control the DVD player when the DVD player is connected to the receiver with the supplied system control cable (see page 12).

DVD/CD mode

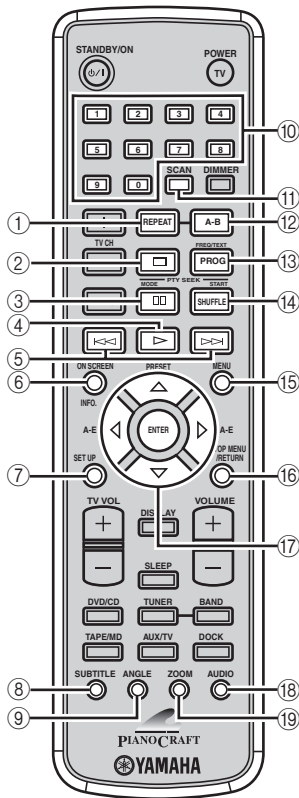

Operations available in DVD/CD mode

The following operations are available for the DVD player.

- Press DVD/CD to set the remote control to the DVD/CD mode before carrying out the following operations.
- ① **REPEAT**
Selects the Repeat Play mode (see page 26).
 - ② Stops playback (see page 25).
 - ③ Pauses playback (see page 25).
 - ④ Starts playback (see page 25).
 - ⑤ Skips to the beginning of the current chapter/track or next chapter/track. Press and hold to fast reverse or fast forward (see page 25).
 - ⑥ **ON SCREEN (INFO.)**
Displays the OSD menu on the TV screen or switches the time display of CDs (see page 34).
 - ⑦ **SET UP**
Displays the setup menu on the TV screen (see page 51).
 - ⑧ **SUBTITLE**
Selects the subtitle language (see page 30).
 - ⑨ **ANGLE**
Selects a viewing angle (see page 31).
 - ⑩ **Number keys (1 to 9, 0)**
Input numerals to specify parameters or chapter/track numbers.
 - ⑪ **SCAN**
Previews the content of a DVD or VCD (see page 28) or plays back the first few seconds of each track on a CD (see page 25).
 - ⑫ **A-B**
Repeats a specified section within a chapter/track (see page 26).
 - ⑬ **PROG**
Displays the program list used for the Program Play feature (see page 29).
 - ⑭ **SHUFFLE**
Turns on/off the Shuffle Play feature (see page 26).
 - ⑮ **MENU**
Displays the DVD menu (see page 31) or PBC menu of a VCD (see page 31).
 - ⑯ **TOP MENU/RETURN**
Returns to the top of the DVD menu (see page 31) or to the previous PBC menu (see page 31). Press and hold to return to the previous DVD menu.
 - ⑰ **Cursor keys () , ENTER**
Selects an item in the menu screen or specify the selected parameter.
 - ⑱ **AUDIO**
Selects the audio language (see page 30).
 - ⑲ **ZOOM**
Zooms in a specified part of picture (see page 30).

■ TUNER mode

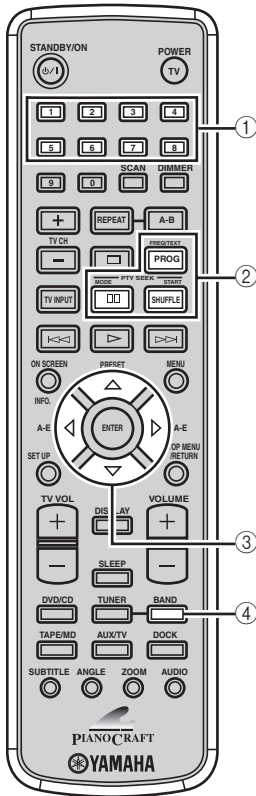

Operations available in TUNER mode

The following operations are available for the receiver.



Press TUNER to set the remote control to the TUNER mode before carrying out the following operations.

① **Number keys (1 to 8)**
Selects preset station number (see page 39).

② **Radio Data System tuning keys (U.K. and Europe models only)**

FREQ/TEXT

Switches the Radio Data System display between the PS mode, PTY mode, RT mode, CT mode (if the station offers the corresponding data services) and the frequency display (see page 41).

PTY SEEK MODE

Sets the receiver to the PTY SEEK mode (see page 40).

PTY SEEK START

Starts searching for a station once the desired program type is selected in the PTY SEEK mode (see page 40).

③ **A-E** , **PRESET**
Press A-E to select a preset station group (A to E) and PRESET to select a preset station number (1 to 8) (see page 39).

④ **BAND**
Switches the radio reception mode between FM, AM and the preset mode.

■ Installing the batteries in the remote control

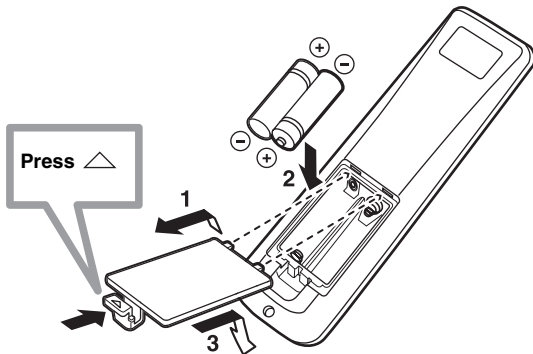

1 Press the \triangle mark on the battery cover and open the cover.

2 Insert the two supplied batteries (AA, R06, UM-3) into the battery compartment.

Make sure you insert the batteries according to the polarity markings (+ and -).

3 Close the battery cover.

Notes

- Do not use an old battery together with new one.
- Do not use different types of batteries (for example, alkaline and manganese) together. Each type of battery has its own characteristics even if they are similar in shape.
- If the batteries run out, immediately remove them from the remote control to prevent an explosion or acid leak.
- Dispose of the batteries according to the regional regulations.
- If a battery starts leaking, dispose of it immediately. Be careful not to let leaking battery acid come into contact with your skin or clothing. Before inserting new batteries, wipe the compartment clean.
- Replace the batteries within two minutes to preserve the memory in the remote control.

■ Using the remote control

Use the remote control within 6 m (20 feet) of the component you want to control and point it toward its remote control sensor (see pages 3 and 6).

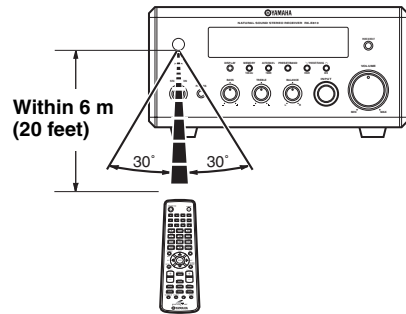

Notes

- Be careful not to spill liquid on the remote control.
- Be careful not to drop the remote control.
- Do not leave the remote control in the following places:
 - hot or humid places, such as near a heater or in a bathroom
 - extremely cold places
 - dusty places

Connecting the System

Make sure you read the following procedure and notes carefully before connecting the system. For information on the speakers (NX-E800), refer to the owner's manual supplied with it.

Note

Do not connect the power cable of the receiver, DVD player, or other components to the wall outlet until all cable connections are completed.

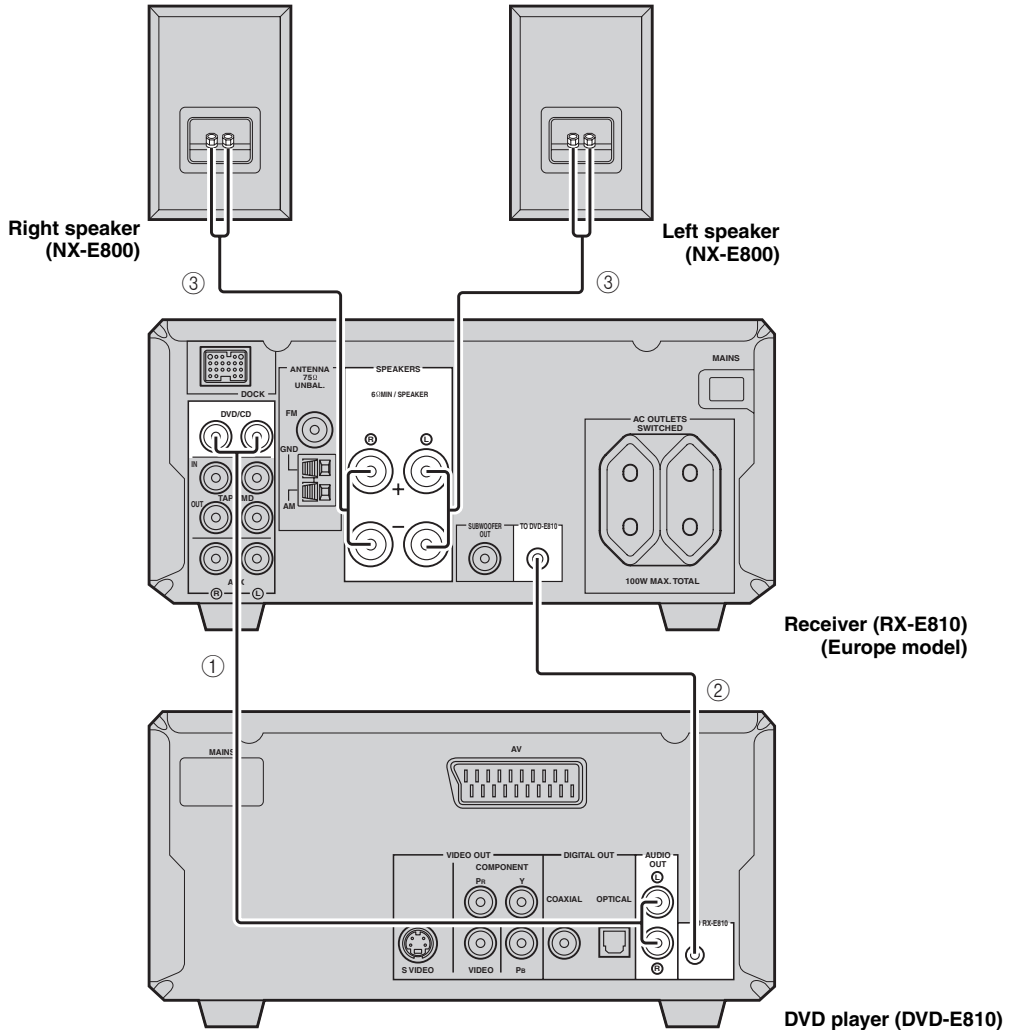

- ① Connect the DVD/CD (L/R) jacks of the receiver to the AUDIO OUT (L/R) jacks of the DVD player using the supplied audio pin cable.
- ② Connect the system connector (TO DVD-E810) jack of the receiver to the system connector (TO RX-E810) jack of the DVD player using the supplied system control cable.
- ③ Connect the speaker terminals (L) of the receiver to the speaker terminals of the left speaker and the speaker terminals (R) of the receiver to the speaker terminals of the right speaker using the speaker cables supplied with the speaker set (NX-E800). See page 13 for details.



- The system control connection is used to synchronize the specific operations between the receiver and the DVD player.
- If you want to connect an amplifier with a digital input instead of the RX-E810, use the DIGITAL OUT (COAXIAL or OPTICAL) jacks of the DVD player and configure the "DIGITAL OUTPUT" setting in the setup menu (see page 52).

■ Connecting the speaker cable

Notes

- Be sure to connect the left channel (L), right channel (R), “+” (red) and “-” (black) properly. If the connections are faulty, no sound will be heard from the speakers, and if the polarity of the speaker connections is incorrect, the sound will be unnatural and lack bass.
- Do not let the bare speaker wires touch each other or do not let them touch any metal part of the receiver. This could damage the receiver and/or the speakers.
- When connecting another speaker set instead of the NX-E800, be sure to use speakers with the specified impedance shown on the rear panel of the receiver and magnetically shielded. In case the magnetically shielded speakers interfere with the monitor, place the speakers away from the monitor.

- 1 Remove approximately 10 mm (3/8 in) of insulation from the end of each speaker cable and then twist the exposed wires of the cable together to prevent short circuits.**

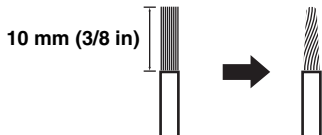

- 2 Unscrew the knob.**

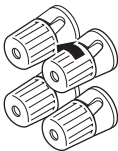

Red: positive (+)
Black: negative (-)

- 3 Insert the bare wire into the terminal.**

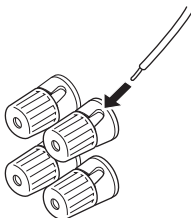

Red: positive (+)
Black: negative (-)

- 4 Tighten the knob to secure the wire.**

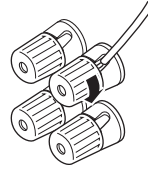

Red: positive (+)
Black: negative (-)

Connecting a TV

Follow the procedure below to connect your TV to the DVD player using the supplied video pin cable. Also, you can enjoy high-quality pictures with a S-video connection, a component video connection or a scart connection (U.K. and Europe models only) using a corresponding commercially available cable. For information on your TV, refer to the owner's manual supplied with it.

Note

Do not connect the power cable of the receiver, DVD player, or other components to the wall outlet until all cable connections are completed.

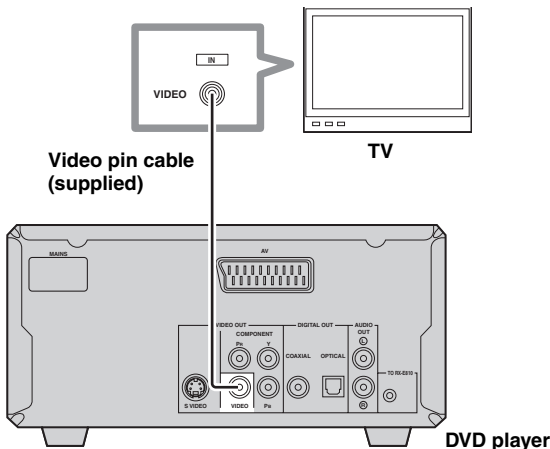

Connect the VIDEO jack of the DVD player to the video input jack of your TV using the supplied video pin cable.



To enjoy TV sounds with the receiver, connect AUX (L/R) jacks of the receiver to the audio output jacks of your TV using a commercially available audio pin cable.

■ Component video connection

Connect the COMPONENT jacks of the DVD player to the component video input jacks of your TV using a commercially available component video cable.

Note

(U.K. and Europe models only)

When you make a component video connection, set "COMPONENT" to "YUV" in the setup menu of the DVD player (see page 54).

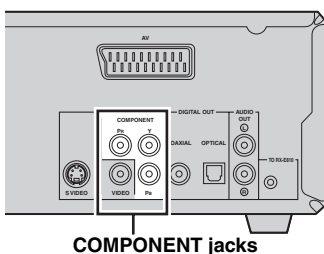

■ S-video connection

Connect the S VIDEO jack of the DVD player to the S-video input jack of your TV using a commercially available S-video cable.

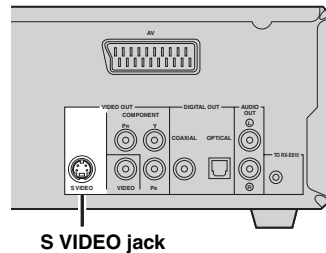

■ Scart connection (U.K. and Europe models only)

Connect the AV terminal of the DVD player to the scart input terminal of your TV using a commercially available scart cable.

Note

(U.K. and Europe models only)

When you make a scart connection, set "COMPONENT" to "RGB" in the setup menu of the DVD player (see page 54).

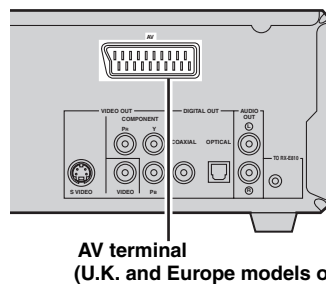

Connecting Antennas

To enjoy radio on the receiver, connect the supplied AM and FM antennas to the designated terminals. If there is a problem of weak radio wave reception in your area or you want to improve radio reception, we recommend that you use optional outdoor antennas. For details, consult the nearest authorized YAMAHA dealer or service center.

Note

Be sure to set the tuner frequency step (Asia and Taiwan models only) according to the frequency spacing in your area (see page 38).

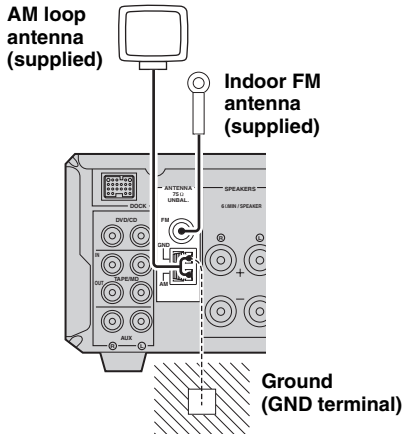

About grounding

For maximum safety and minimum interference, connect the antenna GND terminal to a good earth ground. A good earth ground is a metal stake driven into moist earth.

Connecting the AM loop antenna

1 Attach the antenna stand to the antenna.

When attaching the antenna to the wall, you do not need to use the antenna stand.

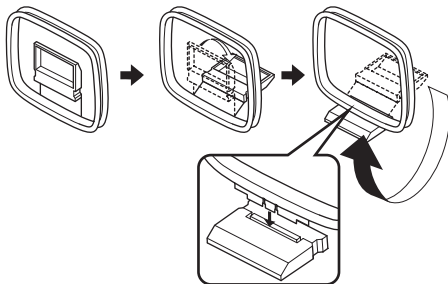

2 Press down the tab of the AM terminal.

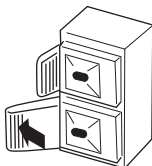

Note

Depending on the product, the shape of the tab is different from the described illustration.

3 Insert the AM loop antenna lead wires into the AM terminal.

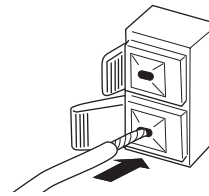

4 Replace the tab back to secure the wire.

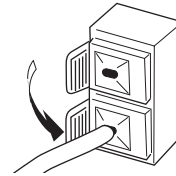

5 Repeat steps 2 to 4 to insert the AM loop antenna lead wires into the GND terminal.

6 Place the antenna away from the receiver and speaker cables.

While listening to the radio, rotate the antenna head to find the best angle for reception.

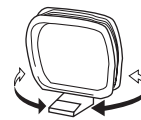

Connecting the FM antenna

1 Connect the supplied indoor FM antenna to the FM jack of the receiver.

2 Place the antenna away from the receiver and speaker cables.

Connecting External Components

You can connect various audio components, such as an MD player, a tape deck or a YAMAHA iPod universal dock to the receiver. Also you can connect an MD recorder or a CD recorder to the DVD player using the DIGITAL OUT jacks. For information on your external component, refer to the owner's manual supplied with each component.

Note

Do not connect the power cable of the receiver, DVD player, or other components to the wall outlet until all cable connections are completed.

Connecting an MD player or a tape deck

If you connect an MD player or a tape deck to the receiver, you can enjoy audio sources played on the component.

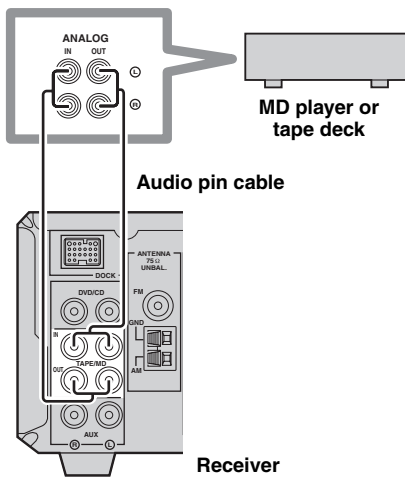

Connecting an MD recorder or a CD recorder

If you connect an MD recorder or a CD recorder to the DVD player with a digital connection, you can make a digital recording.

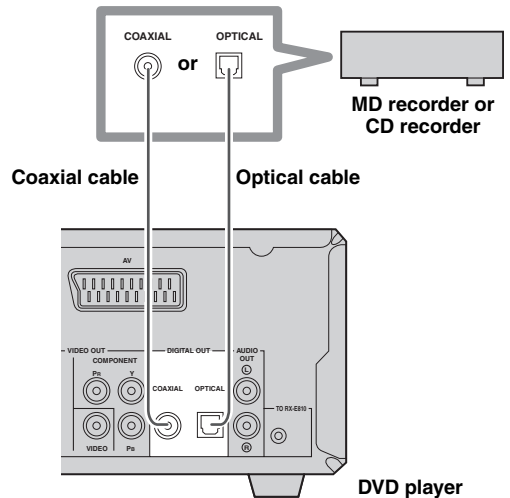

- 1 Connect the TAPE/MD IN (L/R) jacks of the receiver to the analog output jacks of an MD player or a tape deck using a commercially available audio pin cable.
- 2 To record audio output from the receiver, connect the TAPE/MD OUT (L/R) jacks of the receiver to the analog input jacks of an MD player or a tape deck using a commercially available audio pin cable.

Connect the DIGITAL OUT (COAXIAL or OPTICAL) jack of the DVD player to the digital input (coaxial or optical) jack of an MD recorder or a CD recorder using a commercially available coaxial or optical cable.

Notes

- The DIGITAL OUT jacks are compatible with PCM, Dolby Digital and DTS signals.
- The DIGITAL OUT (OPTICAL) jack is designed based on EIA standards. To make a digital connection, use an optical cable that meets EIA standards.

Connecting a YAMAHA iPod universal dock

The receiver (RX-E810) is equipped with the DOCK terminal on the rear panel that allows you to connect a YAMAHA iPod universal dock (such as YDS-10 sold separately) where you can station your iPod and control playback of your iPod using the supplied remote control. Connect a YAMAHA iPod universal dock (such as YDS-10 sold separately) to the DOCK terminal on the rear of the receiver using its dedicated cables. Once the connection is complete, station your iPod in the YAMAHA iPod universal dock.

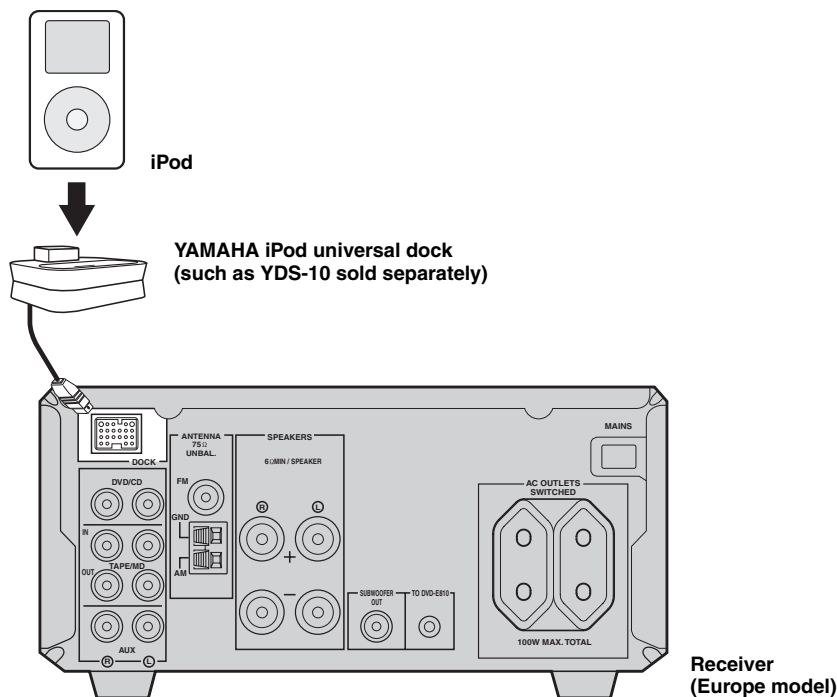

Notes

- Do not connect the power cable of the receiver, DVD player, or other components to the wall outlet until all cable connections are completed.
- Only iPod (Click and Wheel), iPod nano, and iPod mini are supported.
- You need a YAMAHA iPod universal dock (such as YDS-10 sold separately) and its dedicated cable compatible with the DOCK terminal of the receiver.
- Do not connect any iPod accessories (such as headphones, a wired remote control, or an FM transmitter) to your iPod when it is stationed in a YAMAHA iPod universal dock (such as YDS-10 sold separately).
- Unless your iPod is firmly stationed in a YAMAHA iPod universal dock (such as YDS-10 sold separately) connected to the DOCK terminal of the receiver, audio signals may not be output properly.
- Once the connection between your iPod and the receiver is complete and the receiver is set to DOCK mode (see page 47), "iPod connected" appears in the front panel display. If the connection between your iPod and the receiver fails, a status message appears in the front panel display. For a complete list of connection status message, see the iPod section in "Troubleshooting" on page 60.
- Your iPod battery is automatically charged when your iPod is stationed in a YAMAHA iPod universal dock (such as YDS-10 sold separately) connected to the DOCK terminal of the receiver as long as the receiver is turned on.
- Depending on the type of the iPod, you may need to insert one of the iPod adapters supplied with a YAMAHA iPod universal dock (such as YDS-10 sold separately) into the dock slot before you station your iPod.

Connecting the Power Cables

Once all connections are complete, connect the power cable of the DVD player to the AC OUTLET(S) terminal on the rear of the receiver (or the AC wall outlet if the AC OUTLET(S) terminal is not available), and then plug the power cable of the receiver into the AC wall outlet.

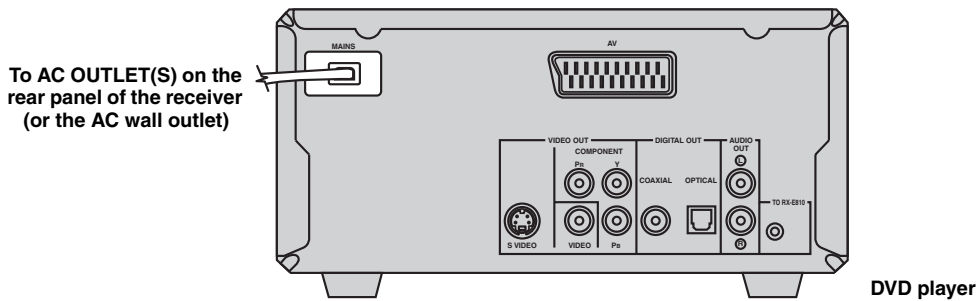
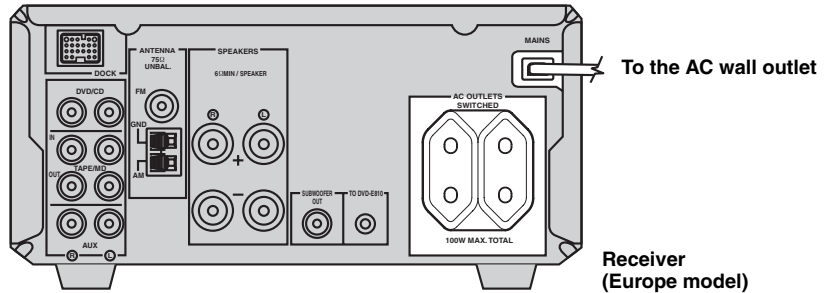

■ AC OUTLET(S) (SWITCHED)

- U.K. and Australia models 1 outlet
- Korea model None
- Other models 2 outlets

Use these outlet(s) to supply power to the DVD player or any connected components. Connect the power cable of your other components to these outlet(s). Power to these outlet(s) is supplied when the receiver is turned on. For information on the maximum power or the total power consumption of the components that can be connected to these outlet(s), see “Specifications” on page 67.

Setting the System

Before starting playback operation, follow the procedure below to configure the system settings.

Step 1: Turn on the power and select the DVD input

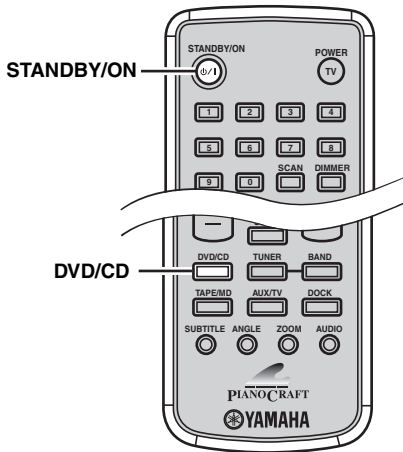

- 1 Turn on your TV and then press **STANDBY/ON** to turn on the receiver.

If the DVD player is connected to the receiver with the system control cable, the DVD player turns on automatically. Otherwise, press **STANDBY/ON** on the front panel of the DVD player to turn on it. The front panel display of each component lights up.

- 2 Press **DVD/CD** to select “DVD/CD” as an input source.

- 3 On your TV, select the input to which the DVD player is connected (**EXT1**, **AV1**, etc.). For details, refer to the manual supplied with your TV.

The default screen appears on the TV screen.

Note

If the picture is distorted on your TV, the color system (NTSC and PAL) setting of the DVD player may not match your TV.

To switch the color system setting in such case, press  and then **AUDIO** while the disc tray is open.

Step 2: Adjust the clock

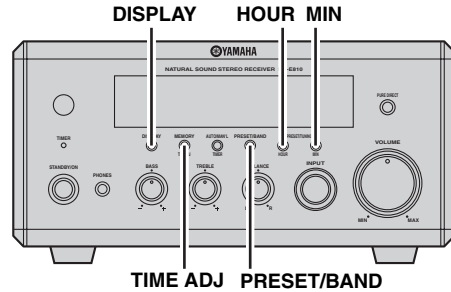

- 1 Press **DISPLAY** on the front panel of the receiver.

“Clock Time” appears in the front panel display for a few seconds, and then “Set Clock” appears.

- 2 Press **TIME ADJ** for about two seconds to enter the clock setting mode.

- 3 To set the hour setting ahead, press **HOUR** repeatedly. To set the hour setting backward, press **HOUR** repeatedly while holding down **PRESET/BAND**.

- 4 To set the minute setting ahead, press **MIN** repeatedly. To set the minute setting backward, press **MIN** repeatedly while holding down **PRESET/BAND**.

- 5 Press **TIME ADJ** once again to confirm the clock setting.

“Adjusted” appears in the front panel display for a few seconds, and then the clock appears.

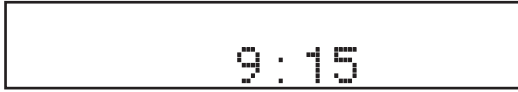

You can switch between 12-hour (AM/PM) format and 24-hour format by pressing **HOUR** or **MIN** while the clock is displayed in the front panel display.

Step 3: Set the aspect ratio

Follow the procedure below to configure the aspect ratio setting of the DVD player. (The default setting is “4:3 PAN SCAN”.)

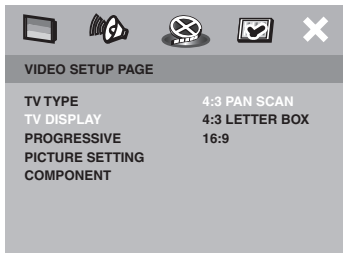
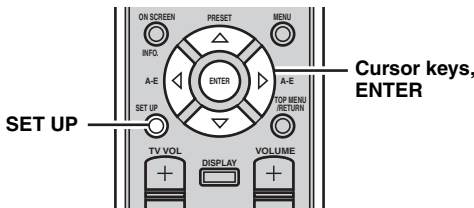

- 1 Press **SET UP**.

The setup menu appears on the TV screen.

- 2 Press **◀** or **▶** repeatedly to select “**VIDEO SETUP PAGE**”.

- 3 Press **▲** or **▼** to select “**TV DISPLAY**”, and then press **▶**.

- 4 Press **▲** or **▼** to select the desired setting, and then press **ENTER** to confirm the selection.

4:3 PAN SCAN

Select this if the aspect ratio of your TV is 4:3 and you want both sides of the picture to be trimmed or formatted to fit your TV screen.

4:3 LETTER BOX

Select this if the aspect ratio of your TV is 4:3. In this case, a wide picture with black bands on the upper and lower portions of the TV screen are displayed.

16:9

Select this if you have a widescreen TV.

- 5 To exit from the setup menu, press **SET UP** once again.

Step 4: Set the OSD language

Follow the procedure below to configure the language setting used for the OSD and setup menus. (The default settings is “ENGLISH”.)

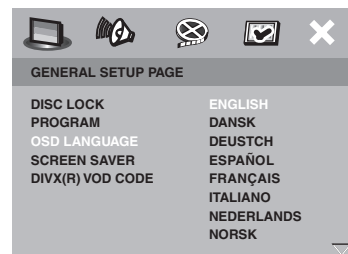
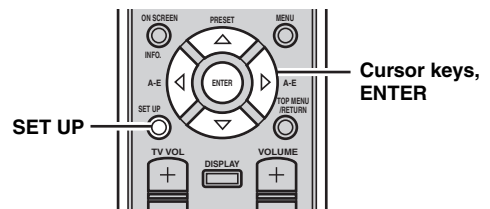

- 1 Press **SET UP**.

The setup menu appears on the TV screen.

- 2 Press **◀** or **▶** to select “**GENERAL SETUP PAGE**”.

- 3 Press **▲** or **▼** to select “**OSD LANGUAGE**”, and then press **▶**.

- 4 Press **▲** / **▼** to select the desired language, and then press **ENTER** to confirm the selection.

Step 5: Set the the default audio, subtitle, and disc menu languages

If you set the default audio, subtitle, and disc menu languages, the DVD player automatically switches to the selected language when a disc is loaded. If the selected language is not available on the disc, the default language of the disc will be used instead. (The default setting is “ENGLISH” for audio and disc menu and “OFF” for subtitle.)

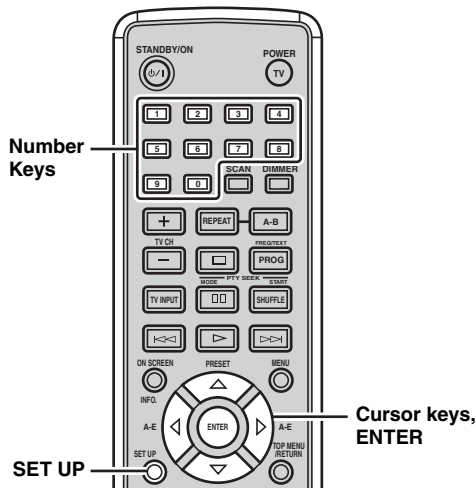

1 Press SET UP.

The setup menu appears on the TV screen.

2 Press ◀ or ▶ to select “PREFERENCE PAGE”.

Note

“PREFERENCE PAGE” is available only when no disc is loaded or the DVD player is in the Stop mode (see page 25).

3 Press ▲ or ▼ to select “AUDIO”, “SUBTITLE”, or “DISC MENU”, and then press ▶.

4 Press ▲ or ▼ to select the desired language, and then press ENTER to confirm the selection.

If the desired language is not listed, select “OTHERS”, use the number keys to enter the 4-digit language code (see page 57), and then press ENTER.

5 To exit from the setup menu, press SET UP once again.

Basic Receiver Operations

Follow the procedure below to select an input source and adjust the sound settings on the receiver.

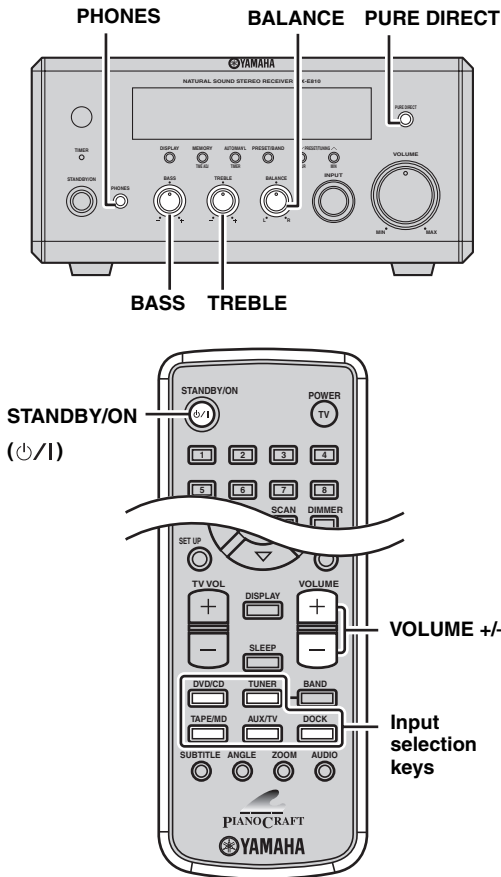

1 Press STANDBY/ON to turn on the receiver.

If the DVD player is connected to the receiver with the system control cable, the DVD player turns on automatically. The front panel display of each component lights up.



This system has the auto-standby function (see page 45) which automatically set the system to the standby mode if you do not operate the system for 30 minutes while the receiver is set to the DVD/CD input mode.

2 Press one of the input selection keys to select the desired input source.

3 Start playback on the selected source component or select a broadcast station.

For information on the disc playback, see page 25, and for information on tuning, see page 37.

4 Press VOLUME +/- to adjust the volume to the desired output level.

5 Rotate BASS, TREBLE, or BALANCE on the front panel of the receiver to adjust the following settings.

BASS: Adjusts the low frequency response.

TREBLE: Adjusts the high frequency response.

BALANCE: Adjusts the volume level of each left and right speaker channel.

■ Pure Direct mode

The Pure Direct mode shuts down the tone control circuitry, allowing you to enjoy pure high-fidelity sounds from analog sources.

Press PURE DIRECT on the front panel of the receiver to turn on the Pure Direct mode.

PURE DIRECT lights up, and the front panel display automatically dims.

Notes

- While the Pure Direct mode is turned on, neither BASS, TREBLE, nor BALANCE are available.
- If you carry out any operation while the Pure Direct mode is turned on, the front panel display lights up briefly to acknowledge the command and dims again.

To turn off the Pure Direct mode

Press PURE DIRECT again so that PURE DIRECT turns off and the front panel display lights up.

■ To use headphones

Connect the headphones to the PHONES jack. You can listen to the sound to be output from the speakers through the headphones.

Changing the front panel display settings

Follow the procedure below to change the settings of the receiver's front panel display.

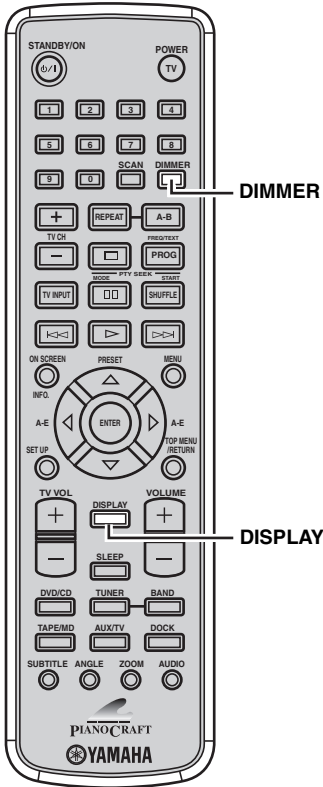

■ To switch the display mode

You can switch the information displayed in the receiver's front panel display between the current input and clock.

Note

You cannot display the clock unless you adjust it (see page 19).

Press DISPLAY repeatedly to select the desired display mode.

Each time you press the key, the display changes as follows.

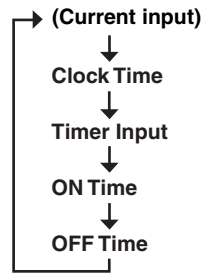

"Timer Input", "ON Time", and "OFF Time" are used to set the clock timer (see page 43).

■ To dim the display

You can dim the front panel display of the receiver. The front panel display of the DVD player also dims if it is connected to the receiver using a system control connection (see page 12). (The default setting is "DIMMER OFF".)

Press DIMMER to select "DIMMER ON".

To return to normal brightness

Press DIMMER to select "DIMMER OFF".

Supported Disc Types

You can enjoy movie or music discs with the DVD player. Since some disc operations are limited to specific disc types, the supported disc types are indicated using the icons shown below. Each means that the operations is limited to the corresponding disc type. Operations with no icon indicated are available for all disc types.

Note

Depending on a disc format, some discs may not be compatible with the DVD player. Before loading a disc into the DVD player, be sure to check the disc compatibility of the DVD player (see page 63).

DVD/DVD-VR	VIDEO CD/ SUPER VIDEO CD	Music CD
		

■ About data discs (MP3, WMA, JPEG, and DivX)

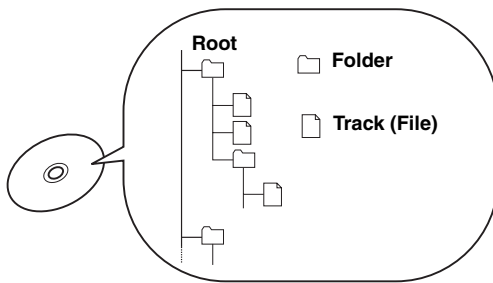

You can play back MP3 and WMA format files recorded on a CD-R/RW, DVD+R/RW, and DVD-R/RW with similar uses as a music CD. The DVD player regards files in the disc as tracks (as shown on the left). Also you can play back JPEG picture files and DivX video files recorded on a CD-R/RW, DVD+R/RW, or DVD-R/RW. For details about how to play those discs, see “Playing back MP3/WMA/JPEG/DivX discs” on page 32.

Note

Depending on recording conditions such as recording software settings, the DVD player may not be able to play the disc or play tracks in the order they were recorded. For information on disc compatibility of the DVD player, see page 63.

Basic Disc Playback Operations

Follow the procedures below to carry out basic disc playback operations.

Notes

- If the inhibit icon (⊘) appears on the TV when a button is pressed, it means the function is not available on the current disc or the current status.
- Depending on the disc, some operations may be different or restricted.

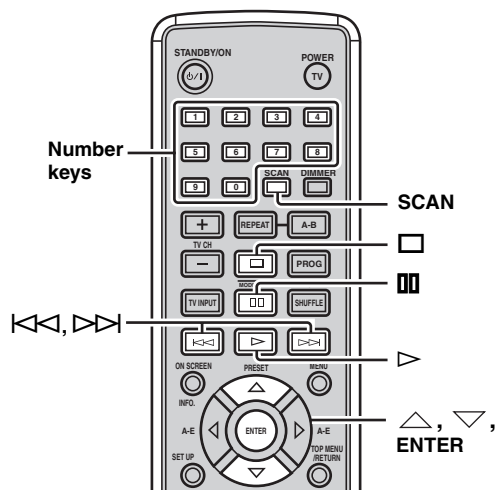

To start playback

Load the disc (press \triangle on the front panel of the DVD player to open/close the disc tray).



- This unit automatically starts playback when a disc is loaded. In case that the disc has the start menu, you may need to press \triangleright to start playback.
- For CDs, you can play back the first few seconds of each track sequentially by pressing SCAN while the playback stops. Press \triangleright to return to normal playback.

To stop playback

Press \square .



This unit automatically memorizes the stopping position when playback is stopped. If you press \triangleright , playback resumes from where it left off. If you press \square once again, the stopping position will be cleared from the memory. (This is called "Stop mode".)

To pause playback

Press \parallel .

To return to normal playback, press \triangleright .

To advance frame-by-frame DVD VCD

Press \parallel to pause playback, then press \parallel repeatedly. Each time you press \parallel , playback advances one frame at a time. To return to normal playback, press \triangleright .

To fast reverse or fast forward

To fast reverse, hold down \lll for a few seconds.

To fast forward, hold down \ggg for a few seconds.

Each time you press the button after holding down it, the speed increases (decreases).

To slow reverse or slow forward DVD VCD

To slow reverse press \triangle . To slow forward, press ∇ .

Each time you press the button, the speed increases (decreases).

Note

The slow reverse feature is not available for VCDs and SVCDs.

To skip chapters (tracks)

To skip to the start of the current chapter (track), press \lll .

To skip to the next chapter (track), press \ggg .

To skip to the previous chapter (track), quickly press \lll twice.

Note

The skip feature may not work properly when playing back a VCD or SVCD using the PBC menu (see page 31).

To specify a chapter (track) for playback

Use the number keys to enter the chapter (track) number you want to play.

To specify 1-digit number, press a number key to enter the track number and then ENTER, or press 0 and then a number key to enter the track number.

Note

This feature may not work properly when playing back a VCD or SVCD using the PBC menu (see page 31).

Repeating disc playback (Repeat Play)

You can repeat the playback of the selected item in a disc. Also, you can set two points to repeat the specified section of a chapter (track) with A-B Repeat.

Notes

- Repeat Play may not work depending on DVD disc types.
- Repeat Play does not work while playing back a VCD or SVCD using the PBC menu (see page 31).

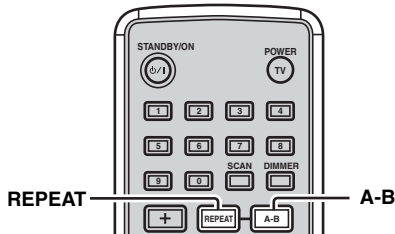

1 Play back the disc, title, or chapter (track) you want to repeat.

2 Press REPEAT to select the desired Repeat Play mode.

Each time you press the key, the mode changes as follows.

DVD

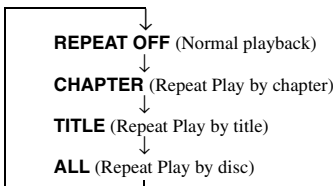

VCD/CD

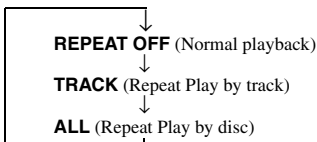

MP3/WMA/JPEG/DivX

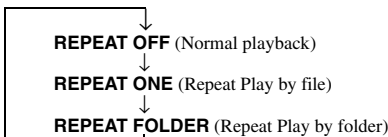

To cancel Repeat Play

Press REPEAT to select "REPEAT OFF".



When playing back a JPEG or picture CD with the slide show mode, "REPEAT ALL" (Repeat Play by disc) appears instead of "REPEAT FOLDER".

To repeat between two points (A-B Repeat)

You can repeat the specified section of a chapter (track) by setting two points (start and end points).

Note

You can use A-B Repeat only within one chapter (track).

1 Play back the chapter or track that includes the section you want to repeat.

2 At the position where you want to set as the start point of the repeat section, press A-B. "A" appears on the TV screen.

3 At the position where you want to set as the end point of the repeat section, press A-B once again. "AB" appears on the TV screen and A-B Repeat starts.

To cancel A-B Repeat

Press A-B once.

Playing back randomly (Shuffle Play)

You can play back chapters or tracks in the disc in random order.

Notes

- Shuffle Play is not available for DVD-VRs.
- Shuffle Play does not work while playing back a VCD or SVCD using the PBC menu (see page 31).

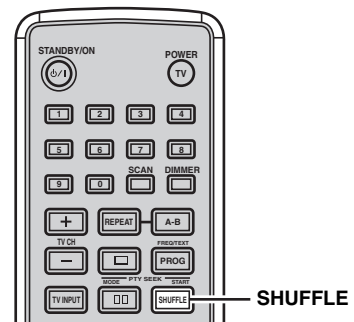

1 Play back the disc.

2 Press SHUFFLE to select the desired Shuffle Play mode.

Each time you press the key, the mode changes as follows.

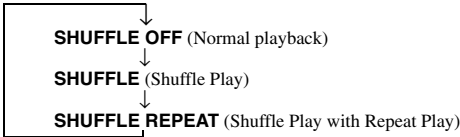

To cancel Shuffle Play

Press SHUFFLE to select “SHUFFLE OFF”.

Specifying an elapsed time for playback (Time Search) DVD VCD

You can specify an elapsed time where you want playback to start.

Notes

- Using the Time Search feature for a VCD or SVCD automatically closes the PBC menu (see page 31).
- You cannot specify an elapsed time that exceeds the total time.

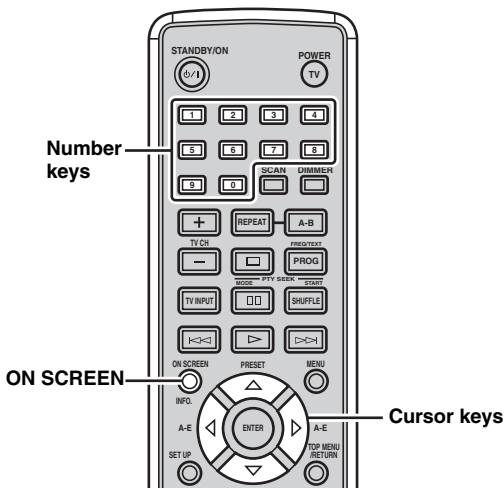

Time Search on DVD

1 While playing back a disc, press ON SCREEN.

The OSD menu appears on the TV screen.

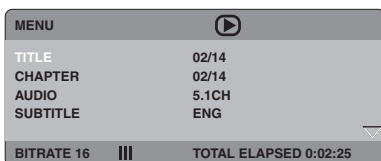

2 Press \triangle or ∇ to select “TT TIME” or “CH TIME”, and then press \triangleright .

TT TIME:

Select this if you want to specify an elapsed time for the current title.

CH TIME:

Select this if you want to specify an elapsed time for the current chapter.

3 Use the number keys to enter hours, minutes, and seconds.

Playback skips to the specified position.



To return to the previous menu, press \triangleleft . To exit from the OSD menu, press ON SCREEN.

Time Search on VCD

1 While playing back a disc, press ON SCREEN.

The OSD menu appears on the TV screen.

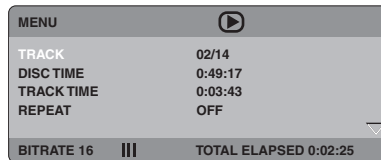

2 Press \triangle or ∇ to select “DISC TIME” or “TRACK TIME”, and then press \triangleright .

DISC TIME:

Select this if you want to specify an elapsed time for the entire disc.

TRACK TIME:

Select this if you want to specify an elapsed time for the current track.

3 Use the number keys to enter hours, minutes, and seconds.

Playback skips to the specified position.



To return to the previous menu, press \triangleleft . To exit from the OSD menu, press ON SCREEN.

Specifying a preview picture for playback (Scan Search) DVD VCD

You can preview the content of a DVD or VCD with pictures selected at regular intervals, and specify a preview picture for playback.

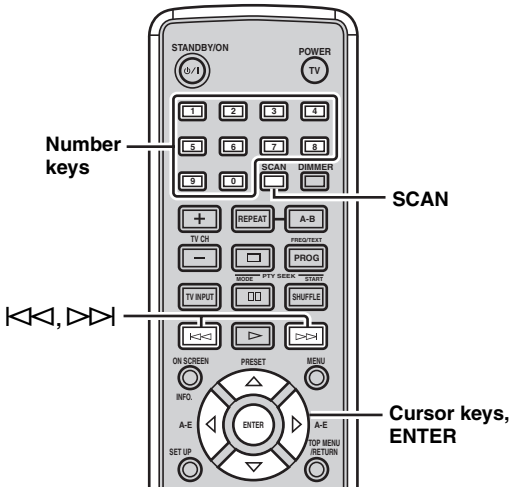

1 While the disc is loaded into the DVD player, press **SCAN**.

2 Press \triangle or ∇ to select one of the following preview modes, and then press **ENTER**.

DVD

TITLE DIGEST:

Displays the beginning of each title.

CHAPTER DIGEST:

Displays the beginning of each chapter.

TITLE INTERVAL:

Divides a title into parts at 10 minutes intervals and play back the first 3-4 seconds of each part.

CHAPTER INTERVAL:

Divides a chapter into parts at 10 minutes intervals and play back the first 3-4 seconds of each part.

VCD

TRACK DIGEST:

Displays the beginning of each track.

TRACK INTERVAL:

Divides a track into six parts at regular intervals, and displays the beginning of each part.

DISC INTERVAL:

Divides a disc into six parts at regular intervals, and displays the beginning of each part.

Notes

- You can only select "TRACK INTERVAL" during VCD playback when the PBC menu (see page 31) is turned off.
- CHAPTER DIGEST and CHAPTER INTERVAL are not available for DVD-VR discs.

3 Use the cursor keys to select the desired preview picture or number keys to input the picture number.

Pressing \lll or \ggg switches the preview list to the previous/next page.



- To select another preview mode, use the cursor keys to select "MENU" in the preview list, and then press ENTER.
- To cancel Scan Search, use the cursor keys to select "EXIT" in the preview list, and then press ENTER or press SCAN again.

4 Press **ENTER** to start the playback of the selected item.

Customizing playback order (Program Play)

You can customize the playback order for chapters or tracks stored in the disc. This unit can memorize playback order of 10 discs (20 chapters or 20 tracks for each disc).

Notes

- The PBC menu (see page 31) is not available during Program Play of a VCD or SVCD.
- The Program Play feature is not available for MP3, WMA, JPEG, and DivX discs.

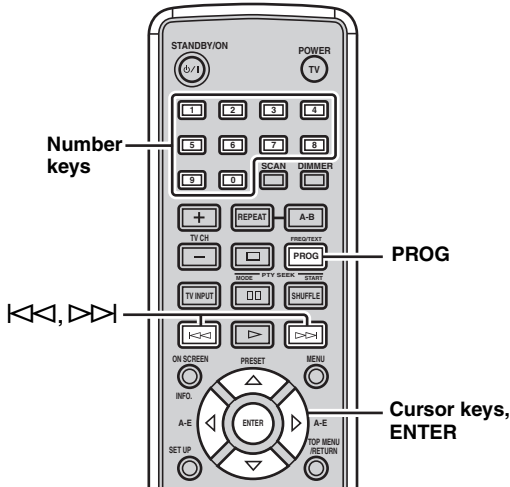

- To cancel the Program Play feature, use the cursor keys to select "EXIT" in the program list, and then press ENTER.
- To remove a chapter or track programmed in the list, use the cursor keys to select the program number to be cleared, and then press ENTER.

1 While the disc is loaded into the DVD player, press PROG.

The program list appears on the TV screen.

2 Use the cursor keys to select a program number, and then press ENTER.

Pressing <<< or >>> switches the program list to the previous/next page.

3 To program the order for a DVD disc, use the number keys and ENTER to enter a title number, and then enter a chapter number. To program the order for a VCD, SVCD, or CD, use number keys and ENTER to enter a track number.

Repeat steps 2 and 3 until you select all desired chapters (tracks).

4 To start playback with Program Play, use the cursor keys to select "START", and then press ENTER.

Selecting audio and subtitle languages DVD /audio channel settings VCD

You can select audio and subtitle languages for DVD disc playback and audio channel settings for VCD. If no language is selected, the default languages specified in the setup menu (see page 21) are selected.

Note

The selections of audio and subtitle languages are available only with multi-language compatible discs. Also, languages available for each disc may vary. For information on your disc, refer to the operating instructions in the disc's menu or on its jacket.

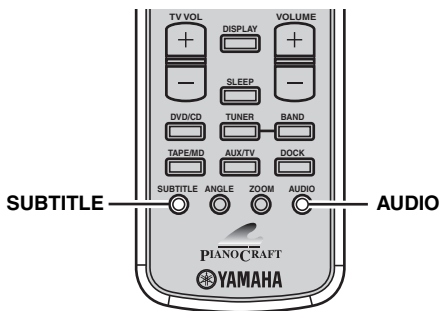

■ For DVD

To select an audio language while playing back a disc, press AUDIO repeatedly until the desired language appears on the TV screen.

To select a subtitle language while playing back a disc, press SUBTITLE repeatedly until the desired language appears on the TV screen.

■ For VCD

To switch the audio channel settings (stereo, monaural, etc.), press AUDIO repeatedly.



To turn off the subtitle, press SUBTITLE repeatedly to select "OFF".

Zooming the picture DVD VCD

You can zoom in or zoom out the picture during disc playback.

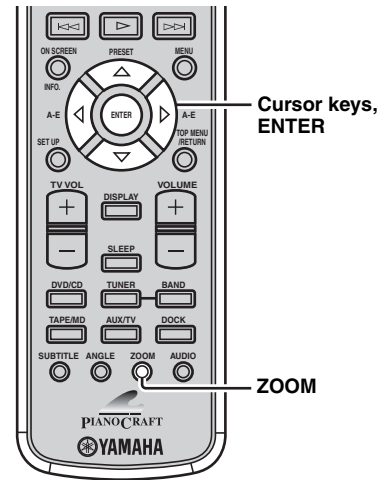

1 While playing back a disc, press ZOOM.

Each time you press the key, the picture scale changes as follows.

2X → 3X → 4X → 1/2 → 1/3 → 1/4 → original scale (1X)

2 If you select "2X", "3X" or "4X" in step 1, use the cursor keys to pan through the enlarged picture.



To return to the original picture scale, press ZOOM repeatedly to select the original scale.

Selecting a viewing angle DVD

You can select the desired viewing angle during DVD playback.

Note

This selection is available only with multi-angle compatible discs. Also, viewing angles available for each disc may vary. For information on your disc, refer to the operating instructions in the disc's menu or on its jacket.

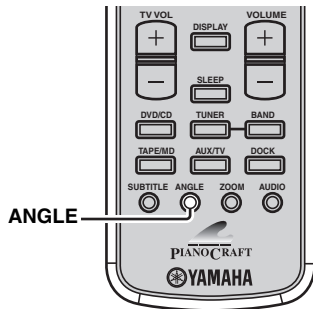

While playing back a disc, press **ANGLE** repeatedly until the desired viewing angle is selected.

Operating the disc menu

Many DVDs and VCDs (SVCDs) include original navigational menus called "DVD menu" and "Playback Control (PBC) menu". These menus provide a convenient way to operate the disc. Follow the procedure below to use those menus on the DVD player.

Note

Menu contents or operation method of each disc may vary. For information on your disc, refer to the operation instructions in the disc's menu or on its jacket.

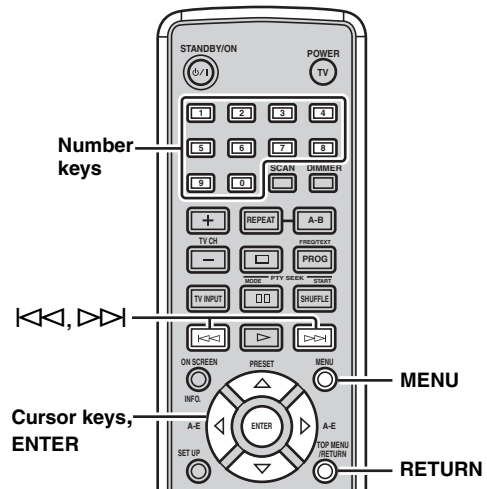

■ To operate the DVD menu DVD

1 While playing back a disc, press **MENU**.

The DVD menu of the disc appears on the TV screen.



Depending on the disc, the DVD menu may automatically appear after the disc is loaded.

2 Use the cursor keys to select a menu item, and then press **ENTER** to confirm the selection.

■ To operate the PBC menu VCD

If you load a VCD or SVCD that includes the Playback Control (PBC) feature (version 2.0 only), the PBC menu automatically appears on the TV screen. To operate the menu with the remote control, use the following keys.

Number keys or <<< / >>>: Selects an item.

RETURN: Returns to the menu screen.

MENU: Displays or closes the PBC menu.



If you set "PBC" to "OFF" in the setup menu of the DVD player (see page 55), the PBC menu does not appear automatically when a disc is loaded.

Playing back MP3/WMA/JPEG/DivX discs

You can play back MP3, WMA, and DivX format files recorded on a CD-R/RW, DVD+R/RW, and DVD-R/RW. Also you can view JPEG files in the commercially available JPEG discs (such as KODAK Picture CDs) or recorded on a CD-R/RW, DVD+R/RW, and DVD-R/RW.

Notes

- This unit cannot display special characters such as double-byte characters used for folder and file names.
- Depending on the disc format, characteristics, or recording conditions, the unit may not read or play back some discs properly. For information on disc compatibility of the DVD player, see page 63.
- If a disc contains a folder consisted of more than 500 files, the unit may not read or play back the disc properly.

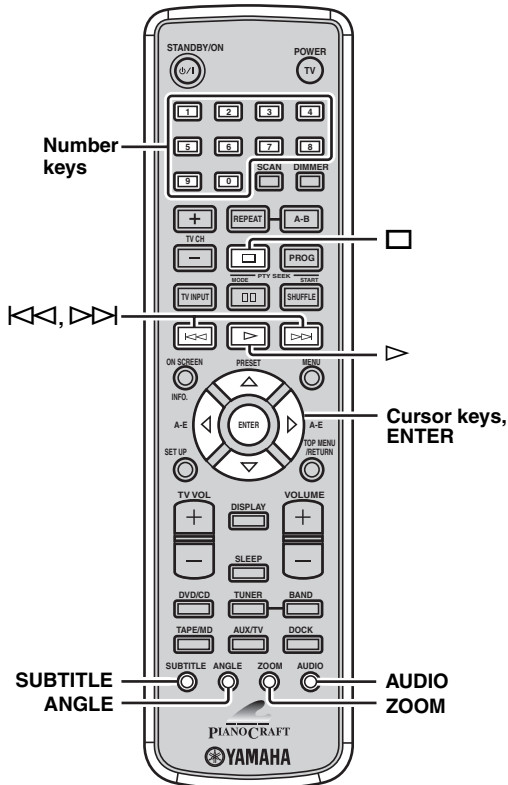

- 2 Press \triangle or ∇ to select a folder, and then press ENTER.

The file list of the selected folder appears on the TV screen.

- 3 Press \triangle , ∇ , or number keys to select a file, and then press ENTER.

Playback starts from the selected file to the end of the folder.



- While viewing a JPEG file, you can zoom in the picture by pressing ZOOM. Also, you can pan through the enlarged picture using the cursor keys.
- While viewing a JPEG file, you can flip the picture vertically by pressing \triangle or flip it horizontally by pressing ∇ . Also you can rotate it 90 degrees by pressing \triangleleft or \triangleright .
- While viewing a JPEG file, you can select a scan effect by pressing ANGLE repeatedly.

Viewing JPEG pictures in thumbnail form

You can view the JPEG files stored in the selected folder or the disc as small thumbnail images.

- 1 While viewing a JPEG disc, press \square .

The JPEG pictures appear in thumbnail form.

Pressing \triangleleft or \triangleright switches the thumbnail list to the previous/next page.



- 2 To view a specified picture in full size, use the cursor keys to select a thumbnail image, and then press ENTER.



- To start the slide show from the first picture of the current page, use the cursor keys to select \square , and then press ENTER.
- To return to the disc menu, press MENU.

- 1 Load a disc into the DVD player.

For MP3 and WMA discs, the disc menu appears. For JPEG discs, the disc menu appears on the TV screen. Press \triangleright to start the slide show (the slide show may start automatically with some commercially available JPEG discs). For a DivX disc, the interactive menu appears if the disc includes DivX Media Format (DMF). Refer to "About DivX Media Format (DMF)" for details. Otherwise, follow the steps below.

■ About DivX Media Format (DMF)

DivX Media Format (DMF) enables you to play back the DivX files with interactive features such as interactive menus, alternate audio and subtitles. Follow the procedure below to operate the interactive menu.

1 Load a disc into the DVD player.

The interactive menu appears on the TV screen.

2 Use the cursor keys to select a chapter.

3 Press ENTER or to start playback from the selected chapter.

To access the interactive menu during playback

Press MENU.

To return to the data disc menu when the disc menu is displayed

Press .



- You can select an audio or turn on/off the subtitle by pressing AUDIO or SUBTITLE during playback.
- To select an external subtitle language, you need to set "DIVX SUBTITLE" in the setup menu of the DVD player (see page 55).

Viewing or changing playback settings on the TV (OSD menu) DVD VCD

You can view and change the settings for the DVD or VCD (SVCD) currently played back.

Note

Displaying the OSD menu for a VCD or SVCD automatically closes the PBC menu (see page 31).

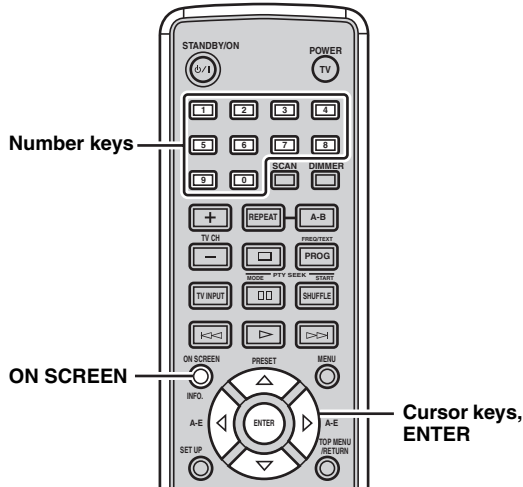

1 While playing back a disc, press ON SCREEN.

The OSD menu appears on the TV screen. The menu items vary depending on the disc type.



For CDs, each time you press ON SCREEN, the time display changes as follows: TOTAL ELAPSED → TOTAL REMAIN → SINGLE ELAPSED → SINGLE REMAIN.

2 To select a menu item, press \triangle or ∇ , and then press \triangleright .

3 To change the setting of the selected menu item, press \triangle or ∇ . To specify numbers or time, use the number keys.



To return to the previous menu, press \triangleleft . To exit from the OSD menu, press ON SCREEN.

■ OSD menu items

Items for DVD	Description
TITLE	The current title and the number of titles in the disc
CHAPTER	The current chapter and the number of chapters in the disc
AUDIO	The current settings for audio channels and audio language
SUBTITLE	The current setting for subtitle language
ANGLE	The current angle and the number of angles in the disc
TT TIME	The total time of the current title
CH TIME	The total time of the current chapter
REPEAT	The current setting for the Repeat Play feature
TIME DISP.	The current setting for the time display

Items for VCD/SVCD	Description
TRACK	The current track and the number of track in the disc
DISC TIME	The total time of the disc
TRACK TIME	The total time of the current track
REPEAT	The current setting for the Repeat Play feature
TIME DISP.	The current setting for the time display

Restricting Disc Playback

You can set playback restrictions for certain discs using the parental control or disc lock feature. Only users who know the password (see page 36) can access the locked discs.

Setting the parental control level

You can restrict playback according to a predetermined level (parental control level). For information on the parental control level of each disc, refer to the instruction on its jacket.

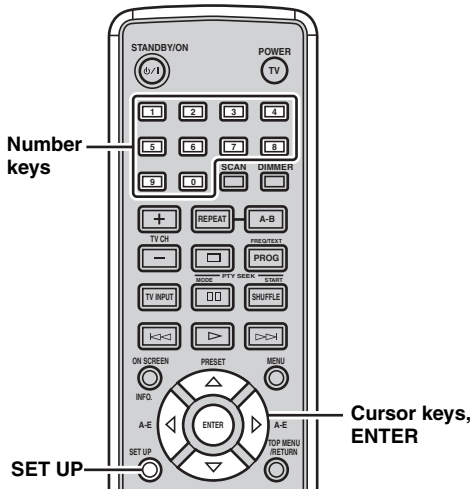

3 Press \triangle or ∇ to select a parental control level, and then press ENTER.

1 to 7: Users cannot play a disc that is rated above the level without entering the password. (The smaller the number, the stricter the Parental Control level.)

8 ADULT (Default setting): Users can play all discs without entering the password.

4 Press the number buttons to enter the 6-digit password, and then press ENTER.

Notes

- The default password is “000000”. To change the password, carry out the “Changing the password” procedure (see page 36).
- If you forget your password, enter “000000” instead of your password.



- To return to the previous menu, press \triangleleft . To exit from the setup menu, press SET UP.
- To unlock the parental control temporarily for playback, use the number keys to enter the password in the password input area (displayed when the locked disc is loaded), and then press ENTER.

1 Press SET UP.

2 Press \triangleleft or \triangleright to select “PREFERENCE PAGE”, press \triangle or ∇ to select “PARENTAL”, and then press \triangleright .

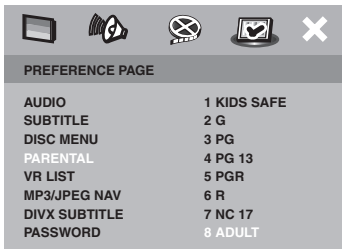

Note

“PREFERENCE PAGE” is available only when no disc is loaded or the DVD player is in the Stop mode (see page 25).

Locking a disc

You can prevent up to 40 specific discs from playback by locking the discs.

- 1** While the disc to be locked is loaded into the unit, press **SET UP**.
- 2** Press \triangleleft or \triangleright to select “GENERAL SETUP PAGE”, press \triangle or ∇ to select “DISC LOCK”, and then press \triangleright .
- 3** Press \triangle or ∇ to select “LOCK”, and then press **ENTER**.

To disable a lock applied to a disc

Select “UNLOCK” in step 3.



- To return to the previous menu, press \triangleleft . To exit from the setup menu, press **SET UP**.
- To unlock the disc lock temporarily for playback, use the number keys to enter the password in the password input area (displayed when the locked disc is loaded), and then press **ENTER**.

Changing the password

Follow the procedure below to change the password to access locked disc temporarily.

- 1** Press **SET UP**.
The setup menu appears on the TV screen.
- 2** Press \triangleleft or \triangleright to select “PREFERENCE PAGE”, press \triangle or ∇ to select “PASSWORD”, then press \triangleright .

Note

“PREFERENCE PAGE” is available only when no disc is loaded or the DVD player is in the Stop mode (see page 25).

- 3** Press **ENTER** to display the Password change screen.
- 4** Use the number keys to enter the current 6-digit password in the “OLD PASSWORD” area, enter the new 6-digit password in the “NEW PASSWORD” and “CONFIRM PWD” areas, then press **ENTER**.

Notes

- The default password is “000000”.
- If you forget your password, enter “000000” instead of your password.



To return to the previous menu, press \triangleleft . To exit from the setup menu, press **SET UP**.

FM/AM Tuning

There are 2 tuning methods: automatic and manual. Automatic tuning is effective when station signals are strong and there is no interference. If the signal from the station you want to select is weak, tune into it manually. You can also use the automatic and manual preset tuning features to store up to 40 stations (A1 to E8: 8 preset station numbers in each of the 5 preset station groups).

Automatic tuning

Automatic tuning is effective when station signals are strong and there is no interference.

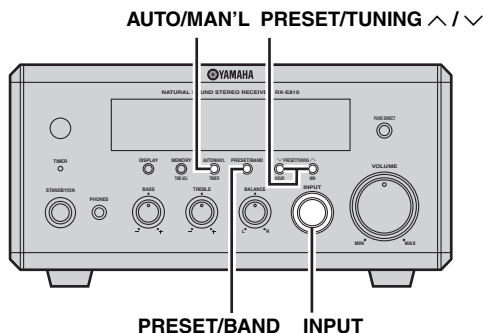

1 Rotate **INPUT** on the front panel of the receiver to select “TUNER” as an input source.

2 Press **PRESET/BAND** repeatedly to select “FM” or “AM”.



When the preset indicator lights up, the receiver is in the preset mode. For details, see pages 38 and 39.

3 Press **AUTO/MAN'L** so that the **AUTO** indicator lights up in the front panel display.

4 Press **PRESET/TUNING** \wedge / \vee to begin automatic tuning.

When the receiver is tuned into a station, the **TUNED** indicator lights up and the frequency of the received station is shown in the front panel display.

- Press \wedge to tune into a higher frequency.
- Press \vee to tune into a lower frequency.

Manual tuning

If the signal received from the station you want to select is weak, tune into it manually.

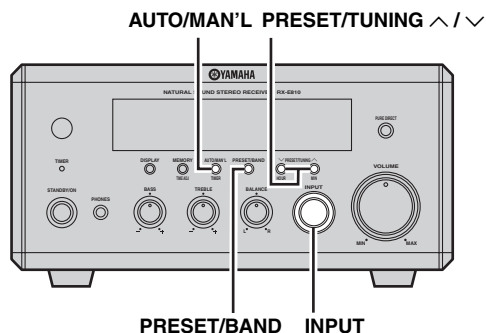

1 Rotate **INPUT** on the front panel of the receiver to select “TUNER” as an input source.

2 Press **PRESET/BAND** to select “FM” or “AM”.



When the preset indicator lights up, the receiver is in the preset mode. For details, see pages 38 and 39.

3 Press **AUTO/MAN'L** so that the **AUTO** indicator disappears from the front panel display.

4 Press **PRESET/TUNING** \wedge / \vee to tune into the desired station manually.

Hold down the button to continue searching.

■ To switch the frequency step (Asia and Taiwan models only)

Because the interstation frequency spacing differs in different areas, you may need to switch the frequency step mode.

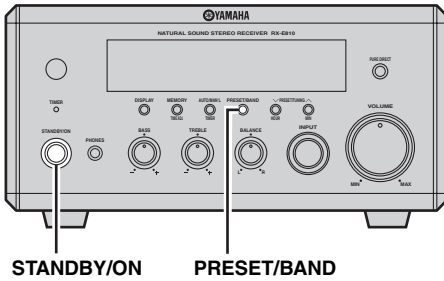

- 1 While the receiver is in the standby mode, hold down PRESET/BAND on the front panel, and then press STANDBY/ON.**
The receiver turns on.
- 2 Press PRESET/BAND repeatedly to select "FM 50k/AM 9k" or "FM 100k/AM 10k".**
- 3 To confirm the setting, press STANDBY/ON.**

Automatic preset tuning

Follow the procedure below to preset radio stations automatically.

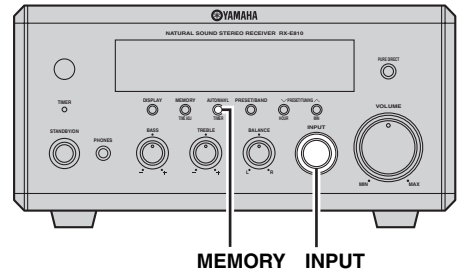

- 1 Rotate INPUT on the front panel of the receiver to select "TUNER" as an input source.**
- 2 Hold down MEMORY for more than two seconds.**
The AUTO and MEMORY indicator flash in the front panel display.
 - Auto Preset starts at the lowest frequency toward the highest frequency.
 - The receiver automatically applies a preset number to each detected station.

Notes

- You can preset up to 40 of AM and FM stations by automatic preset tuning.
- (U.K. and Europe models only)
Only Radio Data System broadcasting stations and AM stations are stored automatically by automatic preset tuning.

Manual preset tuning

You can also store up to 40 stations (A1 to E8: 8 preset station numbers in each of the 5 preset station groups) manually.

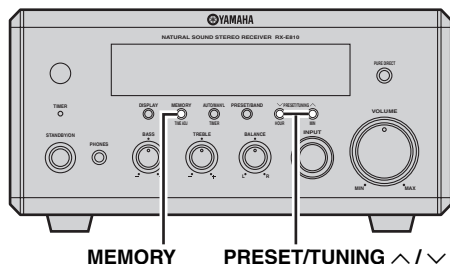

1 Tune into a radio station you want to preset.
See page 37 for tuning instructions.

2 Press MEMORY.
The MEMORY indicator flashes in the front panel display for about 5 seconds.

3 Hold down PRESET/TUNING ^ / v to select a preset station group (A to E) while the MEMORY indicator is flashing.

4 Press PRESET/TUNING ^ / v repeatedly to select a preset station number (1 to 8) while the MEMORY indicator is flashing.

5 Press MEMORY while the MEMORY indicator is flashing.
The PRESET and MEMORY indicators light up in the front panel display.

6 Repeat steps 1 to 5 until all desired stations are preset.

Selecting preset stations

You can tune into any desired station simply by selecting the preset station group and number under which it was stored (see page 38).

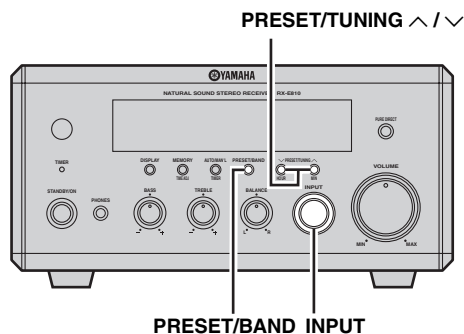

1 Rotate INPUT on the front panel of the receiver to select "TUNER" as an input source.

2 Press PRESET/BAND repeatedly so that the preset indicator lights up in the front panel display.

3 Hold down PRESET/TUNING ^ / v to select a preset station group (A to E), and then press PRESET/TUNING ^ / v repeatedly to select a preset station number (1 to 8).



You can also use the remote control to select preset stations. While the remote control is in the TUNER mode (see page 8), press BAND repeatedly to select "PRESET". To select a preset station group (A to E), press A-E ◀ / ▶ repeatedly. To select a preset station number (1 to 8), press PRESET ▲ / ▼ repeatedly or use the number keys (1 to 8).

Radio Data System Tuning (U.K. and Europe Models Only)

Radio Data System (U.K. and Europe models only) is a data transmission system used by FM stations in many countries. The Radio Data System function is carried out among the network stations. This unit can receive various Radio Data System data such as PS (program service), PTY (program type), RT (radio text), CT (clock time), and EON (enhanced other networks) when receiving Radio Data System broadcasting stations.

Selecting the Radio Data System program

Use this feature to select one of the 15 Radio Data System program types and search for all the available preset stations of the selected program type.

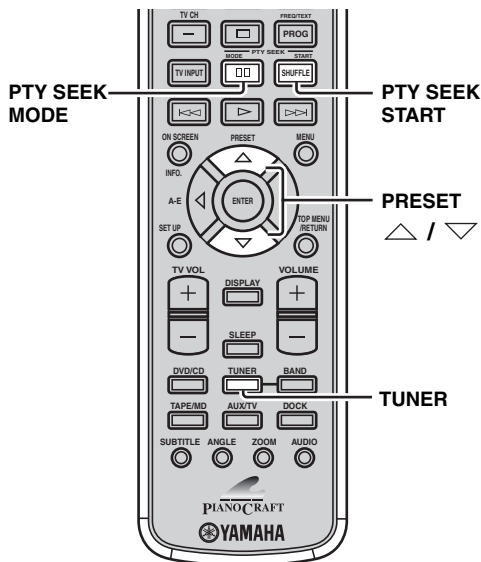

1 Set the receiver to the “FM” tuning mode.
See page 37 for tuning instructions.

2 Press PTY SEEK MODE to set the receiver to the PTY SEEK mode.

The PTY indicator and the name of the program type flash in the front panel display of the receiver.



- To cancel the PTY SEEK mode, press PTY SEEK MODE once again.
- The PTY SEEK mode is automatically cancelled if you do not operate any key for about 20 seconds.

3 Press PRESET \triangle / ∇ repeatedly to select the desired program type.

The name of the selected program type appears in the front panel display.

Program type	Descriptions
NEWS	News
AFFAIRS	Current affairs
INFO	General information
SPORT	Sports
EDUCATE	Education
DRAMA	Drama
CULTURE	Culture
SCIENCE	Science
VARIED	Light entertainment
POP M	Popular music
ROCK M	Rock music
M.O.R. M	Middle-of-the-road music (easy-listening)
LIGHT M	Light classics
CLASSICS	Serious classics
OTHER M	Other music

4 Press PTY SEEK START to start searching for available Radio Data System preset stations.

If a station broadcasting the selected program type is found, the receiver stops searching, and then program service name and the PTY HOLD indicator lights up in the front panel display.

If there is no station broadcasting the selected program type, the frequency currently selected appears.



To stop searching for stations, press PTY SEEK START once again.

5 Repeat step 4 until the desired station is found.

Displaying the Radio Data System information

Use this feature to display the 4 types of the Radio Data System information: PS (program service), PTY (program type), RT (radio text) and CT (clock time). The corresponding indicators light up in the front panel display.

Notes

- You can select one of the Radio Data System modes only when the corresponding Radio Data System indicator lights up in the front panel display. It may take a while for the receiver to receive all of the Radio Data System data from the station.
- You can select only the available Radio Data System modes being offered by the station.
- If the signals being received are not strong enough, the receiver may not be able to utilize the Radio Data System data. In particular, the "RT" mode requires a large amount of data and may not be available even when the other Radio Data System modes are available.
- In case of poor reception conditions, press AUTO/MAN'L on the front panel of the receiver so that the AUTO indicator disappears from the front panel display.
- If the signal strength is weakened by external interference while the receiver is receiving the Radio Data System data, the reception may be cut off unexpectedly and "...WAIT" appears in the front panel display.
- When the "RT" mode is selected, the receiver can display the program information by a maximum of 64 alphanumeric characters, including the umlaut symbol. Unavailable characters are displayed with the "_" (underscore).

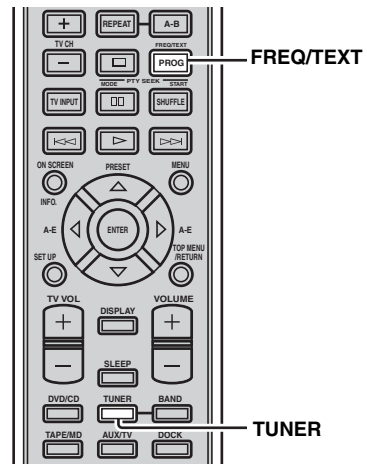

While tuning into a Radio Data System station, press FREQ/TEXT repeatedly to select the desired Radio Data System display mode.

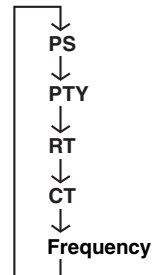

- Select "PS" to display the name of the Radio Data System program currently being received.
- Select "PTY" to display the type of the Radio Data System program currently being received.
- Select "RT" to display the information on the Radio Data System program currently being received.
- Select "CT" to display the current time.

■ Additional CT (clock time) settings

You can use CT information received from the Radio Data System stations to adjust the built-in clock of the receiver.

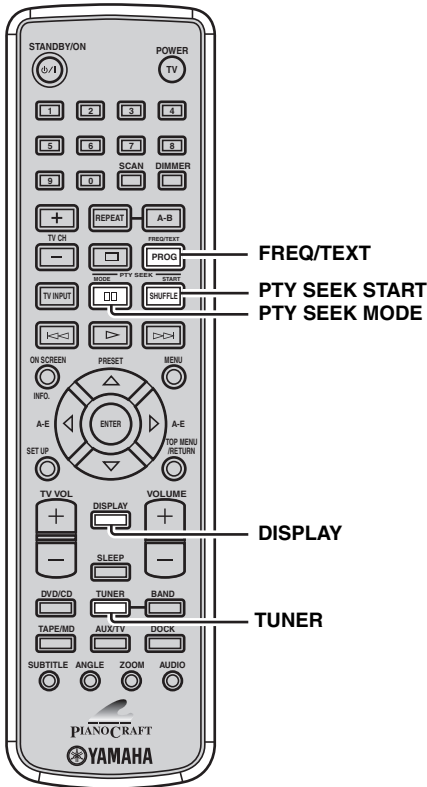

- 3 Press **PTY SEEK MODE** repeatedly to select “CT→Clock” or “Local CT”, and then press **PTY SEEK START** to switch the setting between “ON” and “OFF”.

CT→Clock

Set this to “ON” if you want to apply CT information received from the Radio Data System stations to the built-in clock of the receiver. (The default setting is “ON”.)

Local CT

Set this to “ON” if you want to apply the daylight saving time or summer time to CT information received from the Radio Data System stations. (The default setting is “ON”.)

- 4 Press **FREQ/TEXT** to confirm the settings.

- 1 While tuning into a Radio Data System station, press **DISPLAY** repeatedly so that the clock appears in the front panel display of the receiver.

- 2 Press **FREQ/TEXT** once.
“CT→Clock” appears in the front panel display.

Setting the Timer

The receiver is equipped with 2 types of timer functions: clock timer and sleep timer. The clock timer automatically turns the receiver on or sets it to the standby mode at the specified time. The sleep timer sets the receiver to the standby mode after the specified time elapses. The DVD player also turns on or sets to the standby mode automatically if it is connected to the receiver using a system control connection (see page 12).

Setting the clock timer

The clock timer automatically turns the receiver on or sets it to the standby mode at the specified time. You can also specify an input which the receiver automatically selects when the clock timer turns it on.

Notes

- You cannot set the clock timer unless you adjust the clock (see page 19).
- If you do not touch any key for more than 30 seconds after the previous key operation, the operations you made are cleared from the memory and the normal display reappears.

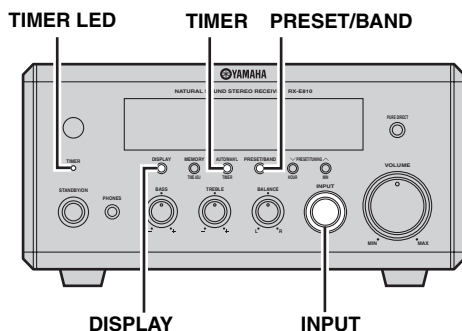

5 Press DISPLAY again to select “OFF Time”, and then specify the time when you want to turn off the receiver as well as step 4.

6 To turn off the receiver now with the clock timer set, press TIMER.

TIMER LED lights up. The receiver will be turned on or set to the standby mode automatically at the specified time.



If you want to turn off the receiver by “OFF Time”, press DISPLAY repeatedly to display the clock in the front panel display, and then press TIMER. The TIMER indicator lights up in the front panel display.

To set or cancel the clock timer

Press TIMER on the front panel while the clock is displayed or the receiver is in the standby mode.

1 Press DISPLAY on the front panel of the receiver repeatedly to select “Timer Input”.

The TIMER indicator flashes in the front panel display.

2 Rotate INPUT to select an input which the receiver automatically selects when the clock timer turns it on.

If you select “TUNER”, you can select a band by pressing PRESET/BAND. To select a preset station, carry out steps 2 and 3 in the “Selecting preset stations” procedure (see page 39).

3 Press DISPLAY again to select “ON Time”.

4 Specify the time when you want to turn on the receiver.

Carry out the steps 3 and 4 in “Step 2: Adjust the clock” (see page 19) to adjust the hour and minute settings.

Setting the sleep timer

The sleep timer sets the receiver to the standby mode after the specified time elapses.

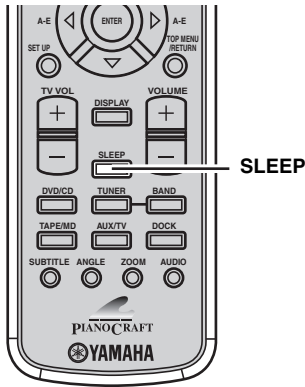

Press SLEEP repeatedly to select the desired duration.

Each time you press the key, the duration changes as follows.

The SLEEP indicator lights up in the front panel display.

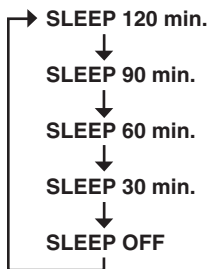

- The sleep timer is canceled if you set the receiver to the standby mode.
- If you press SLEEP once while the sleep timer is set, the ongoing duration appears in the front panel display.

To cancel the sleep timer

Press SLEEP repeatedly to select “SLEEP OFF”.

Setting the auto-standby mode

You can turn on/off the auto-standby feature which automatically set the system to the standby mode if you do not operate the system for 30 minutes while the receiver is set to the DVD/CD input mode. (The default setting is “AUTO STANDBY ON”.)

Notes

- Unless you connect the receiver and the DVD player properly with the supplied system control cable (see page 12), this feature does not function for the system.
- This feature does not function for the system during playback.

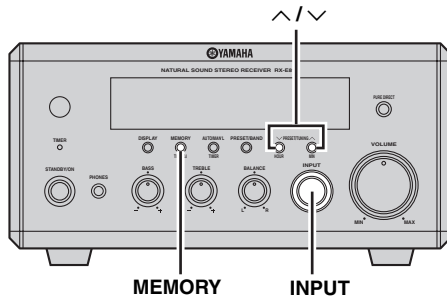

- 1 Rotate INPUT on the front panel of the receiver to select “DVD/CD” as an input source.**
- 2 Press MEMORY.**
The current setting appears in the receiver’s front panel display for about five seconds.
- 3 While the current setting is displayed in the front panel display, press ^ or v to switch between “AUTO STANDBY ON” or “AUTO STANDBY OFF”.**
- 4 Press MEMORY or wait for five seconds without any operation to confirm the setting.**

Controlling External Components

In addition to controlling the receiver (RX-E810) and DVD player (DVD-E810), you can operate the specific functions for external components made by YAMAHA or an iPod connected with a YAMAHA iPod universal dock (such as YDS-10 sold separately) using the supplied remote control. To control a TV made by other manufacturers, you need to set up the appropriate remote control code (see page 48).

Note

Depending on the product, the remote control may not be able to operate the external component. In this case, use the remote control supplied with the product.

Available operations

■ AUX/TV mode

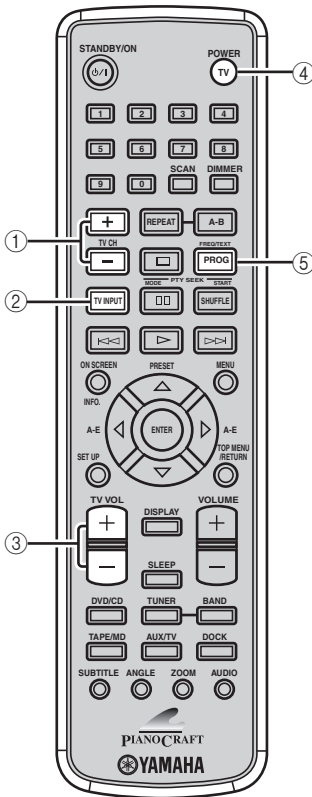

Operations available in AUX/TV mode

The following operations are available for the TV if you set up the appropriate remote control code (see page 48).



Press AUX/TV to set the remote control to the AUX/TV mode before carrying out the following operations.

- ① **TV CH +/-**
Switches the TV channels.
- ② **TV INPUT**
Switches the TV inputs.
- ③ **TV VOL +/-**
Adjusts the TV volume level.
- ④ **POWER TV**
Turns the TV on, or set it to the standby mode.
- ⑤ **PROG**
Use to set a remote control code.

■ DOCK mode

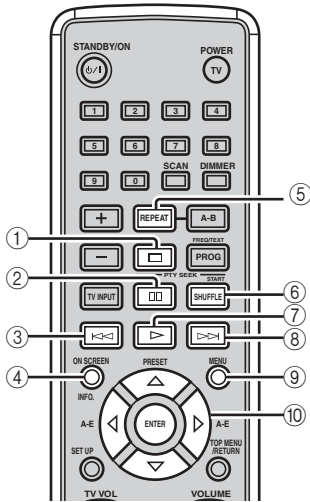

Operations available in DOCK mode

The following operations are available for the iPod connected with a YAMAHA iPod universal dock (such as YDS-10 sold separately). For details on iPod operations, see “Using iPod” on page 49.



Press DOCK to set the remote control to the DOCK mode before carrying out the following operations.

- ① Stops playback.
- ② Pauses playback.
- ③ Skips to the previous track. Press and hold to fast reverse.
- ④ **INFO.**
Switches between the simple remote mode and menu browse mode.
- ⑤ **REPEAT**
Selects the repeat playback mode during playback in the menu browse mode.
- ⑥ **SHUFFLE**
Selects the shuffle playback mode during playback in the menu browse mode.
- ⑦ Starts playback.
- ⑧ Skips to the next track. Press and hold to fast forward.
- ⑨ **MENU**
Returns to the upper level in the iPod menu.

⑩ Cursor keys (/ / /), ENTER

Press to return to the upper level in the iPod menu.
Press or to select an item in the selected group.
Press or ENTER to enter the selected group. (Pressing ENTER starts playback when a song is selected.)

■ TAPE mode

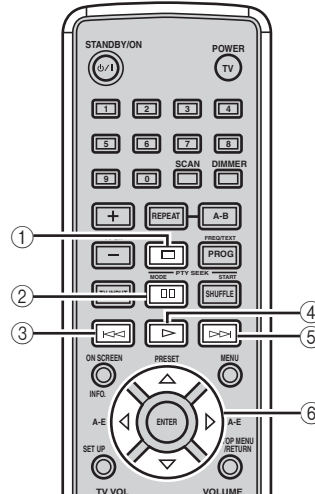

Operations available in TAPE mode

The following operations are available for the tape deck made by YAMAHA.



Press TAPE/MD to set the remote control to the TAPE mode before carrying out the following operations.

- ① Stops playback.
- ② Pauses recording.
- ③ Fast reverses.
- ④ Starts playback.
- ⑤ Fast forwards.
- ⑥ **Cursor keys (/ / /)**
Press to play back the front side of the tape, and to play back the back side.
Press to start recording on the tape deck.
Press to play back both sides of the tape in sequence.

Setting remote control codes

You can control TVs made by other manufactures by setting the appropriate remote control code (refer to “LIST OF REMOTE CONTROL CODES” at the end of this manual). Follow the procedures below to set the remote control code.

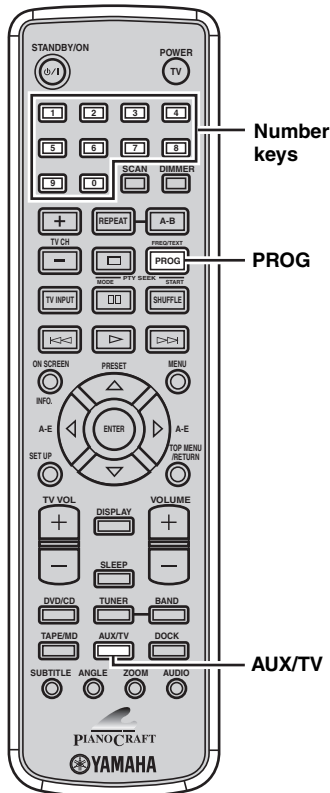

- 1 Press **AUX/TV** to set the remote control to the **AUX/TV mode**.
- 2 While holding down **PROG**, press **AUX/TV**, and then use the number keys to enter the three-digit remote control code (refer to “LIST OF REMOTE CONTROL CODES” at the end of this manual) for the manufacturer of your TV.
- 3 See “AUX/TV mode” on page 46 and try one of the key operations for your TV to check that the setting is working properly.
If the key operation does not work properly, the remote control code may be incorrect. In this case, perform step 2 again.

Notes

- Even if you set a remote control code, it will be cleared about two minutes after the remote control batteries run out. In this case, store remote control codes again after replacing the batteries. (Be careful not to press the remote control keys while replacing the batteries. Doing so may clear the settings.)
- If the manufacturer of your component has more than one code, try each of them until you find the correct one.

Using iPod

Once you have stationed your iPod in a YAMAHA iPod universal dock (such as YDS-10 sold separately) connected to the DOCK terminal of the receiver (see page 17), you can enjoy playback of your iPod using the supplied remote control. The operations of your iPod are available with the aid of the receiver's front panel display (menu browse mode) or without it (simple remote mode).

Notes

- Only iPod (Click and Wheel), iPod nano, and iPod mini are supported.
- Some features may not be compatible depending on the model or the software version of your iPod.



- For a complete list of the remote control functions used to control your iPod, refer to "DOCK mode" (see page 47).
- For a complete list of status messages that appear in the front panel display, refer to the "iPod" section in "Troubleshooting" (see page 60).

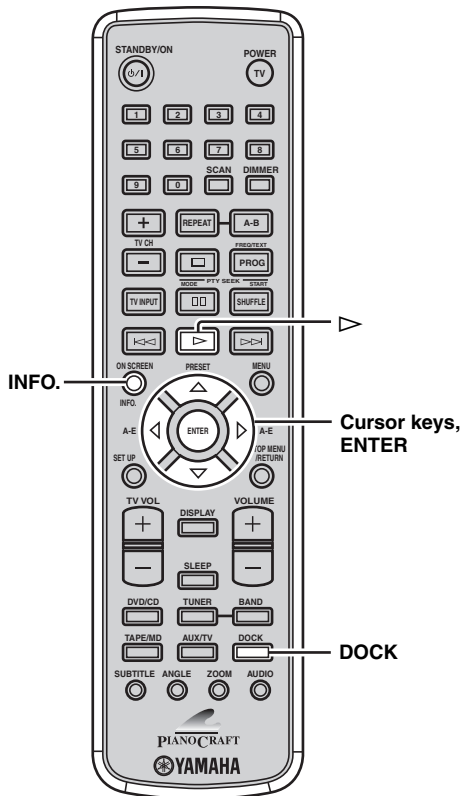

1 Press DOCK to select the iPod as the input source.

2 Press INFO. to switch between the simple remote mode and menu browse mode.

Simple remote mode

- View the screen of the iPod to control the menu.
- Operate the iPod using the iPod controls or the supplied remote control.

Menu browse mode

- View the front panel of the receiver to control the menu.
- Operate the iPod using the supplied remote control.
- You can configure the "Setup" parameters of the iPod.

3 Use the cursor keys to operate the iPod menu, and then press > to start playback of the selected song (or group).

For details on how to operate the iPod menu with the menu browse mode, refer to "Menu browse mode" (see page 50).



In the simple remote mode, you can also use the iPod controllers to operate the menu.

■ Menu browse mode

In the menu browse mode, you can operate the iPod menu using the receiver's front panel display. Also you can configure the "Setup" parameters with the menu browse mode.

Note

There are some characters that cannot be displayed in the front panel display of the receiver. Those characters are replaced with underscore "_".

iPod menu



1 Select the menu browse mode (see page 49).

The top of the iPod menu appears in the front panel display.



iPod operation indicators



The iPod operation indicators (see page 5) show the operable cursor keys in each step.

2 Press \triangle or ∇ to select the menu, and then press \triangleright or ENTER to enter the selected menu.

The name of the first item stored in the selected menu appears.

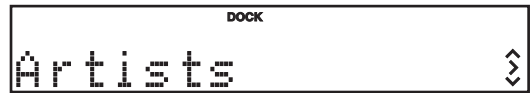

- The iPod menu indicators (see page 5) show the iPod menu currently selected.
- To return to the upper level in the iPod menu, press \triangleleft or MENU.

3 Repeat step 2 until you select the desired item, and then press \triangleright to start playback of the desired item (group or song).

If you select "Setup" in step 2, press \triangle or ∇ to select the desired setup menu, and then press ENTER repeatedly to configure the parameter.

Setup menu

Shuffle: Off, **Songs** (Shuffle Play by song), **Albums** (Shuffle Play by album)

Repeat: Off, **One** (Repeat Play by song), **ALL** (Repeat Play by selected group)

FL Scroll: **Cont** (Scrolls the song name continuously, default setting), **Once** (Scrolls the song name once)



While playing back a track (or group) with the menu browse mode, you can switch the playback information (such as song name, elapsed time, artist name, or album name) displayed in the front panel display by pressing \triangle or ∇ .

Configuring the DVD Player Settings (Setup Menu)

In the setup menu, you can configure the various parameters or operate useful functions related to the DVD player. Follow the procedure below to operate the setup menu. For details on each menu or available parameters, see “Setup menu items” on page 52.

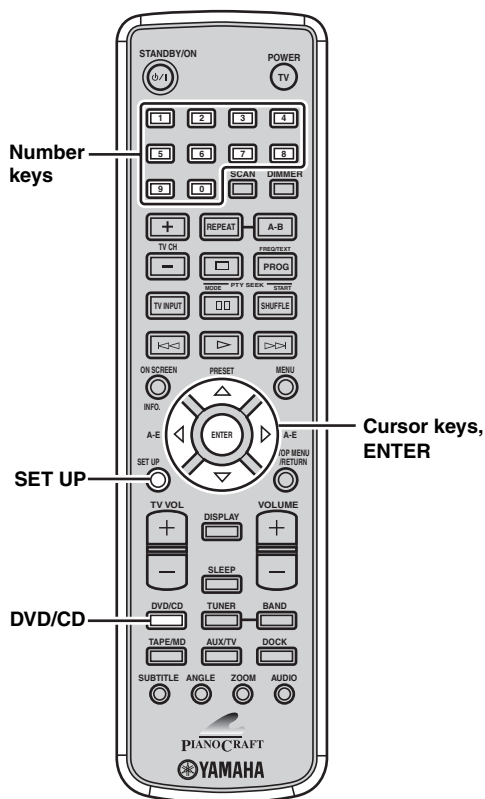

1 Press DVD/CD to set the remote control to the DVD/CD mode.

2 Press SET UP.

The setup menu appears on the TV screen.

3 Press ◀ or ▶ to select “GENERAL SETUP PAGE”, “AUDIO SETUP PAGE”, “VIDEO SETUP PAGE” or “PREFERENCE PAGE”.

Note

“PREFERENCE PAGE” is available only when no disc is loaded or the the DVD player is in the Stop mode (see page 25).

4 Press ▲ or ▼ to select the desired menu, and then press ▶.

If the selected menu contains one submenu, press ENTER.

If the selected menu contains two or more submenus, press ▲ or ▼ to select the desired submenu, and then press ENTER.

5 Press ▲ or ▼ to select the desired parameter, and then press ENTER.

For configuring some parameters, you need to enter the password by pressing the number keys.



To return to the previous menu, press ◀. To exit from the setup menu, press SET UP.

Setup menu items

The following table explains details on the setup menu items of the DVD player. For instructions on operating the setup menu, see “Configuring the DVD Player Settings (Setup Menu)” on page 51.

Page	Menu	Submenu	Parameter
GENERAL SETUP PAGE	DISC LOCK		See page 36 for details. (Default: UNLOCK)
	PROGRAM	INPUT MENU	See page 29 for details.
	OSD LANGUAGE		See page 20 for details. (Default: ENGLISH)
	SCREEN SAVER		The screen saver function allows you to prevent the TV screen from burn-in. (Default: ON) ON: Turns on the screen saver when disc playback is stopped or paused for more than 15 minutes. OFF: Disables the screen saver function.
	DIVX(R) VOD CODE		You can display the DivX® VOD (Video On Demand) registration code that allows you to rent or purchase videos using the DivX® VOD service. For more information, visit the website at www.divx.com/vod .
AUDIO SETUP PAGE	ANALOG OUTPUT		You can configure the analog output setting. (Default: STEREO) STEREO: Delivers sounds from only the two front speaker channels. LT/RT: Delivers sounds from the multi speaker channels if the DVD player is connected to a Dolby Pro Logic decoder using an analog connection. VIRTUAL SURR: Reproduces the surround channel sounds virtually.
	DIGITAL AUDIO	DIGITAL OUTPUT	You can configure the digital output setting according to your optional audio equipment connections. (Default: ALL) OFF: Disables the digital output. ALL: Select this if you connect the DVD player to a multi-channel decoder/amplifier using a digital connection. PCM ONLY: Select this if your amplifier is not capable of decoding multi-channel audio.
		LPCM OUTPUT	If you connect the DVD player to a PCM compatible amplifier using a digital connection, configure the LPCM output setting. The higher the sampling rate, the better the sound quality. (Default: 48KHz) 48KHz: Plays back a disc recorded at the sampling rate of 48 kHz. 96KHz: Plays back a disc recorded at the sampling rate of 96 kHz.

Page	Menu	Submenu	Parameter
AUDIO SETUP PAGE	CD UPSAMPLING *1		You can convert your music CD to a higher sampling rate using sophisticated digital signal processing for better sound quality. If you have activated the upsampling, the DVD player will automatically switch to the stereo mode. (Default: OFF) OFF: Disables the CD upsampling function. 88.2kHz (X2): Converts the sampling rate of the CDs twice higher than original. 176.4kHz (X4): Converts the sampling rate of the CDs four times higher than original.
			You can soften the high volume output and enhance the low volume output to an audible level. This setting is effective only when a Dolby Digital 2-channel source is played back. (Default: OFF) ON: Enables the night mode. OFF: Disables the night mode.
			You can adjust the delay time (00 to 200 ms) for the sound output in order to synchronize it with video image. (Press ◀ or ▶ to adjust the delay time and then press ENTER to confirm adjustment.) (Default: 00 ms)
VIDEO SETUP PAGE *2	TV TYPE *3		You can set the color system of the DVD player according to the TV. (Default: NTSC for U.S.A. and Canada models, MULTI for Korea model, and PAL for other models) PAL: Select this if the TV connected to the DVD player adopts the PAL system. NTSC: Select this if the TV connected to the DVD player adopts the NTSC system. MULTI: Select this if the TV connected to the DVD player is compatible with both PAL and NTSC (such as a multi-system TV).
			You can set the aspect ratio of the DVD player according to the TV. When the selected format is not available on the disc, this setting will not affect the disc playback. (Default: 4:3 PAN SCAN) 4:3 PAN SCAN: Select this if you have a normal TV and want both sides of the picture to be trimmed or formatted to fit your TV screen. 4:3 LETTER BOX: Select this if you have a normal TV. In this case, a wide picture with black bands on the upper and lower portions of the TV screen will be displayed. 16:9: Select this if you have a wide-screen TV.

*1 "CD UPSAMPLING" is available only when a music CD is loaded in the DVD player.

*2 The video settings of your TV also affect the display image. Make sure you configure the video settings of your TV as well as these settings.

*3 If the picture is distorted on your TV, the color system (NTSC and PAL) setting of the DVD player may not match your TV. To switch the color system setting in such case, press ▶ and then AUDIO while the disc tray is open.

Page	Menu	Submenu	Parameter
VIDEO SETUP PAGE *2	PROGRESSIVE *4		When connecting the DVD player to a progressive scan compatible TV using a component video connection, you can enjoy high-quality DVD video with the progressive scan mode. (Default: OFF) ON: Enables the progressive scan. OFF: Disables the progressive scan.
		PICTURE SETTING	You can select the picture color setting from three predefined sets or configure in detail. (Default: STANDARD) STANDARD: Uses standard TV picture settings. BRIGHT: Makes the TV picture brighter. SOFT: Makes the TV picture softer. PERSONAL: You can adjust Brightness, Contrast, Tint and Color (saturation) individually. (Press \triangle or ∇ to select an item, press \triangleleft or \triangleright to adjust the parameter, then press ENTER to confirm the adjustment.)
	COMPONENT (U.K. and Europe models only)	You can switch the jack (terminal) at which the component video signals are output between the COMPONENT jacks and AV terminal. (Default: RGB) YUV: Select this if you connect the TV to the COMPONENT jacks. RGB: Select this if you connect the TV to the AV terminal (scart).	
	BLACK LEVEL (U.S.A. and Canada models only)	You can set the black level to improve color contrast during disc playback. This setting is effective only when "TV TYPE" is set to "NTSC". (Default: OFF) ON: Select this to enhance the black level. OFF: Select this for the standard black level setting.	
	CLOSED CAPTION (U.S.A. and Canada models only)	Closed captions are data hidden in the video signals of specific discs, and are invisible without the use of a special decoder. The difference between subtitles and captions is that subtitles are intended for hearing persons and captions are for the hearing impaired. Subtitles rarely show all of the audio. For example, captions show sound effects (e.g., "phone ringing" and "footsteps"), while subtitles do not. Before you select this function, please ensure that the disc contains closed caption information and your TV set also supports this function. (Default: OFF) ON: Enables the closed caption function. OFF: Disables the closed caption function.	

*2 The video settings of your TV also affect the display image. Make sure you configure the video settings of your TV as well as these settings.

*4 The progressive scan mode is only available if you connect the player to a progressive scan compatible TV using a component video connection. For U.K. and Europe models, "PROGRESSIVE" is available only when you connect a TV with a component video connection and "COMPONENT" is set to "YUV".

To set this parameter to "OFF" without using the Setup menu, open the disk tray, press \triangleleft on the remote control and then press ANGLE.

Page	Menu	Submenu	Parameter
PREFERENCE PAGE *5	AUDIO		See page 21 for details. (Default: ENGLISH)
	SUBTITLE		See page 21 for details. (Default: OFF)
	DISC MENU		See page 21 for details. (Default: ENGLISH)
	PARENTAL		See page 35 for details. (Default: 8 ADULT)
	VR LIST		You can select the original list or play list used for playback of VR (Video Recording) format discs. (Default: ORIGINAL LIST) ORIGINAL LIST: Select this to play the originally recorded titles on the disc. PLAY LIST: Select this to play the edited version of the disc. (This feature is available only when a play list has been created.)
	MP3/JPEG NAV		You can enable or disable the navigator menu function when an MP3 disc or JPEG disc includes the menu. (Default: WITH MENU) WITHOUT MENU: Displays all the files contained in the MP3 disc or JPEG disc. WITH MENU: Displays only the folder menu of the MP3 disc or JPEG disc.
	DIVX SUBTITLE *6		You can select a language group to assign the desired font sets used as external subtitles for DivX files. (Default: GROUP1) GROUP1: Albanian, Basque, Catalan, Danish, Dutch, English, Faroese, Finnish, French, German, Icelandic, Irish, Italian, Norwegian, Portuguese, Rhaeto-Romanic, Scottish, Spanish, Swedish GROUP2: Albanian, Croatian, Czech, Hungarian, Polish, Romanian, Slovak, Slovenian GROUP3: Bulgarian, Byelorussian, Macedonian, Russian, Serbian, Ukrainian GROUP4: Hebrew, Yiddish GROUP5: Turkish
	PASSWORD	CHANGE	See page 36 for details.
	PBC		You can enable or disable the auto-display function of the playback control (PBC) menu for VCDs and SVCDs. (Default: ON) ON: Displays the PBC menu automatically when a disc is played back. OFF: Starts playback of a disc without displaying the PBC menu.
	DEFAULT	RESET	See page 56 for details.

*5 "PREFERENCE PAGE" is available only when no disc is loaded or the DVD player is in the stop mode (see page 25).

*6 The file names of the DivX movie and external subtitle should be identical (except extensions). The file extensions supported for external subtitles are ".srt", ".sub", ".ssa", and ".smi". Some external subtitles may be displayed incorrectly depending on the disc characteristics or recording conditions.

Notes

- Consumers should note that not all high definition television sets are fully compatible with this DVD player and may cause artifacts to be displayed in the picture. In case of 525 or 625 progressive scan picture problems, it is recommended that the user switches the connection to the "Standard Definition" output. If there are questions regarding your video monitor compatibility with this DVD player, please contact our customer service center.
- The DVD player is compatible with the complete line of YAMAHA products, including the projectors DPX-1300, DPX-830 and the plasma monitor PDM-4220.

Resetting the DVD player settings

You can reset all options and your personal settings to the initial factory settings, except your password for “PARENTAL” and “DISC LOCK”.

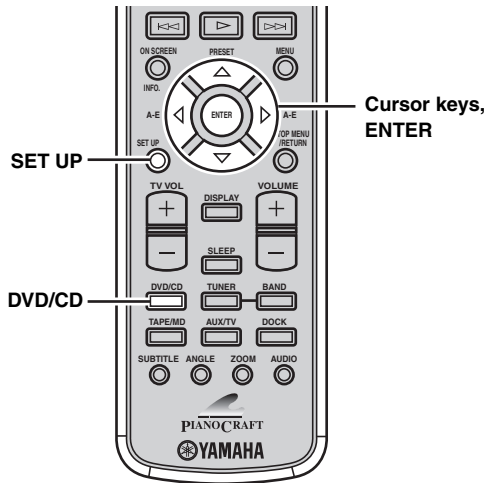

1 Press DVD/CD to set the remote control to the DVD/CD mode.

2 Press SET UP.
The setup menu appears on the TV screen.

3 Press ◀ or ▶ to select “PREFERENCE PAGE”.

Note

“PREFERENCE PAGE” is available only when no disc is loaded or the the DVD player is in the Stop mode (see page 25).

4 Press ▲ or ▼ to select “DEFAULT”, and then press ▶ to select “RESET”.

5 Press ENTER to reset the settings.
All DVD player settings (except password) are reset to the initial factory settings.

Language Codes

If your desired language for “AUDIO”, “SUBTITLE” and “DISC MENU” is not listed in the setup menu (see page 21), select “OTHERS”, then enter the 4-digit language code for your desired language.

Abkhazian	6566	Khmer	7577	Somali	8379
Afar	6565	Kikuyu; Gikuyu	7573	Sotho, Southern	8384
Afrikaans	6570	Kinyarwanda	8287	South Ndebele	7882
Albanian	8381	Kirghiz	7589	Spanish; Castilian	6983
Amharic	6577	Komi	7586	Sundanese	8385
Arabic	6582	Korean	7579	Swahili	8387
Armenian	7289	Kuanyama; Kwanyama	7574	Swati	8383
Assamese	6583	Kurdish	7585	Swedish	8386
Avestan	6569	Kwanyama; Kuanyama	7574	Tagalog	8476
Aymara	6589	Lao	7679	Tahitian	8489
Azerbaijani	6590	Latin	7665	Tajik	8471
Bashkir	6665	Latvian	7686	Tamil	8465
Basque	6985	Letzeburgesch;	7666	Tatar	8484
Belarusian	6669	Limburgan; Limburger	7673	Telugu	8469
Bengali	6678	Limburger; Limburgan	7673	Thai	8472
Bihari	6672	Lingala	7678	Tibetan	6679
Bislama	6673	Lithuanian	7684	Tigrinya	8473
Bokmål, Norwegian	7866	Luxembourgish	7666	Tonga (Tonga Islands)	8479
Bosnian	6683	Macedonian	7775	Tsonga	8483
Breton	6682	Malagasy	7771	Tswana	8478
Bulgarian	6671	Malay	7783	Turkish	8482
Burmese	7789	Malayalam	7776	Turkmen	8475
Castilian, Spanish	6983	Maltese	7784	Twi	8487
Catalan	6765	Manx	7186	Uighur	8571
Chamorro	6772	Maori	7773	Ukrainian	8575
Chechen	6769	Marathi	7782	Urdu	8582
Chewa; Chichewa; Nyanja	7889	Marshallese	7772	Uzbek	8590
Chichewa; Chewa; Nyanja	7889	Moldavian	7779	Vietnamese	8673
Chinese	9072	Mongolian	7778	Volapük	8679
Chuang; Zhuang	9065	Nauru	7865	Walloon	8765
Church Slavonic; Slavonic	6785	Navaho, Navajo	7886	Welsh	6789
Church Slavonic; Church	6785	Navajo; Navaho	7886	Wolof	8779
Chuvash	6786	Ndebele, North	7868	Xhosa	8872
Cornish	7587	Ndebele, South	7882	Yiddish	8973
Corsican	6779	Ndonga	7871	Yoruba	8979
Czech	6783	Nepali	7869	Zhuang; Chuang	9065
Danish	6865	North Ndebele	7868	Zulu	9085
Dutch	7876	Northern Sami	8369		
Dzongkha	6890	Norwegian	7879		
English	6978	Norwegian Bokmål; Bokmål	7866		
Esperanto	6979	Norwegian Nynorsk	7878		
Estonian	6984	Nyanja; Chichewa; Chewa	7889		
Faroese	7079	Nynorsk, Norwegian	7878		
Fijian	7074	Occitan; Provençal	7967		
Finnish	7073	Old Bulgarian; Old Slavonic	6785		
French	7082	Old Slavonic; Old Bulgarian	6785		
Frisian	7089	Oriya	7982		
Gaelic; Scottish Gaelic	7168	Oromo	7977		
Gallegan	7176	Ossetian; Ossetic	7983		
Georgian	7565	Ossetic; Ossetian	7983		
German	6869	Pali	8073		
Gikuyu; Kikuyu	7573	Panjabi	8065		
Greek	6976	Persian	7065		
Guarani	7178	Polish	8076		
Gujarati	7185	Portuguese	8084		
Hausa	7265	Provençal; Occitan (post)	7967		
Hebrew	7269	Pushto	8083		
Herero	7290	Quechua	8185		
Hindi	7273	Raeto-Romance	8277		
Hiri Motu	7279	Romanian	8279		
Hungarian	7285	Rundi	8278		
Icelandic	7383	Russian	8285		
Ido	7379	Samoan	8377		
Interlingua (International)	7365	Sango	8371		
Inuktitut	7385	Sanskrit	8365		
Inupiaq	7375	Sardinian	8367		
Irish	7165	Scottish Gaelic; Gaelic	7168		
Italian	7384	Serbian	8382		
Japanese	7465	Shona	8378		
Javanese	7486	Sindhi	8368		
Kalaallisut	7576	Sinhalese	8373		
Kannada	7578	Slavonic; Church Slavonic	6785		
Kashmiri	7583	Slovak	8375		
Kazakh	7575	Slovenian	8376		

Troubleshooting

Refer to the table below when this unit does not function properly. If the problem you are experiencing is not listed below or if the instruction below does not help, turn off this unit, disconnect the power cable, and contact the nearest authorized YAMAHA dealer or service center.

Receiver (RX-E810)

■ General

Problem	Cause	Remedy	See page
The receiver fails to turn on or enters the standby mode soon after the power is turned on.	The power cable is not connected or the plug is not completely inserted.	Connect the power cable firmly.	18
	The receiver has been exposed to a strong external electric shock (such as lightning or strong static electricity).	Set the receiver to the standby mode, disconnect the power cable, plug it back in after 30 seconds and then use it normally.	—
No sound	Incorrect input or output cable connections.	Connect the cables properly. If the problem persists, the cables may be defective.	12
	No appropriate input source has been selected.	Select an appropriate input source with the INPUT selector on the front panel (or the input selection keys on the remote control).	—
	Speaker connections are not secure.	Secure the connections.	13
	The volume is turned down.	Turn up the volume.	—
	Signals the receiver cannot reproduce are being input from a source component, such as a CD-ROM.	Play a source whose signals can be reproduced by the receiver.	—
The sound suddenly goes off.	The timer has turned off the receiver.	Turn on the receiver, and play the source again.	—
Sound is heard from the speaker on one side only.	Incorrect cable connections.	Connect the cables properly. If the problem persists, the cables may be defective.	13
There is noise interference from digital or radio frequency equipment.	The receiver is too close to the digital or high-frequency equipment.	Move the receiver further away from such equipment.	—

■ Tuner

	Problem	Cause	Remedy	See page
FM	FM stereo reception is noisy.	The characteristics of FM stereo broadcasts may cause this problem when the transmitter is too far away or the antenna input is poor.	Check the antenna connections.	15
			Try using a high-quality directional FM antenna.	—
			Use the manual tuning method.	37
	There is distortion, and clear reception cannot be obtained even with a good FM antenna.	There is multi-path interference.	Adjust the antenna position to eliminate multi-path interference.	—
	The desired station cannot be tuned into with the automatic tuning method.	The signal is too weak.	Use a high-quality directional FM antenna.	—
			Use the manual tuning method.	37
	Previously preset stations can no longer be tuned into.	The receiver has been disconnected for a long period.	Set preset stations	38
AM	The desired station cannot be tuned into with the automatic tuning method.	The signal is weak or the antenna connections are loose.	Tighten the AM loop antenna connections and orient it for the best reception.	15
			Use the manual tuning method.	37
	There are continuous crackling and hissing noises.	Noises result from lightning, fluorescent lamps, motors, thermostats and other electrical equipment.	Use an outdoor antenna and a ground wire. This will help somewhat, but it is difficult to eliminate all noise.	—
	There are buzzing and whining noises.	A TV set is being used nearby.	Move the receiver away from the TV set.	—

■ iPod

Note

In case of a transmission error without a status message appearing in the front panel and in the OSD, check the connection to your iPod (see page 17).

Status message	Cause	Remedy	See page
Loading...	<p>The receiver is in the middle of recognizing the connection with your iPod.</p> <hr/> <p>The receiver is in the middle of acquiring song lists from your iPod.</p>		
Connect error	There is a problem with the signal path from your iPod to the receiver.	<p>Turn off the receiver and reconnect the YAMAHA iPod universal dock to the DOCK terminal of the receiver.</p> <hr/> <p>Try resetting your iPod.</p>	<p>17</p> <hr/> <p>—</p>
Unknown type	The iPod being used is not supported by the receiver.	Only iPod (Click and Wheel), iPod nano, and iPod mini are supported.	—
iPod connected	Your iPod is properly stationed in a YAMAHA iPod universal dock (such as YDS-10 sold separately) connected to the DOCK terminal of the receiver, and the connection between your iPod and the receiver is complete.		
Disconnected	Your iPod was removed from a YAMAHA iPod universal dock (such as YDS-10 sold separately) connected to the DOCK terminal of the receiver.	Station your iPod back in a YAMAHA iPod universal dock (such as YDS-10 sold separately) connected to the DOCK terminal of the receiver.	17
Unable to play	The receiver cannot play back the songs currently stored on your iPod.	<p>Check that the songs currently stored on your iPod are playable.</p> <hr/> <p>Store some other playable music files on your iPod.</p>	<p>—</p> <hr/> <p>—</p>

DVD player (DVD-E810)

Problem	Cause	Remedy	See page
Power turns on but immediately shuts off.	The power cable is not connected or the plug is not completely inserted.	Connect the power cable firmly.	18
Power immediately shuts off during playback.	Auto-standby function of the receiver works when the receiver can not receive the playing signal transmitted from the DVD player with the system control cable for 30 minutes.	Check the connection of the system control cable between the receiver and the DVD player.	12
The TV (monitor) does not show the picture properly.	The component video signal output setting may not match the video connection.	Set "COMPONENT" of the DVD player to match the connection method.	54
	The color system setting of the DVD player may not match the specification of your TV.	Check that the color system of your TV, and then set "TV TYPE" of the DVD player to match it.	53
	The progressive scan mode may be used with a TV that does not support it.	Set "PROGRESSIVE" to "OFF".	54
	The disc being played back may not be compatible with the DVD player.	Check that the disc is compatible with the DVD player.	63
The screen size of the TV or monitor looks strange (the image is distorted or the subtitle is missing).	Occasionally, a small amount of picture distortion may appear depending on the disc being played back. This is not a malfunction.		
	The TV size setting of the DVD player to match the connection method.	Set "TV DISPLAY" of the DVD player to match your TV, or check the screen size setting of your TV.	53
No sound or distorted sound	When the progressive scan mode is activated, image with a 4:3 aspect ratio are played back on a 16:9 wide television screen.	Set "TV DISPLAY" of the DVD player to adjust the screen size. If you cannot adjust it, set "PROGRESSIVE" to "OFF".	53
	The sampling rate of a MP3 or WMA file may not be compatible with the DVD player.	Check the sampling rate and bit rate of an MP3 or WMA file are compatible with the DVD player.	63
No audio at digital output	Incorrect digital cable connections.	Connect the digital cables properly.	16
	The disc being played back may not be compatible with the DVD player.	Check that the disc is compatible with the DVD player.	63
	The digital output settings of the DVD player may not be set properly.	Set "DIGITAL OUTPUT" of the DVD player according to your external audio equipment connections.	52

Problem	Cause	Remedy	See page
Disc playback does not start.	You may use a CD-R/RW, DVD+R/RW or DVD-R/RW that is not finalized.	Finalize the CD-R/RW, DVD+R/RW or DVD-R/RW.	—
	The disc label may not be facing up.	Check that the disc label is facing up.	—
	The disc may be defective.	Try to play back another disc. If the same problem does not happen, the disc you want to play back is defective.	—
	JPEG or MP3/ WMA disc may not contain sufficient picture files or music tracks to be played back.	Check that your JPEG or MP3/ WMA disc contains at least 10 JPEG picture files or 5 MP3/WMA music files.	—
	For MP3/WMA files, the sampling rate and bit rate may not be compatible. For JPEG files, the resolution may not be compatible.	For MP3/WMA files, check that the sampling rate and bit rate are compatible. For JPEG files, check that the resolution is compatible.	63
	The region code of the disc may not be supported with the DVD player.	Check the region code.	63
Picture freezes momentarily during playback.	The disc may be dirty.	Check the disc for fingerprints/scratches and clean it with a soft cloth wiping from center to edge.	64
The DVD player does not read CDs and DVDs.	The disc lens may be dirty.	Use a lens cleaner to clean the lens.	64
Unable to turn on or off a progressive scan	The component video signal output setting may not match the video connection.	Set “COMPONENT” of the DVD player to match the connection method.	54
No sound during DivX movie playback	The audio code may not be supported with the DVD player.		

Remote control

Problem	Cause	Remedy	See page
The remote control does not work nor function properly.	Wrong distance or angle.	The remote control functions within a maximum range of 6 m (20 ft) and no more than 30 degrees off-axis from the front panel.	11
	Direct sunlight or lighting (from an inverter type of fluorescent lamp, etc.) is striking the remote control sensor of this unit.	Reposition this system.	—
	The batteries are weak.	Replace all batteries.	11
	The remote control code is not correctly set.	Set the remote control code correctly using “LIST OF REMOTE CONTROL CODES” at the end of this manual.	48
		Try setting another code for the same manufacturer using “LIST OF REMOTE CONTROL CODES” at the end of this manual.	48
	Even if the remote control code is correctly set, there are some models that do not respond to the remote control.		

Notes on Discs

Disc information

The following tables explain the disc types supported by the DVD player.

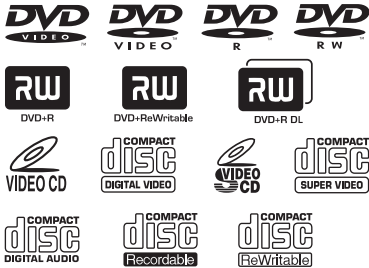

Disc logo marks are printed on the disc and the disc jacket.

Note

Do not load any other type of disc into the DVD player. Doing so may damage the DVD player.

The DVD player can play:

- DVD+R/RW and DVD-R/RW discs recorded in DVD-Video compatible format.
- DVD-RW discs recorded in VR format (compatible with CPRM).

The DVD player can play the following data discs (For MP3 and WMA files, the parenthetic words represent the compatible sampling rate and bit rate):

- MP3 files, recorded on CD-R/RW, DVD+R/RW and DVD-R/RW (fs 32, 44.1, 48 kHz/96-320 kbps (CBR only))
- WMA files, recorded on CD-R/RW, DVD+R/RW and DVD-R/RW (When in fs 44.1 kHz: 64-192 kbps/When in 48 kHz: 128-192 kbps (CBR only))
- JPEG (except progressive JPEG) files, recorded on CD-R/RW, DVD+R/RW and DVD-R/RW (compatible resolution: 3072 x 2048 or less)
- DivX Video files, recorded on CD-R/RW, DVD+R/RW and DVD-R/RW
- KODAK Picture CD
- FUJICOLOR CD
- Official DivX® Ultra Certified product
- Plays all version of DivX® video (including DivX® 6) with enhanced playback of DivX® media files and the DivX® Media Format
- ISO 9660 Level1/Level2 for CD-R/RW
- Up to 299 folders per disc and up to 648 files per folder with 8 hierarchies

Notes

- The following discs cannot be played on the DVD player. CD-ROM, DVD-ROM, DVD-RAM, CDV. (This product can play some types of DVD-R (Video format only).)
- CD-R/RW, DVD+R/RW and DVD-R/RW cannot be played unless finalized.
- Only the first session of DVD+R/R DL and DVD-R/RW/R DL can be played.
- Copyright-protected WMA files cannot be played back with the DVD player.
- Some discs cannot be played depending on the recording conditions such as PC environment and application software. Failure can also result from disc characteristics and condition, like material quality, scratches or curvature.
- Do not use any non-standard sized or shaped (heart-shaped, etc.) discs.
- Do not use discs with tape, seals, or paste on their surface.
- Do not use discs with many scratches on their surface.

DVD region codes

The region code (an ID number assigned to each market region) is set for normal DVD players and DVD video discs. The DVD player supports the discs with the region codes shown in the table below. For details, read the information on the disc jacket.

Destination	Region code of DVD player	Playable discs
U.S.A. Canada		
U.K. Europe		
Australia		
Korea Taiwan Asia		

Handling a disc

- Do not touch the surface of the disc. Hold a disc by its edge and center hole.
- Do not leave a disc in the tray when you are not playing it.
- Do not write on the disc with a pencil or other marker.
- Do not stick tape, seals or other attachments to a disc, and do not bring into contact with glue.
- Do not use a protective cover to prevent scratches.
- Do not use a disc whose surface can be printed with a commercially available label printer.
- Do not put a disc in a place with direct sunlight, high temperature, high humidity or a lot of dust.

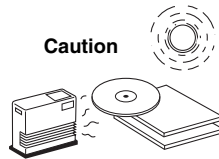
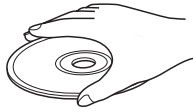

- If a disc becomes dirty, wipe it with a clean, dry cloth from the center out to the edge. Do not use record cleaner or paint thinner.
- To avoid malfunction, do not use a commercially available lens cleaner.

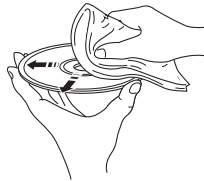

Glossary

Audio information

■ Dolby Digital

Dolby Digital is a digital surround sound system that gives you completely independent multi-channel audio. With 3 front channels (left, center, and right), and 2 surround stereo channels, Dolby Digital provides 5 full-range audio channels. With an additional channel especially for bass effects, called LFE (low frequency effect), the system has a total of 5.1-channels (LFE is counted as 0.1 channel). The receiver downmixes the multi-channel audio to 2 channel so that you can enjoy Dolby Digital sources easily.

■ MP3 (MPEG Audio Layer-3)

One of the audio compression methods used by MPEG. It employs the irreversible compression method, which achieves a high compression rate by thinning out the data of hardly audible part to the human ears. It is said to be capable of compressing the data quantity by about 1/11 (128 kbps) while maintaining a similar audio quality to music CD.

■ PCM (Pulse Code Modulation)

A signal that is changed to digital format without compression. A CD is recorded with 16-bit sound at 44.1 kHz, while DVD recording is anywhere from 16 bits at 48 kHz to 24 bits at 192 kHz, which makes it a higher quality sound than CD. This signal also has a type called Packed PCM (PPCM) that can be compressed without any loss of data.

■ Sampling frequency

The number of sampling (process for digitalizing analog signals) per second. In principle, the higher the sampling rate, the wider the frequency range that can be played back, and the higher the quantized bit rate, the finer the sound that can be reproduced.

■ Title, Chapter (DVD)

DVD video lets you divide a disc in a big way by titles or a small way by chapters. Each division is either called a title number or a chapter number.

■ Track (CD/Video CD/Super Video CD)

A CD, VCD or SVCD can be divided into a number of segments (tracks). Each division is called a track number.

■ WMA (Windows Media Audio)

An audio compression method developed by Microsoft Corporation. It employs the irreversible compression method, which achieves a high compression rate by thinning out the data of hardly audible part to the human ears. It is said to be capable of compressing the data quantity by about 1/22 (64 kbps) while maintaining a similar audio quality to music CD.

Video information

■ Component video signal

With the component video signal system, the video signal is separated into the Y signal for the luminance and the P_B and P_R signals for the chrominance. Color can be reproduced more faithfully with this system because each of these signals is independent. The component signal is also called the “color difference signal” because the luminance signal is subtracted from the color signal.

■ NTSC (National Television System Committee)

NTSC is a video signal system (525 lines, 30 frames per second) used in North America, Central America, a number of South American countries, and some Asian countries, including Japan.

■ PAL (Phase Alternating Line)

PAL is a video signal system (625 lines, 25 frames per second) used in the United Kingdom, much of the rest of western Europe, several South American countries, some Middle East and Asian countries, several African countries, Australia, New Zealand, and other Pacific island countries.

■ Pan & Scan and Letterbox

In general, DVD Video is produced for viewing on a wide television screen with an aspect ratio of 16:9. This means you can now view most material with the intended aspect ratio on a wide-screen television.

This ratio will not fit on a standard television that has an aspect ratio of 4:3. Two picture styles, Pan & Scan and Letterbox, deal with this problem.

- Pan & Scan cuts off the left and right portions of the picture to fill the screen.
- Letterbox inserts black bands at the top and bottom of the picture to reproduce an aspect ratio of 16:9.

■ Progressive scan

A method of displaying all scanning lines in a frame at once, reducing flicker noticeable on a larger screen and creating a sharp and smooth image.

■ Title, Chapter (DVD Video)

DVD video lets you divide a disc in a big way by titles or a small way by chapters. Each division is either called a title number or a chapter number.

Copyright and logo marks

This product incorporates copyright protection technology that is protected by method claims of certain U.S. patents and other intellectual property rights owned by Macrovision Corporation and other rights owners. Use of this copyright protection technology must be authorized by Macrovision Corporation, and is intended for home and other limited viewing uses only unless otherwise authorized by Macrovision Corporation. Reverse engineering or disassembly is prohibited.



Manufactured under license from Dolby Laboratories. “Dolby” and the double-D symbol are trademarks of Dolby Laboratories.

MPEG Layer-3 audio decoding technology licensed from Fraunhofer IIS and Thomson multimedia.



DivX, DivX Ultra Certified, and associated logos are trademarks of DivX, Inc. and are used under license.

iPod®

“iPod” is a trademark of Apple Computer, Inc., registered in the U.S. and other countries.

Specifications

■ RX-E810

AMPLIFIER SECTION

- Minimum RMS output power per channel (6 Ω, 1 kHz, 0.1% THD) 55 W + 55 W
- Maximum RMS output power per channel (6 Ω, 1 kHz, 1% THD) 65 W + 65 W
- Input sensitivity/Impedance
DVD/MD/TAPE/AUX etc. 150 mV/47 kΩ
- Frequency Response (20 Hz to 20 kHz)
DVD etc. 0 ± 0.5 dB
- Total Harmonic Distortion (20 Hz to 20 kHz)
DVD etc. 30 W, 6 Ω 0.04% or less
- Signal to Noise ratio (IHF-A network)
DVD etc. (150 mV, Input shorted) 93 dB or more
- Output level/Impedance
PHONES 0.23 V/120 Ω

TUNER SECTION

FM Section

- Tuning Range
U.S.A., Canada, Asia, and Taiwan models 87.50-107.90 MHz
Other models 87.50-108.00 MHz

AM Section

- Tuning Range
U.S.A., Canada, Asia, and Taiwan models 530-1710 kHz
Other models 531-1611 kHz
- Sensitivity
FM (S/N 68 dB) 6.0 μV
AM 600 μV/m

GENERAL

- Power Supply
U.S.A. and Canada models AC 120 V, 60 Hz
Australia model AC 240 V, 50 Hz
U.K. and Europe models AC 230 V, 50 Hz
Korea model AC 220 V, 60 Hz
China model AC 220 V, 50 Hz
Asia model AC 220-240 V, 50/60 Hz
Taiwan model AC 110-120 V, 50/60 Hz
- Power consumption
U.S.A., Canada, and Taiwan models 115 W
Other models 130 W
- Standby Power consumption 0.1 W
- AC Outlets
U.K. and Australia models 1 (Total 100 W max.)
Korea model None
Other models 2 (Total 100 W max.)
- Dimensions (W x H x D) 215 x 108 x 363 mm
- Weight 5.7 kg

■ DVD-E810

PLAYBACK SYSTEM

- DVD video, video CD and SVCD, CD, picture CD, CD-R/RW, DVD+R/RW, DVD-R/RW

VIDEO PERFORMANCE

- Video (CVBS) Output 1 Vpp into 75 Ω
- S-Video output Y: 1 Vpp into 75 Ω
C: 305 mVpp into 75 Ω
- RGB (Scart) output 700 mVpp into 75 Ω
- Component video output Y: 1 Vpp into 75 Ω
P_BC_BP_RC_R: 700 mVpp into 75 Ω

AUDIO FORMAT

- Dolby Digital/DTS/MPEG Compressed Digital
PCM 16, 20, 24 bits
fs, 44.1, 48, 96 kHz
- MP3 (ISO 9660) 96, 128, 256, 320 kbps
fs, 32, 44.1, 48 kHz
- WMA 64 kbps - 192 kbps
fs, 44.1, 48 kHz
- Analog Sound stereo

LASER

- Type Semiconductor laser GaAlAs
- Wave length 650 nm (DVD)
780 nm (VCD/CD)
- Output power 7 mW (DVD)
10 mW (VCD/CD)
- Beam divergence 60 degree

AUDIO PERFORMANCE

- DA Converter 24 bit/192 kHz
- Signal-Noise (1 kHz) 105 dB
- Dynamic range (1 kHz) 97 dB
- DVD
fs 96 kHz 2 Hz - 44 kHz
fs 48 kHz 2 Hz - 22 kHz
- SVCD
fs 48 kHz 2 Hz - 22 kHz
fs 44.1 kHz 2 Hz - 20 kHz
- CD/VCD
fs 44.1 kHz 2 Hz - 20 kHz
- Distortion and Noise (1 kHz) 0.0035 %

TV STANDARD (PAL/50 Hz) (NTSC/60 Hz)

- Number of lines 625 525
- Playback Multistandard (PAL/NTSC)

CONNECTIONS

- SCART Euroconnector
- Y output Cinch (green)
- P_B/C_B output Cinch (blue)
- P_R/C_R output Cinch (red)
- S-Video output Mini DIN, 4 pins
- Video output Cinch
- Audio output (L+R) Cinch
- Digital output
..... 1 coaxial, 1 optical (IEC60958 for CDDA/LPCM)
(IEC61937 for MPEG2, Dolby Digital)

GENERAL

- Power supply
U.S.A. and Canada models AC 120 V, 60 Hz
Australia model AC 240 V, 50 Hz
U.K. and Europe models AC 230 V, 50 Hz
Korea model AC 110-240 V, 50/60 Hz
China model AC 220 V, 50 Hz
- Standby Power consumption < 1.0 W
- Power consumption Approx. 12 W
- Dimensions (W x H x D) 215 x 108 x 330 mm
- Weight 2.3 kg

*Specifications are subject to change without notice.

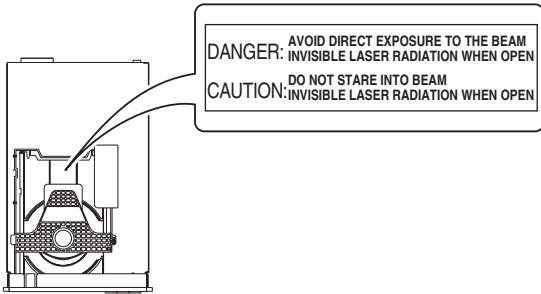
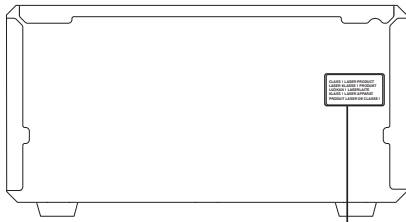

DANGER: AVOID DIRECT EXPOSURE TO THE BEAM
INVISIBLE LASER RADIATION WHEN OPEN
CAUTION: DO NOT STARE INTO BEAM
INVISIBLE LASER RADIATION WHEN OPEN

**CAUTION VISIBLE AND INVISIBLE LASER RADIATION
WHEN OPEN. AVOID EXPOSURE TO BEAM.
ATTENTION RAYONNEMENT LASER VISIBLE ET
INVISIBLE EN CAS D'OUVERTURE. EXPOSITION
DANGEREUSE AU FAISCEAU.**

LASER

Type	Semiconductor laser GaAlAs
Wave length	650 nm (DVD) 780 nm (VCD/CD)
Output Power	7 mW (DVD) 10 mW (VCD/CD)
Beam divergence	60 degrees

CAUTION

Use of controls or adjustments or performance of procedures other than those specified herein may result in hazardous radiation exposure.

LASER

Type	Laser à semi-conducteur GaAlAs
Longueur d'onde	650 nm (DVD) 780 nm (VCD/CD)
Puissance de sortie	7 mW (DVD) 10 mW (VCD/CD)
Divergence de faisceau	60 degrés

AVERTISSEMENT

L'utilisation de commandes et l'emploi de réglages ou de méthodes autres que ceux décrits ci-dessous, peuvent entraîner une exposition à un rayonnement dangereux.

**LIST OF REMOTE CONTROL CODES
LISTE DES CODES DE COMMANDE**

TV

Admiral	292/293/216	Panasonic	234/235/236/253/ 288/211
Aiwa	294/276/283/284	Philco	297/225/239/298
Akai	295/296	Philips	225/205/298
Alba	296		
AOC	297		
Bell & Howell	292	Pioneer	226/235/254/255/ 268
Bestar	298		
Blaupunkt	229/222	Portland	297/256
Blue sky	298	Proscan	293/221
Brandt	223	Proton	297/250/260/270
Brocsonic	297	Quasar	234/235
Bush	296	Radio Shack	299/293/297
By Design	201/202	RCA	293/297/234/256/ 257/258/221
Clatronic	298		
Craig	224	SABA	223/269/265/266
Croslex	225/298	Sampo	281/297/280
Curtis Mathis	297/226	Samsung	297/239/248/262/ 275
Daewoo	297/298/224/227/ 228	Sanyo	295/233/279/272/ 273/274/212
Dayton	239		
Dwin	293/281	Schneider	296
Emerson	297/224/239/232	Scott	297
Ferguson	223/265/266	Sharp	292/239/232/213
First line	298	Siemens	229
Fisher	295/233	Signature	216/292
Fraba	298	Sony	263/214
Fujitsu	289	Sylvania	297/225/298
Funai	277/278	Symphonic	217/218/219
GE	293/297/234/235/ 236	Telefunken	269/264/265/266
		Thomson	223/266
Goodmans	296/298/223	Toshiba	292/226/267/215
Grundig	229/238/249	Videch	297/242
Hitachi	297/239/242/243/ 285	Wards	297/239/232/216
ICE	296	Yamaha	299/292/242/285/ 287/253
Irradio	296	Zenith	216/261/271
Itt/Nokia	244/245		
JC Penny	293/297/234/237		
JVC (Victor)	296/246/247/286		
Kendo	298		
KTV	297/239		
LG/Goldstar	297/298/239/237		
Loewe	298/248		
LXI	293/297/225/226/ 233/298		
Magnavox	297/225/239/298		
Marantz	298/210		
Matsui	295		
Medion	203/204/298		
Memorex	297/216		
Mitsubishi	299/297/259/287		
Nad	226/255		
NEC	297/252/282		
Nokia	244/245		
Nokia Oceanic	245		
Nordmende	265/266		
Onwa	296		



© 2006 YAMAHA CORPORATION All rights reserved.

YAMAHA ELECTRONICS CORPORATION, USA 6660 ORANGETHORPE AVE., BUENA PARK, CALIF. 90620, U.S.A.
YAMAHA CANADA MUSIC LTD. 135 MILNER AVE., SCARBOROUGH, ONTARIO M1S 3R1, CANADA
YAMAHA ELECTRONIK EUROPA G.m.b.H. SIEMENSSTR. 22-34, 25462 RELLINGEN BEI HAMBURG, GERMANY
YAMAHA ELECTRONIQUE FRANCE S.A. RUE AMBROISE CROIZAT BP70 CROISSY-BEAUBOURG 77312 MARNE-LA-VALLEE CEDEX02, FRANCE
YAMAHA ELECTRONICS (UK) LTD. YAMAHA HOUSE, 200 RICKMANSWORTH ROAD WATFORD, HERTS WD18 7GQ, ENGLAND
YAMAHA SCANDINAVIA A.B. J A WETTERGRENS GATA 1, BOX 30053, 400 43 VÄSTRA FRÖLUNDA, SWEDEN
YAMAHA MUSIC AUSTRALIA PTY, LTD. 17-33 MARKET ST., SOUTH MELBOURNE, 3205 VIC., AUSTRALIA

YAMAHA CORPORATION
Printed in China © WH45450