



RX-V1800

AV Receiver

OWNER'S MANUAL

Important safety instructions

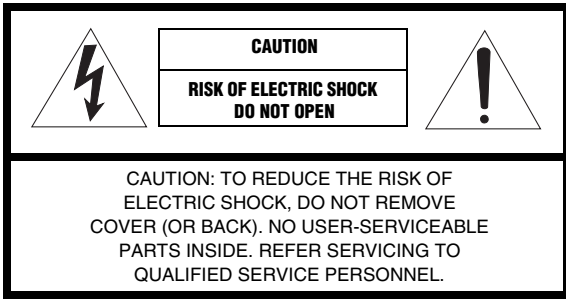

• Explanation of Graphical Symbols

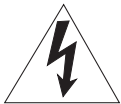

The lightning flash with arrowhead symbol, within an equilateral triangle, is intended to alert you to the presence of uninsulated “dangerous voltage” within the product’s enclosure that may be of sufficient magnitude to constitute a risk of electric shock to persons.



The exclamation point within an equilateral triangle is intended to alert you to the presence of important operating and maintenance (servicing) instructions in the literature accompanying the appliance.

- 1 Read Instructions – All the safety and operating instructions should be read before the product is operated.
 - 2 Retain Instructions – The safety and operating instructions should be retained for future reference.
 - 3 Heed Warnings – All warnings on the product and in the operating instructions should be adhered to.
 - 4 Follow Instructions – All operating and use instructions should be followed.
 - 5 Cleaning – Unplug this product from the wall outlet before cleaning. Do not use liquid cleaners or aerosol cleaners.
 - 6 Attachments – Do not use attachments not recommended by the product manufacturer as they may cause hazards.
 - 7 Water and Moisture – Do not use this product near water – for example, near a bath tub, wash bowl, kitchen sink, or laundry tub; in a wet basement; or near a swimming pool; and the like.
 - 8 Accessories – Do not place this product on an unstable cart, stand, tripod, bracket, or table. The product may fall, causing serious injury to a child or adult, and serious damage to the product. Use only with a cart, stand, tripod, bracket, or table recommended by the manufacturer, or sold with the product. Any mounting of the product should follow the manufacturer’s instructions, and should use a mounting accessory recommended by the manufacturer.
 - 9 A product and cart combination should be moved with care. Quick stops, excessive force, and uneven surfaces may cause the product and cart combination to overturn.
- 
- 10 Ventilation – Slots and openings in the cabinet are provided for ventilation and to ensure reliable operation of the product and to protect it from overheating, and these openings must not be blocked or covered. The openings should never be blocked by placing the product on a bed, sofa, rug, or other similar surface. This product should not be placed in a built-in installation such as a bookcase or rack unless proper ventilation is provided or the manufacturer’s instructions have been adhered to.
 - 11 Power Sources – This product should be operated only from the type of power source indicated on the marking label. If you are not sure of the type of power supply to your home, consult your product dealer or local power company. For products intended to operate from battery power, or other sources, refer to the operating instructions.
 - 12 Grounding or Polarization – This product may be equipped with a polarized alternating current line plug (a plug having one blade wider than the other). This plug will fit into the power outlet only one way. This is a safety feature. If you are unable to insert the plug fully into the outlet, try reversing the plug. If the plug should still fail to fit, contact your electrician to replace your obsolete outlet. Do not defeat the safety purpose of the polarized plug.
 - 13 Power-Cord Protection – Power-supply cords should be routed so that they are not likely to be walked on or pinched by items placed upon or against them, paying particular attention to cords at plugs, convenience receptacles, and the point where they exit from the product.
 - 14 Lightning – For added protection for this product during a lightning storm, or when it is left unattended and unused for long periods of time, unplug it from the wall outlet and disconnect the antenna or cable system. This will prevent damage to the product due to lightning and power-line surges.
 - 15 Power Lines – An outside antenna system should not be located in the vicinity of overhead power lines or other electric light or power circuits, or where it can fall into such power lines or circuits. When installing an outside antenna system, extreme care should be taken to keep from touching such power lines or circuits as contact with them might be fatal.
 - 16 Overloading – Do not overload wall outlets, extension cords, or integral convenience receptacles as this can result in a risk of fire or electric shock.
 - 17 Object and Liquid Entry – Never push objects of any kind into this product through openings as they may touch dangerous voltage points or short-out parts that could result in a fire or electric shock. Never spill liquid of any kind on the product.
 - 18 Servicing – Do not attempt to service this product yourself as opening or removing covers may expose you to dangerous voltage or other hazards. Refer all servicing to qualified service personnel.
 - 19 Damage Requiring Service – Unplug this product from the wall outlet and refer servicing to qualified service personnel under the following conditions:
 - a) When the power-supply cord or plug is damaged,
 - b) If liquid has been spilled, or objects have fallen into the product,
 - c) If the product has been exposed to rain or water,

- d) If the product does not operate normally by following the operating instructions. Adjust only those controls that are covered by the operating instructions as an improper adjustment of other controls may result in damage and will often require extensive work by a qualified technician to restore the product to its normal operation,
 - e) If the product has been dropped or damaged in any way, and
 - f) When the product exhibits a distinct change in performance - this indicates a need for service.
- 20 Replacement Parts** – When replacement parts are required, be sure the service technician has used replacement parts specified by the manufacturer or have the same characteristics as the original part. Unauthorized substitutions may result in fire, electric shock, or other hazards.
- 21 Safety Check** – Upon completion of any service or repairs to this product, ask the service technician to perform safety checks to determine that the product is in proper operating condition.
- 22 Wall or Ceiling Mounting** – The unit should be mounted to a wall or ceiling only as recommended by the manufacturer.
- 23 Heat** – The product should be situated away from heat sources such as radiators, heat registers, stoves, or other products (including amplifiers) that produce heat.

- 24 Outdoor Antenna Grounding** – If an outside antenna or cable system is connected to the product, be sure the antenna or cable system is grounded so as to provide some protection against voltage surges and built-up static charges. Article 810 of the National Electrical Code, ANSI/NFPA 70, provides information with regard to proper grounding of the mast and supporting structure, grounding of the lead-in wire to an antenna discharge unit, size of grounding conductors, location of antenna discharge unit, connection to grounding electrodes, and requirements for the grounding electrode.

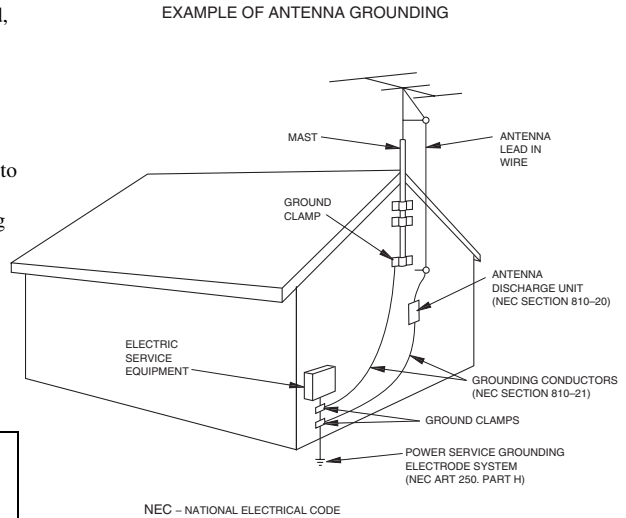

Note to CATV system installer:

This reminder is provided to call the CATV system installer's attention to Article 820-40 of the NEC that provides guidelines for proper grounding and, in particular, specifies that the cable ground shall be connected to the grounding system of the building, as close to the point of cable entry as practical.

FCC INFORMATION (for US customers)

1 IMPORTANT NOTICE: DO NOT MODIFY THIS UNIT!

This product, when installed as indicated in the instructions contained in this manual, meets FCC requirements. Modifications not expressly approved by Yamaha may void your authority, granted by the FCC, to use the product.

- 2 IMPORTANT:** When connecting this product to accessories and/or another product use only high quality shielded cables. Cable/s supplied with this product **MUST** be used. Follow all installation instructions. Failure to follow instructions could void your FCC authorization to use this product in the USA.

- 3 NOTE:** This product has been tested and found to comply with the requirements listed in FCC Regulations, Part 15 for Class "B" digital devices. Compliance with these requirements provides a reasonable level of assurance that your use of this product in a residential environment will not result in harmful interference with other electronic devices.

This equipment generates/uses radio frequencies and, if not installed and used according to the instructions found in the users manual, may cause interference harmful to the operation of other electronic devices.

Compliance with FCC regulations does not guarantee that interference will not occur in all installations. If this product is found to be the source of interference, which can be determined by turning the unit "OFF" and "ON", please try to eliminate the problem by using one of the following measures:

Relocate either this product or the device that is being affected by the interference.

Utilize power outlets that are on different branch (circuit breaker or fuse) circuits or install AC line filter/s.

In the case of radio or TV interference, relocate/reorient the antenna. If the antenna lead-in is 300 ohm ribbon lead, change the lead-in to coaxial type cable.

If these corrective measures do not produce satisfactory results, please contact the local retailer authorized to distribute this type of product. If you can not locate the appropriate retailer, please contact Yamaha Electronics Corp., U.S.A. 6660 Orangethorpe Ave, Buena Park, CA 90620.

The above statements apply **ONLY** to those products distributed by Yamaha Corporation of America or its subsidiaries.

Caution: Read this before operating your unit.

- 1 To assure the finest performance, please read this manual carefully. Keep it in a safe place for future reference.
- 2 Install this sound system in a well ventilated, cool, dry, clean place – away from direct sunlight, heat sources, vibration, dust, moisture, and/or cold. Allow ventilation space of at least 30 cm on the top, 20 cm on the left and right, and 20 cm on the back of this unit.
- 3 Locate this unit away from other electrical appliances, motors, or transformers to avoid humming sounds.
- 4 Do not expose this unit to sudden temperature changes from cold to hot, and do not locate this unit in an environment with high humidity (i.e. a room with a humidifier) to prevent condensation inside this unit, which may cause an electrical shock, fire, damage to this unit, and/or personal injury.
- 5 Avoid installing this unit where foreign objects may fall onto this unit and/or this unit may be exposed to liquid dripping or splashing. On the top of this unit, do not place:
 - Other components, as they may cause damage and/or discoloration on the surface of this unit.
 - Burning objects (i.e. candles), as they may cause fire, damage to this unit, and/or personal injury.
 - Containers with liquid in them, as they may fall and liquid may cause electrical shock to the user and/or damage to this unit.
- 6 Do not cover this unit with a newspaper, tablecloth, curtain, etc. in order not to obstruct heat radiation. If the temperature inside this unit rises, it may cause fire, damage to this unit, and/or personal injury.
- 7 Do not plug in this unit to a wall outlet until all connections are complete.
- 8 Do not operate this unit upside-down. It may overheat, possibly causing damage.
- 9 Do not use force on switches, knobs and/or cords.
- 10 When disconnecting the power cable from the wall outlet, grasp the plug; do not pull the cable.
- 11 Do not clean this unit with chemical solvents; this might damage the finish. Use a clean, dry cloth.
- 12 Only voltage specified on this unit must be used. Using this unit with a higher voltage than specified is dangerous and may cause fire, damage to this unit, and/or personal injury. Yamaha will not be held responsible for any damage resulting from use of this unit with a voltage other than specified.
- 13 To prevent damage by lightning, keep the power cord and outdoor antennas disconnected from a wall outlet or the unit during a lightning storm.
- 14 Do not attempt to modify or fix this unit. Contact qualified Yamaha service personnel when any service is needed. The cabinet should never be opened for any reasons.
- 15 When not planning to use this unit for long periods of time (i.e. vacation), disconnect the AC power plug from the wall outlet.
- 16 Install this unit near the AC outlet and where the AC power plug can be reached easily.
- 17 Be sure to read the “Troubleshooting” section on common operating errors before concluding that this unit is faulty.
- 18 Before moving this unit, press **Ⓐ MASTER ON/OFF** to release it outward to the OFF position to turn off this unit, the main room, Zone 2 and Zone 3 and then disconnect the AC power plug from the AC wall outlet.
- 19 **VOLTAGE SELECTOR** (Asia and General models only)
The **VOLTAGE SELECTOR** on the rear panel of this unit must be set for your local main voltage BEFORE plugging into the AC wall outlet. Voltages are:
.....AC 110/120/220/230–240 V, 50/60 Hz
- 20 The batteries shall not be exposed to excessive heat such as sunshine, fire or like.
- 21 Excessive sound pressure from earphones and headphones can cause hearing loss.

WARNING

TO REDUCE THE RISK OF FIRE OR ELECTRIC SHOCK, DO NOT EXPOSE THIS UNIT TO RAIN OR MOISTURE.

As long as this unit is connected to the AC wall outlet, it is not disconnected from the AC power source even if you turn off this unit by **Ⓐ MASTER ON/OFF**. In this state, this unit is designed to consume a very small quantity of power.

FOR CANADIAN CUSTOMERS

To prevent electric shock, match wide blade of plug to wide slot and fully insert.
This Class B digital apparatus complies with Canadian ICES-003.

POUR LES CONSOMMATEURS CANADIENS

Pour éviter les chocs électriques, introduire la lame la plus large de la fiche dans la borne correspondante de la prise et pousser jusqu'au fond.
Cet appareil numérique de la classe B est conforme à la norme NMB-003 du Canada.

IMPORTANT

Please record the serial number of this unit in the space below.

MODEL:

Serial No.:

The serial number is located on the rear of the unit. Retain this Owner's Manual in a safe place for future reference.

Contents

INTRODUCTION

Notice	2
Features	3
Supplied accessories	4
Getting started	5
Quick start guide	6

PREPARATION

Connections	12
Optimizing the speaker setting for your listening room	37
Using AUTO SETUP	37

BASIC OPERATION

Playback	42
Basic procedure	42
Selecting audio input jacks (AUDIO SELECT)	43
Selecting the MULTI CH INPUT component	43
Using your headphones	43
Muting the audio output	44
Displaying the input source information (SIGNAL INFO)	44
Playing video sources in the background of an audio source	45
Using the sleep timer	45
Sound field programs	46
Selecting sound field programs	46
Sound field program descriptions	46
Enjoying unprocessed input sources	51
Using audio features	52
Enjoying pure hi-fi sound	52
Adjusting the tonal quality	52
Adjusting the speaker level	53
Enjoying multi-channel sources in 2-channel stereo	53
FM/AM tuning	54
Automatic tuning	54
Manual tuning	54
Automatic preset tuning	55
Manual preset tuning	55
Selecting preset stations	56
Exchanging preset stations	57
XM™ Satellite Radio tuning	58
Connecting XM™ Mini-Tuner Home Dock	58
Activating XM™ Satellite Radio	59
Basic XM™ Satellite Radio operations	59
Setting the XM™ Satellite Radio preset channels	62
Displaying the XM™ Satellite Radio information	63
Using iPod™	64
Controlling iPod™	64
Recording	66

ADVANCED OPERATION

Advanced sound configurations	67
Changing sound field parameter settings	67
Selecting decoders	72
Customizing this unit (MANUAL SETUP)	75
Using SET MENU	79
1 BASIC MENU	80
2 VOLUME MENU	84
3 SOUND MENU	85
4 INPUT MENU	88
5 OPTION MENU	91
Saving and recalling the system settings (SYSTEM MEMORY)	96
Saving the current system settings	96
Loading the stored system settings	97
Using examples	98
Remote control features	100
Controlling this unit, a TV, or other components	100
Setting remote control codes	102
Programming codes from other remote controls	104
Changing source names in the display window	105
Macro programming features	106
Clearing configurations	109
Using multi-zone configuration	111
Connecting the Zone 2 and Zone 3 components	111
Controlling Zone 2 or Zone 3	112
Advanced setup	117
Using the advanced setup menu	117

ADDITIONAL INFORMATION

Troubleshooting	121
Resetting the system	129
Glossary	130
Sound field program information	134
Parametric equalizer information	135
Specifications	136
Index	138

APPENDIX

(at the end of this manual)

Front Panel	i
Remote Control	ii
Sound output in each sound field program	iii
List of remote control codes	v

“**A** MASTER ON/OFF” or “**1** DVD” (example) indicates the name of the parts on the front panel or the remote control. Refer to the attached sheet or the pages at the end of this manual for the information about each position of the parts.

INTRODUCTION

PREPARATION

BASIC
OPERATION

ADVANCED
OPERATION





ADDITIONAL
INFORMATION

APPENDIX

English

Notice

About this manual

-  indicates a tip for your operation.
- Some operations can be performed by using either the buttons on the front panel or the ones on the remote control. In case the button names differ between the front panel and the remote control, the button name on the remote control is given in parentheses.
- This manual is printed prior to production. Design and specifications are subject to change in part as a result of improvements, etc. In case of differences between the manual and product, the product has priority.
- “ MASTER ON/OFF” or “ DVD” (example) indicates the name of the parts on the front panel or the remote control. Refer to the attached sheet or the pages at the end of this manual for the information about each position of the parts.
- The symbol “ ” with page number(s) indicates the corresponding reference page(s).

We Want You Listening For A Lifetime



Yamaha and the Electronic Industries Association's Consumer Electronics Group want you to get the most out of your equipment by playing it at a safe level. One that lets the sound come through loud and clear without annoying blaring or distortion – and, most importantly, without affecting your sensitive

hearing. Since hearing damage from loud sounds is often undetectable until it is too late, Yamaha and the Electronic Industries Association's Consumer Electronics Group recommend you to avoid prolonged exposure from excessive volume levels.



Manufactured under license from Dolby Laboratories. “Dolby”, “Pro Logic”, and the double-D symbol are trademarks of Dolby Laboratories.



Manufactured under license under U.S. Patent No's: 5,451,942;5,956,674;5,974,380;5,978,762;6,226,616;6,487,535 & other U.S. and worldwide patents issued & pending. DTS is a registered trademark and the DTS logos, Symbol, DTS-HD and DTS-HD Master Audio are trademark of DTS, Inc. © 1996-2007 DTS, Inc. All Rights Reserved.

iPod™

“iPod” is a trademark of Apple Inc., registered in the U.S. and other countries.



“HDMI”, the “HDMI” logo and “High-Definition Multimedia Interface” are trademarks, or registered trademarks of HDMI Licensing LLC.

SILENT™ CINEMA

“SILENT CINEMA” is a trademark of YAMAHA CORPORATION.



The XM name and related logos are registered trademarks of XM Satellite Radio Inc.



This product is manufactured under license from Neural Audio Corporation and THX Ltd. YAMAHA CORPORATION hereby grants the user a non-exclusive, non-transferable, limited right of use to this product under U.S.A. and foreign patent, patent pending and other technology or trademarks owned by Neural Audio Corporation and THX Ltd. “Neural Surround”, “Neural Audio”, “Neural” and “NRL” are trademarks and logos owned by Neural Audio Corporation. THX is a trademark of THX Ltd., which may be registered in some jurisdictions. All rights reserved.

Features

Built-in 7-channel power amplifier

- ◆ Minimum RMS output power (20 Hz to 20 kHz, 0.04% THD, 8 Ω)
Front: 130 W + 130 W
Center: 130 W
Surround: 130 W + 130 W
Surround back: 130 W + 130 W

Sound field programs

- ◆ Proprietary Yamaha technology for the creation of sound fields
- ◆ Compressed Music Enhancer mode to improve the sound quality of compression artifacts (such as the MP3 format) to that of a high-quality multi-channel source playback
- ◆ Virtual CINEMA DSP
- ◆ SILENT CINEMA

Digital audio decoders

- ◆ Dolby TrueHD, Dolby Digital Plus decoder
- ◆ DTS-HD Master Audio, DTS-HD High Resolution Audio decoder
- ◆ Dolby Digital/Dolby Digital EX decoder
- ◆ DTS/DTS-ES Matrix 6.1, Discrete 6.1, DTS 96/24 decoder
- ◆ Dolby Pro Logic/Dolby Pro Logic II/Dolby Pro Logic IIX decoder
- ◆ DTS NEO:6 decoder
- ◆ Neural-THX Surround decoder (U.S.A. and Canada models only)

Sophisticated FM/AM tuner

- ◆ 40-station random and direct preset tuning
- ◆ Automatic preset tuning
- ◆ Preset station shifting capability (preset editing)

XM™ Satellite Radio

- ◆ XM Satellite Radio tuning capability (using XM Mini-Tuner and Home Dock, sold separately)
- ◆ Neural-THX Surround decoder to play back the XM HD content of XM Satellite Radio broadcasts in multi-channels, resulting in a full surround sound experience
- ◆ XM Satellite Radio information displaying capability

HDMI™ (High-Definition Multimedia Interface)

- ◆ HDMI interface for standard, enhanced or high-definition video as well as multi-channel digital audio based on HDMI version 1.3a
- ◆ Automatic audio and video synchronization (lip sync) information capability
- ◆ Deep Color video signal (30/36 bit) transmission capability
- ◆ High refresh rate and high resolution video signals capability
- ◆ High definition digital audio format signals capability
- ◆ Analog video to HDMI digital video up-conversion (composite video ↔ S-video ↔ component video → HDMI digital video) capability for monitor out
- ◆ Analog video up-scaling from 480i (NTSC)/576i (PAL) or 480p/576p to 720p, 1080i or 1080p

iPod™ controlling capability

- ◆ DOCK terminal to connect a Yamaha iPod universal dock (such as the YDS-10, sold separately), which supports iPod (Click and Wheel), iPod nano, and iPod mini

Other features

- ◆ YPAO (Yamaha Parametric Room Acoustic Optimizer) for automatic speaker setup
- ◆ 192-kHz/24-bit D/A converter
- ◆ OSD (on-screen display) menus that allow you to optimize this unit to suit your individual audiovisual system
- ◆ 6 or 8-channel additional input jacks for discrete multi-channel input
- ◆ Analog video interlace/progressive conversion from 480i (NTSC)/576i (PAL) to 480p/576p
- ◆ S-video signal input/output capability
- ◆ Component video input/output capability includes (3 COMPONENT VIDEO INs and 1 MONITOR OUT)
- ◆ Optical and coaxial digital audio signal jacks
- ◆ Pure Direct mode for pure hi-fi sound for all sources
- ◆ Adaptive dynamic range controlling capability
- ◆ Adaptive DSP effect level controlling capability
- ◆ Remote control with preset remote control codes, learning and macro capability
- ◆ ZONE 2/ZONE 3 custom installation facility
- ◆ Zone switching capability between the main zone and ZONE 2/ZONE 3 using ZONE CONTROLS
- ◆ SYSTEM MEMORY capability for saving and recalling multiple system parameter settings
- ◆ Sleep timer

Supplied accessories

Check that you received all of the following accessories.

Remote control

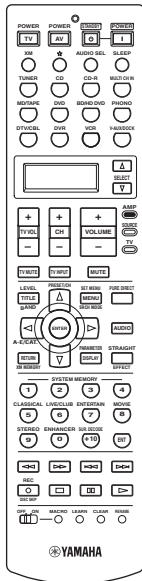

Zone 2/Zone 3 remote control (except Europe model)

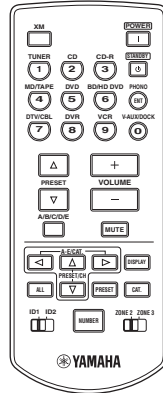

Batteries (6) (AAA, R03, UM-4) (except Europe model)

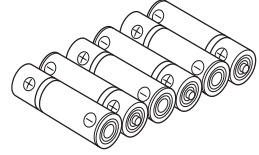

Batteries (4) (AAA, R03, UM-4) (Europe model)

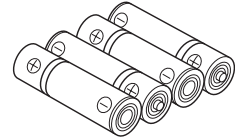

Speaker terminal wrench

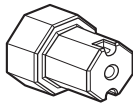

Power cables (Two for Asia model)

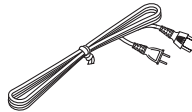

Optimizer microphone

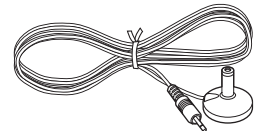

Indoor FM antenna

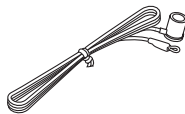

AM loop antenna



Note

The form of the supplied accessories varies depending on the models.

Getting started

■ Installing batteries in the remote control

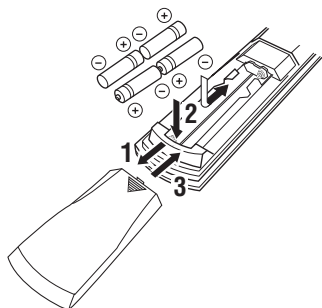

1 Press the ▼ part and slide the battery compartment cover off.

2 Insert the four supplied batteries (AAA, R03, UM-4) according to the polarity markings (+ and -) on the inside of the battery compartment.

3 Slide the cover back until it snaps into place.

■ Installing batteries in the Zone 2/Zone 3 remote control (Except Europe model)

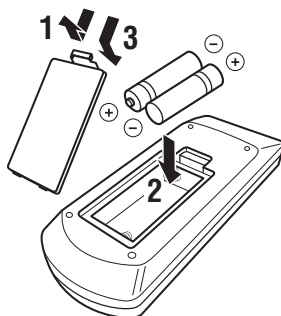

1 Take off the battery compartment cover.

2 Insert the two supplied batteries (AAA, R03, UM-4) according to the polarity markings (+ and -) on the inside of the battery compartment.

3 Snap the battery compartment cover back into place.

Notes

- Change all of the batteries if you notice the following conditions:
 - the operation range of the remote control decreases.
 - the transmit indicator (⊕) does not flash or its light becomes dim.
- Do not use old batteries together with new ones.
- Do not use different types of batteries (such as alkaline and manganese batteries) together. Read the packaging carefully as these different types of batteries may have the same shape and color.
- If the batteries have leaked, dispose of them immediately. Avoid touching the leaked material or letting it come into contact with clothing, etc. Clean the battery compartment thoroughly before installing new batteries.
- Do not throw away batteries with general house waste; dispose of them correctly in accordance with your local regulations.
- If the remote control is without batteries for more than 2 minutes, or if exhausted batteries remain in the remote control, the contents of the memory may be cleared. When the memory is cleared, insert new batteries, set up the remote control code and program any acquired functions that may have been cleared.

■ VOLTAGE SELECTOR (Asia and General models only)

Caution

The VOLTAGE SELECTOR on the rear panel of this unit must be set for your local voltage BEFORE plugging the power cable into the AC wall outlet. Improper setting of the VOLTAGE SELECTOR may cause damage to this unit and create a potential fire hazard.

Rotate the VOLTAGE SELECTOR clockwise or counterclockwise to the correct position using a straight slot screwdriver.

Voltages are as follows:

.....AC 110/120/220/230–240 V, 50/60 Hz

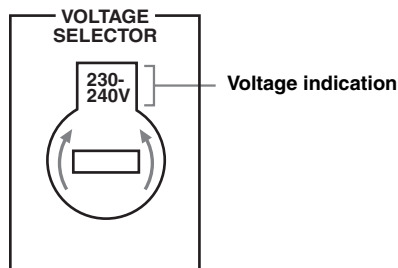

Quick start guide

The following steps describe the easiest way to enjoy DVD movie playback in your home theater.

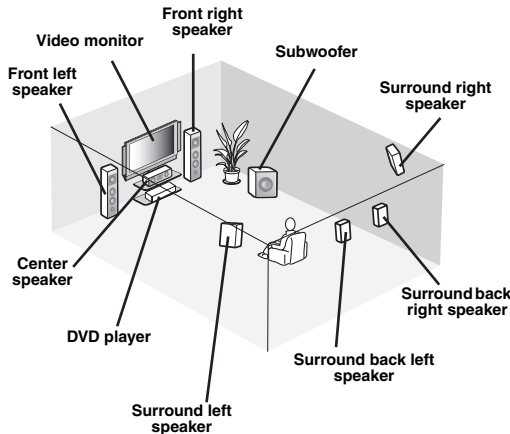

Step 1: Set up your speakers

P. 7

Step 2: Connect your DVD player and other components

P. 8

Step 3: Turn on the power and start playback

P. 10

Enjoy DVD playback!

Preparation: Check the items

In these steps, you need the following supplied accessories.

- AM loop antenna
- Indoor FM antenna
- Power cable

The following items are not included in the package of this unit.

- Speakers**
 - Front speaker x 2
 - Center speaker x 1
 - Surround speaker x 4Select magnetically shielded speakers. The minimum required speakers are two front speakers. The priority of the requirement of other speakers is as follows:
 1. Two surround speakers
 2. One center speaker
 3. One (or two) surround back speaker(s)
- Active subwoofer** x 1
Select an active subwoofer equipped with an RCA input jack.
- Speaker cable** x 7
- Subwoofer cable** x 1
Select a monaural RCA cable.
- DVD player** x 1
Select DVD player equipped with coaxial digital audio output jack and composite video output jack.
- Video monitor** x 1
Select a TV monitor, video monitor or projector equipped with a composite video input jack.
- Video cable** x 2
Select RCA composite video cables.
- Digital coaxial audio cable** x 1

Step 1: Set up your speakers

Place your speakers in the room and connect them to this unit.

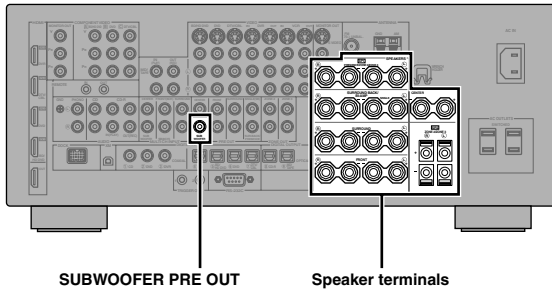

1 Place your speakers and subwoofer in the room.

2 Connect speaker cables to each speaker.

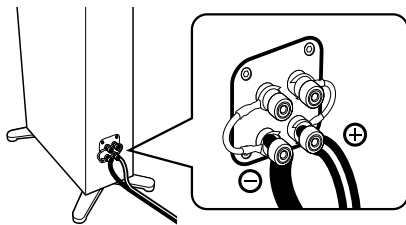

3 Connect each speaker cable to the corresponding speaker terminal of this unit.

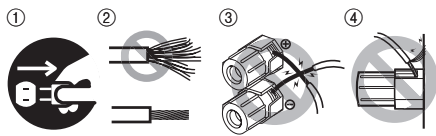

- ① Make sure that this unit and the subwoofer are unplugged from the AC wall outlets.
- ② Twist the exposed wires of the speaker cables together to prevent short circuits.
- ③ Do not let the bare speaker wires touch each other.
- ④ Do not let the bare speaker wires touch any metal part of this unit.

Be sure to connect the left channel (L), right channel (R), “+” (red) and “-” (black) properly.

Front speakers and center speaker

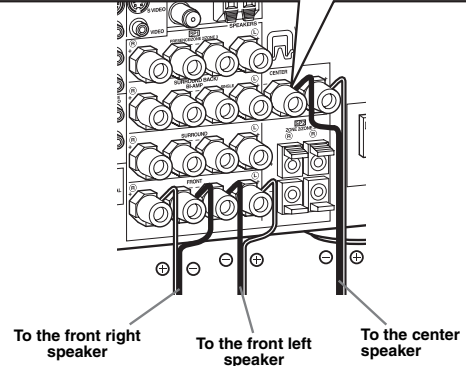
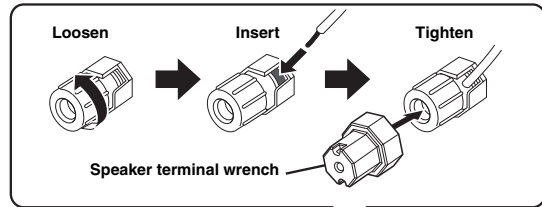

Surround and surround back speakers

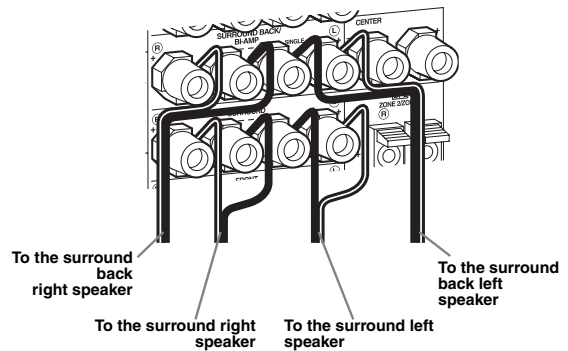

4 Connect the subwoofer cable to the **SUBWOOFER PRE OUT** jack of this unit and the input jack of the subwoofer.

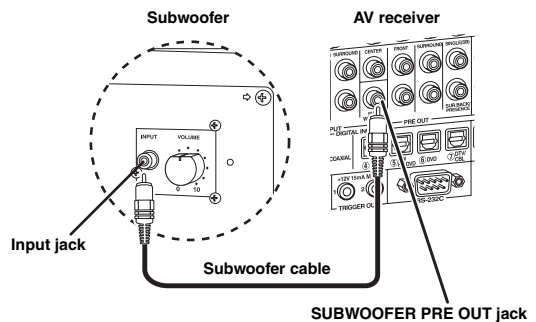

Step 2: Connect your DVD player and other components

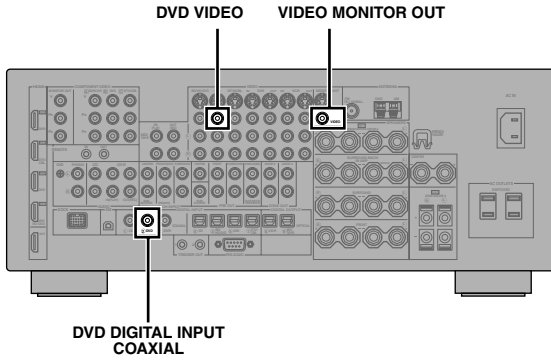

Make sure that this unit and the DVD player are unplugged from the AC wall outlets.

- 1 Connect the digital coaxial audio cable to the digital coaxial audio output jack of your DVD player and the DVD DIGITAL INPUT COAXIAL jack of this unit.

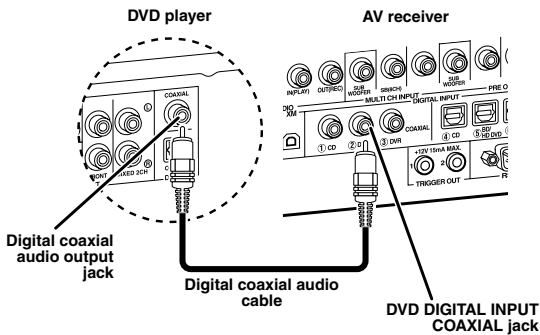

- 2 Connect the video cable to the composite video output jack of your DVD player and DVD VIDEO jack of this unit.

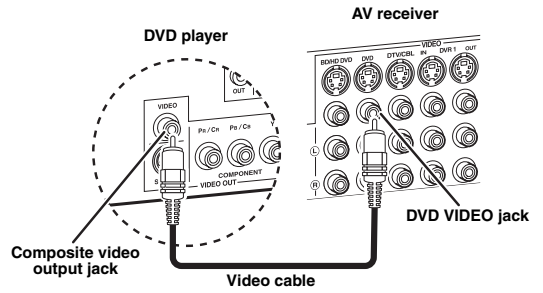

- 3 Connect the video cable to the VIDEO MONITOR OUT jack of this unit and the video input jack of your video monitor.

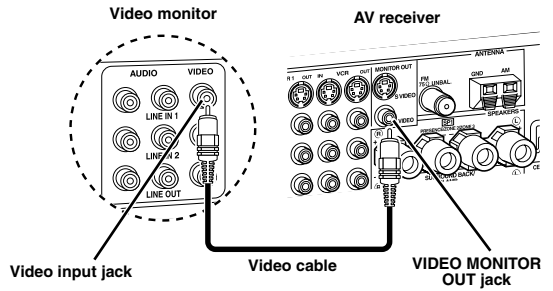

4 Connect the supplied AM loop antenna and indoor FM antenna to this unit.

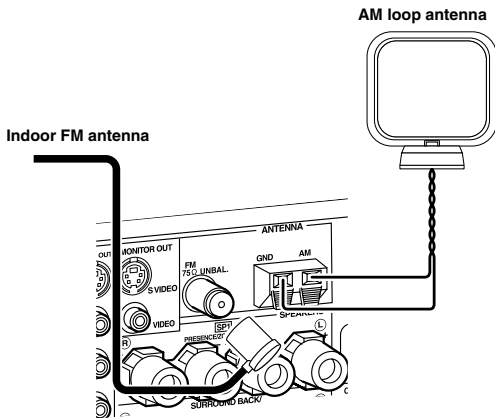

Note

The types of the supplied indoor FM antenna and the FM antenna terminal of this unit are different depending on the models.

Connecting the wire of the AM loop antenna

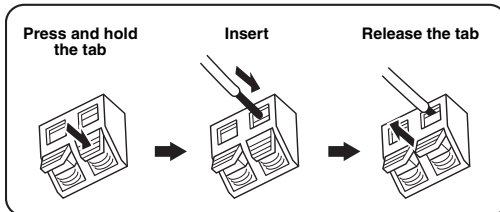

The wire of the AM loop antenna does not have any polarity and you can connect either end of the wire to AM or GND terminal.

Assembling the supplied AM loop antenna

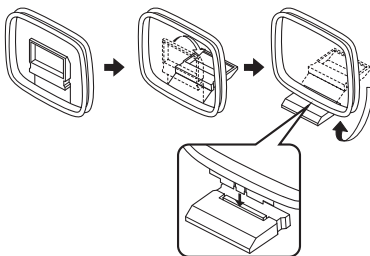

5 Connect the supplied power cable to this unit and then plug of the power cable and other components into the AC wall outlet.



- This unit is equipped with AC OUTLET(S) that provide(s) power to other components (except Korea model). See page 32 for details.
- (Asia model only) Select one of the supplied power cables suitable for the type of AC wall outlet in your location before plugging this unit into the AC wall outlet.

For further connections

- Using other kinds of speaker combinations P. 14
- Connecting a video monitor via various ways of connection P. 24
- Connecting a DVD player via various ways of connection P. 25
- Connecting a DVD recorder or a digital video recorder P. 27
- Connecting a set-top box P. 27
- Connecting a CD player, an MD recorder, or a turntable P. 28
- Connecting an external amplifier P. 29
- Connecting a DVD player via multi-channel analog audio connection P. 30
- Connecting a Yamaha iPod universal dock P. 31
- Using the REMOTE IN/OUT jacks P. 31
- Using the VIDEO AUX jacks on the front panel P. 31
- Connecting an outdoor FM/AM antenna P. 32
- Connecting XM Mini-Tuner Home Dock P. 58

General connection information

- General information on jacks and cable plugs P. 20
- General information on HDMI P. 21–22
- Speaker impedance settings P. 33

Step 3: Turn on the power and start playback

Check the type of the connected speakers.

If the speakers are 6-ohm speakers, set "SPEAKER IMP." to "6Ω MIN" before using this unit (see page 33). You can also use 4-ohm speakers as the front speakers (see page 117).

1 Turn on the video monitor connected to this unit.

2 Press **Ⓐ** **MASTER ON/OFF** inward to the ON position on the front panel.

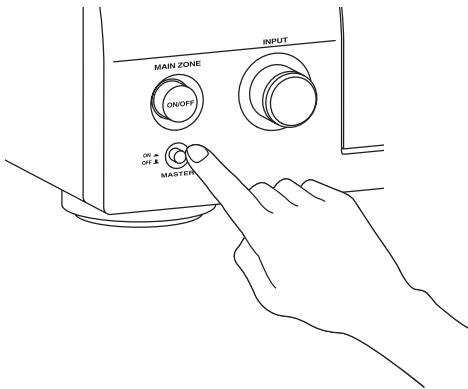

3 Rotate the **Ⓒ** **INPUT** selector to set the input source to "DVD".



- The recommended sound field program is set for each input source (DVD, etc.). You can also use various sound field programs and other sound modes for playback. Refer to the following pages for details:
 - see pages 46 to 50 to use various sound field programs
 - see page 51 to turn on or off the sound effect
 - see page 52 to use the pure direct mode for high fidelity sound
- You can also set the input source to "TUNER" to use the FM/AM tuning feature. For information on the FM/AM tuning, see pages 54 to 57.

4 Start playback of the desired DVD on your player.

5 Rotate **Ⓓ** **VOLUME** to adjust the volume.

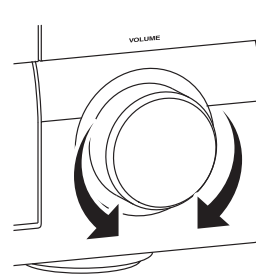

■ After using this unit...



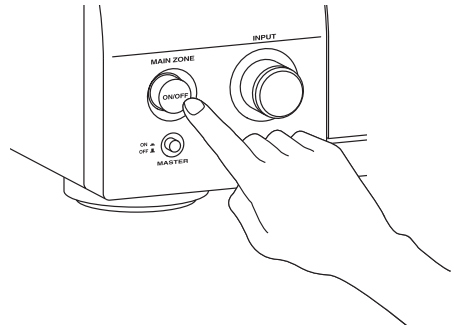

Press **Ⓑ** **MAIN ZONE ON/OFF** to set this unit to the standby mode.







This unit is set to the standby mode and consumes a small amount of power in order to receive infrared signals from the remote control. To turn on this unit from the standby mode, press **Ⓑ** **MAIN ZONE ON/OFF** on the front panel (or **Ⓑ** **POWER** on the remote control). See page 33 for details.

What do you want to do with this unit?



Using various input sources

- Basic operations of this unit  P. 42
- Enjoying FM/AM radio programs  P. 54
- Enjoying XM Satellite Radio programs  P. 58
- Using your iPod with this unit  P. 64





Using various sound features

- Using various sound field programs  P. 46
- Using the Pure Direct mode for high fidelity sound  P. 52
- Adjusting the tonal quality of the speakers  P. 52
- Customizing the sound field programs  P. 67











Adjusting the parameters of this unit

- Automatically optimizing the speaker parameters for your listening room (AUTO SETUP)  P. 37
- Setting the remote control  P. 100



Additional features

- Displaying the current input source signal information in the OSD  P. 44
- Saving and recalling the system settings of this unit (SYSTEM MEMORY)  P. 96
- Using headphones  P. 43
- Using this unit in multiple rooms simultaneously (multi-zone configuration)  P. 111
- Automatically turning off this unit  P. 45

Manually adjusting various parameters of this unit

- Setting the basic speaker configuration  P. 80
- Adjusting the balance of the speaker levels  P. 82
- Setting the distance of each speaker  P. 83
- Setting the parameters related to the volume level  P. 84
- Adjusting the tonal quality by using the graphic equalizer  P. 85
- Adjusting the lip sync function for the HDMI connection  P. 87
- Assigning the input/output jacks of this unit  P. 89
- Setting the parameters of the front panel display or OSD  P. 91
- Setting the parameters related to the video signals  P. 92
- Protecting the various settings  P. 93
- Setting the parameters of the multi-zone feature  P. 94

Adjusting the advanced parameters

- Setting the speaker impedance of the connected speakers  P. 117
- Setting the parameters of this unit to default values  P. 120

Connections

Rear panel

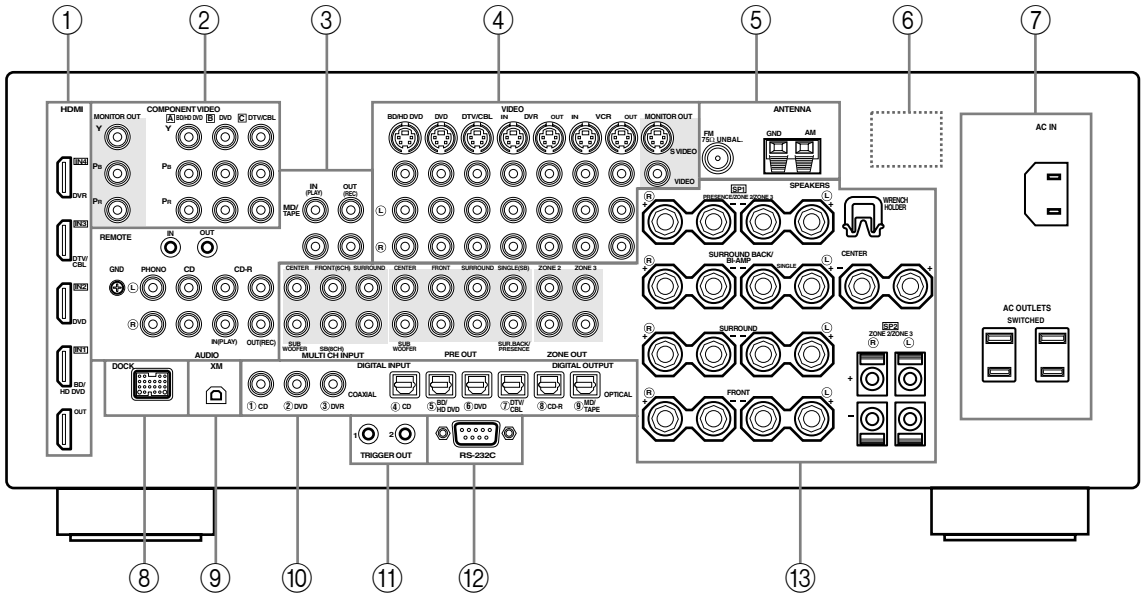

	Name	Page
①	HDMI jacks	21
②	COMPONENT VIDEO jacks	24 – 27
③	Audio component jacks	28
	REMOTE IN/OUT jacks	31, 111
④	Video component jacks	24 – 27
⑤	ANTENNA terminals	32
⑥	VOLTAGE SELECTOR (Asia and General models only)	32
⑦	AC IN	32
	AC OUTLET(S)	32
⑧	DOCK terminal	31
⑨	XM jack (U.S.A. and Canada models only)	58
⑩	DIGITAL INPUT/OUTPUT jacks	25
⑬	MULTI CH INPUT jacks	30
	PRE OUT jacks	29
	ZONE OUT jacks	111
	Speaker terminals	16
	WRENCH HOLDER	18

⑪ TRIGGER OUT jacks

These are control expansion terminals for custom installation.

⑫ RS-232C terminal

This is a control expansion terminal for factory use only. Consult your dealer for details.

Placing speakers

The speaker layout below shows the speaker setting we recommend. You can use it to enjoy the CINEMA DSP and multi-channel audio sources.

■ 7.1-channel speaker layout

7.1-channel speaker layout is highly recommended to play back of the sound of high definition digital audio formats (Dolby TrueHD, DTS-HD Master Audio, etc.) as well as the conventional audio sources with sound field programs. See page 16 for connection information.

 We recommend that you also add the presence speakers for the effect sounds of the CINEMA DSP sound field program. See page 46 for details.

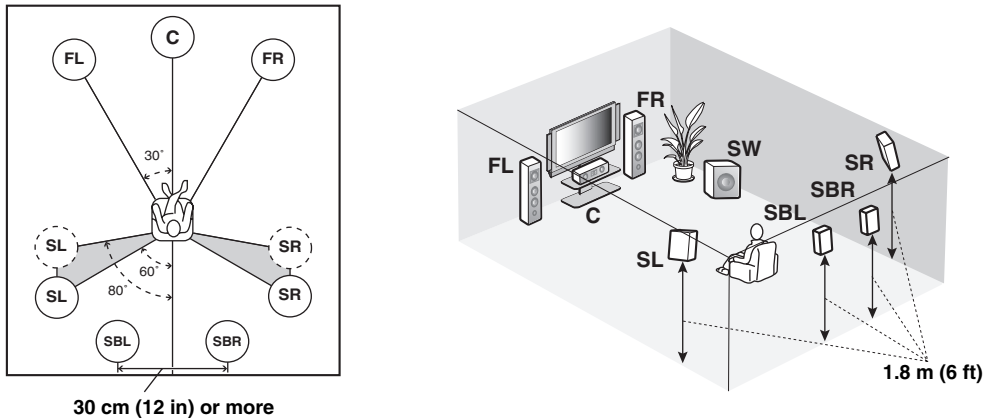

Front left and right speakers (FL and FR)

The front speakers are used for the main source sound plus effect sounds. Place these speakers at an equal distance from the ideal listening position. The distance of each speaker from each side of the video monitor should be the same.

Center speaker (C)

The center speaker is for the center channel sounds (dialog, vocals, etc.). If for some reason it is not practical to use a center speaker, you can do without it. Best results, however, are obtained with the full system.

Surround left and right speakers (SL and SR)

The surround speakers are used for effect and surround sounds.

Surround back left and right speakers (SBL and SBR)

The surround back speakers supplement the surround speakers and provide more realistic front-to-back transitions.

Subwoofer (SW)

The use of a subwoofer with a built-in amplifier, such as the Yamaha Active Servo Processing Subwoofer System, is effective not only for reinforcing bass frequencies from any or all channels, but also for reproducing the high fidelity sound of the LFE (low-frequency effect) channel included in bitstreams and multi-channel PCM sources. The position of the subwoofer is not so critical, because low bass sounds are not highly directional. But it is better to place the subwoofer near the front speakers. Turn it slightly toward the center of the room to reduce wall reflections.

■ 6.1-channel speaker layout

See page 17 for connection information.



We recommend that you also add the presence speakers for the effect sounds of the CINEMA DSP sound field program. See page 15 for details.

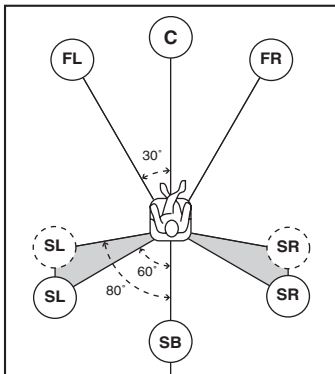
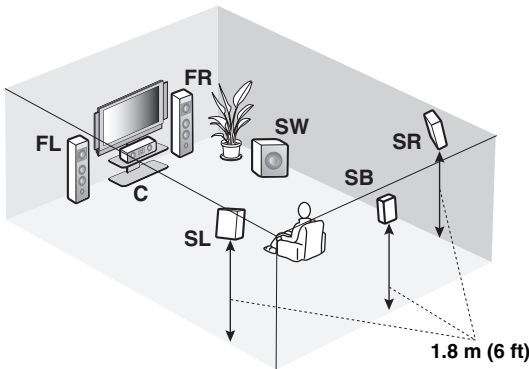

- Front left and right speakers (FL and FR)**
- Center speaker (C)**
- Surround left and right speakers (SL and SR)**
- Subwoofer (SW)**

The function and settings of each speaker are the same as those for the 7.1-channel speaker layout (see page 13).

Surround back speaker (SB)

Connect a single surround speaker to the SURROUND BACK (SINGLE) speaker terminals and place the single surround back speaker behind the listening position. The surround back left and right channel signals are mixed down and output at the single surround back speaker when you set "SUR.B L/R SP" to "SMLx1" or "LRGx1" (see page 81).

■ 5.1-channel speaker layout

See page 17 for connection information.



We recommend that you also add the presence speakers for the effect sounds of the CINEMA DSP sound field program. See page 15 for details.

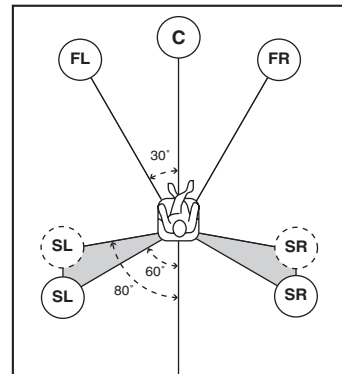
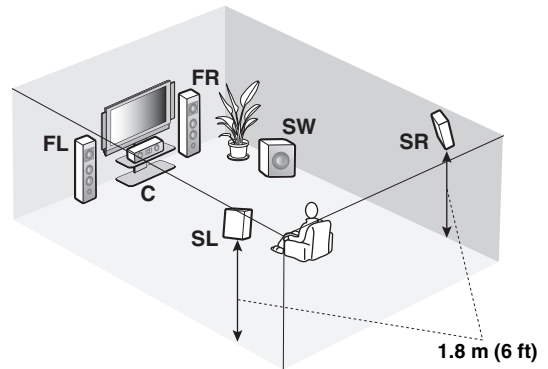

- Front left and right speakers (FL and FR)**
- Center speaker (C)**
- Subwoofer (SW)**

The function and settings of each speaker are the same as those for the 7.1-channel speaker layout (see page 13).

Surround left and right speakers (SL and SR)

Connect the surround speakers to the SURROUND speaker terminals even if you place the surround speakers behind the listening position.

For the smooth and unbroken sound field behind the listening position, place the surround left and right speakers farther back compared with the placement in the 7.1-channel speaker layout.

The surround back channel signals are directed to the surround left and right speakers when "SUR.B L/R SP" is set to "NONE" (see page 81).

For other speaker combinations

You can enjoy multi-channel sources with sound field programs by using a speaker combination other than the 7.1/6.1/5.1-channel speaker combinations.

Use the automatic setup feature (see page 37) or set the "SPEAKER SET" parameters in "MANUAL SETUP" (see page 80) to output the surround sounds at the connected speakers.

■ Presence left and right speakers (PL and PR)

The presence speakers supplement the sound from the front speakers with extra ambient effects produced by the sound field programs (see page 46). We recommend that you use the presence speakers especially for the CINEMA DSP sound field programs. To use the presence speakers, connect the speakers to SP1 speaker terminals and then set “PRESENCE SP” to “YES” (see page 81).

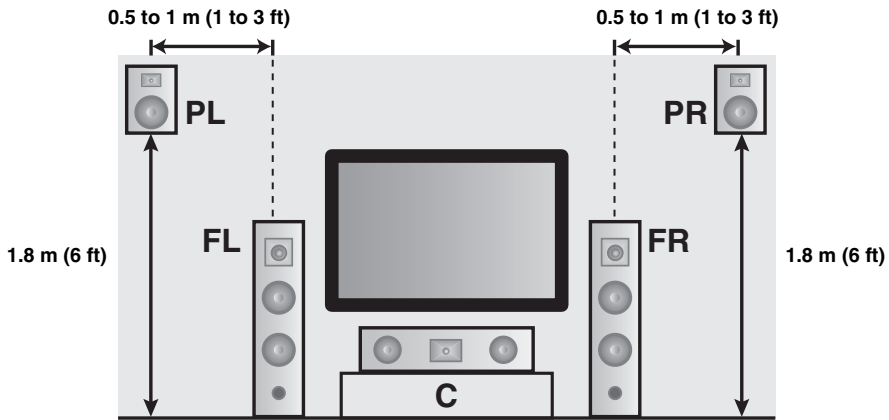

Note

You can connect both surround back and presence speakers to this unit, but they do not output sound simultaneously. This unit automatically switches the presence speakers and surround back speakers depending on the input sources and the selected sound field programs. You can set to prioritize either set of speakers using the “PRIORITY” parameter in “MANUAL SETUP” (see page 82).

Connecting speakers

Be sure to connect the left channel (L), right channel (R), “+” (red) and “-” (black) properly. If the connections are faulty, this unit cannot reproduce the input sources accurately.

Caution

- Before connecting the speakers, make sure that this unit is turned off (see page 33).
- Do not let the bare speaker wires touch each other or do not let them touch any metal part of this unit. This could damage this unit and/or speakers.
- Use magnetically shielded speakers. If this type of speaker still creates interference with the monitor, place the speakers away from the monitor.
- If you are to use 6-ohm speakers, be sure to set “SPEAKER IMP.” to “6Ω MIN” before using this unit (see page 33). You can also use 4-ohm speakers as the front speakers (see page 117).

Notes

- A speaker cord is actually a pair of insulated cables running side by side. Cables are colored or shaped differently, perhaps with a stripe, groove or ridge. Connect the striped (grooved, etc.) cable to the “+” (red) terminals of this unit and your speaker. Connect the plain cable to the “-” (black) terminals.
- You can use the SP1 terminals to connect the Zone 2 or Zone 3 speakers as well as the presence speakers (see page 111).
- You can connect both surround back and presence speakers to this unit, however they do not output sound simultaneously. This unit automatically switches the presence speakers and surround back speakers depending on the input sources and the selected sound field programs. You can set to prioritize either set of speakers using the “PRIORITY” parameter in “MANUAL SETUP” (see page 82).

■ For the 7.1-channel speaker setting

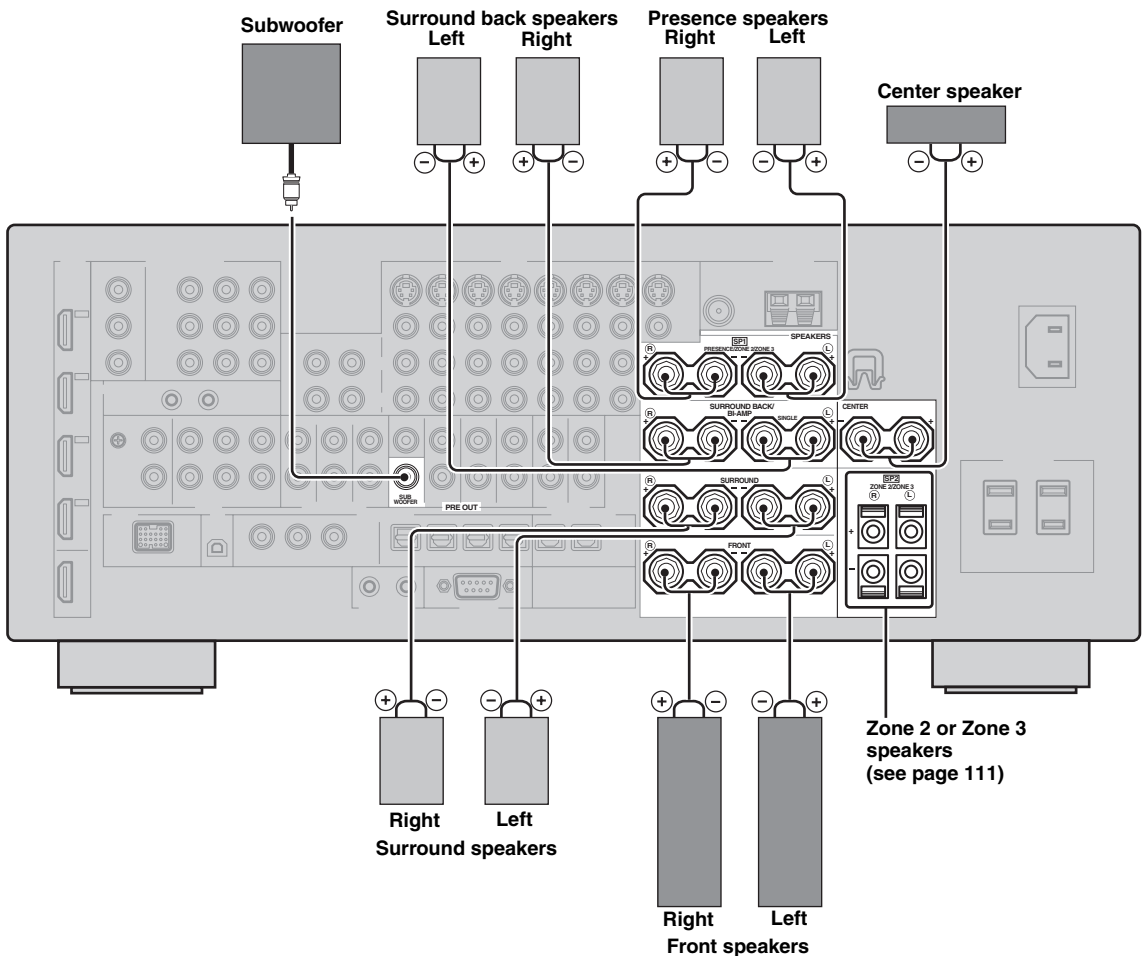

■ For the 6.1-channel speaker setting

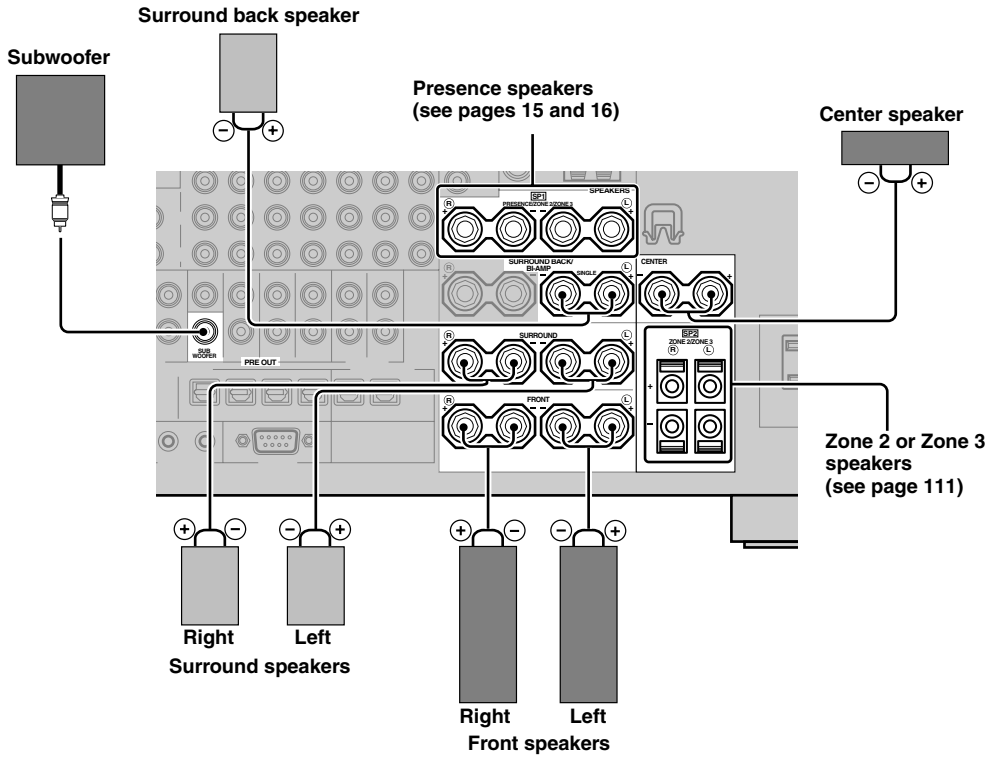

■ For the 5.1-channel speaker setting

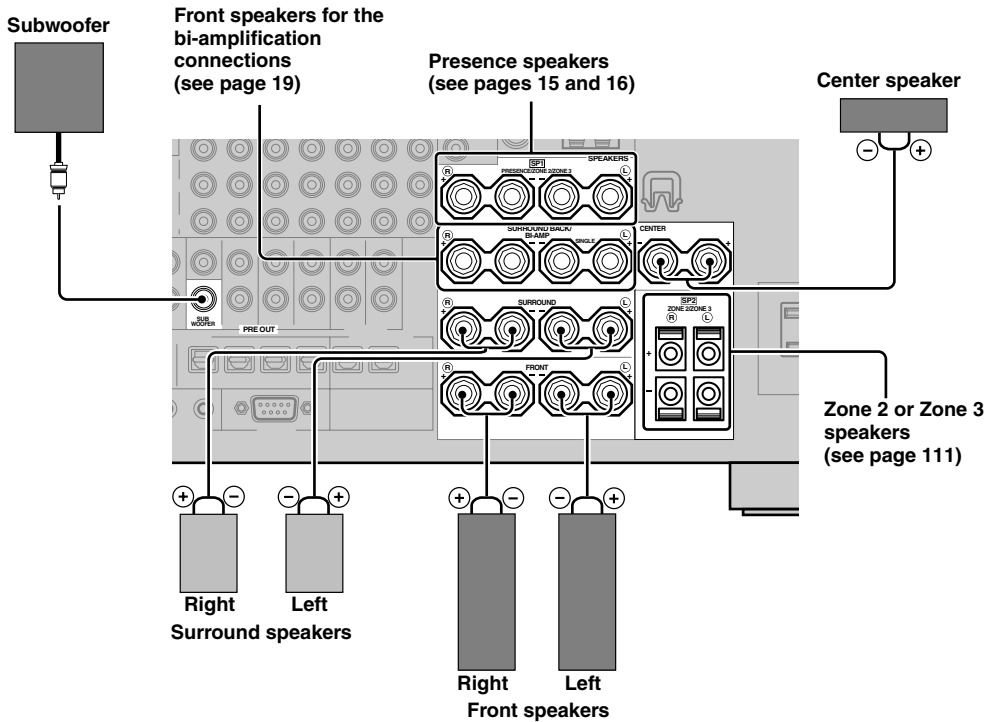

■ Connecting the speaker cable

- 1 Remove approximately 10 mm (0.4 in) of insulation from the end of each speaker cable and then twist the exposed wires of the cable together to prevent short circuits.

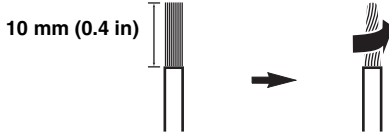

- 2 Loosen the knob using the supplied speaker terminal wrench.

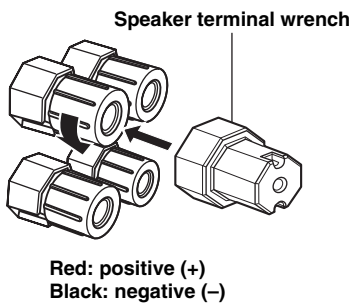

- 3 Insert one bare wire into the hole on the side of each terminal.

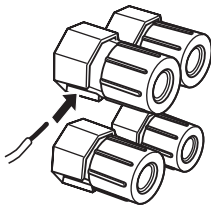

- 4 Tighten the knob to secure the wire using the supplied speaker terminal wrench.

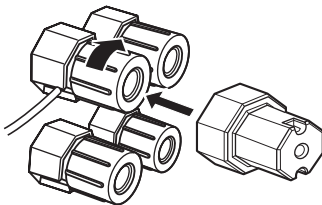

- 5 Hook the speaker terminal wrench onto WRENCH HOLDER on the rear panel of this unit when not in use.

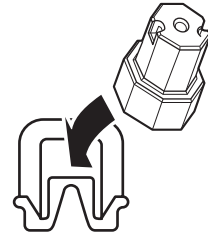

■ Connecting to the SP2 speaker terminals

Connect Zone 2 or Zone 3 speakers to these terminals (see page 111).

- 1 Open the tab.

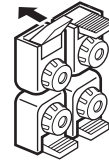

Red: positive (+)
Black: negative (-)

- 2 Insert one bare wire into the hole on the terminal.

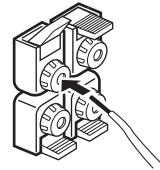

- 3 Close the tab to secure the wire.

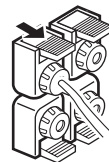

■ Connecting the banana plug (Except U.K., Europe, Asia and Korea models)

1 Tighten the knob using the supplied speaker terminal wrench.

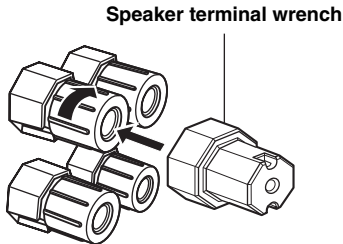

Red: positive (+)
Black: negative (-)

2 Insert the banana plug connector into the end of the corresponding terminal.

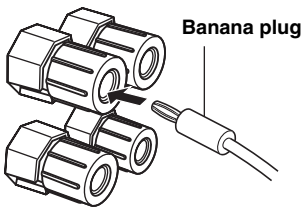

You can also use the banana plug with the SP2 speaker terminals. Open the tab and then insert one banana plug into the hole on the terminal. Do not close the tab after connecting the banana plug.

■ Using bi-amplification connections

Caution

Remove the shorting bars or bridges of your speakers to separate the LPF (low pass filter) and HPF (high pass filter) crossovers.

This unit allows you to make bi-amplification connections to one speaker system. Check if your speakers support bi-amplification connection.

To make the bi-amplification connections, use the FRONT and SURROUND BACK/BI-AMP speaker terminals as shown below. To activate the bi-amplification connections, set "BI-AMP" to "ON" in "ADVANCED SETUP" (see page 120).

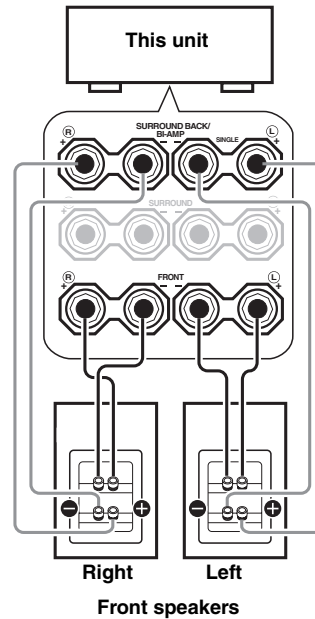

Note

When you make the conventional connection with the speakers, make sure that the shorting bars are put into the terminals of the speakers appropriately. Refer to the instruction manuals of the speakers for details.

Information on jacks and cable plugs

Audio jacks and cable plugs

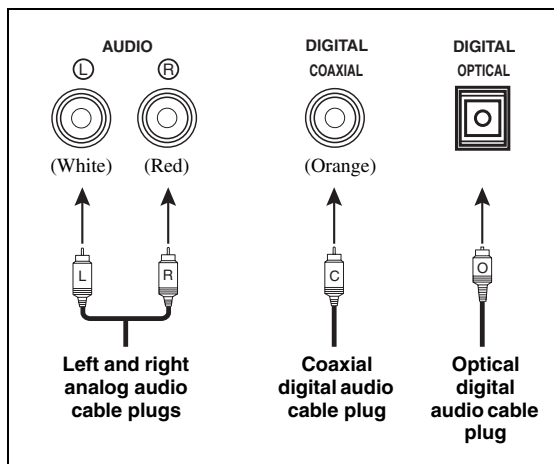

Video jacks and cable plugs

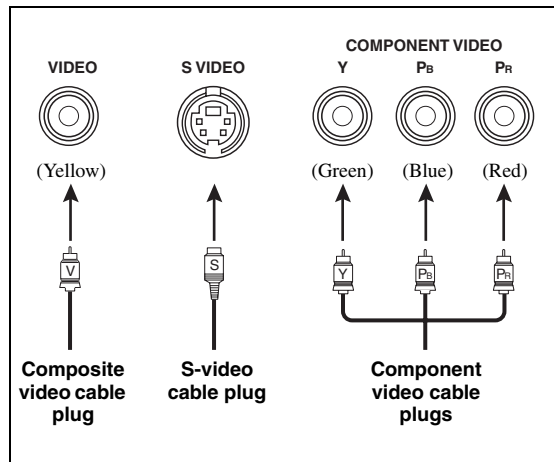

■ Audio jacks

This unit has three types of audio jacks. Connection depends on the availability of audio jacks on your other components.

AUDIO jacks

For conventional analog audio signals transmitted via left and right analog audio cables. Connect red plugs to the right jacks and white plugs to the left jacks.

DIGITAL COAXIAL jacks

For digital audio signals transmitted via coaxial digital audio cables.

DIGITAL OPTICAL jacks

For digital audio signals transmitted via optical digital audio cables.

Note

You can use the digital jacks to input PCM, Dolby Digital and DTS bitstreams. When you connect components to both the COAXIAL and OPTICAL jacks, priority is given to the signals input at the COAXIAL jack. All digital input jacks are compatible with up to 96-kHz sampling digital signals.

■ Video jacks

This unit has three types of video jacks. Connect the video input jacks of this unit to the video output jacks of the input source components to switch the audio and video sources simultaneously. Connection depends on the availability of input jacks on your video monitor.

VIDEO jacks

For conventional composite video signals transmitted via composite video cables.

S VIDEO jacks

For S-video signals, separated into the luminance (Y) and chrominance (C) video signals transmitted on separate wires of S-video cables.

COMPONENT VIDEO jacks

For component video signals, separated into the luminance (Y) and chrominance (P_B, P_R) video signals transmitted on separate wires of component video cables.



This unit is equipped with the video conversion function. See pages 23 and 92 for details.

Information on HDMI™

This unit has four HDMI input jacks and one HDMI output jack for digital audio and video signal input/output. Connect the HDMI IN 1, HDMI IN 2, HDMI IN 3 or HDMI IN 4 jack of this unit to the HDMI output jack of other HDMI components (such as a DVD player). Connect the HDMI OUT jack of this unit to the HDMI input jack of other HDMI components (such as a TV and a projector).

The video or audio signals input at the HDMI IN jacks of the selected input source are output at the HDMI OUT jack of this unit.

This HDMI interface of this unit is based on the following standards:

- HDMI Version 1.3a (High-Definition Multimedia Interface Specification Version 1.3a) licensed by HDMI Licensing, LLC.
- HDCP (High-bandwidth Digital Content Protection System) licensed by Digital Content Protection, LLC.

Note

You can check the potential problem about the HDMI connection (see page 44).

■ HDMI jack and cable plug

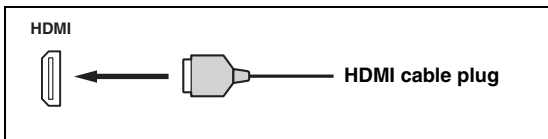

- We recommend that you use a commercially available HDMI cable shorter than 5 meters (16 feet) with the HDMI logo printed on it.
- Use a conversion cable (HDMI jack ↔ DVI-D jack) to connect this unit to other DVI components.

Notes

- Do not disconnect or connect the cable or turn off the power of the HDMI components connected to the HDMI OUT jack of this unit while data is being transferred. Doing so may disrupt playback or cause noise.
- The HDMI OUT jack outputs the audio signals input at the HDMI input jacks only even if “SUPPORT AUDIO” is set to “OTHER” (see page 88).
- If you turn off the power of the video monitor connected to the HDMI OUT jack via a DVI connection, this unit may fail to establish the connection to the component.
- The analog video signals input at the composite video, S-video and component video jacks can be digitally up-converted to be output at the HDMI OUT jack. Set “VIDEO CONV.” to “ON” in “MANUAL SETUP” (see page 92) to activate this feature.

■ Default input assignment of HDMI input jacks

HDMI input jack	Assigned input source
IN1	BD/HD DVD
IN2	DVD
IN3	DTV/CBL
IN4	DVR

■ HDMI signal compatibility with this unit

Audio signals

Audio signal types	Audio signal formats	Compatible media
2ch Linear PCM	2ch, 32-192 kHz, 16/20/24 bit	CD, DVD-Video, DVD-Audio, etc.
Multi-ch Linear PCM	8ch, 32-192 kHz, 16/20/24 bit	DVD-Audio, etc.
DSD	2/5.1ch, 2.8224 MHz, 1 bit	SACD, etc.
Bitstream	Dolby Digital, DTS	DVD-Video, etc.
Bitstream (High definition audio)	Dolby TrueHD, Dolby Digital Plus, DTS-HD Master Audio, DTS-HD High Resolution Audio	Blu-ray Disc, HD DVD, etc.



- If the input source component can decode the bitstream audio signals of audio commentaries, you can play back the audio sources with the audio commentaries mixed down by using the following connections:
 - multi-channel analog audio input (see page 30)
 - DIGITAL INPUT OPTICAL (or COAXIAL)
- Refer to the supplied instruction manuals of the input source component, and set the component appropriately.

Notes

- When CPPM copy-protected DVD audio is played back, video and audio signals may not be output depending on the type of the DVD player.
- This unit is not compatible with HDCP-incompatible HDMI or DVI components.
- To decode the audio bitstream signals on this unit, set the input source component appropriately so that the component outputs the audio bitstream signals directly (does not decode the bitstream signals on the component). Refer to the supplied instruction manuals for details.
- This unit is not compatible with the audio commentary features (for example, the special audio contents downloaded via Internet) of Blu-ray Disc or HD DVD. This unit does not play back the audio commentaries of the Blu-ray Disc or HD DVD contents.

Video signals

This unit is compatible with the video signals of the following resolutions:

Video signal format

- 480i/576i
- 480p/576p
- 720p
- 1080i
- 1080p

Refresh rate

- 59.94(60)/50 Hz

This unit also accepts 30 or 36-bit Deep Color video signal.

Audio and video signal flow

Audio signal flow

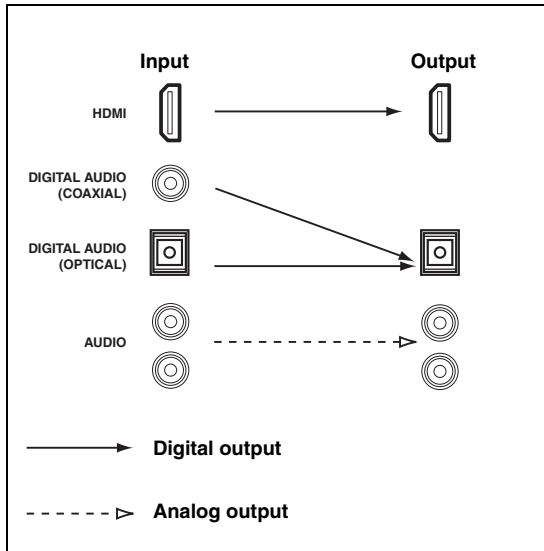

Notes

- 2-channel as well as multi-channel PCM, Dolby Digital and DTS signals input at one of the HDMI input jacks can be output at the HDMI OUT jack only when “SUPPORT AUDIO” is set to “OTHER” (see page 88).
- The following types of audio signals can be only input at HDMI input jacks:
 - DSD
 - Dolby TrueHD
 - Dolby Digital Plus
 - DTS-HD Master Audio
 - DTS-HD High Resolution Audio

Video signal flow

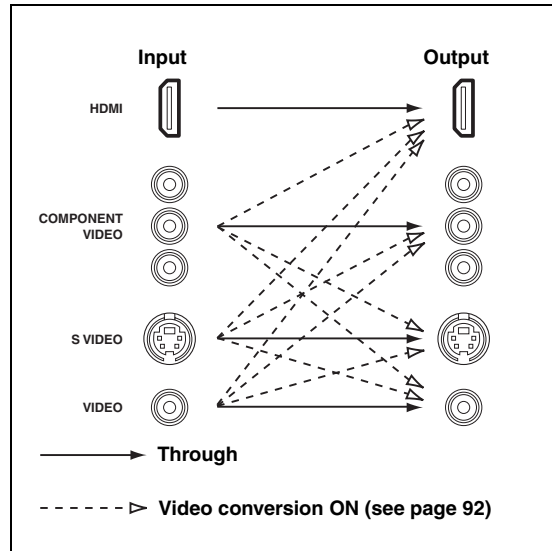

You can deinterlace and convert the resolution of the video signals by using “VIDEO SET” parameters. See page 92 for details.

Notes

- When the analog video signals are input at the COMPONENT VIDEO, S VIDEO and VIDEO jacks, the priority order of the input signals is as follows:
 1. COMPONENT VIDEO
 2. S VIDEO
 3. VIDEO
- Digital video signals input at the HDMI input jacks cannot be output from analog video output jacks.
- The analog component video signals (with 480i (NTSC)/576i (PAL) of resolution only) are converted to the S-video or composite video signals and output at the VIDEO or S VIDEO MONITOR OUT jacks.
- The analog component video signals with 1080p of resolution are only output at the COMPONENT VIDEO MONITOR OUT jacks.
- The OSD signal is not output at the DVR OUT and VCR OUT jacks and is not recorded.

Connecting a TV monitor or projector

Connect your TV (or projector) to the HDMI OUT jack, the COMPONENT VIDEO MONITOR OUT jacks, the S VIDEO MONITOR OUT jack or the VIDEO MONITOR OUT jack of this unit.



Make sure that this unit and other components are unplugged from the AC wall outlets.



You can select to play back HDMI audio signals on this unit or on another HDMI component connected to the HDMI OUT jack on the rear panel of this unit. Use the "SUPPORT AUDIO" parameter in "SOUND MENU" to select the component to play back HDMI audio signals (see page 88).

Notes

- Some video monitors connected to this unit via a DVI connection fail to recognize the HDMI audio/video signals being input if they are in the standby mode. In this case, the HDMI indicator flashes irregularly.
- Set "VIDEO CONV." in "OPTION MENU" to "ON" (see page 92) to display the short message displays and sound field parameter displays.
- The "SET MENU" and sound field parameter displays appear with the gray background depending on the input video signal format and the setting of the parameters in "DISPLAY SET" (see page 91).
- If the connected video monitor is compatible with the automatic audio and video synchronization feature (automatic lip sync feature), this unit adjusts the audio and video timing automatically (see page 87). Connect the video monitor to the HDMI OUT jack of this unit to use the feature.

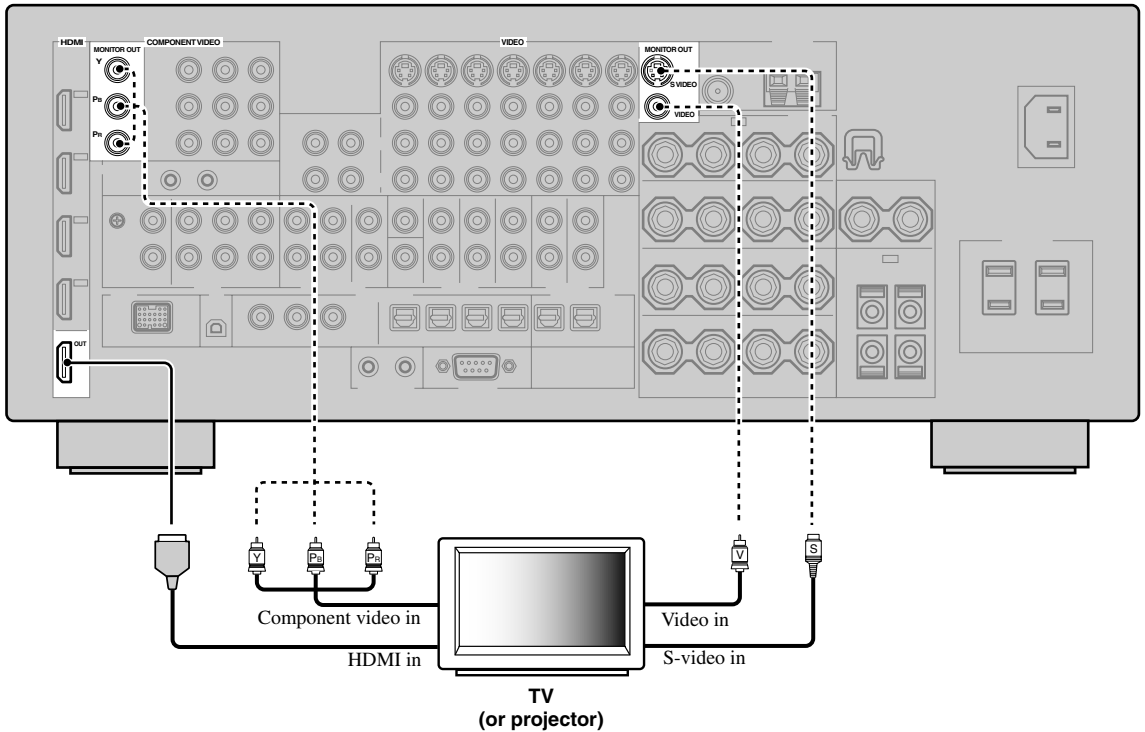

———— indicates recommended connections

- - - - - indicates alternative connections

Connecting other components



Make sure that this unit and other components are unplugged from the AC wall outlets.

Notes

- When “VIDEO CONV.” is set to “OFF” (see page 92), be sure to make the same type of video connections as those made for your TV (see page 24). For example, if you connected your TV to the VIDEO MONITOR OUT jack of this unit, connect your other components to the VIDEO jacks.

- When “VIDEO CONV.” is set to “ON” (see page 92), the converted video signals are output only at the MONITOR OUT jacks. When recording a source, you must make the same type of video connections between each component.
- To make a digital connection to a component other than the default component assigned to each DIGITAL INPUT or DIGITAL OUTPUT jack, select the corresponding setting for “OPTICAL OUT”, “OPTICAL IN”, or “COAXIAL IN” in “I/O ASSIGNMENT” (see page 89).
- If you connect your DVD player to both the DIGITAL INPUT OPTICAL and the DIGITAL INPUT COAXIAL jacks, priority is given to the signals input at the DIGITAL INPUT COAXIAL jack.
- The short message displays do not appear when the component video signals with 480p/576p, 720p, 1080i or 1080p resolutions are input.

■ Connecting a Blu-ray Disc or HD DVD player

Connect your Blu-ray Disc or HD DVD player to the HDMI IN 1 jack of this unit to perform the features of the Blu-ray Disc or HD DVD completely.

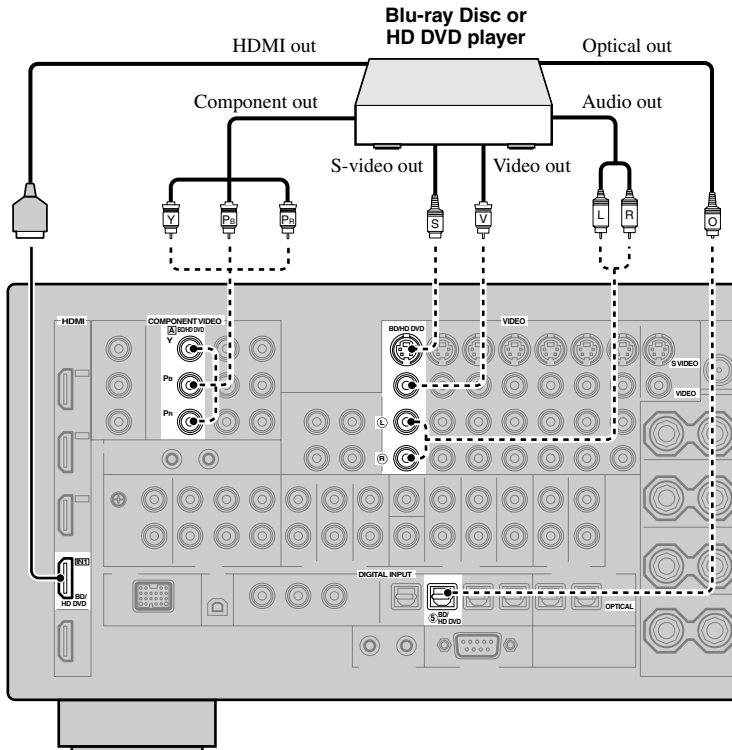

———— indicates recommended connections

----- indicates alternative connections

■ Connecting a DVD player

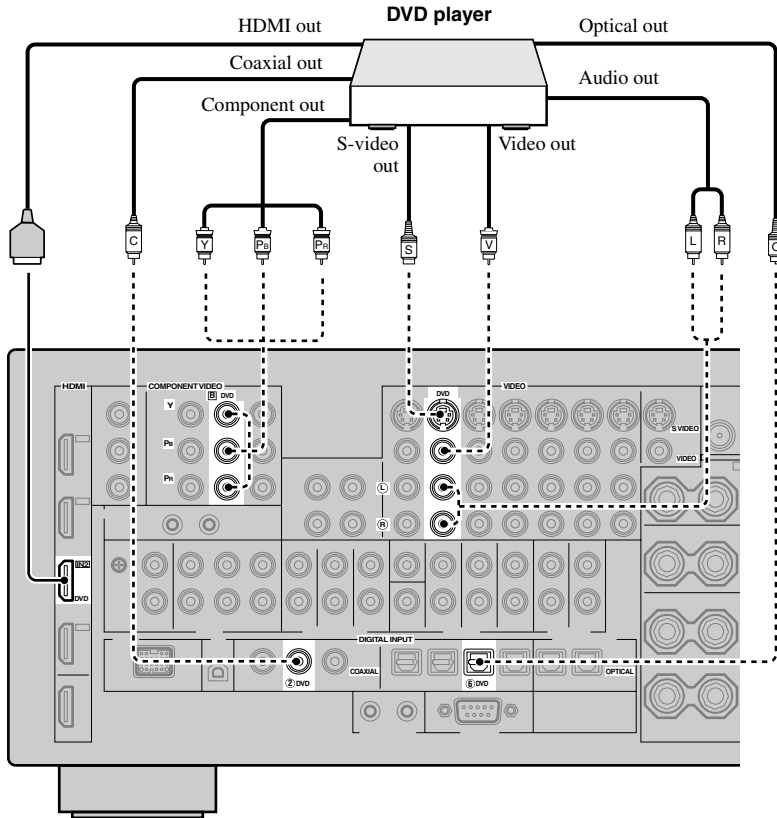

————— indicates recommended connections
- - - - - indicates alternative connections

■ Connecting a DVD recorder, PVR or VCR

Note

* When you connect another VCR to this unit, connect it to the VCR terminals (S VIDEO IN, VIDEO IN, AUDIO IN, S VIDEO OUT, VIDEO OUT and AUDIO OUT jacks) same as DVR terminals except the DIGITAL INPUT (COAXIAL) jack.

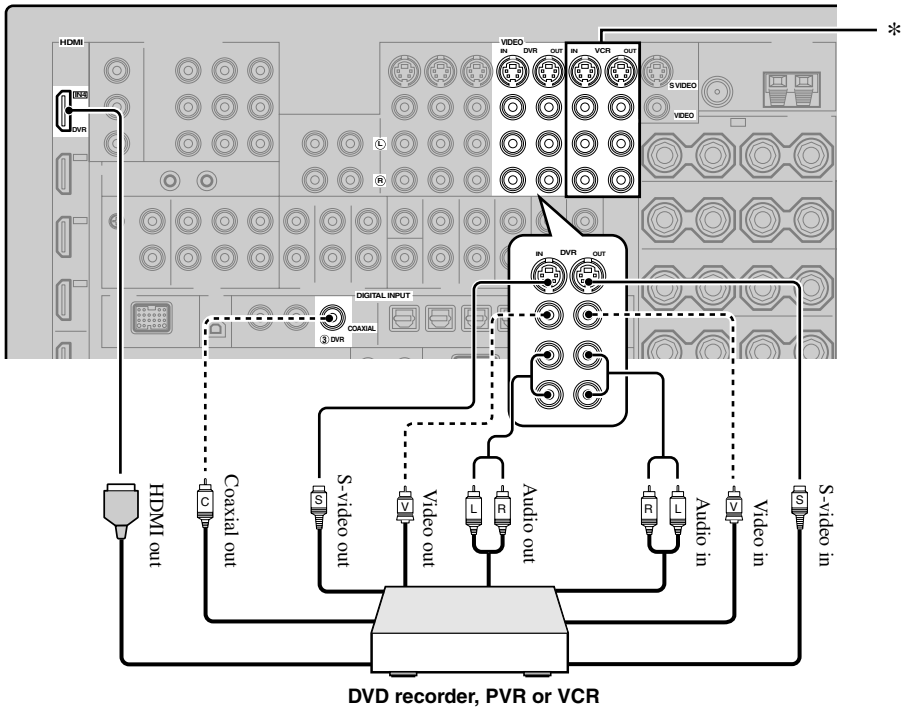

■ Connecting a set-top box

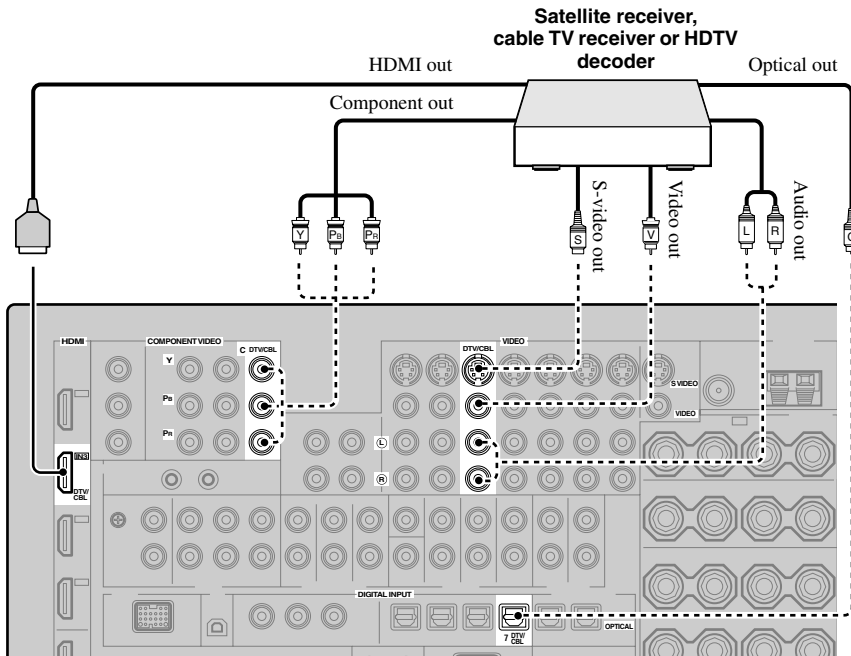

■ Connecting audio components

Notes

- Connect your turntable to the GND terminal of this unit to reduce noise in the signal. However, you may hear less noise without the connection to the GND terminal for some turntables.
- The PHONO jacks are only compatible with a turntable with an MM or a high-output MC cartridge. To connect a turntable with a low-output MC cartridge to the PHONO jacks, use an in-line boosting transformer or an MC-head amplifier.
- When you connect both the DIGITAL INPUT OPTICAL jack and the DIGITAL INPUT COAXIAL jack to an audio component, the priority is given to the DIGITAL INPUT COAXIAL jack.

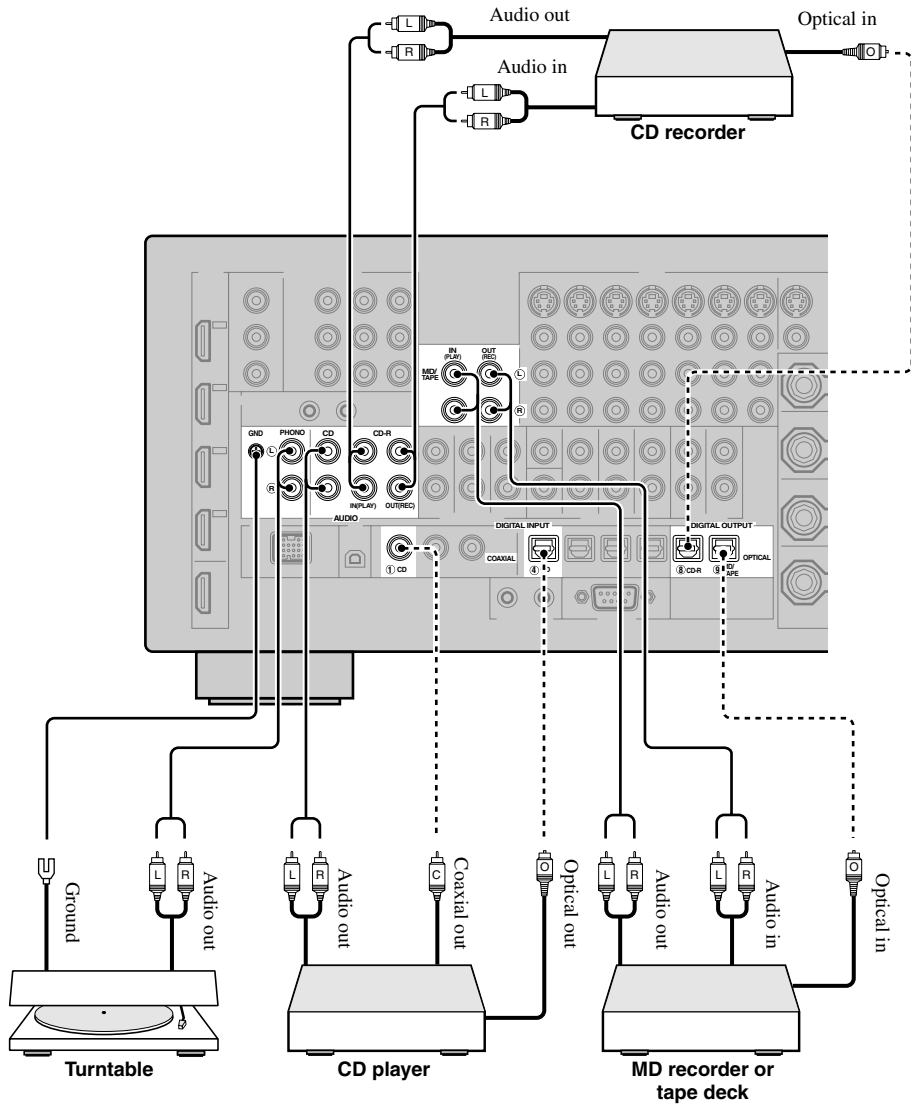

—————	indicates recommended connections
- - - - -	indicates alternative connections

■ Connecting an external amplifier

This unit has more than enough power for any home use. However, if you want to add more power to the speaker output or if you want to use another amplifier, connect an external amplifier to the PRE OUT jacks.

Notes

- When you make connections to the PRE OUT jacks, do not make any connections to the SPEAKERS terminals.
- Each PRE OUT jack outputs the same channel signals as the corresponding SPEAKERS terminals.
- Adjust the volume level of the subwoofer with the control on the subwoofer unit.
- Some signals may not be output at the SUBWOOFER PRE OUT jack depending on the settings for “SPEAKER SET” (see page 80).
- You can use the automatic setup feature even if you use an external amplifier (see page 37).

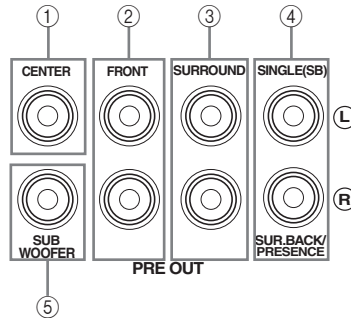

① CENTER PRE OUT jack

Center channel output jack.

② FRONT PRE OUT jacks

Front channel output jacks.

③ SURROUND PRE OUT jacks

Surround channel output jacks.

④ SUR.BACK/PRESENCE PRE OUT jacks

Surround back or presence channel output jacks. When you only connect one external amplifier for the surround back channel, connect it to the SINGLE (SB) jack.



- Set the “SUR.B L/R SP” to “LRGx2”, “LRGx1”, “SMLx2” or “SMLx1” and “PRESENCE SP” to “NONE” (see page 81) to output the surround back channel signals at the SUR.BACK/PRESENCE PRE OUT jacks.
- Set the “PRESENCE SP” to “YES” and “SUR.B L/R SP” to “NONE” (see page 81) to output the presence channel signals at the SUR.BACK/PRESENCE PRE OUT jacks.
- When “BI-AMP” is set to “ON” (see page 19), this unit outputs the front channel audio signals at the SUR.BACK/PRESENCE PRE OUT jacks.

⑤ SUBWOOFER PRE OUT jack

Connect a subwoofer with a built-in amplifier.

■ Connecting a multi-format player or an external decoder

This unit is equipped with 6 additional input jacks (left and right FRONT, CENTER, left and right SURROUND and SUBWOOFER) for discrete multi-channel input from a multi-format player, external decoder, sound processor or pre-amplifier.

If you set "INPUT CH" to "8CH" in "MULTI CH" (see page 90), you can use the input jacks assigned as "FRONT" in "MULTI CH" together with the MULTI CH INPUT jacks to input 8-channel signals.

Connect the output jacks on your multi-format player or external decoder to the MULTI CH INPUT jacks. Be sure to match the left and right outputs to the left and right input jacks for the front and surround channels.

Notes

- When you select the component connected to the MULTI CH INPUT jacks as the input source (see page 43), this unit automatically turns off the digital sound field processor, and you cannot select sound field programs.
- This unit does not redirect signals input at the MULTI CH INPUT jacks to accommodate for missing speakers. We recommend that you connect at least a 5.1-channel speaker system before using this feature.
- When the component connected to the MULTI CH INPUT jacks of this unit is selected as the input source, only the signals input at MULTI CH INPUT FRONT jacks are output from the connected headphones.

For 6-channel input

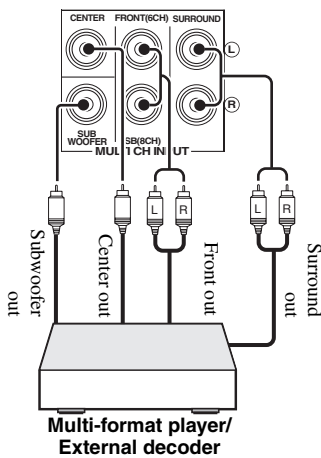

For 8-channel input

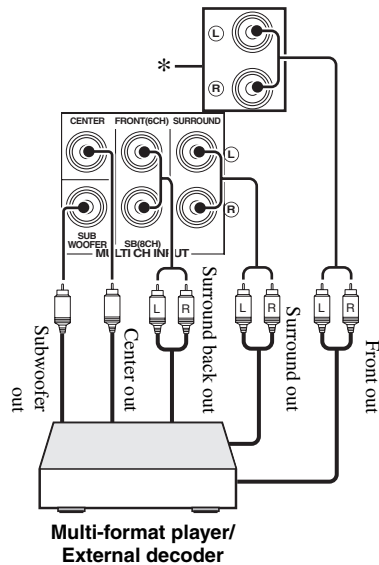

Note

- * The analog audio input jacks assigned as "FRONT" in "MULTI CH" (see page 88).

■ Connecting a Yamaha iPod universal dock

This unit is equipped with the DOCK terminal on the rear panel that allows you to connect a Yamaha iPod universal dock (such as the YDS-10, sold separately), where you can station your iPod and control playback of your iPod using the supplied remote control. Connect a Yamaha iPod universal dock (such as the YDS-10, sold separately) to the DOCK terminal on the rear panel of this unit using its dedicated cable.

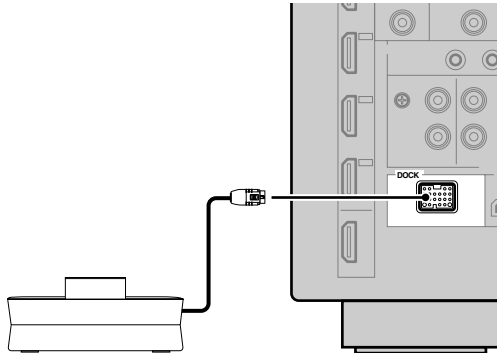

Yamaha iPod universal dock
(such as the YDS-10,
sold separately)

■ Using REMOTE IN/OUT jacks

When the components are the Yamaha products and have the capability of the transmission of the remote control signals, connect the REMOTE IN and REMOTE OUT jack to the remote control input and output jack with the monaural analog mini cable as follows. See page 111 for more details of this feature.

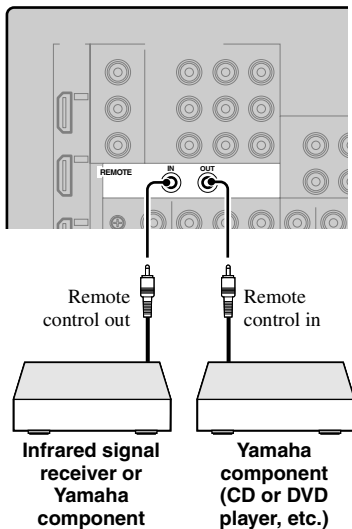

Using the VIDEO AUX jacks on the front panel

Use the VIDEO AUX jacks on the front panel to connect a game console or a video camera to this unit.

Caution

Be sure to turn down the volume of this unit and other components before making connections.

Note

The audio signals input at the DOCK terminal on the rear panel take priority over the ones input at the VIDEO AUX jacks.

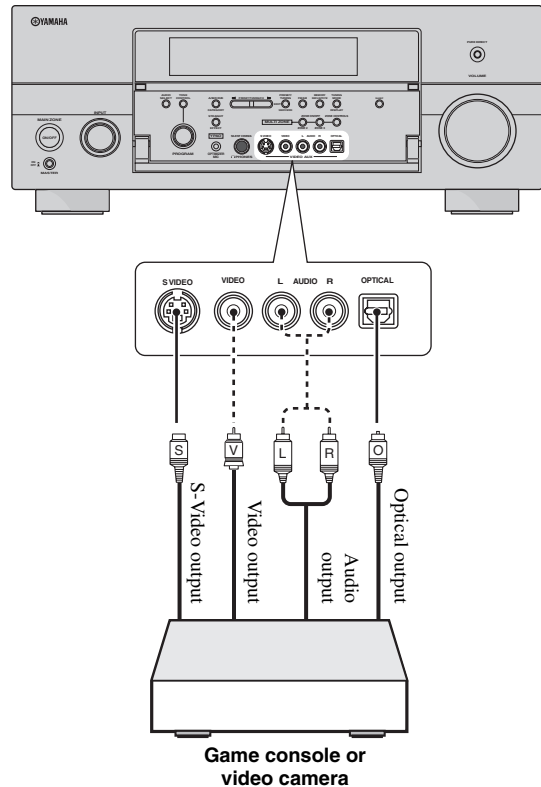

Connecting the FM and AM antennas

Both FM and AM indoor antennas are supplied with this unit. Connect each antenna correctly to the designated terminals. In general, these antennas should provide sufficient signal strength.

Notes

- (Asia and General models only) Be sure to set the tuner frequency step according to the frequency spacing in your area (see page 120).
- The AM loop antenna should be placed away from this unit.
- The AM loop antenna should always be connected, even if an outdoor AM antenna is connected to this unit.
- A properly installed outdoor antenna provides clearer reception than an indoor one. If you experience poor reception quality, install an outdoor antenna. Consult the nearest authorized Yamaha dealer or service center about outdoor antennas.

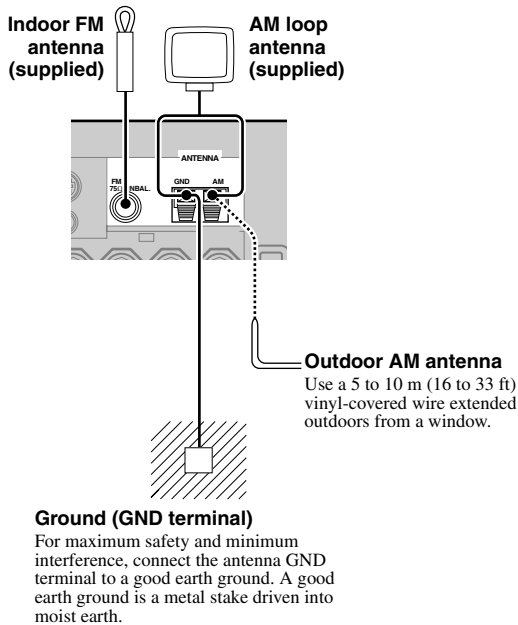

Connecting the power cable

■ Connecting the AC power cable

Plug the supplied AC power cable into the AC inlet after all other connections are complete, then plug the AC power cable into an AC wall outlet.

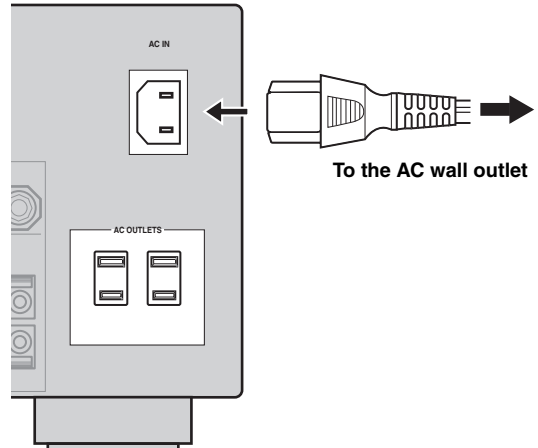

Note

(Asia model only) Select one of the supplied power cables suitable for the type of AC wall outlet in your location before plugging this unit into the AC wall outlet.

■ AC OUTLET(S) (SWITCHED)

U.K. and Australia models..... 1 outlet
 Korea model..... None
 Other models..... 2 outlets

Use these outlet(s) to supply power to any connected components. Connect the power cable of your other components to these outlet(s). Power to these outlet(s) is supplied when this unit is turned on. However, power to these outlet(s) is cut off when this unit is turned off. For information on the maximum power or the total power consumption of the components that can be connected to these outlet(s), see "Specifications" on page 136.

Memory back-up

The memory back-up circuit prevents the stored data from being lost even if this unit is in the standby mode. However, the stored data will be lost in case the power cable is disconnected from the AC wall outlet or if the power supply is cut off for more than one week.

Setting the speaker impedance

Caution

If you are to use 6 ohm speakers, set "SPEAKER IMP." to "6Ω MIN" as follows BEFORE using this unit. You can also use 4 ohm speakers as the front speakers.

- 1 **Make sure this unit is turned off.**
- 2 **Press and hold **⊙**STRAIGHT on the front panel and then press **Ⓐ**MASTER ON/OFF inward to the ON position to turn on this unit.** This unit turns on, and the advanced setup menu appears in the front panel display.
- 3 **Rotate the **Ⓝ**PROGRAM selector to select "SPEAKER IMP."**
- 4 **Press **⊙**STRAIGHT repeatedly to select "6Ω MIN".**
- 5 **Press **Ⓐ**MASTER ON/OFF to release it outward to the OFF position to save the new setting and turn off this unit.**



Note

The setting you made is reflected next time you turn on this unit.

Turning this unit on and off

Turning on this unit

Press **Ⓐ**MASTER ON/OFF on the front panel inward to the ON position to turn on this unit.

When you turn on this unit by pressing **Ⓐ**MASTER ON/OFF, the main zone is turned on.



When you turn on this unit, there will be a delay for a few seconds before this unit can reproduce sound.

Turning off this unit

Press **Ⓐ**MASTER ON/OFF on the front panel again to release it outward to the OFF position to turn off this unit.

Notes

- **Ⓝ**MAIN ZONE ON/OFF on the front panel as well as **Ⓑ**POWER and **Ⓣ**STANDBY on the remote control are operational only when **Ⓐ**MASTER ON/OFF is pressed inward to the ON position.
- Basically, we recommend that you use the standby mode to turn off this unit.

Set the main zone to the standby mode

Press **Ⓑ**MAIN ZONE ON/OFF (or **Ⓣ**STANDBY) to set the main zone to the standby mode.

In the standby mode, this unit consumes a small amount of power in order to receive infrared signals from the remote control.

Turning on the main zone from the standby mode

Press **Ⓑ**MAIN ZONE ON/OFF (or **Ⓑ**POWER) to turn on the main zone.



- When you turn on this unit, there will be a delay for a few seconds before this unit can reproduce sound.
- These buttons are operational only when **Ⓐ**MASTER ON/OFF is pressed inward to the ON position.

If there are some problems...

- First, turn off and then turn on this unit again.
- If problems persist, initialize the parameters of this unit. See page 129 for details.

Front panel display

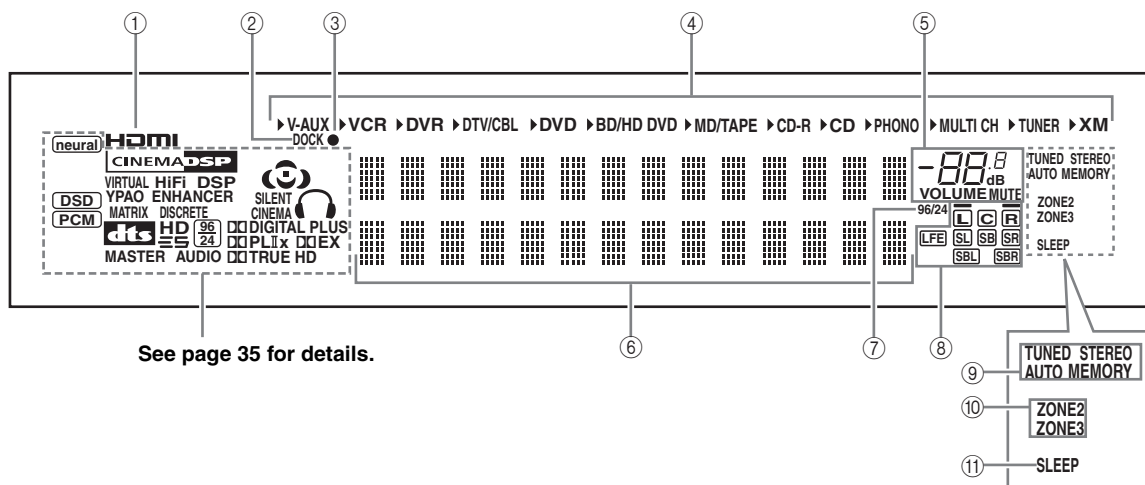

See page 35 for details.

① HDMI indicator

Lights up when the signal of the selected input source is input at one of the HDMI input jacks (see page 21).

② DOCK indicator

Lights up when you station your iPod in a Yamaha iPod universal dock (such as the YDS-10, sold separately) connected to the DOCK terminal of this unit (see page 31).

③ Battery charge indicator

Lights up when this unit charges the battery of the stationed iPod in the standby mode of this unit (see page 64).

④ Input source indicators

The corresponding cursor lights up to show the currently selected input source.

Note

The XM indicator is only applicable to the U.S.A. and Canada models.

⑤ MUTE indicator and VOLUME level indicator

- Indicates the current volume level.
- The MUTE indicator flashes while the MUTE function is on (see page 44).

⑥ Multi-information display

Shows the name of the current sound field program and other information when adjusting or changing settings.

⑦ 96/24 indicator

Lights up when a DTS 96/24 signal is input to this unit.

⑧ Input channel and speaker indicators

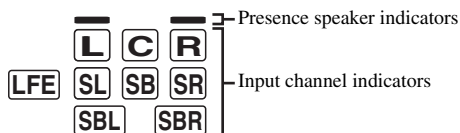

Input channel indicators

- Indicate the channel components of the current digital input signal.
- Light up or flash according to the settings of the speakers when this unit is in the auto setup procedure (see page 37) or the speaker level setting procedure in the “SPEAKER LEVEL” (see page 82).

Presence speaker indicators

Light up according to setting for “PRESENCE SP” (see page 81) in “SPEAKER SET” when this unit is in the auto setup procedure (see page 37) or the speaker level setting procedure in the “SPEAKER LEVEL” (see page 82).



You can make settings for the presence and surround back speakers automatically by running “AUTO SETUP” (see page 37) or manually by adjusting settings for “PRESENCE SP” (see page 81) and “SUR.B L/R SP” (see page 81) in “SPEAKER SET”.

⑨ Tuner indicators

Lights up when this unit is in the FM, AM or XM Satellite Radio tuning mode.

TUNED indicator

Lights up when this unit is tuned into a station (see page 54).

STEREO indicator

Lights up when this unit is receiving a strong signal for an FM stereo broadcast while the AUTO indicator is lit (see page 54).

AUTO indicator

Lights up when this unit is in the automatic tuning mode (see page 54).

MEMORY indicator

Flashes to show that a station can be stored (see pages 55 and 62).

⑩ ZONE2/ZONE3 indicators

Lights up when Zone 2 or Zone 3 is turned on (see page 112).

⑪ SLEEP indicator

Lights up while the sleep timer is on (see page 45).



⑫ neural indicator (U.S.A. and Canada models only)

Lights up when the Neural-THX Surround decoder is activated (see page 74).

⑬ YPAO indicator

Lights up when you run “AUTO SETUP” and when the speaker settings set in “AUTO SETUP” are used without any modifications (see page 37).

⑭ Input signal indicators

Lights up when this unit is reproducing DSD (Direct Stream Digital) or PCM (Pulse Code Modulation) digital audio signals.

⑮ DSP indicators

The respective indicator lights up when any of the sound field programs are selected.

CINEMA DSP indicator

Lights up when you select a CINEMA DSP sound field program (see page 46).

HiFi DSP indicator

Lights up when you select a HiFi DSP sound field program (see page 46).

VIRTUAL indicator

Lights up when Virtual CINEMA DSP is active (see page 51).

⑯ Sound field indicators

Light up to indicate the active sound fields (see page 46).

⑰ ENHANCER indicator

Lights up when the Compressed Music Enhancer mode is turned on (see page 50).

⑱ Headphones indicator

Lights up when headphones are connected (see page 43).

⑲ SILENT CINEMA indicator

Lights up when headphones are connected and a sound field program is selected (see page 51).

⑳ Decoder indicators

The respective indicator lights up when any of the decoders of this unit function.

Using the remote control

The remote control transmits a directional infrared ray. Be sure to aim the remote control directly at the remote control sensor on this unit during operation.

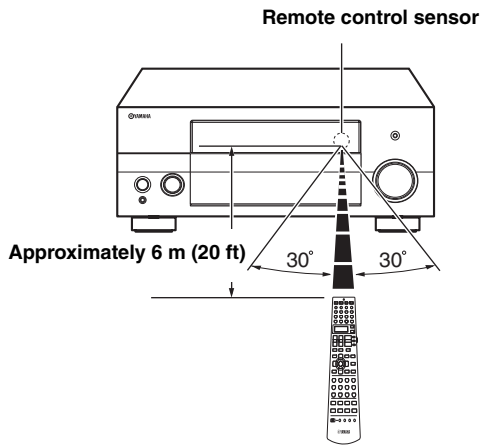

Display window (11)

Shows the name of the selected input source that you can control.

Infrared window (26)

Outputs infrared control signals. Aim this window at the component you want to operate.

Transmit indicator (25)

Flashes while the remote control is sending infrared signals.

Operation mode selector (13)

The function of some buttons depends on the operation mode selector position.

AMP

Operates the amplifier function of this unit.

SOURCE

Operates the component selected with an input selector button (see page 101).

TV

Operates the TV assigned to either DTV/CBL or PHONO (see page 100).

Notes

- Do not spill water or other liquids on the remote control.
- Do not drop the remote control.
- Do not leave or store the remote control in the following conditions:
 - places of high humidity, such as near a bath
 - places of high temperatures, such as near a heater or stove
 - places of extremely low temperatures
 - dusty places
- To set the remote control codes for other components, see page 102.

Opening and closing the front panel door

When you want to use the controls behind the front panel door, open the door by gently pressing on the lower part of the panel. Keep the door closed when not using these controls.

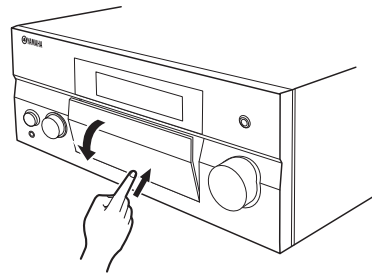

To open, press gently on the lower part of the panel.

Optimizing the speaker setting for your listening room

This unit employs the YPAO (Yamaha Parametric Room Acoustic Optimizer) technology which lets you avoid troublesome listening-based speaker setup and achieves highly accurate sound adjustments automatically. The supplied optimizer microphone collects and this unit analyzes the sound your speakers produce in your actual listening environment.

Using AUTO SETUP

Notes

- Be advised that it is normal for loud test tones to be output during the “AUTO SETUP” procedure.
- To achieve the best results, make sure the room is as quiet as possible while the “AUTO SETUP” procedure is in progress. If there is too much ambient noise, the results may not be satisfactory.
- We recommend that you get out of the room while this unit is in the automatic setup procedure. Keep quiet when you leave the room. It takes approximately 3 minutes for this unit to complete the automatic setup procedure.



- The initial setting for each parameter is indicated in bold.
- Before performing operations, set the operation mode selector on the remote control to **AMP**.

Basic procedure of the automatic setup

1 Make sure of the following check points before starting the AUTO SETUP operations.

- Speakers are connected appropriately.
- Headphones are disconnected from this unit.
- This unit and the video monitor are turned on.
- The connected subwoofer is turned on and the volume level is set to about half way (or slightly less).
- The crossover frequency controls of the connected subwoofer is set to the maximum.
- If you use the external amplifiers (see page 29), the amplifiers are turned on and the settings are appropriate.
- The room is sufficiently quiet.

2 Connect the supplied optimizer microphone to the OPTIMIZER MIC jack on the front panel.

“MIC ON” and “View OSD Menu” appears in the front panel display.

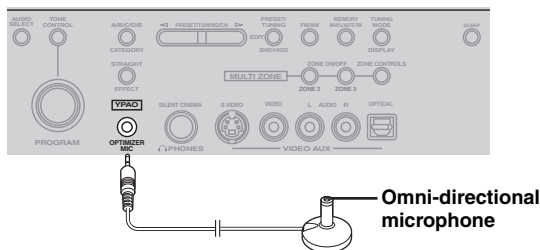

The following menu screen appears on the video monitor.

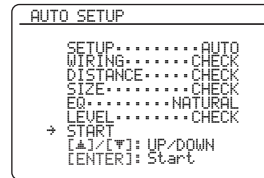

You can also run “AUTO SETUP” using the system menu that appears in the front panel display. When you connect the optimizer microphone to the OPTIMIZER MIC jack, the following display appears in the front panel display. This manual uses the OSD illustrations to explain the “AUTO SETUP” procedure.

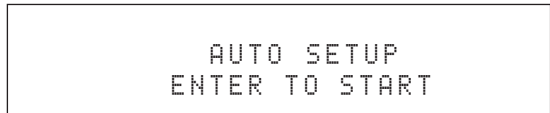

3 Place the optimizer microphone at your normal listening position on a flat level surface with the omni-directional microphone heading upward.

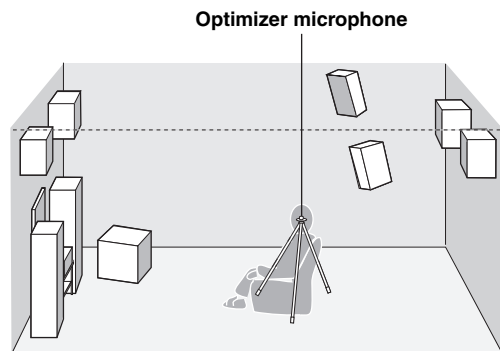

It is recommended that you use a tripod (etc.) to affix the optimizer microphone at the same height as your ears would be when you are seated in your listening position. You can use the attached screw of a tripod (etc.) to fix the optimizer microphone to the tripod (etc.).

4 Press $\text{\textcircled{3}}$ ENTER to start the setup procedure.

This unit starts the automatic setup procedure. Loud test tones are output from each speaker during the automatic setup procedure. Once all items are set, the result display appears in the OSD.

Notes

- During the automatic setup procedure, do not perform any operation on this unit. If you perform any operation while this unit is in the automatic setup procedure, "E-9:USER CANCEL" appears in the OSD. In such cases, select "RETRY" to restart the automatic setup procedure.
- We recommend that you get out of the room while this unit is in the automatic setup procedure. Keep quiet when you leave the room. It takes approximately 3 minutes for this unit to complete the automatic setup procedure.

The display changes as follows.

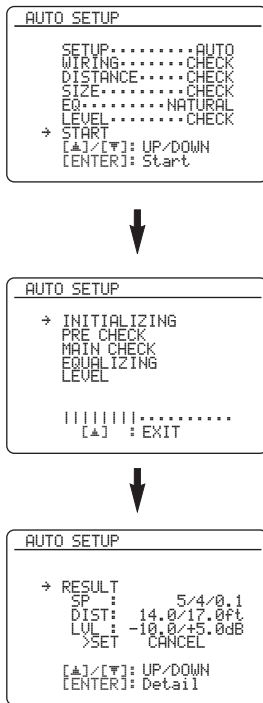

The results displayed under "RESULT" are as follows.

Number of speakers SP

Displays the number of speakers connected to this unit in the following order:
Front/Back/Subwoofer

Speaker distance DIST

Displays the speaker distance from the listening position in the following order:
Closest speaker distance/Farthest speaker distance

Speaker level LVL

Displays the speaker output level in the following order:
Lowest speaker output level/Highest speaker output level

Notes

- If "E-10:INTERNAL ERROR" appears during the testing procedure, restart from step 2.
- When this unit detects potential problems during the automatic setup procedure, "WARNING" and the number of warning messages appears in the above of "RESULT" (see page 41).
- Depending on the listening environment, "SWFR PHASE:REV" appears during the automatic setup procedure and "SUBWOOFER PHASE" in "SOUND MENU" (see page 82) is automatically set to "REVERSE".

5 Press $\text{\textcircled{3}}$ ENTER to display the setup results in detail.

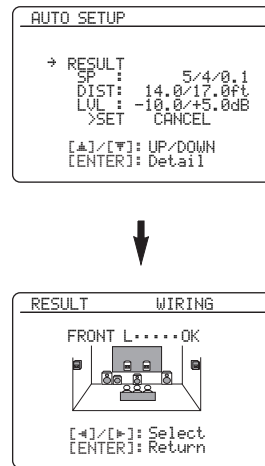

- 6 Press **Ⓧ** **◀/▶** repeatedly to toggle between the setup result displays.

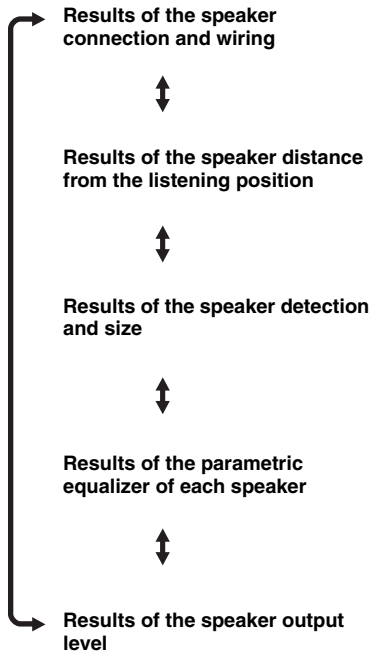

- Press **Ⓧ** **▲/▼** to toggle between the parameters in the result.
- If you are not satisfied with the results or want to manually adjust each parameter, run “MANUAL SETUP” (see page 75).

Notes

- If you change speakers, speaker positions, or the layout of your listening environment, run “AUTO SETUP” again to recalibrate your system.
- The distances displayed in the “DISTANCE” results may be longer than the actual distance depending on the characteristics of your subwoofer or external amplifiers if you connect them.
- In the “EQUALIZING” results, different values may be set for the same band to provide finer adjustments.

- 7 Press **Ⓧ** **ENTER** to return to the top result display.

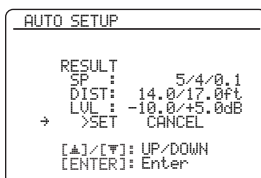

- 8 Press **Ⓧ** **◀/▶** to select “SET” or “CANCEL”.

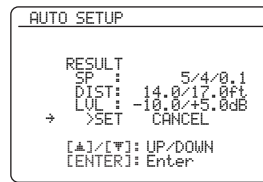

Choices: **SET**, **CANCEL**

- Select “SET” to confirm the “AUTO SETUP” results.
- Select “CANCEL” to cancel the “AUTO SETUP” results.

- 9 Press **Ⓧ** **ENTER** to confirm your selection. The top “SET MENU” display appears in the OSD.

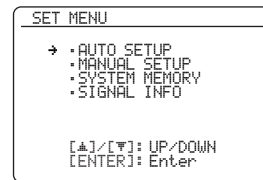

- 10 Press **Ⓧ** **SET MENU** to exit from “SET MENU”.

Notes

- After you have completed the automatic setup procedure, be sure to disconnect the optimizer microphone.
- The optimizer microphone is sensitive to heat. Keep it away from direct sunlight and do not place it on top of this unit.

SYSTEM MEMORY feature

You can save multiple result of the automatic setup by using the SYSTEM MEMORY feature. See page 96 for details.

■ Customizing the measurements

You can select the parametric equalizer type, and activate or deactivate each check items.

1 Connect the supplied optimizer microphone to this unit and place the microphone appropriately.

Refer to the steps 1 to 3 of “Basic procedure of the automatic setup” on page 37.

2 Press **③** **△** repeatedly to select “SETUP” and then press **③** **◀** / **▶** to select the desired setting.

Choices: **AUTO**, **RELOAD**

- Select “AUTO” to automatically run the entire “AUTO SETUP” procedure.
- Select “RELOAD” to reload the last “AUTO SETUP” settings and override the current settings. When you select “RELOAD”, the previous auto setup result appears in the OSD. See step 4 on page 38 and carry out the operations.

Notes

- “RELOAD” is available only when you have previously run “AUTO SETUP” and confirmed the results.
- If you selected “RELOAD” in step 2, no test tones are output and the result of the previous automatic setup appears in the OSD.
- If an error occurs during the automatic setup procedure, the setup procedure is canceled and an error screen appears. For details, see “If an error screen appears” on page 41.

3 Press **③** **△** / **▽** repeatedly to select “WIRING”, “DISTANCE”, “SIZE”, “EQ”, or “LEVEL” and then press **③** **◀** / **▶** to select the desired setting.

This unit performs the following checks:

Speaker wiring **WIRING**

Checks which speakers are connected and the polarity of each speaker.

Speaker distance **DISTANCE**

Checks the distance of each speaker from the listening position and adjusts the timing of each channel.

Speaker size **SIZE**

Checks the frequency response of each speaker and sets the appropriate low-frequency crossover for each channel.

Choices: **CHECK**, **SKIP**

- Select “CHECK” to automatically check and adjust the item.
- Select “SKIP” to skip the item and perform no adjustments.

Parametric equalizer type **EQ**

Parametric equalizer adjusts the level of the specified frequency bands. This unit automatically selects the crucial frequency bands for the listening room and adjusts the level of the selected frequency bands to create a cohesive sound field in the room. You can select the type of the parametric equalizer adjustment from the following choices.

Choices: **NATURAL**, **FLAT**, **FRONT**, **SKIP**

- Select “NATURAL” to average out the frequency response of all speakers with higher frequencies being less emphasized. Recommended if the **FLAT** setting sounds a little harsh.
- Select “FLAT” to average the frequency response of all speakers. Recommended if all of your speakers are of similar quality.
- Select “FRONT” to adjust the frequency response of each speaker in accordance with the sound of your front speakers. Recommended if your front speakers are of much higher quality than your other speakers.
- Select “SKIP” to skip this item and perform no adjustments.

Volume level **LEVEL**

Checks and adjusts the volume level of each speaker.

Choices: **CHECK**, **SKIP**

- Select “CHECK” to automatically check and adjust this item.
- Select “SKIP” to skip this item and perform no adjustments.

4 After the setting of the measurement, start the automatic setup procedure.

Refer to steps 4 to 6 of “Basic procedure of the automatic setup” on page 38 for details.

SYSTEM MEMORY feature

You can save multiple result of the automatic setup by using the SYSTEM MEMORY feature. See page 96 for details.

■ If an error screen appears

Press **Ⓜ**◀/▶ to select “RETRY” or “EXIT” and then press **Ⓜ**ENTER.

The following display is an example where “E-9:USER CANCEL” appears in the OSD.

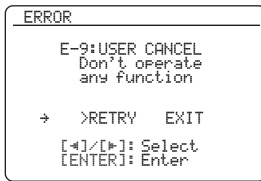

Choices: **RETRY**, **EXIT**

- Select “RETRY” to retry the “AUTO SETUP” procedure.
- Select “EXIT” to exit from the “AUTO SETUP” procedure.



- If “E-5:NOISY” appears in the OSD, you can also select “PROCEED” and let this unit continue the automatic setup. However, we recommend that you perform the automatic setup procedure again for more accurate adjustment.

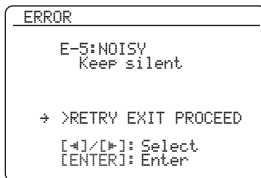

- If “E-10:INTERNAL ERROR” appears in the OSD, you can select only “EXIT”.
- For details about each error message, refer to the “AUTO SETUP” section in “Troubleshooting” on page 128.

■ If “WARNING” appears

When this unit detects potential problems during the automatic setup procedure, “WARNING” appears in the result display. Check the warning messages to correct your speaker settings.

Note

Warnings differ from errors in that warnings do not cancel the “AUTO SETUP” procedure.

- 1 Make sure the pointer is pointing at “WARNING” and then press **Ⓜ**ENTER to display the detailed information about the warning.

The number on the right of “WARNING” indicates the number of warning messages.

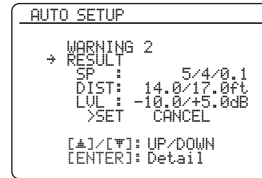

- 2 Press **Ⓜ**◀/▶ repeatedly to toggle between the warning displays.

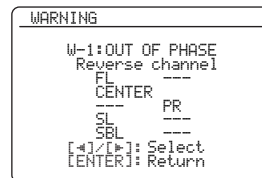

- For details about each warning message, refer to the “AUTO SETUP” section in “Troubleshooting” on page 128.
- When the corresponding warning message is not applicable to a speaker, “---” is displayed instead.
- If the volume level setting of the connected subwoofer is too high or low, “TOO LOUD” (the volume level setting is too high) or “TOO LOW” (the volume level setting is too low) is displayed in the “W-3:LEVEL ERROR” display. Adjust the volume level setting of the connected subwoofer appropriately.

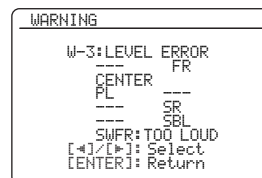

- 3 Press **Ⓜ**ENTER to return to the top result display.



The adjustment are made even if “WARNING” appears, however the adjustment may not be optimal.

Playback

Caution

Extreme caution should be exercised when you play back CDs encoded in DTS. If you play back a CD encoded in DTS on a DTS-incompatible CD player, you will only hear some unwanted noise that may damage your speakers. Check whether your CD player supports CDs encoded in DTS. Also, check the sound output level of your CD player before you play back a CD encoded in DTS.



To play DTS-encoded CDs when using a digital audio connection, set "DECODER MODE" in "INPUT MENU" to "DTS" before the playback (see page 89).

Before performing the following operations, set the operation mode selector on the remote control to **AMP**.

Basic procedure

1 Turn on the video monitor connected to this unit.



- See page 44 to display the input source information.
- You can display a gray background in the OSD when there is no video signal being input by setting "GRAY BACK" in "OPTION MENU" to "AUTO" (see page 91).
- You can turn on or off the short message displays on the video monitor. See pages 91 for details.

2 Rotate the **INPUT** selector (or set the operation mode selector to **AMP** and then press one of the input selector buttons (1)) to select the desired input source.

The name of the currently selected input source appears in the front panel display and in the OSD for a few seconds.

Available input sources

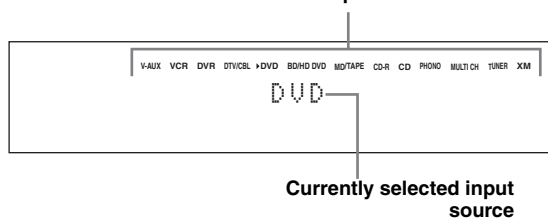

3 Start playback on the selected source component or select a broadcast station.

- Refer to the instruction manuals for the source component.
- See page 54 for details about FM/AM tuning instructions.
- See page 58 for details about XM Satellite Radio tuning instruction.

4 Rotate **VOLUME** (or press **VOLUME +/-**) to adjust the volume to the desired output level.

Control range: MUTE, -80.0 dB (minimum) to +16.5 dB (maximum)



See page 53 to adjust the level of each speaker.

5 Rotate the **PROGRAM** selector (or press one of the sound field program selector buttons (24) repeatedly) to select the desired sound field program.

The name of the selected sound field program appears in the front panel display and in the OSD. See page 46 for details about sound field programs.

Currently selected sound field program category

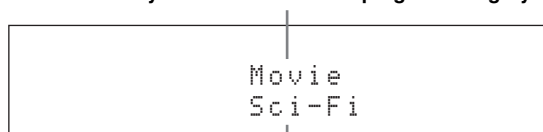

Currently selected sound field program

Note

Sound field programs cannot be selected when the component connected to the MULTI CH INPUT jacks is selected as the input source (see page 43).



- Choose a sound field program based on your listening preference, not merely on the name of the program.
- When you select an input source, this unit automatically selects the last sound field program used with the corresponding input source.
- To display information about the currently selected input source in the OSD, see page 44 for details.

Selecting audio input jacks (AUDIO SELECT)

This unit comes with a variety of input jacks. Use this feature (audio input jack select) to switch the input jack assigned to an input source when more than one jacks are assigned to an input source.



- We recommend that you set the audio input jack select setting to “AUTO” in most cases.
- You can adjust the default audio input jack select setting of this unit by using “AUDIO SELECT” in “OPTION MENU” (see page 94).

1 Rotate the **ⓈINPUT** selector (or press one of the input selector buttons (①)) to select the desired input source.

2 Press **ⓈAUDIO SELECT** (or **ⓈAUDIO SEL**) repeatedly to select the desired audio input jack select setting.

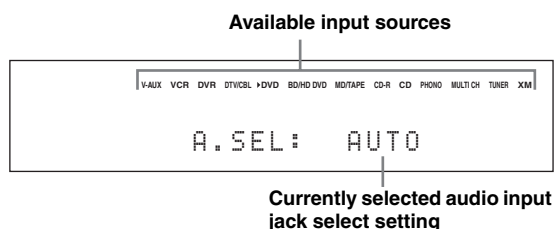

AUTO	Automatically selects input signals in the following order: (1) HDMI (2) Digital signals (3) Analog signals
HDMI	Selects only HDMI signals. When HDMI signals are not input, no sound is output.
COAX/OPT	Automatically selects input signals in the following order: (1) Digital signals input at the COAXIAL jack. (2) Digital signals input at the OPTICAL jack. When no signals are input, no sound is output.
ANALOG	Selects only analog signals. If no analog signals are input, no sound is output.

Note

This feature is not available when no digital input jack (OPTICAL, COAXIAL and HDMI) are assigned. In addition, HDMI is not available as an Audio input jack select setting when the HDMI input jacks are not used. Use “I/O ASSIGNMENT” in “INPUT MENU” to reassign the respective input jack (see page 89).

Selecting the MULTI CH INPUT component

Use this feature to select the component connected to the MULTI CH INPUT jacks (see page 30) as the input source.

Rotate the **ⓈINPUT** selector on the front panel to select MULTI CH (or press **①MULTI CH IN**).



Use “MULTI CH” menu in “INPUT MENU” to set the parameters for “MULTI CH” (see page 88).

Note

Sound field programs cannot be selected when the component connected to the MULTI CH INPUT jacks is selected as the input source.

Using your headphones

Connect a pair of headphones with a stereo analog audio cable plug to the PHONES jack on the front panel.

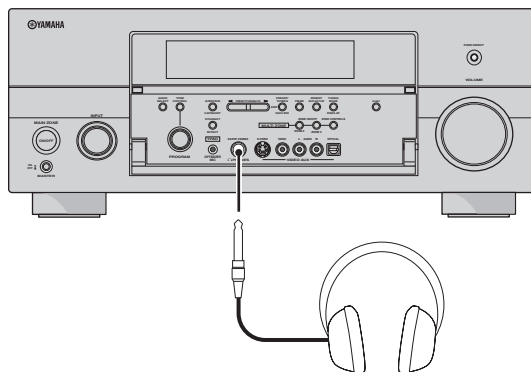

When you select a sound field program, SILENT CINEMA mode activates automatically (see page 51).

Notes

- When you connect headphones, no signals are output at the speaker terminals.
- When the component connected to the MULTI CH INPUT jacks of this unit is selected as the input source, only the signals input at the MULTI CH INPUT FRONT jacks are output from the connected headphones.
- All digital multi-channel audio signals are mixed down to the left and right headphone channels.

Muting the audio output

Press **Ⓜ** **MUTE** on the remote control to mute the audio output. Press **Ⓜ** **MUTE** again to resume the audio output.



- You can also rotate **Ⓜ** **VOLUME** on the front panel or press **Ⓜ** **VOLUME +/-** on the remote control to resume the audio output.
- You can adjust the muting level by using the “MUTING TYPE” parameter in “VOLUME MENU” (see page 84).
- The MUTE indicator flashes in the front panel display when the audio output is muted and disappears from the front panel display when the audio output is resumed.

Displaying the input source information (SIGNAL INFO)

You can display the format, sampling frequency, channel, bit rate and flag data of the current input signal.

- Set the operation mode selector to **Ⓜ** **AMP** and then press **Ⓜ** **SET MENU** on the remote control.

The top “SET MENU” display appears in the OSD.

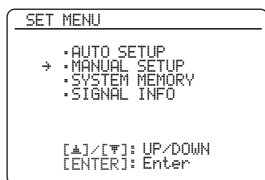

- Press **Ⓜ** **▽** repeatedly to select “SIGNAL INFO” and then press **Ⓜ** **ENTER**.

The audio information about the input source appears in the OSD.

- Press **Ⓜ** **◀/▶** to toggle between the audio and video information displays.



The information is also appears in the front panel display. Press **Ⓜ** **▲/▼** repeatedly to change the displayed information.

- Press **Ⓜ** **SET MENU** on the remote control again to exit from “SET MENU”.

Audio information

FORMAT	Signal format. When this unit cannot detect a digital signal, it automatically switches to analog input.
SAMPLING	The number of samples per second taken from a continuous signal to make a discrete signal.
CHANNEL	The number of source channels in the input signal (front/surround/LFE). For example, a multi-channel soundtrack with 3 front channels, 2 surround channels and LFE, is displayed as “3/2/0.1”.
BITRATE	The number of bits passing a given point per second.
DIALOG	The dialogue normalization level preset to the current input bitstream signal (see page 130).
FLAG	Flag data encoded in the bitstream, or PCM signals that cue this unit to automatically switch decoders (“Surround EX”, etc.).

Notes

- “—” appears when this unit cannot display the corresponding information.
- Some high definition audio bitstream contents may not include the discrete surround back left and right channel signals but are encoded at the bitrate of 192 kHz.
- Even if you make settings to output bitstreams directly, some players convert the Dolby TrueHD or Dolby Digital Plus bitstreams to the Dolby Digital bitstreams, while converting the DTS-HD Master Audio or DTS-HD High Resolution Audio bitstreams to the DTS bitstreams.

Video information

HDMI SIGNAL	Type of the source video signals and the video signals output at the HDMI OUT jack of this unit.
HDMI RES.	Resolution of the input signal (analog or HDMI) and the output signal (HDMI).
ANALOG RES.	Resolution of the source video signals and the analog video signals output at the COMPONENT MONITOR OUT jacks of this unit.
HDMI ERROR (HDMI MESSAGE)	Error message for HDMI sources or connected HDMI devices. See page 125 for details.

Note

“—” appears when this unit cannot display the corresponding information.

Playing video sources in the background of an audio source

You can combine a video image from a video source with sound from an audio source. For example, you can enjoy listening to classical music while viewing beautiful scenery from the video source on the video monitor.

Press the input selector buttons (1) on the remote control to select a video source and then an audio source.

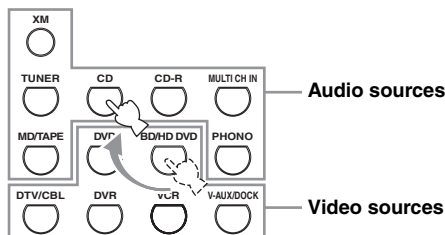

Set the "BGV" parameter in the "MULTI CH" menu to the desired setting to select the default background video input source of the MULTI CH INPUT sources (see page 90).

Using the sleep timer

Use this feature to automatically set the main zone to the standby mode after a certain amount of time. The sleep timer is useful when you are going to sleep while this unit is playing or recording a source. The sleep timer also automatically turns off any external components connected to the AC OUTLET(S) (see page 32).

1 Rotate the **INPUT** selector (or press one of the input selector buttons (1)) to select the desired input source.

2 Start playback on the selected source component or select a broadcast station.

- Refer to the instruction manual for the source component.
- See page 54 for details about FM/AM tuning instructions.
- See page 58 for details about XM Satellite Radio tuning instruction.

3 Press **SLEEP** (or **SLEEP**) repeatedly to set the amount of time.

Each time you press **SLEEP** (or **SLEEP**), the front panel display changes as shown below.

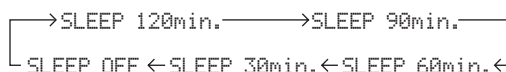

The SLEEP indicator flashes while you are switching the amount of time for the sleep timer. Once the sleep timer is set, the SLEEP indicator lights up in the front panel display, and the display returns to the selected sound field program.

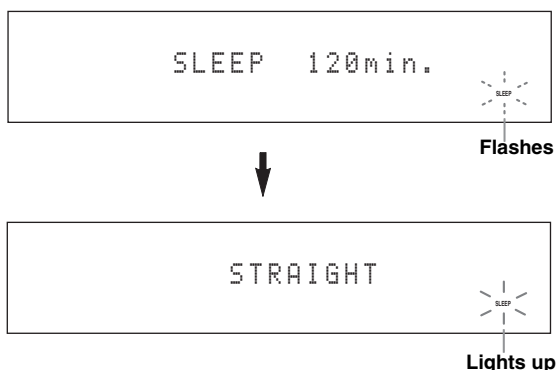

■ Cancelling the sleep timer

Press **SLEEP** (or **SLEEP**) repeatedly until "SLEEP OFF" appears in the front panel display.

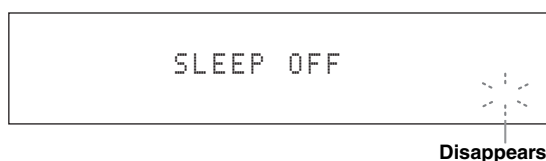

The SLEEP indicator turns off, and "SLEEP OFF" disappears from the front panel display after a few seconds.



The sleep timer setting can also be canceled by pressing **MAIN ZONE ON/OFF** (or **STANDBY**) to set the main zone to the standby mode.

Sound field programs

This unit is equipped with a variety of precise digital decoders that allow you to enjoy multi-channel playback from almost any stereo or multi-channel sound source. This unit is also equipped with a Yamaha digital sound field processing (DSP) chip containing several sound field programs which you can use to enhance your playback experience.



- The Yamaha CINEMA DSP sound field programs are compatible with all Dolby Digital, DTS, Dolby Surround, Dolby TrueHD and DTS-HD Master Audio sources.
- The Yamaha HiFi DSP sound field programs recreate real-world acoustic environments made from precise measurements taken in actual concert halls, music venues, movie theaters, etc. Thus, you may notice variations in the strength of the reflections coming from the front, back, left and right.
- You can change sound field parameters. See page 67 for details.

Selecting sound field programs

Rotate the **PROGRAM** selector (or set the operation mode selector to **AMP** and then press one of the sound field selector buttons repeatedly).

The name of the selected sound field program appears in the front panel display and in the OSD.

Notes

- When you select an input source, this unit automatically selects the last sound field program used with the corresponding input source.
- Sound field programs cannot be selected when the component connected to the MULTI CH INPUT jacks is selected as the input source (see page 43) or when this unit is in the Pure Direct mode (see page 52).
- When you play back DTS 96/24 sources with any sound field program, this unit applies the selected program without activating the DTS 96/24 decoder.
- Sampling frequencies higher than 48 kHz are sampled down to 48 kHz or lower and then sound field programs are applied.

Sound field program descriptions



Select a sound field program based on your listening preference, not merely on the name of the program, etc.

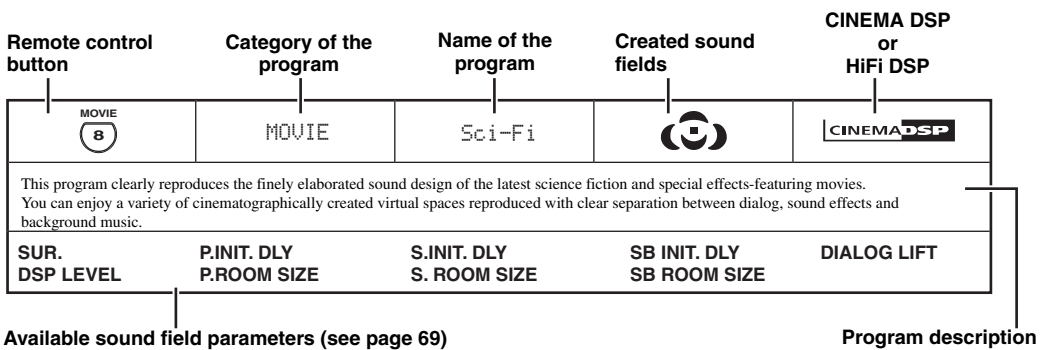

Sound field indicators

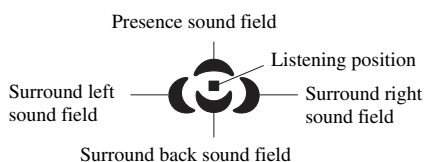



■ For audio music sources



For audio music sources, we also recommend using the Pure Direct mode (see page 52), the “STRAIGHT” mode (see page 51) or surround decode mode (see page 72).

CLASSICAL 5	CLASSICAL	Hall in Munich		HiFi DSP
This sound field simulates a concert hall with approximately 2500 seats in Munich, using stylish wood for the interior finishing as normal standards for European concert halls. Fine, beautiful reverberations spread richly, creating a calming atmosphere. The listener's virtual seat is at the center left of the arena.				
DSP LEVEL INIT. DLY	ROOM SIZE LIVENESS	DIALOG LIFT		
CLASSICAL 5	CLASSICAL	Hall in Vienna		HiFi DSP
This is an approximately 1700-seated, middle-sized concert hall with a shoebox shape that is traditional in Vienna. Pillars and ornate carvings create extremely complex reflections from all around the audience, producing a very full, rich sound.				
DSP LEVEL INIT. DLY	ROOM SIZE LIVENESS	DIALOG LIFT		
CLASSICAL 5	CLASSICAL	Hall in Amsterdam		HiFi DSP
The large, shoe box shaped hall seats about 2200 around the circle stage. Reflections are rich and pleasing while the sound travels freely.				
DSP LEVEL INIT. DLY	ROOM SIZE LIVENESS	DIALOG LIFT		
CLASSICAL 5	CLASSICAL	Church in Freiburg		HiFi DSP
Located in the south of Germany, this grand, stone-built church has a pointed tower at 120 meters in height. Its long and narrow shape and the high ceiling enable the elongated reverberation time and limited initial reflection time. Thus, the rich reverberation rather than the sound itself reproduces the atmosphere of the church.				
DSP LEVEL INIT. DLY	LIVENESS REV.TIME	REV.DELAY REV. LEVEL	DIALOG LIFT	
CLASSICAL 5	CLASSICAL	Chamber		HiFi DSP
This program creates a relatively wide space with a high ceiling like an audience hall in a palace. It offers pleasant reverberations that are suitable for courtly music and chamber music.				
DSP LEVEL INIT. DLY	LIVENESS REV.TIME	REV.DELAY REV. LEVEL	DIALOG LIFT	
LIVE/CLUB 6	LIVE/CLUB	Village Vanguard		HiFi DSP
The Jazz club is on 7th Avenue, New York. This small club with the low ceiling makes the powerful reflections converge toward the stage located in the corner.				
DSP LEVEL INIT. DLY	ROOM SIZE LIVENESS	DIALOG LIFT		
LIVE/CLUB 6	LIVE/CLUB	Warehouse Loft		HiFi DSP
The warehouse resembles some lofts in Soho. Sound reflects off the concrete walls clearly with a lot of energy.				
DSP LEVEL INIT. DLY	ROOM SIZE LIVENESS	REV.TIME REV.DELAY	REV. LEVEL DIALOG LIFT	



Sound field programs

LIVE/CLUB 6	LIVE/CLUB	Cellar Club		HiFi DSP
This program simulates a live house with a low ceiling and homey atmosphere. A realistic, live sound field features powerful sound as if the listener is in a row in front of a small stage.				
DSP LEVEL INIT. DLY	ROOM SIZE LIVENESS	DIALOG LIFT		
LIVE/CLUB 6	LIVE/CLUB	The Roxy Theatre		HiFi DSP
This is the sound field of a rock music live house in Los Angeles, with approximately 460 seats. The listener's virtual seat is at the center left of the hall.				
DSP LEVEL INIT. DLY	ROOM SIZE LIVENESS	REV.TIME REV.DELAY	REV. LEVEL DIALOG LIFT	
LIVE/CLUB 6	LIVE/CLUB	The Bottom Line		HiFi DSP
This is the sound field at stage front in The Bottom Line, a famous New York jazz club. The floor can seat 300 people to the left and right in a sound field offering real and vibrant sound.				
DSP LEVEL INIT. DLY	ROOM SIZE LIVENESS	DIALOG LIFT		

■ For various sources

Note



The available sound field parameters and the created sound fields differ depending on the input sources and the settings of this unit.



ENTERTAIN 7	ENTERTAINMENT	Sports		CINEMA DSP
This program allows the listeners to enjoy stereo sport broadcasts and studio variety programs with enriched live feeling. In sports broadcasts, the voices of the commentator and sportscaster are positioned clearly on the center while the atmosphere of the stadium expands in an optimum space to offer the listeners with a feeling of presence in the stadium.				
DSP LEVEL P. INIT. DLY	P. ROOM SIZE S. INIT. DLY	S. ROOM SIZE SB INIT. DLY	SB ROOM SIZE DIALOG LIFT	
ENTERTAIN 7	ENTERTAINMENT	Action Game		CINEMA DSP
This sound field is suitable for action games such as car racing and FPS games. It uses the reflection data that limits the effects range per channel in order to offer a powerful playing environment with a being-there feeling by enhancing various effects tones while maintaining a clear sense of directions.				
DSP LEVEL P. INIT. DLY	P. ROOM SIZE S. INIT. DLY	S. ROOM SIZE SB INIT. DLY	SB ROOM SIZE DIALOG LIFT	
ENTERTAIN 7	ENTERTAINMENT	Roleplaying Game		CINEMA DSP
This sound field is suitable for role-playing and adventure games. It combines the sound field effects for movies and the sound field design used with "Action Game" to represent the depth and 3D feeling of the field during play, while offering movie-like surround effects in the movie scenes in the game.				
DSP LEVEL P. INIT. DLY	P. ROOM SIZE S. INIT. DLY	S. ROOM SIZE SB INIT. DLY	SB ROOM SIZE DIALOG LIFT	

■ For visual sources of music

Note

The available sound field parameters and the created sound fields differ depending on the input sources and the settings of this unit.

	ENTERTAINMENT	Music Video		
This sound field offers an image of a concert hall for live performance of pop, rock and jazz music. The listener can indulge oneself in a hot live space thanks to the presence sound field that emphasizes the vividness of vocals and solo play and the beat of rhythm instruments, and to the surround sound field that reproduces the space of a big live hall.				
DSP LEVEL P. INIT. DLY	P. ROOM SIZE S. INIT. DLY	S. ROOM SIZE SB INIT. DLY	SB ROOM SIZE DIALOG LIFT	

	ENTERTAINMENT	Recital/Opera		
This program controls the amount of reverberations at an optimum level and emphasizes the depth and clarity of human voices. "Opera" offers the reverberations of an orchestra box in front of the listener at the same time as providing the acoustic positioning and feeling of presence on the stage. The surround sound field is relatively moderate, but the data for concert hall effects are used to represent the inherent beauty of music. The listener will not be fatigued even after long hours of opera entertainment.				
DSP LEVEL P. INIT. DLY	P. ROOM SIZE S. INIT. DLY	S. ROOM SIZE SB INIT. DLY	SB ROOM SIZE DIALOG LIFT	



■ For movie sources









You can select the desired decoder (SUR.) used with following sound field program (except "Mono Movie"). See page 74 for details.

Note









The available sound field parameters and the created sound fields differ depending on the input sources and the settings of this unit.

	MOVIE	Standard		
This program creates a sound field emphasizing the surrounding feeling without disturbing the original acoustic positioning of multi-channel audio such as Dolby Digital and DTS. It has been designed with the concept of "an ideal movie theater", in which the audience is surrounded by beautiful reverberations from the left, right and rear.				
SUR. DSP LEVEL	S. INIT. DLY S. ROOM SIZE	S. LIVENESS SB INIT. DLY	SB ROOM SIZE SB LIVENESS	DIALOG LIFT





	MOVIE	Spectacle		
This program represents the spectacular feeling of large-scale movie productions. It reproduces a broad theater sound field matching the cinemascope and wider-screen movies with an excellent dynamic range from very small to extremely large sound.				
SUR. DSP LEVEL	P. INIT. DLY P. ROOM SIZE	S. INIT. DLY S. ROOM SIZE	SB INIT. DLY SB ROOM SIZE	DIALOG LIFT

	MOVIE	Sci-Fi		
This program clearly reproduces the finely elaborated sound design of the latest science fiction and special effects-featuring movies. You can enjoy a variety of cinematographically created virtual spaces reproduced with clear separation between dialog, sound effects and background music.				
SUR. DSP LEVEL	P. INIT. DLY P. ROOM SIZE	S. INIT. DLY S. ROOM SIZE	SB INIT. DLY SB ROOM SIZE	DIALOG LIFT



Sound field programs

	MOVIE	Adventure		
<p>This program is ideal for precisely reproducing the sound design of action and adventure movies. The sound field restrains reverberations but puts emphasis on reproducing a powerful space expanded widely to the left and right. The reproduced depth is also restrained relatively to ensure the separation between audio channels and the clarity of the sound.</p>				
SUR. DSP LEVEL	P. INIT. DLY P. ROOM SIZE	S. INIT. DLY S. ROOM SIZE	SB INIT. DLY SB ROOM SIZE	DIALOG LIFT
	MOVIE	Drama		
<p>This sound field features stable reverberations that match a wide range of movie genres from serious dramas to musicals and comedies. The reverberations are modest but offer an optimum 3D feeling, reproducing effects tones and background music softly but cubically around clear words and center positioning in a way that does not fatigue the listener even after long hours of viewing.</p>				
SUR. DSP LEVEL	P. INIT. DLY P. ROOM SIZE	S. INIT. DLY S. ROOM SIZE	SB INIT. DLY SB ROOM SIZE	DIALOG LIFT
	MOVIE	Mono Movie		
<p>This program is provided for reproducing monaural video sources such as a classic movie in an atmosphere of a good old movie theater. The program produces the optimum expansion and reverberation to the original audio to create a comfortable space with a certain sound depth.</p>				
DSP LEVEL INIT. DLY	ROOM SIZE LIVENESS	REV.TIME REV. LEVEL	REV.DELAY DIALOG LIFT	

■ Stereo playback

	STEREO	2ch Stereo		
<p>Use this program to mix down multi-channel sources to 2 channels. See page 53 for details.</p>				
DIRECT				
	STEREO	7ch Stereo		HiFi DSP
<p>Use this program to output sound from all speakers. When you play back multi-channel sources, this unit downmixes the source to 2 channels, and then output the sound from all speakers. This program creates a larger sound field and is ideal for background music at parties, etc.</p>				
CT LEVEL SL LEVEL	SR LEVEL SB LEVEL	PL LEVEL PR LEVEL		

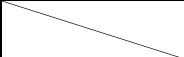
■ Compressed Music Enhancer

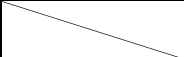
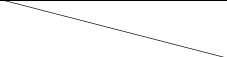
	MUSIC ENHANCER	Straight Enhancer		
<p>Use this program to enhance the sound nearest to the original depth and width of the 2-channel or multi-channel compression artifacts.</p>				
EFFECT LEVEL				
	MUSIC ENHANCER	7ch Enhancer		
<p>Use this program to play back compression artifacts in 7-channel stereo.</p>				
EFFECT LEVEL				

■ Using sound field programs without surround speakers (Virtual CINEMA DSP)

Virtual CINEMA DSP allows you to enjoy the CINEMA DSP or HiFi DSP sound field programs without surround speakers. It creates virtual speakers to reproduce the natural sound field.

When you set “SUR. L/R SP” to “NONE” (see page 81), Virtual CINEMA DSP activates automatically whenever you select a CINEMA DSP or HiFi DSP sound field program (see page 46).

Note

Virtual CINEMA DSP will not activate even when “SUR. L/R SP” is set to “NONE” (see page 81) in the following cases:

- when the component connected to the MULTI CH INPUT jacks is selected as the input source (see page 43).
- when headphones are connected to the PHONES jack.
- when this unit is in the “7ch Stereo” mode.

■ Enjoying multi-channel sources and sound field programs with headphones (SILENT CINEMA)

SILENT CINEMA allows you to enjoy multi-channel music or movie sound through ordinary headphones. SILENT CINEMA activates automatically whenever you connect headphones to the PHONES jack while listening to CINEMA DSP or HiFi DSP sound field programs (see page 46). When activated, the SILENT CINEMA indicator lights up in the front panel display.

Notes

- SILENT CINEMA does not activate when the component connected to the MULTI CH INPUT jacks is selected as the input source (see page 43).
- SILENT CINEMA is not effective when the Pure Direct (see page 52) or “2ch Stereo” mode (see page 53) is selected, or when this unit is in the “STRAIGHT” mode.

Before performing the following operation, set the operation mode selector on the remote control to **AMP**.

Enjoying unprocessed input sources

When this unit is in the “STRAIGHT” mode, 2-channel stereo sources are output from only the front left and right speakers. Multi-channel sources are decoded straight into the appropriate channels without any additional effect processing.

Press **STRAIGHT** (or **STRAIGHT**) to select “STRAIGHT”.

STRAIGHT



The names of the audio signal format of the input source and the active decoder appear in the front panel display.

■ Deactivating the “STRAIGHT” mode

Press **STRAIGHT** (or **STRAIGHT**) so that “STRAIGHT” disappears from the front panel display.

The sound effect is turned back on.



You can also select desired sound field program by rotating the **PROGRAM** selector (or press one of the desired sound field program buttons (**PROGRAM**)) repeatedly.

Using audio features

Before performing the following operation, set the operation mode selector on the remote control to **AMP**.

Enjoying pure hi-fi sound

Use the Pure Direct mode to enjoy the pure fidelity sound of the selected source. When the Pure Direct mode is activated, this unit plays back the selected source with the least circuitry.

Press **PURE DIRECT** (or **PURE DIRECT**) to turn on or off the Pure Direct mode.

The **PURE DIRECT** button on the front panel lights up and the front panel display automatically turns off while this unit is in the Pure Direct mode.

Notes

- When this unit is in the Pure Direct mode, this unit does not output any video signals at the MONITOR OUT jacks and the HDMI OUT jack.
- When you set the audio input jack select setting to “AUTO”, “HDMI”, or “COAX/OPT” (see page 43) and play back the bitstreams or multi-channel PCM sources, this unit activates the corresponding decoder.
- The following operations are not possible when this unit is in the Pure Direct mode:
 - switching the sound field program
 - displaying the OSD
 - adjusting the “SET MENU” parameters (except for speaker level settings)
 - operating video functions (video conversion, etc.)
- The Pure Direct mode is automatically canceled whenever this unit is turned off.



The front panel display turns on momentarily when an operation is performed.

Adjusting the tonal quality

Use this feature to adjust the balance of bass and treble for the front L/R and center speaker channels and the subwoofer channel.

1 Press **TONE CONTROL** on the front panel repeatedly to select the high-frequency response (TREBLE) or the low-frequency response (BASS).

2 Rotate the **PROGRAM** selector to adjust the high-frequency response (TREBLE) or the low-frequency response (BASS).

Control range: -6.0 dB to +6.0 dB

Notes

- If you increase or decrease the high-frequency or the low-frequency sound to an extreme level, the tonal quality of the surround speakers may not match that of the front L/R and center speakers and the subwoofer.
- TONE CONTROL is not effective when the Pure Direct mode is activated, or when MULTI CH is selected as the input source.

Before performing the following operation, set the operation mode selector on the remote control to **AMP**.

Adjusting the speaker level

You can adjust the output level of each speaker while listening to a music source. This is also possible when playing sources input at the MULTI CH INPUT jacks.

Note

This operation will override the level adjustments made in “Optimizing the speaker setting for your listening room” (see page 37) and “SPEAKER LEVEL” (see page 82).

- 1 Press **LEVEL** on the remote control repeatedly to select the speaker you want to adjust.

Display	Adjusted speaker
FRONT L	Front left speaker
CENTER	Center speaker
FRONT R	Front right speaker
SUR. R	Surround right speaker
SB R	Surround back right speaker
SB L	Surround back left speaker
SUR. L	Surround left speaker
SWFR	Subwoofer
PRNS L	Presence left speaker
PRNS R	Presence right speaker



- Once you press **LEVEL** on the remote control, you can also select the speaker by pressing **Δ / ▽**.
- Instead of “SB R” and “SB L”, “SB” is displayed if “SUR. B L/R SP” is set to either “SMLx1” or “LRGx1” (see page 81).

- 2 Press **◀ / ▶** on the remote control to adjust the speaker output level.

- Press **▶** to increase the value.
- Press **◀** to decrease the value.

Control range: -10.0 dB to +10.0 dB

Enjoying multi-channel sources in 2-channel stereo

You can mix down multi-channel sources to 2 channels and enjoy playback in 2-channel stereo.

- Press **STEREO** on the remote control repeatedly to select “2ch Stereo”.



- You can use a subwoofer with this program when “LFE/BASS OUT” is set to “SWFR” or “BOTH” (see page 80).
- You can also select the “2ch Stereo” mode by rotating the **PROGRAM** selector on the front panel.
- See page 72 for details about the parameters of the “2ch Stereo” mode.

FM/AM tuning

There are 2 tuning methods: automatic and manual. Automatic tuning is effective when station signals are strong and there is no interference. If the signal from the station you want to select is weak, tune into it manually. You can also use the automatic and manual preset tuning features to store up to 40 stations (A1 to E8: 8 preset station numbers in each of the 5 preset station groups). Furthermore, you can recall any preset stations and exchange the assignment of two preset stations with each other.

Note

Orient the connected FM and AM antennas for the best reception.

Automatic tuning

Automatic tuning is effective when station signals are strong and there is no interference.

- 1 Rotate the **ⓈINPUT** selector on the front panel to select “TUNER” as the input source.
- 2 Press **ⓈFM/AM** to select the reception band. “FM” or “AM” appears in the front panel display.
- 3 Press **ⓈTUNING MODE** so that the **AUTO** indicator lights up in the front panel display.

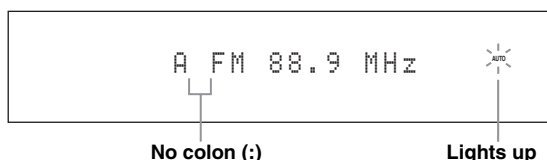

If a colon (:) appears in the front panel display, tuning is not possible. Press **ⓈPRESET/TUNING** to turn the colon (:) off.

- 4 Press **ⓈPRESET/TUNING/CH** **◀/▶** once to begin automatic tuning. When this unit is tuned into a station, the **TUNED** indicator lights up and the frequency of the received station is shown in the front panel display.
 - Press **Ⓢ▶** to tune into a higher frequency.
 - Press **Ⓢ◀** to tune into a lower frequency.

Manual tuning

If the signal received from the station you want to select is weak, tune into it manually.

Note

Manually tuning into an FM station automatically switches the tuner to monaural reception to increase the signal quality.

- 1 Rotate the **ⓈINPUT** selector on the front panel to select “TUNER” as the input source.
- 2 Press **ⓈFM/AM** to select the reception band. “FM” or “AM” appears in the front panel display.
- 3 Press **ⓈTUNING MODE** so that the **AUTO** indicator disappears from the front panel display.

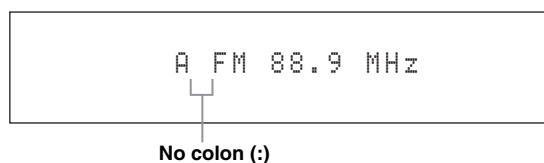

If a colon (:) appears in the front panel display, tuning is not possible. Press **ⓈPRESET/TUNING** to turn the colon (:) off.

- 4 Press **ⓈPRESET/TUNING/CH** **◀/▶** to tune into the desired station manually. Hold down the button to continue searching.

Automatic preset tuning

You can use the automatic preset tuning feature to store up to 40 FM stations with strong signals (A1 to E8: 8 preset station numbers in each of the 5 preset station groups) in order. You can then recall any preset station easily by selecting the preset station number.

1 Rotate the  INPUT selector on the front panel to select "TUNER" as the input source.

2 Press  FM/AM to select "FM" as the reception band.

"FM" appears in the front panel display.





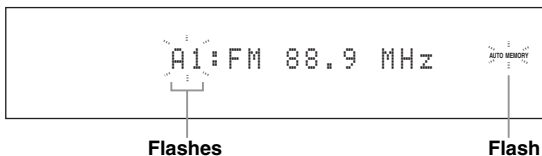



3 Press and hold  MEMORY for more than 3 seconds.

The preset station number as well as the AUTO and MEMORY indicators flashes. After approximately 5 seconds, automatic presetting starts from the current frequency and proceeds toward higher frequencies.



When automatic preset tuning is completed, the front panel display shows the frequency of the last preset station.



- You can specify the preset number from which this unit stores FM stations. Press  A/B/C/D/E and then  PRESET/TUNING/CH   repeatedly after you perform step 3 to select the preset station number under which the first station will be stored.
- You can begin tuning toward lower frequencies to store FM stations automatically. Press  PRESET/TUNING so that the colon (:) disappears from the front panel display and then press  PRESET/TUNING/CH  after pressing and holding  MEMORY for more than 3 seconds.

Notes

- Any stored station data existing under a preset station number is cleared when you store a new station under the same preset station number.
- If the number of received stations does not reach 40 (E8), automatic preset tuning automatically stops after searching for all the available stations.
- Only FM stations with sufficient signal strength are stored automatically by automatic preset tuning. If the station you want to store is weak in signal strength, tune into it manually and store it as described in "Manual preset tuning".
- (Europe model only) Only Radio Data System broadcasting station are stored automatically by automatic preset tuning.

Manual preset tuning

You can also store up to 40 stations (A1 to E8: 8 preset station numbers in each of the 5 preset station groups) manually.

1 Tune into a station automatically or manually.

See page 54 for tuning instructions.

2 Press  MEMORY on the front panel.

The MEMORY indicator flashes in the front panel display for approximately 10 seconds.

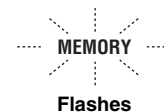

3 Press  A/B/C/D/E repeatedly to select a preset station group (A to E) while the MEMORY indicator is flashing.

The selected preset station group letter appears. Check that the colon (:) appears in the front panel display.

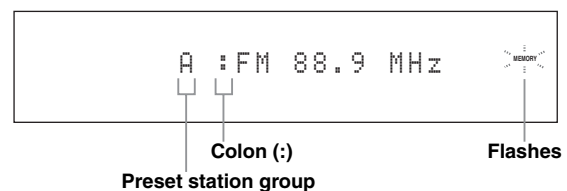

Flashes

- 4** Press **ⓐPRESET/TUNING/CH** **◀/▶** to select a preset station number (1 to 8) while the **MEMORY** indicator is flashing.
- Press **ⓐ▶** to select a higher preset station number.
 - Press **ⓐ◀** to select a lower preset station number.

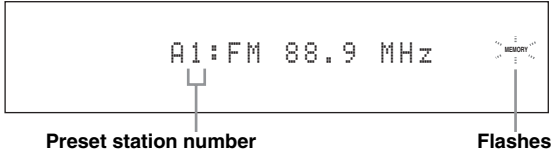

- 5** Press **ⓓMEMORY** while the **MEMORY** indicator is flashing.

The station band and frequency appear in the front panel display with the preset station group and number you have selected. The **MEMORY** indicator disappears from the front panel display.

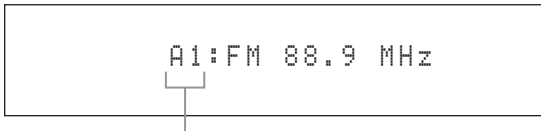

The displayed station has been stored as A1.

Notes

- Any stored station data existing under a preset station number is cleared when you store a new station under the same preset station number.
- The reception mode (stereo or monaural) is stored along with the station frequency.

Selecting preset stations

You can tune into any desired station simply by selecting the preset station group and number under which it was stored.

Set the operation mode selector to **ⓑSOURCE** and then press **ⓑTUNER** to select "TUNER" as the input source.

- 1** Press **ⓑA/B/C/D/E** (or **ⓑA-E/CAT.** **◀/▶**) repeatedly to select the desired preset station group (A to E).

The preset station group letter appears in the front panel display and changes each time you press the button.

- 2** Press **ⓐPRESET/TUNING/CH** **◀/▶** (or **ⓐPRESET/CH** **▲/▼**) repeatedly to select the desired preset station number (1 to 8).

The preset station group and number appear in the front panel display along with the station band and frequency.

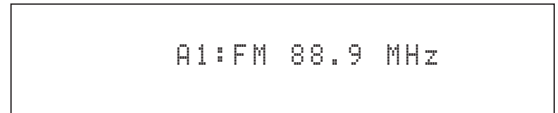

Exchanging preset stations

You can exchange the assignments of two preset stations with each other. The example below describes the procedure to exchange preset station “E1” with “A5”.

- 1 Select preset station “E1” using **F**A/B/C/D/E and **PRESET/TUNING/CH** </> on the front panel.

See “Selecting preset stations” on page 56.

- 2 Press and hold **H**EDIT for more than 3 seconds.

“E1” and the MEMORY indicator flash in the front panel display.



- 3 Select preset station “A5” using **F**A/B/C/D/E and **PRESET/TUNING/CH** </>.

“A5” and the MEMORY indicator flash in the front panel display.

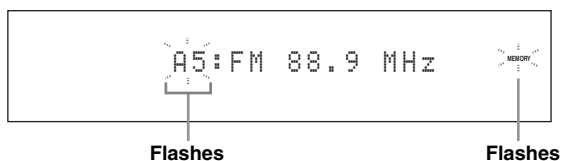

- 4 Press **H**EDIT again.

“EDIT E1–A5” appears in the front panel display and the assignments of the two preset stations are exchanged.



XM™ Satellite Radio tuning

XM Satellite Radio offers an extraordinary variety of commercial-free music, plus the best in sports, news, talk and entertainment. XM is broadcast in superior digital audio from coast to coast. From rock to reggae, from classical to hip hop, XM has something for every music fan. XM's dedication to playing the richest selection of music is matched by its passion for live sporting events, talk radio, up-to-the-minute news, stand-up comedy, children's programming, and much more.

XM Satellite Radio online information

For U.S. customers: <http://www.xmradio.com/>
For Canadian customers: <http://www.xmradio.ca/>

Note

The XM Satellite Radio service is only available in the 48 contiguous United States (not available in Alaska and Hawaii) and Canada.

XM READY legal disclaimer

Hardware and required monthly subscription sold separately. Other fees and taxes, including a one-time activation fee may apply. Subscription fee is consumer only. All fees and programming subject to change. Channels with frequent explicit language are indicated with an XL. Channel blocking is available for XM radio receivers by calling 1-800-XMRADIO (US residents) and 1-877-GET-XMSR (Canadian residents). For a full listing of the XM commercial-free channels and advertising-supported channels, visit lineup.xmradio.com (US residents) or www.xmradio.ca (Canadian residents). Subscriptions subject to Customer Agreement available at xmradio.com (US residents) and xmradio.ca (Canadian residents). Service only available in the 48 contiguous United States and Canada. ©2007 XM Satellite Radio Inc. All rights reserved. All other trademarks are the property of their respective owners.

■ Enjoying XM HD Surround content

This unit is equipped with the Neural-THX Surround decoder that plays back the XM HD surround sound content of the XM Satellite Radio broadcasts in multi-channels, resulting in a full surround sound experience (see page 74).

Connecting XM™ Mini-Tuner Home Dock

Connect XM Mini-Tuner and XM Home Dock (each sold separately) to the XM jack on the rear panel of this unit. For information on your XM Mini-Tuner and XM Home Dock, see the operating instructions provided with XM Mini-Tuner Dock.

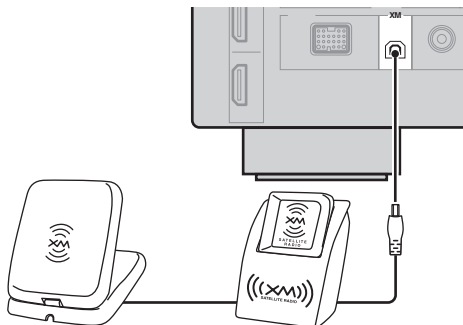

XM Mini-Tuner and XM Home Dock
(sold separately)



- To ensure optimal reception of the XM Satellite Radio signals, the antenna of Home Dock must be placed at or near a south-facing window with no obstacles in the path to the sky. You can mount it indoors or outdoors.
- Use the “ANTENNA LEVEL” parameter in “INPUT MENU” (see page 90) to display the XM Satellite Radio reception level in the OSD. For the best reception, adjust the orientation of the antenna of connected Home Dock so that a value of 60% or more is displayed.

Note

If “CHECK ANTENNA” appears in the front panel display, the Home Dock may not be connected to the XM jack on the rear panel of this unit properly.

Activating XM™ Satellite Radio

■ Checking your XM Radio ID

Once you have installed the XM Mini-Tuner Home Dock, inserted the XM Mini-Tuner, connected the Home Dock to your XM Ready home audio system, and installed the antenna, you are ready to subscribe and begin receiving XM programming. There are three places to find your eight character XM Radio ID: on the XM Mini-Tuner, on the XM Mini-Tuner package, and on XM Channel 0 (see page 61). Record the Radio ID in the following eight squares for reference.

□	□	□	□	□	□	□	□
---	---	---	---	---	---	---	---

Note

The XM Radio ID does not use the letters “I”, “O”, “S” or “F”.

■ Subscription of your XM Satellite Radio service

For U.S. customers

URL: <http://www.xmradio.com/>

Phone: 1-800-XM-RADIO (1-800-967-2346)

For Canadian customers

URL: <http://www.xmradio.ca/>

Phone (XM’s Listener Care):

1-877-GET-XMSR (1-877-438-9677)

Note

You will need a major credit card. XM will send a signal from the satellites to activate the full channel lineup. Activation normally takes 10 to 15 minutes, but during peak busy periods you may need to keep your XM Ready home audio system on for up to an hour. When you can access the full channel lineup on your XM Ready home audio system you are done.

Basic XM™ Satellite Radio operations

Before performing the following operations, set the operation mode selector on the remote control to **SOURCE**.

1 Rotate the **INPUT** selector (or press **XM**) to select “XM” as the input source.

The cursor on the left of the XM indicator lights up in the front panel display and the XM Satellite Radio information (such as channel number, channel name, category, artist name, or song title) for the currently selected channel appears in the front panel display.

Lights up

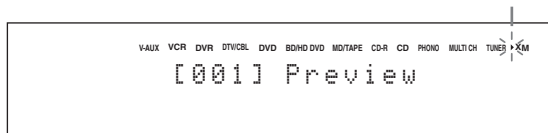

When you select “XM” as the input source, this unit automatically recalls the previously selected channel.

Note

The XM Satellite Radio signals cannot be output at the AUDIO OUT (REC) jacks.

2 Search for a channel by using one of the XM Satellite Radio search modes.

- To select a channel from the all channel list, see “All Channel Search mode” on page 60.
- To select a channel by category, see “Category Search mode” on page 60.
- To select a channel from the preset channels, see “Preset Search mode” on page 60.
- To select the desired channel directly by entering the channel number, see “Direct Number Access mode” on page 61.



- You can use the Neural-THX Surround decoder to enjoy the XM HD surround sound content of the XM Satellite Radio broadcasts in multi-channels (see page 74).
- You can set the XM Satellite Radio preset channels (see page 62).
- You can display the XM Satellite Radio information in the front panel display or in the OSD (see page 63).

Before performing the following operations, set the operation mode selector on the remote control to **③SOURCE** and then press **①XM**.

■ All Channel Search mode

- 1 Press **ⓂSEARCH MODE** (or **ⓂSRCH MODE**) repeatedly to select “ALL CH SEARCH”.

ALL CH SEARCH

- 2 Press **ⓂCATEGORY** (or **③A-E/CAT. </>**) repeatedly to change the channel category.

- 3 Press **ⓂPRESET/TUNING/CH </>** (or **③PRESET/CH Δ / ▽**) repeatedly to search for a channel within all channels.



You can search for a channel quickly by pressing and holding **ⓂPRESET/TUNING/CH </>** (or **③PRESET/CH Δ / ▽**).

■ Category Search mode

- 1 Press **ⓂSEARCH MODE** (or **ⓂSRCH MODE**) repeatedly to select “CAT SEARCH”.

CAT SEARCH

- 2 Press **ⓂCATEGORY** (or **③A-E/CAT. </>**) repeatedly to change the channel category.

- 3 Press **ⓂPRESET/TUNING/CH </>** (or **③PRESET/CH Δ / ▽**) repeatedly to search for a channel within the selected channel category.



You can search for a channel quickly by pressing and holding **ⓂPRESET/TUNING/CH </>** (or **③PRESET/CH Δ / ▽**).

■ Preset Search mode

Prior to selecting a preset channel in the Preset Search mode, you must preset XM Satellite Radio channels. For details, see “Setting the XM™ Satellite Radio preset channels” on page 62.



The initial factory setting of all preset channels (A1 to E8) is “[001] Preview”.

- 1 Press **ⓂSEARCH MODE** (or **ⓂSRCH MODE**) repeatedly to select “PRESET SEARCH”.

PRESET SEARCH

- 2 Press **ⓂCATEGORY** (or **③A-E/CAT. </>**) repeatedly to change the preset channel group (A to E).

- 3 Press **ⓂPRESET/TUNING/CH </>** (or **③PRESET/CH Δ / ▽**) repeatedly to change the preset channel number (1 to 8).



You can also select the preset channel number directly by pressing the numeric buttons (1 to 8) on the remote control.

■ Direct Number Access mode

1 Press **SRCH MODE** on the remote control repeatedly to select “ALL CH SEARCH” or “CAT SEARCH”.

ALL CH SEARCH

or

CAT SEARCH

2 Press the numeric buttons (0-9) on the remote control to enter the desired three-digit channel number.

For example, to enter the number 123, press the numeric buttons as shown below.



The display changes as follows.

<XM> --1



<XM> -12



<XM>123



- To enter a one-digit or two-digit channel number, press the numeric buttons (0-9) on the remote control and then press **ENT** to confirm the input number.
- If no button is pressed within a few seconds after you enter a one-digit or two-digit number, this unit automatically confirms the entered channel number.
- Pressing a button other than the numeric buttons (0-9) or **ENT** cancels the Direct Number Access mode procedure.
- If you enter the number 0, this unit displays your XM Radio ID (see page 59).

Before performing the following operations, set the operation mode selector on the remote control to **③SOURCE** and then press **①XM**.

Setting the XM™ Satellite Radio preset channels

You can use this feature to store up to 40 XM Satellite Radio channels (A1 to E8: 8 preset channel numbers in each of the 5 preset channel groups). You can then recall any preset channel easily by selecting the preset channel group and number as described in “Preset Search mode” on page 60.

- 1 Search for a channel you want to set as a preset channel by using one of the XM Satellite Radio search modes.**

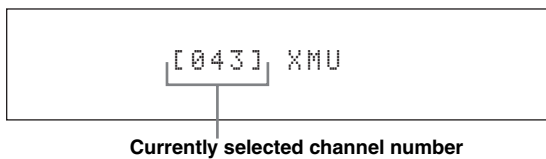

- 2 Press **①MEMORY** (or **④XM MEMORY**).**
The MEMORY indicator flashes in the front panel display for approximately 10 seconds.

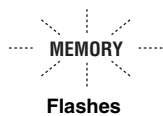

Note

You must proceed to and carry out steps 3 through 5 while the MEMORY indicator is flashing in the front panel display.

- 3 Press **ⓔCATEGORY** (or **③A-E/CAT**. $\triangleleft/\triangleright$) repeatedly to select a preset channel group (A to E) while the MEMORY indicator is flashing.**

The preset channel group letter appears in the front panel display.

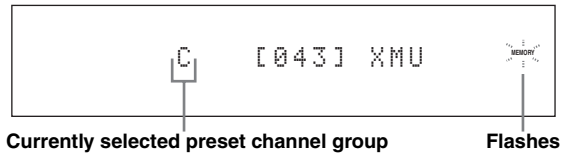

- 4 Press **②PRESET/TUNING/CH** $\triangleleft/\triangleright$ (or **③PRESET/CH** \triangle/∇) repeatedly to select a preset channel number (1 to 8) while the MEMORY indicator is flashing.**

The preset channel number appears in the front panel display.

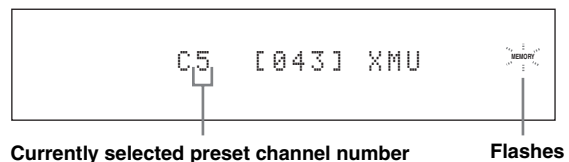

- 5 Press **①MEMORY** (or **④XM MEMORY**) to set the selected XM Satellite Radio channel as a preset channel while the MEMORY indicator is flashing.**

A colon (:) appears next to the preset channel number for confirmation, and the MEMORY indicator turns off in the front panel display.

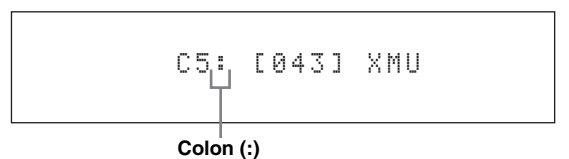

Note

Once you set a new preset channel, the one previously stored in the same preset channel group and number is cleared.

Before performing the following operations, set the operation mode selector on the remote control to **SOURCE** and then press **XM**.

Displaying the XM™ Satellite Radio information

You can display the XM Satellite Radio information (such as channel number, channel name, category, artist name, or song title) for the currently selected channel in the front panel display or in the OSD.

Note

If a status message or an error message appears in the front panel display or in the OSD, see the “XM Satellite Radio (U.S.A. and Canada models only)” section in “Troubleshooting” on page 125 for appropriate remedies.

■ Displaying the XM Satellite Radio information in the front panel display

Press **DISPLAY** (or **DISPLAY**) repeatedly to toggle between the following XM Satellite Radio information display modes.

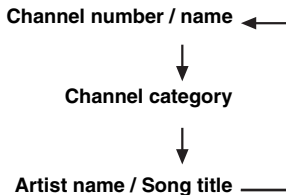

When the channel number / name is displayed:

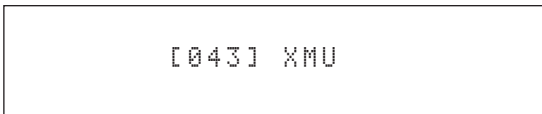

When the channel category is displayed:

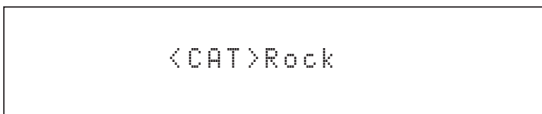

When the artist name / song title is displayed:

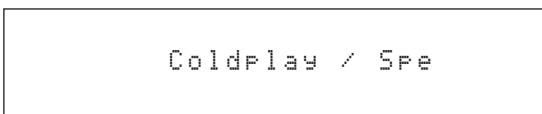

- You can set the front panel display mode by using the “FL SCROLL” parameter in “OPTION MENU” (see page 92).
- If the XM Satellite Radio information contains a character that cannot be recognized by this unit, the character will be displayed with a space.

■ Displaying the XM Satellite Radio information in the OSD

Press **DISPLAY** (or **DISPLAY**).

The following screen is displayed in the OSD.

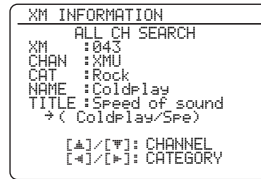

- To turn off the OSD, press **DISPLAY** (or **DISPLAY**).
- You can set the time for which the XM Satellite Radio information is displayed in the OSD after operation by using the “ON SCREEN” parameter in “OPTION MENU” (see page 91).
- To hold the XM Satellite Radio information screen, press **ENTER** on the remote control while it is being displayed in the OSD.
- The XM Satellite Radio information screen on hold is released if you press **ENTER** on the remote control again or if you change the XM Satellite Radio channel.
- This unit can save up to two XM Satellite Radio information screens for future reference. To view the previous two XM Satellite Radio information screens, press **TITLE** on the remote control repeatedly while the current XM Satellite Radio information screen is being hold.

Using iPod™

Once you have stationed your iPod in a Yamaha iPod universal dock (such as the YDS-10, sold separately) connected to the DOCK terminal of this unit (see page 31), you can enjoy playback of your iPod using the supplied remote control. You can also use the Compressed Music Enhancer mode of this unit to enhance the sound quality of the compression artifacts (such as the MP3 format) stored on your iPod (see page 50).

Notes

- Only iPod (Click and Wheel), iPod nano, and iPod mini are supported.
- Some features may not be compatible depending on the model or the software version of your iPod.



- For a complete list of status messages that appear in the front panel display and in the OSD, see the “iPod” section in “Troubleshooting” on page 127.
- Once your iPod is stationed in a Yamaha iPod universal dock (such as the YDS-10, sold separately) connected to the DOCK terminal of this unit, this unit begins signal transmission with your iPod.
- Once the connection between your iPod and this unit is complete, “iPod connected” appears in the front panel display and the DOCK indicator lights up in the front panel display.
- Your iPod battery is automatically charged when your iPod is stationed in a Yamaha iPod universal dock (such as the YDS-10, sold separately) connected to the DOCK terminal of this unit as long as this unit is turned on. You can also select whether this unit charges the battery of the stationed iPod or not when this unit is in the standby mode by selecting the “STANDBY CHARGE” parameter in “INPUT MENU” (on page 90).
- While the stationed iPod is being charged in the standby mode of this unit, the battery charge indicator (see page 34) appears in the front panel display. Once the charge is complete (or after 4 hours from the start of the charge), the indicator disappears.

Controlling iPod™

You can control your iPod when “V-AUX” is selected as the input source. The operations of your iPod can be done with the aid of the OSD of this unit (menu browse mode) or without it (simple remote mode).

■ Remote control operation

Before performing the following operations, set the operation mode selector on the remote control to **③SOURCE** and then press **①V-AUX/DOCK**.

Button	Function
③ ENTER	Subsequent menu
△	Menu up
▽	Menu down
◀	Previous menu
▷	Subsequent menu
⑥ ◀◀	Search backward (Press and hold)
▷▷	Search forward (Press and hold)
▷▷	Skip forward
◀◀	Skip backward
□	Stop
⏸	Pause (Menu browse mode) Play/Pause (Simple remote mode)
▶	Play (Menu browse mode) Play/Pause (Simple remote mode)
⑫ MENU	Previous menu
⑬ DISPLAY	Display

■ Controlling iPod in the simple remote mode

You can perform the basic operations of your iPod (play, stop, skip, etc.) using the supplied remote control without the aid of the OSD of this unit.



- You can view the photos or video clips stored on your iPod.
- Operations can be also done with the controls on your iPod.

■ Controlling iPod in the menu browse mode

You can perform the advanced operations of your iPod using the supplied remote control with the aid of the OSD of this unit. The name of the song being played appears in the front panel display according to the “FL SCROLL” parameter in “OPTION MENU” (see page 92). You can also browse the songs stored on your iPod in the OSD. Further, you can change or adjust settings for your iPod to suit your personal preferences.

Notes

- Operations cannot be done with the controls on your iPod.
- The Yamaha logo appears in the display window of your iPod.
- There are some characters that cannot be displayed in the front panel display or in the OSD of this unit. Those characters are replaced with underscores “_”.
- You cannot browse the photos or video clips stored on your iPod in the OSD. Use the simple remote mode to enjoy watching the photos or video clips stored on your iPod.

Before performing the following operations, set the operation mode selector on the remote control to **SOURCE** and then press **V-AUX/DOCK**.

1 Press **DISPLAY** on the remote control.

The following display appears in the OSD.



2 Press **▲/▼/◀/▶** on the remote control to navigate the iPod menu and then press **ENTER** to begin playback of the selected song.

Choices: Playlists (playlists), Artists (artists), Albums (albums), Songs (songs), Genres (genres), Composers (composers), Settings (settings)

- Playlists > Songs
- Artists > Albums > Songs
- Albums > Songs
- Songs
- Genres > Artists > Albums > Songs
- Composers > Albums > Songs
- Settings > Shuffle, Repeat

Shuffle Shuffle

Use this feature to set this unit to play songs or albums in random order.

Choices: Off, Songs, Albums

- Select “Off” to deactivate this feature.
- Select “Songs” to set this unit to play songs in random order.
- Select “Albums” to set this unit to play albums in random order.

Notes

- When “Shuffle” is set to a setting other than “Off”, “” appears in the top right corner while songs or albums are being shuffled.
- Press **ENTER** repeatedly to toggle between the settings of “Shuffle”.



Repeat Repeat

Use this feature to set this unit to repeat one song or a sequence of songs.

Choices: Off, One, All





- Select “Off” to deactivate this feature.
- Select “One” to set this unit to repeat one song.
- Select “All” to set this unit to repeat a sequence of songs.

Notes

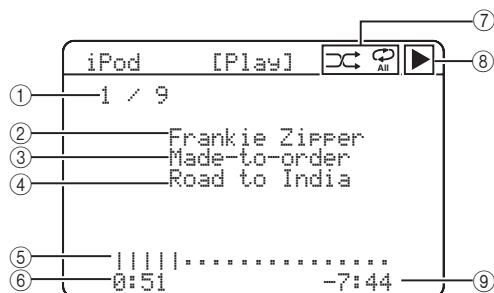
- When “Repeat” is set to a setting other than “Off”, “” or “” appears in the top right corner while one song or a sequence of songs are being repeated.
- Press **ENTER** repeatedly to toggle between the settings of “Repeat”.

■ The function of the play information display



- ① Track number/total tracks
- ② Name of the artist
- ③ Name of the album
- ④ Name of the song
- ⑤ Progress bar
- ⑥ Elapsed time
- ⑦ Shuffle and repeat icons
- ⑧  (playback),  (pausing),  (search forward) or  (search backward)
- ⑨ Remaining time

Recording

Recording adjustments and other operations are performed from the recording components. Refer to the operating instructions for those components.

Caution

The DTS signal is a digital bitstream. Attempting to digitally record the DTS bitstream will result in noise being recorded. Therefore, if you want to use this unit to record sources encoded in DTS, the following considerations and adjustments need to be made. To play DTS-encoded DVDs and CDs (when using a digital audio connection) on your DTS-compatible player, follow its operating instructions to make a setting so that the analog signal will be output from the player.

Notes

- When this unit is set to the standby mode, you cannot record between other components connected to this unit.
- TONE CONTROL (see page 52) and the volume settings, the speaker level (see page 82) and the sound field programs (see page 46) do not affect recorded material.
- The source connected to the MULTI CH INPUT jacks of this unit cannot be recorded.
- The XM Satellite Radio signals (U.S.A. and Canada models only) cannot be output at the audio OUT (REC) jacks.
- Digital signals input at the DIGITAL INPUT jacks are not output at the analog audio OUT (REC) jacks for recording. Likewise, analog signals input at the AUDIO IN jacks are not output at the DIGITAL OUTPUT jack. Therefore, if your source component is connected to provide only digital or analog signals, you can only record digital or analog signals.
- A given input source is not output on the same OUT (REC) channel.
- S-video and composite video signals pass independently through the video circuits of this unit. Therefore, when recording or dubbing video signals input from a video source component that provides only an S-video or a composite video signal, you can record only an S-video or a composite video signal on your VCR.
- The analog audio and video signals input at the DOCK terminal can be output at the analog audio OUT (REC) jacks and DVR or VCR OUT jacks for recording.
- Check the copyright laws in your country to record from CDs, radio, etc. Recording of copyrighted material may infringe copyright laws.



Do a test recording before you start an actual recording.

If you play back a video source that uses scrambled or encoded signals to prevent it from being dubbed, the picture itself may be disturbed due to those signals.

1 Turn on all the connected components.

2 Rotate the **ⓈINPUT selector (or press one of the input selector buttons (①)) to select the source component you want to record from.**

3 Start playback on the selected source component or select a broadcast station.

4 Start recording on the recording component.

Advanced sound configurations

Changing sound field parameter settings

You can enjoy good quality sound with the initial factory settings. Although you do not have to change the initial factory settings, you can change some of the parameters to better suit the input source or your listening room.

Note

You cannot change the sound field parameter values when "MEMORY GUARD" in "OPTION MENU" is set to "ON" (see page 93). If you want to change the sound field parameter values, set "MEMORY GUARD" to "OFF".

1 Turn on the video monitor connected to this unit.

2 Set the operation mode selector to **AMP and then press **PARAMETER** on the remote control.**

The following display is shown in the OSD.

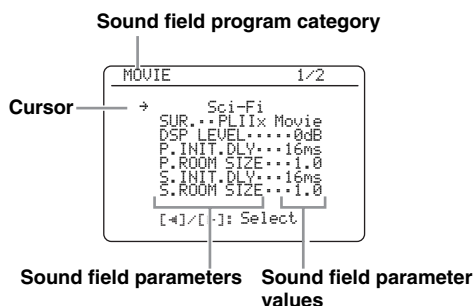

3 Press one of the sound field program selector buttons (24) repeatedly to select the desired sound field program you want to adjust.

4 Press **Δ / **∇** to select the desired sound field parameter and then **◀** / **▶** to change the selected sound field parameter value.**

- Press **▶** to increase the value.
- Press **◀** to decrease the value.



- For details about the function and control range of each sound field parameter, see page 69.
- When you set a sound field parameter to a value other than the initial factory settings, an asterisk mark (*) appears by the sound field parameter name in the OSD.
- Repeat steps 3 and 4 as necessary to change other sound field program parameter settings.
- The available sound field parameters for some of the sound field programs may be displayed on more than one page in the OSD. In this case, press **Δ** / **∇** to scroll through pages.
- If you press and hold **◀** / **▶** to change the sound field parameter value, the initial factory settings are shown momentarily in the front panel display.
- To initialize the parameters of the selected sound field program, press **∇** repeatedly to select "INITIALIZE" and then press **▶**. Once the confirmation screen appears in the OSD, press **▶** to confirm or **◀** to cancel the initialization.

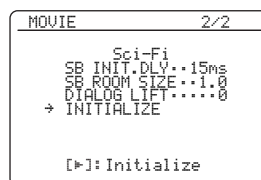

5 Press **PARAMETER to turn off the sound field parameter display.**

SYSTEM MEMORY feature

You can save multiple customized sound field parameter settings by using the SYSTEM MEMORY feature. See page 96 for details.

■ Basic configuration of sound field programs

Each sound field program has some parameters defining the characteristics of the program. To customize the selected sound field program, adjust “DSP LEVEL” and/ or “DIALOG LIFT” first, and then try other parameters.



To change sound field parameter settings, see page 67 for details.

Adjusting the effect sound level of the sound field programs (DSP LEVEL)

Sound field programs add effect sounds (DSP effect sounds) to the original source sound to create sound field in the listening room. Use the “DSP LEVEL” parameter to adjust the level of the effect sounds.

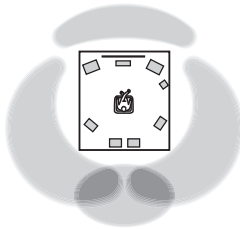

The DSP effect sound level is low

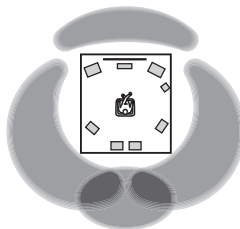

The DSP effect sound level is high

Adjust “DSP LEVEL” as follows:

Increase the value of “DSP LEVEL” when

- the effect sound of the selected sound field program is too weak.
- you cannot recognize any difference between the sound field programs.

Decrease the value of “DSP LEVEL” when

- the sound is vague.
- you feel that the additional sound effect is excessive.

Control range: -6 dB to +3 dB

Adjusting the vertical dialogue position (DIALOG LIFT)

Use this feature to adjust the vertical position of the dialogues in movies. The ideal position of the dialogues is at the center of the video monitor screen.

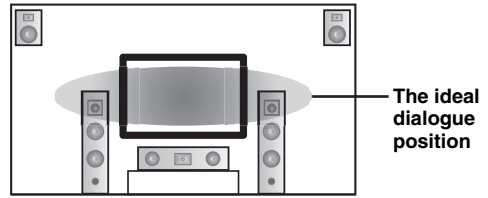

If the dialogues are heard at the lower position of the video monitor screen, increase the value of “DIALOG LIFT”.

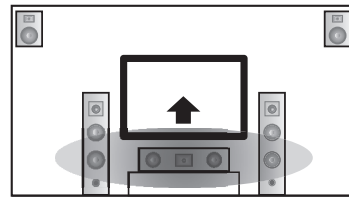

Move up to the ideal dialogue position

Choices: 0, 1, 2, 3, 4, 5

“0” (initial setting) is the lowest position, and “5” is the highest position.

Notes

- “DIALOG LIFT” is available only when “PRESENCE SP” is set to “ON” (see page 81).
- You cannot move the dialogue position down from the initial dialogue position.

■ Sound field parameter descriptions

You can adjust the values of certain digital sound field parameters so that the sound fields are recreated accurately in your listening room. Not all of the following parameters are found in every program.



To change sound field parameter settings to suit your listening environment, see page 67 for details.

Sound field parameter	Features
INIT.DLY P.INIT.DLY S.INIT.DLY SB INIT.DLY	<p>Initial delay. Presence, surround, and surround back sound field initial delay. Changes the apparent size of the sound field by adjusting the delay between the direct sound and the first reflection heard by the listener. The smaller the value, the smaller the sound field seems to the listener.</p> <p> When you adjust the initial delay parameters, we also recommend that you adjust the corresponding room size parameters likewise. This adjustment is especially effective for the CINEMA DSP programs.</p> <hr/> <p>Control range: 1 to 99 ms (INIT.DLY and P.INIT.DLY) 1 to 49 ms (S.INIT.DLY and SB INIT.DLY)</p>

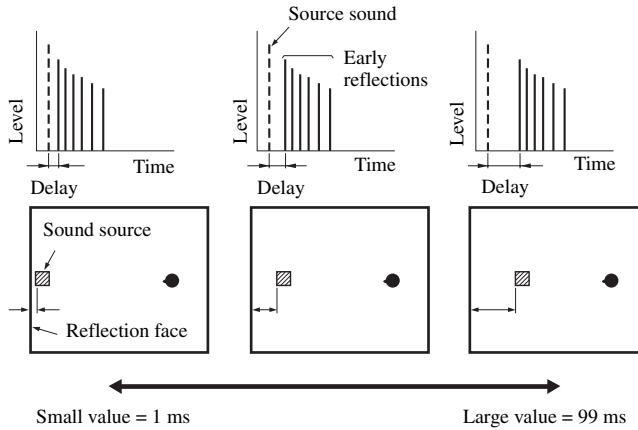

Sound field parameter	Features
ROOM SIZE P. ROOM SIZE S. ROOM SIZE SB ROOM SIZE	<p>Room size. Presence, surround, and surround back room size. Adjusts the apparent size of the sound field. The larger the value, the larger the surround sound field becomes. As the sound is repeatedly reflected around a room, the larger the hall is, the longer the time between the original reflected sound and the subsequent reflections. By controlling the time between the reflected sounds, you can change the apparent size of the virtual venue. Changing this parameter from one to two doubles the apparent length of the room.</p> <p>☼</p> <p>When you adjust the room size parameters, we also recommend that you adjust the corresponding initial delay parameters likewise. This adjustment is especially effective for the CINEMA DSP programs.</p>

Control range: 0.1 to 2.0

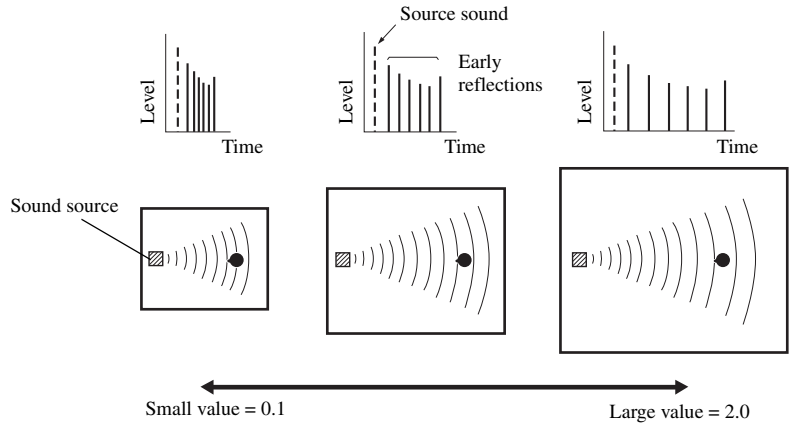

LIVENESS S. LIVENESS SB LIVENESS	<p>Liveness. Surround and surround back liveness. Adjusts the reflectivity of the virtual walls in the hall by changing the rate at which the early reflections decay. The early reflections of a sound source decay much faster in a room with acoustically absorbent wall surfaces than in one which has highly reflective surfaces. A room with acoustically absorbent surfaces is referred to as “dead”, while a room with highly reflective surfaces is referred to as “live”. This parameter lets you adjust the early reflection decay rate and thus the “liveness” of the room.</p>
--	---

Control range: 0 to 10

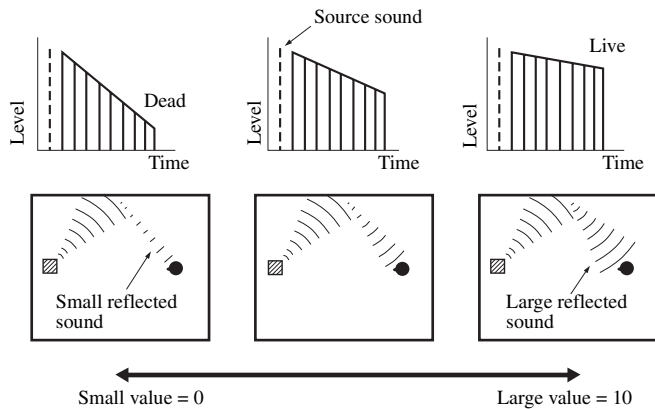

Sound field parameter	Features
REV. TIME	Reverberation time. Adjusts the amount of time taken for the dense, subsequent reverberation sound to decay by 60 dB at 1 kHz. This changes the apparent size of the acoustic environment over an extremely wide range. Set a longer reverberation time to get more sustaining reverberation sound, and set a shorter time to get articulate sound.

Control range: 1.0 to 5.0 s

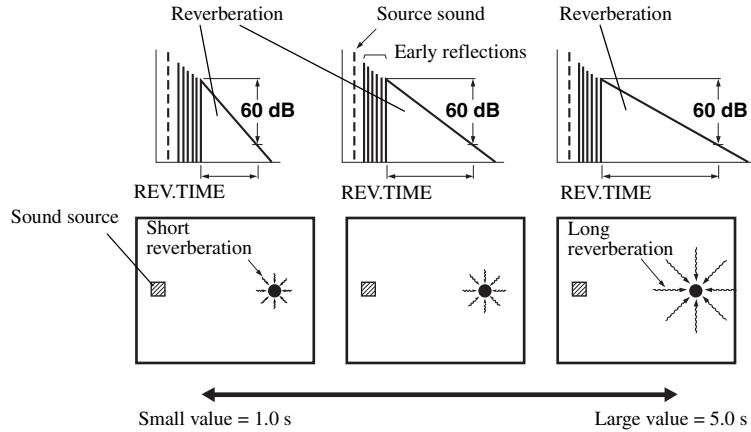

REV. DELAY	Reverberation delay. Adjusts the time difference between the beginning of the direct sound and the beginning of the reverberation sound. The larger the value, the later the reverberation sound begins. A later reverberation sound makes you feel as if you are in a larger acoustic environment.
-------------------	---

Control range: 0 to 250 ms

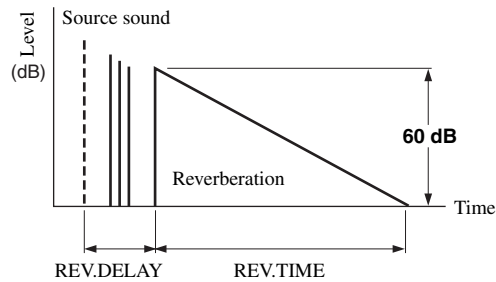

REV. LEVEL	Reverberation level. Adjusts the volume of the reverberation sound. The larger the value, the stronger the reverberation becomes.
-------------------	---

Control range: 0 to 100%

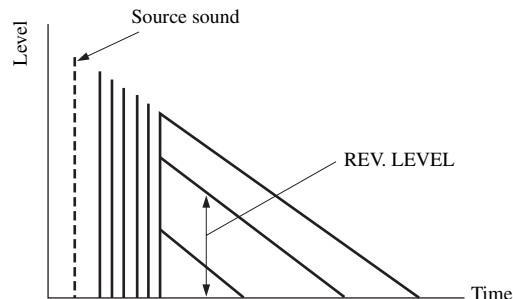



Sound field parameter	Features
DIRECT ("2ch Stereo" only)	<p>2-channel stereo direct. Bypasses the decoders and DSP processors of this unit for pure hi-fi stereo sound when playing 2-channel analog sources.</p> <hr/> <p>Choices: AUTO, OFF</p> <hr/> <p></p> <ul style="list-style-type: none"> • Select "AUTO" to bypass the decoders, DSP processors and the tone control circuitry only when "BASS" and "TREBLE" are set to 0 dB (see page 52). • Select "OFF" not to bypass the decoders, DSP processors and the tone control circuitry when "BASS" and "TREBLE" are set to 0 dB. • When multi-channel signals are input, they are downmixed to 2 channels and output from the front left and right speakers. • The low-frequency signals of the front left and right channels are redirected to the subwoofer in the following cases: <ul style="list-style-type: none"> – "LFE/BASS OUT" is set to "BOTH" (see page 80). – "FRONT SP" is set to "SMALL" (see page 80) and "LFE/BASS OUT" is set to "SWFR" (see page 80).
CT LEVEL SL LEVEL SR LEVEL SB LEVEL PL LEVEL PR LEVEL ("7ch Stereo" only)	<p>7-channel stereo center, surround left, surround right, surround back, presence left and presence right levels. Adjusts the volume level of each channel in the 7-channel stereo mode.</p> <hr/> <p>Control range: 0 to 100%</p>
EFFECT LEVEL ("Straight Enhancer" and "7ch Enhancer" only)	<p>Straight and 7-channel Compressed Music Enhancer effect level. The high-frequency signals of some sources may be emphasized too much. In this case, set the effect level to "LOW".</p> <hr/> <p>Choices: HIGH, LOW</p> <hr/> <ul style="list-style-type: none"> • Select "HIGH" for a high effect level. • Select "LOW" for a low effect level.

Selecting decoders





■ Selecting decoders for 2-channel sources (surround decode mode)

Use this feature to play back sources with selected decoders. You can play back 2-channel sources on multi-channels.

Set the operation mode selector to  AMP and then press  SUR. DECODE repeatedly on the remote control to select the surround decode mode.

You can select the desired surround decoder mode depending on the type of source you are playing and your personal preference.



You can change the decoder parameter settings. Press  PARAMETER and then  /  repeatedly on the remote control to select the desired decoder parameter. You can change the value of the selected parameter by pressing  < / >  repeatedly on the remote control.

■ Decoder descriptions

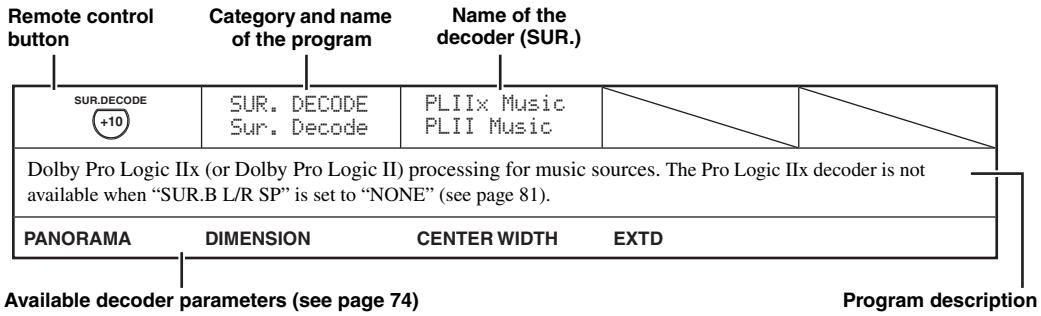

SUR.DECODE (+10)	SUR. DECODE Sur. Decode	PRO LOGIC		
Dolby Pro Logic processing for any sources.				
EXTD				
SUR.DECODE (+10)	SUR. DECODE Sur. Decode	PLIIX Movie PLII Movie		
Dolby Pro Logic Ix (or Dolby Pro Logic II) processing for movie sources. The Pro Logic Ix decoder is not available when "SUR.B L/R SP" is set to "NONE" (see page 81).				
EXTD				
SUR.DECODE (+10)	SUR. DECODE Sur. Decode	PLIIX Music PLII Music		
Dolby Pro Logic Ix (or Dolby Pro Logic II) processing for music sources. The Pro Logic Ix decoder is not available when "SUR.B L/R SP" is set to "NONE" (see page 81).				
PANORAMA	DIMENSION	CENTER WIDTH	EXTD	
SUR.DECODE (+10)	SUR. DECODE Sur. Decode	PLIIX Game PLII Game		
Dolby Pro Logic Ix (or Dolby Pro Logic II) processing for game sources. The Pro Logic Ix decoder is not available when "SUR.B L/R SP" is set to "NONE" (see page 81).				
EXTD				
SUR.DECODE (+10)	SUR. DECODE Sur. Decode	Neo:6 Cinema		
DTS processing for movie sources.				
EXTD				
SUR.DECODE (+10)	SUR. DECODE Sur. Decode	Neo:6 Music		
DTS processing for music sources.				
C. IMAGE	EXTD			

SUR.DECODE 	SUR. DECODE Sur. Decode	Neural-THX (U.S.A. and Canada models only)	/	/
Neural-THX Surround processing for any sources. The Neural-THX Surround decoder is especially suitable for the XM HD Surround program of XM Satellite Radio.				
EXTD				



When you select the surround decode mode for the multi-channel digital sources, this unit automatically selects the corresponding decoder for each source.

Decoder parameter descriptions

Decoder parameter	Features
EXTD (“U.S.A. and Canada models only”)	<p>Extended surround mode. Selects the extended surround mode used for the multi-channel sources when the decoder is selected. See page 87 for details.</p> <hr/> <p>Choices: AUTO, PLIIx Movie, PLIIx Music, EX/ES, EX, Neural-THX, OFF</p> <p> You can select “Neural-THX” in “EXTD”. When you select “Neural-THX” in “EXTD”, this unit plays back Dolby Digital or DTS signals in 6.1/7.1 channels using the Neural-THX Surround decoder.</p>
PANORAMA (“PLIIx Music” and “PLII Music” only)	<p>Pro Logic IIX Music and Pro Logic II Music panorama. Sends stereo signals to the surround speakers as well as the front speakers for a wraparound effect.</p> <hr/> <p>Choices: OFF, ON</p>
DIMENSION (“PLIIx Music” and “PLII Music” only)	<p>Pro Logic IIX Music and Pro Logic II Music dimension. Adjusts the sound field either towards the front or towards the rear.</p> <hr/> <p>Control range: -3 (towards the rear) to +3 (towards the front)</p> <hr/> <p>Initial setting: STD (standard)</p>
CENTER WIDTH (“PLIIx Music” and “PLII Music” only)	<p>Pro Logic IIX Music and Pro Logic II Music center width. Moves the center channel output completely towards the center speaker or towards the front left and right speakers. A larger value moves the center channel output towards the front left and right speakers.</p> <hr/> <p>Control range: 0 (center channel sound is output only from the center speaker) to 7 (center channel sound is output only from the front left and right speakers)</p> <hr/> <p>Initial setting: 3</p>
C. IMAGE (“Neo:6 Music” only)	<p>DTS Neo:6 Music center image. Adjusts the front left and right channel output relative to the center channel to make the center channel more or less dominant as necessary.</p> <hr/> <p>Control range: 0.0 (center channel sound is output only from the front left and right speakers) to 1.0 (center channel sound output only from the center speaker)</p> <hr/> <p>Initial setting: 0.3</p>

■ Selecting decoders used with sound field programs (SUR.)

Use this feature to select the desired decoder used with MOVIE sound field programs (except “Mono Movie”). See page 49 for details about MOVIE sound field program.

Available decoders

Decoder	Functions
PLIIx Movie PLII Movie	Dolby Pro Logic IIX (or Dolby Pro Logic II) processing for movie sources. The Pro Logic IIX decoder is not available when “SUR.B L/R SP” is set to “NONE” (see page 81).
Neo:6 Cinema	DTS processing for movie sources

Customizing this unit (MANUAL SETUP)

You can use the following parameters in “SET MENU” to adjust a variety of system settings and customize the way this unit operates. Change the initial settings (indicated in bold under each parameter) to reflect the needs of your listening environment.

■ Auto setup AUTO SETUP

Use this feature to automatically adjust speaker and system parameters (see page 37).

■ Manual setup MANUAL SETUP

Use this feature to manually adjust speaker and system parameters.

Basic menu 1 BASIC MENU

Menu	Parameter	Functions	Page
A)SPEAKER SET	LFE/BASS OUT	Selects the speakers that output the LFE (low-frequency effect) and the low-frequency signals.	80
	FRONT SP	Selects the size of the front speakers.	80
	CENTER SP	Selects the size of the center speaker.	80
	SUR. L/R SP	Selects the size and number of the surround speakers.	81
	SUR. B L/R SP	Selects the size and number of the surround back speakers.	81
	PRESENCE SP	Selects whether this unit uses the presence speakers.	81
	CROSS OVER	Selects the crossover frequency of all the speakers set to “SML” (or “SMALL”) or to “NONE” in “SPEAKER SET” (see pages 80 and 81).	81
	SUBWOOFER PHASE	Switches the phase of your subwoofer if bass sounds are lacking or unclear.	82
	PRIORITY	Prioritizes either the presence or the surround back speakers when playing back sources that contain surround back channel signals using the CINEMA DSP sound field programs.	82
B)SPEAKER LEVEL	FR.L/FR.R/ CENT./SUR.L/ SUR.R/SB L/SB R/ SWFR/PR.L/PR.R	Adjust the balance the speaker levels between the front left or surround left speakers and each speaker selected in “SPEAKER SET” (see page 80).	82
C)SP DISTANCE	UNIT	Selects the unit to adjust the speaker distance.	83
	FRONT L/FRONT R/ CENTER/SUR. L/ SUR. R/SB L/SB R/SWFR/PRNS L/ PRNS R	Adjust the distance of each speaker and the delay applied to the respective channel.	83
D)TEST TONE	—	Turns the test tone output on or off for the “SPEAKER SET”, “SPEAKER LEVEL”, and “SP DISTANCE” settings.	83

Volume menu 2 VOLUME MENU

Parameter	Functions	Page
ADAPTIVE DRC	Selects whether this unit automatically adjusts the dynamic range in conjunction with the volume level or not.	84
ADAPTIVE DSP LEVEL	Selects whether this unit adjusts the DSP effect level automatically in conjunction with the volume level or not.	84
MUTING TYPE	Adjusts how much the mute function reduces the output volume (see page 44).	84
MAX VOL.	Sets the maximum volume level of the main zone.	84
INIT. VOL.	Sets the volume level of the main zone when the power of this unit is turned on.	84

Sound menu 3 SOUND MENU

Menu	Parameter	Functions	Page
A)EQUALIZER	EQ TYPE SELECT	Selects the type of equalizer.	85
	GEQ	Adjusts the tonal quality of the speakers when you set "EQ TYPE SELECT" to "GEQ".	85
	TEST	Selects whether this unit outputs the test tone while making adjustments of "GEQ" or not.	85
B)LFE LEVEL	SPEAKER	Adjusts the speaker LFE level.	86
	HEADPHONE	Adjusts the headphone LFE level.	86
C)DYNAMIC RANGE	SPEAKER	Adjusts the amount of the dynamic range compression of the speakers.	86
	HEADPHONE	Adjusts the amount of the dynamic range compression of the headphones.	86
D)LIPSYNC	HDMI AUTO	Selects whether this unit activates the automatic audio and video synchronization function (automatic lip sync) or not.	87
	AUTO DELAY	Makes fine adjustments of the audio delay when the automatic audio and video synchronization function is active.	87
	MANUAL DELAY	Adjustment the audio delay manually when the connected video monitor is not compatible with the automatic audio and video synchronization function or "HDMI AUTO" is set to "OFF".	87
E)AUDIO SET	EXTD SUR.	Use this feature to enjoy 6.1/7.1-channel playback for multi-channel sources using the Dolby Pro Logic IIx, Dolby Digital EX, or DTS-ES decoders by using the connected surround back speakers.	87
	TONE BYPASS	Selects whether the audio output bypasses the tone control circuitry when "TREBLE" and "BASS" are set to 0 dB (see page 52).	87
F)HDMI SET	SUPPORT AUDIO	Selects whether to play back HDMI audio signals on this unit or on another HDMI component connected to the HDMI OUT jack.	88

Input menu 4 INPUT MENU

Note

Some parameters described below may not be available for all input sources and some parameters are only available for specific input sources.

Parameter	Functions	Page
I/O ASSIGNMENT	Assigns the input/output jacks according to the component to be used if the initial settings of this unit do not correspond to your needs.	89
INPUT RENAME	Changes the name of the input source that appears in the OSD and in the front panel display.	89
VOL. TRIM	Adjusts the level of the signal input at each jack.	89
DECODER MODE	Switches the decoder activation mode. You can designate the reassigned digital input jacks for DTS signals.	89
ANTENNA LEVEL (U.S.A. and Canada models only)	Displays the current reception level of the XM Satellite Radio signals (see page 58).	90
STANDBY CHARGE	Selects whether this unit charges the battery of the stationed iPod or not when this unit is in the standby mode (see page 64).	90
BGV	Selects the video source played back in the background of the sources input at the MULTI CH INPUT jacks.	90
INPUT CH	Selects the number of channels input from an external decoder.	90
FRONT	Selects the analog jacks at which the front channel signals from an external decoder are input when you set "INPUT CH" to "8CH".	90

Option menu 5 OPTION MENU

Menu	Parameter	Functions	Page
A)DISPLAY SET	DIMMER	Adjusts the brightness of the front panel display.	91
	OSD SHIFT	Adjusts the vertical position of the OSD.	91
	GRAY BACK	Selects whether this unit displays a gray background in your video monitor when there is no video signal being input.	91
	SHORT MESSAGE	Selects whether this unit displays the short messages on the video monitor after you perform a certain operation.	91
	ON SCREEN	Sets the time for which the XM Satellite Radio information or iPod menu is displayed in the OSD after you perform a certain operation.	91
	FL SCROLL	Selects the mode to display the information of the XM Satellite Radio or iPod in the front panel display.	92

Menu	Parameter	Functions	Page
B>VIDEO SET	VIDEO CONV.	Selects whether to convert the video signals input at the VIDEO, S VIDEO, and COMPONENT VIDEO jacks.	92
	COMPONENT I/P	Selects whether this unit activates the analog interlace/progressive conversion of the analog video signals input at the VIDEO, S VIDEO, and COMPONENT VIDEO jacks so that the analog video signals deinterlaced from 480i (NTSC)/576i (PAL) to 480p/576p are output at the COMPONENT MONITOR OUT jacks.	92
	HDMI SCALING	Selects whether this unit activates the HDMI up-conversion of the analog video signals input at the VIDEO, S VIDEO, and COMPONENT VIDEO jacks so that the up-scaled analog video signals are output at the HDMI OUT jack.	92
	HDMI ASPECT	Adjusts the aspect ratio for analog video signals output at the HDMI OUT jack.	93
C>MEMORY GUARD	—	Prevents accidental changes to sound field program parameter values and other system settings.	93
D>INIT. CONFIG	AUDIO SELECT	Designates the default audio input jack select setting for the input sources connected to the DIGITAL INPUT jacks when you turn on the power of this unit.	94
	DECODER MODE	Designates the default decoder mode for the input sources connected to the DIGITAL INPUT jacks when you turn on the power of this unit.	94
	EXTD SUR.	Designates the extended decoder mode for the input sources connected to the DIGITAL INPUT jacks when you turn on the power of this unit.	94
E>ZONE SET	AMP	Selects how the Zone 2 or Zone 3 speakers are amplified.	94
	VOLUME	Selects whether this unit controls the volume level of the audio signals output at the ZONE OUT (ZONE 2 or ZONE 3) jacks.	95
	MAX VOL.	Adjusts the maximum volume level in Zone 2 or Zone 3.	95
	INIT. VOL.	Sets the volume level of Zone 2 or Zone 3 when you turn on the power of this unit.	95

■ **System memory** SYSTEM MEMORY

Use this feature to create your favorite settings and assign the settings to each **SYSTEM MEMORY** button (see page 96).

■ **Signal information** SIGNAL INFO

Use this feature to check audio signal information (see page 44).

Using SET MENU

Use the remote control to access and adjust each parameter.



- You can change the “SET MENU” parameters while this unit is reproducing sound.
- If you press **Ⓜ**PARAMETER during the “SET MENU” operation, the “SET MENU” operation is canceled.
- Repeat the following procedure to select and adjust each parameter setting.
- Press **Ⓜ**RETURN to return to the previous menu level.

1 Set the operation mode selector to **Ⓜ**AMP and then press **Ⓜ**SET MENU to enter “SET MENU”.

The top “SET MENU” display appears in the OSD.

2 Press **Ⓜ**△/▽ to select “MANUAL SETUP”.

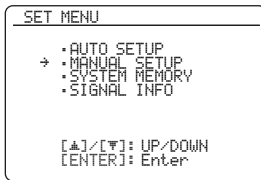

3 Press **Ⓜ**ENTER to enter “MANUAL SETUP”.

The “MANUAL SETUP” display appears in the OSD.

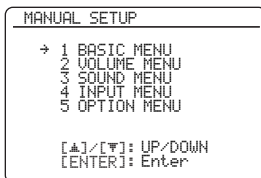

4 Press **Ⓜ**△/▽ repeatedly and then press **Ⓜ**ENTER to select and enter the desired menu.

The following displays are examples where “SOUND MENU” is selected.

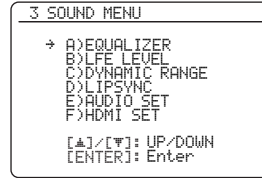

5 Press **Ⓜ**△/▽ repeatedly and then press **Ⓜ**ENTER to select and enter the desired submenu.

The following display is an example where “LFE LEVEL” is selected.

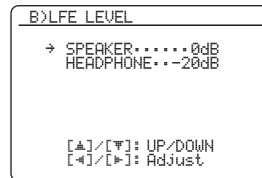

6 Press **Ⓜ**△/▽ to select the desired parameter and then **Ⓜ**◀/▶ to change the parameter settings.

- Press **Ⓜ**▶ to increase the value.
- Press **Ⓜ**◀ to decrease the value.

7 Press **Ⓜ**SET MENU to exit from “SET MENU”.

1 BASIC MENU

Use this feature to manually adjust the basic speaker settings. Most of the “BASIC MENU” parameters are set automatically when you run the automatic setup.



Set “TEST TONE” to “ON” to output the test tone for the “SPEAKER SET”, “SPEAKER LEVEL” and “SP DISTANCE”.

■ Speaker settings A) SPEAKER SET

LFE/bass out LFE/BASS OUT

Use this feature to select the speakers that output the LFE (low-frequency effect) and the low-frequency signals.

Choices: SWFR, FRONT, **BOTH**

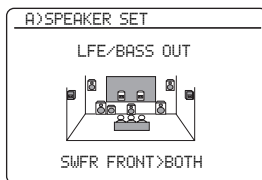

When a subwoofer is connected to this unit and you want to get natural bass sound:

Select “SWFR” (subwoofer). The LFE signals as well as the low-frequency signals of other speakers set to “SML” (or “SMALL”) are directed to the subwoofer.

When a subwoofer is connected to this unit and you want to get rich bass sound:

Select “BOTH” (both). The low-frequency signals of any source are output from the subwoofer. The LFE signals as well as the low-frequency signals of other speakers set to “SML” (or “SMALL”) are directed to the subwoofer. The low-frequency signals of the front left and right channels are directed to the front left and right speakers and the subwoofer regardless of the “FRONT SP” setting.

When you do not use a subwoofer:

Select “FRONT” (front). The LFE signals, the low-frequency signals of the front left and right channels, and the low-frequency signals of other speakers set to “SML” (or “SMALL”) are all directed to the front left and right speakers regardless of the “FRONT SP” setting.

Measure for the speaker size

The woofer section of a speaker is

- 16 cm (6.5 in) or larger: large
- smaller than 16 cm (6.5 in): small

Front speakers FRONT SP

Choices: SMALL, **LARGE**

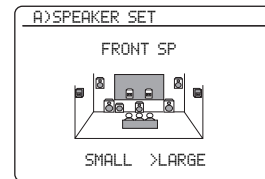

When the front speakers are large:

Select “LARGE” (large).

When the front speakers are small:

Select “SMALL” (small).

Notes

- When “LFE/BASS OUT” is set to “FRONT”, the LFE signals found in bitstream sources, the low-frequency signals of the front left and right channels, and the low-frequency signals of other speakers set to “SML” (or “SMALL”) are all directed to the front left and right speakers regardless of the “FRONT SP” setting.
- When “LFE/BASS OUT” is set to “FRONT”, you can select only “LARGE” in “FRONT SP”. If the value of “FRONT SP” is set to other than “LARGE” in advance, this unit change the value to “LARGE” automatically.

Center speaker CENTER SP

Choices: NONE, **SMALL**, LARGE

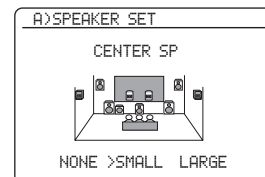

When the center speaker is large:

Select “LARGE” (large).

When the center speaker is small:

Select “SMALL” (small).

When you do not use the center speaker:

Select “NONE” (none). The center channel signals are directed to the front left and right speakers.

Measure for the speaker size

The woofer section of a speaker is

- 16 cm (6.5 in) or larger: large
- smaller than 16 cm (6.5 in): small

Surround left/right speakers SUR. L/R SP

Choices: NONE, **SMALL**, LARGE

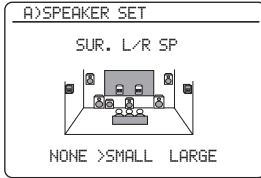

When the surround speakers are large:

Select "LARGE" (large).

When the surround speakers are small:

Select "SMALL" (small).

When you do not use the surround speakers:

Select "NONE" (none). This unit is set to the Virtual CINEMA DSP mode (see page 51), and "SUR.B L/R SP" is automatically set to "NONE".



See page 17 for the connection information of the surround back speakers.

Surround back left/right speakers

SUR. B L/R SP

Choices: NONE, SMLx1, **SMLx2**, LRGx1, LRGx2

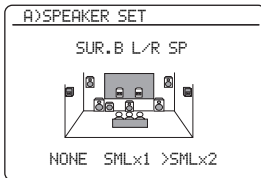

When the surround back left and right speakers are large:

Select "LRGx2" (large x 2).

When the single surround back speaker is large:

Select "LRGx1" (large x 1).

When the surround back left and right speakers are small:

Select "SMLx2" (small x 2).

When the single surround back speaker is small:

Select "SMLx1" (small x 1).

When you do not use the surround back speakers:

Select "NONE" (none). The surround back channel signals are directed to the surround left and right speakers.



See page 17 for the connection information of the surround back speakers.

Note

If the Dolby TrueHD audio signals are input and "SUR.B L/R SP" is set to "NONE", the left and right surround back channels are not directed to the surround left and right speakers.

Presence speakers PRESENCE SP

Use this feature if you want to use the presence speakers connected to this unit.

Choices: NONE, **YES**

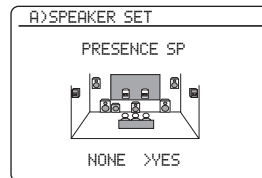

When you do not use the presence speakers:

Select "NONE" (none).

When you use the presence speakers:

Select "YES" (yes).

Note

"DIALOG LIFT" is available only when "PRESENCE SP" is set to "YES".

Bass cross over CROSS OVER

Use this feature to select the crossover frequency of all the speakers set to "SML" (or "SMALL") or "NONE" in "SPEAKER SET" (see page 80). All frequencies below the selected frequency will be sent to the subwoofer or to the speakers set to "LRG" (or "LARGE") in "SPEAKER SET" (see page 80).

Choices: 40Hz, 60Hz, **80Hz**, 90Hz, 100Hz, 110Hz, 120Hz, 160Hz, 200Hz



If your subwoofer can adjust the output volume and the crossover frequency, set the volume to about half way (or slightly less) and set the crossover frequency to the maximum.

Subwoofer phase SUBWOOFER PHASE

Use this feature to switch the phase of your subwoofer if bass sounds are lacking or unclear.

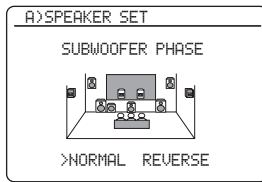

Choice	Functions
NORMAL (normal)	Does not change the phase of your subwoofer.
REVERSE (reverse)	Sets the phase of your subwoofer to reverse.

Presence/surround back channel priority PRIORITY

Use this feature to prioritize either the presence or the surround back speakers when playing back 2-channel audio sources using the sound field programs.

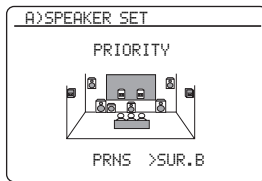

Choice	Functions
PRNS	Uses the presence speakers.
SUR.B	Uses the surround back speakers.



For details about the sound output from each speaker in sound field programs, refer to “Sound output in each sound field program” in “APPENDIX” at the end of this manual.

Speaker level B>SPEAKER LEVEL

Use this feature to manually balance the speaker levels between the front left or surround left speakers and each speaker selected in “SPEAKER SET” (see page 80).

Control range: -10.0 dB to +10.0 dB

Control step: 0.5 dB

Initial setting:

FR.L/FR.R/SWFR/PR.L/PR.R: 0 dB

CENT./SUR.L/SUR.R/SB L/SB R: -1.0 dB

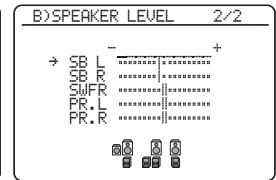
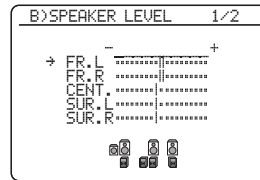

SPEAKER LEVEL	Adjusted speaker
FR.L	Front left speaker
FR.R	Front right speaker
CENT.	Center speaker
SUR.L	Surround left speaker
SUR.R	Surround right speaker
SB L	Surround back left speaker
SB R	Surround back right speaker
SWFR	Subwoofer
PR.L	Presence left speaker
PR.R	Presence right speaker



- If your subwoofer can adjust the output volume and the crossover frequency, set the volume to about half way (or slightly less) and set the crossover frequency to the maximum.
- Set “TEST TONE” to “ON” to output the test tone for the “SPEAKER LEVEL” setting (see page 83).

Notes

- The available speaker channels differ depending on the setting of the speakers.
- Instead of “SB L” and “SB R”, “SB” is displayed if “SUR. B L/ R SP” is set to either “SMLx1” or “LRGx1” (see page 81).

■ Speaker distance C)SP DISTANCE

Use this feature to manually adjust the distance of each speaker and the delay applied to the respective channel. Ideally, each speaker should be the same distance from the main listening position. However, this is not possible in most home situations. Thus, a certain amount of delay must be applied to the sound from each speaker so that all sounds will arrive at the listening position at the same time.

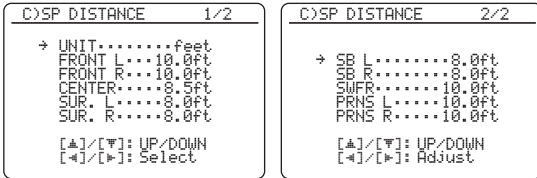

Unit for the speaker distance adjustment UNIT

Initial setting:

[U.S.A. and Canada models]: feet (ft)

[Other models]: meters (m)

Choice	Functions
meters (m)	Adjusts speaker distances in meters.
feet (ft)	Adjusts speaker distances in feet.

Speaker distances

Control range: 0.30 to 24.00 m (1.0 to 80.0 ft)

Control step: 0.10 m (0.5 ft)

Initial setting:

FRONT L/FRONT R/SWFR/PRNS L/

PRNS R: 3.00 m (10.0 ft)

CENTER: 2.60 m (8.5 ft)

SUR. L/SUR. R/SB L/SB R: 2.40 m (8.0 ft)

SP DISTANCE	Adjusted speaker
FRONT L	Front left speaker
FRONT R	Front right speaker
CENTER	Center speaker
SUR. L	Surround left speaker
SUR. R	Surround right speaker
SB L	Surround back left speaker
SB R	Surround back right speaker
SWFR	Subwoofer
PRNS L	Presence left speaker
PRNS R	Presence right speaker



If your subwoofer can adjust the output volume and the crossover frequency, set the volume to about half way (or slightly less) and set the crossover frequency to the maximum.

Notes

- The available speaker channels differ depending on the setting of the speakers.
- Instead of “SB L” and “SB R”, “SUR.B” is displayed if “SUR.B L/R SP” is set to either “SMLx1” or “LRGx1” (see page 81).

■ Test tone D)TEST TONE

Turns the test tone output on or off for the “SPEAKER SET”, “SPEAKER LEVEL”, and “SP DISTANCE” settings.

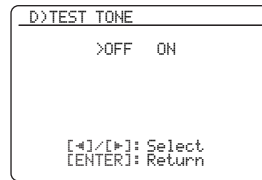

Choice	Functions
OFF	This unit does not output the test tone for the “SPEAKER SET”, “SPEAKER LEVEL”, and “SP DISTANCE” settings.
ON	This unit outputs the test tone for the “SPEAKER SET”, “SPEAKER LEVEL”, and “SP DISTANCE” settings.



If you use a handheld sound pressure level meter, hold at arm’s length and point upwards so that the meter is in the listening position. With the meter set to the 70 dB scale and to C SLOW, calibrate each speaker to 75 dB.

Note

This function is automatically turned off if you exit from “BASIC MENU”.

2 VOLUME MENU

Use this menu to manually adjust the various volume settings.

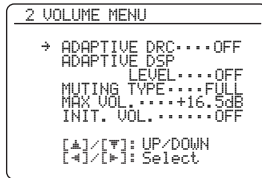

Adaptive dynamic range control

ADAPTIVE DRC

Use this feature to adjust the dynamic range in conjunction with the volume level. This feature is useful when you are listening at lower volumes or at night. When “ADAPTIVE DRC” is set to “AUTO”, this unit controls the dynamic range as follows:

- If the VOLUME setting is low: the dynamic range is narrow
- If the VOLUME setting is high: the dynamic range is wide

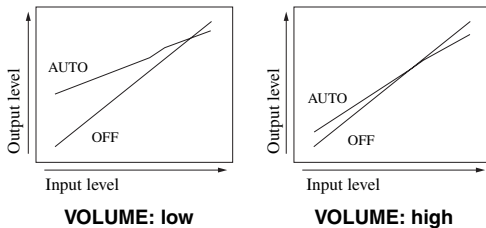

Choice	Functions
AUTO	Adjusts the dynamic range automatically.
OFF	Does not adjust the dynamic range automatically.



- You can also adjust the dynamic range of the bitstream signal sources by using “DYNAMIC RANGE” in “SOUND MENU” (see page 86).
- This function is also useful for listening with your headphones.

Note

The adaptive dynamic range control feature does not function when this unit is in the Pure Direct mode (see page 52).

Adaptive DSP level ADAPTIVE DSP LEVEL

Use this feature to make fine adjustments of the DSP effect level (see page 68) automatically in conjunction with the volume level.

Choice	Functions
AUTO	Adjusts the DSP effect level in conjunction with the volume level.
OFF	Does not adjust the DSP effect level automatically.

Note

Even if you set “ADAPTIVE DSP LEVEL” to “AUTO”, this unit does not change but the fine-tunes the specified value of “DSP LEVEL” (see page 68).

Muting type MUTING TYPE

Use this feature to adjust how much the mute function reduces the output volume (see page 44).

Choice	Functions
FULL	Mutes all the audio output.
-20dB	Reduces the current volume by 20 dB.

Maximum volume MAX VOL.

Use this feature to set the maximum volume level in the main zone. This feature is useful to avoid the unexpected loud sound by mistake. For example, the original volume range is -80.0 dB to +16.5 dB. However, when “MAX VOL.” is set to -5.0 dB, the volume range becomes -80.0 dB to -5.0 dB.

Control range: -30.0 dB to +15.0 dB, **+16.5 dB**

Control step: 5.0 dB

Notes

- When this unit is in the auto setup procedure, the volume level is automatically set to 0 dB regardless of the current “MAX VOL.” setting.
- The “MAX VOL.” setting takes priority over the initial volume setting. For example, if “INI.VOL.” is set to -20.0 dB and “MAX VOL.” is set to -30.0 dB, the volume level is automatically set to -30.0 dB when you turn on the power of this unit next time.
- Use “MAX VOL.” in “ZONE SET” to set the initial volume level in Zone 2 or Zone 3.

Initial volume INIT. VOL.

Use this feature to set the volume level of the main zone when the power of this unit is turned on.

Choices: **OFF**, MUTE, -80.0 dB to +16.5 dB

Control step: 0.5 dB

Note

The “MAX VOL.” setting takes priority over the initial volume setting.

3 SOUND MENU

Use this feature to adjust the audio parameters.

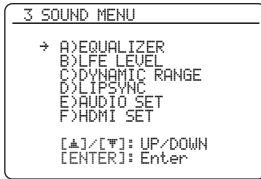

Equalizer A)EQUALIZER

Use this feature to select the parametric equalizer or the graphic equalizer.

Equalizer type select EQ TYPE SELECT

Use this feature to select the type of equalizer.

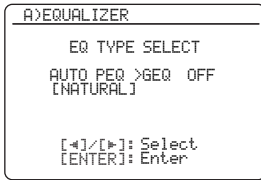

Choice	Functions
AUTO PEQ	Uses the parametric equalizer adjusted in "AUTO SETUP" (see page 37).
GEQ	Adjusts the built-in 7-frequency band graphic equalizer so that the tonal quality of the speakers matches. Press ⓈENTER to display the graphic equalizer screen.
OFF	Deactivates the equalizing feature.



Currently applied parametric equalizer type (see page 40) appears under "AUTO PEQ".

Note

You can select "AUTO PEQ" only when you carry out "AUTO SETUP" in advance (see page 37). In this case, "AUTO PEQ" is automatically selected as the default setting.

Graphic equalizer GEQ

Use this feature to match the tonal quality of the center, surround L/R and surround back L/R, surround back, presence L/R speakers and the subwoofer with that of the front L/R speakers. You can adjust 7 frequency bands (63 Hz, 160 Hz, 400 Hz, 1 kHz, 2.5 kHz, 6.3 kHz, 16 kHz).

Control range: -6.0 dB to +6.0 dB

Control step: 0.5 dB

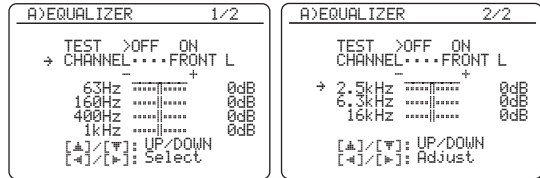

Press **ⓈΔ / ▽** to select a frequency band and **Ⓢ◀ / ▶** to adjust the selected frequency band.

Note

The "GEQ" parameter can be adjusted only when "GEQ" is selected in "EQ TYPE SELECT".

Test tone TEST

Use this feature to make adjustments of "GEQ" while listening to a test tone. To select "TEST", press **ⓈΔ / ▽** repeatedly in the graphic equalizer screen.

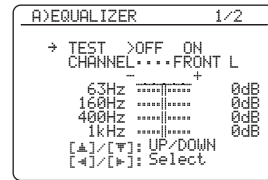

Choice	Functions
OFF	Does not output test tones and output the currently selected source component.
ON	Outputs test tones from the selected speakers.

■ Low-frequency effect level

B>LFE LEVEL

Use this feature to adjust the output level of the LFE (low-frequency effect) channel according to the capacity of your subwoofer or headphones. The LFE channel carries low-frequency special effects which are only added to certain scenes. This setting is effective only when this unit decodes bitstream signals.

Control range: -20 to 0 dB

Control step: 1 dB

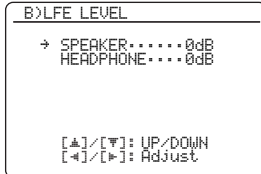

Speakers SPEAKER

Adjusts the speaker LFE level.

Headphones HEADPHONE

Adjusts the headphone LFE level.

Note

Depending on the settings of “LFE/BASS OUT” (see page 80), some signals may not be output at the SUBWOOFER PRE OUT jack.

■ Dynamic range C>DYNAMIC RANGE

Use this feature to select the amount of dynamic range compression to be applied to your speakers or headphones. This setting is effective only when this unit is decoding bitstream signals.

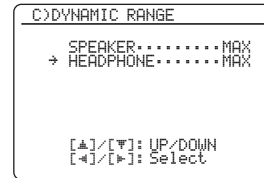

Speakers SPEAKER

Adjusts the dynamic range compression for the speakers.

Headphones HEADPHONE

Adjusts the dynamic range compression for the headphones.

Choice	Functions
MIN/AUTO	<ul style="list-style-type: none"> • MIN: Adjusts the dynamic range to narrow when this unit is decoding bitstream signals (except Dolby TrueHD). • AUTO: Adjusts the dynamic range according to the instruction of the input source signals when this unit is decoding Dolby TrueHD signals.
STD	Adjusts the dynamic range to medium. When this unit is decoding Dolby TrueHD signals, the dynamic range control is always active regardless of the instruction of the input source signals.
MAX	Preserves the greatest amount of dynamic range.

Audio and video synchronization (lip sync) D>LIPSYNC

Use this feature to adjust the audio and video synchronization.

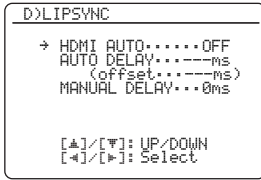

HDMI automatic lip sync mode HDMI AUTO

If the connected video monitor is connected to the HDMI OUT jack of this unit and compatible with the automatic audio and video synchronization function (automatic lip sync), this unit adjusts the audio and video synchronization automatically. Use this feature to activate or deactivate the automatic lip sync.

Choices: ON, **OFF**

If the connected video monitor is compatible with the automatic lip sync:

Select “ON”. Use “AUTO DELAY” to make fine adjustments of the audio and video synchronization.

If the video monitor is not compatible with the automatic lip sync or you do not want to use the automatic lip sync:

Select “OFF”. Use “MANUAL DELAY” to adjust the audio and video synchronization.

Auto delay AUTO DELAY

Use this feature to make fine adjustments of the audio and video synchronization when you set “HDMI AUTO” to “ON”.

Control range: **0** to 240 ms

Control step: 1 ms



“offset” indicates the difference between the value of the audio delay that this unit sets automatically and the value of the audio delay that you set in “AUTO DELAY”. This unit stores the value of “offset” and applies the value to other automatic lip sync compatible video monitors.

Manual delay MANUAL DELAY

Use this feature to adjust the delay of the sound output manually to synchronize audio with video images when you set “HDMI AUTO” to “OFF”.

Control range: **0** to 240 ms

Control step: 1 ms

Audio settings E>AUDIO SET

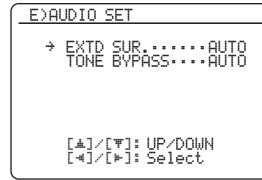

Extended surround EXTD SUR.

Use this feature to enjoy 6.1/7.1-channel playback for multi-channel sources using the Dolby Pro Logic IIX, Dolby Digital EX, or DTS-ES decoders by using the connected surround back speakers.

Choice	Functions
AUTO	Activates the optimum decoder to play back signals in 6.1/7.1 channels when this unit recognizes a signal flag being input.
PLIIXMovie	Plays back Dolby Digital or DTS signals in 7.1 channels using the Pro Logic IIX movie decoder.
PLIIXMusic	Plays back Dolby Digital or DTS signals in 6.1/7.1 channels using the Pro Logic IIX music decoder.
EX/ES	Plays back Dolby Digital or DTS signals in 6.1/7.1 channels using the Dolby Digital EX or DTS-ES decoder.
EX	Plays back Dolby Digital or DTS signals in 6.1/7.1 channels using the Dolby Digital EX decoder.
OFF	Does not use any decoders to create 6.1/7.1 channels.

Note

(U.S.A. and Canada models only) “EXTD SUR.” does not function when this unit is in the surround decode mode (see page 72). You can select the desired extended surround mode for each decoder by setting “EXTD” (see page 74).

Tone bypass TONE BYPASS

Use this feature to select whether the audio output bypasses the tone control circuitry when “TREBLE” and “BASS” are set to 0 dB (see page 52).

Choice	Functions
AUTO	Automatically bypasses the tone control circuitry to provide the purest signal possible when “TREBLE” and “BASS” are set to 0 dB.
OFF	Does not bypass the tone control circuitry.

HDMI set F>HDMI SET

Use this feature to select the component to play back HDMI audio signals.

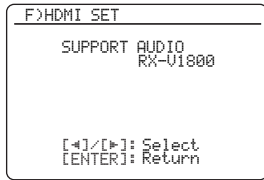

Support audio SUPPORT AUDIO

Use this feature to select whether to play back HDMI audio signals on this unit or on another HDMI component connected to the HDMI OUT jack on the rear panel of this unit.

Choice	Functions
RX-V1800	Plays back HDMI audio signals on this unit. The HDMI audio signals input at the HDMI input jacks of this unit are not output to the HDMI component connected to the HDMI OUT jack on the rear panel of this unit.
OTHER	Plays back HDMI audio signals on another HDMI component connected to the HDMI OUT jack.

Notes

- This unit transmits audio and video signals input at the HDMI input jacks to the HDMI out jack only when this unit is turned on even if “SUPPORT AUDIO” is set to “OTHER”.
- Available audio/video signals depend on the specification of the connected video monitor. Refer to the instruction manual of each connected component.

4 INPUT MENU

Use this menu to adjust the parameters of each input source.

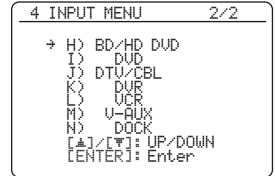
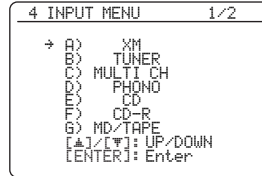

Input source	Parameter
A)XM (U.S.A. and Canada models only)	INPUT RENAME VOL. TRIM ANTENNA LEVEL
B)TUNER	INPUT RENAME VOL. TRIM
C)MULTI CH	INPUT RENAME VOL. TRIM BGV INPUT CH FRONT
D)PHONO	I/O ASSIGNMENT
E)CD	INPUT RENAME
F)CD-R	VOL. TRIM
G)MD/TAPE	DECODER MODE
H)BD/HD DVD	
I)DVD	
J)DTV/CBL	
K)DVR	
L)VCR	
M)V-AUX	
N)DOCK	INPUT RENAME VOL. TRIM STANDBY CHARGE

Note

Some parameters described above may not be available for all input sources and some parameters are only available for specific input sources.

Input/output assignment

I/O ASSIGNMENT

Use this feature to assign the input/output jacks according to the component to be used if the initial settings of this unit do not correspond to your needs. Change the parameter to reassign the respective jacks and effectively connect more components.

Once the input/output jacks are reassigned, you can select the corresponding component by using the **INPUT** selector on the front panel (or the input selector buttons on the remote control).

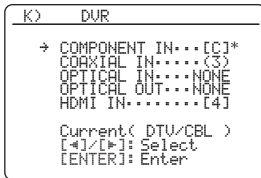

- “NONE” appears in the OSD when any input source is not assigned to the input/output jack.
- You cannot select a specific item more than once for the same type of jack.
- An asterisk (*) appears to the right of the input/output jack names that have been changed from their previous settings.
- The currently assigned input source for the selected input/output jack appears in the OSD (“Current(DTV/CBL)” in the display example above).

Input rename INPUT RENAME

Use this feature to change the name of the input source that appears in the OSD and in the front panel display.

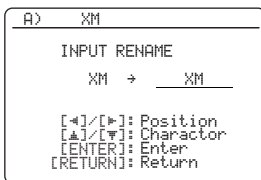

You can also change the name of the input source that appears in the display window (11) on the remote control. Refer to “Changing source names in the display window” on page 105.

- 1 Press **3** </> to place the “_” (underscore) under the space or the character you want to edit.

- 2 Press **3** Δ / ▽ to select the character you want to use and then press **3** </> to move to the next space.

Notes

- You can use up to 9 characters for each input.
- Press **3** ▽ to change the character in the following order, or press **3** Δ to go in the reverse order: A to Z, 0 to 9, a to z, symbols (#, *, -, +, etc.), space.

- 3 Repeat steps 1 through 2 to rename each input source.

- 4 Press **3** ENTER to complete.

Volume trim VOL. TRIM

Use this feature to adjust the level of the signal input at each jack. This feature is useful if you want to balance the level of each input source to avoid sudden changes in volume when switching between input sources.

Control range: -6.0 dB to +6.0 dB

Control step: 0.5 dB

Initial setting: 0.0 dB

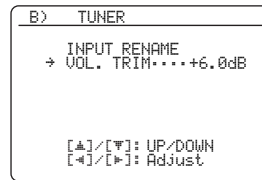

This parameter also affects the signals output at the audio ZONE OUT jacks.

Decoder mode DECODER MODE

Use this feature to switch the decoder activation mode.

You can designate the reassigned digital input jacks for DTS signals.

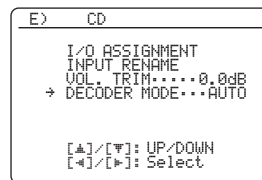

Choice	Functions
AUTO	Automatically detects digital audio signal input types and selects the appropriate decoder.
DTS	Activates the DTS decoder when digital audio signals are input.

XM Radio antenna ANTENNA LEVEL (U.S.A. and Canada models only)

Use this feature to check the current reception level of the XM Satellite Radio signals (see page 58). For the best reception, adjust the orientation of the antenna of connected Home Dock so that a value of 60% or more is displayed here.

Display status: NONE, 0 to 100%

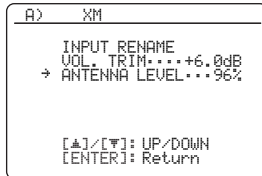

Note

“NONE” is displayed if the Home Dock is not connected to this unit. In this case, check the antenna connections (see page 58).

Charge on standby STANDBY CHARGE

Use this feature to select whether this unit charges the battery of the stationed iPod or not when this unit is in the standby mode (see page 64).

Choice	Functions
AUTO	Charges the battery of the stationed iPod when this unit is turned on and in the standby mode.
OFF	Charges the battery of the stationed iPod only when this unit is turned on.

Multi-channel input BGV BGV

Use this feature to select the video source played in the background of the sources input at the MULTI CH INPUT jacks.

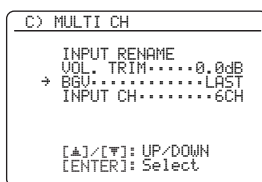

Choice	Functions
LAST	Automatically selects the last selected video source as the background video source.
BD/HD DVD, DTV/CBL, DVD, DVR, VCR, V-AUX	Selects the corresponding input source as the background video source.
OFF	Does not play the video source in the background.

Input channels INPUT CH

Use this setting to select the number of channels input from an external decoder (see page 30).

Choices: 6CH, 8CH

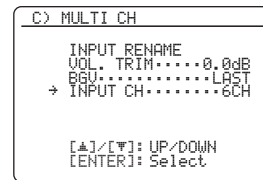

If the connected component outputs discrete 6-channel audio signals.

Select “6CH”.

If the connected component outputs discrete 8-channel audio signals.

Select “8CH”. Also set “FRONT” (see below) to the analog audio jacks at which the front left and right channel signals output from the connected component are input.

Note

If “AMP” is set to “[SP1]”, “[SP2]” or “BOTH” (see page 94), no sound is output from the surround back speakers even if you select “8CH”. In this case, select “6CH” and set the output setting of the external component to 6 channels.

Front left and right channels input jack FRONT

If you selected “8CH” in “INPUT CH”, you can select the analog audio jacks at which the front left and right channel signals output from the connected external decoder is input.

Choices: CD, CD-R, MD/TAPE, **BD/HD DVD**, DVD, DTV/CBL, VCR, DVR, V-AUX

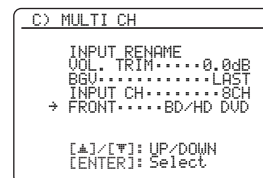

Note

“FRONT” parameter appears only when you set “INPUT CH” to “8CH”.

5 OPTION MENU

Use this menu to adjust the optional system parameters.

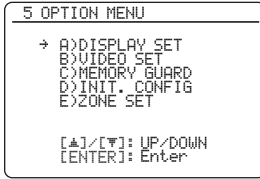

■ Display settings A) DISPLAY SET

Note

Use “VIDEO” of “INITIALIZE” in “ADVANCED SETUP” to set “OSD SHIFT” and “GRAY BACK” to the factory presets (see page 120).

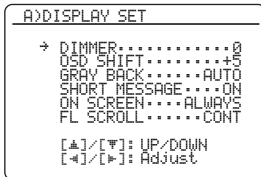

Dimmer DIMMER

Use this feature to adjust the brightness of the front panel display.

Control range: -4 to 0

Control step: 1

- Press **3**◀ to make the front panel display dimmer.
- Press **3**▶ to make the front panel display brighter.

OSD shift OSD SHIFT

Use this feature to adjust the vertical position of the OSD.

Control range: -5 (downward) to +5 (upward)

Control step: 1

Initial setting: 0

- Press **3**◀ to lower the position of the OSD.
- Press **3**▶ to raise the position of the OSD.

Gray back GRAY BACK

Use this feature to display a gray background in your video monitor when there is no video signal being input.

Choice	Functions
AUTO	Displays a gray background on your video monitor when there is no video signal being input.
OFF	Does not display a gray background on your video monitor.

Notes

- Depending on the video signals being input or the system setting of your video monitor (NTSC or PAL), the OSD may be displayed abnormally. In such cases, set “GRAY BACK” to “OFF”.
- Even when “GRAY BACK” is set to “OFF”, the OSD may not be displayed correctly depending on the conditions of the picture.

Short message display

SHORT MESSAGE

Use this feature to activate or deactivate the short message display function.

Choice	Functions
ON	Activates the short message display function. The contents of the front panel display appear at the bottom of the screen each time you operate this unit.
OFF	Deactivates the short message display function.

Note

- The short message display does not appear in the following cases:
- when the component video signals with 480p/576p, 720p, 1080i or 1080p resolutions are input
 - When HDMI video signals are input

On-screen display time ON SCREEN

Use this feature to set the time for which the XM Satellite Radio information or iPod menu is displayed in the OSD after you perform a certain operation.

Choice	Functions
ALWAYS	Displays the OSD unceasingly during an operation.
10S	Turns off the OSD 10 seconds after you perform a certain operation.
30S	Turns off the OSD 30 seconds after you perform a certain operation.

Front panel display scroll FL SCROLL

Use this feature to set the mode to display the XM Satellite Radio information or iPod menu (such as song title or channel name) in the front panel display.

Choice	Functions
CONT	Continuous mode. Select this to display the operation status in the front panel display in a continuous manner.
ONCE	Scroll-once mode. Select this to display the operation status in the front panel display by the first 14 alphanumeric characters after scrolling all characters once.

Video settings B>VIDEO SET

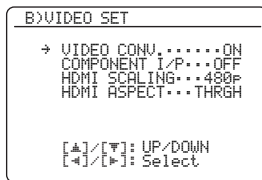

Video conversion VIDEO CONV.

Use this feature to set whether to convert the video signals input at the VIDEO, S VIDEO, and COMPONENT VIDEO jacks.

Choice	Functions
ON	Converts composite, S-video, and component video signals interchangeably and up-converts composite, S-video, and component video signals to HDMI video signals.
OFF	Does not convert any signals.

Notes

- This unit does not convert 480 line video signals and 576 line video signals interchangeably.
- The analog component video signals with 480i (NTSC)/576i (PAL) of resolution are converted into the S-video or composite video signals and output at the S VIDEO MONITOR OUT and VIDEO MONITOR OUT jacks.
- The converted video signals are only output at the MONITOR OUT jacks. When recording a video source, you must make the same type of video connections between each component.
- When composite video or S-video signals from a VCR are converted into component video signals, the picture quality may suffer depending on your VCR.
- Set “VIDEO CONV.” to “ON” to display the sound field parameter display and short message display.
- Unconventional signals input at the composite video or S-video jacks cannot be converted or may be output abnormally. In such cases, set “VIDEO CONV.” to “OFF”.

Component interlace/progressive up-conversion COMPONENT I/P

Use this feature to activate or deactivate the analog interlace/progressive conversion of the analog video signals input at the composite video, S-video and component video jacks so that the analog video signals deinterlaced from 480i (NTSC)/576i (PAL) to 480p/576p are output at the COMPONENT MONITOR OUT jacks.

Choice	Functions
ON	Activates the analog interlace/progressive up-conversion of the analog video signals.
OFF	Deactivates the analog interlace/progressive up-conversion of the analog video signals.

Notes

- The “COMPONENT I/P” parameter appears only when you set “VIDEO CONV.” to “ON”.
- If your video monitor does not support analog video signals with 480p/576p of resolution, the SET MENU items may not be displayed on your video monitor when “COMPONENT I/P” is set to “ON”. In such a case, set the “COMPONENT I/P” parameter to “OFF”.

HDMI scaling HDMI SCALING

Use this feature to activate or deactivate the HDMI up-scaling of the analog video signals input at the VIDEO, S VIDEO and COMPONENT VIDEO jacks so that the up-scaled video signals are output at the HDMI OUT jack. This unit up-scales the video signals as follows:

- 480i (NTSC)/576i (PAL) → 480p/576p, 1080i, 720p, or 1080p
- 480p/576p → 1080i, 720p, or 1080p

Choice	Functions
THROUGH	Does not up-scale any analog video signals.
480p (or 576p), 1080i, 720p, 1080p	Up-scales analog video signals to 480p or 576p, 1080i, 720p, or 1080p of resolution.

Note

This unit does not up-scale the analog component video signals with 720p or 1080i of resolution.

Notes

- The “HDMI SCALING” parameter appears only when you set “VIDEO CONV.” to “ON”.
- If you connect your video monitor via HDMI connection, this unit automatically detects the available video signal resolution of the video monitor, and an asterisk (*) appears on the left of the available video signal resolution(s).
- If this unit cannot detect the available video signal resolution(s) of the connected video monitor, set “MONITOR CHECK” (see page 120) to “SKIP” and then set “HDMI SCALING” again.
- This unit does not convert between 480 line video signals and 576 line video signals.

HDMI aspect ratio HDMI ASPECT

Use this feature to select the adjustment of aspect ratio for analog video signals output at the HDMI OUT jack.

Choice	Functions
THROUGH	Does not make any adjustments to the aspect ratio for the HDMI video signal sources.
16:9	Displays video images with the aspect ratio of 4:3 on your video monitor with the aspect ratio of 16:9. Black stripes appear on the right and left sides as a result.
SMART	Fits video images with the aspect ratio of 4:3 to your video monitor with the aspect ratio of 16:9.

Notes

- When “HDMI SCALING” is set to “THROUGH”, you cannot make any adjustments to “HDMI ASPECT”.
- If the aspect ratio of the input video source is other than 4:3, this unit automatically ignores the setting of “HDMI ASPECT”.
- When “HDMI ASPECT” is set to “SMART”, the video images of the edge of the video monitor are rather stretched.
- When the video signals are input at HDMI IN jacks or the signals are input with 720p, 1080i or 1080p of resolution, the setting of “HDMI ASPECT” does not affect the video signals output at the HDMI OUT jack.

Memory guard C>MEMORY GUARD

Use this feature to prevent accidental changes to sound field program parameter and other system settings.

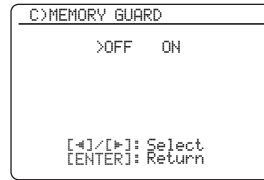

Choice	Functions
OFF	Turns off the “MEMORY GUARD” feature.
ON	Protects: <ul style="list-style-type: none"> – sound field program parameters – “AUTO SETUP” items – “SYSTEM MEMORY” (“SAVE” only) – all speaker levels – “MANUAL SETUP” items

Notes

- You can change the following parameters even if “MEMORY GUARD” is set to “ON”:
 - “AUDIO SET” parameters (see page 87)
 - “DECODER MODE” (see page 89)
 - “MEMORY GUARD”
- When “MEMORY GUARD” is set to “ON”, “” appears at the top right of the “SET MENU” screen.
- You can change the settings of “SUR.” and “EXTD” in the sound field program or decoder parameter menu even if “MEMORY GUARD” is set to “ON” (see pages 73 and 74).

■ **Initial configuration** D>INIT. CONFIG

Use this feature to select the settings of the audio input jack select, active decoders and extended surround when you turn on this unit.

```
D>INIT. CONFIG
→ AUDIO SELECT..AUTO
  DECODER MODE..AUTO
  EXTD SUR.....AUTO

[←]/[→]: Select
[ENTER]: Return
```

Audio select AUDIO SELECT

Use this feature to designate the default audio input jack select setting (see page 43) for the input sources connected to the DIGITAL INPUT jacks when you turn on the power of this unit.

Choice	Functions
AUTO	Automatically detects the type of input signals and selects the appropriate audio input jack select setting.
LAST	Automatically selects the last input jack select setting used for the connected input source.

Decoder mode DECODER MODE

Use this feature to designate the default decoder mode (see page 89) for the input sources connected to the DIGITAL INPUT jacks when you turn on the power of this unit.

Choice	Functions
AUTO	Automatically detects the type of input signals and select the appropriate decoder mode setting.
LAST	Automatically selects the last decoder mode setting used for the connected input source.

Extended surround EXTD SUR.

Use this feature to designate the extended decoder mode (see page 87) for the input sources connected to the DIGITAL INPUT jacks when you turn on the power of this unit.

Choice	Functions
AUTO	Automatically detects the digital audio input signals and activates the appropriate decoder.
LAST	Automatically selects the last decoder mode set for "EXTD SUR." in "SOUND MENU".

■ **Zone set** E>ZONE SET

Use this feature to set the items related in Zone 2 or Zone 3.

```
E>ZONE SET
→ >ZONE2 ZONE3
AMP.....EXT
VOLUME.....UAR
MAX VOL...-30.0dB
INIT. VOL..+16.5dB

[▲]/[▼]: UP/DOWN
[←]/[→]: Select
```

Setting zone

Select the zone to set up "AMP", "VOLUME", "MAX VOL." and "INIT. VOL.".

Choice	Functions
ZONE 2	Sets the "ZONE SET" parameters for Zone 2.
ZONE 3	Sets the "ZONE SET" parameters for Zone 3.

Zone 2/Zone 3 amplifier AMP

Use this feature to select how the Zone 2 or Zone 3 speakers are amplified. This parameter also effects the speaker settings and the sound output of sound field programs in the main zone.

Choices: **EXT**, [SP1], [SP2], BOTH

When the speakers in Zone 2 or Zone 3 are connected to the external amplifier, and the external amplifier is connected to the ZONE OUT (ZONE 2 or ZONE 3) jacks of this unit:

Select "EXT". See "Using external amplifiers" on page 111 for details.

Note

When "BI-AMP" is set to "ON" in "ADVANCED SETUP" (see page 120), you can only set "AMP" to "EXT" in "ZONE 2" or "ZONE 3".

When the speakers in Zone 2 or Zone 3 is connected to the SP1 speaker terminals of this unit directly:

Select "[SP1]". See "Using the internal amplifiers of this unit" on page 112 for details.

Note

When you set "AMP" to "[SP1]" in "ZONE 2" or "ZONE 3" and the corresponding zone is turned on, no sound is output from the surround back speakers.

When the speakers in Zone 2 or Zone 3 is connected to the SP2 speaker terminals of this unit directly:

Select “[SP2]”. See “Using the internal amplifiers of this unit” on page 112 for details.

Note

When you set “AMP” to “[SP2]” in “ZONE 2” or “ZONE 3” and the corresponding zone is turned on, no sound is output from the surround speakers.

If the speakers in Zone 2 or Zone 3 are connected to both the SP1 and SP2 speaker terminals (for example, the speakers are connected via the bi-amplifier connection, or there are four speakers in a room) or if you want to play back the same source in Zone 2 and Zone 3 simultaneously:

Select “BOTH”. See “Using the internal amplifiers of this unit” on page 112 for details.

Notes

- When you set “AMP” to “BOTH” in “ZONE 2” or “ZONE 3”, you can only set “AMP” to “EXT” in the other zone setting.
- When you set “AMP” to “BOTH” in “ZONE 2” or “ZONE 3” and the corresponding zone is turned on, no sound is output from both the surround and surround back speakers.

Zone 2/Zone 3 volume VOLUME

Use this feature to select whether this unit controls the volume level of the audio signals output at the ZONE OUT (ZONE 2 or ZONE 3) jacks when you set “AMP” to “EXT” (see page 94).

Choices: **VAR**, **FIX**

When you want to control the volume level of the selected zone on this unit:

Select “VAR”. You can adjust the ZONE OUT (ZONE 2 or ZONE 3) volume level simultaneously with **ⓂVOLUME +/-** on the remote control.

When you want to control the volume level of the selected zone on the external amplifier:

Select “FIX”. This unit fixes the ZONE OUT (ZONE 2 or ZONE 3) volume level to a standard line level.

Zone 2/Zone 3 maximum volume MAX VOL.

Use this feature to set the maximum volume level in the Zone 2 or Zone 3.

Control range: -30.0 dB to +15.0 dB, **+16.5dB**

Control step: 5.0 dB

Note

The “MAX VOL.” setting takes priority over the “INIT. VOL.” setting. For example, “INIT. VOL.” is set to -20.0 dB and then “MAX VOL.” is set to -30.0 dB, the volume level is automatically set to -30.0 dB when you turn on the power of this unit next time.

Zone 2/Zone 3 initial volume INIT. VOL.

Use this feature to set the volume level of Zone 2 or Zone 3 when the power of Zone 2 or Zone 3 is turned on.

Choices: **OFF**, **MUTE**, -80.0 dB to +16.5 dB

Control step: 0.5 dB

Note

The “MAX VOL.” setting takes priority over the “INIT. VOL.” setting.

Saving and recalling the system settings (SYSTEM MEMORY)

Use this feature to save up to six of your favorite settings that can be easily recalled when needed. You can save the following system setting parameters:

Saved parameters	Page
“BASIC MENU” parameters (except “TEST TONE”)	80
“VOLUME MENU” parameters (except “INIT. VOL.”)	84
“SOUND MENU” parameters* (except “EXTD SUR.”)	85
“DISPLAY SET” parameters (except “SHORT MESSAGE”)	91
“VIDEO SET” parameters	92
Currently selected sound field program (or the Pure Direct mode)	46
Sound field parameter settings	67
Tonal quality control settings*	52

* The settings of “DYNAMIC RANGE”, “LFE LEVEL”, and the tonal quality control for headphones are not saved.

Saving the current system settings

Before performing the following operations, set the operation mode selector on the remote control to **AMP**.

■ Saving by the **SYSTEM MEMORY** buttons

You can save the system settings stored in “MEMORY1” to “MEMORY4” by pressing the corresponding **SYSTEM MEMORY** buttons.

Press and hold one of the **SYSTEM MEMORY buttons on the remote control for 4 seconds.**

“MEMORY 1 SAVE Done” (example) appears in the front panel display, and then this unit saves the current system setting to the corresponding memory number.

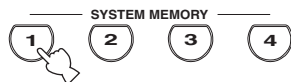

Note

System settings are already saved in the selected memory number, this unit overwrites the old system settings.

■ Saving by the SET MENU operation

You can save the system settings stored in “MEMORY1” to “MEMORY6” by using the “SYSTEM MEMORY” menu in “SET MENU”.

1 Press **SET MENU** on the remote control.

The top “SET MENU” display appears in the OSD.

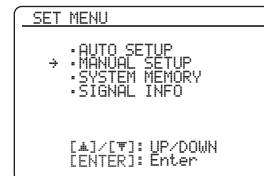

2 Press **DOWN** to select “SYSTEM MEMORY” and then press **ENTER**.

The “SYSTEM MEMORY” menu appears in the OSD.

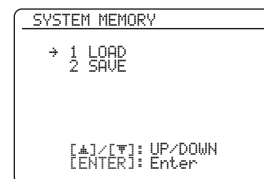

3 Press **DOWN** to select “SAVE” and then press **ENTER**.

The following menu appears in the OSD.

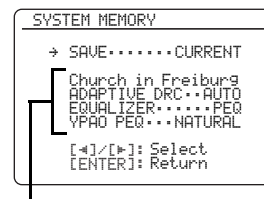

Current system parameters

- Press **3** </> repeatedly to select the desired memory number (“MEMORY1” to “MEMORY6”).

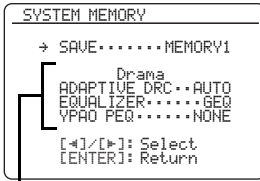

Stored system parameters in the selected memory number



- System settings are already stored in the selected memory number, the stored system parameter settings appear in the menu screen. “EMPTY” appears in the menu screen if no system settings are stored in the selected memory number.
- System settings are already saved in the selected memory number, this unit overwrite the old system settings.
- If you save the system settings to “MEMORY1” to “MEMORY4”, you can load the stored settings by pressing the corresponding **SYSTEM MEMORY** buttons (see page 97).

- Press **3** **ENTER** to save the current system settings to the selected memory number.

- Press **16** **SET MENU** again to exit from “SET MENU”.

Loading the stored system settings

- Before performing the following operations, set the operation mode selector on the remote control to **AMP**.
- This unit overwrites the stored settings to the current settings of this unit. If you do not want to erase the current settings, save the current settings to any SYSTEM MEMORY number in advance.

Loading by the **SYSTEM MEMORY** buttons

You can recall the system settings stored in “MEMORY1” to “MEMORY4” by pressing the corresponding **SYSTEM MEMORY** buttons.

- Press one of the **SYSTEM MEMORY** buttons on the remote control to select the desired memory number.

“MEMORY 1 LOAD” (example) appears in the front panel display.

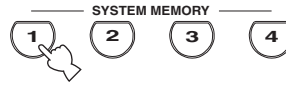

“EMPTY” appears in the menu screen if no system settings are stored in the selected memory number.

- Press the selected **SYSTEM MEMORY** button once more to confirm the selection.

This unit loads the settings stored in the selected memory number.

Loading by the SET MENU operation

- Press **16** **SET MENU** on the remote control.

The top “SET MENU” display appears in the OSD.

- Press **3** **∇** to select “SYSTEM MEMORY” and then press **3** **ENTER**.

The “SYSTEM MEMORY” menu appears in the OSD.

- Press **3** **ENTER** to select “LOAD”.

The following menu appears in the OSD.

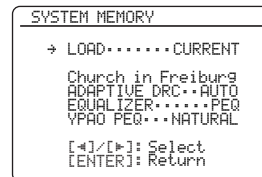

- Press **3** </> repeatedly to select the desired memory number where the system settings are stored and then press **3** **ENTER**.

This unit loads the selected system settings.

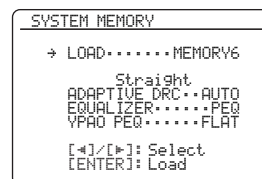

- Press **16** **SET MENU** to exit from “SET MENU”.

Using examples

■ Example 1: Comparing the results of the automatic setup and manual setup

This unit is equipped with three types of parametric equalizer settings (see page 40), and you can also make your customized configuration of the sound settings of this unit by using the “MANUAL SETUP” parameters (see page 75). To compare the results of the automatic setup or your manual configuration, use the **SYSTEM MEMORY** buttons.

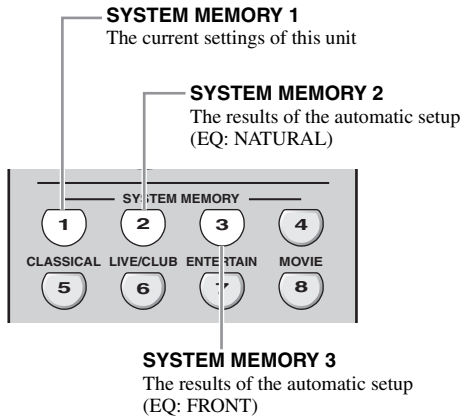

Saving each setting

Note

Carry out the following procedure when all the parameters are set to default value.

1 Press and hold **SYSTEM MEMORY 1** for 4 seconds.

This unit stores the current settings of this unit to “MEMORY1”.

2 Perform the automatic setup.

Set “EQ” to “NATURAL”. See page 40 for details.

3 Press and hold **SYSTEM MEMORY 2** for 4 seconds.

This unit stores the results of the automatic setup performed in step 2 to “MEMORY2”.

4 Perform the automatic setup again.

This time, set “EQ” to “FRONT”.

5 Press and hold **SYSTEM MEMORY 3** for 4 seconds.

This unit stores the result of the automatic setup performed in step 4 to “MEMORY3”.

■ Example 2: Switching the settings for different room environments

The tonal characteristics of the listening room may vary depending on the situations of the room (for example, whether the curtains are open or closed), and the settings of this unit should be arranged for each situation of the room. You can switch between the settings of this unit easily by using **SYSTEM MEMORY** buttons.

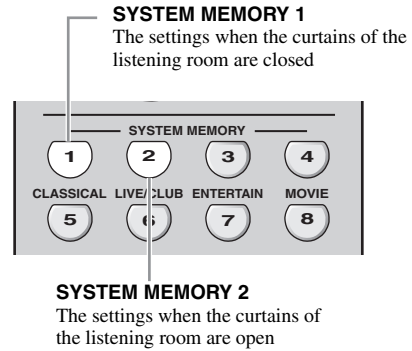

Saving each setting

1 Close the curtains of the listening room and then perform the automatic setup.

See page 37 for details of the automatic setup.

2 Press and hold **SYSTEM MEMORY 1** for 4 seconds.

This unit stores the settings for the current room situation (i.e. the curtains are closed) to “MEMORY1”.

3 Open the curtains of the listening room and then perform the automatic setup.

4 Press and hold **SYSTEM MEMORY 2** for 4 seconds.

This unit stores the current room situation (i.e. the curtains are open) to “MEMORY2”.

■ Example 3: Saving the sound configurations for specific sources

The desired sound configurations are different for each input source. For example, if you use the sound field program “Village Vanguard” for a music source of a live jazz performance, the parameter settings may differ when the input source is a vinyl record or an SACD. You can store the sound settings for each input source.

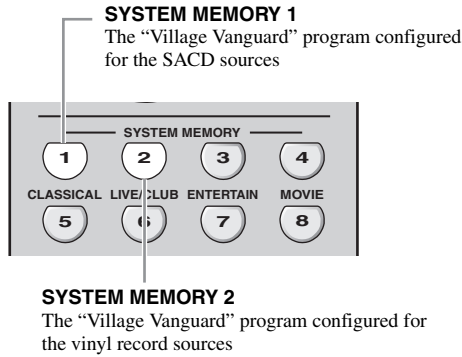

Saving each setting



See page 67 for the sound field program parameter settings.

- 1 Start playback of the desired live jazz performance recorded on the SACD.**
- 2 Set the sound field program to “Village Vanguard” and then adjust the parameters for the current playback sources.**
- 3 Press and hold **ⓂSYSTEM MEMORY 1** for 4 seconds.**
This unit stores the current sound field program settings to “MEMORY1”.
- 4 Change the input source to “PHONO” and then start playback of the desired live jazz performance recorded on the vinyl record.**
- 5 Adjust the sound field program parameters for the current playback source.**
- 6 Press and hold **ⓂSYSTEM MEMORY 2** for 4 seconds.**
This unit stores the current sound field program settings to “MEMORY2”.

■ Example 4: Switching multiple audio and video synchronization settings

If you use two different kinds video monitors or projectors, and these components are not compatible with the automatic audio and video synchronization feature, you should set “MANUAL DELAY” for each component. You can switch between the different “MANUAL DELAY” settings by using the **ⓂSYSTEM MEMORY** buttons.

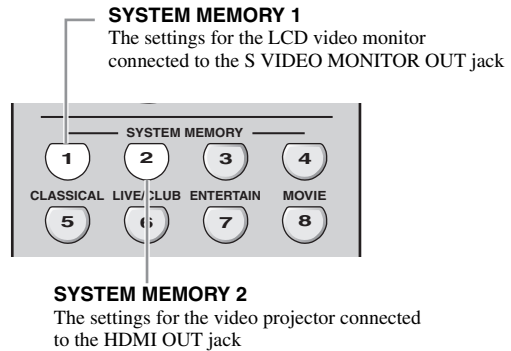

Saving each setting

Note

In the following example, the LCD video monitor and one input component (for example, VCR) are connected to the S VIDEO input jack and S VIDEO MONITOR OUT jack, and the video projector and the other input component (for example, DVD player) are connected to one of the HDMI IN jacks and HDMI OUT jack.

- 1 Start playback of the desired video source on the connected LCD video monitor and then adjust “MANUAL DELAY” in “SOUND MENU” appropriately (see page 87).**
- 2 Press and hold **ⓂSYSTEM MEMORY 1** for 4 seconds.**
This unit stores the audio and video synchronization settings for the LCD video monitor to “MEMORY 1”.
- 3 Change the input source to the component connected to one of the HDMI IN jacks and then start playback.**
- 4 Adjust “MANUAL DELAY” in “SOUND MENU” appropriately.**
- 5 Press and hold **ⓂSYSTEM MEMORY 2** for 4 seconds.**
This unit stores the audio and video synchronization settings for the video projector to “MEMORY 2”.

Remote control features

In addition to controlling this unit, the remote control can also operate other audiovisual components made by Yamaha and other manufacturers. To control your TV or other components, you must set up the appropriate remote control code for each input source (see page 102).

Controlling this unit, a TV, or other components

■ Controlling this unit

Set the operation mode selector to **AMP** to control this unit.

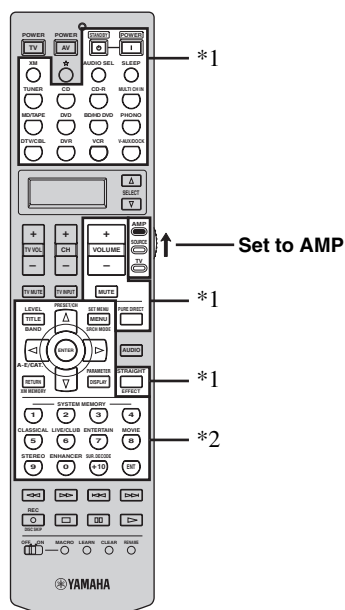

■ Controlling a TV

Set the operation mode selector to **TV** to control your TV. To control your TV, you must set the appropriate remote control code for DTV/CBL or PHONO in advance (see page 102). When you set the remote control codes for both DTV and PHONO, priority is given to the one set for DTV.

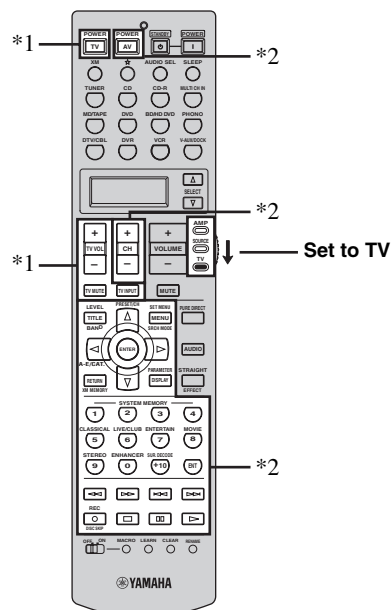

Notes

- *1 These buttons always control this unit regardless of the operation mode selector position.
- *2 These buttons control this unit only when the component operation mode selector is set to **AMP**.

Notes

- *1 These buttons always control your TV regardless of the operation mode selector position.

Remote control	Digital TV/Cable TV
TV POWER	Turns on or off the power.
TV VOL +/-	Increases or decreases the volume level.
TV MUTE	Mutes the audio output.
TV INPUT	Changes the input source.

- *2 These buttons control your TV only when the operation mode selector is set to **TV**. For details, see the “TV” column on page 101.

■ Controlling other components

Set the operation mode selector to **⑩SOURCE** to control other components selected with the input selector buttons (①) or ☆. You must set the appropriate remote control code for each input source in advance (see page 102). The following table shows the function of each control button used to control other components assigned to each input selector button (①) or ☆. Be advised that some buttons may not correctly operate the selected component.



The remote control has 14 modes (input areas) to control components so that the remote control can operate up to 14 different components.

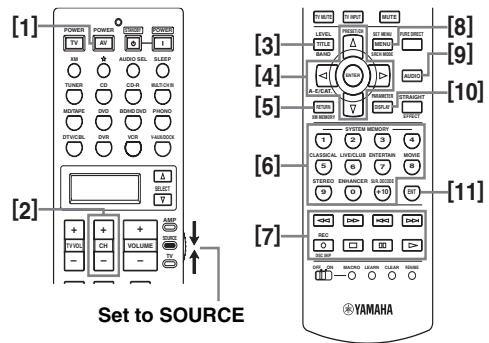

	Blu-ray Disc/ HD DVD player/ recorder	DVD player/ DVD recorder	VCR	Cable TV/ Satellite tuner	TV	LD player	CD player	MD recorder/ CD recorder	Tape deck	Tuner
[1] AV POWER	Power *1	Power *1	Power *1	Power *1	DVR power *2	Power *1	Power *1	Power *1	Power *1	Power *1
[2] CH +	TV channel up*3	TV channel up*3	Channel up	Channel up	Channel up	TV channel up*3	TV channel up*3	TV channel up*3	TV channel up*3	TV channel up*3
CH -	TV channel down*3	TV channel down*3	Channel down	Channel down	Channel down	TV channel down*3	TV channel down*3	TV channel down*3	TV channel down*3	TV channel down*3
[3] TITLE	Title	Title	Title	Title	Title					Band
[4] ENTER	Menu enter	Menu enter		Menu select	Menu select					
PRESET/CH ▲	Menu up	Menu up		Menu up	Menu up					Preset up (1 to 8)
PRESET/CH ▼	Menu down	Menu down		Menu down	Menu down					Preset down (1 to 8)
A-E/CAT. ◀	Menu left	Menu left		Menu left	Menu left					Preset down (A to E)
A-E/CAT. ▶	Menu right	Menu right		Menu right	Menu right				Direction A/B	Preset up (A to E)
[5] RETURN	Return	Return	Return	Return	Return					
[6] 1-9, 0, +10	Numeric buttons	Numeric buttons	Numeric buttons	Numeric buttons	Numeric buttons	Numeric buttons	Numeric buttons	Numeric buttons		
[7] ◀◀	Search backward	Search backward	Search backward	DVR search backward *2	DVR search backward *2	Search backward	Search backward	Search backward	Search backward	Search backward
▶▶	Search forward	Search forward	Search forward	DVR search forward *2	DVR search forward *2	Search forward	Search forward	Search forward	Search forward	Search forward
◀◀	Skip backward	Skip backward				Chapter/Skip backward	Skip backward	Skip backward	Direction back	
▶▶	Skip forward	Skip forward				Chapter/Skip forward	Skip forward	Skip forward	Direction forward	
REC/ DISC SKIP	Rec (recorder)	Disc skip (player) Rec (recorder)	Rec	DVR rec *2	DVR rec *2		Disc skip	Rec	Rec	
□	Stop	Stop	Stop	DVR stop *2	DVR stop *2	Stop	Stop	Stop	Stop	
⏸	Pause	Pause	Pause	DVR pause *2	DVR pause *2	Pause	Pause	Pause	Pause	
▶	Play	Play	Play	DVR play *2	DVR play *2	Play	Play	Play	Play	
[8] MENU	Menu	Menu		Menu	Menu					
[9] AUDIO	Audio	Audio				Audio				
[10] DISPLAY	Display	Display		Display	Display	Display	Display	Display		
[11] ENT			Enter	Enter/recall	Enter					

Notes

*1 This button is operational only when the original remote control supplied with the component has a power button.

*2 These buttons operate your video recorder (DVD recorder, etc.) only when you set the appropriate remote control code for DVR (see page 102).

*3 These buttons control your TV only when the operation mode selector is set to TV. For details, see the "TV" column.

■ Selecting a component to be controlled

You can select a component to be controlled independently of the input source selected with the input selector buttons (①).

Press **①** **SELECT** Δ / ∇ repeatedly to select the desired component.

The name of the component to be controlled appears in the display window (②) on the remote control.



■ Controlling optional components (Option mode)

“OPTN” is an optional component control area that can be programmed with remote control functions independently from any input source. This area is useful for programming commands that are to be used only as a part of a macro function or for components that do not have a valid remote control code.

To select the option mode, press **①** **SELECT** ∇ repeatedly until “OPTN” appears in the display window on the remote control.



Note

You cannot set a remote control code for the optional area. See page 104 to program buttons operated within this component control area.

Setting remote control codes

You can control other components by setting the appropriate remote control codes. Codes can be set up for each input area. For a complete list of available remote control codes, refer to “List of remote control codes” at the end of this manual.

The following table shows the default component (Library: component category) and the remote control code for each input area.

Remote control code default settings

Input area	Library (component category)	Manufacturer	Default code
XM	TUNER	Yamaha	2604
☆	TUNER	Yamaha	2607
TUNER	TUNER	Yamaha	2602
CD	CD	Yamaha	2300
CD-R	CD-R	Yamaha	2400
MULTI CH IN	DVD	Yamaha	2100
MD/TAPE	MD	Yamaha	2500
DVD	DVD	Yamaha	2100
BD/HD DVD	DVD	Yamaha	2100
PHONO	TV	—	—
DTV/CBL	TV	—	—
DVR	DVR	Yamaha	2807
VCR	VCR	—	—
V-AUX/DOCK	TUNER	Yamaha	2606

Note

You may not be able to operate your Yamaha component even if a Yamaha remote control code is preset as listed above. In this case, try setting another Yamaha remote control code.

- 1 Set the operation mode selector to ⑬ SOURCE and then press an input selector button (①) or ☆ to select the input area you want to set up.**

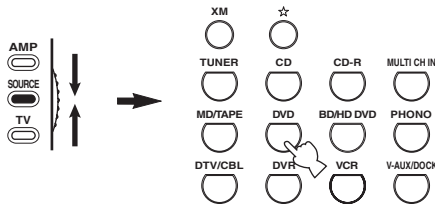

- 2 Press and hold ⑫ LEARN for about 3 seconds using a ballpoint pen or similar object.**

The library name (e.g. L;DVD) and the name of the selected input area (e.g. DVD) appear alternately in the display window (⑪) on the remote control.



- You can set a remote control code of a different type of component to an input area. Press ⑬◀/▶ repeatedly to change the library (component category).
Library choices: L;DVD, L;DVR, L;LD, L;CD, L;CDR, L;MD, L;TAP (tape), L;TUN (tuner), L;AMP, L;TV, L;CAB (cable), L;SAT (satellite), L;VCR
- If you want to setup for another input area, press the input selector button (①) or ☆, or press ⑩SELECT ▲/▼ repeatedly to select the input area.

Notes

- Be sure to press and hold ⑫LEARN for at least 3 seconds, otherwise the learning process will start.
- If you do not complete each of the following steps within 30 seconds, the setting mode will be automatically canceled. In this case, start over from step 2.

- 3 Press ③ENTER.**

The four-digit code set for the selected component appears in the display window (⑪).

Note

“0000” appears in the display window (⑪) if no code has been set.

- 4 Press the numeric buttons (⑤) to enter the four-digit remote control code for the component you want to use.**

For a complete list of available remote control codes, refer to “List of remote control codes” at the end of this manual.

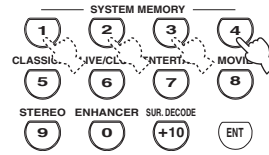

- 5 Press ③ENTER to set the number.**

“OK” appears in the display window (⑪) on the remote control if setting is successful.

“NG” appears in the display window (⑪) on the remote control if the setting is unsuccessful. In this case, start over from step 3.



If you continuously want to set up another code for another component, press the input selector button (①) or ☆, or ⑩SELECT ▲/▼ repeatedly to select the component, then repeat steps 2 through 5.

- 6 Press ⑫LEARN again to exit from the setup mode.**



- 7 Press ⑥▶ (play) or AV POWER to confirm whether you can control your component using the remote control.**

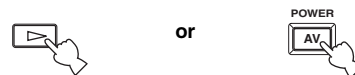

If operation is not possible and the manufacturer of your component has more than one code, try each of them until you find the correct one.

Notes

- “ERROR” appears in the display window (⑪) on the remote control if you press a button not indicated in the respective step, or when you press more than one button simultaneously.
- The supplied remote control does not contain all possible codes for commercially available audio and video components (including Yamaha components). If operation is not possible with any of the remote control codes, program the new remote control function using the learn feature (see “Programming codes from other remote controls” on page 104) or use the remote control supplied with the component.
- Functions programmed using the learn feature take priority over remote control code functions.

Programming codes from other remote controls

You can program remote control codes from other remote controls. Use the learn feature if you want to program functions not included in the basic operations covered by the remote control codes, or an appropriate remote control code is not available. You can program the function of other remote control to the buttons in the highlighted areas in the following illustration. The buttons can be programmed independently for each input area.

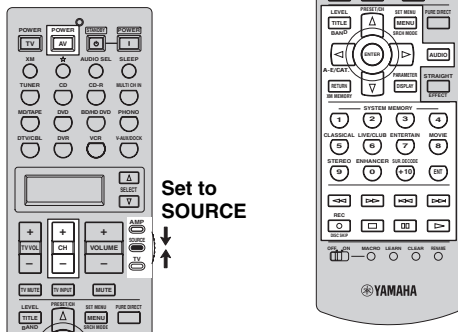

Note

The remote control transmits infrared rays. If the other remote control also uses infrared rays, this remote control can learn most of its functions. However, you may not be able to program some special signals or extremely long transmissions. Refer to the operating instructions for the other remote control.

- 1 Set the operation mode selector to **⑬SOURCE** and then press an input selector button (①) or ☆ to select an input area.



Note

Make sure that the operation mode selector is set to **⑬SOURCE**. When you set the operation mode selector to **⑬AMP** and program a remote control codes from other remote controls, the programmed key cannot operate the amplifier function of this unit.

- 2 Place this remote control about 5 to 10 cm (2 to 4 in) apart from the other remote control on a flat surface so that their infrared transmitters are aimed at each other.

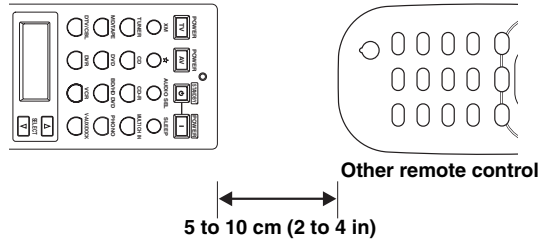

- 3 Press **⑭LEARN** using a ballpoint pen or similar object.

“LEARN” and the name of the selected input area (e.g. “DVD”) appear alternately in the display window (⑮) on the remote control.

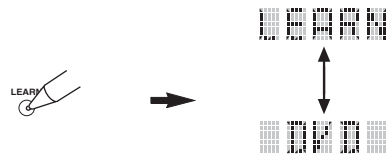

Notes

- Do not press and hold **⑭LEARN**. If you hold it down for more than 3 seconds, the remote enters the remote control code setting mode.
- If you do not complete each of the following steps within 30 seconds, the learning mode will be automatically canceled. In this case, start over from step 3.

- 4 Press the button for which you want to program the new function.

“LEARN” appears in the display window (⑮) on the remote control.



5 Press and hold the button you want to program on the other remote control until "OK" appears in the display window (Ⓜ) on the remote control.

"NG" appears in the display window (Ⓜ) on the remote control if learning was unsuccessful. In this case, start over from step 4.

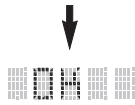
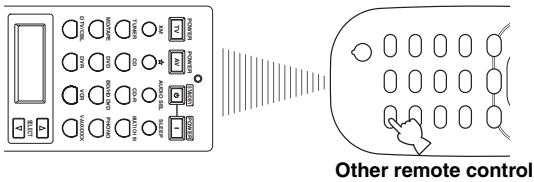

- If you want to program another function, repeat steps 4 and 5.
- If you continuously want to program another function for another component, press (Ⓜ) **SELECT** Δ / ∇ to select the component, and then repeat steps 4 and 5.

6 Press (Ⓜ) **LEARN** again to exit from the learning mode.



Notes

- "ERROR" appears in the display window (Ⓜ) on the remote control if you press a button not indicated in the respective step, or when you press more than one button simultaneously.
- This remote control can learn approximately 200 functions. However, depending on the signals learned, "FULL" may appear in the display before you program 200 functions. In this case, clear unnecessary programmed functions to make room for further learning.
- Learning may not be possible in the following cases:
 - when the batteries in the remote control for this unit or other components are weak.
 - when the distance between the two remote controls is too great or too small.
 - when the remote control infrared windows are not facing each other at the appropriate angle.
 - when the remote control is exposed to direct sunlight.
 - when the function to be programmed is continuous or uncommon.

Changing source names in the display window

You can change the name of the input source that appears in the display window (Ⓜ) on the remote control if you want to use a different name from the factory preset. This feature is useful when you have set an input area to control a different component.

1 Set the operation mode selector to (Ⓜ) **AMP** or (Ⓜ) **SOURCE** and then press an input selector button (Ⓜ) or ☆ to select the input area you want to rename.

The name of the selected input area appears in the display window (Ⓜ).

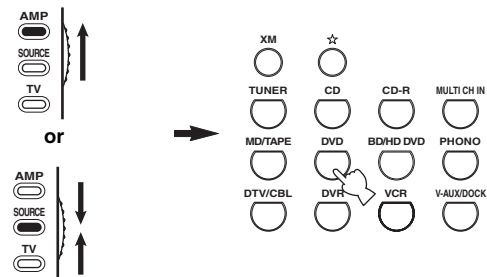

2 Press (Ⓜ) **RENAME** using a ballpoint pen or similar object.



Note

If you do not complete each of the following steps within 30 seconds, the renaming mode will be automatically canceled. In this case, start over from step 2.

3 Press $\textcircled{3}$ Δ / ∇ to select and enter a character.

Pressing $\textcircled{3}$ ∇ changes the character as follows:

A to Z, 1 to 9, 0, + (plus), - (hyphen), ; (semicolon), / (slash), and space.

Pressing $\textcircled{3}$ Δ changes the characters in reverse order.

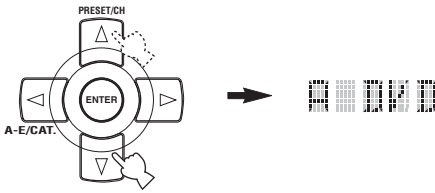

4 Press $\textcircled{3}$ \rightarrow to move the cursor to the next position.

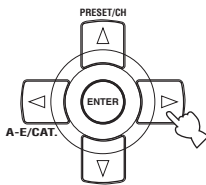

Press $\textcircled{3}$ \leftarrow to move the cursor to the previous position.

5 Press $\textcircled{3}$ ENTER to set the new name.

“OK” appears in the display window (⑪) on the remote control if renaming was successful.

“NG” appears in the display window (⑪) on the remote control if renaming was unsuccessful. In this case, start over from step 3.



If you continuously want to rename another input area, press the input selector button (①) or ☆, or press $\textcircled{11}$ SELECT Δ / ∇ repeatedly to select the component, then repeat steps 3 through 5.

6 Press $\textcircled{2}$ RENAME again to exit from the renaming mode.



Note

“ERROR” appears in the display window (⑪) on the remote control if you press a button not indicated in the respective step, or when you press more than one button simultaneously.

Macro programming features

The macro programming feature makes it possible to perform a series of operations with the press of a single button. For example, when you want to play a CD, normally you would turn on the components, select the CD input, and press the play button to start playback. The macro programming feature lets you perform all of these operations simply by pressing the CD macro button. The buttons listed as macro buttons below are factory set with macro programs. You can also program your own macros (see page 108).

MACRO operations

Macro buttons

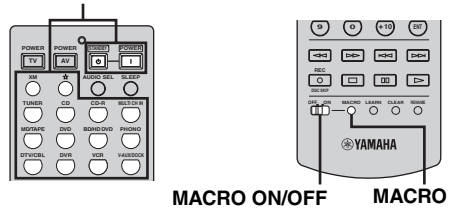

1 Set the $\textcircled{2}$ MACRO ON/OFF selector to ON.

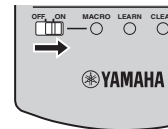

2 Press the desired macro button.

3 Set the $\textcircled{2}$ MACRO ON/OFF selector to OFF when you finish to using the macro programming operation.

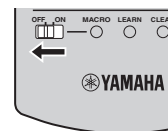

Notes

- While the remote control is running a macro program, it does not accept any other operation until it has completed running the program (the transmission indicator stops flashing).
- Continue to aim the remote control at the component the macro is operating until the macro operation is complete.

■ Default macro functions

Pressing macro button	To automatically transmit these signals in order		
	First	Second	Third
		—	—
	(*1)	(*2)	—
			—
			—
	(*1)	(*3)	—
			(CD area) (*4)
			(CD-R area) (*4)
			—
			(MD/TAPE area) (*4)
			(DVD area) (*4)
			(BD/HD DVD area) (*4)
			—
			—
			(DVR area) (*4)
			(VCR area) (*4)
			—

*1 You can turn on some components (including Yamaha components) connected to this unit by connecting them to the AC OUTLET(S) on the rear panel of this unit. Power control may not be synchronized with this unit depending on the component. For details, refer to the operating instructions for the connected component.

*2 When the remote control code for your TV is set up for either DTV/CBL or PHONO (see page 102), you can turn on the power of your TV without selecting an input source. The remote control code set up for DTV takes priority over the one for PHONO.

*3 When TUNER is selected as the input source, this unit plays the last station received before the unit was set in the standby mode.

*4 Playback can be started for any Yamaha remote control-compatible MD recorder, CD player, CD recorder, DVD player, Blu-ray Disc player, HD DVD player or DVD recorder. When using macros to operate other components, you will need to program the play button on the input area of that component (see page 104) or set a remote control code (see page 102) in advance.

■ Programming macro operations

You can program your own macro and use the macro programming feature to transmit several remote control commands in sequence at the press of a button. Be sure to set up remote control codes or perform learning operations before programming the macro.

Notes

- The default macro is not cleared when a new macro is programmed for a button. The default macro can be used again when the programmed macro is cleared.
- It is not possible to add a new signal (macro step) to the default macro. Programming a macro changes all macro contents.
- We do not recommend programming continuous operations such as volume control in a macro.

1 Set the operation mode selector to ⑬AMP or ⑬SOURCE and then press ②MACRO using a ballpoint pen or similar object.

“MCR ?” appears in the display window (⑪) on the remote control.

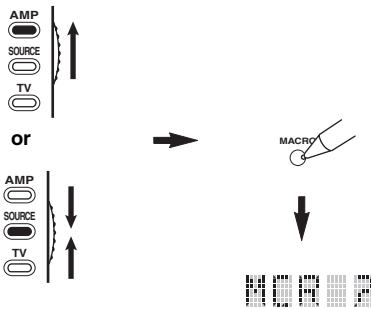

Note

If you do not complete each of the following steps within 30 seconds, the macro programming mode will be automatically canceled. In this case, start over from step 1.

2 Press the ②MACRO button you want to use to operate the macro.

The macro button name (e.g. “M;DVD”) and the selected component name (e.g. “DVD”) appear alternately in the display window (⑪) on the remote control.

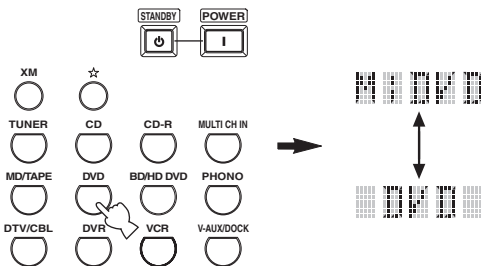

Note

“AGAIN” appears in the display window (⑪) if you press a button other than a macro button.

3 Press the buttons for the functions you want to include in the macro operation in sequence.

You can set up to 10 steps (10 functions). After you have set 10 steps, “FULL” appears and the remote control automatically exits from the macro mode.

Example:

Set the input source to DVD → Activate the DVD player → Set the sleep timer

Step 1 (“MCR 1”): Press DVD.

Step 2 (“MCR 2”): Press AV POWER.

Step 3 (“MCR 3”): Press SLEEP.

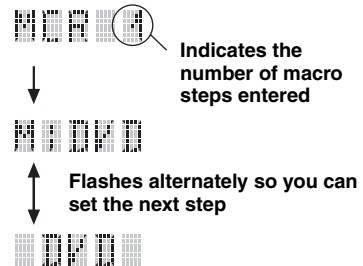
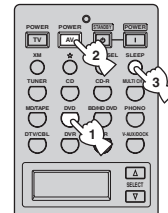

Note

To change the selected input area, press ⑩SELECT Δ / ▽. Pressing the input selector buttons will program a macro step, whereas ⑩SELECT Δ / ▽ only changes the selected input area.

4 Press ②MACRO again using a ballpoint pen or similar object when the operation sequence you want to program is complete.

Note

“ERROR” appears in the display window (⑪) if you press more than one button simultaneously.

Clearing configurations

You can clear all changes made in each function set, such as learned functions, macros, renamed input area names and setup remote control codes.

Clearing function sets

- 1 Set the operation mode selector to **AMP** or **SOURCE** and then press **CLEAR** by using a ballpoint pen or similar object.

“CLEAR” appears in the display window (⑩).

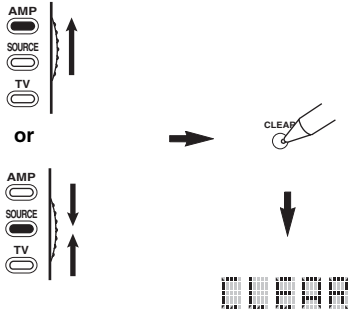

Note

If you do not complete each of the following steps within 30 seconds, the clearing mode will be automatically canceled. In this case, start over from step 1.

- 2 Press **Δ / ∇** to select the clear mode.

L;CD (etc.)	(L; Name of an input area) Clears all learned functions in the respective input area. The name of a component is shown after a semicolon (;). Press an input selector button to select the input area.
L;AMP	Clears all learned functions for controlling the amplifier functions of this unit.
L;ALL	Clears all learned functions.
M;ALL	Clears all programmed macros.
RNAME	Clears all renamed source names.
FCTRY	Clears all remote functions and returns the remote to the factory settings.

- 3 Press and hold **CLEAR** again for about 3 seconds.

“WAIT” appears in the display window (⑩). If clearing was successful, “C;OK” appears in the display window (⑩) on the remote control.



Once you have cleared a learned function for a button, the button reverts to the factory setting (or to the manufacturer setting if you have set remote control codes).

Notes

- “L;ALL” and “FCTRY” may take about 30 seconds to complete.
- “C;NG” appears in the display window (⑩) if clearing was unsuccessful. In this case start over from step 2.
- “ERROR” appears in the display window (⑩) if you press a button not indicated in the respective step, or if you press more than one button simultaneously.

- 4 Press **CLEAR** again to exit.

Clearing a learned function

You can clear the function learned for a certain button in each control area.

- 1 Set the operation mode selector to **AMP** or **SOURCE** and then press an input selector button (①) or **☆** to select the input area containing the function you want to clear.

The selected component name appears in the display window.

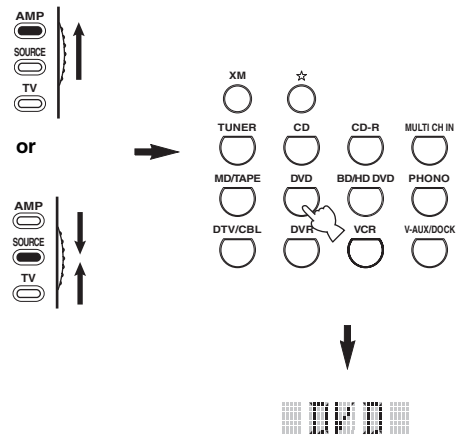

2 Press ②LEARN using a ballpoint pen or similar object.

“LEARN” and the selected component name (e.g. “DVD”) appear alternately in the display window.

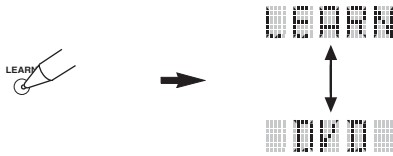

Notes

- Do not press and hold ②LEARN. If you hold it down for more than 3 seconds, the remote control enters the remote control code setting mode.
- If you do not complete each of the following steps within 30 seconds, the learning mode will be automatically canceled. In this case, start over from step 2.

3 Press and hold ②CLEAR using a ballpoint pen or similar object and then press the button you want to clear for about 3 seconds.

“C;OK” appears in the display window (⑩) if clearing was successful. Once “C;OK” appears in the display window on the remote control, release the ballpoint pen or similar object used to press ②CLEAR to exit from the clearing mode. The remote control returns to the learning mode.

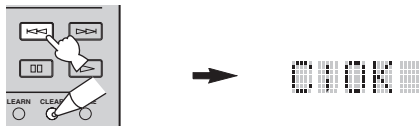

- If you continuously want to clear another function, repeat step 3.
- If you continuously want to clear another function for another component, press ⑩SELECT Δ / ▽ to select the input area, then repeat step 3.
- Once you clear a learned function, the button reverts to the factory setting (or to the manufacturer setting if you have set remote control codes).

4 Press ②LEARN again to exit.

Notes

- “C;NG” appears in the display window (⑩) on the remote control if clearing was unsuccessful. In this case, start over from step 2.
- “ERROR” appears in the display window (⑩) if you press more than one button simultaneously.

Clearing a macro function

You can clear the function programmed for a certain macro button.

1 Set the operation mode selector to ⑬AMP or ⑬SOURCE and then press ②MACRO using a ballpoint pen or similar object.

“MCR ?” appears in the display window (⑩) on the remote control.

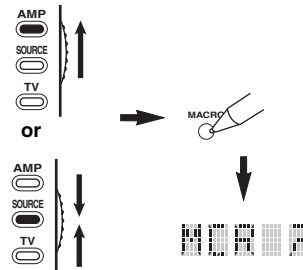

Note

If you do not complete each of the following steps within 30 seconds, the macro programming mode will be automatically canceled. In this case, start over from step 1.

2 Press and hold ②CLEAR using a ballpoint pen or similar object, then press the macro button you want to clear for about 3 seconds.

“C;OK” appears in the display window (⑩) on the remote control if clearing was successful.

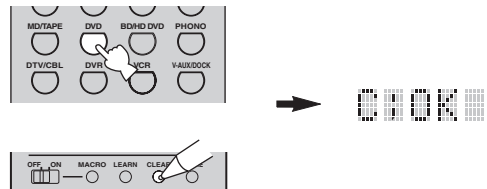

- If you continuously want to clear another function, repeat step 2.
- Once you clear a programmed function, the button reverts to the factory setting (or to the manufacturer setting if you have set remote control codes).

3 Press ②MACRO again to exit from the macro programming mode.

Notes

- “C;NG” appears in the display window (⑩) on the remote control if clearing was unsuccessful. In this case, start over from step 2.
- “ERROR” appears in the display window (⑩) on the remote control if you press more than one button simultaneously.

Using multi-zone configuration

This unit allows you to configure a multi-zone audio system. The multi-zone configuration feature enables you to set this unit to reproduce separate input sources in the main zone, second zone (Zone 2) and third zone (Zone 3). You can control this unit from the second or third zone using the supplied remote control.

Connect the source component to the analog audio input jacks of this unit to play back the source in Zone 2 or Zone 3. This unit does not output the audio signals input at the DIGITAL INPUT and HDMI jacks to the ZONE OUT jacks.

Connecting the Zone 2 and Zone 3 components

You need the following additional equipment to use the multi-zone functions of this unit:

- An infrared signal receiver in Zone 2 and/or Zone 3.
- An infrared signal emitter in the main zone. This emitter transmits the infrared signals from the remote control in Zone 2 and/or Zone 3 to the main zone (to a CD player or DVD player, for example).
- An amplifier and speakers for Zone 2 and/or Zone 3.

- ☀️ You do not need an extra amplifier and speakers for Zone 2 and/or Zone 3 if you want to use the internal amplifiers of this unit.
- Since there are many possible ways to connect and use this unit in a multi-zone configuration, we recommend that you consult with your nearest authorized Yamaha dealer or service center for the Zone 2 and Zone 3 connections that best meet your requirements.

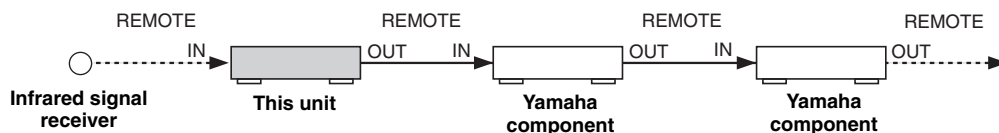

■ Using external amplifiers

To use an external amplifier in Zone 2 or Zone 3, connect the external amplifier to ZONE OUT jacks and select "EXT" in "AMP" (see page 94).

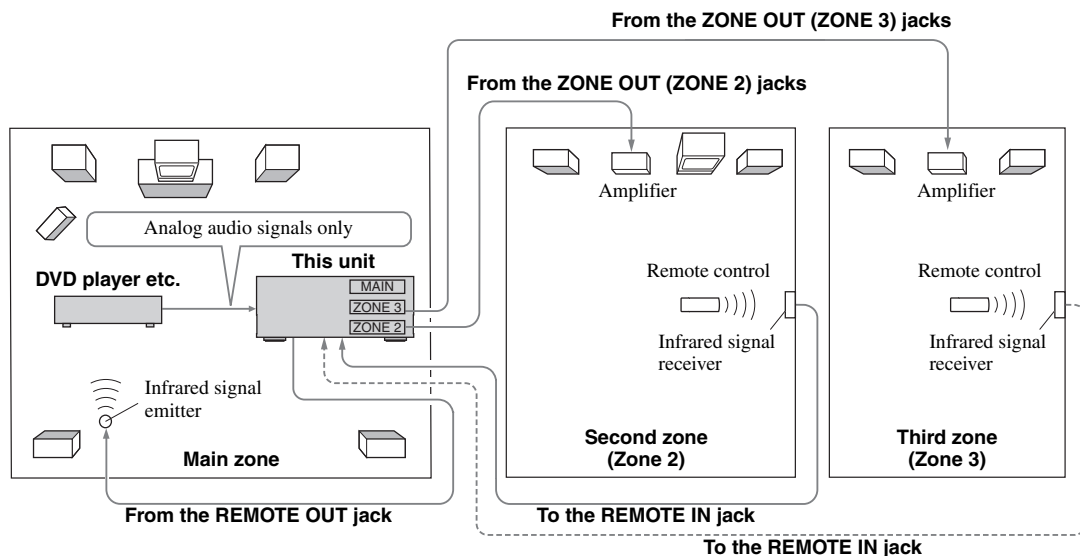

Notes

- To avoid unexpected noise, DO NOT use the Zone 2/Zone 3 feature with CDs encoded in DTS.
- Adjust the Zone 2/Zone 3 volume by using the amplifier in the Zone 2/Zone 3 when "VOLUME" are set to "FIX" (see page 95).

■ Using the internal amplifiers of this unit

Important safety notice

The SP1 or SP2 speaker terminals of this Receiver should not be connected to a Passive Loudspeaker Selector Box or more than one loudspeaker per channel.

Connection to a Passive Loudspeaker Selector Box or multiple speakers per channel could create an abnormally low impedance load resulting in amplifier damage. See this owner's manual for correct usage.

Compliance with minimum speaker impedance information for all channels must be maintained at all times. This information is found on the back panel of your Receiver.

If you want to use one internal amplifier (SP1 or SP2) of this unit

Connect the Zone 2 or Zone 3 speakers directly to the SP1 or SP2 speaker terminals and select either “[SP1]” or “[SP2]” for “AMP” (see page 94).

If you want to use two internal amplifiers (SP1 and SP2) of this unit

Connect the Zone 2 and Zone 3 speakers directly to the SP1 and SP2 speaker terminals and select “BOTH” for “AMP” (see page 94).

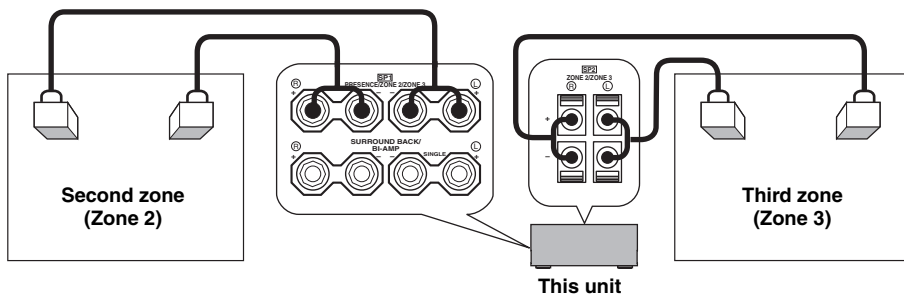

Controlling Zone 2 or Zone 3

You can select the zone you want to control by using the control buttons on the front panel or on the remote control.

■ Selecting Zone 2 or Zone 3

Front panel operations

- 1 Press **Ⓟ ZONE 2 ON/OFF** or **Ⓟ ZONE 3 ON/OFF** on the front panel to individually turn on or off Zone 2 or Zone 3.

- 2 Press **Ⓟ ZONE CONTROLS** on the front panel repeatedly to select the zone you want to control.

Each time you press **Ⓟ ZONE CONTROLS**, the front panel display changes as shown below, and the indicator for the currently selected zone flashes for approximately 10 seconds. However, no indicator flashes when the main zone is selected.

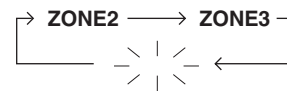

No indicator flashes
when the main zone is selected.

ZONE2

Controls the Zone 2 amplifier or tuner functions.

ZONE3

Controls the Zone 3 amplifier or tuner functions.



- You must complete this step within 10 seconds while the selected zone flashes in the front panel display. Otherwise, the currently selected zone mode is automatically canceled. In this case, press **Ⓟ ZONE CONTROLS** again.
- The initial setting is ZONE2 when both Zone 2 and Zone 3 are turned on.

3 Refer to “Selecting the input source of Zone 2 or Zone 3”, “Adjusting the volume level of Zone 2 or Zone 3”, “Adjusting the balance of the speaker level in Zone 2 or Zone 3” or “Adjusting the tonal quality of Zone 2 or Zone 3” on page 114 to perform further operations.

Remote control operations

- Set the operation mode selector to **Ⓜ AMP** and then press **Ⓡ SELECT** Δ repeatedly to select the zone you want to control. “ZONE 2” or “ZONE 3” is displayed in the display window **(Ⓡ)** on the remote control.

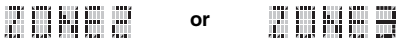

- Refer to “Selecting the input source of Zone 2 or Zone 3”, “Adjusting the volume level of Zone 2 or Zone 3”, “Adjusting the balance of the speaker level in Zone 2 or Zone 3” or “Adjusting the tonal quality of Zone 2 or Zone 3” on page 114 to perform further operations.

- Press **Ⓡ SELECT** Δ / ∇ to exit from the Zone 2/Zone 3 mode.

Turning on or off Zone 2 and/or Zone 3 using the remote control

- Ⓢ POWER** and **Ⓡ STANDBY** on the remote control work differently depending on the selected zone that appears in the display window **(Ⓡ)** on the remote control.
- When the main zone, Zone 2 or Zone 3 mode is selected, you can turn on the main zone, Zone 2 or Zone 3 or set them to the standby mode individually.
 - When the all mode is selected, pressing **Ⓢ POWER** turns on the main zone, Zone 2 and Zone 3 simultaneously and pressing **Ⓡ STANDBY** sets them to the standby mode simultaneously.

Control mode	Display window (Ⓡ)	POWER and STANDBY
Main zone mode	Name of the selected input area	Turns on the main zone only or sets it to the standby mode.
Zone 2 mode	“ZONE 2” or “2;name of the selected input area”	Turns on Zone 2 or sets it to the standby mode.
Zone 3 mode	“ZONE 3” or “3;name of the selected input area”	Turns on Zone 3 or sets it to the standby mode.
All mode	“ALL”	Ⓢ POWER: turns on the main zone, Zone 2 and Zone 3. Ⓡ STANDBY: sets the main zone, Zone 2 and Zone 3 to the standby mode.

Notes

- When the remote control is in the main zone mode, “MAIN” appears for a few seconds when **Ⓢ POWER** or **Ⓡ STANDBY** is pressed.
- “ALL” appears in the display window **(Ⓡ)** on the remote control only when **Ⓡ SELECT** ∇ is pressed.

Operate the following operations after activating the Zone 2 or Zone 3 operation mode.

■ Selecting the input source of Zone 2 or Zone 3

Rotate the **ⒸINPUT** selector on the front panel (or set the operation mode selector to **ⒻAMP** and then press one of the input selector buttons on the remote control) to select the input source of the selected zone.

If the remote control is used to select the input source, “2: name of the selected input source” or “3: name of the selected input source” is displayed in the display window (Ⓔ) on the remote control when Zone 2 or Zone 3 is selected respectively.

- Select “TUNER” as the input source to use the FM/AM tuning features in the selected zone. For details about the FM/AM tuning operations, see “FM/AM tuning” on page 54.
- Select “XM” as the input source to use the XM Satellite Radio features in the selected zone. For details about the XM Satellite Radio operations, see “XM™ Satellite Radio tuning” on page 58.
- Select “V-AUX” as the input source to play back the sources in the iPod stationed in a Yamaha iPod universal dock (such as the YDS-10 sold separately) in the selected zone. You can only control iPod in the simple remote mode (see page 64).

Note

The input sources are shared across all zones. You cannot select the same input source in multiple zones simultaneously.



You must complete this step within 10 seconds while the selected zone flashes in the front panel display. Otherwise, the currently selected zone mode is automatically canceled. In this case, press **ⒺZONE CONTROLS** on the front panel again.

■ Adjusting the volume level of Zone 2 or Zone 3

Rotate **ⒸVOLUME** on the front panel (or press **ⒺVOLUME +/-** on the remote control) to adjust the volume level of the selected zone.



Press **ⒺMUTE** on the remote control to mute the sound output to the selected zone.

Note

When you use the external amplifiers in Zone 2 or Zone 3, **ⒺVOLUME +/-** can be used only when “VOLUME” is set to “VAR” in “ZONE SET” (see page 95).

■ Adjusting the balance of the speaker level in Zone 2 or Zone 3

Press **ⒺTONE CONTROL** repeatedly to select “BALANCE” and then rotate **ⒺPROGRAM** on the front panel to adjust the balance of the front left and right speaker level of the selected zone.

■ Adjusting the tonal quality of Zone 2 or Zone 3

Set the operation mode selector to **ⒻAMP** and then press **CH +/-** on the remote control to adjust the high-frequency response (TREBLE) or **TV VOL +/-** to adjust the low-frequency response (BASS) respectively.

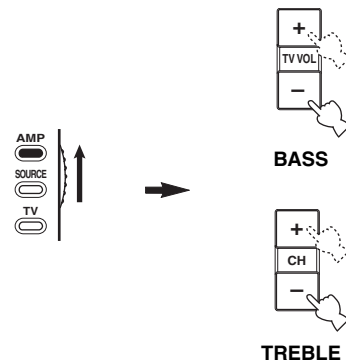

You can also adjust the tonal quality of Zone 2 or Zone 3 by using **ⒺTONE CONTROL** on the front panel. For details, see “Adjusting the tonal quality” on page 52.

Note

Check that “ZONE 2” or “ZONE 3” is displayed in the display window (Ⓔ) of the remote control before you adjust the tonal quality of the corresponding zone (see page 113).

■ Using Zone 2/Zone 3 remote control (except Europe model)

You can control Zone 2 or Zone 3 features by using the supplied Zone 2/Zone 3 remote control. First, set the ID1/ID2 switch and ZONE 2/ZONE 3 switch appropriately.

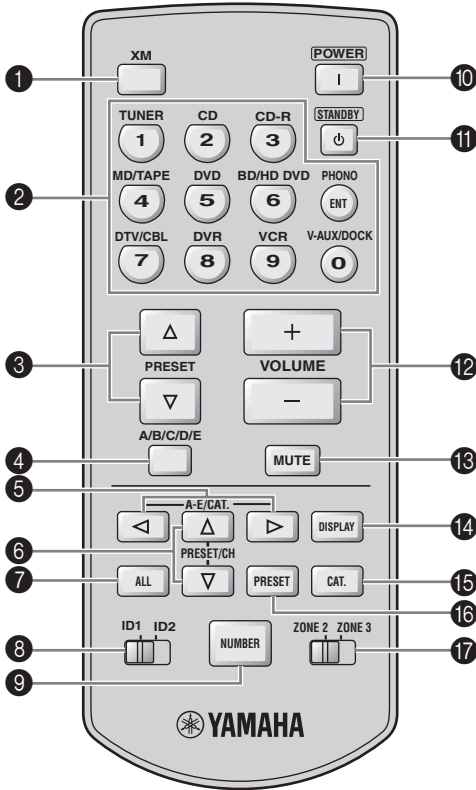

Controlling the amplifier function

① XM

Selects XM as the input source of the controlling zone.

② Input selector buttons

Selects the desired input source for the controlling zone.

③ ID1/ID2 switch

Switches the remote control ID between ID1 and ID2 (see page 118).

⑩ POWER

Turns on Zone 2 or Zone 3.

Note

This button is operational only when **MASTER ON/OFF** on the front panel is pressed inward to the ON position.

⑪ STANDBY

Sets Zone 2 or Zone 3 to the standby mode.

Note

This button is operational only when **MASTER ON/OFF** on the front panel is pressed inward to the ON position.

⑫ VOLUME +/-

Increases or decreases the volume level of Zone 2 or Zone 3.

⑬ MUTE

Mutes the sound of Zone 2 or Zone 3. Press again to restore the audio output to the previous volume level.

⑰ ZONE 2/ZONE 3 switch

Switches between the operation mode of Zone 2 and that of Zone 3.

Controlling the tuner function (see page 54)

Select "TUNER" as the input source of the controlling zone to use the following functions

③ PRESET Δ / ∇

Selects one of the 8 preset station numbers (1 to 8) when the colon (:) is displayed in the front panel display (see page 56).

④ A/B/C/D/E

Selects one of the preset station groups (A to E) (see page 55).

Controlling the XM Satellite Radio tuning function (see page 58)

Select "XM" as the input source of the controlling zone to use the following functions.

② Numeric buttons

(All Channel Search or Category Search mode)

Use 1 to 9 and 0 to enter a channel number directly.

(Preset Search mode)

Use 1 to 8 to enter a preset channel number directly.



While holding down **NUMBER** (see page 116), press the numeric buttons to enter the desired channel numbers directly when this unit is in the All Channel Search or Category Search mode.

⑤ A-E/CAT. \triangleleft / \triangleright

(All Channel Search mode)

Changes the channel category.

(Category Search mode)

Changes the channel category.

(Preset Search mode)

Changes the preset channel group (A to E).

Continued

6 PRESET/CH Δ / ∇

(All Channel Search mode)

Searches for a channel within all channels. Press and hold for quick search.

(Category Search mode)

Searches for a channel within the selected category. Press and hold for quick search.

(Preset Search mode)

Changes the preset channel number (1 to 8).

7 ALL

Selects the All Channel Search mode as the search mode (see page 60).

9 NUMBER

Press and hold before you press the numeric buttons to switch the function to entering the three-digit channel number in the All channel Search mode or Category Search mode (see page 61).

14 DISPLAY

Displays the XM Satellite Radio information such as channel number, channel name, category, artist name, or song title displayed in the front panel display or on the video monitor (see page 63).

15 CAT.

Selects the Category Search mode as the search mode (see page 60).

16 PRESET

Selects the Preset Search mode as the search mode (see page 60).

Advanced setup

This unit has additional menus that are displayed in the front panel display. The advanced setup menu offers additional operations to adjust and customize the way this unit operates. Change the initial settings (indicated in bold under each parameter) to reflect the needs of your listening environment.

Notes

- The settings you make are reflected next time you press **A** MASTER ON/OFF inward to the ON position to turn on this unit (see page 33).
- Only **A** MASTER ON/OFF, **C** STRAIGHT and the **N** PROGRAM selector are effective while you are using the advanced setup menu.
- All the other operations cannot be made while you are using the advanced setup menu.
- The advanced setup menu is only available in the front panel display.

Using the advanced setup menu

1 Press **A** MASTER ON/OFF on the front panel to release it outward to the OFF position to turn off this unit.

2 Press and hold **C** STRAIGHT and then press **A** MASTER ON/OFF inward to the ON position to turn on this unit. This unit turns on, and “ADVANCED MENU” appears in the front panel display.



3 Rotate the **N** PROGRAM selector to select the parameter you want to adjust.

The name of the selected parameter appears in the front panel display.

4 Press **C** STRAIGHT repeatedly to change the selected parameter setting.

5 Press **A** MASTER ON/OFF to release it outward to the OFF position to save the new setting and turn off this unit.



The settings you made are reflected next time you turn on this unit.

■ Speaker impedance SPEAKER IMP.

Use this feature to set the speaker impedance of this unit so that it matches that of your speakers.

Choices: **8Ω MIN**, 6Ω MIN

- Select “8Ω MIN” to set the speaker impedance to 8 Ω .
- Select “6Ω MIN” to set the speaker impedance to 6 Ω .

SPEAKER IMP.	Speaker	Impedance level
8Ω MIN	Front	The impedance of each speaker must be 8 Ω or higher.
	Center	The impedance of each speaker must be 8 Ω or higher.
	Surround	
	Surround back	
6Ω MIN	Front	The impedance of each speaker must be 4 Ω or higher.
	Center	The impedance of each speaker must be 6 Ω or higher.
	Surround	
	Surround back	

■ Remote sensor REMOTE SENSOR

Use this feature to activate or deactivate the signal-receiving capability of the remote control sensor on the front panel of this unit.

Choices: **ON**, OFF

- Select “ON” if you want to activate the signal-receiving capability of the remote control sensor.
- Select “OFF” if you want to deactivate the signal-receiving capability of the remote control sensor.

Note

We recommend that you set the parameter to “ON” in most cases.

See page 117 for the operation of the advanced setup menu.

■ **RS-232C access on the standby mode**
RS-232C STANDBY

Use this feature to set this unit to transmit data via the RS-232C interface when this unit is in the standby mode.

Choices: YES, NO

Initial setting:

[U.S.A. and Canada models]: YES

[Other models]: NO

- Select “YES” to set this unit to transmit data via the RS-232C interface.
- Select “NO” to set this unit not to transmit data via the RS-232C interface.

■ **Remote control AMP ID**
RC AMP ID

Use this feature to set the AMP ID of this unit for remote control recognition.

Choices: ID1, ID2

- Select “ID1” when the remote control AMP ID library code is set to “2001”.
- Select “ID2” when the remote control AMP ID library code is set to “2002”.

Setting remote control AMP ID code

1 Set the operation mode selector to **AMP** or **SOURCE**.

2 Press and hold **LEARN** for about 3 seconds using a ballpoint pen or similar object and then press **ENTER** repeatedly until “L;AMP” appears in the display window (Ⓜ) on the remote control.

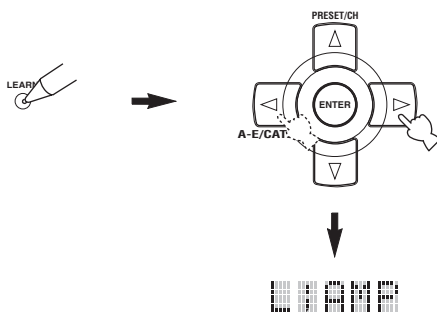

Notes

- Be sure to press and hold **LEARN** for at least 3 seconds, otherwise the learning process will start.
- If you do not complete each of the following steps within 30 seconds, the setting mode will be automatically canceled. In this case, start over from step 2.

3 Press **ENTER**.

The four-digit code set for the selected input area appears in the display window (Ⓜ) on the remote control.

4 Press the numeric buttons (Ⓜ) to enter the four-digit remote control AMP ID code for the input area you want to use.

Remote control AMP ID code*1	Function	RC AMP ID*2
2001 (initial setting)	Operates this unit using the default code.	ID1 (initial setting)
2002	Operates this unit using an alternative code.	ID2

*1 The remote control setting.

*2 The setting of this unit.

5 Press **ENTER** to set the number.

“OK” appears in the display window (Ⓜ) if the setting was successful.

“NG” appears in the display window (Ⓜ) if the setting was unsuccessful. In this case, start over from step 2.

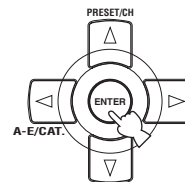

6 Press **LEARN** again to exit from the setup mode.

■ **Remote control TUNER ID**
RC TUNER ID

Use this feature to set the TUNER ID of this unit for remote control recognition.

Choices: ID1, ID2

- Select “ID1” when the remote control TUNER ID library code is set to “2602”.
- Select “ID2” when the remote control TUNER ID library code is set to “2603”.

Setting remote control TUNER ID

- 1 Set the operation mode selector to **AMP** or **SOURCE** and then press **TUNER** on the remote control to select the tuner to change the remote control ID.
- 2 Press and hold **LEARN** for about 3 seconds using a ballpoint pen or similar object until “L;TUN” and “TUNER” alternately appear in the display window (Ⓜ).

**Notes**

- Be sure to press and hold **LEARN** for at least 3 seconds, otherwise the learning process will start.
- If you do not complete each of the following steps within 30 seconds, the setting mode will be automatically canceled. In this case, start over from step 2.

- 3 Press **ENTER**.

The four-digit code set for the selected input area appears in the display window (Ⓜ) on the remote control.

- 4 Press the numeric buttons (Ⓜ) to enter the four-digit remote control code for the input area you want to use.

Remote control TUNER ID code*1	Function	RC TUNER ID*2
2602 (initial setting)	Operates this unit using the default code.	ID1 (initial setting)
2603	Operates this unit using an alternative code.	ID2

*1 The remote control setting.

*2 The setting of this unit.

- 5 Press **ENTER** to set the number.
“OK” appears in the display window (Ⓜ) if the setting was successful.
“NG” appears in the display window (Ⓜ) if the setting was unsuccessful. In this case, start over from step 2.

- 6 Press **LEARN** again to exit from the setup mode.



Remote control XM ID RC XM ID (U.S.A. and Canada models only)

Use this feature to set the XM ID of this unit for remote control recognition.

Choices: ID1, ID2

- Select “ID1” when the remote control XM ID library code is set to “2604”.
- Select “ID2” when the remote control XM ID library code is set to “2605”.

Setting remote control XM ID

- 1 Set the operation mode selector to **AMP** or **SOURCE** and then press **XM** on the remote control to select the XM to change the remote control ID.
- 2 Press and hold **LEARN** for about 3 seconds using a ballpoint pen or similar object until “L;TUN” and “XM” alternately appear in the display window (Ⓜ) on the remote control.

**Notes**

- Be sure to press and hold **LEARN** for at least 3 seconds, otherwise the learning process will start.
- If you do not complete each of the following steps within 30 seconds, the setting mode will be automatically canceled. In this case, start over from step 2.

- 3 Press **ENTER**.

The four-digit code set for the selected input area appears in the display window (Ⓜ) on the remote control.

- 4 Press the numeric buttons (Ⓢ) to enter the four-digit remote control code for the input area you want to use.**

Remote control XM ID code*1	Function	RC XM ID*2
2604 (initial setting)	Operates this unit using the default code.	ID1 (initial setting)
2605	Operates this unit using an alternative code.	ID2

*1 The remote control setting.

*2 The setting of this unit.

- 5 Press ⓂENTER to set the number.**

“OK” appears in the display window (Ⓜ) if the setting was successful.

“NG” appears in the display window (Ⓜ) if the setting was unsuccessful. In this case, start over from step 2.

- 6 Press ⓁLEARN again to exit from the setup mode.**



See page 117 for the operation of the advanced setup menu.

- Tuner frequency step TUNER FRQ STEP (Asia and General models only)**

Use this feature to set the tuner frequency step according to the frequency spacing in your area.

Choices: AM10/FM100, **AM9/FM50**

- Select “AM10/FM100” for North, Central and South America.
- Select “AM9/FM50” for all other areas.

- Bi-amplifier setting BI-AMP**

Use this feature to activate or deactivate the bi-amplifier function (see page 19).

Choices: ON, **OFF**

- Select “ON” if you want to activate the bi-amplifier function.
- Select “OFF” if you want to deactivate the bi-amplifier function.

Note

When “BI-AMP” is set to “ON”, the SURROUND BACK terminals cannot be used to connect surround back speakers in that the SURROUND BACK terminals are already used for the bi-amplifier connection (see page 19).

- Parameter initialization INITIALIZE**

Use this feature to reset the parameters of this unit to the initial factory settings. You can select the category of parameters to be initialized.

Choices: DSP PARAM, VIDEO, ALL, **CANCEL**

- Select “DSP PARAM” to initialize all the parameters of the sound field parameters (see page 67).
- Select “VIDEO” to initialize the parameters in “VIDEO SET” (see page 92) and “OSD SHIFT” (see page 91) and “GRAY BACK” in “DISPLAY SET” (see page 91).
- Select “ALL” to initialize all the parameters of this unit.
- Select “CANCEL” to cancel the initialization procedure.

Notes

- The advanced setup menu parameters are not initialized.
- Use “INITIALIZE” in the sound field program menu to initialize the parameters of the desired program (see page 67).

- HDMI video monitor check MONITOR CHECK**

Use this feature to activate or deactivate the monitor check function of this unit. When “MONITOR CHECK” is set to “YES”, this unit receives the information of the available video signal resolutions from the video monitor connected via HDMI and you can only select the resolutions supported by the video monitor in “HDMI SCALING” (see page 92). When “MONITOR CHECK” is set to “SKIP”, you can select any resolution in “HDMI SCALING”.

Choices: **YES**, SKIP

Troubleshooting

Refer to the table below when this unit does not function properly. If the problem you are experiencing is not listed below or if the instruction below does not help, turn off this unit, disconnect the power cable, and contact the nearest authorized Yamaha dealer or service center.

■ General

Problem	Cause	Remedy	See page
This unit fails to turn on or enters the standby mode soon after the power is turned on.	The power cable is not connected or the plug is not completely inserted.	Connect the power cable firmly.	—
	The speaker impedance setting is incorrect.	Set the speaker impedance to match your speakers.	33
	The protection circuitry has been activated.	Make sure that all speaker wire connections on this unit and on all speakers are secure and that the wire for each connection does not touch anything other than its respective connection.	16
	This unit has been exposed to a strong external electric shock (such as lightning or strong static electricity).	Turn off this unit, disconnect the power cable, plug it back in after 30 seconds and then use it normally.	—
No sound.	Incorrect input or output cable connections.	Connect the cables properly. If the problem persists, the cables may be defective.	24-31
	Audio input jack select is set to “HDMI”, “COAX/OPT” or “ANALOG”.	Set the audio input jack select to “AUTO”.	43
	Audio input jack select is set to “ANALOG” while the input source component outputs digital audio signals.	Set the audio input jack select to “AUTO” or “COAX/OPT”.	43
	No appropriate input source has been selected.	Select an appropriate input source with the Ⓢ INPUT selector on the front panel (or the input selector buttons Ⓢ on the remote control).	42, 43
	Speaker connections are not secure.	Secure the connections.	16
	The volume is turned down.	Turn up the volume.	—
	The sound is muted.	Press Ⓢ MUTE or Ⓢ VOLUME +/- on the remote control to resume audio output and then adjust the volume.	44
	Signals this unit cannot reproduce are being input from a source component, such as a CD-ROM.	Play a source whose signals can be reproduced by this unit.	—
	The HDMI components connected to this unit do not support the HDCP copy protection standards.	Connect HDMI components that support the HDCP copy protection standards.	21
	“SUPPORT AUDIO” is set to “OTHER” and “HDMI” audio signals are not being played back on this unit.	Set “SUPPORT AUDIO” to “RX-V1800” in “SET MENU”.	88
No picture.	The output and input for the picture are connected to different types of video jacks.	Set “VIDEO CONV.” to “ON” or connect your source components in the same way as you connect your video monitor to this unit.	92
	This unit outputs the video signals are not supported on the video monitor connected to the HDMI OUT jack.	Set the “INITIALIZE” to “VIDEO” to reset the video parameters.	120
		Set “MONITOR CHECK” to “YES”.	120
	Pure Direct mode is active.	Turn off the Pure Direct mode.	52
Non-standard video signals are input.			

Problem	Cause	Remedy	See page
Short message displays do not appear on the video monitor.	“SHORT MESSAGE” is set to “OFF”.	Set “SHORT MESSAGE” to “ON”.	91
	“GRAY BACK” is set to “OFF”.	Set “GRAY BACK” to “AUTO”.	91
	“VIDEO CONV.” is set to “OFF”.	Set “VIDEO CONV.” to “ON”.	92
	The signals input at the HDMI input jacks are being output at the HDMI OUT jack.		
The sound suddenly goes off.	Video signals in the progressive format or HDTV video signals are being input.		
	The protection circuitry has been activated because of a short circuit, etc.	Check that the speaker impedance setting is correct.	33, 117
		Check that the speaker wires are not touching each other and then turn this unit back on.	—
	The sleep timer has turned off this unit.	Turn on this unit, and play the source again.	—
Sound is heard from the speaker on one side only.	The sound is muted.	Press MUTE or VOLUME +/- on the remote control to resume audio output.	44
	Incorrect cable connections.	Connect the cables properly. If the problem persists, the cables may be defective.	16
Only the center speaker outputs substantial sound.	Incorrect settings in “SPEAKER LEVEL”.	Adjust the “SPEAKER LEVEL” settings.	82
	When playing a monaural source with a CINEMA DSP program, the source signal is directed to the center channel, and the front and surround speakers output effect sounds.		
No sound is heard from the center speaker.	“CENTER SP” in “SET MENU” is set to “NONE”.	Set “CENTER SP” to “SMALL” or “LARGE”.	80
	One of the HiFi DSP programs (except for “7ch Stereo”) has been selected and 2-channel source is being input.	Try another sound field program if you want to output sound from the center speaker.	46
No sound is heard from the presence speakers.	The sound field programs are turned off.	Press STRAIGHT to turn them on.	51
	You are using a source or program combination that does not output sound from all channels.	Try another sound field program.	42
No sound is heard from the surround speakers.	“SUR. L/R SP” in “SET MENU” is set to “NONE”.	Set “SUR. L/R SP” to “SMALL” or “LARGE”.	81
	This unit is in the “STRAIGHT” mode and a monaural source is being played back.	Press STRAIGHT on the front panel so that “STRAIGHT” disappears from the front panel display.	51
	Speakers are connected to the SURROUND BACK speaker terminals.	Connect the surround speakers to the SURROUND speaker terminals.	51
No sound is heard from the subwoofer.	“LFE/BASS OUT” in “SET MENU” is set to “FRONT” when a Dolby Digital or DTS signal is being played.	Set “LFE/BASS OUT” to “SWFR” or “BOTH”.	80
	“LFE/BASS OUT” in “SET MENU” is set to “SWFR” or “FRONT” when a 2-channel source is being played.	Set “LFE/BASS OUT” to “BOTH”.	80
	The source does not contain low-frequency signals.		

Problem	Cause	Remedy	See page
No sound is heard from the surround back speakers.	“SUR. L/R SP” in “SET MENU” is set to “NONE” and “SUR.B L/R SP” is automatically set to “NONE”.	Set “SUR. L/R SP” and “SUR.B L/R SP” to a setting other than “NONE”.	81
	“SUR.B L/R SP” in “SET MENU” is set to “NONE”.	Set “SUR.B L/R SP” to a setting other than “NONE”.	81
The audio input sources cannot be played in the desired digital audio signal format (Desired input source indicator or decoder indicator in the front panel display does not light up).	The connected component is not set to output the desired digital audio signals.	Make an appropriate setting following the operating instructions for your component.	—
	Audio input jack select is set to “ANALOG”.	Set the audio input jack select to “AUTO”.	43
A humming sound is heard.	Incorrect cable connections.	Connect the audio cables firmly. If the problem persists, the cables may be defective.	—
	No connection from the turntable to the GND terminal.	Connect the grounding cable of the turntable to the GND terminal of this unit.	28
The volume level is low while a record is being played.	The record is being played on a turntable with an MC cartridge.	Connect your turntable to this unit through an MC-head amplifier.	28
The volume level cannot be increased, or the sound is distorted.	The component connected to the AUDIO OUT (REC) jacks of this unit is turned off.	Turn on the power of the component.	—
The sound effect cannot be recorded.	It is not possible to record the sound effect with a recording component.		
A source cannot be recorded by a digital recording component connected to the DIGITAL OUTPUT jack.	The source component is not connected to the DIGITAL INPUT jacks of this unit.	Connect the source component to the DIGITAL INPUT jacks.	25, 28
	Some components cannot record Dolby Digital or DTS sources.		
A source cannot be recorded by an analog component connected to the AUDIO OUT (REC) jacks.	The source component is not connected to the analog AUDIO IN jacks of this unit.	Connect the source component to the analog AUDIO IN jacks.	28
The sound field parameters and some other settings of this unit cannot be changed.	“MEMORY GUARD” in “SET MENU” is set to “ON”.	Set “MEMORY GUARD” to “OFF”.	93
This unit does not operate properly.	The internal microcomputer has been frozen by an external electric shock (such as lightning or excessive static electricity) or by a power supply with low voltage.	Disconnect the power cable from the AC wall outlet and then plug it in again after about 30 seconds.	—
“CHECK SP WIRES” appears in the front panel display.	Speaker cables are short-circuited.	Make sure all speaker cables are connected correctly.	16
There is noise interference from digital or radio frequency equipment.	This unit is too close to the digital or high-frequency equipment.	Move this unit further away from such equipment.	—
The picture is disturbed.	The video source uses scrambled or encoded signals to prevent dubbing.		

Problem	Cause	Remedy	See page
This unit suddenly enters the standby mode.	The internal temperature becomes too high and the overheat protection circuitry has been activated.	Wait about 1 hour for this unit to cool down and then turn it back on.	—

■ Tuner

Problem	Cause	Remedy	See page	
FM	FM stereo reception is noisy.	The characteristics of FM stereo broadcasts may cause this problem when the transmitter is too far away or the antenna input is poor.	Check the antenna connections.	32
			Try using a high-quality directional FM antenna.	—
			Use the manual tuning method.	54
	There is distortion, and clear reception cannot be obtained even with a good FM antenna.	There is multi-path interference.	Adjust the antenna position to eliminate multi-path interference.	—
	The desired station cannot be tuned into with the automatic tuning method.	The signal is too weak.	Use a high-quality directional FM antenna.	—
			Use the manual tuning method.	54
	Previously preset stations can no longer be tuned into.	This unit has been disconnected for a long period.	Preset the stations again.	55
AM	The desired station cannot be tuned into with the automatic tuning method.	The signal is weak or the antenna connections are loose.	Tighten the AM loop antenna connections and orient it for the best reception.	32
			Use the manual tuning method.	54
	There are continuous crackling and hissing noises.	Supplied AM loop antenna is not connected.	Connect the AM loop antenna correctly even if you use an outdoor antenna.	32
		Noises can result from lightning, fluorescent lamps, motors, thermostats and other electrical equipment.	Use an outdoor antenna and a ground wire. This will help somewhat, but it is difficult to eliminate all noise.	32
	There are buzzing and whining noises.	A TV set is being used nearby.	Move this unit away from the TV set.	—

■ XM Satellite Radio (U.S.A. and Canada models only)

If an operation takes longer than usual or an error occurs, one of the following messages may appear in the front panel display. In this case, read the cause and follow the corresponding remedies.

Status message	Cause	Remedy	See page
CHECK ANTENNA	XM Mini-Tuner and Home Dock are not connected to the XM jack of this unit or do not work properly.	Check XM Mini-Tuner and Home Dock connections and orient for the best reception level.	58
UPDATING	The XM user encryption code is being updated.	Wait until the encryption code is updated.	—
NO SIGNAL	The signal is too weak.	Adjust the orientation of the antenna of Home Dock for the best reception level.	58
LOADING	It takes longer than 4 seconds for audio or text data to be decoded.	Wait until the decoding process has finished.	—
OFF AIR	The XM Satellite Radio channel you selected is not currently broadcasting any signals.	Check the channel number again or select another XM Satellite Radio channel.	—
<XM> - - -	The Channel Station ID (SID) is no longer available.		
- - - / - - -	No artist name or song title is available.		
<CAT> - - -	No channels are available for the selected category.	Select another channel category by pressing Ⓢ CATEGORY on the front panel (or Ⓢ A-E/CAT. </> on the remote control) repeatedly.	60

■ HDMI

HDMI ERROR	Cause	Remedy	See page
DEVICE OVER	The number of the connected HDMI components is over the limit.	Reduce the number of the connected HDMI components.	—
HDCP ERROR	HDCP authentication failed.	Check that the connected HDMI components support the HDCP copy protection standards.	—

HDMI Message	Cause	Remedy	See page
Out of Resolution	The connected video monitor is not compatible with the resolution of the input video signal.	Set the resolution of the video output signal of the input source component appropriately.	—

■ Remote control

Problem	Cause	Remedy	See page
The remote control does not work or function properly.	Wrong distance or angle.	The remote control will function within a maximum range of 6 m (20 ft) and no more than 30 degrees off-axis from the front panel.	36
	Direct sunlight or lighting (from an inverter type of fluorescent lamp, etc.) is striking the remote control sensor of this unit.	Reposition this unit.	—
	The batteries are weak.	Replace all batteries.	5
	The operation mode selector is set incorrectly.	Set the operation mode selector correctly. When operating this unit, set it to the AMP position. When operating the component selected by the input selector button, set it to the SOURCE position. When operating the TV set in the DTV or PHONO area, set it to the TV position.	—
	The remote control code is not correctly set.	Set the remote control code correctly using "List of remote control codes" at the end of this manual.	102
		Try setting another code of the same manufacturer using "List of remote control codes" at the end of this manual.	102
The library code of the remote control and the remote control ID of this unit do not match.	Match the remote control ID of this unit with the corresponding remote control library code.	103, 118	
Even if the remote control code is correctly set, there are some models that do not respond to the remote control.	Program the necessary functions independently into the programmable buttons using the Learn feature.	104	
The remote control does not learn new functions.	The batteries of this remote control and/or the other remote control are too weak.	Replace the batteries.	5
	The distance between the two remote controls is too much or too little.	Place the remote controls at the proper distance.	104
	The signal coding or modulation of the other remote control is not compatible with this remote control.	Learning is not possible.	—
	Memory capacity is full.	Delete other unnecessary functions to make room for the new functions.	109

■ iPod

Note

In case of a transmission error without a status message appearing in the front panel and in the OSD, check the connection of your iPod (see page 31).

Status message	Cause	Remedy	See page
Loading...	This unit is in the middle of recognizing the connection with your iPod. This unit is in the middle of acquiring song lists from your iPod.		
Connect error	There is a problem with the signal path from your iPod to this unit.	Turn off this unit and reconnect the Yamaha iPod universal dock to the DOCK terminal of this unit. Try resetting your iPod.	31 —
Unknown type	The iPod being used is not supported by this unit.	Only iPod (Click and Wheel), iPod nano, and iPod mini are supported.	—
iPod connected	Your iPod is properly stationed in a Yamaha iPod universal dock (such as the YDS-10, sold separately) connected to the DOCK terminal of this unit, and the connection between your iPod and this unit is complete.		
Disconnected	Your iPod was removed from a Yamaha iPod universal dock (such as YDS-10 sold separately) connected to the DOCK terminal of this unit.	Station your iPod back in a Yamaha iPod universal dock (such as YDS-10 sold separately) connected to the DOCK terminal of this unit.	31
Unable to Play	This unit cannot play back the songs currently stored on your iPod.	Check that the songs currently stored on your iPod are playable. Store some other playable music files on your iPod.	— —

■ AUTO SETUP

Before AUTO SETUP

Error message	Cause	Remedy	See page
Connect MIC!	Optimizer microphone is not connected.	Connect the supplied optimizer microphone to the OPTIMIZER MIC jack on the front panel.	37
Unplug HP!	Headphones are connected.	Unplug the headphones.	—

During AUTO SETUP

Error message	Cause	Remedy	See page
E-1:NO FRONT SP	Front L/R channel signals are not detected.	Check the front L/R speaker connections.	16
E-2:NO SUR. SP	A surround channel signal is not detected.	Check the surround speaker connections.	16
E-3:NO PRNS SP	A presence channel signal is not detected.	Check the presence speaker connections.	16
E-4:SBR→SBL	Only right surround back channel signal is detected.	Connect the surround back speaker to the SURROUND BACK (SINGLE) speaker terminal if you only have one surround back speaker.	16
E-5:NOISY	Background noise is too loud.	Try running “AUTO SETUP” in a quiet environment.	—
		Turn off noisy electric equipment like air conditioners or move them away from the optimizer microphone.	—
E-6:CHECK SUR.	Surround back speakers are connected, though surround L/R speakers are not.	Connect surround speakers when you use surround back speakers.	17
E-7:NO MIC	The optimizer microphone was unplugged during the “AUTO SETUP” procedure.	Connect the supplied optimizer microphone to the OPTIMIZER MIC jack on the front panel.	37
E-8:NO SIGNAL	The optimizer microphone does not detect test tones.	Check the microphone setting.	37
		Check the speaker connections and placement.	16
E-9:USER CANCEL	The “AUTO SETUP” procedure was cancelled due to user activity.	Run “AUTO SETUP” again.	37
E-10:INTERNAL ERROR	An internal error occurred.	Run “AUTO SETUP” again.	37

After AUTO SETUP

Warning message	Cause	Remedy	See page
W-1:OUT OF PHASE	Speaker polarity is not correct. This message may appear depending on the speakers even when the speakers are connected correctly.	Check the speaker connections for proper polarity (+ or –).	16
W-2:OVER 24m (80ft)	The distance between the speaker and the listening position is over 24 m (80 ft).	Bring the speaker closer to the listening position.	—
W-3:LEVEL ERROR	The difference of volume level among speakers is excessive.	Readjust the speaker installation so that all speakers are set in locations with similar conditions.	—
		Check the speaker connections.	16
		Use speakers of similar quality.	—
		Adjust the output volume of the subwoofer.	37

Notes

- If the “ERROR” or “WARNING” screens appears, check the cause of the problem, then run “AUTO SETUP” again.
- If warning message “W-2” or “W-3” appears, the adjustments are made, however the adjustment may not be optimal.
- Depending on the speakers, warning message “W-1” may appears even if the speaker connections are correct.
- If error message “E-10” occurs repeatedly, contact a qualified Yamaha service center.

Resetting the system

Use this feature to reset all the parameters of this unit to the initial factory settings.

Notes

- This procedure completely resets all the parameters of this unit including the “SET MENU” parameters. However, the advanced setup menu parameters will not be initialized.
- The initial factory settings are activated next time you turn on this unit.



To cancel the initialization procedure at any time without making any changes, press **Ⓐ MASTER ON/OFF** on the front panel to release it outward to the OFF position.

1 Press **Ⓐ MASTER ON/OFF** on the front panel to release it outward to the OFF position to turn off this unit.

2 Press and hold **Ⓞ STRAIGHT** and then press **Ⓐ MASTER ON/OFF** inward to the ON position to turn on this unit.

This unit turns on, and “ADVANCED SETUP” appears in the front panel display.



3 Rotate the **Ⓝ PROGRAM** selector to select “INITIALIZE”.

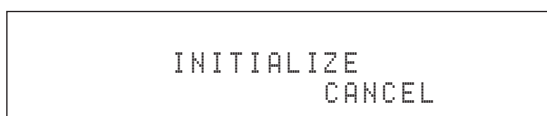

4 Press **Ⓞ STRAIGHT** repeatedly to select “ALL”.



- Select “CANCEL” to cancel the initialization procedure without making any changes.
- You can initialize the video parameters or sound field program parameters separately. See page 120 for details.

5 Press **Ⓐ MASTER ON/OFF** to release it outward to the OFF position to confirm your selection and turn off this unit.

Glossary

■ Audio and video synchronization (lip sync)

Lip sync, an abbreviation for lip synchronization, is a technical term that involves both a problem and a capability of maintaining audio and video signals synchronized during post-production and transmission. Whereas the audio and video latency requires complex end-user adjustments, HDMI version 1.3 incorporates an automatic audio and video syncing capability that allows devices to perform this synchronization automatically and accurately without user interaction.

■ Bi-amplification connection

A bi-amplification connection uses two amplifiers for a speaker. One amplifier is connected to the woofer section of a loudspeaker while the other is connected to the combined mid and tweeter section. With this arrangement each amplifier operates over a restricted frequency range. This restricted range presents each amplifier with a much simpler job and each amplifier is less likely to influence the sound in some way. The internal crossover of the speaker consists of a LPF (low pass filter) and a HPF (high pass filter). As its name implies, the LPF passes frequencies below a cutoff and rejects frequencies above the cutoff frequency. Likewise, the HPF passes frequencies above its cutoff.

■ Component video signal

With the component video signal system, the video signal is separated into the Y signal for the luminance and the Pb and Pr signals for the chrominance. Color can be reproduced more faithfully with this system because each of these signals is independent. The component signal is also called the “color difference signal” because the luminance signal is subtracted from the color signal. A monitor with component input jacks is required in order to output component signals.

■ Composite video signal

With the composite video signal system, the video signal is composed of three basic elements of a video picture: color, brightness and synchronization data. A composite video jack on a video component transmits these three elements combined.

■ Deep Color

Deep Color refers to the use of various color depths in displays, up from the 24-bit depths in previous versions of the HDMI specification. This extra bit depth allows HDTVs and other displays go from millions of colors to billions of colors and eliminate on-screen color banding for smooth tonal transitions and subtle gradations between colors. The increased contrast ratio can represent many times more shades of gray between black and white. Also Deep Color increases the number of available colors within the boundaries defined by the RGB or YcbCr color space.

■ Dialogue normalization

Dialogue Normalization is a feature of Dolby Digital or DTS, which is used to keep the programs at the same average listening level so that the user does not have to change the volume control between Dolby Digital or DTS programs.

■ Dolby Digital

Dolby Digital is a digital surround sound system that gives you completely independent multi-channel audio. With 3 front channels (front L/R and center), and 2 surround stereo channels, Dolby Digital provides 5 full-range audio channels. With an additional channel especially for bass effects, called LFE (Low Frequency Effect), the system has a total of 5.1-channels (LFE is counted as 0.1 channel). By using 2-channel stereo for the surround speakers, more accurate moving sound effects and surround sound environment are possible than with Dolby Surround. The wide dynamic range from maximum to minimum volume reproduced by the 5 full-range channels and the precise sound orientation generated using digital sound processing provide listeners with unprecedented excitement and realism. With this unit, any sound environment from monaural up to a 5.1-channel configuration can be freely selected for your enjoyment.

■ Dolby Digital EX

Dolby Digital EX creates 6 full-bandwidth output channels from 5.1-channel sources. This is done using a matrix decoder that derives 3 surround channels from the 2 in the original recording. For the best results, Dolby Digital EX should be used with movie sound tracks recorded with Dolby Digital Surround EX. With this additional channel, you can experience more dynamic and realistic moving sound especially with scenes with “fly-over” and “fly-around” effects.

■ Dolby Digital Plus

Dolby Digital Plus is an advanced audio technology developed for high-definition programming and media including HD broadcasts, HD DVD, and Blu-ray Disc. Selected as a mandatory audio standard for HD DVD and as an optional audio standard for Blu-ray Disc, this technology delivers multichannel sound with discrete channel output. Supporting bitrates up to 6.0 Mbps, Dolby Digital Plus can carry up to 7.1 discrete audio channels simultaneously. Supported by HDMI version 1.3 and designed for the optical disc players and AV receivers/amplifiers of the future, Dolby Digital Plus also remains fully compatible with the existing multichannel audio systems that incorporate Dolby Digital.

■ Dolby Pro Logic II

Dolby Pro Logic II is an improved technique used to decode vast numbers of existing Dolby Surround sources. This new technology enables a discrete 5-channel playback with 2 front left and right channels, 1 center channel, and 2 surround left and right channels instead of only 1 surround channel for conventional Pro Logic technology. There are three modes available: “Music mode” for music sources, “Movie mode” for movie sources and “Game mode” for game sources.

■ Dolby Pro Logic IIx

Dolby Pro Logic IIx is a new technology enabling discrete multi-channel playback from 2-channel or multi-channel sources. There are three modes available: “Music mode” for music sources, “Movie mode” for movie sources (for 2-channel sources only) and “Game mode” for game sources.

■ Dolby Surround

Dolby Surround uses a 4-channel analog recording system to reproduce realistic and dynamic sound effects: 2 front left and right channels (stereo), a center channel for dialog (monaural), and a surround channel for special sound effects (monaural). The surround channel reproduces sound within a narrow frequency range. Dolby Surround is widely used with nearly all video tapes and laser discs, and in many TV and cable broadcasts as well. The Dolby Pro Logic decoder built into this unit employs a digital signal processing system that automatically stabilizes the volume on each channel to enhance moving sound effects and directionality.

■ Dolby TrueHD

Dolby TrueHD is an advanced lossless audio technology developed for high-definition disc-based media including HD DVD and Blu-ray Disc. Selected as a mandatory audio standard for HD DVD and as an optional audio standard for Blu-ray Disc, this technology delivers sound that is bit-for-bit identical to the studio master, offering a high-definition home theater experience. Supporting bitrates up to 18.0 Mbps, Dolby TrueHD can carry up to 8 discrete channels of 24-bit/96 kHz audio simultaneously. Supported by HDMI version 1.3 and designed for the optical disc players and AV receivers/amplifiers of the future, Dolby TrueHD also remains fully compatible with the existing multichannel audio systems and retains the metadata capability of Dolby Digital, allowing dialog normalization and dynamic range control.

■ DSD

Direct Stream Digital (DSD) technology stores audio signals on digital storage media, such as Super Audio CDs. Using DSD, signals are stored as single bit values at a high-frequency sampling rate of 2.8224 MHz, while noise shaping and oversampling are used to reduce distortion, a common occurrence with very high quantization of audio signals. Due to the high sampling rate, better audio quality can be achieved than that offered by the PCM format used for normal audio CDs.

■ DTS 96/24

DTS 96/24 offers an unprecedented level of audio quality for multi-channel sound on DVD video, and is fully backward-compatible with all DTS decoders. “96” refers to a 96 kHz sampling rate compared to the typical 48 kHz sampling rate. “24” refers to 24-bit word length. DTS 96/24 offers sound quality transparent to the original 96/24 master, and 96/24 5.1-channel sound with full-quality full-motion video for music programs and motion picture soundtracks on DVD video.

■ DTS Digital Surround

DTS digital surround was developed to replace the analog soundtracks of movies with a 6.1-channel digital sound track, and is now rapidly gaining popularity in movie theaters around the world. DTS, Inc. has developed a home theater system so that you can enjoy the depth of sound and natural spatial representation of DTS digital surround in your home. This system produces practically distortion-free 6-channel sound (technically, front left and right, center, surround left and right, and LFE 0.1 (subwoofer) channels for a total of 5.1 channels). This unit incorporates a DTS-ES decoder that enables 6.1-channel reproduction by adding the surround back channel to the existing 5.1-channel format.

■ DTS Express

DTS Express is an advanced audio technology for the optional feature on Blu-ray Disc or HD DVD, which offers high-quality, low bit rate audio optimized for network streaming, and Internet applications. DTS Express is used for the Secondary Audio feature of Blu-ray Disc or the Sub Audio feature of HD DVD. These features deliver audio commentaries (for example, the additional commentaries made by the director of a film) on demand by the users via the Internet, etc. DTS Express signals are mixed down with the main audio stream on the player component, and the component sends the mixed audio stream to the AV receivers/amplifiers via digital coaxial, digital optical, or analog connections.

■ DTS-HD High Resolution Audio

DTS-HD High Resolution Audio is an high resolution audio technology developed for high-definition disc-based media including HD DVD and Blu-ray Disc. Selected as an optional audio standard for both HD DVD and Blu-ray Disc, this technology delivers sound that is virtually indistinguishable from the original, offering a high-definition home theater experience. Supporting bitrates up to 3.0 Mbps for HD DVD and 6.0 Mbps for Blu-ray Disc, DTS-HD High Resolution Audio can carry up to 7.1 discrete channels of 24-bit/96 kHz audio simultaneously. Supported by HDMI version 1.3 and designed for the optical disc players and AV receivers/amplifiers of the future, DTS-HD High Resolution Audio also remains fully compatible with the existing multichannel audio systems that incorporate DTS Digital Surround.

■ DTS-HD Master Audio

DTS-HD Master Audio is an advanced lossless audio technology developed for high-definition disc-based media including HD DVD and Blu-ray Disc. Selected as a mandatory audio standard for both HD DVD and Blu-ray Disc, this technology delivers sound that is bit-for-bit identical to the studio master, offering a high-definition home theater experience. Supporting bitrates up to 18.0 Mbps for HD DVD and up to 24.5 Mbps for Blu-ray Disc, DTS-HD Master Audio can carry up to 7.1 discrete channels of 24-bit/96 kHz audio simultaneously. Supported by HDMI version 1.3 and designed for the optical disc players and AV receivers/amplifiers of the future, DTS-HD Master Audio also remains fully compatible with the existing multichannel audio systems that incorporate DTS Digital Surround.

■ HDMI

HDMI (High-Definition Multimedia Interface) is the first industry-supported, uncompressed, all-digital audio/video interface. Providing an interface between any source (such as a set-top box or AV receiver) and an audio/video monitor (such as a digital television), HDMI supports standard, enhanced or high-definition video as well as multi-channel digital audio using a single cable. HDMI transmits all ATSC HDTV standards and supports 8-channel digital audio, with bandwidth to spare to accommodate future enhancements and requirements. When used in combination with HDCP (High-bandwidth Digital Content Protection), HDMI provides a secure audio/video interface that meets the security requirements of content providers and system operators. For further information on HDMI, visit the HDMI website at "<http://www.hdmi.org/>".

■ LFE 0.1 channel

This channel reproduces low-frequency signals. The frequency range of this channel is from 20 Hz to 120 Hz. This channel is counted as 0.1 because it only enforces a low-frequency range compared to the full-range reproduced by the other 5/6 channels in Dolby Digital or DTS 5.1/6.1-channel systems.

■ Neo:6

Neo:6 decodes the conventional 2-channel sources for 6-channel playback by the specific decoder. It enables playback with the full-range channels with higher separation just like digital discrete signal playback. There are two modes available: "Music mode" for music sources and "Cinema mode" for movie sources.

■ Neural-THX Surround

"Neural-THX®" Surround is taking surround sound to the next level. This revolutionary new technology delivers the rich envelopment and discrete image detail of surround sound in a format that is fully compatible with stereo. Neural-THX Surround reduces the bandwidth needed for broadcasters to deliver true, multi-channel surround presentations, and enables 7.1-channel support for gaming and movies. By unmasking the audio details, typically lost by other playback systems, audiences will experience the deep ambience and subtle details of movies, music and games. And with this technology being used by sound designers during content creation, as well as embedded into playback devices, Neural-THX Surround promises a listening experience that is true to the original mix. Neural-THX Surround has been chosen as the official surround sound broadcast format for XM Satellite Radio's "XM HD Surround", as well as other leading FM/HD radio stations worldwide. For additional information, please visit <http://www.neuralsurround.com/>.

■ PCM (Linear PCM)

Linear PCM is a signal format under which an analog audio signal is digitized, recorded and transmitted without using any compression. This is used as a method of recording CDs and DVD audio. The PCM system uses a technique for sampling the size of the analog signal per very small unit of time. Standing for “Pulse Code Modulation”, the analog signal is encoded as pulses and then modulated for recording.

■ Sampling frequency and number of quantized bits

When digitizing an analog audio signal, the number of times the signal is sampled per second is called the sampling frequency, while the degree of fineness when converting the sound level into a numeric value is called the number of quantized bits. The range of rates that can be played back is determined based on the sampling rate, while the dynamic range representing the sound level difference is determined by the number of quantized bits. In principle, the higher the sampling frequency, the wider the range of frequencies that can be played back, and the higher the number of quantized bits, the more finely the sound level can be reproduced.

■ S-video signal

With the S-video signal system, the video signal normally transmitted using a pin cable is separated and transmitted as the Y signal for the luminance and the C signal for the chrominance through the S-video cable. Using the S VIDEO jack eliminates video signal transmission loss and allows recording and playback of even more beautiful images.

Sound field program information

■ Elements of a sound field

What really creates the rich, full tones of a live instrument are the multiple reflections from the walls of the room. In addition to making the sound live, these reflections enable us to tell where the player is situated as well as the size and shape of the room in which we are sitting.

There are two distinct types of sound reflections that combine to make up the sound field in addition to the direct sound coming straight to our ears from the player's instrument.

Early reflections

Reflected sounds reach our ears extremely rapidly (50 ms to 100 ms after the direct sound), after reflecting from one surface only (for example, from a wall or the ceiling).

Early reflections actually add clarity to the direct sound.

Reverberations

These are caused by reflections from more than one surface (for example, from the walls, and/or the ceiling) so numerous that they merge together to form a continuous sonic afterglow. They are non-directional and lessen the clarity of the direct sound.

Direct sound, early reflections and subsequent reverberations taken together help us to determine the subjective size and shape of the room, and it is this information that the digital sound field processor reproduces in order to create sound fields.

If you could create the appropriate early reflections and subsequent reverberations in your listening room, you would be able to create your own listening environment. The acoustics in your room could be changed to those of a concert hall, a dance floor, or a room with virtually any size at all. This ability to create sound fields at will is exactly what Yamaha has done with the digital sound field processor.

■ CINEMA DSP

Since the Dolby Surround and DTS systems were originally designed for use in movie theaters, their effect is best felt in a theater having many speakers designed for acoustic effects. Since home conditions, such as room size, wall material, number of speakers, and so on, can differ so widely, it is inevitable that there are differences in the sound heard. Based on a wealth of actually measured data, Yamaha CINEMA DSP provides the audiovisual experience of a movie theater in the listening room of your own home by using the Yamaha original sound field technology combined with various digital audio systems.

■ SILENT CINEMA

Yamaha has developed a natural, realistic sound effect DSP algorithm for headphones. Parameters for headphones have been set for each sound field so that accurate representations of all the sound field programs can be enjoyed on headphones.

■ Virtual CINEMA DSP

Yamaha has developed a Virtual CINEMA DSP algorithm that allows you to enjoy DSP sound field surround effects even without any surround speakers by using virtual surround speakers. It is even possible to enjoy Virtual CINEMA DSP using a minimal two-speaker system that does not include a center speaker.

■ Compressed Music Enhancer

The Compressed Music Enhancer feature of this unit enhances your listening experience by regenerating the missing harmonics in a compression artifact. As a result, flattened complexity due to the loss of high-frequency fidelity as well as lack of bass due to the loss of low-frequency bass is compensated, providing improved performance of the overall sound system.

■ Sound output from each speaker

Sound output from each speaker depends on the type of audio signals being input. Refer to the diagrams in the table below to understand the speaker layout for each sound field program. For details about the sound output from each speaker in sound field programs, refer to "Sound output in each sound field program" in "APPENDIX" at the end of this manual.

Note

Be advised that there may be no or not enough sound output from speakers depending on the type of input source being played back. Furthermore, there may be some channels that can only be used partially when they are adjusted to specific aspects of movies, such as special sound effects, etc.



Except for "2ch Stereo", "7ch Stereo", and "STRAIGHT", you can select a decoder to output sound from the surround back speakers (see page 46).

Parametric equalizer information

This unit employs Yamaha Parametric Room Acoustic Optimizer (YPAO) technology to optimize the frequency characteristics of its parametric equalizer to match your listening environment. YPAO uses a combination of the following three parameters (Frequency, Gain and Q factor) to provide highly precise adjustment of the frequency characteristics.

■ Frequency

This parameter is adjustable in one-third octave increments between 32 Hz and 16 kHz.

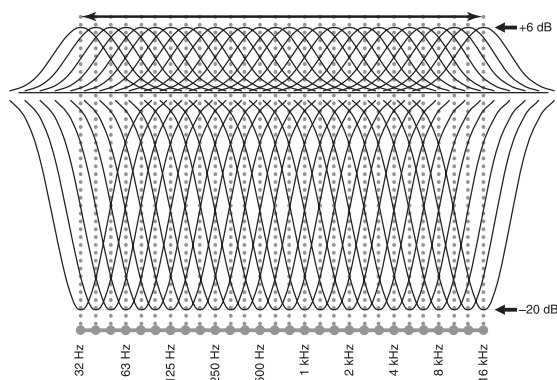

■ Gain

This parameter is adjustable in increments of 0.5 dB between -20 and +6 dB.

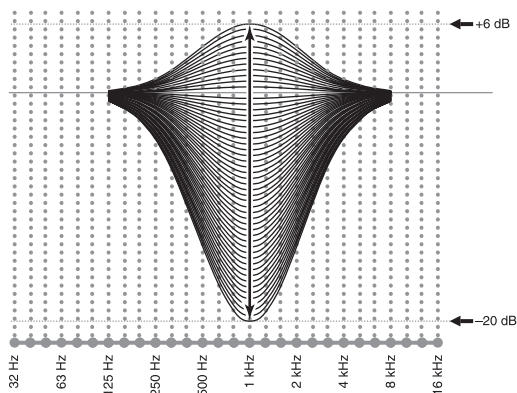

■ Q factor

The width of the specified frequency band is referred to as the Q factor. This parameter is adjustable between the values 0.5 and 10.

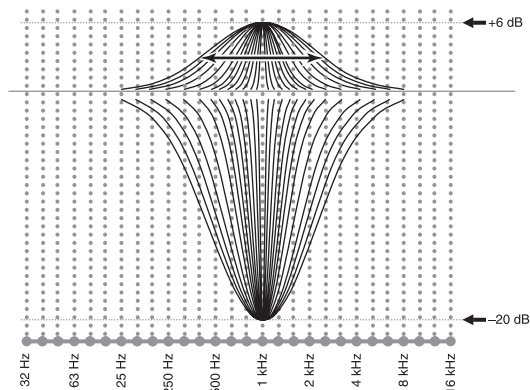

YPAO adjusts frequency characteristics to suit your listening requirements using a combination of the above three parameters (Frequency, Gain and Q factor) for each equalizer band in this unit's parametric equalizer. This unit has 7 equalizer bands for each channel.

The use of multiple equalizer bands enables more precise adjustments of frequency characteristics (as in Figure 2). This is not possible using only a single equalizer band (as in Figure 1).

Figure 1

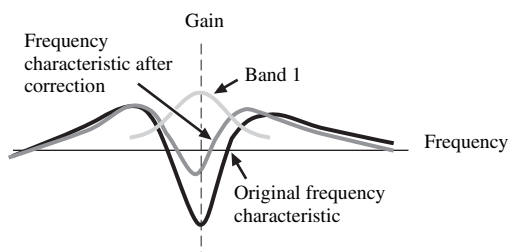
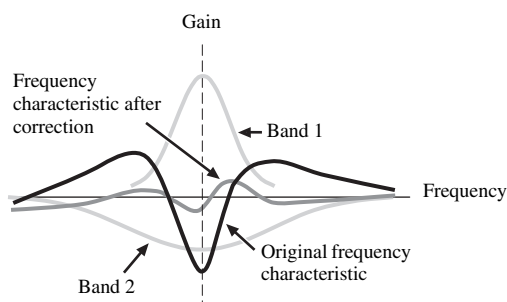

Figure 2



Specifications

AUDIO SECTION

- Minimum RMS Output Power for Front, Center, Surround, Surround back
20 Hz to 20 kHz, 0.04% THD, 8 Ω 130 W
- Dynamic Power (IHF)
8/6/4/2 Ω 160/195/255/335 W
- Maximum Useful Output Power (JEITA)
[Asia, General, China and Korea models]
1 kHz, 10% THD, 8 Ω 175 W
- Maximum Output Power [U.K. and Europe models]
1 kHz, 0.7% THD, 4 Ω 180 W
- Dynamic Headroom
8 Ω 0.9 dB
- IEC Output Power [U.K. and Europe models]
1 kHz, 0.04% THD, 8 Ω 130 W
- Damping Factor (IHF)
20 Hz to 20 kHz, 8 Ω 150 or more
- Input Sensitivity/Input Impedance
PHONO 3.5 mV/47 k Ω
CD, etc. 200 mV/47 k Ω
MULTI CH INPUT 200 mV/47 k Ω
- Maximum Input Voltage
PHONO (1 kHz, 0.1% THD) 60 mV or more
CD, etc. (1 kHz, 0.5% THD) 2.4 V or more
- Rated Output Voltage/Output Impedance
OUT (REC) 200 mV/900 Ω
PRE OUT 1.0 V/1.2 k Ω
SUBWOOFER 2.0 V/1.2 k Ω
ZONE 2/ZONE 3 OUT 1.0 V/1.4 k Ω
- Headphone Jack Rated Output/Impedance
CD, etc. (1 kHz, 40 mV, 8 Ω) 150 mV/100 Ω
- Frequency Response
CD to Front L/R, Pure Direct 10 Hz to 100 kHz, +0/-3 dB
- RIAA Equalization Deviation
PHONO (20 Hz to 20 kHz) 0 \pm 0.5 dB
- Total Harmonic Distortion
PHONO to OUT (REC)
(20 Hz to 20 kHz, 1 V) 0.02% or less
CD, etc. to Front L/R
(20 Hz to 20 kHz, 65 W, 8 Ω) 0.04% or less
- Signal to Noise Ratio (IHF-A Network)
PHONO (5 mV) to Front L/R
[Australia, U.K. and Europe models] 81 dB or more
[Other models] 86 dB or more
CD, etc. (250 mV) to Front L/R 100 dB or more
- Residual Noise (IHF-A Network)
Front L/R 150 μ V or less
- Channel Separation (1 kHz/10 kHz)
PHONO (shortened) to Front L/R 60 dB/55 dB or more
CD, etc. (5.1 k Ω shortened)
to Front L/R 60 dB/45 dB or more

- Tone Control (Front L/R, Center, Subwoofer)
BASS Boost/Cut \pm 6 dB/50 Hz
BASS Turnover Frequency 350 Hz
TREBLE Boost/Cut \pm 6 dB/20 kHz
TREBLE Turnover Frequency 3.5 kHz
- Zone 2/Zone 3 Tone Control (Front L/R)
BASS Boost/Cut \pm 10 dB/100 Hz
BASS Turnover Frequency 450 Hz
TREBLE Boost/Cut \pm 10 dB/10 kHz
TREBLE Turnover Frequency 2.0 kHz
- Filter Characteristics ($f_c=40/60/80/90/100/110/120/160/200$ Hz)
H.P.F. (Front, Center, Surround, Surround back) 12 dB/oct.
L.P.F. (Subwoofer) 24 dB/oct.

VIDEO SECTION

- Video Format (Gray Back)
[U.S.A., Canada, General and Korea models] NTSC
[U.K., Europe, Australia, Asia and China models] PAL
- Video Format (Video Conversion) NTSC/PAL
- Signal Level
Composite 1 V_{p-p}/75 Ω
S-video 1 V_{p-p}/75 Ω (Y), 0.286 V_{p-p}/75 Ω (C)
Component 1 V_{p-p}/75 Ω (Y), 0.7 V_{p-p}/75 Ω (Pb/P_R)
- Maximum Input Level (Video Conversion Off) 1.5 V_{p-p} or more
- Signal to Noise Ratio (Video Conversion Off) 60 dB or more
- Frequency Response (MONITOR OUT)
Component (Video Conversion Off) 5 Hz to 100 MHz, \pm 3 dB

FM SECTION

- Tuning Range
[U.S.A. and Canada models] 87.5 to 107.9 MHz
[Asia and General models] 87.5/87.50 to 108.0/108.00 MHz
[Other models] 87.50 to 108.00 MHz
- 50 dB Quieting Sensitivity (IHF)
Mono/Stereo 2.0/25 μ V (17.3/39.2 dBf)
- Usable Sensitivity (IHF) 1.0 μ V (11.2 dBf)
- Selectivity (400 kHz) 70 dB
- Signal to Noise Ratio (IHF)
Mono/Stereo 76 dB/70 dB
- Harmonic Distortion (1 kHz)
Mono/Stereo 0.2/0.3%
- Stereo Separation (1 kHz)
Stereo 42 dB
- Frequency Response
Stereo 20 Hz to 15 kHz, +0.5, -2 dB
- Antenna Input (unbalanced) 75 Ω

AM SECTION

- Tuning Range
[U.S.A. and Canada models] 530 to 1710 kHz
[Asia and General models] 530/531 to 1710/1611 kHz
[Other models] 531 to 1611 kHz
- Usable Sensitivity 300 μ V/m

GENERAL

- Power Supply
 - [U.S.A. and Canada models] AC 120 V, 60 Hz
 - [General and Asia models]
 - AC 110/120/220/230–240 V, 50/60 Hz
 - [China model] AC 220 V, 50 Hz
 - [Korea model] AC 220 V, 60 Hz
 - [Australia model] AC 240 V, 50 Hz
 - [U.K. and Europe models] AC 230 V, 50 Hz
- Power Consumption
 - [U.S.A. and Canada models] 500 W/630 VA
 - [Other models] 500 W
- Standby Power Consumption
 - [U.S.A. and Canada models] 0.1 W or less
 - [General model] (AC 240 V, 50 Hz) 0.33 W or less
 - [Other models] 0.1 W or less
- Maximum Power Consumption [General model only]
 - 6ch, 10% THD 1100 W
- AC Outlets
 - [U.S.A. and Canada models] 2 (Total 100 W/0.8 A maximum)
 - [Asia, General and China models] 2 (Total 50 W maximum)
 - [Australia model] 1 (100 W maximum)
 - [U.K. model] 1 (100 W/0.4 A maximum)
 - [Europe model] 2 (Total 100 W/0.4 A maximum)
- Dimensions (W x H x D) 435 x 171 x 438.5 mm
(17-1/8 x 6-3/4 x 17-1/4 in)
- Weight 17.0 kg (37 lbs. 8 oz.)

* Specifications are subject to change without notice.

Index

■ Numerics

1 BASIC MENU, Manual setup	75
2 VOLUME MENU, Manual setup	76
2ch Enhancer, Sound field program	50
2ch Stereo DIRECT, Sound field parameter	72
2ch Stereo, Sound field programs	50
2-channel stereo direct, Sound field parameter	72
3 INPUT MENU, Manual setup	77
3 SOUND MENU, Manual setup	76
4 OPTION MENU, Manual setup	77
7ch Enhancer EFFECT LEVEL	72
7ch Enhancer, Sound field program	50
7ch Stereo CT LEVEL, Sound field parameter	72
7ch Stereo PL LEVEL, Sound field parameter	72
7ch Stereo PR LEVEL, Sound field parameter	72
7ch Stereo SB LEVEL, Sound field parameter	72
7ch Stereo SL LEVEL, Sound field parameter	72
7ch Stereo SR LEVEL, Sound field parameter	72
7ch Stereo, Sound field programs	50
7-channel Compressed Music Enhancer effect level, Sound field parameter	72
7-channel stereo center speaker level, Sound field parameter	72
7-channel stereo presence left speaker level, Sound field parameter	72
7-channel stereo presence right speaker level, Sound field parameter	72
7-channel stereo surround back speaker level, Sound field parameter	72
7-channel stereo surround left speaker level, Sound field parameter	72
7-channel stereo surround right speaker level, Sound field parameter	72
96/24 indicator	34

■ A

A)DISPLAY SET, Option menu	91
A)EQUALIZER, Sound menu	85
A)SPEAKER SET, Basic menu	80
AC OUTLET(S)	32
Action Game, Sound field programs	48
Advanced setup	117
Advanced sound configurations	67
Adventure, Sound field programs	50
ALL CH SEARCH	60
All Channel Search mode, XM tuning	60
AM antenna connection	32
AM tuning	54
AMP, Operation mode selector	36

Audio and video synchronization, Sound menu	87
Audio cable plugs	20
Audio components connection	28
Audio information	44
Audio input jacks selection	43
AUDIO jacks	20
Audio jacks	20
AUDIO SELECT	43
AUDIO SELECT, Initial configuration	94
Audio select, Initial configuration	94
Audio settings, Sound menu	87
Audio signal flow	23
AUTO DELAY, Lip sync	87
Auto delay, Lip sync	87
AUTO indicator	35
AUTO SETUP	37
AUTO setup	75
Auto setup	75
Automatic preset tuning, FM/AM tuning	55
Automatic tuning, FM/AM tuning	54
Available decoders with sound field programs	74

■ B

B)LFE LEVEL, Sound menu	86
B)SP LEVEL, Basic menu	82
BASIC MENU, Manual setup	80
Basic menu, Manual setup	75
Bass cross over, Speaker settings	81
Battery charge indicator	34
BGV, Multi-channel input setup	90
BGV, Multi-channel input setup	90
BI-AMP, Advanced setup	120
Bi-amplifier setting, Advanced setup	120
Blu-ray Disc player connection	25

■ C

C)DYNAMIC RANGE, Sound menu	86
C)MEMORY GUARD, Option menu	93
C)SP DISTANCE, Basic menu	83
C.IMAGE, Decoder parameter	74
Cable plugs	20
CAT SEARCH, XM tuning	60
CD player connection	28
CD recorder connection	28
Cellar Club, Sound field programs	48
CENTER PRE OUT jack connection	29
CENTER SP, Speaker settings	80
Center speaker, Speaker settings	80
CENTER WIDTH, Decoder parameter	74
Chamber, Sound field programs	47
Charge on standby, Dock set	90

Church in Freiburg, Sound field programs	47
CINEMA DSP indicator	35
CLASSICAL, Sound field programs	47
COMPONENT I/P, Display settings	92
Component interlace/progressive up-conversion, Display settings	92
COMPONENT VIDEO jacks	20
Compressed Music Enhancer	50
Connection, AM antenna	32
Connection, Audio components	28
Connection, Blu-ray Disc player	25
Connection, CD player	28
Connection, CD recorder	28
Connection, CENTER PRE OUT jack	29
Connection, DVD player	26
Connection, DVD recorder	27
Connection, External amplifier	29
Connection, External decoder	30
Connection, FM antenna	32
Connection, FRONT PRE OUT jack	29
Connection, HD DVD player	25
Connection, iPod	31
Connection, MD recorder	28
Connection, Multi-format player	30
Connection, Power cable	32
Connection, projector	24
Connection, PVR	27
Connection, Set-top box	27
Connection, SUBWOOFER PRE OUT jack	29
Connection, SUR.BACK/PRESENCE PRE OUT jack	29
Connection, SURROUND PRE OUT jack	29
Connection, turntable	28
Connection, TV monitor	24
Connection, VCR	27
CROSS OVER, Speaker settings	81

■ D

D)INIT. CONFIG	94
D)LIPSYNC, Sound menu	87
D)TEST TONE, Basic menu	83
Decoder descriptions	73
Decoder indicators	35
DECODER MODE, Initial configuration	94
Decoder mode, Initial configuration	94
DECODER MODE, Input menu	89
Decoder mode, Input menu	89
DIALG.LIFT, Sound field parameter	68
DIGITAL COAXIAL jacks	20
DIGITAL OPTICAL jacks	20

DIMENSION, Decoder parameter	74
DIMMER, Display settings	91
Dimmer, Display settings	91
Direct number access mode, XM tuning	61
Display settings, Option menu	91
DIST, Auto setup parameter	38
Drama, Sound field programs	50
DSP indicators	35
DSP LEVEL, Sound field parameter	68
DVD player connection	26
DVD recorder connection	27
Dynamic range, Sound menu	86
■ E	
E)AUDIO SET, Sound menu	87
E)ZONE SET, Option menu	94
Effect sound level, Sound field parameter	68
ENHANCER indicator	35
ENTERTAINMENT, Sound field programs	48
EQ TYPE SELECT, Equalizer	85
EQ, Auto setup parameter	40
Equalizer type select, Equalizer	85
Equalizer, Sound menu	85
EXTD SUR., Initial configuration	94
EXTD SUR., Sound menu	87
Extended surround, Initial configuration	94
Extended Surround, Sound menu	87
External amplifier connection	29
External decoder connection	30
■ F	
F)HDMI SET, Sound menu	88
FL SCROLL, Display settings	92
FM antenna connection	32
FM tuning	54
Front input, Multi-channel input setup	90
Front panel display scroll, Display settings	92
Front panel door	36
FRONT PRE OUT connection	29
FRONT SP, Speaker settings	80
Front speakers, Speaker settings	80
FRONT, Multi-channel input setup	90
■ G	
GEQ, Equalizer	85
Graphic equalizer, Equalizer	85
GRAY BACK, Display settings	91
Gray back, Display settings	91
■ H	
Hall in Amsterdam, Sound field programs	47
Hall in Munich, Sound field programs	47
Hall in Vienna, Sound field programs	47
HD DVD player connection	25

HDMI	21
HDMI ASPECT	93
HDMI aspect ratio	93
HDMI AUTO, Lip sync	87
HDMI auto, Lip sync	87
HDMI indicator	34
HDMI set, Sound menu	88
HDMI video monitor, Advanced setup	120
HEADPHONE, Dynamic range	86
Headphones, Dynamic range	86
HEADPHONE, Low frequency effect level	86
Headphones, Low frequency effect level	86
Headphones	43
Headphones indicator	35
Headphones using	43
HiFi DSP indicator	35
■ I	
I/O ASSIGNMENT, Input menu	89
Infrared window	36
INI.VOL., Audio settings	84
INIT.DLY, Sound field parameter	69
Initial configuration, Option menu	94
Initial delay, Sound field parameter	69
Initial volume, Audio settings	84
INITIALIZE, Advanced setup	120
INPUT CH, Multi-channel input setup	90
Input channel and speaker indicators	34
Input channel indicators	34
Input channels, Multi-channel input setup	90
INPUT MENU, Manual setup	88
Input menu, Manual setup	77
INPUT RENAME, Input menu	89
Input rename, Input menu	89
Input signal indicators	35
Input source indicators	34
Input sources information display	44
Input/output assignment, Input menu	89
iPod connection	31
iPod controlling	64
iPod using	64
■ J	
Jacks	20
■ L	
LEVEL, Auto setup parameter	40
LFE/BASS OUT, Speaker settings	80
LFE/Bass out, Speaker settings	80
Lip Sync, Sound menu	87
LIVE/CLUB, Sound field programs	47
LIVENESS, Sound field parameter	70
Liveness, Sound field parameter	70
Low-frequency effect level, Sound menu	86
LVL, Auto setup parameter	38

■ M	
Macro programming, Remote control	108
MANUAL DELAY, Lip sync	87
Manual delay, Lip sync	87
Manual preset tuning, FM/AM tuning	55
MANUAL SETUP	75
Manual setup	75
Manual tuning, FM/AM tuning	54
MASTER ON/OFF	33
MAX VOL., Audio settings	84
Maximum volume	84
Maximum volume, Audio settings	84
MD recorder connection	28
Memory guard, Option menu	93
MEMORY indicator	35
MONITOR CHECK, Advanced setup	120
Mono Movie, Sound field programs	50
MOVIE, Sound field programs	49
MULTI CH INPUT component selection	43
MULTI CH INPUT jacks	30
Multi-format player connection	30
Multi-channel source playback in 2-channel stereo	53
Multi-channel sources playback with headphones	51
Multi-information display	34
MULTI-ZONE configuration, Zone2, Zone3	111
MUSIC ENHANCER, Sound field category	50
Music Video, Sound field programs	49
MUTE	44
MUTE indicator	34
Muting	44
■ N	
Neo:6 Cinema, Decoder type	73, 74
Neo:6 Music, Decoder type	73
neural indicator	35
Neural-THX., Decoder type	74
Number of speakers, Auto setup parameter	38
■ O	
ON SCREEN, Display settings	91
On-screen display time, Display settings	91
Operation mode selector	36
OPTIMIZER MIC jack	37
Optimizer microphone	37
OPTION MENU, Manual setup	91
Option menu, Manual setup	77
OSD SHIFT, Display settings	91
OSD shift, Display settings	91
Other components controlling by remote control	101
Other components controlling, Remote control	101

■ P

P.INIT.DLY, Sound field parameter	69
P.ROOM SIZE, Sound field parameter	70
PANORAMA, Decoder parameter	74
Parameter initialization, Advanced setup	120
Parametric equalizer information	135
Parametric equalizer type, Auto setup parameter	40
PHONES jack	43
Playback basic procedure	42
PLII Game, Decoder type	73
PLII Movie, Decoder type	73
PLII Music, Decoder type	73
PLIIx Game, Decoder type	73
PLIIx Movie, Decoder type	73, 74
PLIIx Music, Decoder type	73
Power cable connection	32
Presence initial delay, Sound field parameter	69
Presence room size, Sound field parameter	70
PRESENCE SP, Speaker settings	81
Presence speaker indicators	34
Presence speakers, Speaker settings	81
Presence/Surround back channel priority, Speaker settings	82
Preset channel setting, XM tuning	62
Preset Search mode, XM tuning	60
Preset stations exchange, FM/AM tuning	57
Preset stations selection	56
PRIORITY, Speaker settings	82
PRO LOGIC, Decoder type	73
Projector connection	24
PURE DIRECT	52
Pure hi-fi sound	52
PVR connection	27

■ R

RC AMP ID, Advanced setup	118
RC TUNER ID, Advanced setup	118
RC XM ID, Advanced setup	119
Recital/Opera, Sound field programs	49
Remote control AMP ID, Advanced setup	118
Remote control code default settings	102
Remote control codes settings	102
Remote control TUNER ID, Advanced setup	118
Remote control using	36
Remote control XM ID, Advanced setup	119
REMOTE IN jack	31
REMOTE OUT jack	31
REMOTE SENSOR, Advanced setup	117
Remote sensor, Advanced setup	117
Repeat, iPod playback	65
Resetting the system	129

REV.DELAY, Sound field parameter	71
REV.LEVEL, Sound field parameter	71
REV.TIME, Sound field parameter	71
Reverberation delay, Sound field parameter	71
Reverberation level, Sound field parameter	71
Reverberation time, Sound field parameter	71
Roleplaying Game, Sound field programs	48
ROOM SIZE, Sound field parameter	70
Room size, Sound field parameter	70
RS-232C STANDBY, Advanced setup	118

■ S

S VIDEO jacks	20
S.INIT.DLY, Sound field parameter	69
S.LIVENESS, Sound field parameter	70
S.ROOM SIZE, Sound field parameter	70
SB INI.DLY, Sound field parameter	69
SB L/R SP, Speaker settings	81
SB LIVENESS, Sound field parameter	70
SB ROOM SIZE, Sound field parameter	70
Sci-Fi, Sound field programs	49
Selection, Audio input jacks	43
Selection, MULTI CH INPUT component	43
SET MENU usage	79
Set-top box connection	27
Short message display, Display settings	91
SHORT MESSAGE, Display settings	91
Shuffle iPod playback	65
SIGNAL INFO	44
Signal information	78
SILENT CINEMA	51
SILENT CINEMA indicator	35
SLEEP indicator	35
Sleep timer	45
Sound field indicators	35
Sound field parameter changing	67
Sound field programs	46
Sound field programs selection	46
Sound field programs with headphones	51
Sound field programs without surround speakers	51
SOUND MENU, Manual setup	85
Sound menu, Manual setup	76
SOURCE, Operation mode selector	36
SP, Auto setup parameter	38

Speaker distance, Auto setup parameter	38
Speaker distance, Basic menu	83
Speaker distances	83
SPEAKER IMP., Advanced setup	117
Speaker impedance setting	33
Speaker impedance, Advanced setup	117
Speaker level adjusting	53
Speaker level, Auto setup parameter	38
Speaker level, Basic menu	82
Speaker settings, Basic menu	80
SPEAKER, Dynamic range	86
SPEAKER, Low frequency effect level	86
Speakers, Dynamic range	86
Speakers, Low frequency effect level	86
Specifications	136
Spectacle, Sound field programs	49
Sports, Sound field programs	48
Standard, Sound field programs	49
STANDBY CHARGE, Dock set	90
Standby mode, Main zone	33
Standby mode, Zone2, Zone3	113
STEREO indicator	35
STEREO, Sound field programs	50
STRAIGHT	51
Straight Compressed Music Enhancer effect level, Sound field parameter	72
Straight Enhancer EFFECT LEVEL	72
STRAIGHT mode	51
SUBWOOFER PHASE, Speaker settings	82
Subwoofer phase, Speaker settings	82
SUBWOOFER PRE OUT jack connection	29
Supplied accessories	4
SUPPORT AUDIO, HDMI set	88
Support audio, HDMI set	88
SUR. DECODE, Decoder category	73
SUR. L/R SP, Speaker settings	81
SUR.BACK/PRESENCE PRE OUT jack connection	29
Surround back initial delay, Sound field parameter	69
Surround back liveness, Sound field parameter	70
Surround back room size, Sound field parameter	70
Surround initial delay, Sound field parameter	69
Surround left/right back speakers, Speaker settings	81
Surround left/right speakers, Speaker settings	81
Surround liveness, Sound field parameter	70
SURROUND PRE OUT jack connection	29

Surround room size, Sound field parameter	70
System memory	78

■ T

Test tone, Basic menu	83
Test tone, Equalizer	85
TEST, Equalizer	85
The Bottom Line, Sound field programs	48
The Roxy Theatre, Sound field programs	48
Tonal quality adjusting	52
TONE BYPASS, Audio settings	87
Tone bypass, Audio settings	87
Transmit indicator	36
Troubleshooting	121
TUNED indicator	35
Tuner frequency step, Advanced setup	120
TUNER FRQ STEP, Advanced setup	120
Tuner indicators	35
Turning off	33
Turning on	33
Turntable connection	28
TV controlling by remote control	100
TV controlling, remote control	100
TV monitor connection	24
TV, Operation mode selector	36

■ U

UNIT, Speaker distance	83
Unit, Speaker distance	83
Unprocessed input sources	51

■ V

VCR connection	27
Vertical dialogue position, Sound field parameter	68
VIDEO AUX jacks	31
Video cable plugs	20
VIDEO CONV., Display settings	92
Video conversion, Display settings	92
Video information	44
VIDEO jacks	20
Video jacks	20
Video signal flow	23
Video sources in the background	45
Village Vanguard, Sound field programs	47
Virtual CINEMA DSP	51
VIRTUAL indicator	35
VOLTAGE SELECTOR	5
VOLUME level indicator	34
Volume level, Auto setup parameter	40
Volume menu, Manual setup	76
VOLUME TRIM, Input menu	89
Volume Trim, Input menu	89

■ W

Wake on RS-232C access, Advanced setup	118
Warehouse Loft, Sound field programs	47

■ X

XM ANTENNA, XM Radio setting	90
XM Mini-Tuner Dock	58
XM Radio antenna, XM Radio setting	90
XM satellite radio activation	59
XM satellite radio basic operation	59
XM Satellite Radio display	63
XM Satellite Radio information display	63
XM satellite radio tuning	58

■ Y

YPAO indicator	35
----------------------	----

■ Z

Zone set, Option menu	94
ZONE2/ZONE3 indicators	35

“(A)MASTER ON/OFF” or “(1)DVD” (example) indicates the name of the parts on the front panel or the remote control. Refer to the attached sheet or the pages at the end of this manual for the information about each position of the parts.

■ Front panel

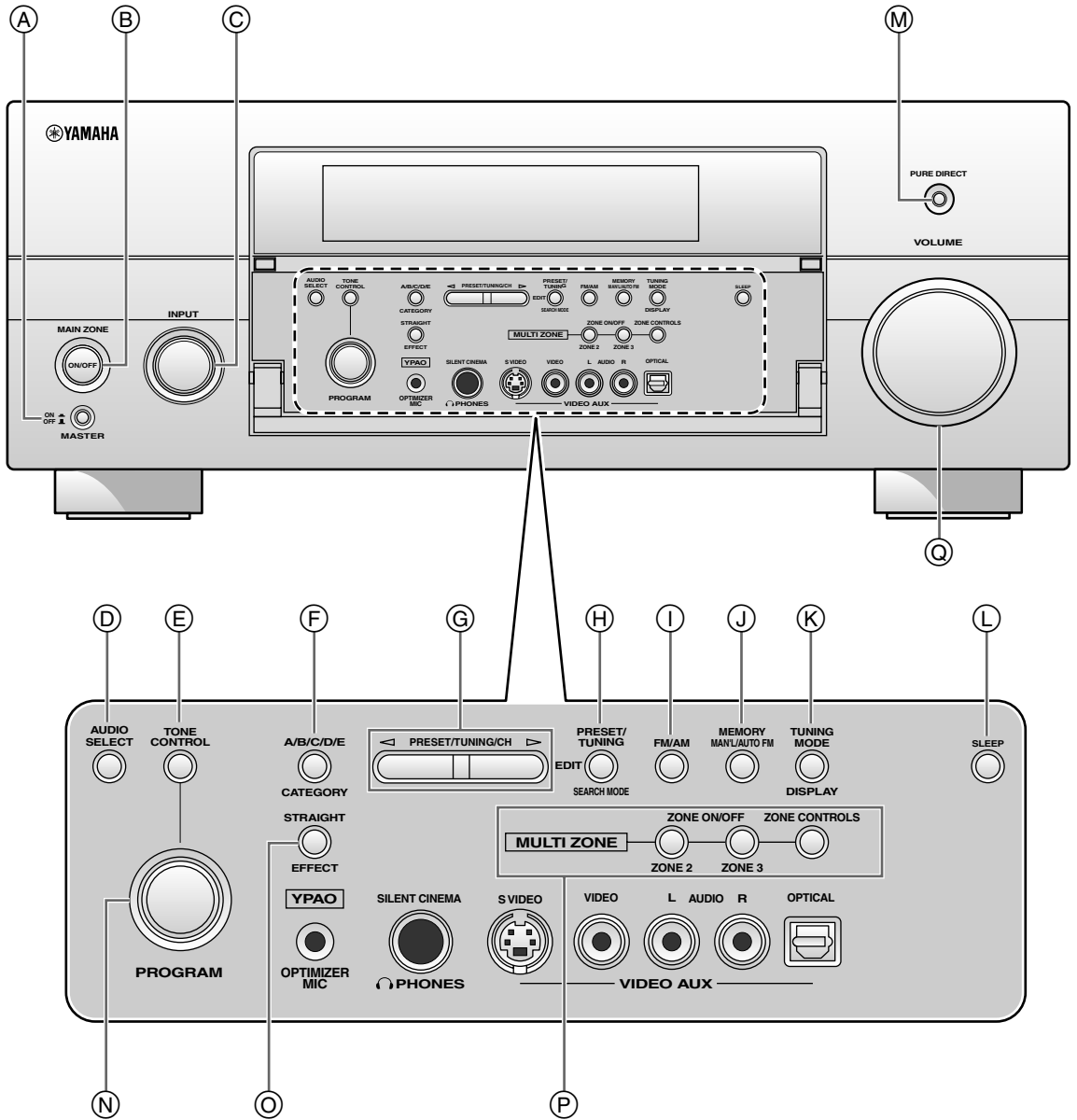

■ Remote control

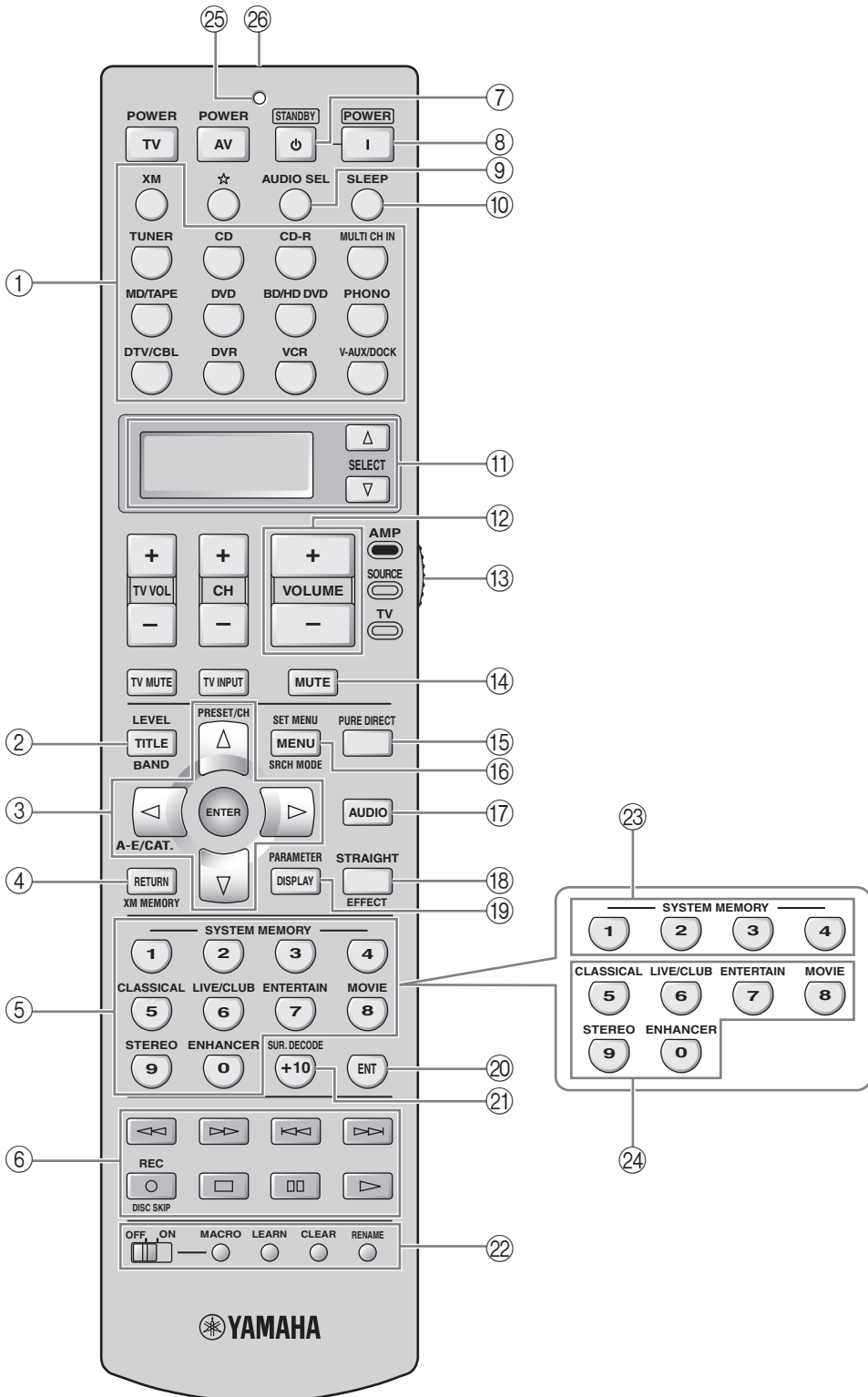

Sound output in each sound field program

- L Front left speaker
- C Center speaker
- R Front right speaker
- SL Surround left speaker
- SR Surround right speaker
- SBL Surround back left speaker
- SBR Surround back right speaker
- PL Presence left speaker
- PR Presence right speaker
- Speaker from which sound is being output
- Speaker from which no sound is being output

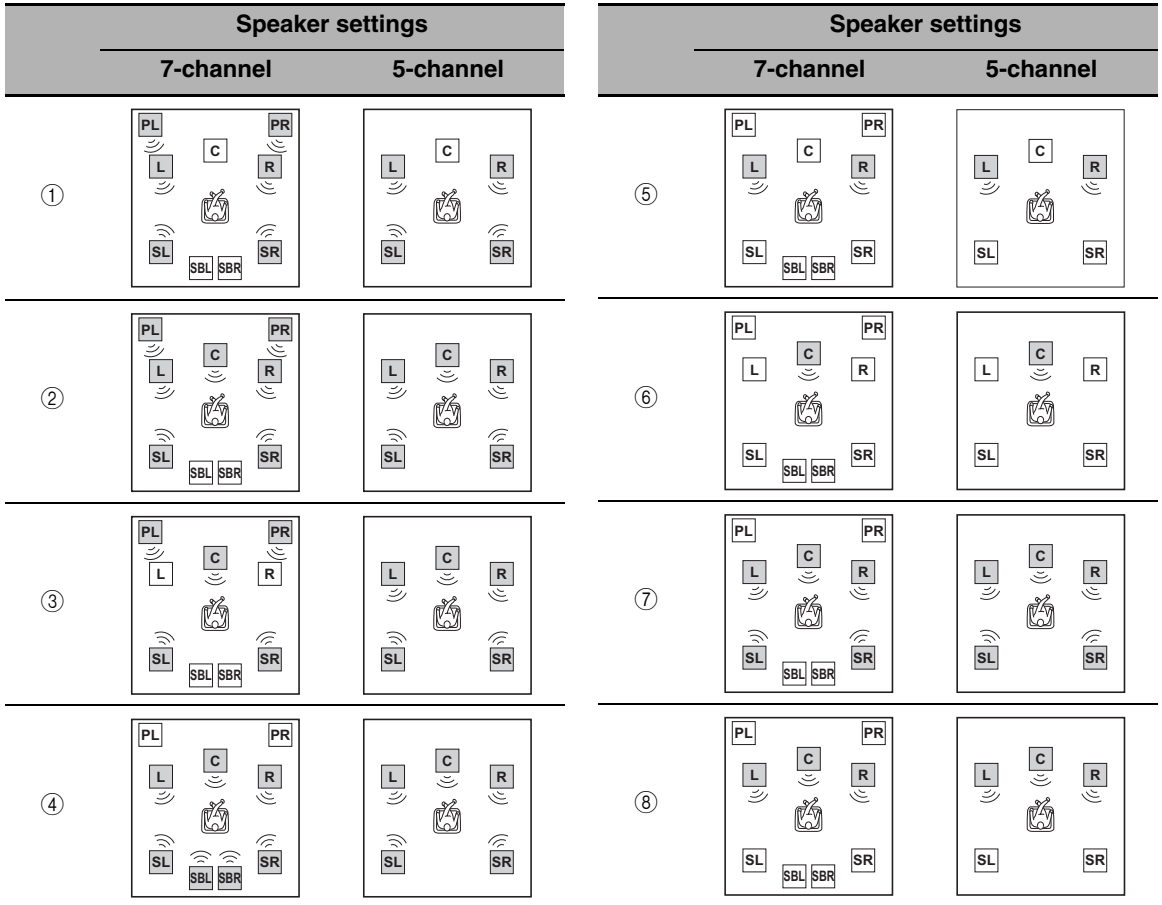

*1 DOLBY DIGITAL EX / DOLBY DIGITAL PL II x / **DTS ES** / **neural**: OFF

*2 DOLBY DIGITAL EX / DOLBY DIGITAL PL II x / **DTS ES** / **neural**: ON or discrete 6.1/7.1-channel audio signals are input.

Program	PRIORITY	Input audio source			
		2-channel (monaural)	2-channel (stereo)	5.1-channel*1	6.1/7.1-channel*2
CLASSICAL Hall in Munich Hall in Vienna Hall in Amsterdam Church in Freiburg Chamber	PRNS	①	①	②	④
	SB				
LIVE/CLUB Village Vanguard Warehouse Loft Cellar Club The Roxy Theatre The Bottom Line		①	①	②	④
ENTERTAINMENT Sports Music Video Recital/Opera Action Game Roleplaying Game	PRNS	③	②	②	④
	SB				
MOVIE STANDARD Spectacle Sci-Fi Adventure Drama		⑦	④	②	④
MOVIE Mono Movie	PRNS	③	②	②	④
	SB	③	②	②	④
STEREO 2ch Stereo	PRNS/SB	⑤	⑤	⑤	⑤
STEREO 7ch Stereo MUSIC ENHANCER 7ch Enhancer	PRNS/SB	④	④	④	④
SUR.DECODE Sur. Decode (Pro Logic) (PLII Movie) (PLII Game)	PRNS/SB	⑥	⑦	⑦	④
SUR.DECODE Sur. Decode (PLII Music)	PRNS/SB	⑧	⑦	⑦	④
SUR.DECODE Sur. Decode (PLIIx Movie) (PLIIx Game) (Neo:6 Cinema) (Neural THX)	PRNS/SB	⑥	④	⑦	④
SUR.DECODE Sur. Decode (PLIIx Music) (Neo:6 Music)	PRNS/SB	⑧	④	⑦	④
STRAIGHT Pure Direct MUSIC ENHANCER Straight Enhancer	PRNS/SB	⑤	⑤	⑦	④

List of remote control codes

CABLE

ABC 0030, 0035
 AMERICAST 0926
 BELL SOUTH 0926
 BIRMINGHAM CABLE COMMUNICATIONS 0303
 BRITISH TELECOM 0030
 CABLE & WIRELESS 1095
 DAERYUNG 0035, 0504, 0904, 1904
 DIRECTOR 0503
 FILMNET 0470
 GENERAL INSTRUMENT 0030, 0303, 0503, 0837,
 GOLDSTAR 0171
 HAMLIN 0036, 0300
 JERROLD 0030, 0303, 0503, 0837
 LG 0171
 MNET 0470
 MEMOREX 0027
 MOTOROLA 0303, 0503, 0837, 1133
 NTL 1095
 NOOS 0844
 ONO 1095
 PVP STEREO VISUAL MATRIX 0030
 PACE 0264, 1087, 1095
 PANASONIC 0027, 0035, 0134
 PARAGON 0027
 PHILIPS 0332, 0344
 PIONEER 0171, 0560, 0904, 1904
 PULSAR 0027
 QUASAR 0027
 REGAL 0300, 0306
 RUNCO 0027
 SAGEM 0844
 SAMSUNG 0027, 0171
 SCIENTIFIC ATLANTA 0035, 0504, 0904, 1904
 SONY 1033
 STARCOM 0030
 SUPERCABLE 0303
 TS 0030
 TELE+1 0470
 TELEWEST 1095
 TORX 0030
 TOSHIBA 0027
 TRANS PX 0303
 UNITED CABLE 0030
 ZENITH 0027, 0552, 0926

CD PLAYER

AIWA 0184
 ARCAM 0184
 AUDIO RESEARCH 0184
 AUDIO TON 0184
 AUDIOLAB 0184
 AUDIOMECA 0184
 CAIRN 0184

CALIFORNIA AUDIO LABS

0056
 CARVER 0184, 0206
 CYRUS 0184
 DKK 0027
 DMX ELECTRONICS 0184
 DENON 0900
 DYNAMIC BASS 0206
 EMERSON 0332
 FISHER 0206
 GENEXXA 0059, 0332
 GOODMANS 0332
 GRUNDIG 0184
 HARMAN/KARDON 0184, 0200
 HITACHI 0059
 JVC 0099
 KENWOOD 0055, 0064
 KRELL 0184
 LXI 0332
 LINN 0184
 MCS 0056
 MAGNAVOX 0184, 0332
 MARANTZ 0056, 0184
 MATSUI 0184
 MEMOREX 0332
 MERIDIAN 0184
 MICROMEGA 0184
 MIRO 0027
 MISSION 0184
 MYRYAD 0184
 NAD 0027
 NSM 0184
 NAIM 0184
 OPTIMUS 0027, 0059, 0064, 0206, 0332
 PANASONIC 0056
 PHILIPS 0184
 PIONEER 0059, 0332
 POLK AUDIO 0184
 PROTON 0184
 QED 0184
 QUAD 0184
 QUASAR 0056
 RCA 0059, 0206, 0332
 REALISTIC 0206
 REVOX 0184
 ROTEL 0184
 SAE 0184
 SANSUI 0184, 0332
 SANYO 0206
 SCOTT 0332
 SEARS 0332
 SHARP 0064
 SIMAUDIO 0184
 SONIC FRONTIERS 0184
 SONY 0027
 SYMPHONIC 0332
 TAG MCLAREN 0184
 TANDY 0059
 TECHNICS 0056
 THORENS 0184
 THULE 0184
 UNIVERSUM 0184
 VICTOR 0099
 WARDS 0184
 Yamaha 2300, 2301

CD RECORDER

KENWOOD 0653
 MARANTZ 0653
 PHILIPS 0653
 Yamaha 2400

DVD PLAYER

ACOUSTIC SOLUTIONS 0757
 ALBA 0744
 AMSTRAD 0740
 APEX DIGITAL 0699, 0744, 0782, 0821, 0823, 0857, 1127
 BLAUPINKT 0744
 BLUE PARADE 0598
 BUSH 0740
 CENTREX 0699
 CLATRONIC 0815
 CYBERHOME 0741
 DVD2000 0548
 DAEWOO 0811, 0797
 DANSAI 0797
 DECCA 0797
 DENON 0517
 DIAMOND 0795
 DIGITREX 0699
 EMERSON 0618
 ENTERPRISE 0618
 FISHER 0697
 GE 0549, 0744
 GO VIDEO 0742
 GOLDSTAR 0768
 GRADIENTE 0678
 GREENHILL 0744
 GRUNDIG 0566
 HITACHI 0600, 0691
 HITEKER 0699
 JVC 0585, 0650
 KLH 0744
 KENWOOD 0517, 0561
 KOSS 0678
 LG 0768
 LIMIT 0795
 MAGNAVOX 0530, 0702
 MARANTZ 0566
 MEMOREX 0858
 MICO 0750
 MICROSOFT 0549
 MINTEK 0744
 MITSUBISHI 0548
 MUSTEK 0757
 NESA 0744
 ONKYO 0530
 ORITRON 0678
 PALSONIC 0699
 PANASONIC 0517, 0659, 1389
 PHILIPS 0530, 0566, 0673, 0881
 PIONEER 0552, 0598, 0658, 0659
 POLK AUDIO 0566
 PROSCAN 0549
 QWESTAR 0678
 RCA 0549, 0598, 0744
 ROTEL 0650

SM ELECTRONIC 0757
 SAMSUNG 0600
 SANYO 0697
 SHARP 0657
 SHERWOOD 0797
 SHINSONIC 0560
 SLIM ART 0811
 SONY 0560, 0891
 SYLVANIA 0702
 TATUNG 0797
 TEAC 0598, 0744
 TECHNICS 0517
 THETA DIGITAL 0598
 THOMSON 0549
 TOSHIBA 0530
 URBAN CONCEPTS 0530
 XBOX 0549
 Yamaha 0517, 0566, 0572, 2100
 ZENITH 0530, 0618, 0768
 ZEUS 0811

HD DVD PLAYER

TOSHIBA 2103

DVD RECORDER

PANASONIC 2800, 2801, 2802
 PHILIPS 2808
 SHARP 2812, 2813
 SONY 2809, 2810, 2811
 Yamaha 2807

Blu-ray Disc player

PANASONIC 2800, 2801, 2802
 SAMSUNG 2816

LD PLAYER

CARVER 0091
 DENON 0086
 MARANTZ 0091
 MITSUBISHI 0086
 NAD 0086
 NAGSMI 0086
 OPTIMUS 0086
 PHILIPS 0091
 PIONEER 0086
 SALORA 0091
 SONY 0228
 TELEFUNKEN 0086
 Yamaha 2200

MD RECORDER

KENWOOD 0708
 ONKYO 0895
 SHARP 0888
 SONY 0517
 Yamaha 2500, 2501, 2502

RECEIVER (TUNER)

ADC 0558
 AIWA 0185, 1116, 1415, 1432, 1668
 ALCO 1417
 ANAM 1636
 APEX DIGITAL 1284
 AUDIOLAB 1216
 AUDIOTRONIC 1216

AUDIOVOX 1417
BOSE 1256
CAMBRIDGE SOUNDWORKS
1397
CAPETRONIC 0558
CARVER 1116, 1216
CENTREX 1284
DENON 1387
FERGUSON 0558
FINE ARTS 1216
GRUNDIG 1216
HARMAN/KARDON
0137, 1331
INTEGRA 0162, 1325
JBL 0137, 1333
JVC 0101, 0558, 1401,
1522
KLH 1417, 1439
KENWOOD 1054, 1340
MCS 0066
MAGNAVOX 0558, 1116, 1216,
1296,
MARANTZ 0066, 1116, 1216,
1316
MICROMEGA 1216
MUSICMAGIC 1116
MYRYAD 1216
NAD 0347
NORCENT 1416
ONKYO 0162, 0869, 1325
OPTIMUS 0558, 1050
PANASONIC 0066, 1315, 1545,
1790
PHILIPS 1116, 1216, 1293,
1295, 1296, 1310,
1316
PIONEER 0041, 0558, 1050,
1411
POLK AUDIO 1316
PROSCAN 1281
QUASAR 0066
RCA 0558, 1050, 1281,
1417, 1636,
SABA 0558
SANSUI 1116
SCHNEIDER 0558
SONY 0185, 1085, 1185,
1685, 1785
STEREOPHONICS 1050
SUNFIRE 1340
TEAC 1417
TECHNICS 0066, 1335, 1336,
1545
TELEFUNKEN 0558
THOMSON 1281
THORENS 1216
UHER 0558
VENTURER 1417
VICTOR 0101
WARDS 0041, 0185
Yamaha 0203, 1203, 1358,
2601
(TUNER ID1) 2602
(TUNER ID2) 2603
(XM ID1) 2604
(XM ID2) 2605
(iPod) 2606

SATELLITE TUNER

@SAT 1327
ABSAT 0150
ALBA 0482
ALPHASTAR 0799
AMSTRAD 0874

ASTON 0169, 1156
ASTRO 0200
ATSAT 1327
AVALON 0423
BLAUPUNKT 0200
BRITISH SKY BROADCASTING
0874, 1202
CANAL DIGITAL 0880
CANAL SATELLITE 0880
CANAL+ 0880
CHAPARRAL 0243
CITYCOM 1203
CONNEXIONS 0423
CROSSDIGITAL 1136
CYRUS 0227
D-BOX 0750, 1154
DMT 1102
DNT 0227, 0423
DAERYUNG 0423
DAEWOO 1323
DIGENIUS 0326
DIRECTV 0274, 0419, 0593,
0666, 0751, 0776,
0846, 1103, 1136,
1169, 1776, 1883
DISH NETWORK SYSTEM
0802, 1032
DISHPRO 0802, 1032
DISTRATEL 0111
DREAM MULTIMEDIA
1264
ECHOSTAR 0194, 0423, 0637,
0802, 0880, 0898,
1032, 1113
ENGEL 1044
EXPRESSVU 0802
FTE 0890
FINLUX 0482
FRACARRO 0898
FUBA 0423
GE 0593
GOI 0802
GALAXIS 0890, 1138
GENERAL INSTRUMENT
0896
GOLD BOX 0880
GRUNDIG 0200, 0874
HTS 0802
HIRSCHMANN 0200, 0423
HITACHI 0482, 0846
HUGHES NETWORK SYSTEM
0776, 1169, 1776
HUMAX 0890, 1203
INVIDEO 0898
JVC 0802
KATHREIN 0150, 0200, 0227,
0276, 0685, 1248
KREISELMEYER 0200
LABGEAR 1323
LOGIX 1044
LORENZEN 0326
MAGNAVOX 0749, 0751
MANHATTAN 0482, 1044,
1110
MARANTZ 0227
MEDIASAT 0880
MEMOREX 0751
METRONIC 0111
MITSUBISHI 0776
MOTOROLA 0896
MYRYAD 0227
NEXT LEVEL 0896
NOKIA 0482, 0750, 0778,
1154, 1250, 1750
OCTALTV 1032

ORBITECH 1127
PACE 0482, 0874, 1202,
1350
PANASONIC 0274, 0728, 0874,
1347
PANDA 0482
PAYSAT 0751
PHILIPS 0160, 0227, 0482,
0749, 0751, 0776,
0880, 1103, 1169,
1776
PIONEER 0880
PROMAX 0482
PROSCAN 0419, 0593
RCA 0170, 0419, 0593,
0882
RFT 0227
RADIOSHACK 0896
RADIOLA 0227
RADIX 0423
SKY 0874, 0883, 1202
SM ELECTRONIC 1227
SABRE 0482
SAGEM 0847, 1141, 1280
SAMSUNG 1044, 1136, 1303,
1319
SAT CONTROL 1327
SATSTATION 1110
SCHWAIGER 1138
SEEMANN 0423
SIEMENS 0200
SONY 0666, 0874, 1666
STAR CHOICE 0896
STRONG 1327
TPS 0847, 1280
TANTEC 0482
TECHNISAT 1126, 1127
TELESTAR 1127
THOMSON 0482, 0880, 1073,
1318
TOPFIELD 1233
TOSHIBA 0776, 0817, 1776
ULTIMATETV 0419, 0666
UNIDEN 0749, 0751
UNIVERSUM 0200
VENTANA 0227
WISI 0200, 0423, 0482
XSAT 0150
ZEHNDER 1102
ZENITH 0883, 1883

TAPE DECK

AIWA 0056
CARVER 0056
GRUNDIG 0056
HARMAN/KARDON
0056
MAGNAVOX 0056
MARANTZ 0056
MYRYAD 0056
OPTIMUS 0054
PHILIPS 0056
PIONEER 0054
POLK AUDIO 0056
RCA 0054
REVOX 0056
SANSUI 0056
SONY 0270
THORENS 0056
WARDS 0054
Yamaha 2700,2701

TV

AGB 0543
AOC 0036, 0057, 0087,
0119, 0120, 0135,
0205, 0207, 0478
0131
ASA
AWA 0036
ACURA 0036
ADDISON 0119, 0135, 0680
ADMIRAL 0120, 0190, 0490
ADVENT 0788
AIKO 0119
AKAI 0036, 0057, 0235,
0388, 0543, 0729,
0839
AKURA 0291
ALBA 0036, 0064, 0398,
0695
AMERICA ACTION 0207
AMPRO 0778
AMSTRAD 0036, 0064, 0198,
0398, 0439, 0460,
0543
ANAM 0036, 0207, 0277
ANAM NATIONAL 0277, 0677
ANITECH 0036
APEX DIGITAL 0775, 0792,
0794
AUDIOSONIC 0064, 0136
BANG & OLUFSEN 0592
BASIC 0036
BAUR 0064, 0388, 0539
BAYSONIC 0207
BEAUMARK 0205
BEKO 0397, 0513, 0741,
0742
BELL & HOWELL 0181
BEON 0064
BLAUPUNKT 0222
BLUE SKY 0695, 1064
BONDSTEC 0274
BRADFORD 0207
BRANDT 0136, 0362
BROKSONIC 0263, 0490
BUSH 0036, 0064, 0398,
0401, 0695, 1064
CCE 0064
CGE 0274
CTC 0274
CXC 0207
CANDLE 0057
CARNIVALE 0057
CARVER 0081, 0197
CASCADE 0036
CATHAY 0064
CELEBRITY 0027
CELERA 0792
CENTURION 0064
CHANGHONG 0792
CHING TAI 0036, 0119
CHUN YUN 0027, 0036, 0119,
0207
CHUNG HSIN 0080, 0135, 0207
CIMLINE 0036
CINERAL 0119, 0478
CITIZEN 0057, 0087, 0119
CLARION 0207
CLARIVOX 0064
CLATRONIC 0274, 0397
CONDOR 0347, 0397
CONRAC 0835

CONTEC	0036, 0207	GRANADA	0064, 0235, 0366, 0543	MAGNADYNE	0274, 0543	PHILIPS	0027, 0057, 0064, 0078, 0081, 0119, 0135, 0205, 0401, 0583, 0717, 1481
CRAIG	0207			MAGNAFON	0543		
CROSLLEY	0081	GRANDIN	0637	MAGNAVOX	0057, 0081, 1281, 1481	PHONOLA	0064
CROWN	0036, 0064, 0207, 0397, 0445	GRUNDIG	0064, 0222, 0514, 0583, 0614	MANESTH	0291, 0347	PILOT	0057
CURTIS MATHES	0057, 0074, 0081, 0087, 0120, 0172, 0181, 0193, 0478, 0729, 1174, 1374	GRUNPY	0207	MARANTZ	0057, 0064, 0081, 0583	PIONEER	0136, 0190, 0193, 0314, 0706, 0787, 0893
DAEWOO	0036, 0057, 0064, 0119, 0135, 0181, 0197, 0205, 0207, 0401, 0478, 0650, 0661, 1688	HCM	0036, 0439	MARK	0064	PORTLAND	0119
DANSAI	0064	HALLMARK	0205	MATSUI	0036, 0064, 0235, 0398, 0514, 0543	PRANDONI-PRINCE	0543
DAYTON	0036	HANKOOK	0057, 0205, 0207	MATSUSHITA	0277, 0677	PRIMA	0788
DE GRAAF	0235, 0575	HANSEATIC	0064, 0347, 0388, 0455, 0583	MEDIATOR	0064	PRISM	0078
DECCA	0064, 0543	HANTAREX	0543	MEDION	0695, 0835, 1064	PROFEX	0036, 0388
DENON	0172	HARMAN/KARDON	0081	MEGATRON	0172, 0205	PROSCAN	0074
DIGATRON	0064	HARVARD	0207	MEMOREX	0036, 0177, 0181, 0205, 0277, 0490, 1064	PROTECH	0036, 0064, 0274, 0291, 0445, 0695
DIXI	0036, 0064	HAVERMY	0120	METZ	0474	PROTON	0036, 0057, 0205
DUMONT	0044	HELLO KITTY	0478	MICROMAXX	0835	PULSAR	0044
DWIN	0747, 0801	HINARI	0036, 0064	MICROSTAR	0835	QUASAR	0078, 0277, 0677
ECE	0064	HISAWA	0482	MIDLAND	0044, 0074, 0078	QUELLE	0064, 0131, 0388, 0539
ELBE	0286	HITACHI	0036, 0057, 0119, 0132, 0136, 0172, 0190, 0205, 0252, 0383, 0508, 0575, 0605, 1172, 1283	MINERVA	0514	R-LINE	0064
ELECTROBAND	0027			MINOKA	0439	RCA	0027, 0057, 0074, 0117, 0119, 0205, 0706, 1074, 1174, 1274, 1374, 1474, 1481, 1574
ELIN	0064, 0575	HUA TUN	0036	MITSUBISHI	0057, 0120, 0135, 0177, 0181, 0205, 0207, 0263, 0277, 0539, 0863, 1277	RFT	0455
ELITE	0347	HUANYU	0401	MIVAR	0318, 0319, 0543, 0636	RADIOSHACK	0057, 0074, 0181, 0205, 0207
ELTA	0036	HYPSON	0064, 0291	MOTOROLA	0120	RADIOLA	0064
EMERSON	0181, 0205, 0207, 0263, 0388, 0490, 0650	ICE	0291, 0398	MULTITECH	0036, 0207	RADIOMARELLI	0543
ENVISION	0057, 0840	INGELEN	0190	MYRYAD	0583	REALISTIC	0057, 0181, 0205, 0207
EPSON	0860	INNO HIT	0543	NAD	0183, 0205, 0388, 0893	REDIFFUSION	0388
ERRES	0064	INNOVA	0064	NEC	0036, 0057, 0078, 0181, 0183, 0197, 0205, 0482, 0524, 1731	REOC	0741
ETHER	0036, 0057	INTEQ	0044	NEI	0064	REVOX	0064
ETRON	0036	INTERFUNK	0064, 0190, 0274, 0388, 0539	NTC	0119	REX	0190, 0286, 0291
EUROPHON	0543	INTERVISION	0064, 0291, 0404	NECKERMANN	0064, 0583	ROADSTAR	0036, 0291, 0445
FERGUSON	0064, 0100, 0136, 0265, 0314, 0362, 0587	JBL	0081	NETSAT	0064	RUNCO	0044, 0057, 0524, 0630
FIDELITY	0388	JCB	0027	NEWAVE	0036, 0119, 0120, 0205	SBR	0064
FINLANDIA	0235, 0373	JVC	0080, 0398, 0490, 0680, 0710	NIKKAI	0064, 0291	SEG	0291, 0695
FINLUX	0064, 0131, 0132, 0373, 0543	JEAN	0036, 0078, 0119, 0183, 0263	NIKKO	0057, 0119, 0205	SEI	0543
FIRSTAR	0036, 0263	JENSEN	0788	NOKIA	0388, 0500, 0507, 0575, 0658	SKY	0064
FIRSTLINE	0036, 0274, 0695	KEC	0207	NORCENT	0775, 0851	SSS	0207
FISHER	0131, 0181, 0235, 0397	KTV	0057, 0207	NORDMENDE	0136, 0314, 0587	SABA	0136, 0190, 0314, 0362
FLINT	0482	KAISUI	0036	OCEANIC	0190, 0388	SACCS	0265
FORMENTI	0064, 0347	KAPSCH	0190	ONWA	0207, 0460	SAGEM	0637
FORTRESS	0120	KARCHER	0637	OPTIMUS	0181, 0193, 0277, 0677	SAISHO	0036, 0291, 0543
FRONTECH	0190, 0274, 0291	KATHREIN	0583	OPTONICA	0120	SALORA	0190, 0380, 0388, 0575
FUJITSU	0710, 0836	KENDO	0064	ORION	0064, 0263, 0347, 0490, 0543	SAMBERS	0543
FUNAI	0207, 0198, 0291	KENWOOD	0057	OSAKI	0291, 0439	SAMPO	0036, 0057, 0119, 0120, 0181, 0198, 0205, 0677, 1782
FUTURETECH	0207	KNEISSEL	0286, 0462	OTTO VERSAND	0064, 0347, 0539, 0583	SAMSUNG	0036, 0057, 0064, 0087, 0117, 0119, 0181, 0205, 0291, 0397, 0583, 0614, 0645, 0729, 0793, 0839, 0841
GE	0057, 0074, 0078, 0119, 0205, 0207, 0478, 0587, 1174, 1374, 1481	KOLIN	0080, 0135, 0207	PALLADIUM	0397, 0445	SANSEI	0478
GEC	0064, 0543	KORPEL	0064	PANAMA	0291	SANSUI	0490
GATEWAY	1782, 1783	KOYODA	0036	PANASONIC	0064, 0078, 0081, 0190, 0277, 0677, 1437	SANYO	0131, 0181, 0207, 0235, 0366, 0826
GELOSO	0036	L&S ELECTRONIC	0835	PERDIO	0347	SCHAUB LORENZ	0388
GENEXXA	0190	LG	0057, 0064, 0087, 0135, 0205, 0741	PHILCO	0057, 0064, 0081, 0172, 0205, 0207, 0274, 0490, 1688	SCHNEIDER	0064, 0274, 0398, 0695
GIBRALTER	0044, 0057	LXI	0074, 0081, 0181, 0183, 0205			SCOTCH	0205
GOLDSTAR	0057, 0064, 0136, 0181, 0205, 0404	LEYCO	0064, 0291			SCOTT	0205, 0207, 0263
GOODMANS	0064, 0398, 0401, 0661	LIESENK & TTER	0064				
GOREMJE	0397	LOEWE	0539				
GRADIENTE	0080, 0197	LUXOR	0383, 0388				
GRAETZ	0190, 0388	M ELECTRONIC	0036, 0064, 0131, 0132, 0136, 0190, 0314, 0373, 0401, 0507				
		MGA	0057, 0177, 0205				
		MTC	0057, 0087, 0539				

SEARS	0074, 0081, 0181, 0183, 0198, 0205	UHER	0347	COMBITECH	0379	KAISUI	0099
SELECO	0190, 0286	UNIVERSUM	0064, 0131, 0132, 0291, 0373, 0397, 0519	CRAIG	0064, 0074, 0099, 0267	KENWOOD	0068, 0094
SEMIVOX	0207			CROWN	0099, 0305	KODAK	0062, 0064
SEMP	0183	VECTOR RESEARCH	0057	CURTIS MATHES	0062, 0068, 0087, 1062	KOLIN	0068, 0070
SHARP	0057, 0120, 0677	VESTEL	0064	CYBERNEX	0267	KORPEL	0099
SHEN YING	0036, 0119	VICTOR	0080, 0277, 0677, 0680	CYRUS	0108	LG	0064, 0069, 0072, 0507
SHENG CHIA	0036, 0120, 0263	VIDEOSAT	0274	DAEWOO	0072, 0131, 0305, 0669, 1305	LXI	0064
SIAREM	0543	VIDIKRON	0081	DANSAI	0099	LENCO	0305
SIEMENS	0064, 0222	VIDTECH	0205	DE GRAAF	0069	LEYCO	0099
SINUDYNE	0543	VIEWSONIC	1782	DECCA	0027, 0108	LLOYD'S	0027
SKANTIC	0383	VISION	0347	DENON	0069	LOEWE	0064, 0108, 1589
SKYGIANT	0207	VOXSON	0190	DUAL	0068	LOGIK	0099, 0267
SKYWORTH	0064	WALTHAM	0383	DUMONT	0027, 0108, 0131	LUXOR	0070, 0075, 0131
SOLAVOX	0190	WARDS	0057, 0081, 0205, 0893	DYNATECH	0027	M ELECTRONIC	0027
SONITRON	0235	WATSON	0064, 0347	ESC	0267, 0305	MEI	0062
SONOKO	0036, 0064	WAYCON	0183	ELCATECH	0099	MGA	0070, 0267
SONOLOR	0190, 0235	WHITE WESTINGHOUSE	0064, 0347, 0490, 0650	ELECTROHOME	0064	MGN TECHNOLOGY	0267
SONTEC	0064	Yamaha	0057, 0172, 0677, 0796, 0860, 2900 (projector), 2901 (projector), 2903, 2904 (projector)	ELECTROPHONIC	0064	MTC	0027, 0267
SONY	0027, 0677, 0861, 1127, 1532, 1678			EMEREX	0059	MAGNASONIC	1305
SOUNDESIGN	0205, 0207			EMERSON	0027, 0062, 0064, 0070, 0072, 0211, 0267, 0305, 1305, 1506	MAGNAVOX	0027, 0062, 0066, 0108, 1808
SOUNDWAVE	0064, 0445			FERGUSON	0068, 0347	MAGNIN	0267
SOWA	0078, 0087, 0119, 0183, 0205			FIDELITY	0027	MANESTH	0072, 0099
SQUAREVIEW	0198			FINLANDIA	0108, 0131	MARANTZ	0062, 0108
STANDARD	0036	YAPSHE	0277	FINLUX	0027, 0069, 0108, 0131	MARTA	0064
STARLITE	0207	YOKO	0064, 0291	FIRSTLINE	0064, 0070, 0072, 0099	MATSUI	0375, 0379
STERN	0190, 0286	ZENITH	0044, 0119, 0205, 0490	FISHER	0074, 0131	MATSUBISHITA	0062
SUPREME	0027			FUJI	0060, 0062	MEDION	0375
SYLVANIA	0057, 0081, 0198			FUJITSU	0027, 0072	MEMOREX	0027, 0062, 0064, 0066, 0074, 0075, 0131, 0267, 0334, 0375, 1264
SYMPHONIC	0198, 0207			FUNAI	0027	MEMPHIS	0099
SYNCO	0027, 0087, 0119, 0120, 0205, 0478			GE	0062, 0087, 0267, 0834, 1062, 1087	METZ	0064, 0374, 1589
SYSLINE	0064			GEC	0108	MINOLTA	0069
T + A	0474			GARRARD	0027	MITSUBISHI	0068, 0070, 0094, 0108, 0834
TCM	0835			GENERAL	0072	MOTOROLA	0062, 0075
TMK	0205			GO VIDEO	0459	MULTITECH	0027, 0099
TNCI	0044			GOLDHAND	0099	MURPHY	0027
TVS	0490			GOLDSTAR	0064, 0252, 0507, 1264	MYRYAD	0108
TACICO	0036, 0119, 0205			GOODMANS	0027, 0064, 0099, 0305	NAD	0131
TAI YI	0036			GRADIENTE	0027	NEC	0062, 0064, 0068, 0075, 0094, 0131
TANDY	0120, 0190			GRAETZ	0068, 0131, 0267	NATIONAL	0253
TASHIKO	0119, 0677			GRANADA	0108, 0131	NECKERMANN	0108
TATUNG	0036, 0064, 0078, 0081, 0087, 0181, 0183, 0543			GRANDIN	0027, 0064, 0099	NESCO	0099
TEAC	0036, 0064, 0291, 0439, 0445, 0482, 0695, 1064			GRUNDIG	0099, 0108, 0253, 0374	NEWAVE	0064
TEC	0274			HCM	0099	NIKKO	0064
TECHNEMA	0347			HI-Q	0074	NOBLEX	0267
TECHNICS	0078, 0277, 0677			HANSEATIC	0064	NOKIA	0068, 0131, 0267
TECHWOOD	0078			HARLEY DAVIDSON	0027	NORDMENDE	0068, 0347
TECO	0036, 0078, 0119, 0120, 0205, 0291, 0680			HARMAN/KARDON	0108	OCEANIC	0027, 0068
TEKNIKA	0081, 0087, 0119, 0177, 0207			HARWOOD	0099	OKANO	0342, 0375
TELEFUNKEN	0136, 0289, 0362, 0652, 0729			HINARI	0099, 0267, 0379	OLYMPUS	0062, 0253
TELEMEISTER	0347			HITACHI	0027, 0064, 0068, 0069, 0267	OPTIMUS	0064, 0075, 0131, 0459
TELETECH	0036			HUGHES NETWORK SYSTEMS	0069	ORION	0211, 0375, 0379, 1506
TENSAI	0347			HYPSON	0099	OSAKI	0027, 0064, 0099
TERA	0057			ITT	0068, 0131, 0267	OTTO VERSAND	0108
THOMSON	0136, 0314, 0587, 0652, 1474			ITV	0064, 0305	PALLADIUM	0064, 0068, 0099
THORN	0064, 0131, 0388, 0539			IMPERIAL	0027	PANASONIC	0062, 0252, 0253, 0643, 1062, 1589
TOSHIBA	0087, 0181, 0183, 0535, 0645, 0677, 0859, 1283, 1383, 1683, 1731			INTERFUNK	0108	PATHE MARCONI	0068
TRIUMPH	0543			JVC	0068, 0072, 0094	PENNEY	0062, 0064, 0069, 0267, 1062, 1264
TUNTEX	0036, 0057, 0119			JENSEN	0068	PENTAX	0069
				KEC	0064, 0305	PERDIO	0027
				KLH	0099	PHILCO	0062
						PHILIPS	0062, 0108, 0645, 1108, 1208
						PHONOLA	0108

VCR

ASA	0064, 0108
ADMIRAL	0075
ADVENTURA	0027
AIKO	0305
AIWA	0027, 0064, 0334, 0375, 0379
AKAI	0068, 0342
AKIBA	0099
ALBA	0099, 0305, 0342, 0379
AMERICA ACTION	0305
AMERICAN HIGH	0062
AMSTRAD	0027
ANAM	0064, 0253, 0267, 0305, 0507
ANAM NATIONAL	0253, 1589
ANITECH	0099
ASHA	0267
ASUKA	0064
AUDIOVOX	0064, 0305
BAIRD	0027, 0068, 0131
BASIC LINE	0099, 0305
BEAUMARK	0267
BELL & HOWELL	0131
BLAUPUNKT	0253
BRANDT	0347
BRANDT ELECTRONIC	0068
BROKSONIC	0211, 0375, 1506
BUSH	0099, 0305, 0379
CCE	0099, 0305
CGE	0027
CALIX	0064
CANON	0062
CARVER	0108
CIMLINE	0099
CINERAL	0305
CITIZEN	0064, 0305, 1305
COLT	0099

PILOT	0064	TELEAVIA	0068
PIONEER	0069, 0094, 0108	TELEFUNKEN	0068, 0347
POLK AUDIO	0108	TENOSAL	0099
PROFITRONIC	0267	TENSAI	0027
PROLINE	0027	THOMAS	0027
PROSCAN	0087, 1087	THOMSON	0068, 0087, 0094,
PROTEC	0099		0347
PULSAR	0066	THORN	0068, 0131
PYE	0108	TIVO	0645, 0663
QUASAR	0062, 1062	TOSHIBA	0068, 0070, 0072,
QUELLE	0108		0094, 0108, 0872
RCA	0062, 0069, 0087,	TOTEVISION	0064, 0267
	0267, 0834, 1062,	UHER	0267
	1087	UNITECH	0267
RADIOSHACK	0027	UNIVERSUM	0027, 0064, 0108,
RADIOLA	0108		0267
RADIX	0064	VECTOR	0072
RANDEX	0064	VICTOR	0068, 0094
REALISTIC	0027, 0062, 0064,	VIDEO CONCEPTS	0072
	0074, 0075, 0131	VIDEOMAGIC	0064
REOC	0375	VIDEOSONIC	0267
REPLAYTV	0641, 0643	VILLAIN	0027
REX	0068	WARDS	0027, 0062, 0069,
ROADSTAR	0064, 0099, 0267,		0074, 0075, 0087,
	0305		0099, 0108, 0267
RUNCO	0066	WHITE WESTINGHOUSE	
SBR	0108		0099
SEG	0267	XR-1000	0027, 0062, 0099
SEI	0108	Yamaha	0068
STS	0069	YAMISHI	0099
SABA	0068, 0347	YOKAN	0099
SALORA	0070	YOKO	0267
SAMPO	0064, 0075	ZENITH	0027, 0060, 0066,
SAMSUNG	0072, 0267, 0459		1506
SANKY	0066, 0075		
SANSUI	0027, 0068, 0094,		
	1506		
SANYO	0074, 0131, 0267		
SAVILLE	0379		
SCHAUB LORENZ	0027, 0068,		
	0131		
SCHNEIDER	0027, 0099, 0108		
SCOTT	0070, 0072, 0211		
SEARS	0027, 0062, 0064,		
	0069, 0074, 0131,		
	1264		
SELECO	0068		
SEMP	0072		
SHARP	0075, 0834		
SHINTOM	0099, 0131		
SIEMENS	0064, 0108, 0131		
SILVA	0064		
SINGER	0072, 0099		
SINUDYNE	0108		
SONIC BLUE	0641, 0643		
SONTEC	0064		
SONY	0027, 0059, 0060,		
	0062, 0663, 1259		
SUNKAI	0375		
SUNSTAR	0027		
SUNTRONIC	0027		
SYLVANIA	0027, 0062, 0108,		
	0070, 1808		
SYMPHONIC	0027		
TMK	0267		
TANDY	0027, 0131		
TASHIKO	0027, 0064		
TATUNG	0027, 0068, 0072,		
	0094, 0108		
TEAC	0027, 0068, 0305,		
	0334, 0669		
TECHNICS	0062, 0253		
TECO	0062, 0064, 0068,		
	0075		
TEKNIKA	0027, 0062, 0064		



© 2007 YAMAHA CORPORATION All rights reserved.

YAMAHA ELECTRONICS CORPORATION, USA 6660 ORANGETHORPE AVE., BUENA PARK, CALIF. 90620, U.S.A.
YAMAHA CANADA MUSIC LTD. 135 MILNER AVE., SCARBOROUGH, ONTARIO M1S 3R1, CANADA
YAMAHA ELECTRONIK EUROPA G.m.b.H. SIEMENSSTR. 22-34, 25462 BELLINGEN BEI HAMBURG, GERMANY
YAMAHA ELECTRONIQUE FRANCE S.A. RUE AMBROISE CROIZAT BP70 CROISSY-BEAUBOURG 77312 MARNE-LA-VALLÉE CEDEX02, FRANCE
YAMAHA ELECTRONICS (UK) LTD. YAMAHA HOUSE, 200 RICKMANSWORTH ROAD WATFORD, HERTS WD18 7GQ, ENGLAND
YAMAHA SCANDINAVIA A.B. J A WETTERGRENS GATA 1, BOX 30053, 400 43 VÄSTRA FRÖLUNDA, SWEDEN
YAMAHA MUSIC AUSTRALIA PTY, LTD. 17-33 MARKET ST., SOUTH MELBOURNE, 3205 VIC., AUSTRALIA

YAMAHA CORPORATION
Printed in Malaysia ◀ WK69280-1

The circled numbers and alphabets correspond to those in the Owner's Manual.
Les nombres et lettres dans un cercle correspondent à ceux du mode d'emploi.

■ **Front panel/Face avant**

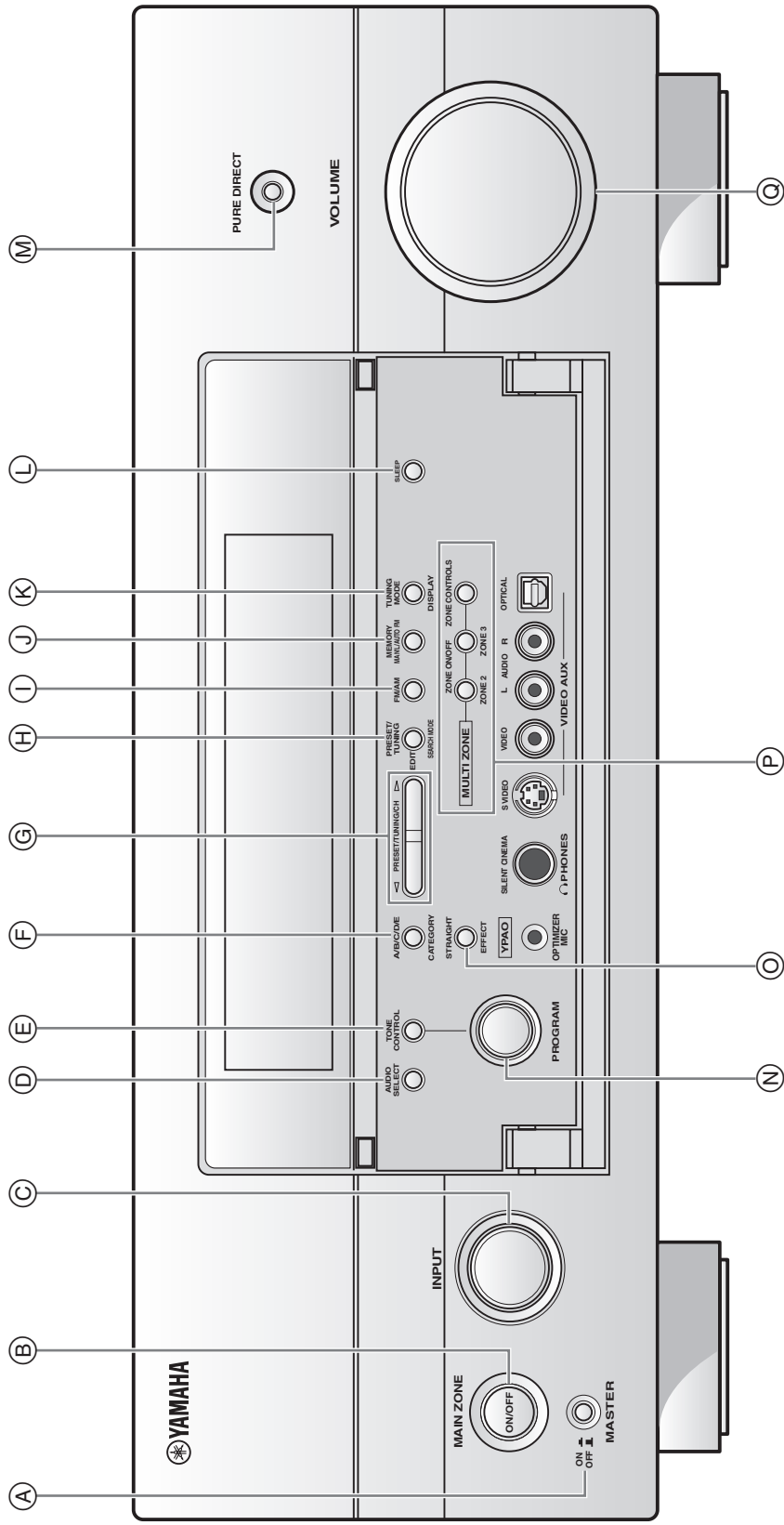

■ Remote control/Boîtier de télécommande

