



YST-SW012

SUBWOOFER SYSTEM



OWNER'S MANUAL

IMPORTANT SAFETY INSTRUCTIONS

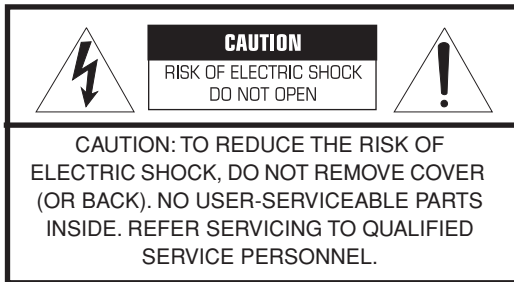

- Explanation of graphic symbols:

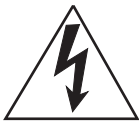

The lightning flash with arrowhead symbol within an equilateral triangle is intended to alert you to the presence of uninsulated "dangerous voltage" within the product's enclosure that may be of sufficient magnitude to constitute a risk of electric shock to persons.



The exclamation point within an equilateral triangle is intended to alert you to the presence of important operating and maintenance (servicing) instructions in the literature accompanying the appliance.

IMPORTANT

Please record the serial number of this system in the space below.

Model:

Serial No.:

The serial number is located on the rear of the unit. Retain this Owner's Manual in a safe place for future reference.

For Canadian Customers

To prevent electric shock, match wide blade of plug to wide slot and fully insert. This Class B digital apparatus complies with Canadian ICES-003.

- 1 Read these instructions.
- 2 Keep these instructions.
- 3 Heed all warnings.
- 4 Follow all instructions.
- 5 Do not use this apparatus near water.
- 6 Clean only with dry cloth.
- 7 Do not block any ventilation openings. Install in accordance with the manufacturer's instructions.
- 8 Do not install near any heat sources such as radiators, heat registers, stoves, or other apparatus (including amplifiers) that produce heat.
- 9 Do not defeat the safety purpose of the polarized or grounding-type plug. A polarized plug has two blades with one wider than the other. A grounding type plug has two blades and a third grounding prong. The wide blade or the third prong are provided for your safety. If the provided plug does not fit into your outlet, consult an electrician for replacement of the obsolete outlet.
- 10 Protect the power cord from being walked on or pinched particularly at plugs, convenience receptacles, and the point where they exit from the apparatus.
- 11 Only use attachments/accessories specified by the manufacturer.
- 12 Use only with the cart, stand, tripod, bracket, or table specified by the manufacturer, or sold with the apparatus. When a cart is used, use caution when moving the cart/apparatus combination to avoid injury from tip-over.
- 13 Unplug this apparatus during lightning storms or when unused for long periods of time.
- 14 Refer all servicing to qualified service personnel. Servicing is required when the apparatus has been damaged in any way, such as power-supply cord or plug is damaged, liquid has been spilled or objects have fallen into the apparatus, the apparatus has been exposed to rain or moisture, does not operate normally, or has been dropped.
- 15 Be sure to allow spaces of at least 20cm above, behind and both sides of the unit.
- 16 Do not place the following objects on the unit:
A vessel with water in it.
If the vessel falls by vibrations and water spills, it may cause damage to the unit, and/or you may get an electric shock.



FCC INFORMATION (for US customers)

1. IMPORTANT NOTICE: DO NOT MODIFY THIS UNIT!

This product, when installed as indicated in the instructions contained in this manual, meets FCC requirements. Modifications not expressly approved by Yamaha may void your authority, granted by the FCC, to use the product.

2. **IMPORTANT:** When connecting this product to accessories and/or another product, use only high quality shielded cables. Cable(s) supplied with this product **MUST** be used. Follow all installation instructions. Failure to follow instructions could void your FCC authorization to use this product in the USA.

3. **NOTE:** This product has been tested and found to comply with the requirements listed in FCC Regulations, Part 15 for Class "B" digital devices. Compliance with these requirements provides a reasonable level of assurance that your use of this product in a residential environment will not result in harmful interference with other electronic devices.

This equipment generates or uses radio frequencies and, if not installed and used in accordance with the instructions in the user's manual, may cause interference harmful to the operation of other electronic devices.

Compliance with FCC regulations does not guarantee that interference will not occur in all installations. If this product is found to be the source of interference, which can be determined by turning the unit "OFF" and "ON," please try to eliminate the problem using one of the following measures:

- Relocate either this product or the device that is being affected by the interference.
- Utilize power outlets that are on different branch circuits (circuit breaker or fuse) or install AC line filter(s).
- In the case of radio or TV interference, relocate or reorient the antenna. If the antenna lead-in is 300 ohm ribbon lead, change the lead-in to a coaxial type cable.

If these corrective measures do not produce satisfactory results, please contact the local retailer authorized to distribute this product. If you cannot locate the appropriate retailer, please contact Yamaha Electronics Corp., U.S.A.; 6660 Orangethorpe Ave; Buena Park, CA 90620.

The above statements apply **ONLY** to those products distributed by Yamaha Corporation of America or its subsidiaries.

For U.K. customers

If the socket outlets in the home are not suitable for the plug supplied with this appliance, it should be cut off and an appropriate 3 pin plug fitted. For details, refer to the following instructions.

Note: The plug severed from the mains lead must be destroyed, as a plug with bared flexible cord is hazardous if engaged in a live socket outlet.

SPECIAL INSTRUCTIONS FOR U.K. MODEL

IMPORTANT:

THE WIRES IN MAINS LEAD ARE COLOURED IN ACCORDANCE WITH THE FOLLOWING CODE:

Blue: NEUTRAL

Brown: LIVE

As the colours of the wires in the mains lead of this apparatus may not correspond with the coloured markings identifying the terminals in your plug, proceed as follows: The wire which is coloured BLUE must be connected to the terminal which is marked with the letter N or coloured BLACK. The wire which is coloured BROWN must be connected to the terminal which is marked with the letter L or coloured RED. Making sure that neither core is connected to the earth terminal of the three pin plug.

We Want You Listening for a Lifetime

Yamaha and the Electronic Industries Association's Consumer Electronics Group want you to get the most enjoyment out of your equipment by playing it at a safe level — a level that lets the sound come through loud and clear without annoying blaring or distortion — and, most importantly, without damaging your sensitive hearing.

Since hearing damage from loud sounds is often undetectable until it is too late, Yamaha and the Electronic Industries Association's Consumer Electronics Group recommend that you avoid prolonged exposure to excessive volume levels.



Precautions: Read this before operating this unit

- To assure the finest performance, please read this manual carefully. Keep it in a safe place for future reference.
- Install this unit in a cool, dry, clean place - away from windows, heat sources, sources of excessive vibration, dust, moisture and cold. Avoid sources of humming (transformers, motors). To prevent fire or electrical shock, do not expose this unit to rain or water.
- Never open the cabinet. If any foreign objects drop into the set, contact your dealer.
- The voltage to be used must be the same as that specified on the rear panel. Using this unit with a higher voltage than specified is dangerous and may cause a fire and/or electric shock.
- To reduce the risk of fire or electric shock, do not expose this unit to rain or moisture.
- Do not use force on switches, controls, or connection wires. When moving the unit, first disconnect the power plug and the wires connected to other equipments. Never pull the wires themselves.
- When not planning to use this unit for a long period (i.e., vacation, etc.), disconnect the AC power plug from the wall outlet.
- Since this unit has a built-in power amplifier, heat will radiate from the rear panel. Place the unit apart from the walls, allowing at least 20 cm of space above, behind and on both sides of the unit to prevent fire or damage. Furthermore, do not position with the rear panel facing down on the floor or other surfaces.
- Do not cover the rear panel of this unit with a newspaper, a tablecloth, a curtain, etc. in order not to obstruct heat radiation. If the temperature inside the unit rises, it may cause fire, damage to the unit and/or personal injury.
- Do not place the following objects on this unit:
Glass, china, small metallic etc.
If glass etc. falls by vibrations and breaks, it may cause bodily injury.
A burning candle etc.
If the candle falls by vibrations, it may cause fire and bodily injury.
A vessel with water in it
If the vessel falls by vibrations and water spills, it may cause damage to the speaker, and/or you may get an electric shock.
- Do not place this unit where foreign objects such as water drips might fall. It might cause a fire, damage to this unit, and/or personal injury.
- Never put a hand or a foreign object into the YST port located on the right side of this unit. When moving this unit, do not hold the port as it might cause personal injury and/or damage to this unit.
- Never place a fragile object near the YST port of this unit. If the object falls or drops by the air pressure, it may cause damage to the unit and/or personal injury.
- Never open the cabinet. It might cause an electric shock since this unit uses a high voltage. It might also cause personal injury and/or damage to this unit.
- When using a humidifier, be sure to avoid condensation inside this unit by allowing enough spaces around this unit or avoiding excess humidification. Condensation might cause a fire, damage to this unit, and/or electric shock.
- Super-bass frequencies reproduced by this unit may cause a turntable to generate a howling sound. In such a case, move this unit away from the turntable.
- This unit may be damaged if certain sounds are continuously outputted at high volume level. For example, if 20 Hz-50 Hz sine waves from a test disc, bass sounds from electronic instruments, etc. are continuously outputted, or when the stylus of a turntable touches the surface of a disc, reduce the volume level to prevent this unit from being damaged.
- If you hear distorted noise (i.e., unnatural, intermittent “rapping” or “hammering” sounds) coming from this unit, reduce the volume level. Extremely loud playing of a movie soundtrack’s low frequency, bass-heavy sounds or similarly loud popular music passages can damage this subwoofer system.
- Vibration generated by super-bass frequencies may distort images on a TV. In such a case, move this unit away from the TV set.
- Do not attempt to clean this unit with chemical solvents as this might damage the finish. Use a clean, dry cloth.
- Be sure to read the “TROUBLESHOOTING” section regarding common operating errors before concluding that the unit is faulty.
- Install this unit near the wall outlet and where the AC power plug can be reached easily.
- **Secure placement or installation is the owner’s responsibility. YAMAHA shall not be liable for any accident caused by improper placement or installation of the subwoofer.**

WARNING

TO REDUCE THE RISK OF FIRE OR ELECTRIC SHOCK, DO NOT EXPOSE THIS UNIT TO RAIN OR MOISTURE.

As long as this unit is connected to the AC wall outlet, it is not disconnected from the AC power source even if you turn off this unit by POWER.

This unit features a magnetically shielded design, but there is still a chance that placing it too close to a TV set might impair picture color. Should this happen, move this unit away from the TV set.

• **VOLTAGE SELECTOR**

(For China, Korea, Asia and General models)

The voltage selector switch on the rear panel of this unit must be set for your local main voltage BEFORE plugging this unit into the AC main supply. Voltages are 110–120/220–240 V AC, 50/60 Hz.

Table of contents

Precautions: Read this before operating this unit	iii
Introduction	2
Features	2
Supplied accessories	2
Positioning the subwoofer	2
Connections	3
Basic connection example	3
Connecting components and the subwoofer to AC power	3
Using the subwoofer	4
Pre-adjusting the subwoofer volume	4
Advanced Yamaha Active Servo Technology II	5
Troubleshooting	6
Specifications	7
Frequency response	7

Introduction

Features

- This subwoofer system employs Advanced Yamaha Active Servo Technology II which Yamaha has developed for reproducing higher quality super-bass sound. (Refer to page 5 for details on Advanced Yamaha Active Servo Technology II) This super bass sound adds a more realistic, theater-in-the-home effect to your stereo system.
- This subwoofer system is equipped with a linear port unique to Yamaha that provides smooth bass response during playback, minimizing extraneous noise not included in the original input signal.

Supplied accessories

Please confirm that the following item is included in the package.

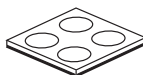

Non-skid pads
(1 set, 4 pieces)

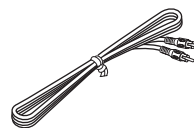

Subwoofer cable
(5 m)

Positioning the subwoofer

It is recommended to place it on the outside of either the right or the left front speaker. (See fig. **A**.) The placement shown in fig. **B** is also possible, however, if the subwoofer system is placed directly facing the wall, the bass effect may lessen because the sound from it and the sound reflected by the wall may cancel out each other. To prevent this from happening, face the subwoofer system at an angle as in fig. **A**.

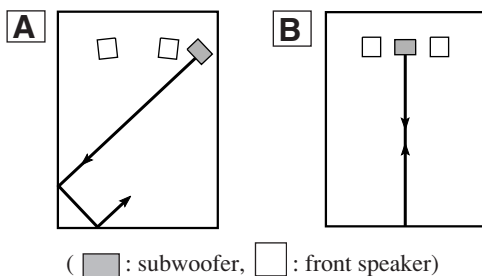

Use the non-skid pads

Put the provided non-skid pads at the four corners on the bottom of the subwoofer to prevent the subwoofer from moving by vibrations etc.

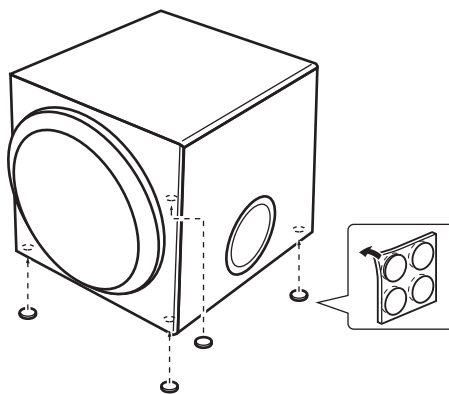

Note

There may be a case that you cannot obtain enough super-bass sounds from the subwoofer when listening in the center of the room. This is because “standing waves” have been developed between two parallel walls and they cancel the bass sounds.

In such a case, face the subwoofer obliquely to the wall. It also may be necessary to break up the parallel surfaces by placing bookshelves etc. along the walls.

Connections

Caution: Plug the power cables for the subwoofer and other audio/video components into an AC outlet only after you complete all other connections.

Basic connection example

Connect a subwoofer cable to the output jack of your AV amplifier and to the INPUT jack of the subwoofer.

Amplifier (The rear panel of various amplifiers may differ in appearance.)

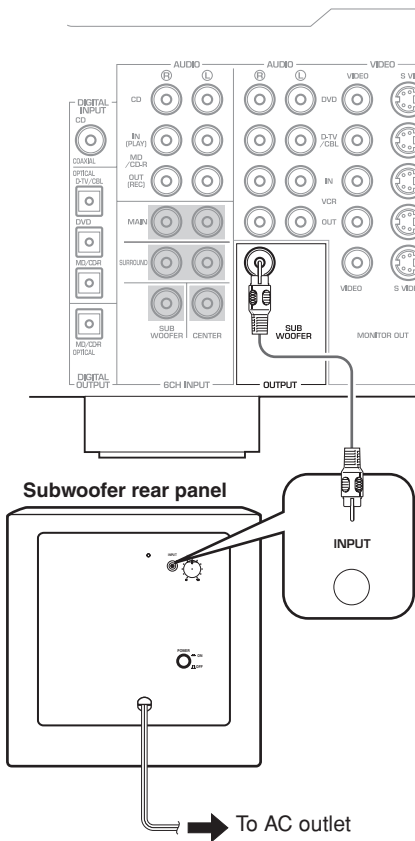

Connecting components and the subwoofer to AC power

After you complete a subwoofer connection, plug the amplifier, other audio/video component, and the subwoofer into an AC outlet of appropriate voltage.

Using the subwoofer

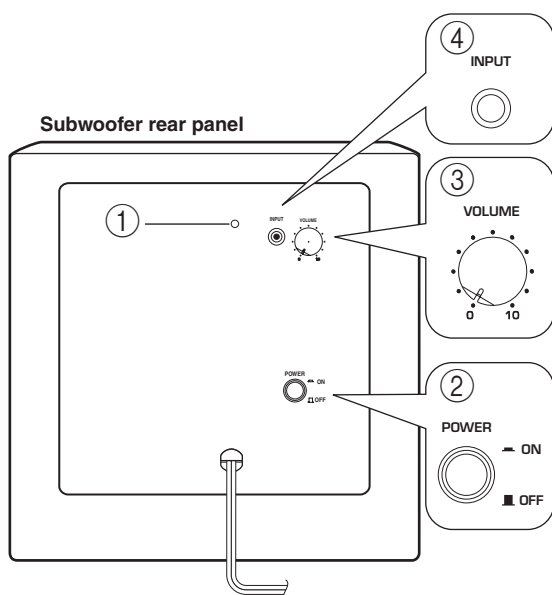

Pre-adjusting the subwoofer volume

Before you use the subwoofer, first adjust the volume balance between the subwoofer and the front speakers by following the procedure below.

1. Set the **VOLUME** control to minimum (0).
2. Turn on the power to all other components.
3. Press the **POWER** switch to the **ON** position. The power indicator on the rear panel lights up in green.
4. Play a source that contains bass signal. Adjust the amplifier's volume control to the desired listening level.
5. Rotate the **VOLUME** control gradually to adjust the volume balance between the subwoofer and the other speakers. To enjoy natural bass sound, keep the subwoofer volume at a level where it is barely distinguishable from other speakers.
6. Adjust the volume of the entire sound system using the amplifier's volume control.

① Power indicator

Lights up in GREEN when the **POWER** switch (②) is turned **ON**; turns off when the **POWER** switch is turned OFF.

② POWER switch

Press this switch to the **ON** position to turn on the power to the subwoofer. When the power of the subwoofer is on, the power indicator (①) on the rear panel lights up in green. Press this switch again to set it to the OFF position to turn off the power of the subwoofer.

③ VOLUME control

Adjusts the volume level. Turn the control clockwise to increase the volume, and counter-clockwise to decrease the volume.

④ INPUT terminal

Input terminal for line level signals from the amplifier.

Note: It is recommended to set the **VOLUME** control about in the middle position when using in a multi channel home theater system.



Advanced Yamaha Active Servo Technology II

In 1998, Yamaha brought to the marketplace speaker systems utilizing YST (Yamaha Active Servo Technology) to give powerful, high quality bass reproduction. This technique uses a direct connection between the amplifier and speaker, allowing accurate signal transmission and precise speaker control.

As this technology uses speaker units controlled by the negative impedance drive of the amplifier and resonance generated between the speaker cabinet volume and port, it creates more resonant energy (the “air woofer” concept) than the standard bass

reflex method. This allows for bass reproduction from much smaller cabinets than was previously possible.

Yamaha’s newly developed Advanced YST II adds many refinements to Yamaha Active Servo Technology, allowing better control of the forces driving the amplifier and speaker. From the amplifier’s point of view, the speaker impedance changes depending on the sound frequency. Yamaha developed a new circuit design combining negative-impedance and constant-current drives, which provides a more stable performance and clear bass reproduction without any murkiness.

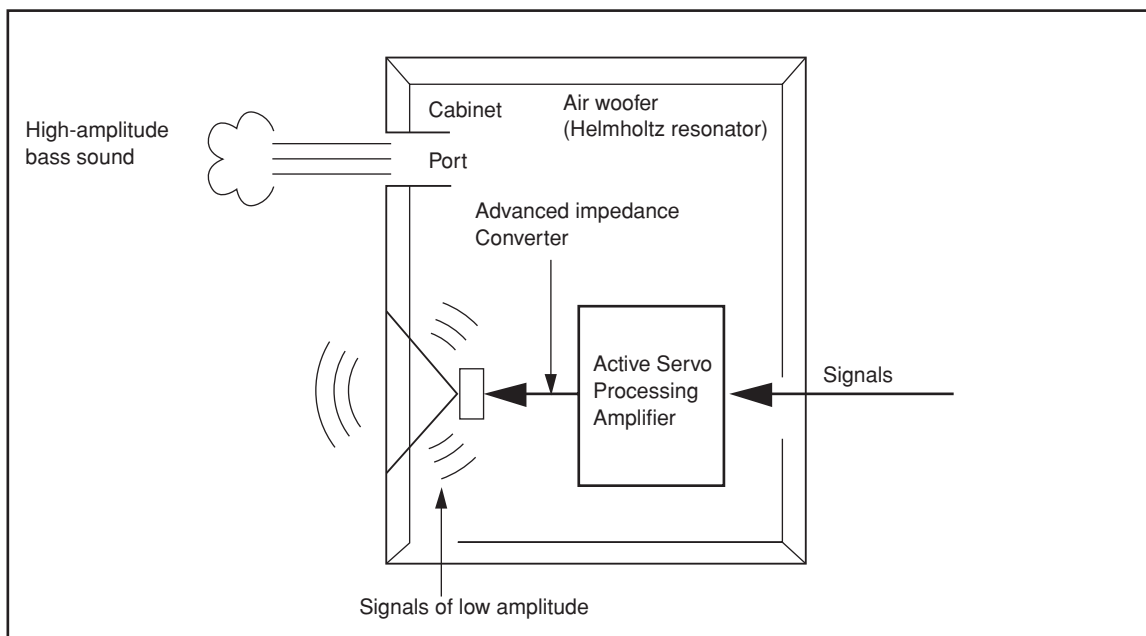

Troubleshooting

Refer to the chart below if the unit does not function properly. If the problem you are experiencing is not listed, or if the instructions fail to help you resolve the problem, disconnect the power cord and contact your authorized Yamaha dealer or service center.

Problem	Cause	Remedy
Power is not supplied even though the POWER switch is set to the ON position.	The power plug is not securely connected.	Turn the power switch OFF, then connect the power plug securely.
No sound.	The VOLUME control is set to 0.	Turn the VOLUME control to the right (clockwise).
	A subwoofer cable is not connected securely.	Connect a subwoofer cable securely.
Sound level is too low.	You are playing a sound source that includes inadequate bass frequencies.	Play a sound source that includes more bass frequencies.
	The sound level has been diminished by standing waves.	Reposition the subwoofer, or break up the parallel wall surface by placing bookshelves or other large objects along the wall.
	The input signal is too small	Turn up the volume.

Specifications

TypeAdvanced Yamaha Active Servo Technology II

Driver 20 cm (8") cone woofer
Magnetically shielded type

Output Power 50 W

Dynamic Power 100 W, 5 Ω

Input Impedance 12 k Ω

Frequency Response 28 Hz – 200 Hz

Input Sensitivity 50 mV (50 Hz, 50 W/5 Ω)

Power Supply

[U.S.A. and Canada models] AC 120 V, 60 Hz

[Australia model] AC 240 V, 50 Hz

[U.K. and Europe models] AC 230 V, 50 Hz

[China, Korea, Asia and General models]

..... AC 110–120/220–240 V, 50/60 Hz

Power Consumption 45 W

Dimensions (W x H x D)

.....290 mm x 290 mm x 328 mm
(11-13/32" x 11-13/32" x 12-29/32")

Weight 8.5 kg (18-3/4 lbs.)

Frequency response

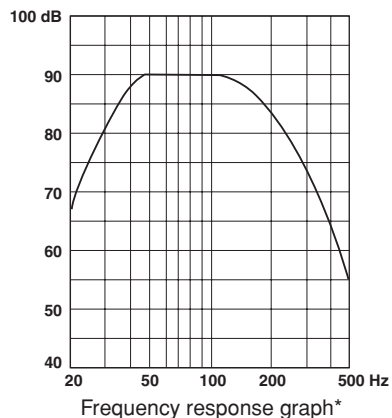

*This diagram does not depict actual frequency response characteristics accurately.

Specifications are subject to change without notice.



©2006 YAMAHA CORPORATION All rights reserved.

YAMAHA ELECTRONICS CORPORATION, USA 6660 ORANGETHORPE AVE., BUENA PARK, CALIF. 90620, U.S.A.
YAMAHA CANADA MUSIC LTD. 135 MILNER AVE., SCARBOROUGH, ONTARIO M1S 3R1, CANADA
YAMAHA ELECTRONIK EUROPA G.m.b.H. SIEMENSSTR. 22-34, 25462 RELLINGEN BEI HAMBURG, GERMANY
YAMAHA ELECTRONIQUE FRANCE S.A. RUE AMBROISE CROIZAT BP70 CROISSY-BEAUBOURG 77312 MARNE-LA-VALLEE CEDEX02, FRANCE
YAMAHA ELECTRONICS (UK) LTD. YAMAHA HOUSE, 200 RICKMANSWORTH ROAD WATFORD, HERTS WD18 7GQ, ENGLAND
YAMAHA SCANDINAVIA A.B. J A WETTERGRENS GATA 1, BOX 30053, 400 43 VÄSTRA FRÖLUNDA, SWEDEN
YAMAHA MUSIC AUSTRALIA PTY, LTD. 17-33 MARKET ST., SOUTH MELBOURNE, 3205 VIC., AUSTRALIA

YAMAHA CORPORATION
Printed in China ◀ WG56940