



RX-V867

AV Receiver

Owner's Manual

English for U.S.A.

CONTENTS

INTRODUCTION

Features and capabilities	4
Using the TV OSD to operate the unit	5
View or modify content for the current input source <Content window>	5
Configuring settings for this unit <ON SCREEN menu>.....	5
Adjust settings for each input source <Option menu>.....	6
About this manual.....	7
Supplied accessories.....	7
Part names and functions	8
Front panel.....	8
Rear panel.....	9
Front panel display	10
Remote control	11
On-screen display	12

CONNECTIONS

Connecting speakers	13
Speaker channels and functions.....	13
Speaker layout	14
Connecting speakers and subwoofers.....	17
Connecting external components	21
Jacks and cables.....	21
Connecting a TV monitor.....	22
Connecting BD/DVD players and other devices	25
Connecting game consoles	29
Connecting a multi-format player or an external decoder	29
Connecting an external amplifier	30
Connecting a SCENE link playback-compatible device	30
Using the Trigger function to link external component power.....	31
Connecting audio/video recording devices.....	31
Connecting to the network.....	32

Connecting the FM/AM antennas	33
Setting up the speaker parameters automatically (YPAO)	34

PLAYBACK

Basic playback procedure	42
Changing input settings with a single key (SCENE function)	44
Registering input sources/sound program/ HDMI OUT	44
Enjoying favorite sound field effect	44
Selecting sound programs and sound decoders.....	44
Sound programs.....	48
Using the TV display to control this unit	50
Basic operations via the TV screen display	50
Configuring settings specific to an individual input source (Option menu)	52
Option menu display and setup	52
Option menu.....	53
Confirming and operating input sources from the Content window	56
Displaying the Content window on the TV screen.....	56
Switching the display between the Now Playing view and the Browse view	56
FM/AM tuning	57
Selecting a frequency for reception (Normal tuning).....	57
Navigating the FM/AM tuner from the Content window.....	59

Listening to SIRIUS Satellite Radio™	61
Connecting the SiriusConnect™ tuner	61
Activating SIRIUS Satellite Radio™ subscription	62
SIRIUS Satellite Radio™ operations.....	62
Registering and recalling the SIRIUS Satellite Radio™ channels.....	63
Displaying the SIRIUS Satellite Radio™ information ..	64
Navigating the SIRIUS Satellite Radio™ from the Content window	65
Playing back tunes on the PC	67
Windows Media Player setup.....	67
Playback of PC music contents.....	67
Listening to the Internet Radio	69
Listening to Internet Radio	69
Using the Rhapsody® service	71
Rhapsody® account sign-in.....	71
Playback of Rhapsody® contents.....	72
Listening to the SIRIUS Internet Radio	75
SIRIUS Internet Radio account sign-in	75
Navigating the SIRIUS Internet Radio menu	76
Using shortcut function	78
Playing back tunes from your iPod™/iPhone™	79
Connecting the Universal Dock for iPod	79
Controlling an iPod™/iPhone™	79
Playing iPod/iPhone from the menu screen (Menu browse control).....	80
Operating basic playback functions via the remote control (Simple remote control)	81
Playing iPod™/iPhone™ with wireless connection	81
Playing back tunes from Bluetooth™ components	83
Connecting a Yamaha Bluetooth wireless audio receiver.....	83
Pairing Bluetooth™ components	83
Using Bluetooth™ components	84
Changing the friendly name of this unit by using the web browser	85

SETUP

Configuring input sources (Input menu)	86
Configuring input sources	86
Input menu	87
Editing the SCENE function (SCENE menu)	90
Editing a scene	90
SCENE menu	91
Setting sound program parameters (Sound Program menu)	93
Editing sound programs	93
CINEMA DSP parameters	94
Parameters usable in certain sound programs	96
Parameters usable in surround decoder	97
Setting various functions (Setup menu)	98
Operating the Setup menu	98
Setup menu	99
Manages settings for speakers	99
Setting the audio output function of this unit	103
Setting this unit's video output function	104
Setting HDMI functions	105
Adjusting this unit's network parameters	108
Setting this unit's multi-zone function	109
Making the receiver easier to use	109
Language	112
Confirming information of this unit (Information menu)	113
Selecting information	113
Controlling other components with the remote control	115
Keys connecting external components	115
Default remote control code settings	116
Registering remote control codes for external component operations	116
Resetting all remote control codes	117

Extended functionality that can be configured as needed (Advanced Setup menu)	118
Displaying/Setting the Advanced Setup menu	118
Setting the impedance of speakers	118
Avoiding crossing remote control signals when using multiple Yamaha receivers	119
Resetting the SIRIUS Satellite Radio™ parental lock code	119
Changing TV format	120
Removing HDMI video output up-scaling limits	120
Initializing various settings for this unit	120
Firmware update	120
Firmware version	120
Using the HDMI Control function	121
Using multi-zone configuration	125
Connecting Zone2	125
Controlling Zone2	126
Using the party mode	126

APPENDIX

Troubleshooting	127
General	127
HDMI™	129
Tuner (FM/AM)	130
SIRIUS Satellite Radio™	130
Network	131
iPod™/iPhone™	132
Bluetooth™	133
Remote control	133
Glossary	134
Audio information	134
Sound program information	135
Video information	136
Video conversion	136

Information on HDMI™	137
About trademarks	138
Specifications	139
Index	141

INTRODUCTION

Features and capabilities

■ Built-in high-quality, high-power 7-channel amplifier	
■ 6 HDMI input jacks (5 + 1 VIDEO AUX) supporting Audio Return Channel and 3D video signal	
■ 2 HDMI output jacks	
– Selecting the HDMI OUT jack	42
■ 1-button input/sound program switching (SCENE function).....	44
■ Speaker connections for 2- to 7.1-channel configurations	
– Speaker impedance configuration	18
– Speaker channels and functions	13
– Speaker layout.....	14
– Speaker cable connection.....	17
– Subwoofer cable connection	20
– High quality playback using bi-amplification connections	18
■ Automatic settings for speaker acoustic parameters (YPAO - Yamaha Parametric Room Acoustic Optimizer)	34
■ External component connection (max. 16 inputs) and playback	
– External component connection.....	21
– Protective cover for front panel jacks	7
– Configuring the settings specific for each input source <Option menu>	52
– Playback from external components.....	42
– Playback from an iPod/iPhone with wired connection	80
– Playback from an iPod/iPhone with wireless connection.....	81
– Playback from a Bluetooth component (Bluetooth and components sold separately)	83
■ FM/AM tuner	
– Receiving an FM/AM broadcast	57
– Presetting stations	57
– Simple preset tuning	57
– Changing Audio mode (Auto/Mono).....	59
■ SIRIUS Satellite Radio™	
– Receiving a channel	62
– Presetting channels	63
– Displaying information	64
■ Playback and control via network	
– Playback of music on the PC and DLNA server.....	67
– Internet radio service playback.....	69
– Control this unit via network (Web Browser Control).....	85
■ Multi-channel, multi-format playback	
– Sound field effect selection.....	44
– Playback without sound field effects	45
– Stereo playback	45
– Compressed-music playback	47
■ Front panel information display/on-screen display (OSD) on the TV screen	
– Switching information on the front panel display	10
– Operating this unit using the on-screen display.....	12
■ Volume adjustment functions	
– Easy listening at low volumes < Adaptive DRC>	54
– Adjusting volume between input sources <Volume Trim>	55
■ Remote control operation	
– External component operation with this unit’s remote control.....	115
■ Playing back the audio source in another room	
– Using the internal amplifier for playback	18
– Using the external amplifier for playback	125
– Configuring the settings for another room.....	125
– Controlling the external component in another room.....	126
■ Other features	
– Standby mode after a specific amount of time <Sleep timer>.....	11
– Charging the iPod/iPhone when this unit is in standby mode <iPod Standby Charge>.....	89

Most of this unit’s functions can be operated by following instructions displayed on the TV screen. Refer to “Using the TV OSD to operate the unit” on the following pages for information on functions that can be controlled using the on-screen display.



Using the TV OSD to operate the unit

This unit features a sophisticated on-screen display (OSD) for the TV screen. The OSD is designed to enable visual guidance that simplifies operations. The OSD mainly displays the ON SCREEN and Option menus, as well as the Content window that displays the content of current input sources.

■ Select an input source, SCENE and sound program

- Select an input source50
- Select a SCENE51
- Select a sound program51

View or modify content for the current input source <Content window>

■ Operate the AM/FM tuner or SIRIUS Satellite Radio

- Display a list of preset stations/channels for selection60, 66
- Display information on the station/channel currently received59, 65
- Perform operations such as searching for and registering stations/channels using the Utility <Utility>.....59, 65

■ Display the list of iPod music sources

- Display the list of iPod music sources for selection80
- Perform operations such as play, stop and pause using the TV screen <Menu browse control>80

Configuring settings for this unit <ON SCREEN menu>

■ Configure an input source

- Select an input source50
- Play the audio/video signal from the selected input source.....42
- Change the input source name <Rename/Icon Select>88
- Select the audio input jack separately from the video input jack <Audio In>.....88
- Specify a format for digital audio signals <Decoder Mode>.....88
- Enhance the sound of compressed audio <Enhancer>.....89
- Output a video signal input from another input source while playing a multi-channel audio signal <Video Out>89
- Charge the iPod/iPhone when this unit is in standby mode <Standby Charge>.....89

■ Customize a SCENE

- Register or clear settings for a selected SCENE <Save>, <Reset>91
- Turn on a Yamaha BD/DVD player or CD player connected to this unit automatically when a SCENE is selected <SCENE IR>.....91

■ Adjust a sound program (sound program)

- Adjust sound program parameters93

■ Display settings information for this unit

- Display audio signal information <Audio Signal> 113
- Display video signal information <Video Signal> 113
- Display HDMI signal information <HDMI - Monitor Info.>..... 113

■ Adjust acoustic parameters to match your speakers and listening environment

- Specify speaker acoustic parameters automatically (Yamaha Parametric Room Acoustic Optimizer - YPAO).....34
- Set up this unit's speaker configuration simply <Power Amp Assign>99
- Specify settings for each speaker <Configuration>100
- Control volume control for each speaker <Level>101
- Apply speaker distance settings <Distance>101
- Control equalizer sound quality <Parametric EQ>.....102
- Adjust test tone speaker <Test Tone>102

■ Adjust audio signals output from this unit

- Correct lag between audio and video signals <Lipsync>103
- Select a dynamic range adjustment method <Dynamic Range>103
- Specify the maximum volume <Max Volume>103
- Specify the initial volume <Initial Volume>.....104
- Adjust DSP effect and volume level <Adaptive DSP Level>104

■ Adjust video signals output from this unit

- Convert analog video signal to another type of signal <Analog to Analog Conversion>104
- Specify the resolution and aspect ratio of analog video signal converted to HDMI or specify upscaling resolution for 480i/576i- or 480p/576p-HDMI output signal <Processing>.....105

■ HDMI settings

- Assign the audio input source for the TV <TV Audio Input>106
- Listen to TV audio with HDMI cable connection <ARC (Audio Return Channel)>.....106
- Transmit HDMI audio/video to the TV during standby mode <Standby Through>107
- Change the output destination of HDMI input audio signals <Audio Output>.....107



■ Network settings

- Set the IP address of this unit <IP Address>108
- Accept the commands via LAN network when this unit is in the standby mode
 <Network Standby>108
- Set the mac address filter for this unit <MAC Address Filter>108

■ Enable listening in multiple rooms (multi-zone function)

- Adjust Zone2 volume <Zone2 Set>109
- Rename each zone <Zone Rename>109

■ Specify other functions for this unit

- Enter standby mode automatically when no operations are performed <Auto Power Down>110
- Adjust the brightness of the front panel display <Dimmer>110
- Change the wall paper displayed on the TV screen <Wall Paper>110
- Specify the function of the TRIGGER OUT jack for controlling external components
 <Trigger Output>111
- Prohibit changes to settings <Memory Guard>112

■ Select a language



- Change the language displayed on the TV screen <Language>112





Adjust settings for each input source <Option menu>

- Select the 5.1-channel signal playback method <Extended Surround>55
- Adjust bass and treble levels <Tone Control>54
- Enable low-volume background music <Adaptive DRC>54
- Adjust the volume of input sources <Volume Trim>55
- Adjust the vertical position of dialogues <Dialogue Lift>54



About this manual

- Some features are not available in certain regions.
- This manual is created prior to production. Design and specifications are subject to change in part as a result of improvements, etc. In case of differences between the manual and product, the product has priority.
- “**4**HDMI” (example) indicates the name of the parts on the remote control. Refer to the “Remote control” (p. 11) for the information about each position of the parts.
-  1 indicates that the reference is in the footnote. Refer to the corresponding numbers on the bottom of the page.
-  indicates the page describing the related information.
- Click on the “” at the bottom of the page to display the corresponding page in “Part names and functions.”

-  Front panel
-  Rear panel
-  Front panel display
-  Remote control

Supplied accessories

Check that you received all of the following parts.

- Remote control
- Batteries (AAA, R03, UM-4) x 2
- YPAO microphone
- AM loop antenna
- Indoor FM antenna
- VIDEO AUX input cover

■ Attaching the VIDEO AUX input cover (supplied)

To protect against dust, attach the supplied VIDEO AUX input cover to the VIDEO AUX jacks when you do not use the jacks. To remove the cover, push the left section of it.

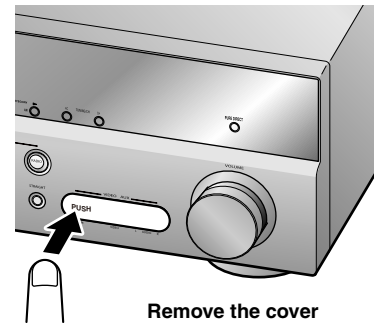
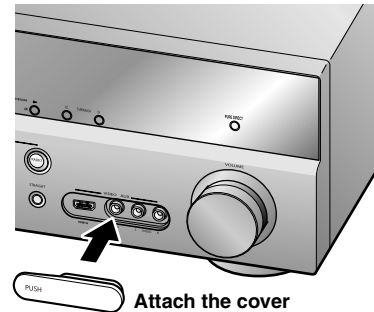

■ Installing batteries in the remote control

When inserting batteries in the remote control, remove the battery compartment cover from the reverse side of the remote control, and insert two AAA batteries into the battery compartment so that they match with the polarity markings (+ and -).

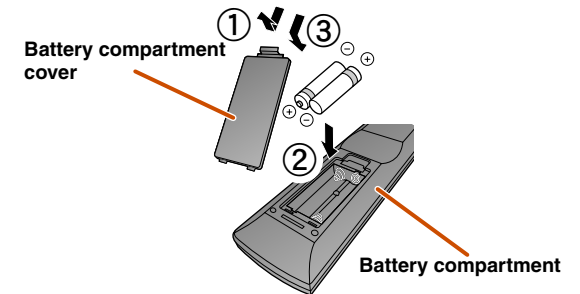

Replace the batteries with new ones if the remote control can only be operated within a narrow range.

NOTE

If there are remote control codes for external components registered to the remote control, removing the batteries for more than 2 minutes, or leaving exhausted batteries in the remote control, may clear the remote control codes. If this should occur, replace the batteries with new ones, and set the remote control codes.

Part names and functions

Front panel

① MAIN ZONE \odot (Power)

Switches this unit between on and standby mode.

② HDMI Through/iPod Charge indicator

Lights up in any of the following cases while the unit is in standby mode.

- When the Standby Through function is enabled and audio/video from an external component connected with HDMI is output to a TV during standby mode ([p. 107](#)).
- When an iPod/iPhone, which is placed in the Universal Dock for iPod, is charging while the unit is in standby mode ([p. 81](#)). This indicator also lights up when the Yamaha Wireless System for iPod is connected to this unit ([p. 81](#)).
- When the Network Standby function is enabled. This function allows this unit to be turned on by receiving a command over a network ([p. 108](#)).

③ ZONE2

Switches to enable/disable the audio output to Zone2 ([p. 126](#)).

④ ZONE CONTROL

Switches to Zone2 operation mode. This unit, or its remote control, can be used to select input sources or adjust volume for an external amplifier in another room or the built-in amplifier for speakers in another room ([p. 126](#)).

⑤ INFO

Changes the information displayed on the front panel display ([p. 10](#)).

⑥ MEMORY

Registers FM/AM stations as preset stations ([p. 57](#)) or SIRIUS channels as preset channels ([p. 63](#)). 

⑦ PRESET </>

Selects an FM/AM preset station ([p. 59](#)) or a SIRIUS preset channel ([p. 64](#)). 

⑧ FM/AM (CATEGORY </>)

Sets the FM/AM tuner band to FM or AM ([p. 57](#)). 
Selects a channel category for a SIRIUS ([p. 63](#)).

⑨ Front panel display

Displays information on this unit ([p. 10](#)).

⑩ TUNING/CH <</>>

Changes FM/AM tuner frequencies ([p. 57](#)) or SIRIUS Satellite Radio channels ([p. 63](#)). 

⑪ PURE DIRECT

Switches this unit to Pure Direct mode ([p. 47](#)).

⑫ INPUT selector

Selects an input source from which to playback. Rotate this selector to cycle through the input sources in order.

⑬ PHONES jack

For plugging headphones in. Sound effects applied during playback can also be heard through the headphones.

⑭ YPAO MIC jack

Connect the supplied YPAO microphone and adjust the speaker balance automatically ([p. 34](#)).

⑮ TONE CONTROL

Adjusts high-frequency/low-frequency output of speakers/headphones ([p. 43](#)).

⑯ SCENE

Switches the input source, the sound program, and the HDMI OUT with a single button ([p. 44](#), [p. 90](#)). When this unit is in standby mode, press this key to switch on.

⑰ PROGRAM selector

Selects a sound program ([p. 44](#)). Rotate this selector to cycle through sound programs.

⑱ STRAIGHT

Changes a sound program to straight decoding mode ([p. 45](#)).

⑲ VIDEO AUX jacks

For connecting game consoles to this unit temporarily ([p. 29](#)). Attach the supplied VIDEO AUX input cover when not using this jack ([p. 7](#)).

⑳ VOLUME

Adjusts the volume level.

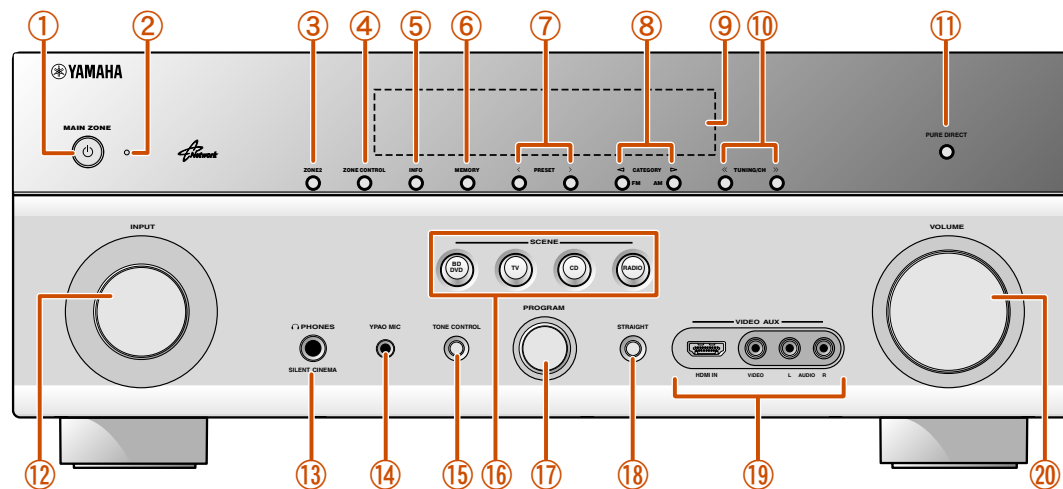

 1: Usable when you have selected TUNER or SIRIUS input.

Rear panel

① **DOCK jack**

For connecting an optional Universal Dock for iPod (such as YDS-12), Wireless System for iPod (YID-W10), or Bluetooth wireless audio receiver (YBA-10) (see p. 79, p. 81, p. 83).

② **NETWORK port**

For connecting to the network (see p. 32).

③ **HDMI OUT 1-2 jacks**

For connecting an HDMI - compatible TV to output audio/video signals (see p. 23).

④ **ANTENNA jacks**

For connecting AM and FM antennas (see p. 33).

⑤ **MONITOR OUT jacks**

VIDEO jack

For connecting a TV capable of receiving video input, and outputting video signals to it (see p. 23).

COMPONENT VIDEO jacks

For connecting TV that are compatible with component video signals, using three cables to output video signal (see p. 23).

⑥ **REMOTE IN/OUT jacks**

For connecting an external component that supports the remote control function (see p. 30).

⑦ **HDMI1-5 jacks**

For connecting external components equipped with HDMI-compatible outputs to receive audio/video signals (see p. 25).

⑧ **SPEAKERS terminals**

For connecting the front, center, surround and surround back speakers (see p. 17). Connect the presence speakers (see p. 17) or the speakers for Zone2 (see p. 18) to the EXTRA SP jacks.

⑨ **Power cable**

For connecting this unit to an AC wall outlet.

⑩ **SIRIUS jack**

For connecting a SiriusConnect tuner (sold separately) (see p. 61).

⑪ **AV1-6 jacks**

For connecting to external components equipped with audio/video outputs to receive audio/video signals (see p. 26).

⑫ **AV OUT jacks**

For outputting audio/video signals received when analog inputs (AV3-6 or AUDIO1-2) are selected (see p. 31).

⑬ **AUDIO1-2 jacks**

For connecting external components equipped with analog audio outputs to input sound into this unit (see p. 28).

⑭ **TRIGGER OUT jack**

For connecting an external component that supports the trigger function to operate it linked with operation of this unit (see p. 31).

⑮ **MULTI CH INPUT jacks**

For connecting a player that supports a multi-channel output (see p. 29).

⑯ **AUDIO OUT jacks**

For outputting audio signals received when analog jacks, such as the AV5-6 or AUDIO1-2 are selected (see p. 31).

⑰ **ZONE2 OUT jacks**

Outputs sound of this unit to an external amplifier set in a different room. (see p. 125).

⑱ **PRE OUT terminals**

For connecting a subwoofer with built-in amplifier or an external power amplifier (see p. 20, p. 30).

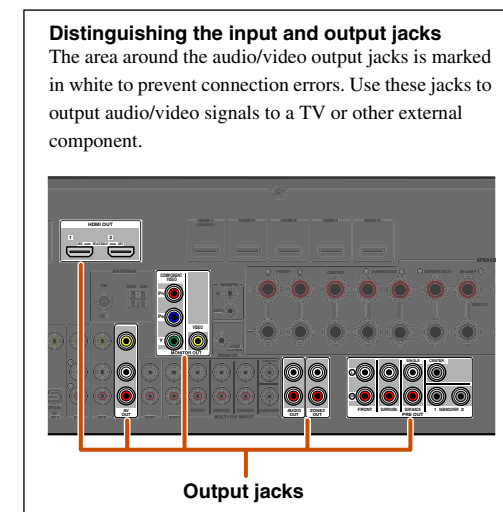
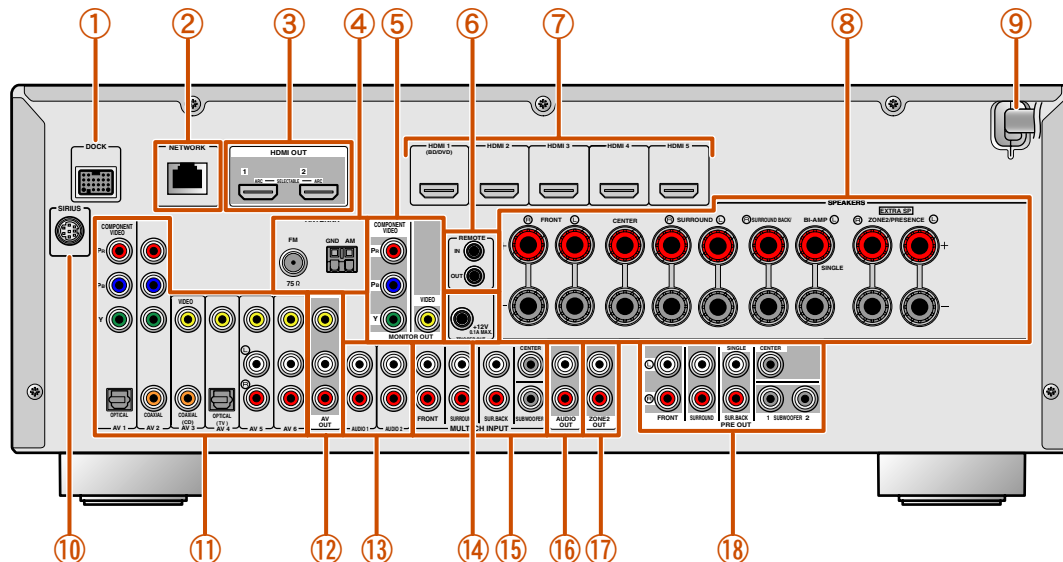

Distinguishing the input and output jacks

The area around the audio/video output jacks is marked in white to prevent connection errors. Use these jacks to output audio/video signals to a TV or other external component.

Front panel display

- ① **HDMI indicator**
Lights up when this unit detects the external component connected to the HDMI1-5 jacks.
- OUT 1/OUT 2 indicators**
Indicate which HDMI OUT jack outputs audio/video signals (p. 23).
- ② **SIRIUS indicator**
Lights up when a SiriusConnect tuner is selected as an input source.
- ③ **CINEMA DSP indicator**
Lights up when a sound field effect that uses CINEMA DSP technology is selected.
- ④ **ENHANCER indicator**
Lights up when the Compressed Music Enhancer is active (p. 47).
- ⑤ **CINEMA DSP 3D indicator**
Lights up when CINEMA DSP 3D is activated (p. 46).
- ⑥ **Tuner indicators**
Light up according to the status of a received station (p. 57).

- ⑦ **SLEEP indicator**
Lights up when the sleep timer is on (p. 11).
- ⑧ **ZONE2 indicator**
Lights up when the audio output to Zone2 is enabled (p. 126).
- ⑨ **MUTE indicator**
Flashes when audio is muted.
- ⑩ **VOLUME indicator**
Displays the current volume level.
- ⑪ **Cursor indicators**
Light up if corresponding cursors on the remote control are available for operations.
- ⑫ **Multi information display**
Displays a range of information on menu items and settings.
- ⑬ **Speaker indicators**
Indicate speaker terminals from which signals are output.

Switching information on the front panel display
The front panel can display sound programs and surround decoder names as well as the active input source. Press **INFO** repeatedly to cycle through displayed informations. 



Input source name
Sound program (DSP program)

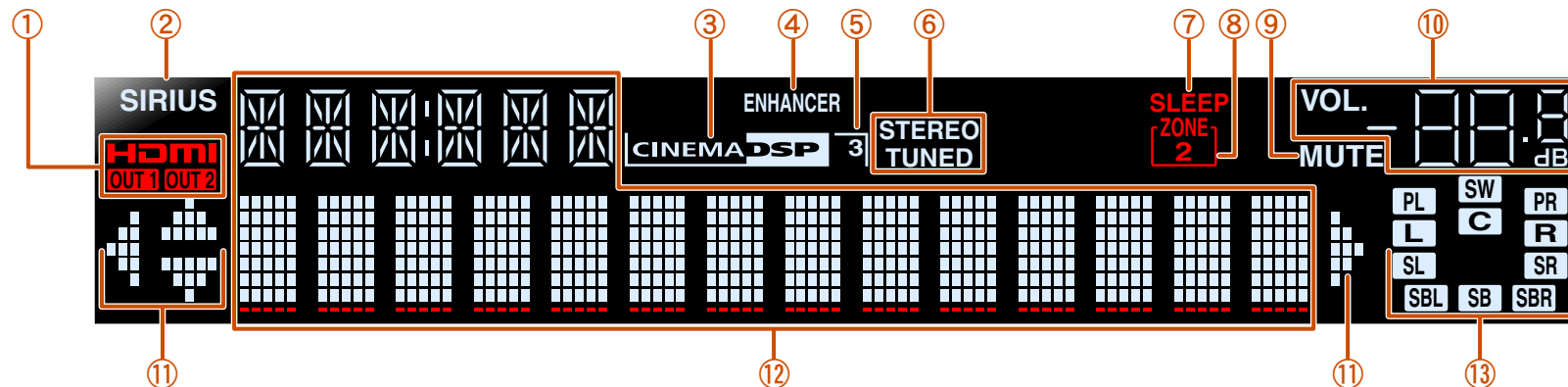
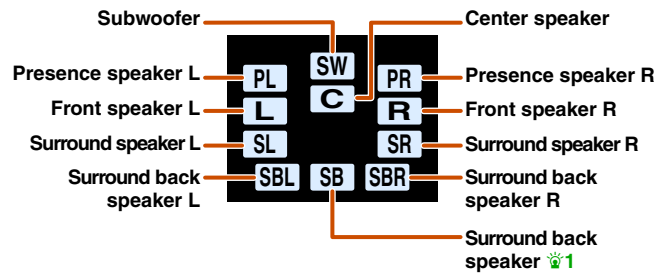

 1: "SB" is displayed when using a 6.1-channel configuration only.

 2: During FM/AM reception, the frequency is displayed instead of the input source. During SIRIUS Satellite Radio signals reception, the channel is displayed instead of the input source.

Remote control

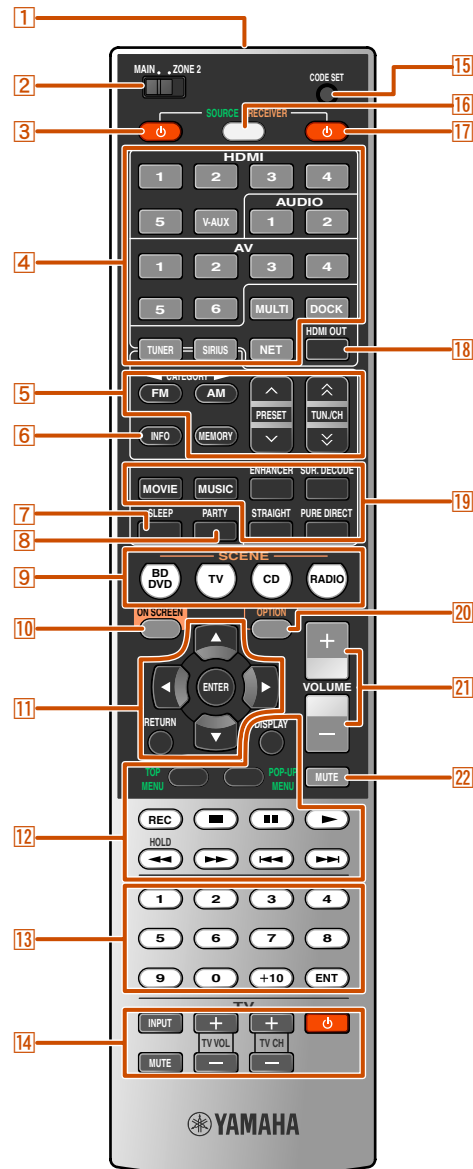

- 1 Remote control signal transmitter**
Transmits infrared signals.
- 2 MAIN/ZONE2**
Switches the zone to be operated by the remote control between the Main zone and Zone2 (p. 126).
- 3 SOURCE ϕ (SOURCE Power)**
Switches an external component on and off.
- 4 Input selector**
Select an input source on this unit from which to playback.

HDMI1-5	HDMI1-5 jacks
V-AUX	Front panel VIDEO AUX jacks
AUDIO1-2	AUDIO1-2 jacks
AV1-6	AV1-6 jacks
NET	Rhapsody service, SIRIUS internet radio, internet radio, or a PC connected to the NETWORK port.
MULTI CH INPUT	MULTI CH INPUT jacks
DOCK	A Universal Dock for iPod, Wireless System for iPod, or Bluetooth wireless audio receiver connected to the DOCK jack.
TUNER	FM/AM tuner
SIRIUS	A SIRIUS tuner connected to the SIRIUS jack.
- 5 Radio control keys**
Operates the FM/AM tuner. These keys are used when using the tuner input.

FM	Sets the FM/AM tuner band to FM.
AM	Sets the FM/AM tuner band to AM.
(CATEGORY $\triangleleft/\triangleright$)	Selects a channel category for a SIRIUS.
MEMORY	Presets radio stations.
PRESET \wedge/\vee	Selects a preset station.
TUN./CH \wedge/\vee	Changes tuning frequencies or SIRIUS Satellite Radio channels.
- 6 INFO**
Cycles the information displayed on the front panel display (the name of the currently selected input source, the sound program, the surround decoder, the FM/AM tuner frequency, etc.).
- 7 SLEEP**
Switches this unit to standby mode automatically after a specified period of time has elapsed (sleep timer). Press this key repeatedly to set the time for the sleep timer function.

Sleep 120min.	Sleep 90min.
Sleep Off	Sleep 30min.
	Sleep 60min.

The SLEEP indicator lights up when the sleep timer is on.

- 8 PARTY**
Switches the party mode on and off (p. 126).
- 9 SCENE**
Switch the input source and the sound program with a single button (p. 44). When this unit is in standby mode, press this key to switch on.
- 10 ON SCREEN**
Turns on and off the ON SCREEN menu.
- 11 Cursor $\triangle/\nabla/\triangleleft/\triangleright$, ENTER, RETURN**
Cursor $\triangle/\nabla/\triangleleft/\triangleright$ Select menu items and change settings when menus, etc. are displayed.
ENTER Confirms a selected item.
RETURN Returns to the previous screen when menus are displayed, or close the menu.
- 12 External component operation keys**
Operate recording, playback, and menu displays etc. for external components (p. 115).
- 13 Numeric keys**
Enter numbers.
- 14 TV control keys**
Operate a monitor such as a TV.
- 15 CODE SET**
Sets remote control codes for external component operations (p. 116).
- 16 SOURCE/RECEIVER**
Switches remote control key function to operate this unit or an external component (p. 115). Operate an external component when this key glows green, or this unit when this key glows orange.
- 17 RECEIVER ϕ (RECEIVER Power)**
Switches this unit between on and standby mode.
- 18 HDMI OUT**
Switches the output jack connected to an HDMI compatible TV (p. 42).
- 19 Sound selection keys**
Switch between the sound field effect (sound program) you are using and the surround decoder (p. 44).
- 20 OPTION**
Turns on and off the Option menu (p. 52).
- 21 VOLUME +/-**
Adjust the volume level (p. 42).
- 22 MUTE**
Turns the mute function of the sound output on and off (p. 42).



On-screen display

When a TV is connected to this unit, the supplied remote control can be used to specify and verify this unit's settings via menus and options displayed on the TV screen.

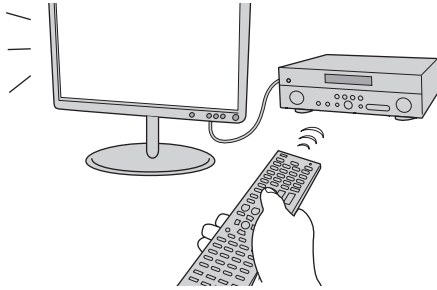

The following displays are available in the on-screen display.

ON SCREEN menu

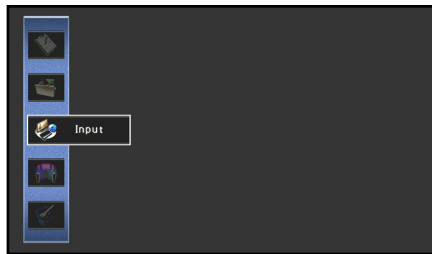

Press **[10] ON SCREEN** to display the ON SCREEN menu.

Detailed settings for this unit can be configured. Use this menu to select desired settings, change their values, or check the current status of this unit.

Refer to "SETUP" ([p. 86](#)) for details.

Option menu



Press **[20] OPTION** to display the Option menu.

Configure the optional settings for each input source. Settings such as "Tone Control" and "Volume Trim" are applied to this unit regardless of the input source.

Refer to "Configuring settings specific to an individual input source (Option menu)" ([p. 52](#)) for details.

Content window

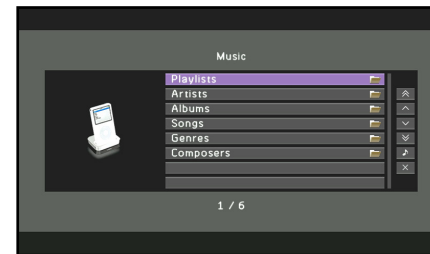

Press **[4] Input selector** to display the Content window.

Includes the Browse view and the Now Playing view. The Now Playing view displays the status of the source from which music is currently played back. Adjust settings for music content from the Browse view.

Refer to "Confirming and operating input sources from the Content window" ([p. 56](#)) for details.

CONNECTIONS

Connecting speakers

This unit uses acoustic field effects and sound decoders to bring you the impact of a real movie theater or concert hall. These effects will be brought to you with ideal speaker positioning and connections in your listening environment.

Speaker channels and functions

Front left and right speakers

The front speakers are used for the front channel sounds (stereo sound) and effect sounds.

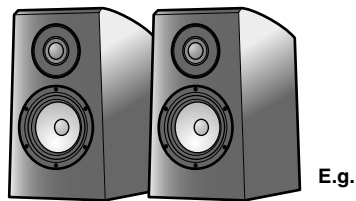

Front speaker layout:

Place these speakers at an equal distance from the ideal listening position in the front of the room. When using a projector screen, the appropriate top positions of the speakers are about 1/4 of the screen from the bottom.

Center speaker

The center speaker is for the center channel sounds (dialog, vocals, etc.).

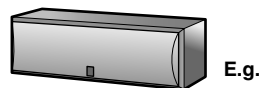

Center speaker layout:

Place it halfway between the left and right front speakers. When using a TV, place the speaker just above or just under the center of the TV with the front surfaces of the TV and the speaker aligned. When using a screen, place it just under the center of the screen.

Surround left and right speakers

The surround speakers are for effect and vocal sounds when playing back a 5.1-channel source or higher. If used with no surround back speaker when playing back a 6.1-channel source or higher (including a surround back channel), the sound of the surround back channel is distributed between the left and right surround speakers.

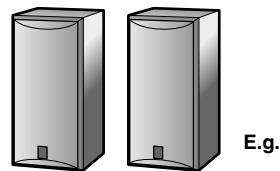

Surround speaker layout:

Place the speakers at the rear of the room on the left and right sides facing the listening position. They should be placed between 60 degrees and 80 degrees from the listening position and with the speaker tops at a height of 4.9 – 5.9 ft. (1.5 – 1.8 m) from the floor.

Presence left and right speakers

The presence speakers are used for front effect sounds. When used in combination with the sound programs (see p. 44), a sound with a richer and more spatial presence is possible.

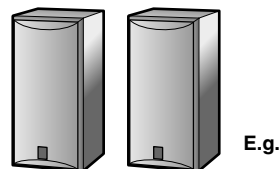

Presence speaker layout:

Place the left and right presence speakers 1.6 – 3.3 ft. (0.5 – 1 m) to the outside of the left and right front speakers respectively. The tops of the presence speakers should be 5.9 ft. (1.8 m) above the floor.

Surround back left and right speakers

The surround back speakers are for rear effect sounds when playing back a 6.1-channel source or higher. If used with only one surround back speaker when playing back a 7.1-channel source or higher, the sound of the left and right surround back channel is mixed and output from a single speaker.

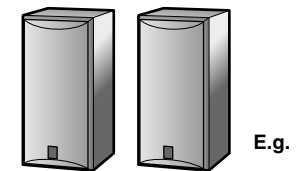

Surround back speaker layout:

When used with 7.1ch sound, arrange the left and right speakers towards the listening position, to the rear of the listening position. Arrange the left and right speakers at least 1 ft. (30 cm) apart. The same separation as with the front left and right speakers is optimum. When used with 6.1ch sound, arrange these to the rear of the listening position.

Subwoofer

The subwoofer speaker is used for bass sounds and low-frequency effect (LFE) sounds included in Dolby Digital and DTS. Use a subwoofer that is equipped with built-in amplifier.



Subwoofer speaker layout:

Place it to the outside of the front left and right speakers facing slightly inward to reduce echoes from the wall. You can use one or two subwoofers.

Speaker layout

In addition to the 7.1-channel speaker layout, a variety of speaker configurations can be specified with presence speaker connection, bi-amp connection or the Zone2 function.

And, this unit is equipped with “Power Amp Assign” function which can easily apply the appropriate speaker setting to this unit according to your speaker configuration.

Connection of speakers

Connect the speakers to the appropriate jacks shown in the table for each speaker layout. Refer to “Connecting speakers and subwoofers” (p. 17) for details on connecting speakers.

You can also use two subwoofers by connecting them to both SUBWOOFER1 and SUBWOOFER2 jacks. In this case, monaural sound of subwoofer channel is output from both speakers.

Assigning a speaker configuration

A speaker configuration must be assigned to this unit to activate the speakers. Use the Power Amp Assign function to apply the appropriate settings shown in the table for each speaker layout. Refer to “Power Amp Assign” (p. 99) for details on setting.

Enjoying the 7.1 channel audio source

7.1-channel speaker layout (7 speakers + subwoofer)

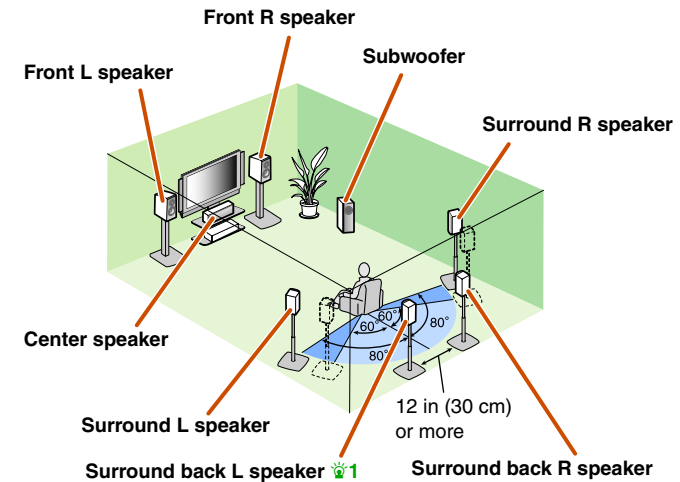

Audio from a 7.1-channel audio source can be played back with no degradation with this speaker configuration.

Connections of speakers

FRONT jacks	Front L/R speakers	SURROUND BACK jacks	Surround back L/R speakers
CENTER jack	Center speaker	SUBWOOFER (PRE OUT) jack	Subwoofer
SURROUND jacks	Surround L/R speakers		

Assigning a speaker configuration

Power Amp Assign	7ch Normal (Default)
-------------------------	----------------------

1: The sound of surround back channel can also be output from a single surround back speaker. When only one surround back speaker is used, connect it to the SURROUND BACK L (SINGLE) jack and place it directly behind the listening position.

■ Adding the presence speakers for a richer sound field effect

■ Presence speaker layout (7 speakers + subwoofer + presence speakers)

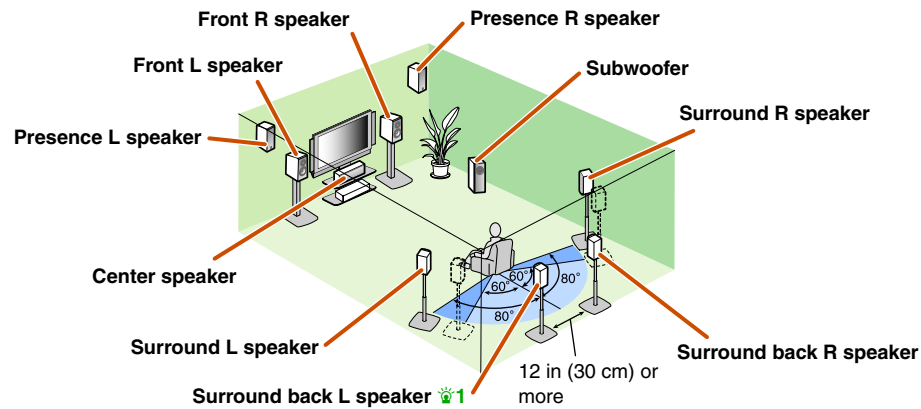

This unit automatically selects the presence speakers or surround back speakers to output sounds according to the selected sound program.
When the sound program is changed, the speakers that output the sound are switched between the presence speakers and surround back speakers automatically. 🌟2

■ Connections of speakers

FRONT jacks	Front L/R speakers	SURROUND BACK jacks	Surround back L/R speakers
CENTER jack	Center speaker	SUBWOOFER (PRE OUT) jack	Subwoofer
SURROUND jacks	Surround L/R speakers	EXTRA SP jacks	Presence L/R speakers

■ Assigning a speaker configuration

Power Amp Assign	7ch Normal (Default)
------------------	----------------------

■ Enjoying the audio source without surround back speakers

■ 5.1-channel speaker layout (5 speakers + subwoofer)

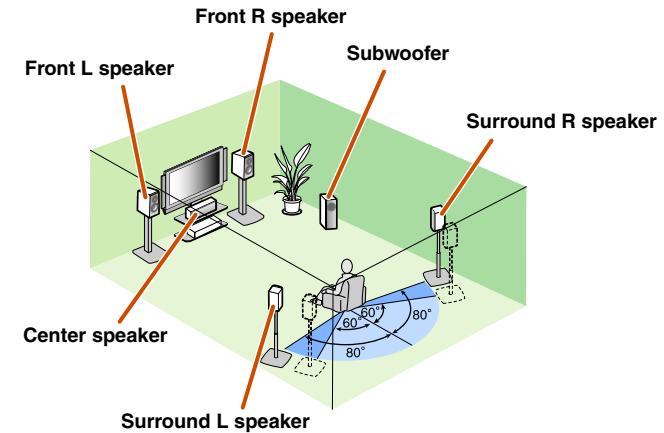

This unit can mix 7.1-channel audio source down to 5.1-channel sound. This enables 7.1-channel sound without surround back speakers.

■ Connections of speakers

FRONT jacks	Front L/R speakers	SURROUND jacks	Surround L/R speakers
CENTER jack	Center speaker	SUBWOOFER (PRE OUT) jack	Subwoofer

■ Assigning a speaker configuration

Power Amp Assign	7ch Normal (Default)
------------------	----------------------

🌟 1: The sound of surround back channel can also be output from a single surround back speaker. When only one surround back speaker is used, connect it to the SURROUND BACK L (SINGLE) jack and place it directly behind the listening position.

🌟 2: Sound cannot be output from the surround back speakers when it is output from the speakers connected to the EXTRA SP jacks.

Using the front speakers that support bi-amp connections for a high quality sound

5.1-channel speaker layout (Front speakers (Bi-amp) + 3 speakers)

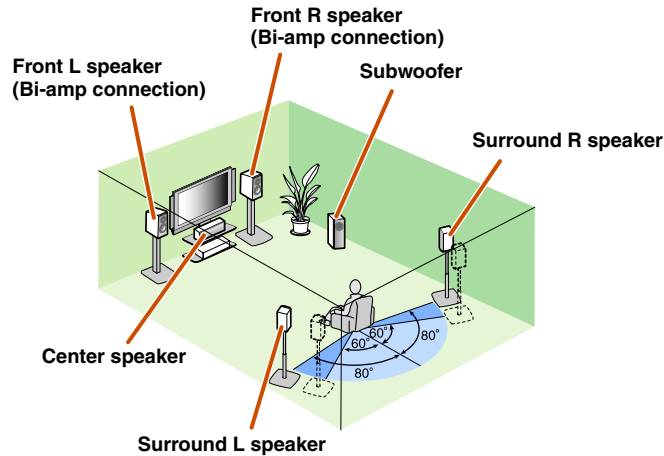

Using the front speakers that support bi-amp connections reproduces a high quality sound.

Connections of speakers

FRONT jacks	Front L/R speakers (bi-amp)	SURROUND BACK jacks	Front L/R speakers (bi-amp)
CENTER jack	Center speaker	SUBWOOFER (PRE OUT) jack	Subwoofer
SURROUND jacks	Surround L/R speakers		

Assigning a speaker configuration

Power Amp Assign	5ch BI-AMP
-------------------------	------------

Using speakers in two rooms (Zone2 function)

7.1-channel speaker layout + Zone2 (7 speakers (in main zone) + subwoofer (in main zone) + front speakers (in secondary zone))

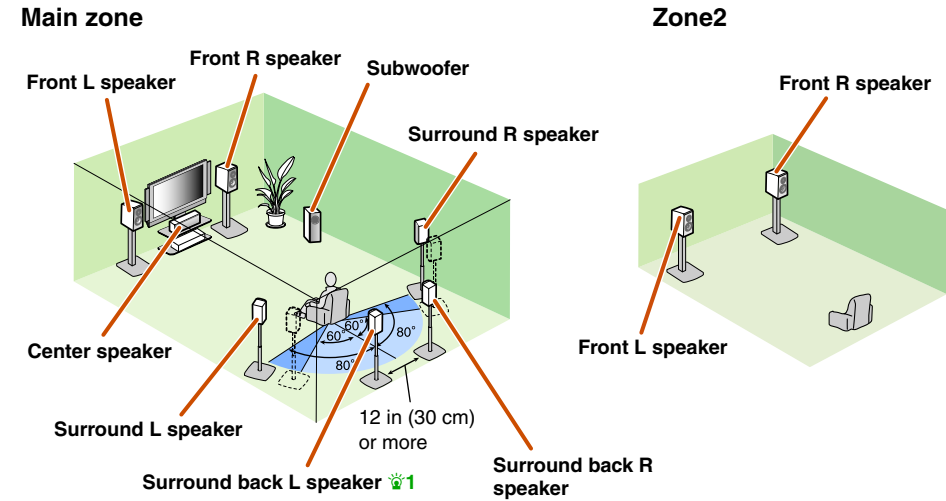

In addition to the main room, speakers in another room can also be controlled. When the built-in amplifier assigned to speakers in another room is turned on, sound output automatically switches from the surround back speakers to the speakers in the other room.

Connections of speakers

FRONT jacks	Front L/R speakers	SURROUND BACK jacks	Surround back L/R speakers
CENTER jack	Center speaker	SUBWOOFER (PRE OUT) jack	Subwoofer
SURROUND jacks	Surround L/R speakers	EXTRA SP jacks	Zone2 speakers

Assigning a speaker configuration

Power Amp Assign	7ch + 1ZONE
-------------------------	-------------

1: The sound of surround back channel can also be output from a single surround back speaker. When only one surround back speaker is used, connect it to the SURROUND BACK L (SINGLE) jack and place it directly behind the listening position.

2: Sound cannot be output from the surround back speakers when it is output from the speakers connected to the EXTRA SP jacks.

Connecting speakers and subwoofers

Connect your speakers to their respective terminals on the rear panel.

CAUTION

- Remove the AC power cable of this unit from the power outlet before connecting the speakers.
- Generally speaker cables consist of two parallel insulated cables. One of these cables is a different color, or has a line running along it, to indicate different polarity. Insert the different colored (or lined) cable into the “+” (positive, red) terminal on this unit and the speakers, and the other cable into the “-” (negative, black) terminal.
- Be careful that the core of the speaker cable does not touch anything or come into contact with the metal areas of this unit. This may damage this unit or the speakers. If the speaker cables short circuit, “CHECK SP WIRES!” will appear on the front panel display when this unit is switched on.

■ Front/Center/Surround/Surround back speaker and Subwoofer connection

When connecting only one surround back speaker, connect the speaker to the SURROUND BACK L (SINGLE) jacks.

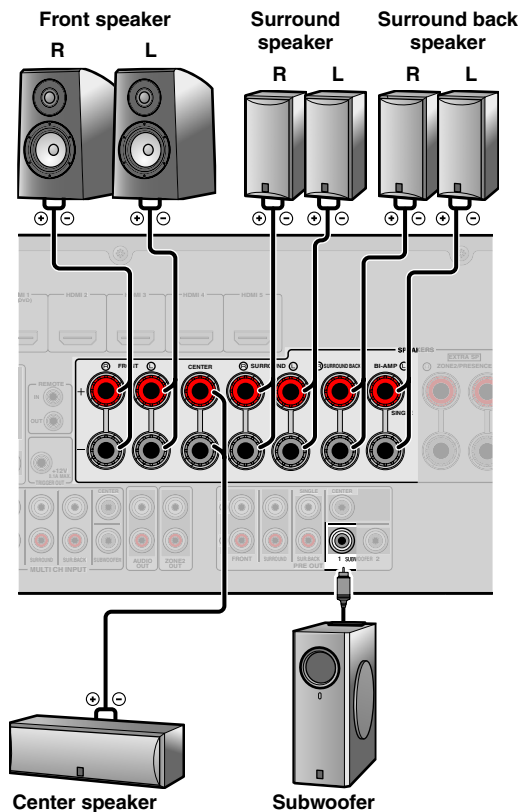

■ Presence speaker connection

When using the presence speakers, connect the speakers to the EXTRA SP jacks as shown in the diagram below.

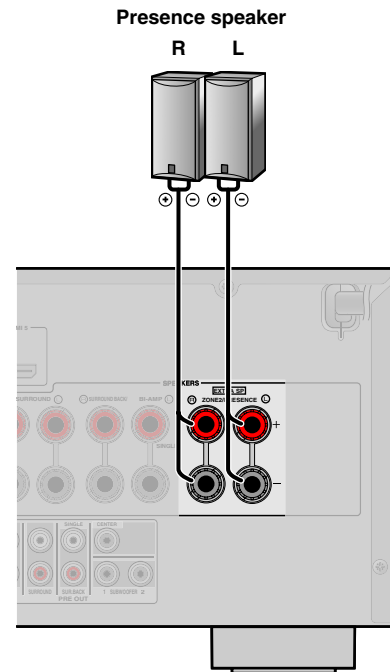

The presence speakers (PL/PR) that output front effect sounds can be connected to this unit. With the sound programs (p. 48), sound with a richer and more spatial presence can be created.

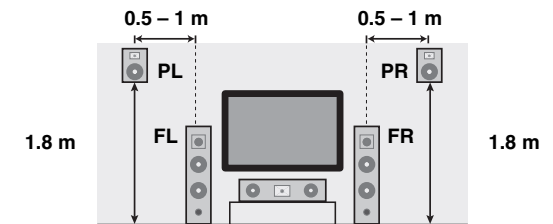

- Connection of presence speakers is recommended to take full advantage of the effects of CINEMA DSP sound programs.
- Although you can connect both surround back speakers and presence speakers to this unit, you cannot output sounds from those speakers at the same time.

Continues to the next page

■ Bi-amp connection

This unit can be connected to speakers that support bi-amp connections. When connecting speakers, connect the FRONT jacks and the SURROUND BACK/BI-AMP jacks as in the diagram below. Configure the bi-amp settings to activate connections.

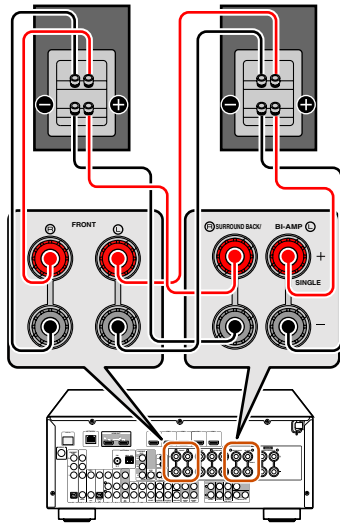

NOTES

- Before making bi-amplification connections, remove any brackets or cables that connect a woofer with a tweeter. Refer to the instruction manuals of speakers for details. When not making bi-amplification connections, make sure that the brackets or cables are connected before connecting the speaker cables.
- If connecting a bi-amp, then surround back speakers cannot be used.

■ Multi-zone audio system using the internal amplifier of this unit

Connect the speakers in the second zone to the EXTRA SP jacks as in the diagram below.

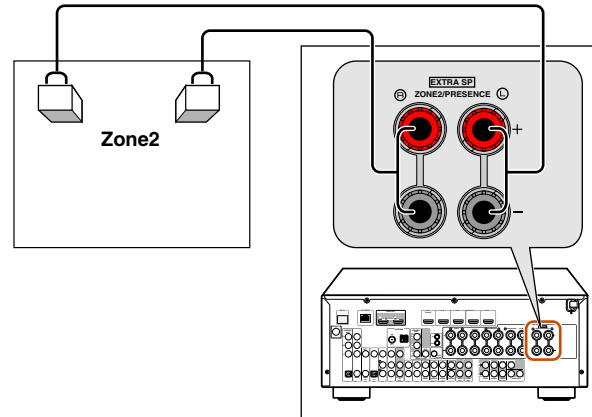

CAUTION

The EXTRA SP jacks of this unit should not be connected to a Passive Loudspeaker Selector Box or more than one loudspeaker per channel. Connection to a Passive Loudspeaker Selector Box or multiple speakers per channel could create an abnormally low impedance load resulting in amplifier damage. See this owner's manual for correct usage. Compliance with minimum speaker impedance information for all channels must be maintained at all times. This information is found on the back panel of this unit.

■ Changing speaker impedance

This unit is configured for 8 Ω speakers at the factory setting. When connecting to 6 Ω speakers, carry out the following procedure to switch to 6 Ω. When this unit is configured for 6 Ω speakers, 4 Ω speakers can also be used as the front speakers.

- 1 Switch this unit to the standby mode.
- 2 Press **MAIN ZONE** while pressing and holding **STRAIGHT** on the front panel.

Release the keys when “ADVANCED SETUP” is displayed on the front panel display.

After approximately a few seconds, the top menu item is displayed. 1

MAIN ZONE

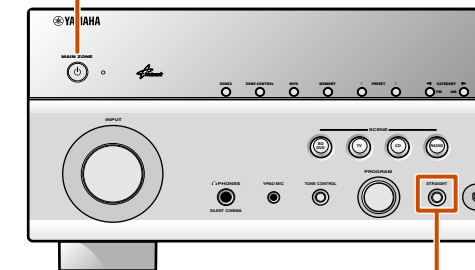

STRAIGHT

Continues to the next page

1 : Refer to the “Extended functionality that can be configured as needed (Advanced Setup menu)” ([see p. 118](#)) for details on the Advanced Setup menu.

- 3 Check that "SP IMP." is displayed on the front panel.



- 4 Press STRAIGHT repeatedly to select a "6ΩMIN."

- 5 Switch this unit to the standby mode, and then switch it on again.

The power turns on, when the settings you made has been configured.

Connecting speakers

This type of jack can connect to the following speakers or connection.

- Front L/R speakers
- Center speaker
- Surround L/R speakers
- Surround back L/R speakers
- Presence L/R speakers
- Zone2 speakers
- Bi-amp connection (Front L/R speakers)

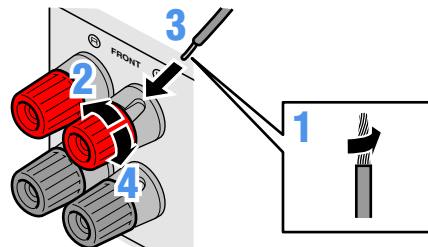

- 1 Remove approximately 0.4 in. (10 mm) of insulation from the ends of the speaker cables, and twist the bare wires of the cables together firmly so that they will not cause short circuits.
- 2 Loosen the speaker terminals.
- 3 Insert the bare wire of the speaker cable into the gap on the side of the terminal.

- 4 Tighten the terminal.

Connecting the banana plug

Tighten the knob, and then insert the banana plug into the end of the terminal.

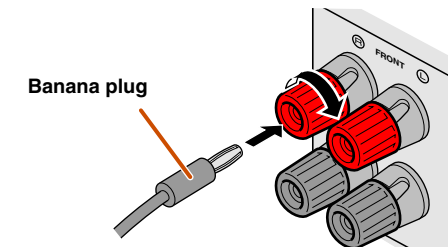

■ Connecting subwoofers

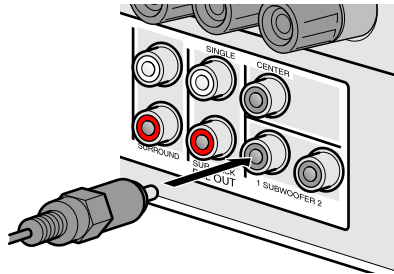

1 Connect the subwoofer input jack to the SUBWOOFER 1 or 2 jack on this unit with an audio pin cable.

2 Set the subwoofer volume as follows.
 Volume: Set to approximately half volume (or slightly less than half).
 Crossover frequency (if available): Set to maximum.

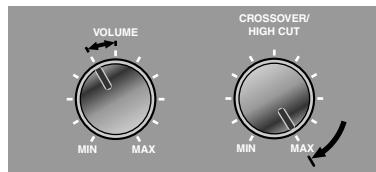

Subwoofer examples

NOTE

After connection, applying this setting to this unit is required to activate all speaker connections. With using “Power Amp Assign” function, you can easily apply the speaker configuration.

Refer to “Power Amp Assign” ([p. 99](#)) for details on using “Power Amp Assign” function.

Connecting external components

Jacks and cables

This unit is equipped with the following input/output jacks. Use jacks and cables appropriate for components that you are going to connect.

Audio/Video jacks

HDMI jacks

Digital video and digital sound are transmitted through a single jack.
Only use an HDMI cable.

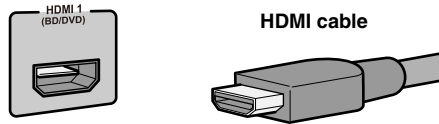

- Use a 19-pin HDMI cable with the HDMI logo.
- We recommend using a cable less than 16.4 ft. (5.0 m) long to prevent signal quality degradation.
- When a TV that supports HDMI functions and Audio Return Channel function is connected, audio output from the TV can be input to this unit ([see p. 123](#)).
- When a player and TV that support the 3D video format are connected to this unit, 3D content can be played back.
- If you connect this unit to a component that has a DVI jack, an HDMI/DVI-D cable is required.

Analog video jacks

COMPONENT VIDEO jacks

The signal is separated into three components:
luminance (Y), chrominance blue (PB), and chrominance red (PR).
Use component video pin cables with three plugs.

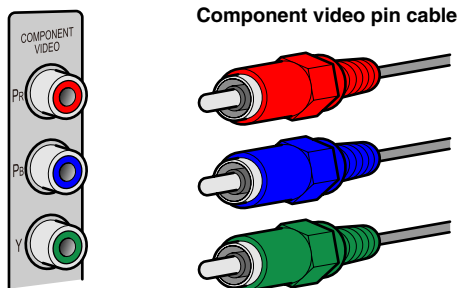

VIDEO jacks

These jacks transmit conventional analog video signals.
Use video pin cables.

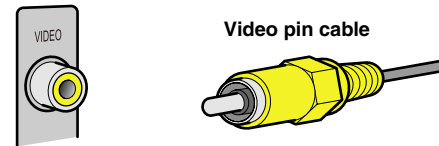

Audio jacks

OPTICAL jacks

These jacks transmit optical digital audio signals.
Use fiber-optic cables for optical digital audio signals.



COAXIAL jacks

These jacks transmit coaxial digital audio signals.
Use pin cables for digital audio signals.



AUDIO jacks

These jacks transmit conventional analog audio signals.
Use stereo pin cables, connecting the red plug to the red R jack, and the white plug to the white L jack.

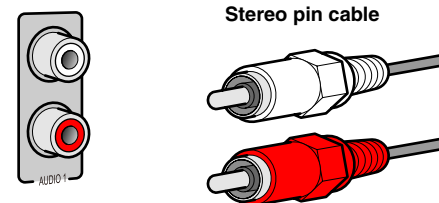

Connecting a TV monitor

This unit is equipped with the following three types of output jack for connection to a TV. HDMI OUT 1-2, COMPONENT VIDEO or VIDEO. Select the proper connection according to the input signal format supported by your TV.

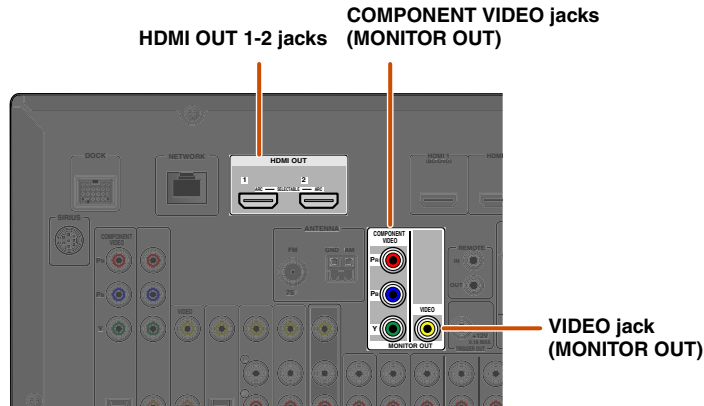

When connecting to a non-HDMI compatible TV

Connect to the TV using the same type of connection that you used to connect to the external component, and change the inputs on your TV to match that of the external component you are using for playback. If the external component and TV are equipped with different types of analog video jacks, this unit will convert the video signal to component video signal, or vice-versa, according to the type of video input jacks used by the TV. 🟡2, 🟢3

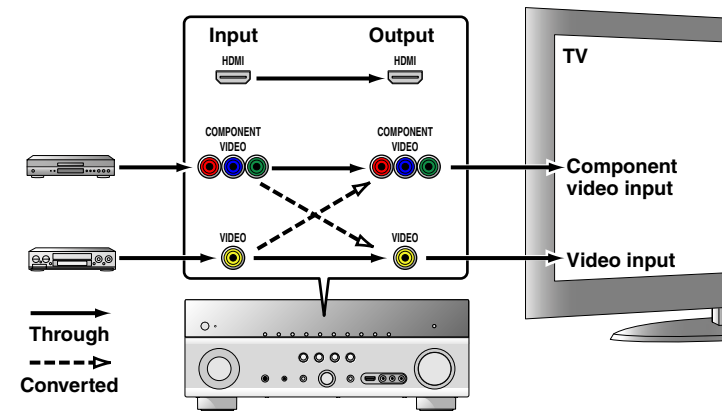

When connecting to an HDMI compatible TV

Video signal such as component video and video received by this unit is converted to HDMI and output to the TV. Just select HDMI input on the TV to view video from any external source connected to this unit. 🟢1

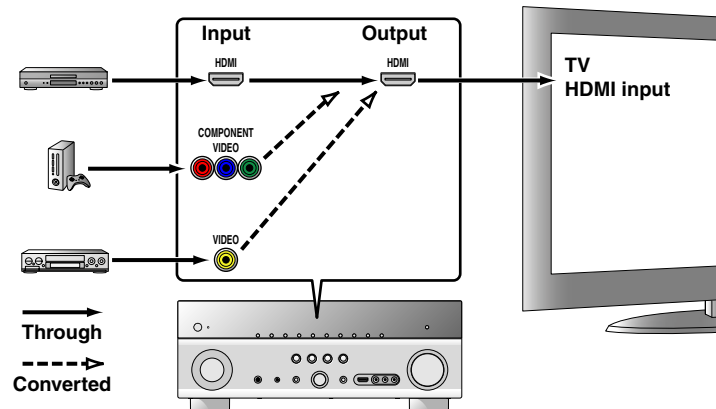

🟢 1 : You can change the resolution and aspect ratio when converting to HDMI to suit your requirements (see p. 105).

🟡 2 : Set "Analog to Analog Conversion" to "On" (see p. 104).

🟢 3 : Analog to analog conversion is available only for 480i/576i-resolution video signal.

■ Connecting an HDMI video monitor

Connect the HDMI cable to one of the HDMI OUT 1-2 jacks.

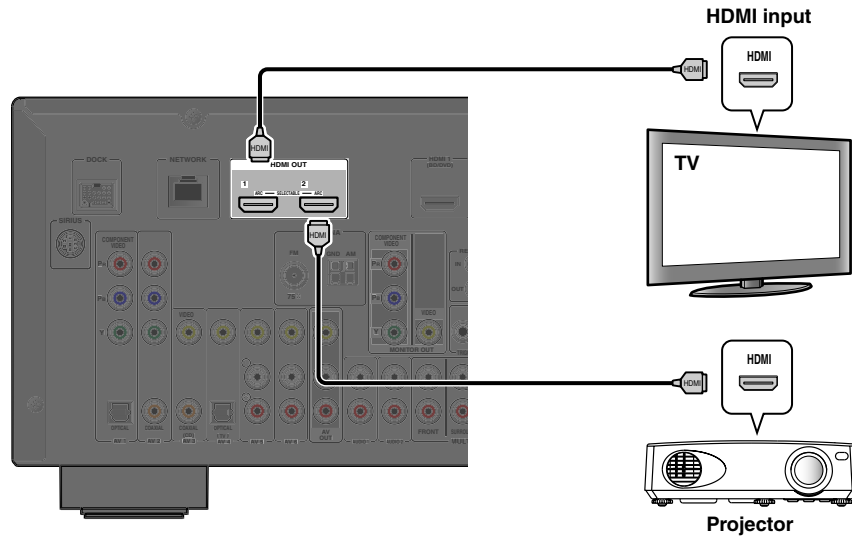

■ Connecting a component video monitor

Connect the component video cable to the COMPONENT VIDEO (MONITOR OUT) jacks.

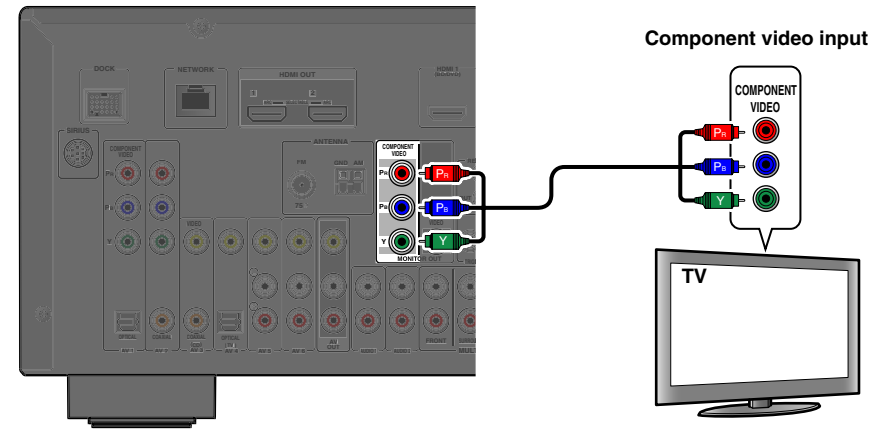

■ Connecting a video monitor

Connect the video pin cable to the VIDEO (MONITOR OUT) jack.

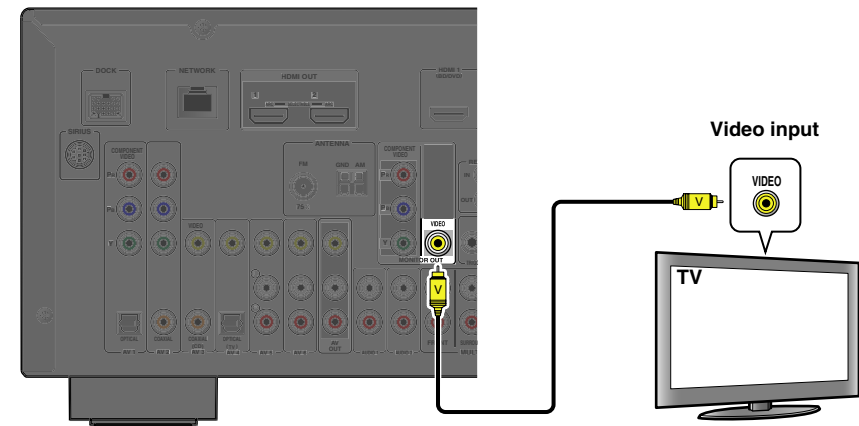

- Use a 19-pin HDMI cable with the HDMI logo.
- We recommend using a cable less than 16.4 ft. (5.0 m) long to prevent signal quality degradation.
- When a TV that supports the HDMI function and Audio Return Channel function is connected, audio output from the TV can be input to this unit ([p. 123](#)).
- When a player and TV that support the 3D video format are connected to this unit, 3D content can be played back.
- This unit is equipped with HDMI OUT 1 and 2 jacks. The active HDMI OUT jack(s) can be selected ([p. 42](#)). The active HDMI OUT jack(s) can be registered with the SCENE function ([p. 44](#)).

 **1** : When connecting to a TV that supports HDMI input, the video signal for the COMPONENT VIDEO or VIDEO jacks is converted and output from HDMI OUT 1-2 jacks. When connecting to a TV via the HDMI jack, you do not need to use these jacks.

■ Listening to TV audio

To transmit sound from the TV to this unit, connect as followings according to the TV:

When using a TV that supports the Audio Return Channel function and HDMI Control function

When your TV supports both HDMI Control (e.g., Panasonic VIERA Link) and Audio Return Channel functions, audio/video output from the unit to the TV and audio output from the TV to the unit are possible using a single HDMI cable.

The input source is switched automatically to match operations carried out on the TV, and that makes TV sound control easier to use.

For the connections and settings, refer to “Single HDMI cable input to TV audio with Audio Return Channel function” ([p. 123](#)).

When using a TV that supports the HDMI Control functions

When using a TV that supports HDMI Control functions (e.g., Panasonic VIERA Link), if HDMI Control functions are enabled on the unit, then input source can be switched automatically to match operations carried out on the TV.

For the connections and settings, refer to “Switching the input source on this unit automatically when listening to TV audio” ([p. 122](#)).

When using other TVs

To transmit sound from the TV to this unit, connect AV1-6 or AUDIO1-2 jacks to the TV's audio output jacks.

TV audio output	Connection
Optical digital audio output	Connect to the OPTICAL jack of the AV1 or AV4 with a fiber-optic cable.
Coaxial digital audio output	Connect to the COAXIAL jack of the AV2 or AV3 with a digital audio pin cable.
Analog stereo output	Connect to one of the AV5, AV6, AUDIO1, or AUDIO2 with a stereo pin cable.

Select the input source connected via TV's audio output jack to enjoy the TV sound.

If the TV supports optical digital audio output, we recommend that you connect the TV audio output to the receiver's AV4 jack.

Connecting to AV4 allows you to switch the input source to AV4 with just a single key operation using the SCENE function ([p. 44](#)).

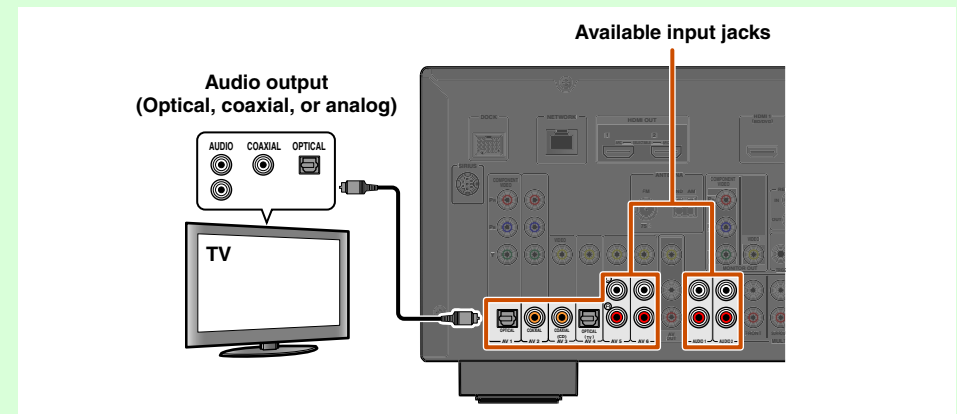

You can control your TV using the receiver's remote control by entering the TV's remote control code ([p. 116](#)).

Connecting BD/DVD players and other devices

This unit has the following input jacks. Connect them to the appropriate output jacks on the playback devices such as BD/DVD players.

Input	Video input	Audio input
HDMI1	HDMI	HDMI
HDMI2	HDMI	HDMI
HDMI3	HDMI	HDMI
HDMI4	HDMI	HDMI
HDMI5	HDMI	HDMI
AV1	Component video	Optical digital
AV2	Component video	Coaxial digital
AV3	Video	Coaxial digital
AV4	Video	Optical digital
AV5	Video	Analog (Stereo)
AV6	Video	Analog (Stereo)
AUDIO1	—	Analog (Stereo)
AUDIO2	—	Analog (Stereo)
VIDEO AUX	HDMI/Video	HDMI/Analog (Stereo)

Connecting BD/DVD players and other devices with HDMI

Connect the device with an HDMI cable to one of the HDMI1-5 jacks. The HDMI IN jack on the front panel can also be used.

Select the HDMI input (HDMI1-5 or VIDEO AUX) that the playback device is connected to for playback.

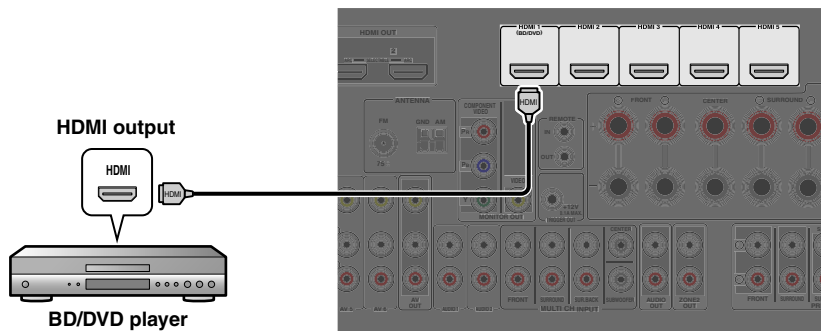

Receiving video signals from the HDMI jack and audio signals from a jack other than HDMI

This unit can use the AV1-6 or AUDIO1-2 input jacks to receive audio signals from other input jacks.

For example, if a playback device cannot produce audio signals from an HDMI jack, use the following method to change the audio input.

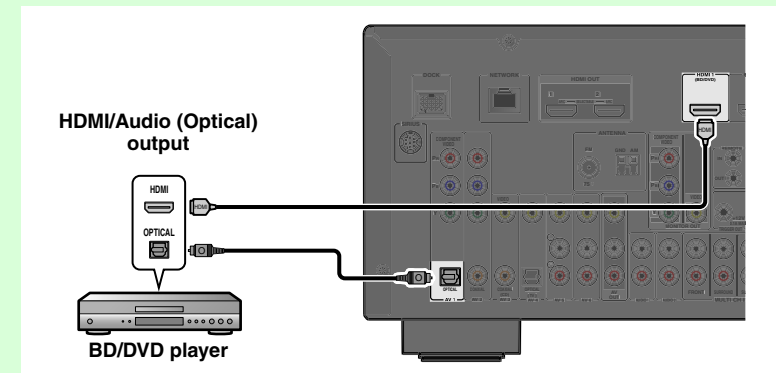

- 1 Press **[10] ON SCREEN** to display the ON SCREEN menu.
- 2 Press **[11] Cursor Δ / ▽** repeatedly to select “Input,” and then press **[11] ENTER**.
- 3 Press **[11] Cursor < / >** repeatedly to select the desired HDMI input source, and then press **[11] Cursor Δ**.
- 4 Press **[11] Cursor ▽** repeatedly to select “Audio In,” and then press **[11] ENTER**.
- 5 Press **[11] Cursor Δ / ▽** to select the audio input source.
- 6 Once you have completed the setup, press **[10] ON SCREEN** to close the menu.

1: Refer to the “Configuring input sources (Input menu)” ([esp. 86](#)) for details on selecting the input source.



[10] ON SCREEN

[11] Cursor Δ / ▽ / < / >

[11] ENTER

■ Connecting BD/DVD players and other devices with component video cables

Connect the device with a component video cable to one of the AV1-2 input jacks.

Using optical digital audio output sources

Select the AV1 input to which the playback device is connected for playback.

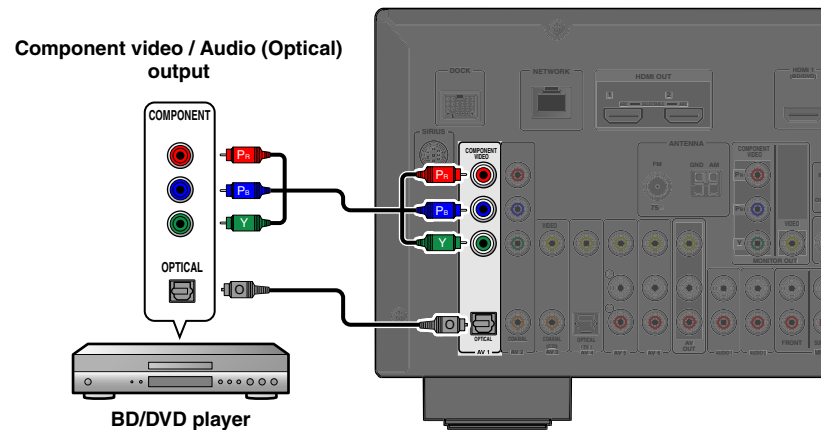

Using coaxial digital audio output sources

Select the AV2 input to which the playback device is connected for playback.

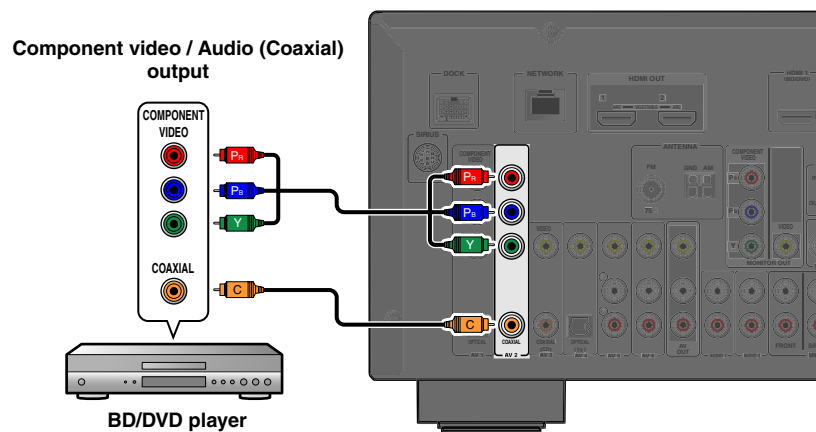

■ Component connections to analog audio output devices

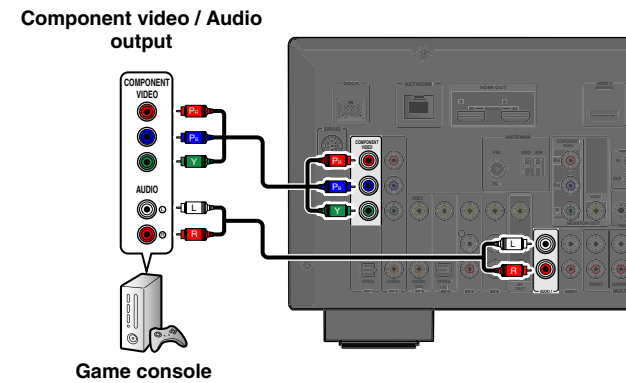

The video input from the AV1-2 jacks can be used in combination with the audio input from other AV inputs or AUDIO1-2.

When connecting these devices, select the AV input jacks or the AUDIO1-2 jacks as the audio input for AV1 or AV2. Refer to "Receiving video signals from the HDMI jack and audio signals from a jack other than HDMI" ([p. 25](#)) for detailed setup guidance.

For playback of the connected device, select the AV input source (AV1-2) to which the device is connected with the component video cable.

Connecting BD/DVD players and other devices with video cables

Connect the playback device with a video pin cable to one of the AV3-6 input jacks.

Using optical digital audio output sources

Select the AV4 input to which the playback device is connected for playback.

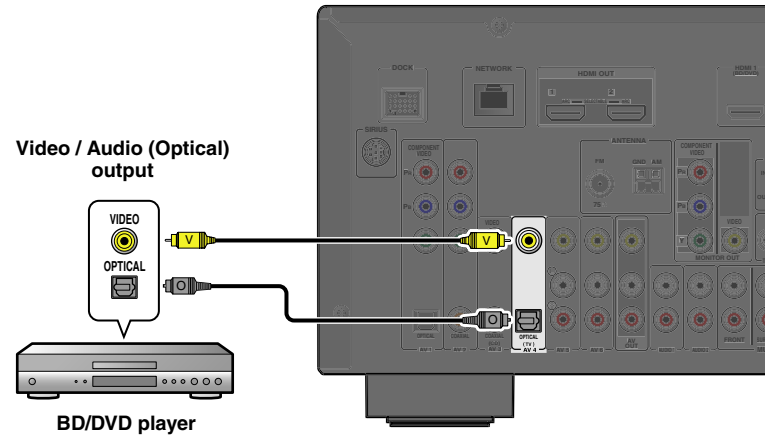

Using analog stereo audio output sources

Select the AV5 or AV6 input to which the playback device is connected for playback.

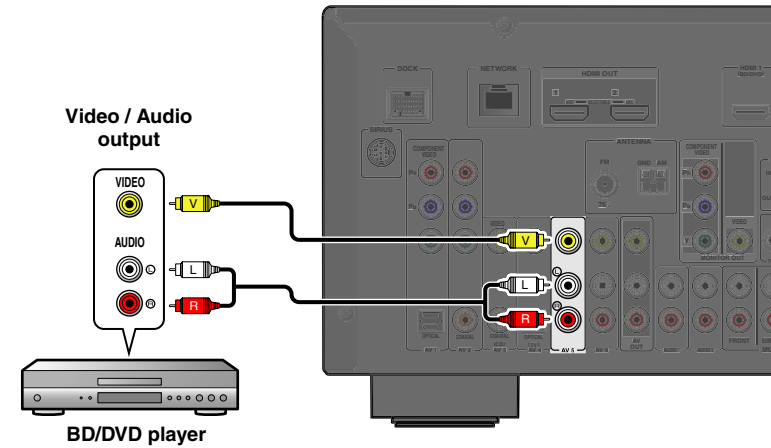

Using coaxial digital audio output sources

Select the AV3 input to which the playback device is connected for playback.

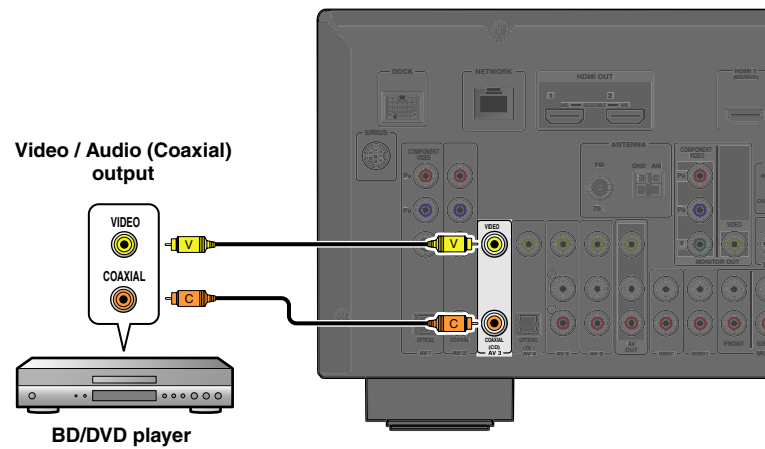

Connecting CD players and other audio devices

Using analog stereo output sources

Select the audio input (AUDIO1-2) to which the playback device is connected for playback.

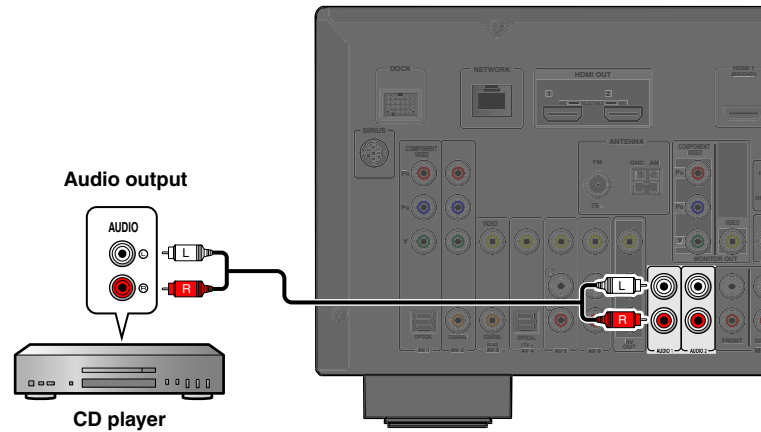

Using optical digital output sources

Select the AV input (AV1 or AV4) to which the playback device is connected for playback.

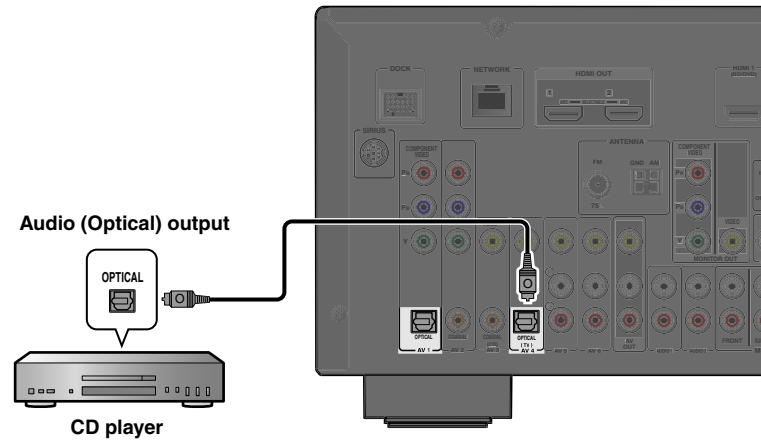

Using coaxial digital output sources

Select the AV input (AV2 or AV3) to which the playback device is connected for playback.

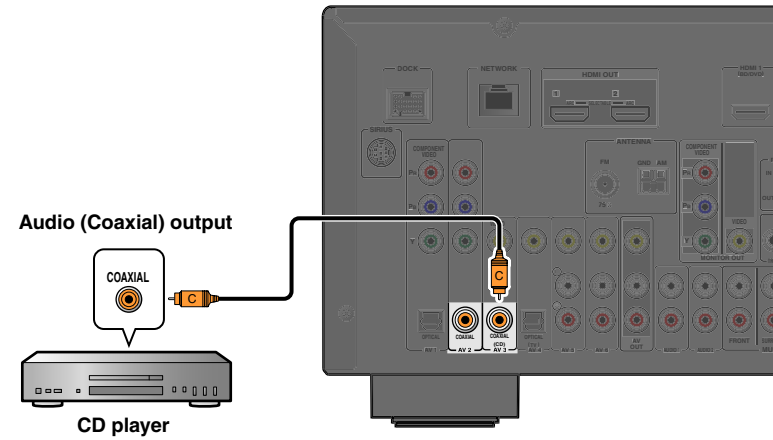

We recommend connecting audio devices with a coaxial digital output to the AV3 coaxial digital jack on this unit. This connection allows you to switch to the AV input 3 just by pressing the “CD” SCENE key (p. 44).

Connecting game consoles

Use the VIDEO AUX jacks on the front panel to temporarily connect devices such as a game console to the receiver.

Select the V-AUX input to use these connected devices.

When connecting an HDMI compatible device

Connect the HDMI output of the device to the HDMI IN jack of this unit.

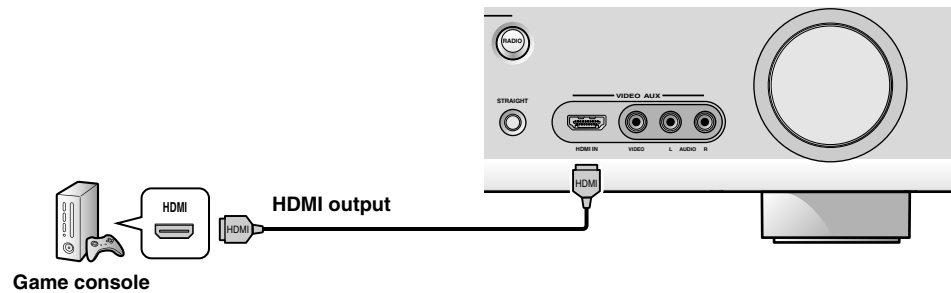

When connecting a non-HDMI compatible device

Connect the video and audio outputs of the device to the VIDEO and AUDIO jacks of this unit.

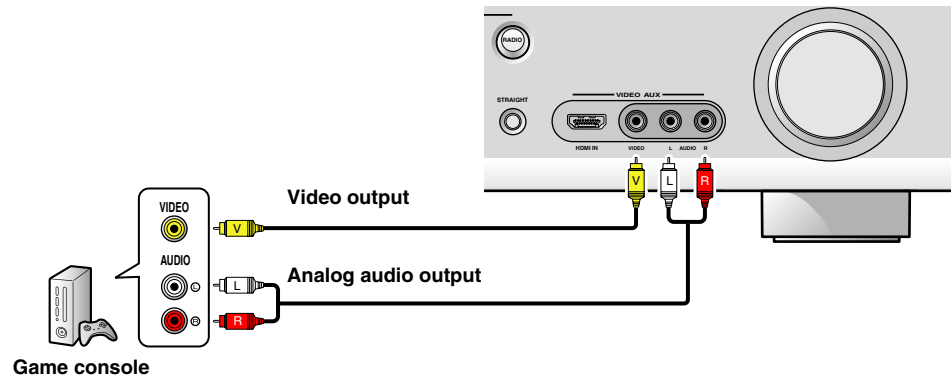

- Be sure to turn down the volume when connecting this unit and the other devices.
- When both the HDMI connection and the analog video/audio connection are performed between the HDMI compatible device and this unit, only the HDMI signal will be input.

Connecting a multi-format player or an external decoder

This unit has 8 sets of input jacks (FRONT L/R, CENTER, SURROUND L/R, SUR. BACK L/R and SUBWOOFER) to input multi-channel analog sound signals. If your playback component, such as a DVD player or SACD player, has multi-channel analog output capability, you can enjoy up to 7.1-channel multi-channel sound. To output multi-channel sound, connect the audio output jacks of your playback component to the MULTI CH INPUT jacks of this unit, and set the input source of this unit to “MULTI CH.”

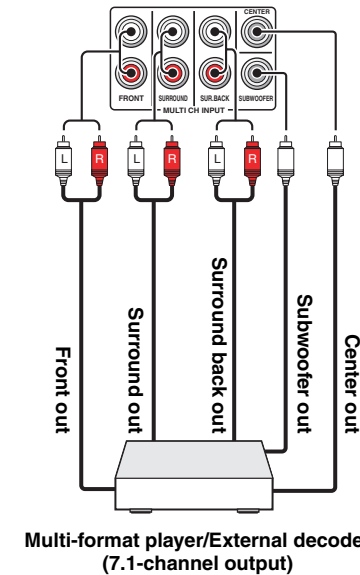

- When you select “MULTI CH” as the input source, the digital sound field processor and tone control are automatically disabled.
- Since this unit does not redirect signals input at the MULTI CH INPUT jacks to accommodate for missing speakers, connect at least a 5.1-channel speaker system when using this feature.
- When the input source is switched to “MULTI CH,” images input from a component connected to the HDMI1-5, AV1-6, or VIDEO AUX jacks can be displayed on a video monitor ([p. 89](#)). If your DVD player does not support multi-channel digital output, connect it to these input jacks.

Connecting an external amplifier

The same channel signals are output from the jacks of the PRE OUT terminals as from their corresponding SPEAKERS terminals. When connecting an external power amplifier (pre-main amplifier) to enhance speaker output, connect the input terminals of the power amplifier to the PRE OUT terminals of this unit.

NOTE

When a component is connected to the PRE OUT terminals, do not connect speakers to the SPEAKERS terminals corresponding to those PRE OUT terminals.

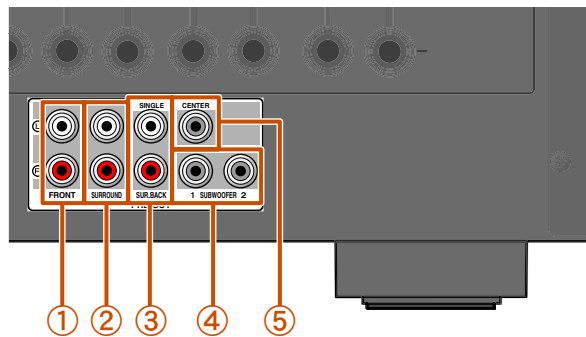

- ① **FRONT (PRE OUT) jacks**
Front channel output jacks.
- ② **SURROUND (PRE OUT) jacks**
Surround channel output jacks.
- ③ **SUR. BACK (PRE OUT) jacks**
Surround back output jacks. When you only connect one external amplifier for the surround back channel, connect it to the SUR. BACK (SINGLE) jack.
- ④ **SUBWOOFER (PRE OUT) 1/2 jack**
Connect a subwoofer with a built-in amplifier. When two subwoofers are connected, the same sound is output from them.
- ⑤ **CENTER (PRE OUT) jack**
Center channel output jack.

Connecting a SCENE link playback-compatible device

When the components are the Yamaha products and have the capability of the transmission of the remote control signals, connect the REMOTE IN and REMOTE OUT jacks to the remote control input and output jack with the monaural analog mini cable as follows.

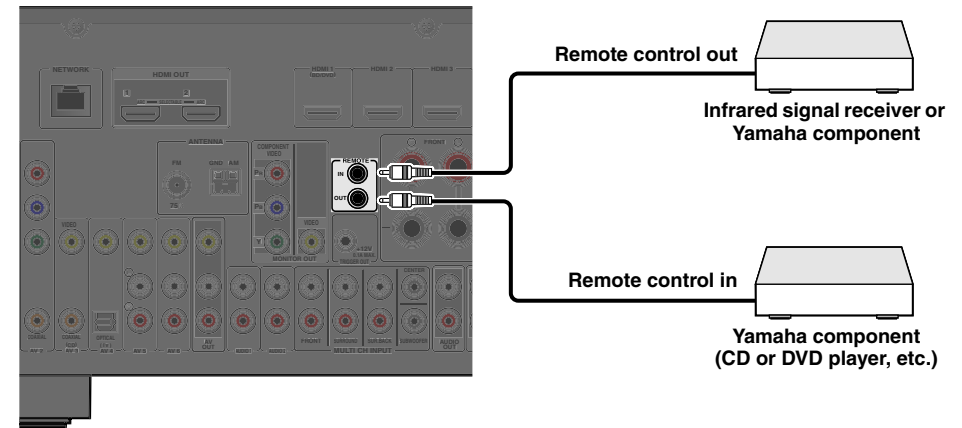

- When a Yamaha component that supports the SCENE link playback function is connected via the REMOTE OUT jack, playback begins automatically when the SCENE function is used (p. 44).
- If the component connected to the REMOTE OUT jack is not a Yamaha product, set “SCENE IR” in the SCENE menu to “Off” (p. 91).

Using the Trigger function to link external component power

When this unit is connected to a Yamaha subwoofer that supports the system connection or the component with TRIGGER IN jack, you can turn on and off the component by using this unit.

When connecting a Yamaha subwoofer

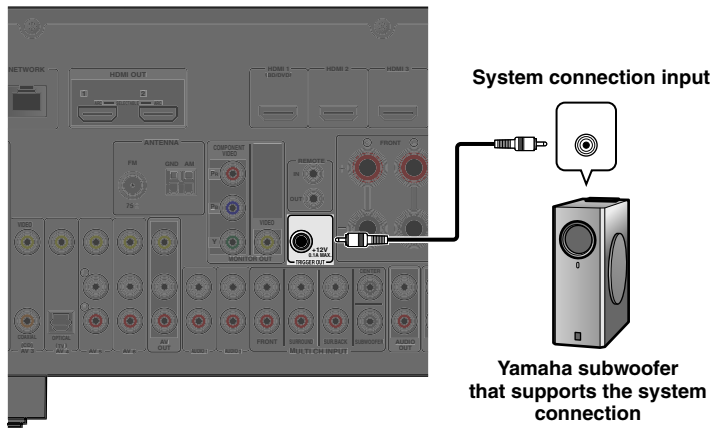

When connecting a component with the TRIGGER IN jack

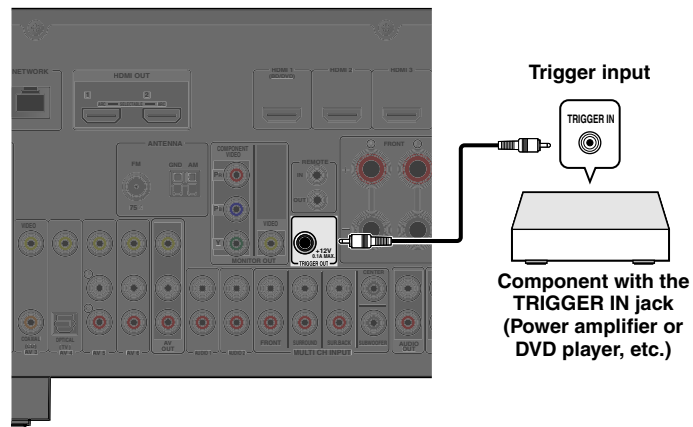

Connecting audio/video recording devices

This receiver can transmit selected incoming analog audio/video signals to external components through the AV OUT and AUDIO OUT jacks. You can record these input audio and video signals to VCRs or similar devices, or send them to other TVs or external components.

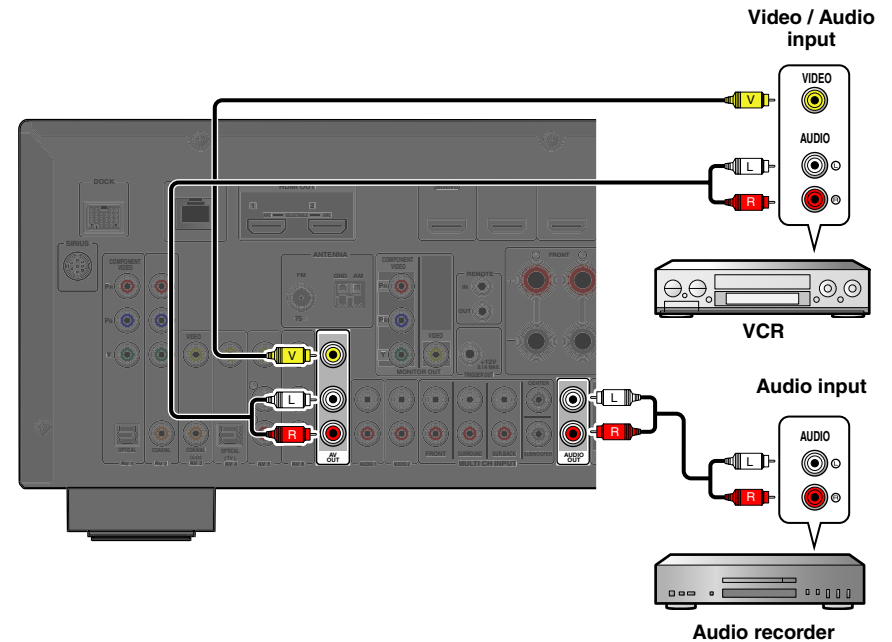

Using the AV OUT jacks

Connect this jacks to the external component's video input jack and analog audio input jacks.

Using the AUDIO OUT jacks

Connect this jack to the external component's analog audio input jacks.

HDMI audio/video signals, component video signals, and digital audio signals cannot be transmitted from these jacks.

Functions of the TRIGGER OUT jack can be specified ([p. 111](#)).

Connecting to the network

To connect this unit to your network, plug one end of a network cable (CAT-5 or higher straight cable) into the NETWORK port of this unit, and plug the other end into one of the LAN ports on your router that supports the DHCP (Dynamic Host Configuration Protocol) server function. To enjoy Internet Radio or music files saved on PC and DLNA server such as NAS (Network Attached Storage), each device must be connected properly in the network.

- Use an STP (shielded twisted pair) cable (commercially available) to connect a network hub or router and this unit.
- If the DHCP server function on your router is disabled, you need to configure the network settings manually ([p. 108](#)).

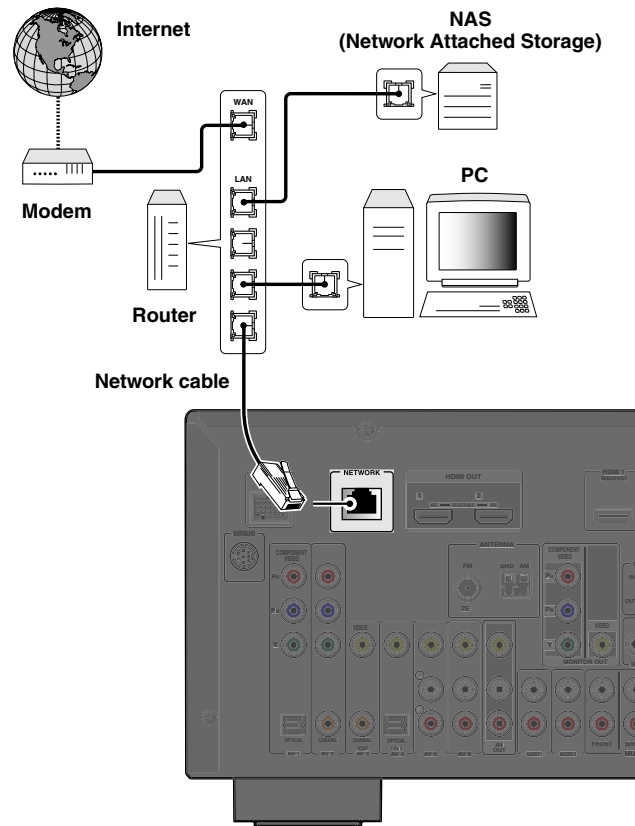

Connecting the FM/AM antennas

An indoor FM antenna and an AM loop antenna are supplied with this receiver. Connect these antennas properly to their respective jacks.

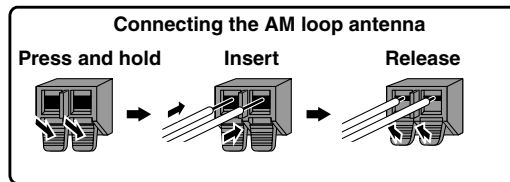
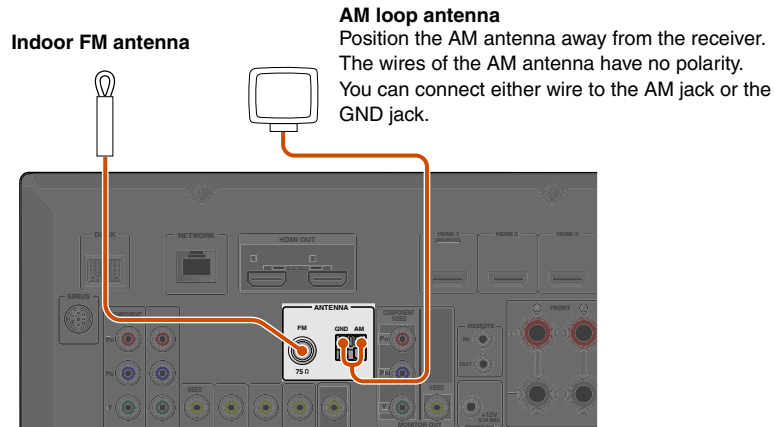

Assembling the AM loop antenna

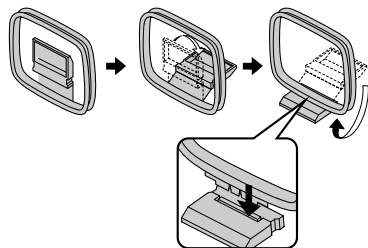

■ Improving FM reception

We recommend using an outdoor antenna. For more information, consult the nearest authorized dealer.

■ Improving AM reception

Connect this unit to an outdoor antenna with a 16.4 – 32.8 ft. (5 – 10 m) vinyl-coated wire. Make sure the AM loop antenna is still connected.

Connecting the GND jack can reduce noise. Connect the jack to a store-bought ground bar or copper plate with a vinyl-covered wire and bury this new attachment in moist ground. The GND jack is not to be connected to the ground socket of an electrical outlet.

Setting up the speaker parameters automatically (YPAO)

This unit is equipped with a Yamaha Parametric Room Acoustic Optimizer (YPAO) that adjusts the configuration, size, and volume balance of the speakers in order to provide an optimal sound field. Using YPAO allows you to automatically configure settings, such as adjusting speaker output and acoustic parameters to suit your listening room (the room in which this unit is placed). 🌟1

The amount of time for measurement varies from about two to ten minutes according to settings. Be aware of the following when using YPAO.

- The test tone is output at high volume. Refrain from using this function at night when it may be a nuisance to others.
- Take care that the test tone does not frighten small children.

YPAO operations can be viewed on the front panel display or TV screen.

1 Check the following before using YPAO.

This unit

- The headphones are removed.

TV

- This unit is connected to the TV correctly.
- The power is turned on.
- The video input to which the video output from this unit has been selected.

Subwoofer

- The power is turned on.
- Volume is set to approximately half, and the cross-over frequency (if present) is set to maximum.

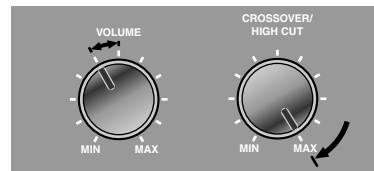

Subwoofer examples

2 Place the supplied YPAO microphone at ear height in your listening position.

Face the head of the YPAO microphone upwards.

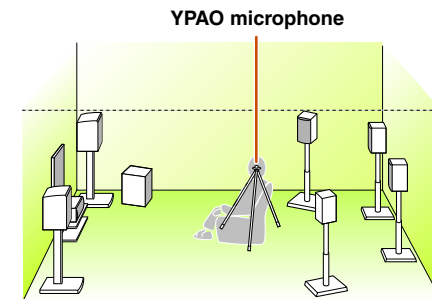

When positioning the microphone, we recommend that you use equipment that allows you to adjust the height (such as a tripod) as a microphone stand. When using a tripod, use the tripod screws to fix the microphone in place.

3 Switch this unit on.

Continues to the next page

🌟 1: When you have changed the number of speakers or the locations in which they are installed, first use YPAO to adjust the speaker balance.



11 Cursor Δ / ∇

11 ENTER

4 Connect the YPAO microphone to the YPAO MIC jack on the front panel.

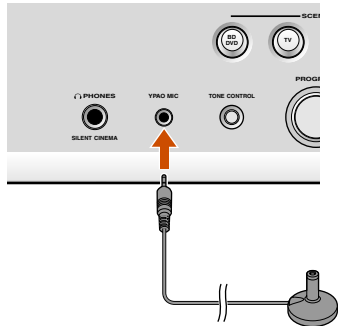

“Mic On. View ON SCREEN” appears on the front panel display, and the following display appears on the front panel display or TV screen.

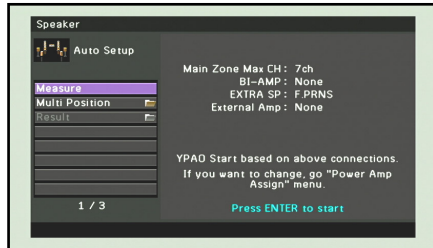

5 Press 11 Cursor Δ / ∇ to select the “Multi Position” and press 11 ENTER to set the number of listening positions to measure.

To measure at the multiple listening positions (up to 8), press 11 Cursor Δ / ∇ to select “Yes” and press 11 ENTER.

To measure at one listening position, press 11 Cursor Δ / ∇ to select “No” and press 11 ENTER.

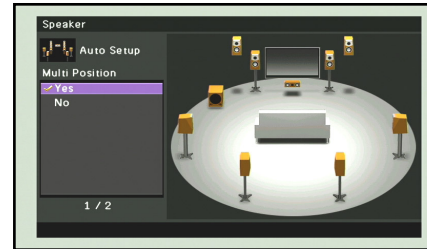

“Multi Position” is set to “Yes” at initial factory settings. It is not necessary to perform step 5 when measuring at the multiple listening positions.

This completes preparation. To achieve more accurate results, take note of the following when measuring acoustics.

- It takes a few minutes to accurately measure acoustics for one position. Keep the room as quiet as possible while acoustics are measured.
- Wait in a corner of the room, or leave it entirely, while acoustics are measured to avoid creating an obstruction between the speakers and the YPAO microphone.

Continues to the next page





- 11 Cursor Δ / ∇
- 11 ENTER
- 11 RETURN

6 Press **11**Cursor Δ / ∇ repeatedly to select the “Measure” and press **11**ENTER to start measurement.

Auto measurement starts in 10 seconds.

- To start the measurement immediately, press **11**ENTER again.
- To cancel the automatic setup and return to the previous screen, press **11**RETURN and then **11**ENTER.

Display during measurement

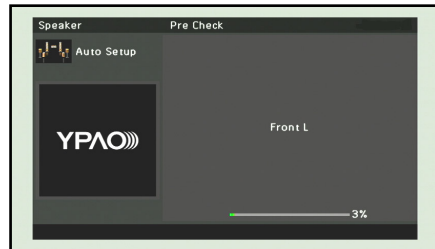

When “Multi Position” is set to “No” in step 5
The following display appears when measurement finishes without any problems.

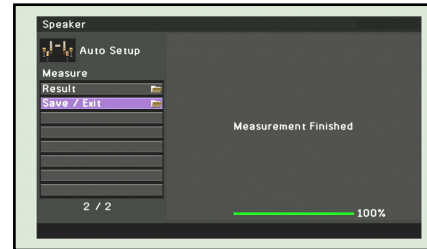

Go to step 8.

When “Multi Position” is set to “Yes” in step 5
The following display appears when measurement at the first position finishes without any problems.

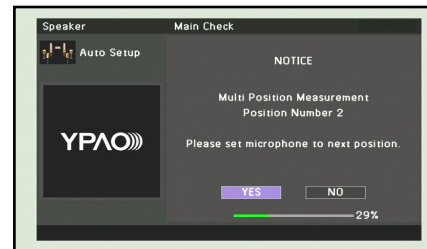

Go to step 7.

7 Replace the optimizer microphone at your choosing position and press **11**ENTER to restart the automatic measurement.

Auto measurement restarts in 10 seconds.

The following illustration shows how to place the optimizer microphone to optimize the setup of this unit for 8 listening positions for example.

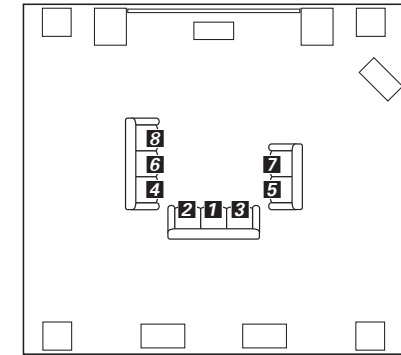

Repeat step 7 until the measurement at all listening positions are made.

Continues to the next page



11 Cursor $\Delta / \nabla / \triangleleft / \triangleright$

11 ENTER

The following display appears again when measurement at the last position finishes without any problems.

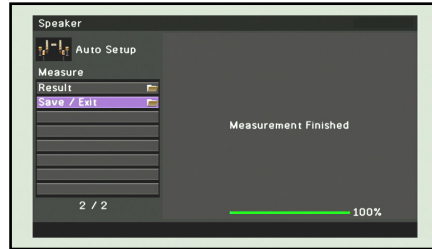

NOTE

If a problem occurs, an error message or report is displayed either during or after acoustic measurement. Refer to “When an error message is displayed during measurement” (p. 39), or “When a warning message is displayed after measurement” (p. 39) to resolve the problem and measure acoustics with YPAO again.

Result	Displays the results of automatic acoustics measurement. Refer to “Reviewing automatic setup parameters” for details (p. 38).
Save/Exit	Applies the result to the speaker setup and finishes the automatic measurement.

8 Press 11 Cursor Δ / ∇ to select “Save/Exit” and press 11 ENTER.

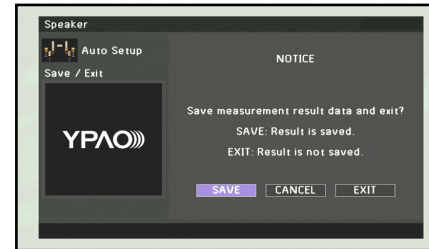

9 Press 11 Cursor $\triangleleft / \triangleright$ to select “SAVE” and press 11 ENTER.

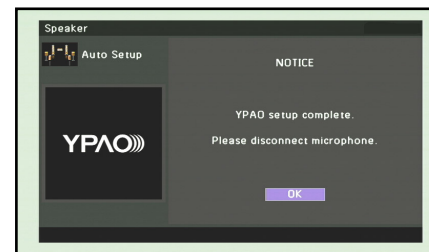

10 Press 11 ENTER. Automatic setup is completed. Disconnect the YPAO microphone.

The YPAO microphone is sensitive to heat. When you have finished measuring, store the microphone out of direct sunlight, and away from locations that may experience high temperatures, such as on top of AV equipment.





Reviewing automatic setup parameters

The results of automatic acoustics measurement can be reviewed once measurement is complete.

NOTE

When automatic setup parameters are reloaded, manually configured settings are cleared. To save manually configured settings before reloading automatic setup parameters, see “Prohibiting setting changes” (p. 112).

- 1 Press **Cursor** Δ / ∇ repeatedly to select “Result” and press **ENTER** immediately after the automatic measurement.

The Result menu can be viewed only by performing the automatic measurement.

The results of acoustics measurement are displayed.

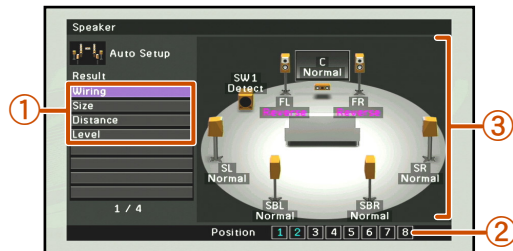

- 1 **List of menu items**
Menu items available in the Result menu are displayed.
- 2 **Number of measurement**
Indicates the number of measurements for multiple listening positions.
- 3 **Diagram**
Shows the speaker setup and sound adjustment as diagram.

- 2 Select the desired menu item (or enable a function) using **Cursor** $\Delta / \nabla / \leftarrow / \rightarrow$ and **ENTER**.

Wiring	Displays the polarity of each connected speaker. <ul style="list-style-type: none"> “Normal” is displayed when the polarity of the connected speaker is normal.
Size	Displays the size of the connected speakers. <ul style="list-style-type: none"> “Large” is displayed when the connected speaker has the ability to reproduce the low-frequency signals effectively. “Small” is displayed when the connected speaker does not have the ability to reproduce the low-frequency signals effectively.
Distance	Displays the distance from the listening position to speakers. The unit for distance can be switched between “ft” (feet) and “m” (meter) by pressing Cursor \leftarrow / \rightarrow .
Level	Displays the result of the adjustment of each connected speaker output level.
Setup Reload 	Clears the fine-adjustment with Manual Setup and reloads the result of automatic setup. For details, refer to “Reloading automatic setup parameters.”

- 3 Press **RETURN** to finish “Result” menu.

The result of automatic setup can be fine-tuned manually by “Manual Setup.” Refer to “Manual speaker setup” (p. 99) for details.

Reloading automatic setup parameters

If you are not satisfied with the fine-adjustment of setup parameters with Manual Setup, the result of automatic setup saved on this unit can be reloaded. Select “Setup Reload” in the Result menu.

NOTE

When automatic setup parameters are reloaded, manually configured settings are cleared. To avoid clearing manually configured settings by reloading automatic setup parameters, see “Prohibiting setting changes” (p. 112).

 1: This item is displayed after the fine-adjustment is performed with “Manual Setup.” Use this item to return to the settings to the result of automatic setup.



- Cursor $\Delta / \nabla / \leftarrow / \rightarrow$
- ENTER
- RETURN

■ When an error message is displayed during measurement

See “Error messages” (p. 40) for instructions on resolving the problem and measure acoustics again.

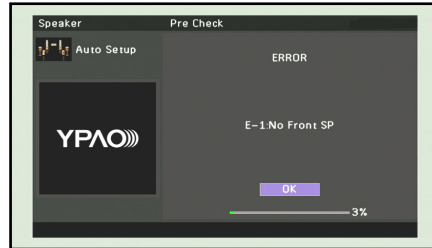

Check the error code displayed and use YPAO to measure acoustics again as described below.

When “E-1,” “E-2,” “E-3,” “E-4” or “E-6” is displayed

- 1 Press ENTER.
- 2 Press Cursor \rightarrow to select “EXIT.”
- 3 Press ENTER to terminate YPAO, and switch the unit to standby mode.
- 4 Check that the speakers are properly connected.
- 5 Turn on the unit and use YPAO again.

When “E-7” or “E-8” is displayed

- 1 Press ENTER.
- 2 Check that the environment is suitable for accurate measurement.

- 3 Press Cursor \rightarrow to select “RETRY.”

- 4 Press ENTER to use YPAO again.

When “E-5” or “E-9” is displayed:

- 1 Press ENTER.
- 2 Check that the environment is suitable for accurate measurement.
- 3 Press Cursor \leftarrow / \rightarrow to select a option.
 PROCEED:
 When “E-5” is displayed, measurement can proceed. However, the measurement in noisy environment may reduce the accuracy.
 When “E-9” is displayed, resume the aborted step.
 RETRY:
 Restart measurement from the beginning.
- 4 Press ENTER to execute the selected option.

When “E-10” is displayed:

- 1 Press ENTER.
- 2 Press Cursor \rightarrow to select “EXIT.”
- 3 Press ENTER to terminate YPAO, and switch the unit to standby mode.
- 4 Turn on the unit and use YPAO again.

■ When a warning message is displayed after measurement

See “Warning messages” (p. 41) for instructions on resolving the problem. The speaker causing the problem can be confirmed from the TV screen display.

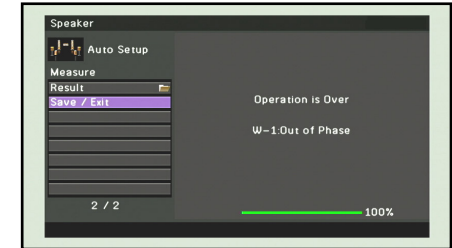

NOTE

Although the results of acoustics measurement can be applied when a warning message is displayed, optimal sound will not be achieved. Resolving the problem and using YPAO to measure acoustics again is recommended.

To exit YPAO with some options

- 1 Use Cursor Δ / ∇ to select “Save/Exit” and press ENTER.
- 2 Use Cursor \leftarrow / \rightarrow to select one of the following options and press ENTER.
 SAVE:
 Exits YPAO applying the results of measurement.
 CANCEL:
 Returns to the previous screen (warning message screen).
 EXIT:
 Exits YPAO without saving the results.

Message list

NOTE

If the following messages appear, resolve the problems that have occurred and carry out the measurement process again.

When a warning message is displayed before measurement

Connect MIC!	The YPAO microphone is not connected.	Connect the YPAO microphone to the YPAO MIC jack on the front panel.
Unplug HP!	The headphones are connected.	Remove the headphones.
Memory Guard!	The settings of this unit are protected.	Set "Memory Guard" in the Setup menu to "Off" (p. 112).

Error messages

E-1: No Front SP	The unit was not able to find the front channel.	Check that the left and right front speakers are connected correctly.
E-2: No Sur. SP	The unit was only able to find one of side of the surround channels.	Check that the left and right surround speakers are connected correctly.
E-3: No F.PRNS SP	The unit was only able to find one of side of the presence channels.	Check that the left and right presence speakers are connected correctly.
E-4: SBR→SBL	Only one surround back speaker is connected and only the right side surround back channel sound is detected.	When only one surround back speaker is connected, connect to the left side (SINGLE) terminal.
E-5: Noisy	The noise is too loud, preventing accurate measurements from being taken.	Measure again in quiet surroundings. Turn off any devices in the room that may be emitting noise, or place them further away from the YPAO microphone. When this message is displayed, selecting "PROCEED" will allow you to continue measuring. However, we recommend resolving the problem and measuring again, as continuing measurement without doing so will not give accurate results.
E-6: Check Sur.	Even though surround left and right speakers are not connected, only the surround back speakers are connected.	When using surround back speakers, connection of the surround left/right speakers is necessary.

E-7: No MIC	The YPAO microphone has been removed.	While measuring, take care not to touch the YPAO microphone.
E-8: No Signal	The YPAO microphone could not distinguish a test tone.	Check that the YPAO microphone has been installed correctly.
		Check that each speaker has been connected and installed correctly.
		The YPAO microphone or the YPAO MIC jack may be broken. Inquire at the retailer where you purchased this unit, or the nearest Yamaha service center.
E-9: User Cancel	You have carried out an operation that has cancelled the measuring process.	Carry out the measuring process again. Do not operate this unit by, for example, adjusting the volume.
E-10: Internal Error	An internal error has occurred.	Carry out the measuring process again. Contact a Yamaha service center if "E-10" is displayed again.



■ Warning messages

<p>W-1: Out of Phase</p>	<p>The speakers displayed are connected with the opposite polarity. Depending on the type of speakers you are using and the environment in which you have them installed, this message may occur even if the speakers are connected correctly.</p>	<p>Depending on the type of speakers, “W-1” may display even if the speakers are connected correctly.</p> <hr/> <p>Check that the speaker polarity + (positive), and - (negative) are correct. If these are connected correctly, you can use the speakers normally even this message appears.</p>
<p>W-2: Over 24m/80ft</p>	<p>The speakers displayed are separated from the listening position by more than 24 m, and cannot be adjusted correctly.</p>	<p>Install the speakers with 24 m of the listening position.</p>
<p>W-3: Level Error</p>	<p>Volume level varies greatly for individual channels, and cannot be adjusted correctly.</p>	<p>Check that all speakers are installed in the same surroundings.</p> <hr/> <p>Check that the speaker polarity + (positive), and - (negative) are correct.</p> <hr/> <p>We recommend the same speakers or speakers with as similar specifications as possible.</p> <hr/> <p>Adjust the volume of the subwoofer.</p>

If “W-2” or “W-3” appears, you can apply measurement results, but they will not give optimal results. We recommend that you resolve the problem and carry out the measurement process again.

PLAYBACK

Basic playback procedure

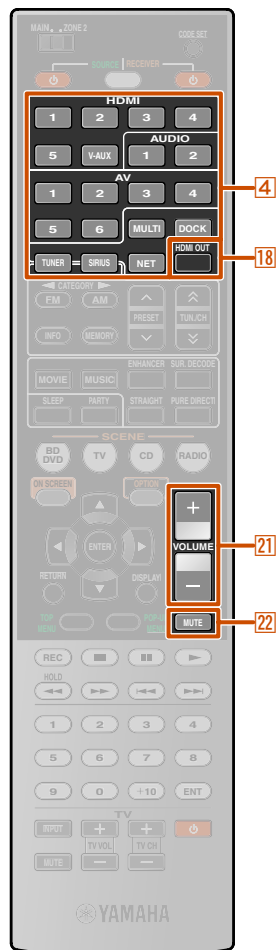

- 4 Input selector
- 18 HDMI OUT
- 21 VOLUME +/-
- 22 MUTE

1 Turn on external components (TV, DVD player, etc.) connected to this unit.

2 Use the **4** Input selector to select the input source.

The name of the selected input source is displayed for a few seconds. 1

When DOCK, TUNER, SIRIUS, or NET is selected, the Content window is displayed ([p. 56](#)).

3 Play the external component that you have selected as the source input, or select a radio station on the tuner.

Refer to the instruction manuals provided with the external component for details on playback.

For details on the following operations, refer to the corresponding pages:

- “FM/AM tuning” ([p. 57](#))
- “Listening to SIRIUS Satellite Radio™” ([p. 61](#))
- “Playing back tunes on the PC” ([p. 67](#))
- “Listening to the Internet Radio” ([p. 69](#))
- “Using the Rhapsody® service” ([p. 71](#))
- “Listening to the SIRIUS Internet Radio” ([p. 75](#))
- “Playing back tunes from your iPod™/iPhone™” ([p. 79](#))
- “Playing back tunes from Bluetooth™ components” ([p. 83](#))

4 Press **21** VOLUME +/- to adjust the volume.

To mute the output.

Press **22** MUTE to mute the audio output.

Press **22** MUTE again to unmute.

Selecting the active HDMI OUT jack

Use this function to select the HDMI OUT jack(s) used to output signal.

Press **18** HDMI OUT repeatedly to select setting.

The HDMI output setting changes as follows.



HDMI OUT 1+2	Outputs the signal at both the HDMI OUT 1 and HDMI OUT 2 jacks simultaneously.
HDMI OUT 1	Outputs the signals at the HDMI OUT 1 jack.
HDMI OUT 2	Outputs the signals at the HDMI OUT 2 jack.
HDMI OUT Off	Any signals are not output at the HDMI OUT 1 and HDMI OUT 2 jacks. Select this setting when you do not use the video monitor connected to one of the HDMI OUT jacks.

- The HDMI OUT jack that utilizes the HDMI Control function can be selected with “Control Select” ([p. 106](#)).
- The active HDMI OUT jack(s) can be registered with the SCENE function ([p. 44](#)).

1 : You can change the input source name displayed on the front panel display as necessary ([p. 88](#)).

■ Adjusting high/low-frequency sound (Tone control)

You can adjust the balance of the high-frequency range (Treble) and low-frequency range (Bass) of sounds output from the front left and right speakers to obtain desired tone.

The tone control of the speakers or headphones can be set separately. Set the headphone tone control with the headphones connected.

1 Press TONE CONTROL on the front panel repeatedly to select “Treble” or “Bass.”

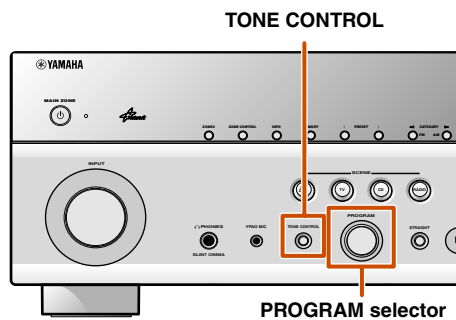

The current setting is displayed on the front panel display.



2 Rotate PROGRAM selector to adjust the output level in those frequency ranges.

Adjustable range	-6.0 dB to +6.0 dB
Adjustment increments	0.5 dB

The display returns to the previous display soon after you release the key.

- The tone control settings are not effective when this unit is in the Pure Direct mode or “MULTI CH” is selected as an input source.
- If you set the balance extremely off, sounds may not match those from other channels well.
- The tone control can also be adjusted in the Option menu ([p. 54](#)).

Changing input settings with a single key (SCENE function)

This unit has a SCENE function that allows you switch this unit on and change input sources, sound programs, and HDMI OUT with one key.

Four scenes are available for different uses, such as playing movies or music. The following input sources, sound programs, and HDMI OUT are provided as the initial factory settings.

SCENE	Input	Sound program	Compressed Music Enhancer	HDMI OUT
BD/DVD	HDMI1	Drama	Off	HDMI OUT 1+2
TV	AV4	STRAIGHT	On	HDMI OUT 1+2
CD	AV3	STRAIGHT	Off	HDMI OUT 1+2
RADIO	TUNER	STRAIGHT	On	HDMI OUT 1+2

Registering input sources/sound program/HDMI OUT

- 1 Use **[4]** Input selector to select the input source you want to register.
- 2 Use the **[19]** Sound selection keys or **[18]** HDMI OUT to select the sound program, Compressed Music Enhancer, or HDMI OUT you want to register.

- 3 Press the **[9]** SCENE key until “SET Complete” appears on the front panel display.



Release the key when “SET Complete” is displayed

- When changing “SCENE,” also change the external component that the remote control operates ([p. 115](#)).
- Selecting a scene and editing the scene function are also available in the SCENE menu ([p. 90](#)).

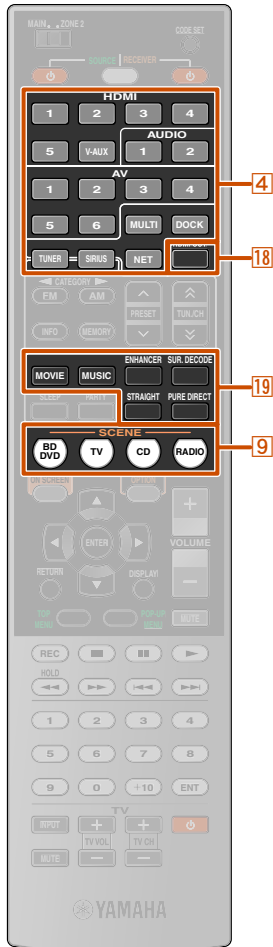

- [4]** Input selector
- [9]** SCENE
- [18]** HDMI OUT
- [19]** Sound selection keys

Enjoying favorite sound field effect

This unit is also equipped with a Yamaha digital sound field processing (DSP) chip. Multi-channel playback from almost any audio source can be enjoyed using a variety of sound decoders and various sound field effect programs stored on the chip. Sound field effect programs built into this unit are called “sound programs.”

Selecting sound programs and sound decoders

This unit offers sound programs in many different categories suitable for movies, music and other uses. Choose a sound program that sounds best with the source you are playing back, rather than relying on the name or explanation of the program.

- Sound programs are stored for each input source. When you change the input source, the sound program previously selected for that input source is applied again.
- When you playback DTS Express sources or audio signals with sampling frequency of higher than 96 kHz, the straight decoding mode ([p. 45](#)) is automatically selected.
- When you playback DTS-HD sources with CINEMA DSP, the DTS decoder is automatically selected.

Continues to the next page



Selecting sound program (p. 48):
 MOVIE category: Press **[19] MOVIE** repeatedly
 MUSIC category: Press **[19] MUSIC** repeatedly

Selecting stereo reproduction:
 Press **[19] MUSIC** repeatedly

Selecting surround decoder:
 Press **[19] SUR. DECODE** repeatedly

Turning on Straight decoding mode:
 Press **[19] STRAIGHT**

Turning on Pure Direct mode (p. 47):
 Press **[19] PURE DIRECT**

Turning on Compressed Music Enhancer (p. 47):
 Press **[19] ENHANCER** repeatedly

Sound program categories



Program

- You can use the speaker indicators on the front panel display to check what speakers are currently outputting sound (p. 10).
- You can adjust sound field elements (sound field parameters) for each of the programs (p. 93).

Enjoying unprocessed playback (Straight decoding mode)

Use straight decoding mode when you want to playback sound without sound field processing. You can playback as follows in straight decoding mode.

2-channel sources such as CD

Stereo sound plays through the front left and right speakers.

Multi-channel playback sources such as BD/DVD

Plays back audio from a playback source without applying sound field effects, using an appropriate decoder to split the signal into multiple channels.

Press **[19] STRAIGHT** to enable the straight decoding mode.



To disable straight decoding mode, press **[19] STRAIGHT** again.



Previously selected program

Enjoying stereo playback

Select “2ch Stereo” from the sound programs when you want to playback 2-channel stereo sound (from the front speakers only), regardless of the playback source. Selecting “2ch Stereo” will playback as follows for the playback of CD and BD/DVD sources.

2-channel sources such as CD

Stereo sound plays back through the front speakers.

Multi-channel sources such as BD/DVD

Playback channels other than the front channels in the playback source are mixed with the front channels and played back through the front speakers.

Press **[19] MUSIC** repeatedly to select “2ch Stereo.”



To disable stereo playback, press any of the **[19] Sound selection keys** to select a sound program other than “2ch Stereo.”

- [19] Sound selection keys**
- [19] MOVIE**
- [19] MUSIC**
- [19] ENHANCER**
- [19] SUR. DECODE**
- [19] STRAIGHT**
- [19] PURE DIRECT**

Enjoying sound programs without surround speakers

This unit allows you to use virtual surround speakers to enjoy sound field surround effects, even without any surround speakers (Virtual CINEMA DSP mode). You can even enjoy surround sound presence with just a minimal configuration of the front speakers only.

This unit will switch to Virtual CINEMA DSP mode automatically when surround speakers are unavailable. 1

Enjoying sound programs with headphones

Even when headphones are connected, you can enjoy the reproduction sound field presence with ease (SILENT CINEMA mode). 2

Enjoying more spatial sound fields (CINEMA DSP 3D mode)

CINEMA DSP 3D mode creates an intensive and accurate stereoscopic sound field in the listening room.

Connection of presence speakers is recommended to take full advantage of the effects of CINEMA DSP 3D mode. Do the following steps. 3

- Connect the presence speakers to the EXTRA SP jacks and set the speakers to use ([p. 15](#)).
- Enable CINEMA DSP 3D Mode in the Option menu ([p. 53](#)).

When a sound program runs in CINEMA DSP 3D mode, the CINEMA DSP 3D indicator on the front panel lights up.

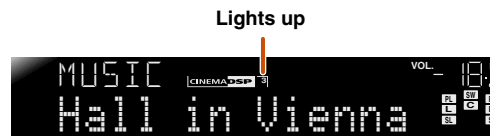

Enjoying sound programs without presence speakers

This unit allows you to use virtual presence speakers to create an intensive and accurate stereoscopic sound field, even when no presence speakers are connected (Virtual CINEMA DSP 3D mode). You can even enjoy surround sound presence with front speakers, center speaker, and surround speakers.

This unit automatically switches to Virtual CINEMA DSP 3D mode when presence speakers are not available.

Do the following steps.

- Connect the front speakers, center speaker, and surround speakers.
- Enable center speaker and surround speakers in “Configuration” ([p. 100](#)).
- Enable CINEMA DSP 3D Mode in the Option menu ([p. 53](#)).

1: However, Virtual CINEMA DSP mode is not available under the following conditions:

- When headphones are connected to this unit.
- When a “7ch Stereo” or “2ch Stereo” sound program is selected.
- When Pure Direct mode or straight decoding mode is selected.

2: However, SILENT CINEMA mode is not available under the following conditions:

- When a “2ch Stereo” sound program is selected.
- When Pure Direct mode or straight decoding mode is selected.

3: However, CINEMA DSP 3D mode is not available under the following conditions:

- When headphones are connected to this unit.
- When a “7ch Stereo” or “2ch Stereo” sound program is selected.
- When Pure Direct mode or straight decoding mode is selected.

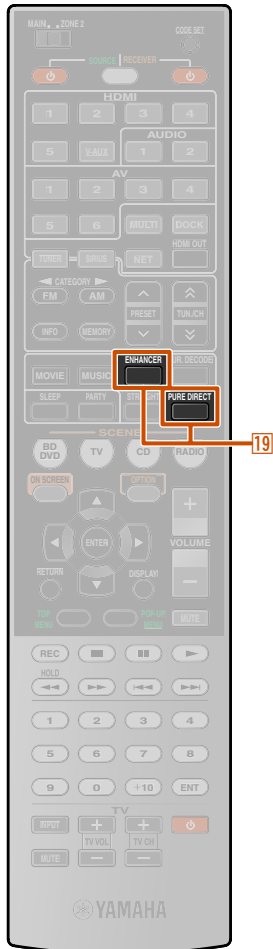

19 ENHANCER
19 PURE DIRECT

Enjoying Hi-Fi Sound Quality (Pure Direct mode)

Use Pure Direct mode to enjoy the pure high fidelity sound of the selected source. When Pure Direct mode is enabled, this unit plays back the selected source with the least circuitry. 🌟1

Press **19** PURE DIRECT to turn Pure Direct mode on. 🌟2

To disable Pure Direct mode, press **19** PURE DIRECT again.

Enjoying compressed music source with better sound quality (Compressed Music Enhancer)

Compressed Music Enhancer mode improves the sound enhancer near to the original depth and width of compression artifacts. 🌟3
This mode can be used along with any other DSP modes.

Press **19** ENHANCER to turn Compressed Music Enhancer on.

Lights up when Compressed Music Enhancer is active



To disable Compressed Music Enhancer, press **19** ENHANCER again.

🌟1 : The following features are disabled in Pure Direct mode.

- sound program, tone control, YPAO PEQ, and Adaptive DRC
- displaying and operating the Option menu and Setup menu

🌟2 : While Pure Direct mode is on, the front panel display screen turns off in order to reduce noise. When turning Pure Direct mode off, the screen returns on.

🌟3 : However, Compressed Music Enhancer is not available in the following audio:







- Signals of which sampling rate is over 48kHz
- High Definition stream



Sound programs

 in the table indicates the sound program for CINEMA DSP.

Category: MOVIE







Sound programs optimized for viewing video sources such as movies, TV programs, and games.

Standard 	<p>This program creates a sound field emphasizing the surround feeling without disturbing the original acoustic positioning of multi-channel audio such as Dolby Digital and DTS. It has been designed with the concept of an ideal movie theater, in which the audience is surrounded by beautiful reverberations from the left, right and rear.</p>
Spectacle 	<p>This program represents the spectacular feeling of large-scale movie productions. It reproduces a broad theater sound field that matches cinemascope and wider-screen movies with an excellent dynamic range providing everything from very small sound effects to large, impressive sounds.</p>
Sci-Fi 	<p>This program clearly reproduces the finely elaborated sound design of the latest science fiction and special effects-featuring movies. You can enjoy a variety of cinematographically created virtual spaces reproduced with clear separation between dialog, sound effects and background music.</p>
Adventure 	<p>This program is ideal for precisely reproducing the sound design of action and adventure movies. The sound field restrains reverberations but puts emphasis on reproducing a powerful space expanded widely to the left and right. The reproduced depth is also restrained relatively to ensure the separation between audio channels and the clarity of the sound.</p>
Drama 	<p>This sound field features stable reverberations that match a wide range of movie genres from serious dramas to musicals and comedies. The reverberations are modest but offer an optimum 3D feeling, reproducing effects tones and background music softly but cubically around clear words and center positioning in a way that does not fatigue the listener even after long hours of viewing.</p>
Mono Movie 	<p>This program is provided for reproducing monaural video sources such as a classic movie in an atmosphere of a good old movie theater. The program produces the optimum expansion and reverberation to the original audio to create a comfortable space with a certain sound depth.</p>
Sports 	<p>This program allows the listeners to enjoy stereo sport broadcasts and studio variety programs with enriched live feeling. In sports broadcasts, the voices of the commentator and sportscaster are positioned clearly at the center while the atmosphere of the stadium expands in an optimal space to offer the listeners a feeling of presence in the stadium.</p>

Action Game 	<p>This sound field is suitable for action games such as car racing, fighting games and FPS games. The reality of, and emphasis on, various effects makes the player feel like they are right in the middle of the action, allowing for greater concentration.</p> <p>Use this program in combination with Compressed Music Enhancer for a more dynamic and strong sound field.</p>
Roleplaying Game 	<p>This sound field is suitable for role-playing and adventure games. This program adds depth to the sound field for natural and realistic reproduction of background music, special effects and dialogue from a wide variety of scenes.</p> <p>Use this program in combination with Compressed Music Enhancer for a more clear and spatial sound field.</p>
Music Video 	<p>This sound field offers an image of a concert hall for live performance of pop, rock and jazz music. The listener can indulge oneself in a hot live space thanks to the presence sound field that emphasizes the vividness of vocals and solo play and the beat of rhythm instruments, and to the surround sound field that reproduces the space of a big live hall.</p>







Category: MUSIC

This sound field is suitable when listening to music sources such as CDs.

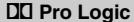
Hall in Munich 	This sound field simulates a concert hall with approximately 2500 seats in Munich, using stylish wood for the interior finishing as normal standards for European concert halls. Fine, beautiful reverberations spread richly, creating a calming atmosphere. The listener's virtual seat is at the center left of the arena.
Hall in Vienna 	This is an approximately 1700-seat, middle-sized concert hall with a shoebox shape that is traditional in Vienna. Pillars and ornate carvings create extremely complex reflections from all around the audience, producing a very full, rich sound.
Chamber 	This program creates a relatively wide space with a high ceiling like an audience hall in a palace. It offers pleasant reverberations that are suitable for courtly music and chamber music.
Cellar Club 	This program simulates a live house with a low ceiling and homey atmosphere. A realistic, live sound field features powerful sound as if the listener is in a row in front of a small stage.
The Roxy Theatre 	This is the sound field of a rock music live house in Los Angeles, with approximately 460 seats. The listener's virtual seat is at the center left of the hall.
The Bottom Line 	This is the sound field at stage front in The Bottom Line, a famous New York jazz club once. The floor can seat 300 people to the left and right in a sound field offering real and vibrant sound.
2ch Stereo	Use this program to mix down multi-channel sources to 2-channels. When multi-channel signals are input, they are down mixed to 2-channels and output from the front left and right speakers.
7ch Stereo 	Use this program to output sound from all speakers. When you playback multi-channel sources, this unit down-mixes the source to 2-channels, and then outputs the sound from all speakers. This program creates a larger sound field and is ideal for background music at parties, etc.

Category: SUR.DEC (Surround decode mode)

Select this program to playback sources with selected decoders. You can playback 2-channel audio sources in up to 7-channels using a surround decoder.

 Pro Logic	Reproduces sound using the Dolby Pro Logic decoder. This is suitable for all kinds of audio sources.
 PLIIX Movie /  PLII Movie	Reproduces sound using the Dolby Pro Logic IIx (or Dolby Pro Logic II) decoder. This is suitable for movies. 🌟1
 PLIIX Music /  PLII Music	Reproduces sound using the Dolby Pro Logic IIx (or Dolby Pro Logic II) decoder. This is suitable for music. 🌟1
 PLIIX Game /  PLII Game	Reproduces sound using the Dolby Pro Logic IIx (or Dolby Pro Logic II) decoder. This is suitable for games. 🌟1
Neo:6 Cinema	Reproduces sound using the DTS Neo:6 decoder. This is suitable for movies.
Neo:6 Music	Reproduces sound using the DTS Neo:6 decoder. This is suitable for music.

🌟1: You cannot select the Dolby Pro Logic IIx decoder in the following conditions:

- When "Surround Back" is set to "None" ([ref. p. 100](#)).
- When headphones are connected.

Using the TV display to control this unit

This unit features a sophisticated on-screen display (OSD) that helps you to control the amplifier function of this unit. With the OSD, you can view information of the signals being input and the status of this unit. Visual guidance simplifies operations for menus.

Basic operations via the TV screen display

A TV screen is required to display the ON SCREEN or Option menu. Refer to “Connecting a TV monitor” for instructions on connecting a TV screen ([p. 22](#)).

This section describes basic operations for configuring “Input,” “Scene” and “Sound Program” using the OSD.

Press **10** ON SCREEN.

The ON SCREEN menu is displayed on the TV screen.

Selecting an input source

1 Use **11** Cursor Δ / ∇ to select “Input” and press **11** ENTER.

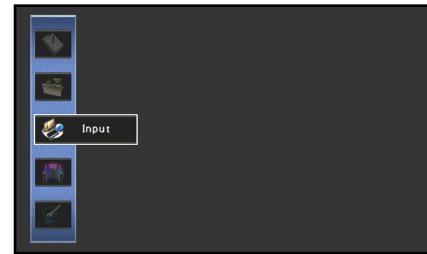

Input source icons are displayed at the bottom of the TV screen.

2 Use **11** Cursor \leftarrow / \rightarrow to select a Input source press **11** ENTER.

The input source is selected.



- Pressing **11** RETURN displays the previous menu screen. Press **11** RETURN repeatedly to close the ON SCREEN menu.
- In addition to selecting an input source, detailed settings for each input source can be configured. Refer to “Configuring input sources (Input menu)” ([p. 86](#)) for details.

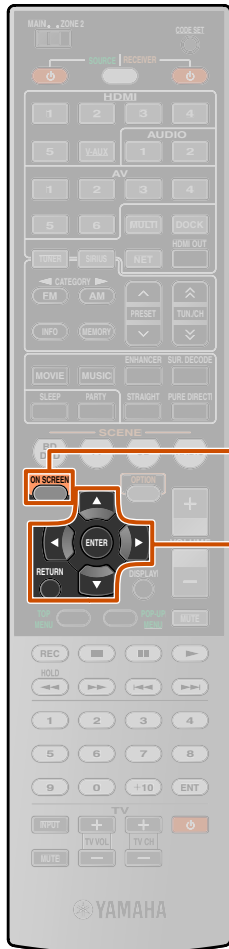

- 10** ON SCREEN
- 11** Cursor $\Delta / \nabla / \leftarrow / \rightarrow$
- 11** ENTER
- 11** RETURN



- 11 Cursor $\Delta / \nabla / \triangleleft / \triangleright$
- 11 ENTER
- 11 RETURN

Selecting a scene

- 1 Use **11**Cursor Δ / ∇ to select “Scene” and press **11**ENTER.

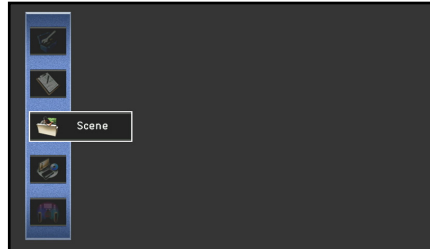

Scene icons are displayed at the bottom of the TV screen.

- 2 Use **11**Cursor $\triangleleft / \triangleright$ to select a scene and press **11**ENTER.

The scene is selected.

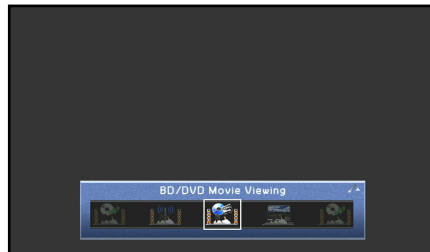

- Pressing **11**RETURN displays the previous menu screen. Press **11**RETURN repeatedly to close the ON SCREEN menu.
- Refer to “Changing input settings with a single key (SCENE function)” (p. 44) for details on the default scene settings.
- Detailed SCENE function settings can be edited. Refer to “Editing the SCENE function (SCENE menu)” (p. 90) for details.

Selecting a sound program

- 1 Use **11**Cursor Δ / ∇ to select “Sound Program” and press **11**ENTER.

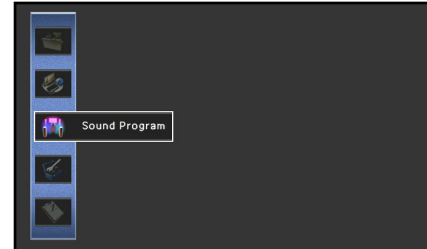

Sound program icons are displayed at the bottom of the TV screen.

- 2 Use **11**Cursor $\triangleleft / \triangleright$ to select a sound program and press **11**ENTER.

The sound program is selected.

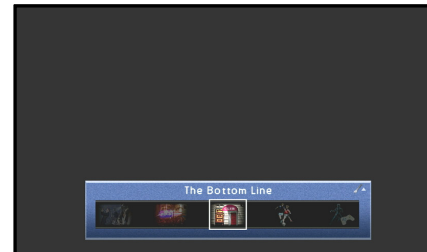

- Pressing **11**RETURN displays the previous menu screen. Press **11**RETURN repeatedly to close the ON SCREEN menu.
- Refer to “Enjoying favorite sound field effect” (p. 44) for various sound programs.
- You can configure the detailed settings for each sound program. Refer to “Setting sound program parameters (Sound Program menu)” (p. 93) for details.

NOTES

Menus can be operated and the status of this unit confirmed from the following three main displays.

- ON SCREEN menu (p. 86)
- Option menu (p. 52)
- Content window (p. 56)

These menus and status features can be used to configure more various functions in addition to selecting “Input,” “Scene” and “Sound Program.” Refer to each reference for details on menus and status.

Configuring settings specific to an individual input source (Option menu)

This unit has a unique Option menu for each input source. Option menus can be used to enable features such as volume trim for compatible input sources or to display audio/video data.

Option menu display and setup

Option menu operations are displayed on the front panel display or TV screen. TV display is used here to explain operation.

1 Use **[4]** Input selector to select an input source to which options will be applied.

2 Press **[20]** OPTION.
The Option menu is displayed.

Option menu

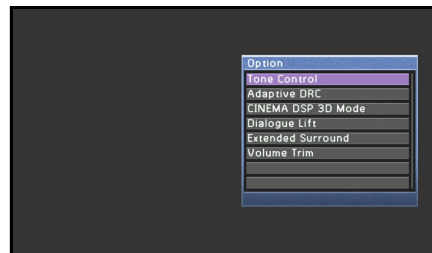

The displayed Option menu settings differ depending on the input source.

For more information, refer to the “Option menu” on the next page.

3 Use **[11]** Cursor Δ / ∇ to select the desired setting and press **[11]** ENTER.

Parameters of the selected item are displayed.

4 Use **[11]** Cursor Δ / ∇ / \triangleleft / \triangleright to select the desired item (or enable a function).

- Press **[11]** RETURN to display the previous screen or close the Option menu.
- The Option menu may close automatically when some functions are enabled.

5 Press **[20]** OPTION to close the Option menu.

The keys on the remote control may not respond for a few seconds after the Option menu is closed. Should this occur, select the input source again.

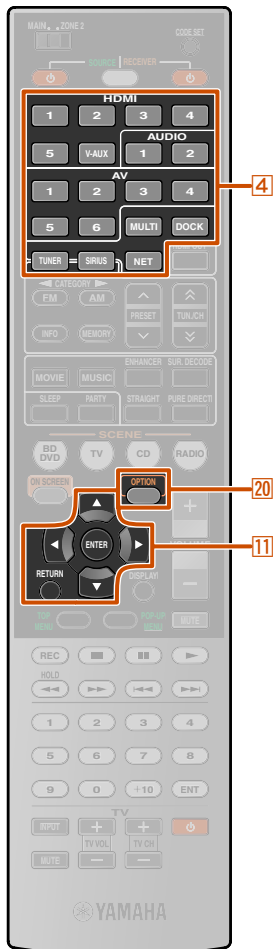

- [4]** Input selector
- [11]** Cursor Δ / ∇ / \triangleleft / \triangleright
- [11]** ENTER
- [11]** RETURN
- [20]** OPTION

Option menu

The following items are provided for each input source. “✓” indicates the available menu for each input source. 🌟1

	HDMI 1-5	AV1-4	AV5-6	AUDIO1-2	V-AUX	MULTI CH	PC	NET RADIO	Rhapsody	SIRIUS IR	DOCK (iPod)	DOCK (Bluetooth)	TUNER	SIRIUS
Tone Control	✓	✓	✓	✓	✓		✓	✓	✓	✓	✓	✓	✓	✓
Adaptive DRC	✓	✓	✓	✓	✓		✓	✓	✓	✓	✓	✓	✓	✓
CINEMA DSP 3D Mode	✓	✓	✓	✓	✓		✓	✓	✓	✓	✓	✓	✓	✓
Dialogue Lift 🌟2	✓	✓	✓	✓	✓		✓	✓	✓	✓	✓	✓	✓	✓
Extended Surround	✓	✓			✓									
Volume Trim	✓	✓	✓	✓	✓	✓	✓	✓	✓	✓	✓	✓	✓	✓
Shuffle							✓		✓		✓ 🌟3			
Repeat							✓		✓		✓ 🌟3			
Connect												✓		
Disconnect												✓		
Pairing												✓		

🌟1: When “Tone Control,” “Adaptive DRC,” “CINEMA DSP 3D Mode,” “Dialogue Lift,” or “Extended Surround” is adjusted for an input source, the same value is applied to other input sources and “ALL” is displayed on the front panel display. When settings specific to a certain input source are selected, the input source name is displayed on the front panel display. If the

name of the input source has been changed (see p. 88), the original name of the input source is displayed.

🌟2: “Dialogue Lift” can be adjusted only when the presence speakers are available.

🌟3: Not available for Yamaha Wireless System for iPod.



Adjusting high/low-frequency sound

Tone Control

You can adjust the balance of the high-frequency range (Treble) and low-frequency range (Bass) of sounds output from the front left and right speakers to obtain desired tone.

Adjustable range	-6.0 dB to +6.0 dB
Adjustment increments	0.5 dB

- The tone control of the speakers or headphones can be set separately. Set the headphone tone control with the headphones connected.
- TONE CONTROL on the front panel can also be used ([p. 43](#)).

Auto-adjusting the sound level to make even low volumes more audible

Adaptive DRC

Adjusts the dynamic range in conjunction with the volume level (from minimum to maximum). When you play audio at night or at low volumes, it is a good idea to set parameter to “On.” 

On	Adjusts the dynamic range automatically.
Off (Default)	Does not adjust the dynamic range automatically.

When “On” is selected, the dynamic range is adjusted as follows.

If the volume level is low, the dynamic range is narrow.
If the volume level is high, the dynamic range is wide.

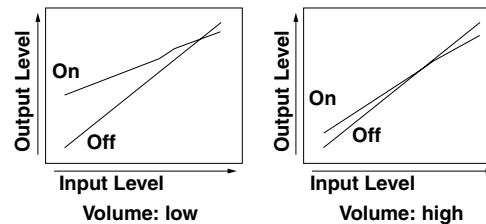

Enjoying more spatial sound fields

CINEMA DSP 3D Mode

Set whether to use sound programs in CINEMA DSP 3D mode ([p. 46](#)).

On (Default)	Enables CINEMA DSP 3D mode.
Off	Disables CINEMA DSP 3D mode.

Adjusts the vertical position of dialogues

Dialogue Lift

Adjusts the vertical position of center sound such as dialogues when presence speakers are used. Increasing this parameter raises the position.

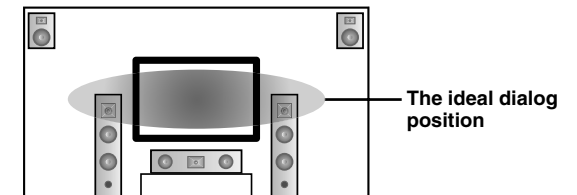

If the dialog seems to come out from a lower position than the video monitor screen, increase this parameter.

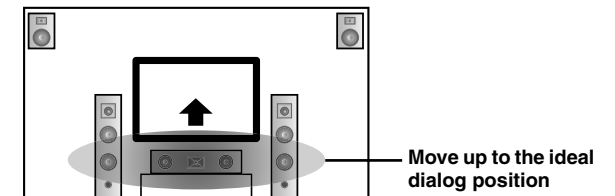

“0” (default) corresponds to the lowest position and “5” to the highest position.

- “Dialogue Lift” can be adjusted only when the presence speakers are available.
- You cannot move the dialog position lower than the default setting.

 1: “Adaptive DRC” is also effective when you use headphones.

Selecting the 5.1-channel signal playback method

Extended Surround

Selects whether to reproduce 5.1-channel input signals in 6.1- or 7.1-channel when surround back speakers are used. 🌱1

Auto (Default)	Automatically selects the most suitable decoder if a flag for reproducing surround back channel is present, and reproduces the signals in 6.1- or 7.1-channel.
<input type="checkbox"/> PLIIx Movie	Always reproduces signals in 7.1-channel using the Dolby Pro Logic IIX Movie decoder whether or not surround back channel signals are contained. You can select this parameter when two surround back speakers are connected.
<input type="checkbox"/> PLIIx Music	Always reproduces signals in 6.1- or 7.1-channel using the Dolby Pro Logic IIX Music decoder whether or not surround back channel signals are contained. You can select this parameter when one or two surround back speakers are connected.
EX/ES	Automatically selects the most suitable decoder for input signals whether or not the flag for reproducing surround back channel is present, and always reproduces signals in 6.1-channel.
Off	Always reproduces original channels whether or not the flag for reproducing surround back channel is present.

Adjusting volume between input sources

Volume Trim

Reduces any change in volume when switching between input sources by correcting volume differences in each input source. You can adjust this parameter for each input source.

Adjustable range	-6.0 dB to 0.0 dB to +6.0 dB
Default setting	0.0 dB
Adjustment increments	0.5 dB steps

Shuffle playback

Shuffle

Plays back songs or albums in random order. When the shuffle function is enabled, “” appears on the TV screen. 🌱2

Off	The shuffle function is turned off.
On 🌱3	The shuffle function is turned on.
Songs 🌱4	Plays songs back in random order.
Albums 🌱4	Plays albums back in random order.

Repeat playback

Repeat

Plays songs or albums repeatedly. When the repeat function is enabled, “ (Single / One[iPod])” or “ (All)” appears on the TV screen. 🌱2

Off	The repeat function is turned off.
Single / One[iPod]	Plays a song back repeatedly.
All	When all songs have completed playback, returns to the start and repeats playback.

Connect / Disconnect Bluetooth component

Connect

Disconnect

Switches communication with a Bluetooth component on and off ([p. 83](#)).

Pairing Bluetooth component

Pairing

Performs pairing of this unit and a Bluetooth component ([p. 83](#)).

🌱1: AV5-6 or AUDIO1-2 are also available when “Audio Return Channel” is on, and the input source is used for “TV Audio Input.”

🌱2: Not available for Yamaha Wireless System for iPod.

🌱3: This item is displayed only when PC or Rhapsody is selected as input source.

🌱4: This item is displayed only when DOCK (iPod) is selected as input source.

Confirming and operating input sources from the Content window

When NET, DOCK, TUNER, or SIRIUS is selected, the Content window is displayed on the TV screen. Playback style for iPod, functions for FM/AM tuner, SIRIUS Satellite Radio tuner, Rhapsody, SIRIUS Internet Radio, Internet Radio, and PC can be set in the Content window.

A TV screen is required to display the Content window. Refer to “Connecting a TV monitor” for instructions on connecting a TV monitor (p. 22).

Displaying the Content window on the TV screen

Press **4**NET, **4**DOCK, **4**TUNER or **4**SIRIUS to display the Content window.

The Content window consists of two main displays, the Now Playing view and the Browse view.

Below is the example of the Now Playing view for TUNER.

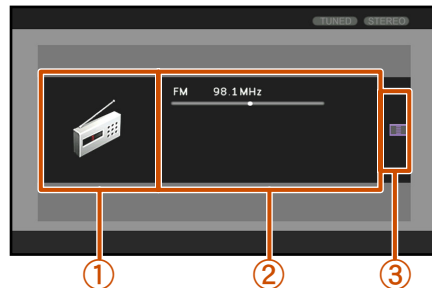

- ① **Image display**
Icon for each input source or album art is displayed.
- ② **Information display**
Information on the current input source is displayed.

- ③ **Screen button area**
Buttons to operate each input source are displayed here. These buttons vary depending on the selected input. For details on operations for each input, see the following.
 - FM/AM tuner (p. 59)
 - SIRIUS Satellite Radio tuner (p. 61)
 - PC servers (p. 68)
 - Internet Radio (p. 74)
 - Rhapsody (p. 71)
 - iPod (p. 80)

- In the Now Playing view, press **11**ENTER and use **11**Cursor Δ / ∇ to select the button. Then press **11**ENTER to execute the selection.
- In the Browse view, press **11**Cursor \triangleright and use **11**Cursor Δ / ∇ to select the button. Then press **11**ENTER to execute the selection.
- Press **11**RETURN repeatedly to exit from the operation.

Switching the display between the Now Playing view and the Browse view

You can switch the display between the Now Playing view and the Browse view by the following methods.

- Press **12**DISPLAY to cycle between the Now Playing view and the Browse view.
- In the Now Playing view, press **11**ENTER and use **11**Cursor Δ / ∇ to select the icon. Then press **11**ENTER to switch to the Browse view.
- In the Browse view, press **11**Cursor \triangleright and use **11**Cursor Δ / ∇ to select the icon. Then press **11**ENTER to switch to the Now Playing view.

Browse view

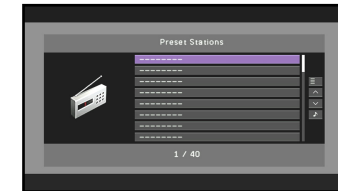

Now Playing view

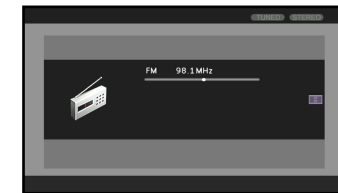

When selecting “DOCK (iPod)” as input source and playing back video content of iPod/iPhone, the screen switches as follows by pressing **12**DISPLAY repeatedly.

Now Playing view → Browse view →
Video playback screen (content window disappears)
→ Now Playing view

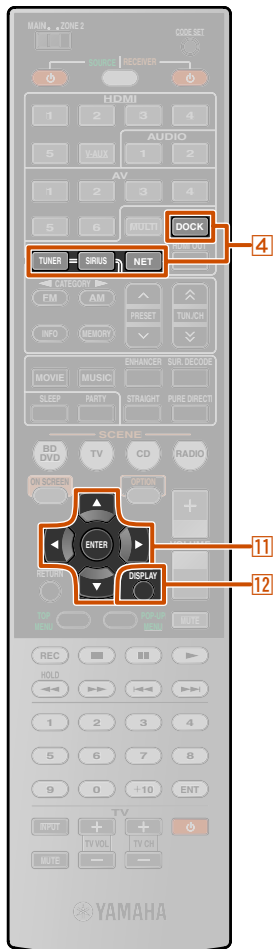

- 4** DOCK
- 4** TUNER
- 4** SIRIUS
- 11** Cursor $\Delta / \nabla / \triangleleft / \triangleright$
- 11** ENTER
- 11** RETURN
- 12** DISPLAY

FM/AM tuning

When using the FM/AM tuner, adjust the direction of the FM/AM antenna connected to this unit to get the best reception.

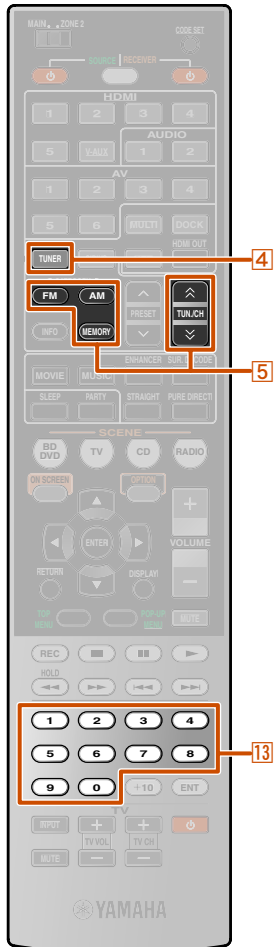

- 4** TUNER
- 5** FM
- 5** AM
- 5** MEMORY
- 5** TUN./CH \wedge / \vee
- 13** Numeric keys

Selecting a frequency for reception (Normal tuning)

- 1** Press **4** TUNER to switch to the tuner input.
- 2** Press **5** FM or **5** AM to select a band to receive.



- 3** Use **5** TUN./CH \wedge / \vee to set a frequency to receive.

5 TUN./CH \wedge
Increases the frequency. Press and hold this key for longer than a second to search automatically for a station on a higher frequency than the current one. 📶1

5 TUN./CH \vee
Decreases the frequency. Press and hold this key for longer than a second to search automatically for a station on a lower frequency than the current one. 📶1

Lights up when a broadcast is received from a station

Lights up when a stereo broadcast is received



Entering a frequency number

In normal tuning mode, use the **13** Numeric keys to enter a frequency. Leave the decimal point out when entering a number. 📶2
For example, enter as follows to select a station on 98.5 MHz.



Registering stations manually (Manual Preset)

Select stations manually and register them as presets individually.

- 1** Tune in to the station you want to register, referring to “Selecting a frequency for reception (Normal tuning).”

- 2** Use one of the following methods to register the station you are currently receiving.

Registering to a preset number to which no station is registered

Press **5** MEMORY for 3 seconds or longer. The station will be registered automatically to the lowest open preset number (or the next number after the one registered most recently).

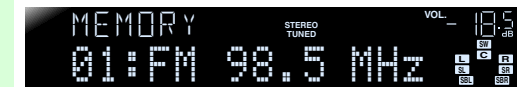

Registered frequencies

📶1 : When searching for a station, release the key once the search has started.

📶2 : “Wrong Station!” appears on the front panel display when you enter a frequency that is out of receivable range. Make sure that the frequency entered is correct.



5 MEMORY

5 PRESET ^ / v

13 Numeric keys

■ Designating a preset number for registration

Press **5**MEMORY once, to display “Manual Preset” on the front panel display. After a small wait, the preset number that the station has been registered to will appear.

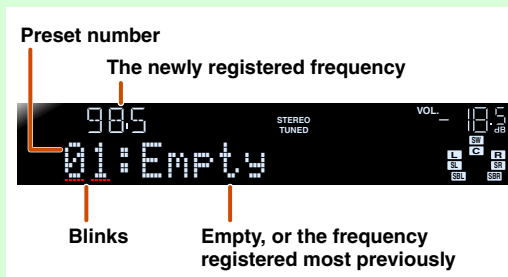

Press **5**PRESET ^ / v to select the preset number to register the station to, and then press **5**MEMORY to register.

To select a registered station, press **5PRESET ^ / v to select the preset number of the station. 💡1**

💡1 : To select a station by selecting a preset number, use the **13**Numeric keys to enter the preset number of the station you want to listen. When an invalid number is entered, “Wrong Num.” appears on the front panel display. Check that you have entered the correct number.



Navigating the FM/AM tuner from the Content window

The station currently received can be confirmed from the menu displayed on the TV screen. Various FM/AM tuner operations can be performed from the Content window rather than controls on the front panel display. The Content window is displayed when **4**TUNER is pressed.

You can operate the FM/AM tuner from the Now Playing view or the Browse view.

Operating from the Now Playing view

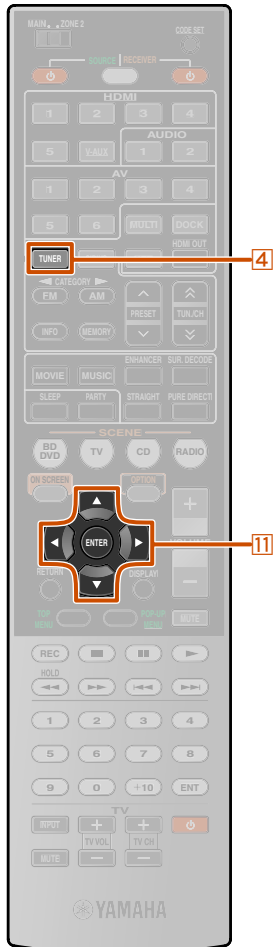

- 4** TUNER
- 11** Cursor Δ / ∇
- 11** ENTER

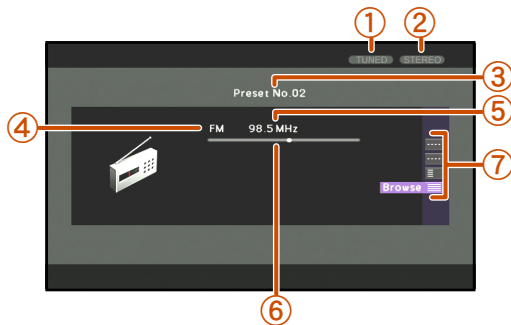

- 1 Tuned indicator**
Lights up when a station is received.
- 2 Stereo indicator**
Lights up when a stereo broadcast is received. When "Audio Mode" is set to "Mono," the indicator does not light.
- 3 Preset number**
The selected preset number is displayed.
- 4 Band**
The selected band (FM or AM) is displayed.
- 5 Frequency**
The frequency currently received is displayed.
- 6 Frequency guide**
The frequency currently received is displayed as a cursor on the bar.
- 7 Screen button area**
Buttons for available operations are displayed. See "Screen buttons on the Now Playing view" for details.

Screen buttons on the Now Playing view

To use these buttons, first press **11**ENTER. Then select the desired one with **11**Cursor Δ / ∇ and **11**ENTER.

Manual Tuning

You can tune in to a desired FM/AM station by specifying its frequency.

FM	Switches a band to FM.
AM	Switches a band to AM.
Tuning -	Decreases the frequency.
Tuning +	Increases the frequency.
Auto -	Automatically searches for a station on a lower frequency than the current station.
Auto +	Automatically searches for a station on a higher frequency than the current station.
Direct	Selects the frequency manually.
Memory	Registers the station currently received as a preset station. Up to 40 FM/AM stations can be registered.

Preset Select

You can call preset stations.

Preset -	Selects the previous preset number.
Preset +	Selects the next preset number.
Preset -8	Returns the previous page.
Preset +8	Goes to the next page.
Direct	Selects a station directly by entering the preset number.
Memory	Registers the station currently received as a preset station. Up to 40 FM/AM stations can be registered.

Utility

FM Mode

Selects "Stereo" or "Mono" when receiving the FM station.

Browse

Switches the display to the Browse view.

Continues to the next page

Operating from the Browse view

Now Playing

Switches the display to the Now Playing view.

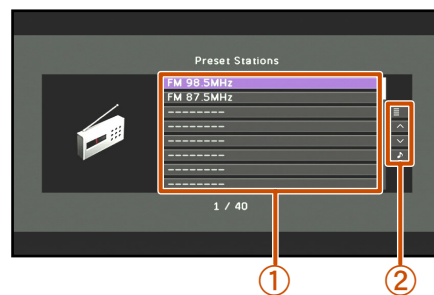

- ① **Preset station list**
The list of preset stations is displayed.
- ② **Screen button area**
Buttons for available operations are displayed. See “Screen buttons on the Browse view” for details.

Screen buttons on the Browse view

To use these buttons, first press **ENTER**. Then select the desired one with **Cursor** Δ / ∇ and **ENTER**.

Utility

Auto Preset	Detects stations with a strong signal and automatically registers up to 40 stations, beginning with the next number after the current number.
Clear Preset	Clears registration of the preset station currently selected.
Clear All Preset	Clears registration of all preset stations.

1 Page Up

1 Page Down

Scrolls the list to the next or previous page.

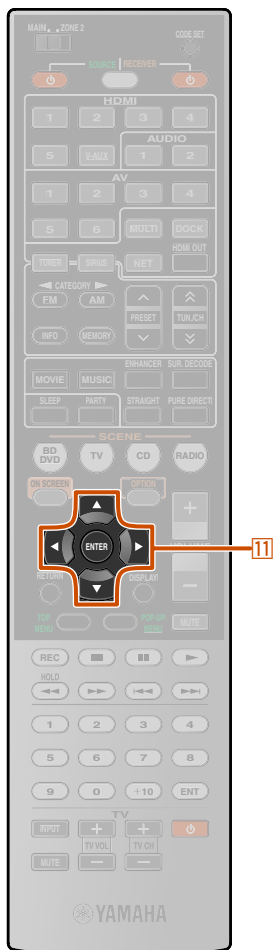

ENTER $\Delta / \nabla / \leftarrow / \rightarrow$

ENTER

Listening to SIRIUS Satellite Radio™

To listen to Satellite Radio, you'll need to connect a SIRIUS Satellite Radio tuner (sold separately) to your SIRIUS-Ready receiver. SIRIUS Satellite Radio is available to residents of the US (except Alaska and Hawaii) and Canada.

Satellite Radio delivers a variety of commercial-free music from categories ranging from Pop, Rock, Country, R&B, Dance, Jazz, Classical and many more plus coverage of all the top professional and college sports including play by play games from select leagues and teams. Additional programming includes expert sports talk, uncensored entertainment, comedy, family programming, local traffic and weather and news from your most trusted sources.

Once you've purchased a SIRIUS tuner you'll need to activate it and subscribe to begin enjoying the service. Easy to follow installation and setup instructions are provided with the SIRIUS tuner. There are a variety of programming packages available, including the option of adding "The Best of XM" programming to the SIRIUS service. The "Best of XM" service is not available to SIRIUS Canada subscribers at this time. Please check with SIRIUS Canada for any updates using the numbers and web address below.

Family friendly packages are also available to restrict channels featuring content that may be inappropriate for children.

To subscribe to SIRIUS, U.S. and Canadian customers can call 1-888-539-SIRI (1-888-539-7474) or visit sirius.com (US) or siriuscanada.ca (Canada).

SIRIUS Radio Legal

SIRIUS and all related marks and logos are trademarks of Sirius XM Radio Inc. and its subsidiaries. All other marks and logos are the property of their respective owners. All rights reserved. SIRIUS subscription sold separately. Taxes and a one-time activation fee may apply. SIRIUS tuner required (sold separately) to receive the SIRIUS service. All programming and fees subject to change. It is prohibited to copy, decompile, disassemble, reverse engineer, hack, manipulate or otherwise make available any technology or software incorporated in receivers compatible with the SIRIUS Satellite Radio System. Service not available in Alaska or Hawaii.

Connecting the SiriusConnect™ tuner

Connect the SiriusConnect tuner (sold separately) to the SIRIUS jack on the rear panel of this unit. For details, see the instruction manuals provided with the SiriusConnect tuner.

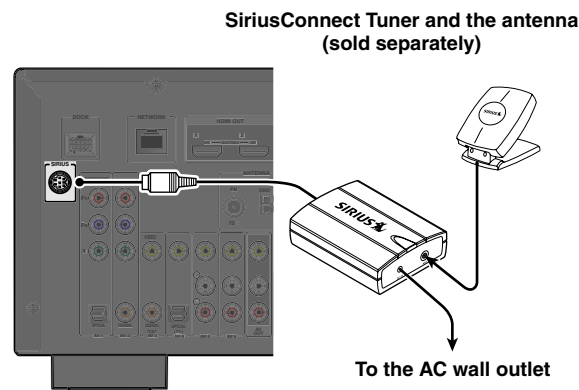

- To ensure optimal reception of the SIRIUS Satellite Radio signals, the antenna of the SiriusConnect tuner must be placed at or near a window with no obstacles in the path to the sky. The orientation of the antenna for the best reception differs depending on the area. Refer to the instruction manuals provided with the SiriusConnect tuner for the installation of the antenna. You can mount it indoors or outdoors.
- Use the Antenna information on the front panel display or the SIRIUS information screen on the TV screen ([see p. 65](#)) to check the antenna reception level and adjust the orientation of the antenna.
- You need to connect the SiriusConnect tuner to the AC wall outlet.

NOTES

- If "CHECK SR TUNER" or "ANTENNA ERROR" appears on the front panel display, the connection of the SiriusConnect tuner or antenna is incorrect. In such cases, check the connection of the SiriusConnect tuner and the antenna.
- If "NOT SUPPORTED" appears on the front panel display, this unit does not support the connected SiriusConnect tuner.



- 4 SIRIUS
- 13 0
- 13 ENT

Activating SIRIUS Satellite Radio™ subscription

Before using the SIRIUS Satellite Radio feature, you need to activate your SIRIUS Satellite Radio subscription. To activate the subscription you need the SIRIUS ID which is uniquely assigned to the SiriusConnect tuner. SIRIUS ID is 12-digit number which is indicated on the package of the SiriusConnect tuner and on the label of the SiriusConnect tuner. SIRIUS ID is also configured on the front panel display when you tune into the SIRIUS Satellite Radio channel “0.”

■ Displaying the SIRIUS ID of your SiriusConnect tuner

- 1 Press **4**SIRIUS.
- 2 Press **13**0 and then **13**ENT to display the SIRIUS ID of your SiriusConnect tuner. “000 Sirius ID” and “xxxxxxxxxxxx” (“xxxxxxxxxxxx” indicates the 12-digit SIRIUS ID of your SiriusConnect tuner) appears alternately on the front panel display.

Write down the SIRIUS ID in the space provided below.

ID: _____

3 Contact SIRIUS Satellite Radio to activate your subscription.

SIRIUS Satellite Radio online information

Contact for activation

URL: <https://activate.siriusradio.com/>

Phone: 1-888-539-SIRIUS (1-888-539-7474)

Status messages appear on the front panel display and the TV screen during the activation. For details, see “SIRIUS Satellite Radio™” (p. 130). Once the activation is finished, “SUB UPDATED” appears.

SIRIUS Satellite Radio™ operations

1 Press **4**SIRIUS to select “SIRIUS” as the input source.

The SIRIUS indicator lights up on the front panel display and the SIRIUS Satellite Radio information (such as channel number, channel name, category, artist name, or song title) for the currently selected channel appears on the front panel display. 1



Channel number Channel name

NOTES

- Before activating your subscription, you can only select “184” or “000.”
- If a status message or an error message appears on the front panel display or TV screen, refer to “SIRIUS Satellite Radio™” (p. 130).

2 Search for a channel by using one of the SIRIUS Satellite Radio search modes.

All channel search mode

Selects a channel from the all channel list (p. 63).

Category search mode

Selects a channel by category (p. 63).

Direct number access mode

Selects a channel directly by entering the channel number (p. 63).

Preset search mode

Selects a channel from the preset channels (p. 64). You can preset channels by registering them to specific numbers, and later just select those numbers to tune in.

- SIRIUS Satellite Radio information can be displayed on the front panel display and the TV screen (p. 65).
- If you tune into a channel that you do not subscribe, “CALL SIRIUS on the front panel display” or “CALL 888-539-SIRIUS TO SUBSCRIBE” appears on the TV screen.

1: When you select “SIRIUS” as the input source, this unit automatically calls the previously selected channel.

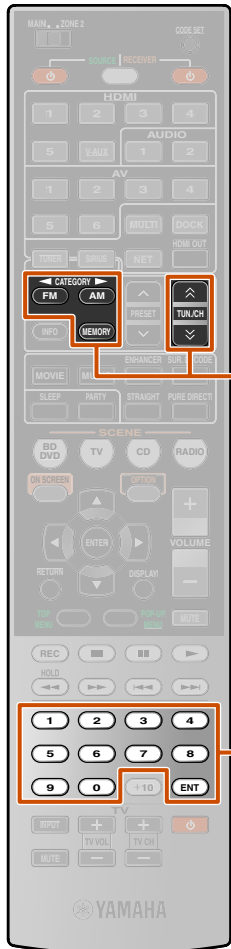

- 5** TUN./CH \wedge / \vee
- 5** CATEGORY \triangleleft / \triangleright
- 5** MEMORY
- 13** Numeric keys
- 13** ENT

All channel search mode

Press **5** TUN./CH \wedge / \vee repeatedly to search for a channel within all channels.

All channel search mode



- You can search for a channel quickly by pressing and holding **5** TUN./CH \wedge / \vee .
- You can skip channels to the previous or next category by pressing **5** CATEGORY \triangleleft / \triangleright .

Category search mode

1 Press **5** CATEGORY \triangleleft / \triangleright to select the channel category.

When you select the category, the first channel in the category is selected.

Category search mode The first channel in the category

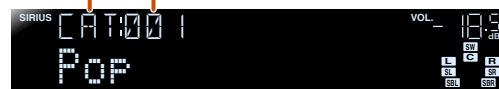

Category name

If you don't operate within 10 seconds, the category search mode returns to "ALL (All Channel Search)."

2 While "CAT" is displayed on the front panel display, press **5** TUN./CH \wedge / \vee repeatedly to search for a channel within the selected channel category.

You can search for a channel quickly by pressing and holding **5** TUN./CH \wedge / \vee .

NOTE

This unit skips the following channels in all channel search mode or category search mode. This is not a malfunction.

- channels that are locked ([p. 65](#))
- channels that are not currently in service
- channels that you do not subscribe to

Direct number access mode

Press the **13** Numeric keys to enter the desired three-digit channel number.

For example, to enter the number 123, press "1," "2" and then "3" of the **13** Numeric keys.

- When entering a one-digit or two-digit channel number, enter the number using the **13** Numeric keys and then press **13** ENT to confirm your entry.
- This unit automatically accepts your entry if you do not press **13** ENT within a few seconds after entering the number.
- If the selected channel is locked, "PIN: ___" appears on the front panel display. Enter the 4-digit Parental Lock code number by using the **13** Numeric keys or press **13** ENT to cancel ([p. 65](#)).
- If the selected channel is not available, an advisory message may appear. For details, refer to "SIRIUS Satellite Radio™" ([p. 130](#)).
- If this unit is in preset search mode, a preset number is selected instead of a channel number when you press the **13** Numeric keys. To switch to direct number access mode, press **5** TUN./CH \wedge / \vee .

Registering and recalling the SIRIUS Satellite Radio™ channels

Up to 40 SIRIUS Satellite Radio channels can be registered as preset channels.

Registering preset channels

1 Search for a channel to be registered.

For details on searching channels, refer to the following pages.

- All channel search mode ([p. 63](#))
- Category search mode ([p. 63](#))
- Direct number access mode ([p. 63](#))

2 Use one of the following methods to register the channel currently received.

Registering to a preset number for which no channel has been registered

Press and hold **5** MEMORY for at least 2 second. The channel will be automatically registered to the lowest available preset number (or the next number after the last to which a channel was registered).



Preset number Registered channel



- 5 MEMORY
- 5 PRESET ^ / v
- 6 INFO
- 11 RETURN
- 13 Numeric keys

■ Designating a preset number for registration

Press **5**MEMORY once.



- Preset number**
- Previously registered channel (or "—" if no channel has been registered)**
- Channel to be registered**

Press **5**PRESET ^ / v to select the preset number to which the channel will be registered and then press **5**MEMORY to register.

To cancel registration, press **11**RETURN or do not operate the remote control for about 30 seconds.

■ Recalling a preset channel (Preset Search mode)

Specify preset numbers to recall registered channels.



Press **5**PRESET ^ / v to change the preset numbers (1 to 40).

- Preset numbers to which no channel has been registered are skipped.
- Preset numbers can also be selected by pressing **13**Numeric keys.

Displaying the SIRIUS Satellite Radio™ information

You can display the SIRIUS Satellite Radio information on the front panel display. 1

NOTE

If a status message or an error message appears on the front panel display or TV screen, see “SIRIUS Satellite Radio™” (p. 130).

■ Front panel display

Press **6**INFO repeatedly to toggle the SIRIUS Satellite Radio information display modes as shown below.

Channel
Channel number, channel name



Category
Channel category, channel number



Artist/Song
Artist name, song title, channel number



Composer
Composer name, channel number



Antenna
Antenna reception level, channel number

Signal reception level

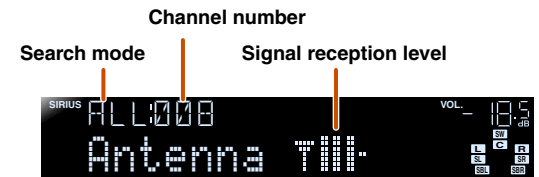

Signal reception is shown in four levels.



DSP Program
Current sound program (p. 48), channel number



Audio Decoder
Current Audio Decoder (p. 44), channel number



Back to “Channel”

1 : If the SIRIUS Satellite Radio information contains a character that cannot be recognized by this unit, the character will be displayed with a space.
When an information is unavailable, “—” appears.

Navigating the SIRIUS Satellite Radio™ from the Content window

The SIRIUS channel currently received can be confirmed from the menu displayed on the TV screen. Various SIRIUS Satellite Radio operations can be performed from the Content window rather than controls on the front panel display. The Content window is displayed when

④ **SIRIUS** is pressed.

You can operate the SIRIUS Satellite Radio from the Now Playing view or the Browse view.

Operating from the Now Playing view

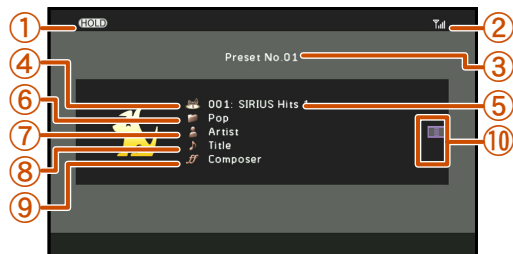

- ① **HOLD indicator**
Blinks when ⑫ **HOLD** is pressed to activate the hold function. The artist name and song title currently received will remain displayed. Press ⑫ **HOLD** again to cancel the hold function.

- ② **Signal reception level**
Indicates the signal reception level.

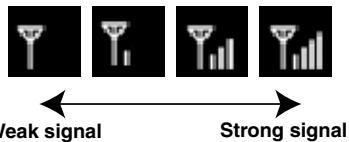

- ③ **Preset number**
The selected preset number is displayed.
- ④ **Channel number**
The channel number currently received is displayed.

- ⑤ **Channel Name**
The channel name currently received is displayed.
- ⑥ **Channel Category**
The category of the channel is displayed.
- ⑦ **Artist Name**
The artist name of the current song is displayed.
- ⑧ **Song Title**
The title of the current song is displayed.
- ⑨ **Composer Name**
The composer name of the current song is displayed.
- ⑩ **Screen button area**
Buttons for available operations are displayed. See "Screen buttons on the Now Playing view" for details.

Screen buttons on the Now Playing view

To use these buttons, first press ⑪ **ENTER**. Then select the desired one with ⑪ **Cursor** Δ / ∇ and ⑪ **ENTER**.

Radio Control

Select a channel for reception.

Memory	Register the current channel as a preset number. Up to 40 channels can be registered.
Preset -	Select the previous preset number.
Preset +	Select the next preset number.
CAT -	Select the previous category.
CAT +	Select the next category.
CH -	Scan channels downwards from the current channel.
CH +	Scan channels upwards from the current channel.
Direct	Specify a specific channel by manually entering the channel number.
Hold	Activate the hold function. The artist name and song title currently received will remain displayed.

Utility

Parental Lock	Restricts the access to specified channel.
---------------	--

When the parental lock function is enabled for a particular channel, that channel is skipped in all channel search mode and category search mode.

- 1 Use ⑪ **Cursor** $\triangleleft / \triangleright$ to select a number, and press ⑪ **ENTER** to enter the selected number.

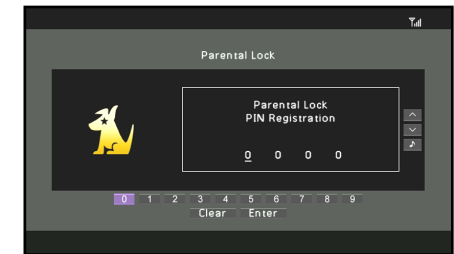

- 2 Repeat step 1 to enter the desired 4-digit code number.
- 3 Use ⑪ **Cursor** ∇ to select "Enter," and press ⑪ **ENTER** to confirm the 4-digit code number.
Selecting "Clear" and pressing ⑪ **ENTER** clears all the code entered.
- 4 Use ⑪ **Cursor** Δ / ∇ to select the category and press ⑪ **ENTER**.

Continues to the next page

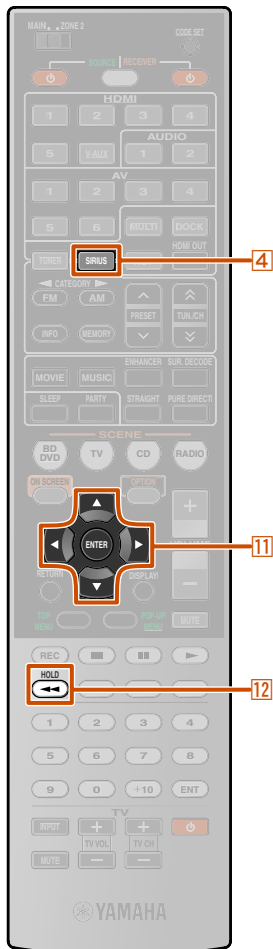

- ④ **SIRIUS**
- ⑪ **Cursor** $\Delta / \nabla / \triangleleft / \triangleright$
- ⑪ **ENTER**
- ⑫ **HOLD**



- 11 Cursor $\Delta / \nabla / \triangleleft / \triangleright$
- 11 RETURN
- 11 ENTER
- 13 Numeric keys
- 13 ENT

5 Use 11 Cursor Δ / ∇ to select the channel to be locked and press 11 ENTER.

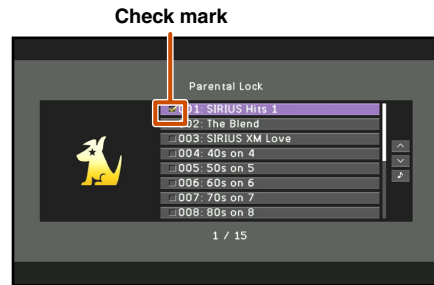

When 11 ENTER is pressed, the selected channel is received for confirmation. Each time 11 ENTER is pressed after that, lock switches between on and off.

To lock channels in other categories, press 11 RETURN to display the category selection screen, and follow the procedure described above.

NOTES

- If a code number is already registered and the different code number is entered, “Wrong” appears. In this case, start over from step 1.
- If you forget the parental lock code or want to change it, reset it using “SR PIN” (p. 119).

Receiving locked channels

Use direct number access mode (p. 63) or preset search mode (p. 64) to receive locked channels. When a locked channel is received, “LOCKED” is displayed followed by the parental lock code input screen. Use 13 Numeric keys to enter the 4-digit code number.

Scroll

Switches the scroll target (channel name, channel category, artist name, song title, or composer name).

Browse

Switches the display to the Browse view.

Operating from the Browse view

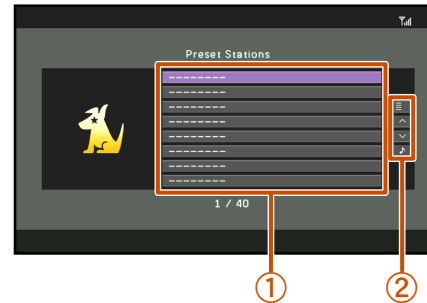

- ① **Preset station list**
The list of preset stations is displayed.
- ② **Screen button area**
Buttons for available operations are displayed. See “Screen buttons on the Browse view” for details.

Screen buttons on the Browse view

To use these buttons, first press 11 Cursor \triangleright . Then select the desired one with 11 Cursor Δ / ∇ and 11 ENTER.

Utility

Parental Lock	Restricts the access to specified channel.
Clear Preset	Clears registration of the preset station currently selected.
Clear All Preset	Clears registration of all preset stations.

1 Page Up

1 Page Down

Scrolls the list to the next or previous page.

Now Playing

Switches the display to the Now Playing view.

Playing back tunes on the PC

You can enjoy playback of audio files stored on PCs connected to this unit via your network. To play back audio files on your PC, you need to install Windows Media Player on the PC and configure the media sharing setting of Windows Media Player.

If you do not use a DHCP server, configure the network parameters (IP address, etc.) of this unit manually ([p. 108](#)).

Windows Media Player setup

1 Install Windows Media Player on your PC.

You can download the installer of Windows Media Player from the Microsoft website, or use the upgrade function of the installed Microsoft Windows Media Player.

2 Turn on your PC then allow media sharing.

Activate Windows Media Player first, enable the media sharing and then select this unit as a device to which the media is shared.

NOTES

- Some security software installed on your PC (anti-virus software, firewall software, etc.) may block the access of this unit to your PC. In such cases, configure the security software appropriately.
- You can connect this unit to up to 16 PC servers, and each server must be connected to the same subnet as this unit.

Playback of PC music contents

For a complete list of status messages that appear on the front panel display and GUI screen, see “Network” ([p. 131](#)).

The PC music contents can be operated from the menu displayed on the TV screen.

You can operate the PC contents from the Now Playing view or the Browse view.

Operating from the Browse view

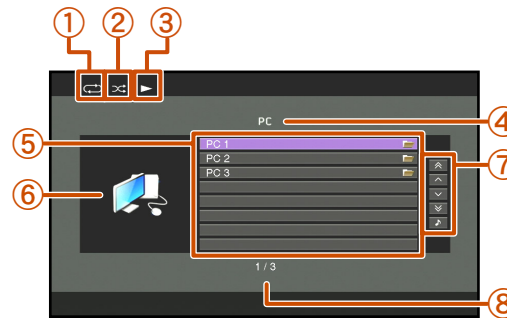

- 1 Repeat icon
- 2 Shuffle icon
- 3 Play icon
- 4 Current directory name
- 5 Menu items
- 6 Album art / Input icon
- 7 Screen button area
Buttons for available operations are displayed. See “Screen buttons on the Browse view” for details.
- 8 Current menu number / Number of all menu items

Screen buttons on the Browse view

To use these buttons, first press **[11]Cursor ▷**. Then select the desired one with **[11]Cursor △ / ▽** and **[11]ENTER**.

10 Pages Up

10 Pages Down

Goes to 10 pages forwards or backwards.

1 Page Up

1 Page Down

Scrolls the list to the next or previous page.

Now Playing

Switches the display to the Now Playing view.

1 Press **[4]NET** repeatedly to select “PC” as the input source.

2 Press **[11]Cursor △ / ▽** to select a PC server and music file to play back.

- To select a PC server, folder or file, press **[11]Cursor △ / ▽**.
- To confirm the selection, press **[11]ENTER**.
- To return to the previous menu, press **[11]RETURN**.

3 Press **[11]ENTER** to start playback.
The Now Playing view appears during playback.

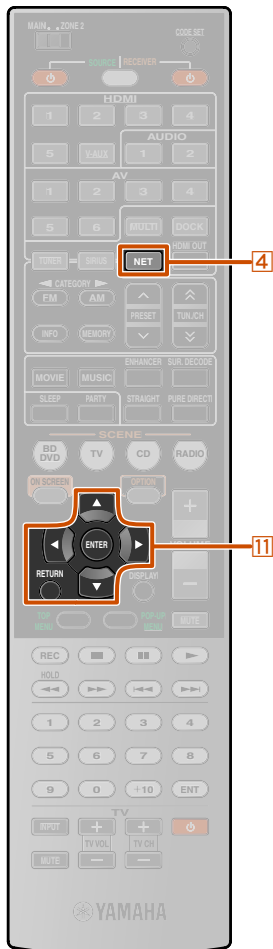

- [4]NET**
- [11]Cursor △ / ▽ / ◀ / ▶**
- [11]ENTER**
- [11]RETURN**



Operating from the Now Playing view

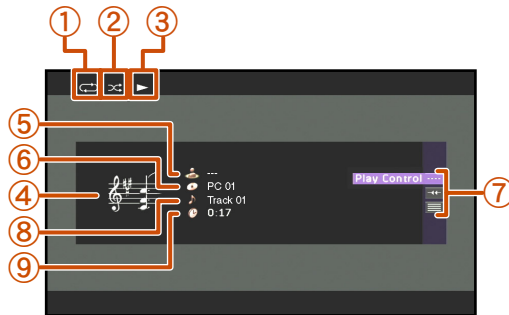
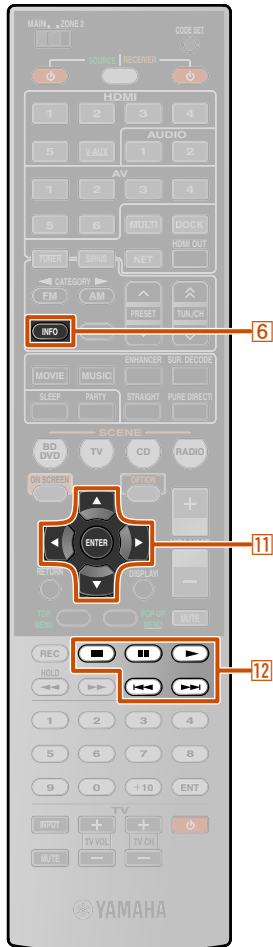

- ① Repeat icon
- ② Shuffle icon
- ③ Play icon
- ④ Album art
- ⑤ Artist name
- ⑥ Album title
- ⑦ Screen button area
Buttons for available operations are displayed. See “Screen buttons on the Now Playing view” for details.
- ⑧ Song title
- ⑨ Elapsed time

- You can switch the information displayed on the front panel display by pressing **6** INFO (p. 10).
- Album art is available only when the file contains image data.

Screen buttons on the Now Playing view

To use these buttons, first press **11** ENTER. Then select the desired one with **11** Cursor Δ / ∇ and **11** ENTER.

Play Control

Operates the basic playback functions of PC.

▷ (Play)	Starts playback.
□ (Stop)	Stops playback.
⏸ (Pause)	Stops playback temporarily.
⏮ (Skip -)	Skips to the beginning of the currently playing song. Press 11 ENTER at the beginning of the song to skip to a previous song.
⏭ (Skip +)	Skips to the beginning of the next song.

Scroll

Switches the scroll target (artist name, album title, or song title).

Browse

Switches the display to the Browse view.

Compatibility of Digital Media Controller

A DLNA-compliant Digital Media Controller (DMC) device can also be used to control music playback. Refer to “Using a PC to control this unit over a network” (p. 88) for details. **1**, **2**

CAUTION

When DMC controls are used to adjust volume, playback volume may be unexpectedly loud. This could result in damage to this unit or the speakers. “Max Volume” can be used to specify the maximum volume level to prevent excessively loud playback (p. 103).

Operating basic playback functions with the remote control

Use the following remote control keys to operate (playback, stop, skip, etc.) your PC contents.

12 ▷	Play
12 □	Stop
12 ⏸	Switches between playback and pause.
12 ⏭	Skip forward during playback
12 ⏮	Skip backward during playback

Shuffle/repeat playback

Use the Option menu to apply playback shuffle and repeat settings. Refer to “Shuffle playback” (p. 55) and “Repeat playback” (p. 55) for details.

- 6** INFO
- 11** Cursor Δ / ∇
- 11** ENTER
- 12** **▷**
- 12** **□**
- 12** **⏸**
- 12** **⏭**
- 12** **⏮**

- 1**: A shortcut button cannot be registered when a DMC is used.
- 2**: Set “DMC Control” to “Disable” to automatically play back the last song played when this unit is turned on.

Listening to the Internet Radio

You can listen to Internet Radio stations using the vTuner Internet Radio station database service particularly customized for this unit, providing a database of over 2000 radio stations. Also, you can store your favorite stations with bookmarks.

- To use this feature, your network must be connected to the Internet.
- A narrowband Internet connection (i.e. 56K modem, ISDN) will not provide satisfactory results, and a broadband connection is strongly recommended (i.e. a cable modem, an xDSL modem, etc.). For detailed information, consult with your ISP.
- If you do not use a DHCP server, configure the network parameters (IP address, etc.) of this unit manually ([p. 108](#)).
- Some security devices (such as firewall) may block the access of this unit to Internet Radio stations. In such cases, configure the security settings appropriately.
- This service may be discontinued without notice.
- Some Internet Radio stations may not be played.

Listening to Internet Radio

For a complete list of status messages that appear on the front panel display and GUI screen, see “Network” ([p. 131](#))

The Internet Radio can be operated from the menu displayed on the TV screen.

You can operate the Internet Radio from the Now Playing view or the Browse view.

Operating from the Browse view

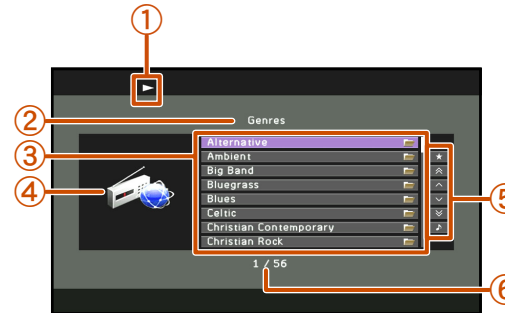

- ① **Play icon**
- ② **Current directory name**
- ③ **Menu items**
- ④ **Channel art**
- ⑤ **Screen button area**
Buttons for available operations are displayed. See “Screen buttons on the Browse view” for details.
- ⑥ **Current menu number / Number of all menu items**

Screen buttons on the Browse view

To use these buttons, first press **[11]Cursor >**. Then select the desired one with **[11]Cursor Δ / ▽** and **[11]ENTER**.

Bookmark On

The selected Internet Radio station is added to the Bookmarks list in “NET RADIO.”

Bookmark Off

This item is displayed in the bookmark directory. The selected Internet Radio station is removed from the Bookmarks list.

10 Pages Up

10 Pages Down

Goes to 10 pages forwards or backwards.

1 Page Up

1 Page Down

Scrolls the list to the next or previous page.

Now Playing

Switches the display to the Now Playing view.

1 Press **[4]NET** repeatedly to select “NET RADIO” as the input source.

2 Press **[11]Cursor Δ / ▽** to select an item to play back.

- To select an item, press **[11]Cursor Δ / ▽**.
- To confirm the selection, press **[11]ENTER**.
- To return to the previous menu, press **[11]RETURN**.

3 Press **[11]ENTER** to start playback. The Now Playing view appears during playback.

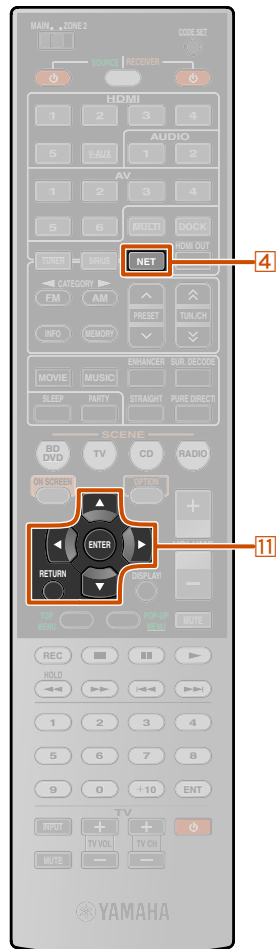

- [4]NET**
- [11]Cursor Δ / ▽ / < / >**
- [11]ENTER**
- [11]RETURN**

Operating from the Now Playing view

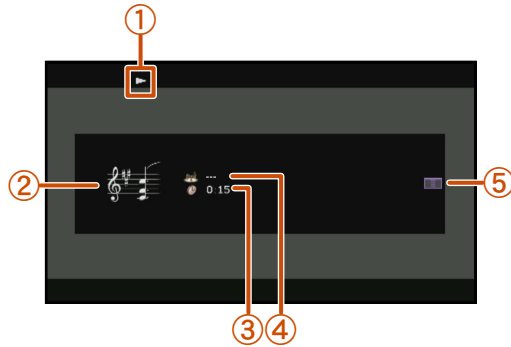

- ① **Play icon**
- ② **Channel art**
- ③ **Elapsed time**
- ④ **Current station name**
- ⑤ **Screen button area**
Buttons for available operations are displayed. See “Screen buttons on the Now Playing view” for details.

- You can switch the information displayed on the front panel display by pressing [6] **INFO** (see p. 10).
- Channel art is available only when the selected channel contains image data.

Screen buttons on the Now Playing view

To use these buttons, first press [11] **ENTER**. Then select the desired one with [11] **Cursor** Δ / ∇ and [11] **ENTER**.

Bookmark On

The station currently being played back is added to the Bookmarks list in “NET RADIO.”

Play Control

The following operation is available.

[12] (Stop)	Stops playback.
-------------	-----------------

Browse

Switches the display to the Browse view.

Operating basic playback functions with the remote control

Use the following remote control keys to operate (playback, stop) the Internet Radio.

[12]	Play
[12]	Stop

You can also register your favorite Internet Radio stations on this unit by accessing the website with the web browser on your PC. To use this feature, you need the vTuner ID of this unit and your e-mail address to create your personal account. For details, refer to the help information on the website.
URL: <http://yradio.vtuner.com/>

NOTE

To clear the personal account such as vTuner ID or e-mail address, perform “NETWORK” of “INITIALIZE” in the Advanced Setup menu (see p. 120).

- [6] **INFO**
- [11] **Cursor** Δ / ∇
- [11] **ENTER**
- [12]
- [12]

Using the Rhapsody® service

Prohibition

It is strictly prohibited to modify, reproduce, reverse-engineer or use this unit and/or built-in software for use other than audiovisual purposes.

The Rhapsody® service is the power behind the Rhapsody® Media Player (the Rhapsody® player software that you can download to your computer). Rhapsody® service supplies the music, keeps My Library up to date, provides you with Rhapsody® channels, the Playlist Central online community, and manages your downloads. Your software connects to Rhapsody® service through the internet. Because your account information and Rhapsody® content are on servers instead of any individual computer, your music is infinitely portable. Much of what you see in the Display area comes from Rhapsody® service. What you can do with Rhapsody® service depends on your subscription. You can use Rhapsody® service for free, or get even more from a paid membership. The Rhapsody® service also brings you Rhapsody® Online, a streamlined, internet version of Rhapsody® that you can access from almost anywhere. Just sign in to your Rhapsody® account to start letting the Rhapsody® service work for you.

For more information, <http://www.rhapsody.com/>

Rhapsody® account sign-in

When you select “Rhapsody” for the first time, the sign-in screen appears. Sign in to your Rhapsody® account to start using the Rhapsody service on this unit.

Use the Utility function later to view information for your Rhapsody® account.

1 Press **[10] ON SCREEN**.

2 Use **[11] Cursor Δ / ▽** to select “Input” and press **[11] ENTER**.

3 Use **[11] Cursor < / >** to select “Rhapsody” and press **[11] Cursor Δ**.

The following display appears when “Sign In” has not been completed yet. Read the description and then press **[11] ENTER**. 

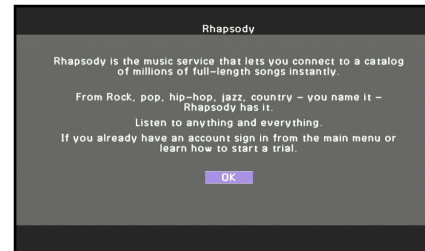

4 Press **[11] Cursor Δ / ▽** to select “Sign In” and then press **[11] ENTER**.

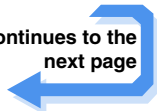

If “Rhapsody Trial” is selected, the URL for free 30-day trial service content is displayed. You can get started with a free trial by registering an account in the specified website.

Continues to the next page 

 **1**: When “Sign In” has not been completed yet, this description can be directly displayed by pressing **[4] NET** repeatedly to select “Rhapsody” as input source.

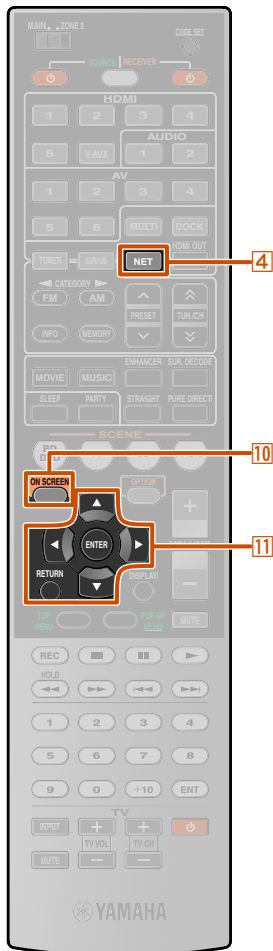

- [4] NET**
- [10] ON SCREEN**
- [11] Cursor Δ / ▽ / < / >**
- [11] ENTER**



11 Cursor $\Delta / \nabla / \triangleleft / \triangleright$
11 ENTER

5 Press **11**ENTER to enter the User Name entry screen.

6 Use **11**Cursor $\Delta / \nabla / \triangleleft / \triangleright$ and **11**ENTER to enter your user name password (up to 64 characters) and then select “OK” and press **11**ENTER.

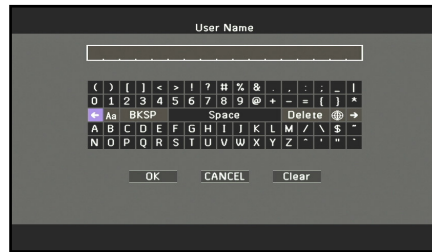

To clear the characters entered in step 6 and 8, select “Clear” and press **11**ENTER.

7 Press **11**ENTER to enter the User Password entry screen.

8 Use **11**Cursor $\Delta / \nabla / \triangleleft / \triangleright$ and **11**ENTER to enter your password (up to 64 characters) and then select “OK” and press **11**ENTER.

“Please wait” appears followed by the confirmation screen.

NOTE

If registration failed, the error message appears. In this case, read the message and start all over again.

9 Press **11**ENTER.
The Rhapsody Browse view is displayed.

Playback of Rhapsody® contents

The Rhapsody can be operated from the content window on the TV screen.

You can operate the Rhapsody from the Now Playing view or the Browse view.

Operating from the Browse view

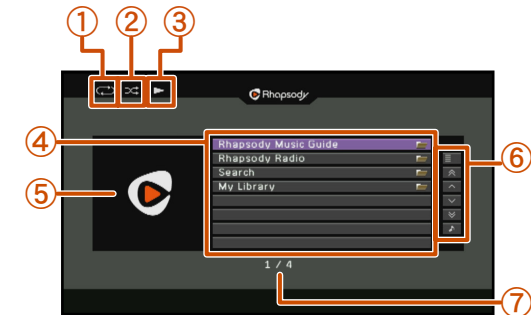

- ① Repeat icon
- ② Shuffle icon
- ③ Play icon
- ④ Menu items
- ⑤ Album art / Input icon
- ⑥ Screen button area
Buttons for available operations are displayed. See “Screen buttons on the Browse view” for details.
- ⑦ Current menu number / Number of all menu items



- 4 NET
- 6 INFO
- 11 Cursor Δ / ∇ / \triangleleft / \triangleright
- 11 ENTER
- 11 RETURN

Screen buttons on the Browse view

To use these buttons, first press **11** Cursor \triangleright . Then select the desired one with **11** Cursor Δ / ∇ and **11** ENTER.

Utility

Play	Plays back the song or album highlighted in the list.
Add track to My Library	Adds the track currently selected to "My Library."
Add album to My Library	Adds the album currently selected to "My Library."
Add CH to My Library	Adds the channel currently selected to "My Library."
Remove from My Library	Removes the content currently selected from "My Library."

10 Pages Up

10 Pages Down

Goes to 10 pages forwards or backwards.

1 Page Up

1 Page Down

Scrolls the list to the next or previous page.

Now Playing

Switches the display to the Now Playing view.

You can navigate the Rhapsody menu with the following remote control buttons.

1 Press **4** NET repeatedly to select "Rhapsody" as the input source.

2 Press **11** Cursor Δ / ∇ to select an item to play back.

- To select an item, folder or file, press **11** Cursor Δ / ∇ .
- To confirm the selection, press **11** ENTER.
- To return to the previous menu, press **11** RETURN.

Rhapsody Music Guide	Select a track from the lists organized by category (artist, album, etc.).
Rhapsody Radio	Select a network radio channel from the lists of the channels provided by Rhapsody.
Search	Use the software keyboard to search the desired item (artist, album, etc.) by keyword.
My Library	Select a track from items (artist, album, etc.) added to "My Library."

3 Press **11** ENTER to start playback.

The Now Playing view appears during playback.

Operating from the Now Playing view

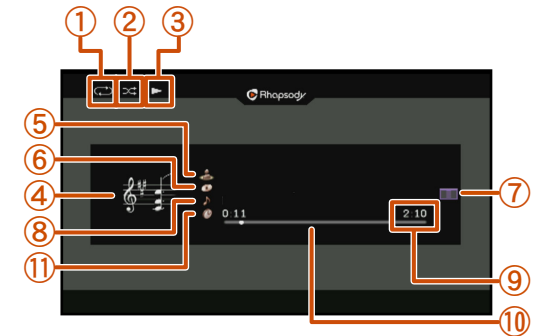

- 1 Repeat icon
- 2 Shuffle icon
- 3 Play icon
- 4 Album art
- 5 Artist name
- 6 Album title
- 7 Screen button area
Buttons for available operations are displayed. See "Screen buttons on the Now Playing view" for details.
- 8 Song title
- 9 Total playback time
- 10 Progress bar
- 11 Elapsed time

- You can switch the information displayed on the front panel display by pressing **6** INFO (see p. 10).
- Album art is available only when the album contains image data.





- 11 Cursor Δ / ∇
- 11 ENTER
- 12 \triangleright
- 12 \square
- 12 $\square\square$
- 12 $\triangleright\triangleright$
- 12 $\triangleleft\triangleleft$

Screen buttons on the Now Playing view

To use these buttons, first press **11**ENTER. Then select the desired one with **11**Cursor Δ / ∇ and **11**ENTER.

Play Control

Operates the basic playback functions of the Rhapsody.

\triangleright (Play)	Starts playback.
\square (Stop)	Stops playback.
$\square\square$ (Pause)	Stops playback temporarily.
$\triangleleft\triangleleft$ (Skip -)	Skips to the beginning of the currently playing song. Press 11 ENTER at the beginning of the song to skip to a previous song.
$\triangleright\triangleright$ (Skip +)	Skips to the beginning of the next song.

Utility

Add track to My Library	Adds the track currently selected to "My Library."
Add album to My Library	Adds the album currently selected to "My Library."

Scroll

Switches the scroll target (artist name, album name, or song name).

Browse

Switches the display to the Browse view.

Operating basic playback functions with the remote control

Use the following remote control keys to operate the Rhapsody.

12 \triangleright	Play
12 \square	Stop
12 $\square\square$	Switches between playback and pause.
12 $\triangleright\triangleright$	Skip forward during playback
12 $\triangleleft\triangleleft$	Skip backward during playback

Shuffle/repeat playback

Use the Option menu to apply playback shuffle and repeat settings. Refer to "Shuffle playback" ([p. 55](#)) and "Repeat playback" ([p. 55](#)) for details.



Listening to the SIRIUS Internet Radio

It's easy to enjoy SIRIUS entertainment at home. Listen to over 80 channels of commercial-free music, plus sports talk, news and entertainment. It all comes through your audio / video receiver and high-speed Internet connection.

If you're not a SIRIUS subscriber, you can sign up today for a PREMIUM SIRIUS Internet Radio subscription at www.sirius.com <<http://www.sirius.com/>>.

Current subscribers can add a PREMIUM SIRIUS Internet Radio subscription to an existing account.

SIRIUS Internet Radio account sign-in

When you use the SIRIUS Internet Radio service for the first time, follow the procedure below to sign in to your account for the service.

1 Press **[ON SCREEN]**.

2 Use **[Cursor Δ / ▽]** to select "Input" and press **[ENTER]**.

3 Use **[Cursor < / >]** to select "SIRIUS IR" and press **[Cursor Δ]**.

The following display appears when "Sign In" has not been completed yet. Read the description and then press **[ENTER]**.  1

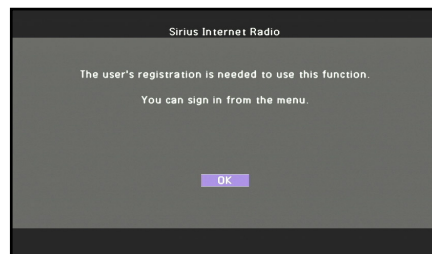

4 Press **[Cursor Δ / ▽]** to select "Sign In" or "SIRIUS IR Trial" and then press **[ENTER]**.

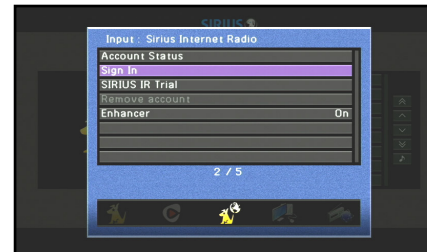

If "SIRIUS IR Trial" is selected, the confirmation message and the URL regarding the terms of trial service are displayed. Press **[Cursor < / >]** to select "OK" to continue. If "Successfully logged into account" is displayed, press **[ENTER]** to enable the SIRIUS Internet Radio Browse view.

5 Press **[ENTER]** to enter the User Name entry screen.

6 Use **[Cursor Δ / ▽ / < / >]** and **[ENTER]** to enter your user name password (up to 64 characters) and then select "OK" and press **[ENTER]**.

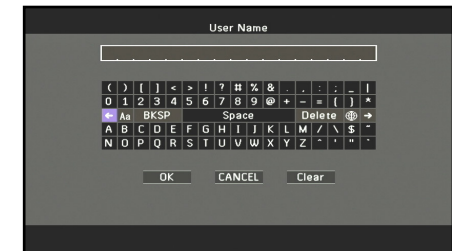

To clear the characters entered in step 6 and 8, select "Clear" and press **[ENTER]**.

7 Press **[ENTER]** to enter the User Password entry screen.

Continues to the next page

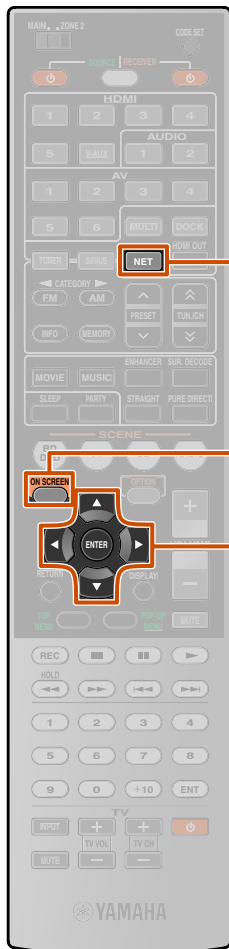

- 4** NET
- 10** ON SCREEN
- 11** Cursor Δ / ▽ / < / >
- 11** ENTER

 1 : When "Sign In" has not been completed yet, this description can be directly displayed by pressing **[4] NET** repeatedly to select "SIRIUS IR" as input source.

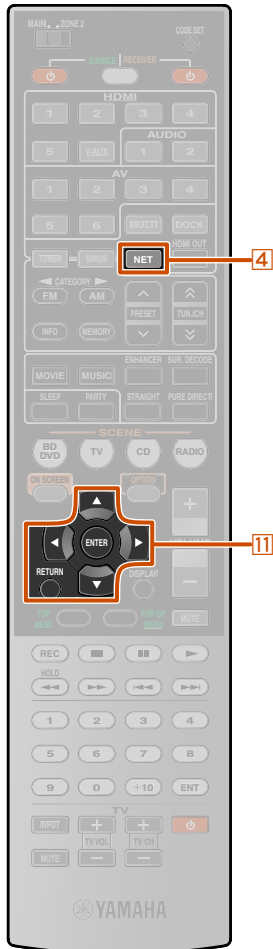

- 4 NET
- 11 Cursor $\Delta / \nabla / \triangleleft / \triangleright$
- 11 ENTER
- 11 RETURN

8 Use **11**Cursor $\Delta / \nabla / \triangleleft / \triangleright$ and **11**ENTER to enter your password (up to 64 characters) and then select “OK” and press **11**ENTER.

“Please wait...” is first displayed, followed by confirmation screen.

NOTE

If registration failed, the error message appears. In this case, read the message and start all over again.

9 Press **11**ENTER.
The SIRIUS Internet Radio Browse view is displayed.

Navigating the SIRIUS Internet Radio menu

The SIRIUS Internet Radio tuner can be operated from the content window on the TV screen.

You can operate the SIRIUS Internet Radio from the Now Playing view or the Browse view.

Operating from the Browse view



- ① Play icon
- ② Menu items
- ③ Channel art
- ④ Screen button area
Buttons for available operations are displayed. See “Screen buttons on the Browse view” for details.
- ⑤ Current menu number / Number of all menu items

Screen buttons on the Browse view

To use these buttons, first press **11**Cursor \triangleright . Then select the desired one with **11**Cursor Δ / ∇ and **11**ENTER.

10 Pages Up

10 Pages Down

Goes to 10 pages forwards or backwards.

1 Page Up

1 Page Down

Scrolls the list to the next or previous page.

Now Playing

Switches the display to the Now Playing view.

You can navigate the SIRIUS Internet Radio menu with the following remote control buttons.

1 Press **4**NET repeatedly to select “SIRIUS IR.”

2 Press **11**Cursor $\Delta / \nabla / \triangleleft / \triangleright$ to select a music file to play back.

- To select a file or folder, press **11**Cursor Δ / ∇ .
- To confirm the selection, press **11**ENTER.
- To return to the previous menu, press **11**RETURN.

3 Press **11**ENTER to start playback.
The Now Playing view appears during playback.



Operating from the Now Playing view

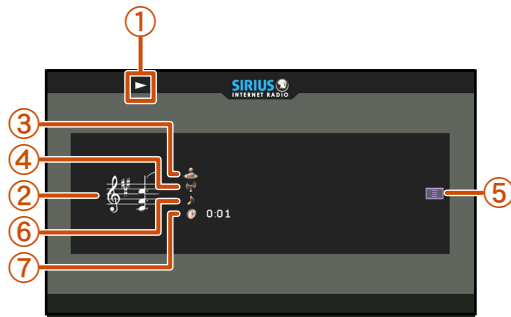
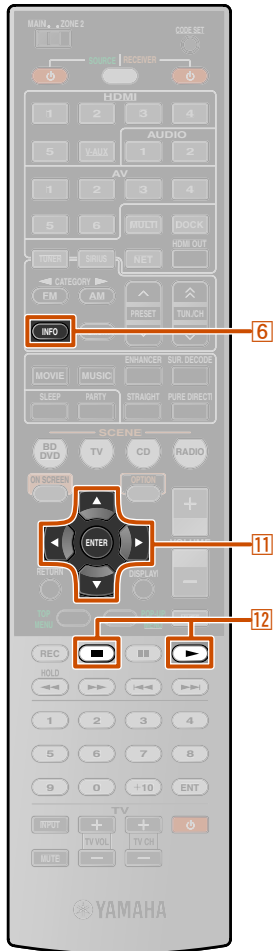

- ① **Play icon**
- ② **Channel art**
- ③ **Artist name**
- ④ **Channel name**
- ⑤ **Screen button area**
Buttons for available operations are displayed. See “Screen buttons on the Now Playing view” for details.
- ⑥ **Song title**
- ⑦ **Elapsed time**

- You can switch the information displayed on the front panel display by pressing [6] **INFO** (see p. 10).
- Channel art is available only when the selected channel contains image data.

Screen buttons on the Now Playing view

To use these buttons, first press [11] **ENTER**. Then select the desired one with [11] **Cursor** Δ / ∇ and [11] **ENTER**.

Play Control

Stops the current playback.

[12] (Stop)	Stops playback.
-------------	-----------------

Scroll

Switches the scroll target (artist name, album name, or song name).

Browse

Switches the display to the Browse view.

Operating basic playback functions with the remote control

Use the following remote control keys to operate the SIRIUS Internet Radio.

[12] \triangleright	Play
[12] \square	Stop

- [6] **INFO**
- [11] **Cursor** Δ / ∇
- [11] **ENTER**
- [12] \square
- [12] \triangleright

Using shortcut function

Use this feature to access the desired music sources (WAV, MP3 and WMA files on the connected PC, Internet Radio Stations, SIRIUS Internet Radio, and Rhapsody® music contents) directly. You can preset up to 40 items for above input sources.

■ Assigning the items to the preset number

1 Select a desired content you want to assign to a preset number, and then play back the content.

2 Press **[5]MEMORY**.
This unit automatically selects an empty preset number and the following display appears.



Preset number (Blinks)

- To automatically assign the selected content to an empty preset number, press and hold **[5]MEMORY** for at least 2 seconds with step 2. In this case, the following steps are unnecessary.
- To cancel the preset, press **[11]RETURN**.
- When you do not complete each of the following steps within 30 seconds, the memory preset mode is automatically canceled. In this case, start over from step 2.

3 Press **[5]PRESET ^ / v** or **[13]Numeric keys** to select the preset number that you want to assign.



Valid numbers as the preset number are "01" to "40."

4 Press **[5]MEMORY**.
The following display appears on the front panel display and the preset content is set.



■ Selecting the item assigned to the preset number

Press **[5]PRESET ^ / v** or **[13]Numeric keys** to select the preset number to which the desired item is assigned to select the item as the input source.

This unit starts the playback of the source assigned to the selected preset number.

NOTES

- "xx:Empty" appears on the front panel display when you select the preset number to which no items are assigned.
- This unit does not recall the correct item assigned to the selected preset number in the following cases:
 - the PC which stores the selected item is turned off or disconnected from the network.
 - the selected Internet Radio station, Rhapsody service or SIRIUS Internet Radio is temporary unavailable or out of service.
 - the directory of the selected item has been changed.

This unit stores the relative position of the preset items in a directory or playlist, and does not recall the correct item by using **[13]Numeric keys** if you add or delete music files to or from the same directory or playlist as the preset items. In such cases, preset the desired item to the preset numbers again.

We recommend the following methods:

PC server

Create playlists containing the desired content, and then assign the top item of each playlist to a preset number. To change the content assigned to preset numbers, replace the content registered with a playlist with new content without deleting the playlist.

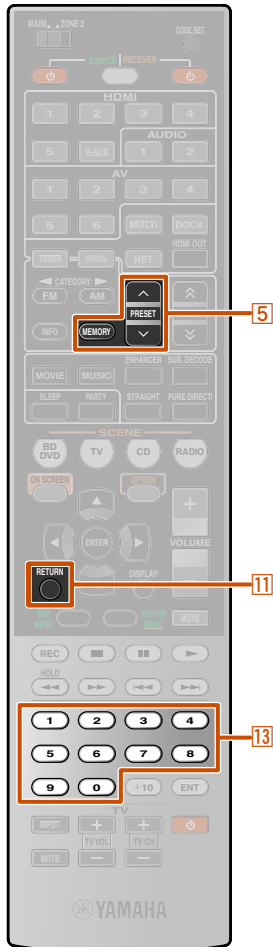

- [5] MEMORY**
- [5] PRESET ^ / v**
- [11] RETURN**
- [13] Numeric keys**



Playing back tunes from your iPod™/iPhone™

Once you have connected a Universal Dock for iPod (such as the YDS-12, sold separately) to this unit, you can enjoy playback of your iPod/iPhone using the remote control supplied with this unit. When playing back from an iPod/iPhone, you can also use the compressed music enhancer sound programs to give compressed audio formats such as MP3 a sharper, more dynamic sound (esp. 47). A Yamaha iPod wireless system (YID-W10, sold separately) can also be connected to this unit to play back iPod/iPhone with wireless connection.



4 DOCK
6 INFO

- **When playing back iPod/iPhone with wired connection**

Refer to “Connecting the Universal Dock for iPod.”

- **When playing back iPod/iPhone with wireless connection**

Refer to “Playing iPod/iPhone™ with wireless connection” (esp. 81).

Connecting the Universal Dock for iPod

Use the dedicated cable to connect the dock to the DOCK jack on the rear panel of this unit. Refer to the operating instructions of the Universal Dock for iPod for information on how to connect your iPod/iPhone.

- iPod touch, iPod (4th Gen/5th Gen/Classic), iPod nano, iPod mini, iPhone, iPhone 3G, and iPhone 3GS are supported (As of March 2010).
- When connecting iPhone, iPhone 3G and iPhone 3GS, use a YDS-12.
- Some features may not be compatible depending on the model or the software version of your iPod/iPhone.
- Some functions may not be available for some Universal Dock for iPod models. This explanation focuses on the YDS-12.

CAUTION

To prevent accidents, switch this unit to standby mode before connecting the Universal Dock for iPod.

Switch this unit on and place your iPod/iPhone in the dock. The unit is now ready for playback.

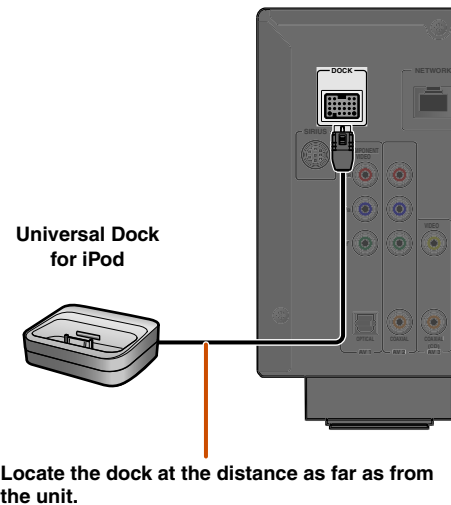

When this unit is in standby mode, iPod/iPhone can be charged automatically (esp. 89).

Controlling an iPod™/iPhone™

After setting your iPod/iPhone in your dock, just press 4 DOCK to switch to DOCK input to play your iPod/iPhone.

The iPod/iPhone can be operated in the following two ways.

Menu browse control:

Plays the iPod/iPhone while viewing the menu displayed on the TV. Refer to “Playing iPod/iPhone from the menu screen (Menu browse control)” (esp. 80).

Simple remote control:

Plays audio and video through this unit while viewing the menu displayed on the iPod/iPhone screen. Refer to “Operating basic playback functions via the remote control (Simple remote control)” (esp. 81).

- Song information (artist, album, song) is displayed on the front panel. Press 6 INFO repeatedly to display subsequent/previous information.
- The Yamaha logo is displayed on the iPod screen when iPod stationed in the Universal Dock for iPod (does not apply to the iPod touch or iPhone).
- Manual control of the iPod/iPhone is not possible while the iPod stationed in the Universal Dock for iPod.

Playing iPod/iPhone from the menu screen (Menu browse control)

The iPod/iPhone can be operated from the menu displayed on the TV screen.

You can operate the iPod/iPhone from the Now Playing view or the Browse view.

Operating from the Browse view

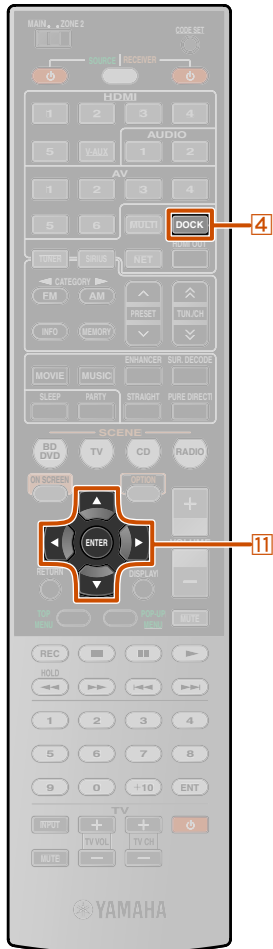

- 4 DOCK
- 11 Cursor Δ / ∇ / \triangleleft / \triangleright
- 11 ENTER

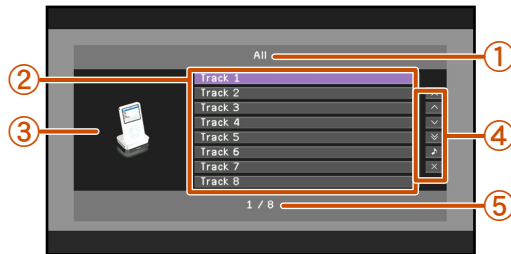

- 1 Input name / List name
- 2 Menu items
- 3 Input icon
- 4 Screen button area
Buttons for available operations are displayed. See "Screen buttons on the Browse view" for details.
- 5 Current menu number / Number of all menu items

Screen buttons on the Browse view

To use these buttons, first press 11 Cursor \triangleright . Then select the desired one with 11 Cursor Δ / ∇ and 11 ENTER.

10 Pages Up

10 Pages Down

Goes to 10 pages forwards or backwards.

1 Page Up

1 Page Down

Scrolls the list to the next or previous page.

Now Playing

Switches the display to the Now Playing view.

Close

Returns to the video playback, turning off the menu display.

1 Press 4 DOCK to switch to the DOCK input.

2 Press 11 Cursor Δ / ∇ to select the content (music or video) that you want to play, and press 11 ENTER. 

3 Press 11 Cursor Δ / ∇ to select iPod/iPhone menu items, and press 11 ENTER to play.
The Now Playing view appears during playback. 

Operating from the Now Playing view

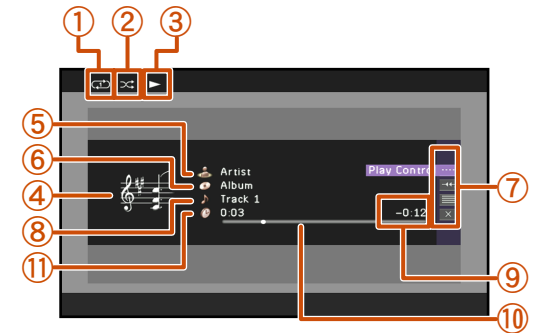

- 1 Repeat icon
- 2 Shuffle icon
- 3 Play icon
- 4 Album image
- 5 Artist name
- 6 Album title
- 7 Screen button area
Buttons for available operations are displayed. See "Screen buttons on the Now Playing view" for details.
- 8 Song title
- 9 Remaining time
- 10 Progress bar
- 11 Elapsed time

Screen buttons on the Now Playing view

To use these buttons, first press 11 ENTER. Then select the desired one with 11 Cursor Δ / ∇ and 11 ENTER.

 1: Videos will not be displayed when your iPod or Universal Dock for iPod do not support the browser function for browsing video files.

 2: When selecting the video content, the following display is not displayed.

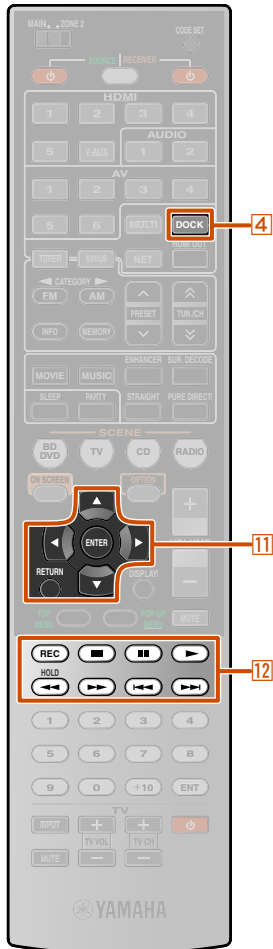

Play Control

Operates the basic playback functions of iPod/iPhone.

▷ (Play)	Starts playback.
◻ (Stop)	Stops playback.
⏸ (Pause)	Stops playback temporarily.
⏮ (Skip -)	Skips to the beginning of the currently playing song. Press 11 ENTER at the beginning of the song to skip to a previous song.
⏭ (Skip +)	Skips to the beginning of the next song.
⏪ (Scan -)	Searches backwards.
⏩ (Scan +)	Searches forwards.

Scroll

Switches the scroll target (artist name, album name, or song name).

Browse

Switches the display to the Browse view.

Close

Returns to the video playback, turning off the menu display.

Operating basic playback functions via the remote control (Simple remote control)

Use the following remote control keys to operate (playback, stop, skip, etc.) your iPod/iPhone. Press **12**REC to enable the Simple remote control. Press **12**REC again to return to the Menu browse control.

4 DOCK	Switches to the DOCK (iPod) input.
11 Cursor Δ / ▽	Move the cursor up and down to different fields.
11 RETURN	Returns to the previous menu.
11 ENTER	Enables the selected menu.
12 ⏪	Searches backwards while held down.
12 ⏭	Searches forwards while held down.
12 ⏮	Skips to the beginning of the currently playing song. Pressing repeatedly skips one song backwards with each press.
12 ⏭	Skips to the beginning of the next song.
12 ◻	Stops playback.
12 ⏸	Switches between playback and pause.
12 ▷	Switches between playback and pause.

Playing iPod™/iPhone™ with wireless connection

A Yamaha iPod wireless system (YID-W10, sold separately) can be connected to this unit to play back iPod/iPhone with wireless connection. The iPod/iPhone can be used as the remote control. **1**

Connecting the Yamaha iPod wireless transmitter and playing back iPod/iPhone

Use the dedicated cable to connect the receiver of the Wireless System for iPod to the DOCK jack on the rear panel of this unit. Refer to the operating instructions of the YID-W10 for more information.

CAUTION

To prevent accidents, unplug the power cable of this unit before connecting the receiver of the Wireless System for iPod.

Continues to the next page

- 4** DOCK
- 11** Cursor Δ / ▽
- 11** ENTER
- 11** RETURN
- 12** REC
- 12** ◻
- 12** ⏸
- 12** ▷
- 12** ⏮
- 12** ⏭
- 12** ⏪
- 12** ⏩

1 : Video signals cannot be transmitted wirelessly.





4 DOCK

Place the iPod/iPhone in the wireless transmitter. Setup is complete.

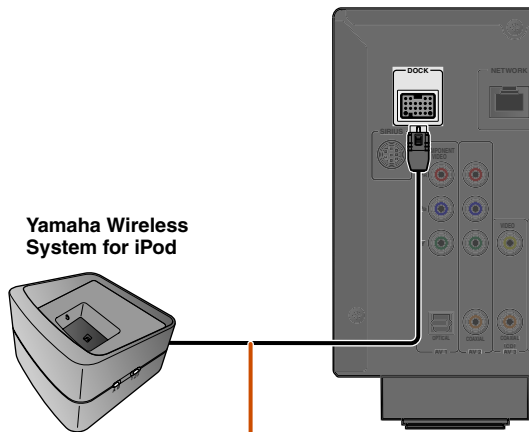

Position the receiver as far as possible from the unit.

When this unit is in standby mode, iPod/iPhone can be charged automatically, if “Standby Charge” is set to “Auto” (p. 89) or “Power & Input” of “iPod Interlock” is set to “On” (p. 89).

Use iPod/iPhone to start playback.

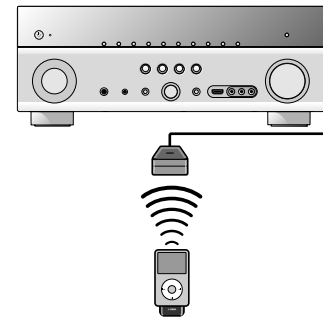

- This unit, which is placed in the main zone, functions as follows when iPod/iPhone controls are used to start playback.
 - The input source switches to DOCK (iPod) when this unit is turned on.
 - When this unit is in standby mode when iPod/iPhone playback starts, this unit turns on and the input source switches to DOCK (iPod). 🌱1
- This unit automatically enters standby mode when the following operations are performed.
 - iPod/iPhone is removed from the YID-W10
 - iPod/iPhone is not operated for a while after playback is stopped

- Pressing 4 DOCK also switches the input source to DOCK (iPod).
- When a menu is operated, this function is not activated.
- When “iPod Interlock” → “Power & Input” in the Input menu is set to “Off,” the power and the input source do not switch automatically (p. 89).

- Adjusting volume control on the iPod/iPhone also adjusts the volume (max 0.0 dB) of this unit.

When “iPod Interlock” → “Volume” in the Input menu is set to “Off,” the volume of this unit is not adjusted when iPod/iPhone volume controls are adjusted (p. 89).

CAUTION

When iPod/iPhone controls are used to adjust volume, playback volume may be unexpectedly loud. This could result in damage to this unit or the speakers. If the volume suddenly increases during playback, immediately remove the iPod/iPhone from the Universal Dock for iPod. “Max Volume” can be used to specify the maximum volume level to prevent excessively loud playback (p. 103).

🌱1 : This function is also activated when sound of application is reproduced or ringtone is received.

Playing back tunes from Bluetooth™ components

You can connect a Yamaha Bluetooth wireless audio receiver (such as the YBA-10, sold separately) to this unit and enjoy wireless playback from Bluetooth-compatible portable music players. 1

NOTE

When playing back from a Bluetooth component for the first time, you must first pair the devices (register the Bluetooth components). When establishing a wireless connection you must carry out pairing on both this unit and on the Bluetooth component.

Connecting a Yamaha Bluetooth wireless audio receiver

Use the dedicated cable to connect the dock to the DOCK jack on the rear panel of this unit. The Bluetooth wireless audio receiver connection will be complete when this unit is turned on.

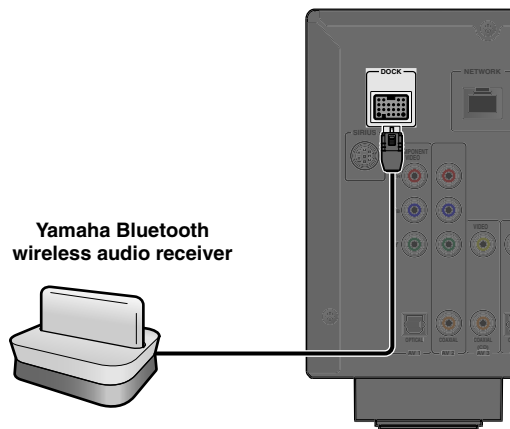

Yamaha Bluetooth wireless audio receiver

CAUTION

To prevent accidents, switch this unit to standby mode before connecting a Bluetooth wireless audio receiver.

Pairing Bluetooth™ components

Be sure to carry out pairing when connecting a Bluetooth component for the first time, or when settings have been deleted. Refer to the operating instructions of your Bluetooth component as necessary when carrying out pairing.

The Yamaha Bluetooth wireless audio receiver can be paired with up to eight Bluetooth components. When the ninth device is paired, the pairing settings for the device which has not been used for the longest period of time will be deleted.

- 1 Press **4 DOCK** to switch to the DOCK input.
- 2 Turn on the Bluetooth component you want to pair with and set it to pairing mode.

- 3 Press **20 OPTION** to display the Option menu and use **11 Cursor Δ / ▽** to select “Pairing.”



- 4 Press **11 ENTER** to start pairing.



- To cancel pairing, press **11 RETURN**.
- You can also press and hold **5 MEMORY** on the remote control to begin pairing.

Continues to the next page

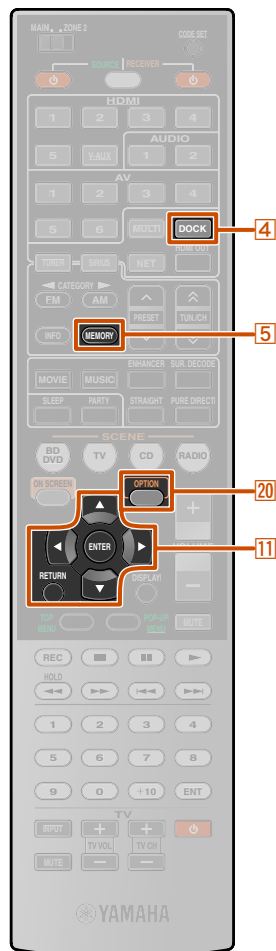

- 4 DOCK**
- 5 MEMORY**
- 11 Cursor Δ / ▽**
- 11 ENTER**
- 11 RETURN**
- 20 OPTION**

1: This unit supports A2DP (Advanced Audio Distribution Profile) of the Bluetooth profile.

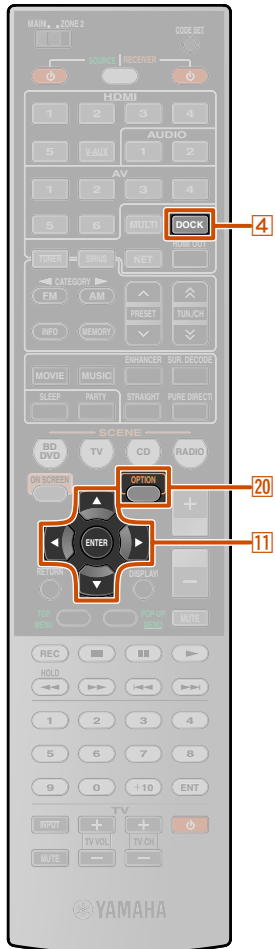

- 4** DOCK
- 11** Cursor Δ / ∇
- 11** ENTER
- 20** OPTION

5 Make sure the Bluetooth component recognizes the Bluetooth wireless audio receiver.

When the device is recognized, it will appear in the Bluetooth component list, for example as “YBA-10 YAMAHA.”

6 Select the Bluetooth wireless audio receiver from the Bluetooth component list, and enter a pass key “0000” into the Bluetooth component.

When pairing occurs correctly



Using Bluetooth™ components

When pairing is complete, perform the following procedure to achieve a wireless connection between this unit and the Bluetooth component. When the wireless connection is complete, Bluetooth components can be played back.

Depending on Bluetooth components, a wireless connection is established automatically or by operating the Bluetooth components. In that case, it is not necessary to carry out the following procedure.

1 Press **4** DOCK to switch to the DOCK input.

2 Press **20** OPTION to display the Option menu.

3 Use **11** Cursor Δ / ∇ to select “Connect” and press **11** ENTER.

When wireless connection is complete



“Not found” is displayed when there is an error connecting. Check that the following conditions have been satisfied, and try to establish a wireless connection again.

- Both this unit and the Bluetooth component are paired.
- The Bluetooth component is switched on.
- The Bluetooth component is within 32 ft. (10 m) of the Bluetooth wireless audio receiver.

4 Operate the Bluetooth component for playback.

To disconnect a wireless connection, repeat the same steps, and in step 3, select “Disconnect.”

1 : Depending on Bluetooth components, wireless connection is carried out right after the pairing. In this case, “BT connected” is displayed instead of “Completed.”

2 : “Disconnect” is displayed when a Bluetooth component has been connected.

Changing the friendly name of this unit by using the web browser

You can change the friendly name of this unit by using the graphical user interface that appears on the web browser.

Friendly name is the identification name informed to external components in the same network. For example, the icon indicating this unit may be easily recognized by the original friendly name when the sharing media function of Windows Media Player is used (p. 67).

Check the IP address of this unit by using “IP Address” in “Network” menu (p. 108) in advance, and then enter the IP address to the web browser to access this unit to change the friendly name.

NOTE

When “Network Standby” is set to “On” in the Network menu, the graphical user interface can be displayed on the web browser even if this unit was in standby mode (p. 108). When “Network Standby” is set to “Off,” we recommend that “Network Standby” is set to “On.”

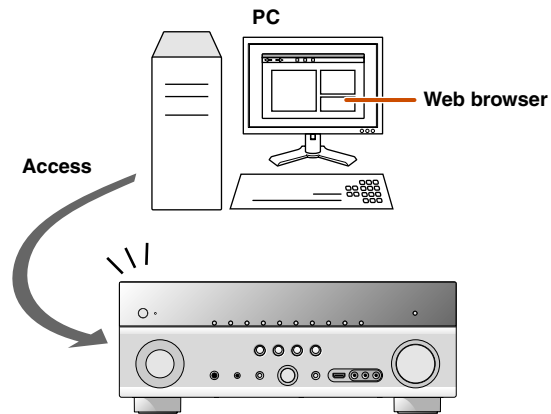

Changing the friendly name of this unit

E.g.,
[RX-V867] (default) → [YAMAHA AV Amplifier]

- To use this feature, this unit and your PC must be connected properly in the network. Refer to “Connecting to the network” for details on the connections (p. 32).
- We recommend that you use Windows Internet Explorer 8 that is installed on Windows XP or Windows 7 PC to access this unit.
- You can register the MAC address of the PCs you want to use to control this unit and limit the PCs that can control this unit by using the web browser. You can select that this unit allows the access to this unit by the PCs whose MAC addresses are registered to this unit or allows the access by any PCs by using “MAC Address Filter” in the “Network” setup (p. 108).

When your PC successfully accesses this unit, the following screen is displayed on the web browser.

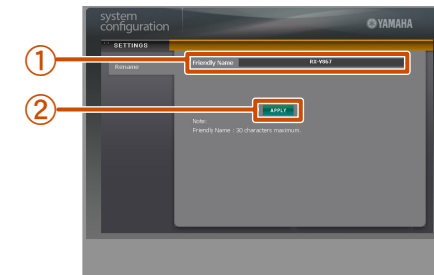

- ① **Friendly Name**
Enter your favorite friendly name in the box.
- ② **APPLY**
Applies the friendly name entered to this unit.

SETUP

Configuring input sources (Input menu)

Settings, such as the name of an input source or the icon displayed for an input source can be changed from the Input menu.

Configuring input sources

The name of an input source and its icon, as well as other input source settings, can be changed from the Input menu displayed on the TV screen.

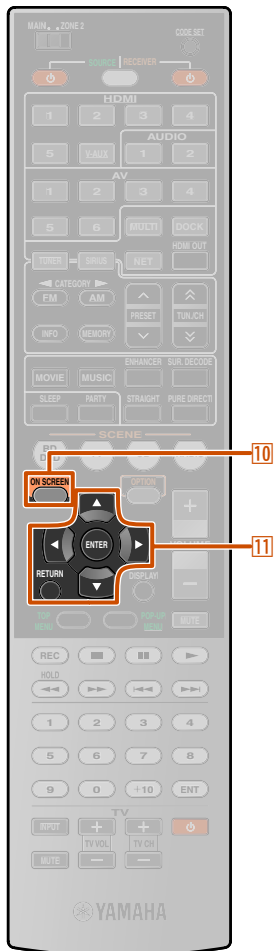

- 10 ON SCREEN
- 11 Cursor $\Delta / \nabla / \triangleleft / \triangleright$
- 11 ENTER
- 11 RETURN

1 Press **10 ON SCREEN**.

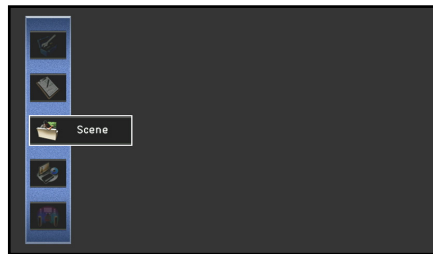

2 Use **11 Cursor Δ / ∇** to select "Input" and press **11 ENTER**.

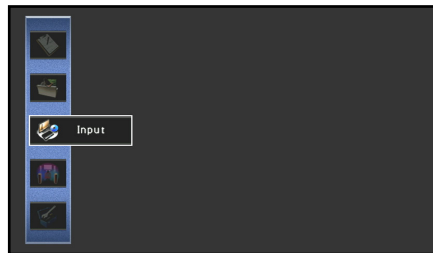

3 Use **11 Cursor $\triangleleft / \triangleright$** to select an input source to be configured and press **11 Cursor Δ** .



4 Use **11 Cursor Δ / ∇** to select an item and press **11 ENTER**.



If the selected item contains additional items, use **11 Cursor Δ / ∇** to select the desired item and press **11 ENTER**.

5 Use **11 Cursor Δ / ∇** to adjust the setting.

Pressing **11 RETURN** displays the previous menu screen. Repeat steps 4 to 5 to adjust multiple settings.

6 Press **10 ON SCREEN** to close the menu.



Input menu

The following items are provided for each input source. “✓” indicates the available menu for each input source.

	HDMI 1-5	AV1-2	AV3-4	AV5-6	V-AUX	AUDIO1-2	TUNER	SIRIUS	Rhapsody	SIRIUS IR	PC	NET RADIO	DOCK (iPod)	DOCK (Bluetooth)	MULTI CH
Rename/Icon Select	✓	✓	✓	✓	✓	✓							✓	✓	✓
Audio In	✓	✓													
Decoder Mode	✓	✓	✓		✓										
Enhancer	✓	✓	✓	✓	✓	✓	✓	✓	✓	✓	✓	✓	✓	✓	
DMC Control											✓				
Account Status									✓	✓					
Sign In									✓	✓					
Rhapsody Trial									✓						
Remove Account									✓	✓					
SIRIUS IR Trial										✓					
Standby Charge													✓		
iPod Interlock													✓ 		
Video Out															✓

 1: Not available when playing back iPod/iPhone with wired connection.



11 Cursor $\Delta / \nabla / \triangleleft / \triangleright$
11 ENTER

Changing an input source name or icon

Rename/Icon Select

Changes the input source name (up to nine characters) and icon displayed on the front panel display or TV screen.

- Use **11**Cursor Δ / ∇ repeatedly to select “Rename/Icon Select” and press **11**ENTER.

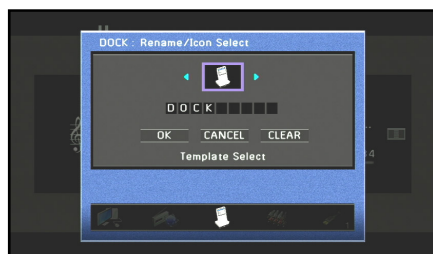

- Use **11**Cursor $\triangleleft / \triangleright$ to choose an icon.

- Press **11**Cursor ∇ and **11**ENTER. Editing the name is available.

- Press **11**Cursor Δ / ∇ to select a character, and press **11**Cursor $\triangleleft / \triangleright$ to enter the selected character.

- Repeat step 4 to enter the desired input source name.

- Confirm the input source name by pressing **11**ENTER.

- Press **11**Cursor ∇ to select “OK” and press **11**ENTER to register the new input name.

- To cancel the operation without applying changes, select “CANCEL” and then press **11**ENTER.
- To clear the characters entered in step 5, select “CLEAR” and press **11**ENTER.

Combining HDMI/AV1-2 input source video and audio

Audio In

Combines video from HDMI or AV input sources with analog/digital audio inputs in situations such as:

- an playback device is connected with an HDMI cable but cannot transmit audio through HDMI
- an playback device with component video output and analog audio output (such as certain game consoles) are connected to the system

To change assignments, select an input source (HDMI1-5 or AV1-2) as the video input first, and then select audio input jacks in this menu.

Set as follows according on the desired combination of audio input jacks.

Audio inputs	Settings method
Optical digital audio input	Select AV1 or AV4. Connect the external component audio cable to the optical digital jack for the selected input.
Coaxial digital audio input	Select AV2 or AV3. Connect the external component audio cable to the coaxial digital jack for the selected input.
Analog audio input	Select one of AV5, AV6, AUDIO1, or AUDIO2. Connect the external component audio cable to the audio jack for the selected input.

11 1: AV5-6 or AUDIO1-2 are also available when “Audio Return Channel” is on, and the input source is used for “TV Audio Input.”

Setting the format of digital audio signals

Decoder Mode

Sets the format of digital audio to playback to DTS. For example, if the format is not automatically detected correctly even during playback of DTS format audio, this item can be used to set the playback format to DTS. **11** 1

Auto (Default)	The audio format is automatically selected to match the format of the input audio.
DTS	Selects DTS signals only. Other input signals are not reproduced.

Using a PC to control this unit over a network

DMC Control

This unit can be operated via the DLNA compatible controller (e.g., Windows Media Player, etc.) to the same network of this unit.

DMC stands for “Digital Media Controller.”

Disable	Disables the DMC control function.
Enable (Default)	Enables the DMC control function.

■ Confirming the account of the Rhapsody service or SIRIUS Internet Radio

Account Status

Displays the current account status of Rhapsody service or SIRIUS Internet Radio.

■ Sign in to your account for the Rhapsody service or SIRIUS Internet Radio

Sign In

Sign in to your account for the Rhapsody service or SIRIUS Internet Radio ([p. 71](#), [p. 75](#)).

Rhapsody Trial

Displays the URL for free 30-day trial service content. Create an account in the specified website, sign in to your account with “Sign In” to get started with a free trial.

SIRIUS IR Trial

Creates a temporary account for free 30-day trial and sign in to the account automatically.

Refer to “Rhapsody® account sign-in” ([p. 71](#)) or “SIRIUS Internet Radio account sign-in” ([p. 75](#)) for details on signing in to your account.

■ Removing your account from the Rhapsody service or SIRIUS Internet Radio

Remove Account

Removes an account registered with the Rhapsody service or SIRIUS Internet Radio.

■ Selecting the sound program suitable for listening to compressed audio, such as MP3

Enhancer

Turns on/off the Compressed Music Enhancer.

Off (Default)	Turns off the Compressed Music Enhancer.
On	Turns on the Compressed Music Enhancer.

■ Charging an iPod™/iPhone™ in standby mode

Standby Charge

Charges an iPod/iPhone stationed in the Universal Dock for iPod / iPhone or receiver of the Wireless System for iPod while the receiver is in standby mode.

Auto (Default)	This unit charges iPod/iPhone when this unit is in standby mode. While charging an iPod/iPhone, the HDMI Through/iPod Charge indicator lights. When HDMI Through function is off, the indicator goes out after the charging is complete.
Off	This unit does not charge iPod/iPhone.

■ Setting the interlock functions with iPod/iPhone (when a Yamaha Wireless System for iPod is connected)

iPod Interlock

This unit can be automatically operated in conjunction with operations on iPod when the receiver of the Wireless System for iPod is connected to this unit.

Power & Input	Starting playback of iPod/iPhone turns on this unit and switches the input source to DOCK (iPod) automatically when this item is set to “On.” This unit automatically enters standby mode when iPod/iPhone is not operated for a while after playback is stopped. This interlock function is disable with “Off.”
Volume	Adjusting the volume on the iPod/iPhone also adjusts the volume of this unit when this item is set to “On.” This interlock function is disable with “Off.”

■ Outputting a video signal input from another input source while playing a multi-channel audio signal

Video Out

When “MULTI CH” is selected as the input source, a video signal input from another terminal can be output to the video monitor. For example, even if an audio and video component such as a DVD player that does not support a multi-channel digital audio output, the video signal can be output to the video monitor while reproducing a multi-channel analog audio signal.

Editing the SCENE function (SCENE menu)

The SCENE function (p. 44) can be edited from the SCENE menu displayed on the TV screen.

Editing a scene

Various settings, such as the name of a scene or the icon displayed for a scene, can be changed from the SCENE menu.

- 1 Press **[ON SCREEN]**.

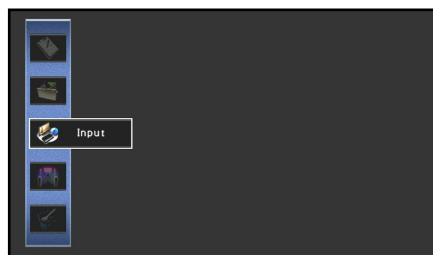

- 2 Use **[Cursor Δ / ▽]** to select "Scene" and press **[ENTER]**.

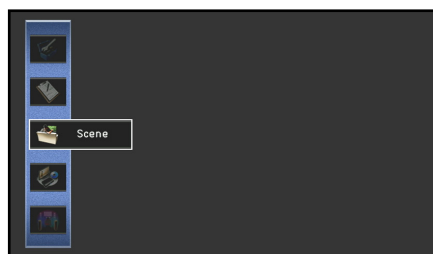

- 3 Use **[Cursor < / >]** to select a scene to be edited and press **[Cursor Δ]**.

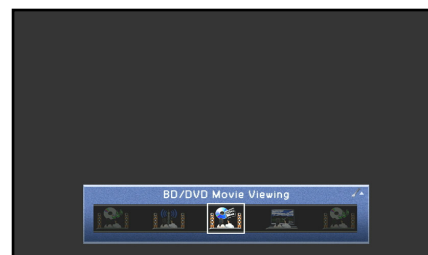

- 4 Use **[Cursor Δ / ▽]** to select an item and press **[ENTER]**.



When the Utility is available in the selected item, use **[Cursor Δ / ▽]** to select the Utility and press **[ENTER]**.

- 5 Use **[Cursor Δ / ▽ / < / >]** to adjust the setting.

Pressing **[RETURN]** displays the previous menu screen. Repeat steps 4 and 5 to adjust multiple settings.

- 6 Press **[ON SCREEN]** to close the menu.

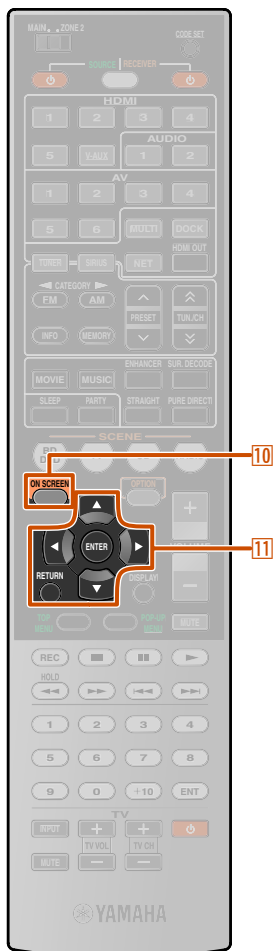

- [10] ON SCREEN**
- [11] Cursor Δ / ▽ / < / >**
- [11] ENTER**
- [11] RETURN**

SCENE menu

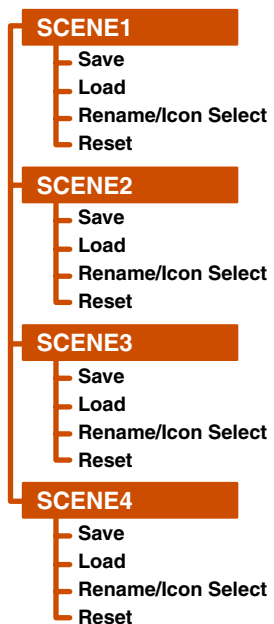

Registering SCENE function settings

Save

Registers the settings currently applied to this unit for each SCENE.

Adjusting settings registered with the SCENE function

Load

Loads input sources or sound programs that have been registered with the SCENE function, or specifies whether or not an external component registered as the input source is automatically turned on when a scene is selected.

Ok	Loads items indicated with a check mark in "Setting."
Cancel	Cancels settings applied with "Setting."
DETAIL	Specifies "SCENE IR" function and displays settings registered with the SCENE function in detail. For more information, see "SCENE IR" and "Detail" at right.

SCENE IR

Specify whether or not a Yamaha BD/DVD player or CD player connected to this unit turns on automatically.

Off	Disables the SCENE IR function.
Yamaha BD/DVD Player1	Select this when a Yamaha BD/DVD player is connected to this unit.
Yamaha BD/DVD Player2	Select this if the player dose not turn on when "Yamaha BD/DVD Player1" is selected.
Yamaha CD Player	Select this when a Yamaha CD player is connected to this unit.

Detail

Display details of settings registered with the SCENE function. Items indicated with a check mark in "Setting" are loaded.

Input	Displays "Input" and "Audio Select" settings registered with the SCENE function.
Mode	Displays the sound program registered with the SCENE function.
Enhancer	Displays the "Enhancer" setting registered with the SCENE function.



11 Cursor $\Delta / \nabla / \triangleleft / \triangleright$
11 ENTER

Changing a scene name and icon

Rename/Icon Select

Changes the scene name and icon displayed on the front panel display or TV screen.

1 Use **11**Cursor Δ / ∇ repeatedly to select “Rename/Icon Select” and press **11**ENTER.

2 Use **11**Cursor $\triangleleft / \triangleright$ to choose an icon.



3 Press **11**Cursor ∇ and **11**ENTER.
 Editing the name is available.

4 Press **11**Cursor Δ / ∇ to select a character, and press **11**Cursor $\triangleleft / \triangleright$ to enter the selected character.

Scene names may consist of up to 20 characters.

5 Repeat step 4 to enter the desired scene name.

6 Confirm the scene name by pressing **11**ENTER.

7 Press **11**Cursor ∇ to select “OK” and press **11**ENTER to register the new input name.

- To cancel the operation without applying changes, select “CANCEL” and then press **11**ENTER.
- To clear the characters entered in step 4, select “CLEAR” and press **11**ENTER.

Resetting a scene

Reset

Restores all settings for the selected scene to their default values.

Setting sound program parameters (Sound Program menu)

Sound effects can be adjusted from the Sound Program menu.

Editing sound programs

Adjust sound field elements (sound program parameters) to achieve sound effects suited to the acoustics of audio/video sources or rooms if you are not satisfied with the results achieved with default sound program settings. Follow the procedure described below to adjust sound program parameters.

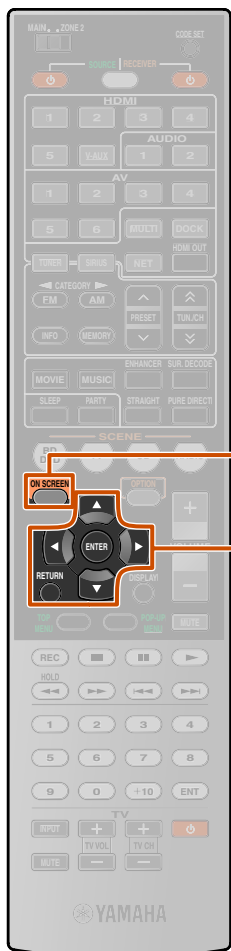

- 10** ON SCREEN
- 11** Cursor $\Delta / \nabla / \triangleleft / \triangleright$
- 11** ENTER
- 11** RETURN

1 Press **10** ON SCREEN.

2 Press **11** Cursor Δ / ∇ repeatedly to select "Sound Program" and press **11** ENTER.

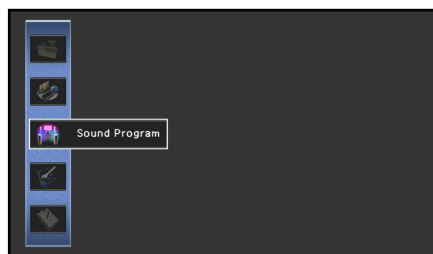

3 Use **11** Cursor $\triangleleft / \triangleright$ to select a sound program and press **11** Cursor Δ .

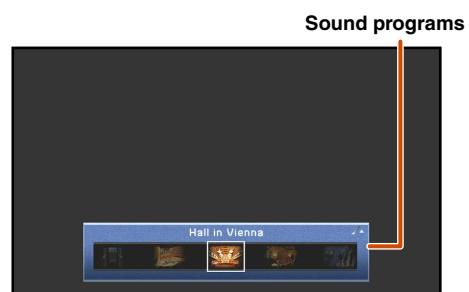

4 Use **11** Cursor Δ / ∇ to select a parameter and press **11** ENTER.

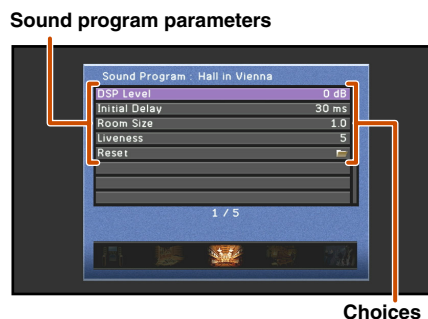

5 Use **11** Cursor $\triangleleft / \triangleright$ to adjust the parameter and press **11** RETURN. 1

When there are multiple parameters in the selected sound program, repeat steps 4 and 5 to adjust other parameters.

6 Press **10** ON SCREEN to close the Sound Program menu.

■ To initialize sound program parameters
To set the parameters of the sound program back to their default settings, use **11** Cursor Δ / ∇ repeatedly to select "Reset" in step 4 and press **11** ENTER. When the following message is displayed, select "OK" and press **11** ENTER to initialize.



To cancel initializing, select "CANCEL" and press **11** ENTER when the message above is displayed.

1: An asterisk (*) appears on the left of the sound field parameter name displayed on the TV when you change the parameter from its default setting.

CINEMA DSP parameters

DSP Level

Change the effect level (level of the sound field effect to be added). You can adjust the level of the sound field effect while checking the sound effect.

Adjustable range	-6 dB to +3 dB
Default setting	0 dB

Adjust "DSP Level" as follows:

- The effect sound is too soft.
→ Increase the effect level.
- There are no differences between effects of the sound programs.
→ Increase the effect level.
- The sound is dull.
→ Reduce the effect level.
- The sound field effect is added too much.
→ Reduce the effect level.

Initial Delay

Surround Initial Delay

Surround Back Initial Delay

Initial delay. Presence, surround, and surround back sound field initial delay. Changes the apparent size of the sound field by adjusting the delay between the direct sound and the first reflection heard by the listener. The smaller the value, the smaller the sound field seems to the listener.

Adjustable range	1 to 99 ms (Initial Delay) 1 to 49 ms (Surround Initial Delay and Surround Back Initial Delay)
------------------	---

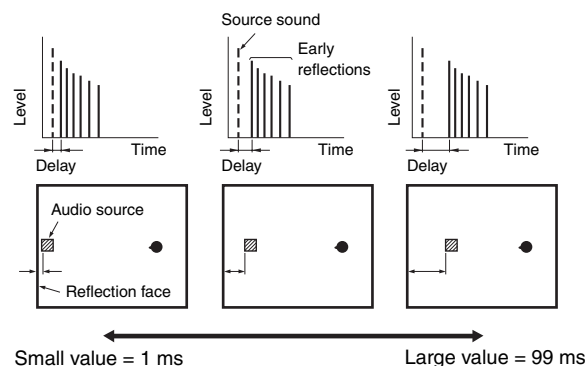

When you adjust the initial delay parameters, we also recommend that you adjust the corresponding room size parameters likewise.

Room Size

Surround Room Size

Surround Back Room Size

Room size. Presence, surround, and surround back room size. Adjusts the apparent size of the sound field. The larger the value, the larger the surround sound field becomes. As the sound is repeatedly reflected around a room, the larger the hall is, the longer the time between the original reflected sound and the subsequent reflections. By controlling the time between the reflected sounds, you can change the apparent size of the virtual venue. Changing this parameter from one to two doubles the apparent length of the room.

Adjustable range	0.1 to 2.0
------------------	------------

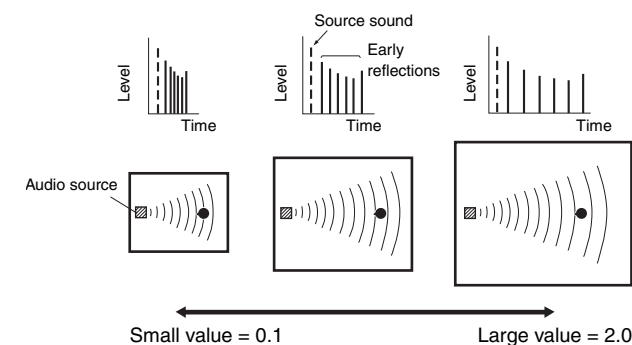

When you adjust the room size parameters, we also recommend that you adjust the corresponding initial delay parameters likewise.

Liveness

Surround Liveness

Surround Back Liveness

Liveness. Surround and surround back liveness. Adjusts the reflectivity of the virtual walls in the hall by changing the rate at which the early reflections decay. The early reflections of an audio source decay much faster in a room with acoustically absorbent wall surfaces than in one which has highly reflective surfaces. A room with acoustically absorbent surfaces is referred to as “dead,” while a room with highly reflective surfaces is referred to as “live.” This parameter lets you adjust the early reflection decay rate and thus the “liveness” of the room.

Adjustable range	0 to 10
-------------------------	---------

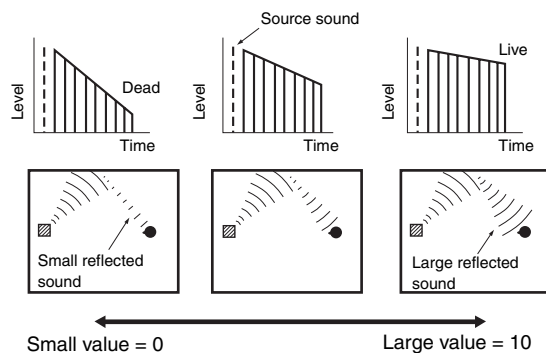

Reverb Time

Reverberation time. Adjusts the amount of time taken for the dense, subsequent reverberation sound to decay by 60 dB at 1 kHz. This changes the apparent size of the acoustic environment over an extremely wide range. Set a longer reverberation time to get more sustaining reverberation sound, and set a shorter time to get articulate sound.

Adjustable range	1.0 to 5.0 s
-------------------------	--------------

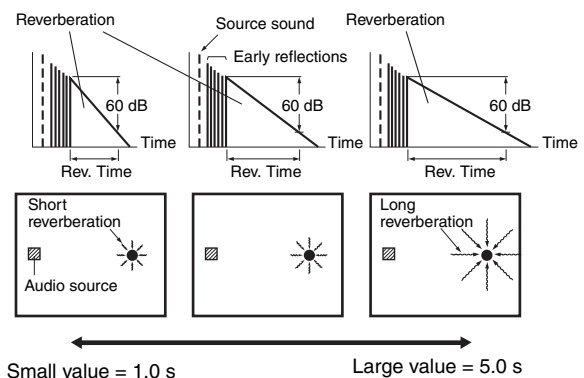

Reverb Delay

Reverberation delay. Adjusts the time difference between the beginning of the direct sound and the beginning of the reverberation sound. The larger the value, the later the reverberation sound begins. A later reverberation sound makes you feel as if you are in a larger acoustic environment.

Adjustable range	0 to 250 ms
-------------------------	-------------

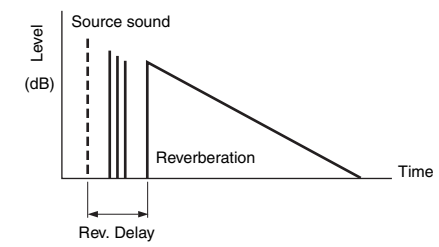

Reverb Level

Reverberation level. Adjusts the volume of the reverberation sound. The larger the value, the stronger the reverberation becomes.

Adjustable range	0 to 100%
-------------------------	-----------

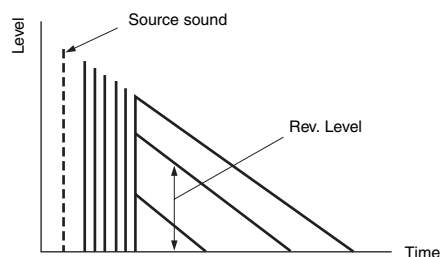

Decode Type

Selects a surround decoder to be used with a sound program in the MOVIE category. 🌟1

PLIIx Movie PLII Movie	Selects the Dolby Pro Logic IIx Movie (or Dolby Pro Logic II Movie) decoder.
Neo:6 Cinema	Selects the Neo:6 (Cinema) decoder.

Parameters usable in certain sound programs

2ch Stereo only

Direct

Automatically bypasses the DSP circuit and tone control circuit depending on the condition of tone control etc., when an analog audio source is played back. You can enjoy a higher quality sound.

Auto (Default)	Outputs sound by bypassing the DSP circuit and tone control circuit when both tone controls of “Bass” and “Treble” are set to 0 dB.
Off	Does not bypass the DSP circuit and tone control circuit.

7ch Stereo only

Center Level

Adjusts the center channel volume. 🌟2

Adjustable range	0 to 100%
Default setting	100%

Surround L Level

Adjusts the volume of the surround L channel. 🌟2

Adjustable range	0 to 100%
Default setting	100%

Surround R Level

Adjusts the volume of the surround R channel. 🌟2

Adjustable range	0 to 100%
Default setting	100%

Surround Back L Level

Adjusts the volume of the surround back L channel. 🌟2

Adjustable range	0 to 100%
Default setting	35% (7.1-channel configuration) 50% (6.1-channel configuration)

Surround Back R Level

Adjusts the volume of the surround back R channel. 🌟2

Adjustable range	0 to 100%
Default setting	35% (7.1-channel configuration) 50% (6.1-channel configuration)

Front Presence L Level

Adjusts the volume of the front presence L channel. 🌟2

Adjustable range	0 to 100%
Default setting	33%

🌟1 : Surround decoders cannot be changed when used with the following MOVIE sound programs.

- Mono Movie
- Sports
- Action Game
- Roleplaying Game

🌟2 : Not displayed when speakers are set to be inactive.

Front Presence R Level

Adjusts the volume of the front presence R channel. 🌱1

Adjustable range	0 to 100%
Default setting	33%

Parameters usable in surround decoder

Decode Type

Selects a surround decoder.

Pro Logic	Reproduces sound using the Dolby Pro Logic decoder. This is suitable for all kinds of audio sources.
PLIIx Movie / PLII Movie	Reproduces sound using the Dolby Pro Logic IIx (or Dolby Pro Logic II) decoder. This is suitable for movies. 🌱2
PLIIx Music / PLII Music	Reproduces sound using the Dolby Pro Logic IIx (or Dolby Pro Logic II) decoder. This is suitable for music. 🌱2
PLIIx Game / PLII Game	Reproduces sound using the Dolby Pro Logic IIx (or Dolby Pro Logic II) decoder. This is suitable for games. 🌱2
Neo:6 Cinema	Reproduces sound using the DTS Neo:6 decoder. This is suitable for movies.
Neo:6 Music	Reproduces sound using the DTS Neo:6 decoder. This is suitable for music.

Dolby PLIIx Music and Dolby PLII Music only

Panorama

Adjusts the soundscape of the front sound field. Sends front left/right channels sounds to the surround speakers as well as the front speakers for a wraparound effect.

Off (Default)	Disables the effect.
On	Enables the effect.

Center Width

Spreads the center channel sound to the front left and right speakers to suit your needs or preferences. Set this parameter to 0 for outputting the center sound from the center speaker only, or to 7 for outputting it from the front left/right speaker only.

Adjustable range	0 to 7
Default setting	3

Dimension

Adjusts the difference in level between the front sound field and the surround sound field. You can adjust the difference in level created by the software being played back to obtain the preferred sound balance.

The surround sound gets stronger as you make the value more negative, and the front sound gets stronger as you make the value more positive.

Adjustable range	-3 to +3
Default setting	0

When Neo:6 Music is selected

Center Image

Adjusts the front left and right channel output relative to the center channel to make the center channel more or less dominant as necessary.

Adjustable range	0.0 to 1.0
Default setting	0.3

🌱1: Not displayed when speakers are set to be inactive.

🌱2: You cannot select the Dolby Pro Logic IIx decoder in the following conditions:

- When "Surround Back" is set to "None" ([**p. 100](#)).
- When headphones are connected.

Setting various functions (Setup menu)

Various settings, such as speaker volume or HDMI functions, can be changed from the Setup menu.

Operating the Setup menu

- 1 Press **[ON SCREEN]**.
- 2 Press **[Cursor Δ / ▽]** repeatedly to select "Setup" and press **[ENTER]**.

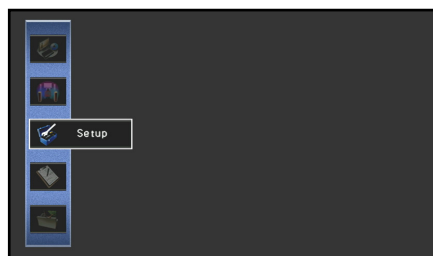
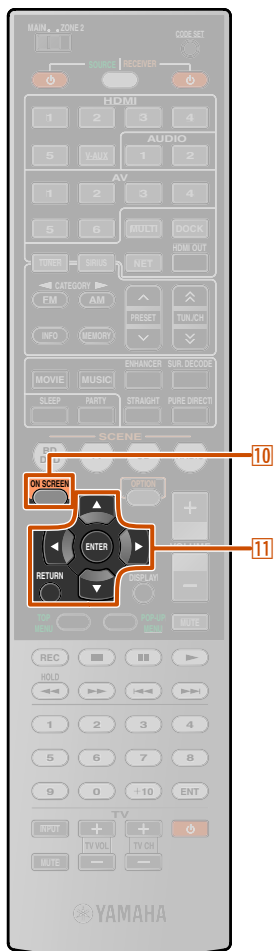

- 3 Use **[Cursor < / >]** to select a menu and press **[ENTER]**.

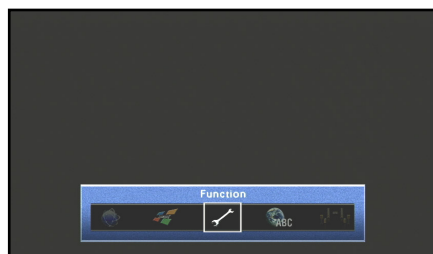

Setup menu setting

Speaker	Adjusts parameters for speakers, such as speaker status, and volume adjustment for each speaker (p. 99).
Sound	Sets functions related to audio output, such as adjustment of maximum volume and of dynamic range (p. 103).
Video	Sets video output functions, such as video conversion settings (resolution and aspect ratio) (p. 104).
HDMI	Sets HDMI functions, such as the HDMI Control function and output destination for HDMI sound (p. 105).
Network	Sets network status, such as IP Address or MAC Address Filter (p. 108).
Multi Zone	Sets multi-zone functions, such as volume adjustment for speakers in the secondary zone (p. 109).
Function	Sets functions such as the Auto Power Down function, that make the unit easier to use (p. 109).
Language	Selects the language of the menus and messages displayed on TV screen (p. 112).

- 4 Use **[Cursor Δ / ▽]** to select an item and press **[ENTER]**.



When the selected item contains detailed ones, use **[Cursor Δ / ▽]** to select the detailed item and press **[ENTER]**.

- 5 Use **[Cursor Δ / ▽ / < / >]** to adjust the setting.

Pressing **[RETURN]** displays the previous menu screen. Repeat steps 4 to 5 to adjust multiple settings.

- 6 Press **[ON SCREEN]** to close the menu.

- [ON SCREEN]**
- [Cursor Δ / ▽ / < / >]**
- [ENTER]**
- [RETURN]**

Setup menu

- Speaker**
 - Auto Setup
 - Manual Setup
- Sound**
 - Lipsync
 - Dynamic Range
 - Max Volume
 - Initial Volume
 - Adaptive DSP Level
- Video**
 - Analog to Analog Conversion Processing
- HDMI**
 - HDMI Control
 - Control Select
 - ARC (Audio Return Channel)
 - TV Audio Input
 - Audio Output
 - Standby Through
- Network**
 - IP Address
 - Network Standby
 - MAC Address Filter
- Multi Zone**
 - Zone2 Set
 - Party Mode Set
 - Zone Rename
- Function**
 - Auto Power Down
 - Display Set
 - Trigger Output
 - Memory Guard
- Language**

Manages settings for speakers



Speaker Setup items

Auto Setup	Optimizes the speaker configuration automatically.
Manual Setup	Manually adjusts parameters for speakers.

Automatic speaker setup

Auto Setup

Optimizes the speaker configuration automatically using YPAO (p. 34).

Manual speaker setup

Manual Setup

The following parameters can be specified manually.

Power Amp Assign	Adds the extra speakers to the 7.1-channel speaker connection.
Configuration	Manually manages speaker configuration, such as speaker size (sound production capacity), and bass audio processing.
Distance	Manually adjusts the output of each speaker based on distance to the listening position.
Level	Manually adjusts the volume of each speaker.
Parametric EQ	Selects an equalizer to adjust speaker output characteristics.
Test Tone	Generates test tones.

Power Amp Assign

In addition to the 7.1-channel speaker connection, various speaker configurations are possible using the presence speakers connection, bi-amp connection or Zone2 function (p. 17, p. 18).

7ch Normal	Enables the normal 7-channel speakers and front presence speakers (p. 14).
7ch + 1ZONE	Enables the normal 7-channel speakers and zone2 speakers (p. 16).
5ch BI-AMP	Enables the bi-amp connection (p. 16).

Configuration

Adjusts the output characteristics of the speakers based on manually set parameters.

In the "Configuration," you can select the speaker size characteristic (Large or Small). Select the size (sound reproduction capacity) that matches your speakers.

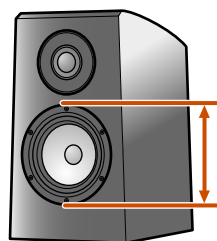

Woofer diameter

- 6-1/4 in (16 cm) or larger → Large
- 6-1/4 in (16 cm) or smaller → Small

When speaker size is set to "Small," low-frequency components of the speakers that you configured are produced from the subwoofer (or from the front speakers if there is no subwoofer).

Front

Selects the size (sound reproduction capacity) of the front speakers. 🌟1

Large	Select this for large speakers. The front speakers will produce all of the front channel frequency components.
Small (Default)	Select this for small speakers. The subwoofer will produce front channel low-frequency components. 🌟2

Center

Selects the size of the center speakers.

Large	Select this when a large center speaker is connected.
Small (Default)	Select this when a small center speaker is connected.
None	Select this when there is no center speaker. The front speakers will produce center channel audio.

Surround

Selects the size of the surround speakers.

Large	Select this when the surround speakers are large.
Small (Default)	Select this when the surround speakers are small.
None	Select this when no surround speakers are connected. The front speakers will produce surround channel audio signals.

- When set to "None," no sound is produced from the surround back speaker even if that speaker is connected.
- When set to "None," the sound programs will change to Virtual CINEMA DSP mode.

Surround Back

Selects the size of the surround back speakers.

Largex1	Select when one large surround back speaker is connected.
Largex2	Select when two large surround back speakers are connected.
Smallx1	Select when one small surround back speaker is connected.
Smallx2 (Default)	Select when two small surround back speakers are connected.
None	Select this when no surround back speakers are connected.

- When there are no surround speakers are connected, the setting will automatically change to "None."
- You can set surround back audio signals, including from the playback source, to be mixed down and produced from a single speaker (6.1-channel layout) or produced from left and right surround speakers (5.1-channel layout).

Front Presence

Specify connection of front presence speakers.

Use (Default)	Select this when front presence speakers are connected.
None	Select this when front presence speakers are not connected.

🌟 1: When "Subwoofer" is set to "None," you can only choose "Large." If the front speaker setting is "Small" and you change "Subwoofer" to "None," it will automatically change to "Large."

🌟 2: You can set the low-frequency components of audio signals transmitted from the front speakers to the subwoofer by using "Bass Cross Over."

Subwoofer

Confirms the subwoofer.

Use (Default)	Select this when subwoofer is connected. During playback, the subwoofer will produce audio from the LFE (low-frequency effect) channel and bass audio from other channels. 🗨️1
None	Select this when subwoofer is not connected. The front speakers will produce audio from the LFE (low-frequency effect) channel and bass frequency audio from other channels.

Phase

Sets the phase of the subwoofer if the bass audio is lacking or unclear.

Normal (Default)	Does not change the subwoofer phase.
Reverse	Reverses the subwoofer phase.

Extra Bass

Allows the front channel low-frequency components to be produced exclusively by the subwoofer, or by both the subwoofer and the front speakers.

Off (Default)	Depending on the size of the front speakers, either the front speakers or the subwoofer produce the front channel low-frequency components.
On	The subwoofer and the front speakers produce the front channel low-frequency components.

When “Subwoofer” is set to “None” or “Front” is set to “Small,” “Extra Bass” is disabled.

Bass Cross Over

Sets the lower limit of low-frequency component which is produced from speakers of which the size is set to “Small.” A frequency sound which is lower than the specified frequency will be produced from the subwoofer or the front speakers. 🗨️2

40Hz	110Hz
60Hz	120Hz
80Hz (Default)	160Hz
90Hz	200Hz
100Hz	

Distance

Adjusts the timing at which the speakers produce audio so that sounds from the speakers reach the listening position at the same time.

Selecting adjustment units

Use **[F1]Cursor Δ / ▽** to select the unit for distance (meters or feet), and press **[F1]ENTER**.

Setting distances for each speaker

Use **[F1]Cursor Δ / ▽** to select the speaker you want to configure, and press **[F1]ENTER**. Then use **[F1]Cursor < / >** to set the distance from the speaker to your listening position.

Adjustable range	1.0 ft to 80.0 ft (0.30 m to 24.0 m)
Default setting	10.0 ft (3.00 m)
Adjustment increments	0.2 ft (0.05 m)

Level

Separately adjusts the volume of each speaker.

Use **[F1]Cursor Δ / ▽** to select the desired speaker, and press **[F1]ENTER**. Then use **[F1]Cursor < / >** to adjust the volume for the selected speaker.

Adjustable range	-10.0 dB to +10.0 dB
Default setting	0.0 dB
Adjustment increments	0.5 dB

🗨️ 1 : Enabling “Extra Bass” allows both the subwoofer and the front speakers to produce bass audio.

🗨️ 2 : If your subwoofer has a volume control or a crossover frequency control, set the crossover frequency to maximum and the volume to half (or slightly less).

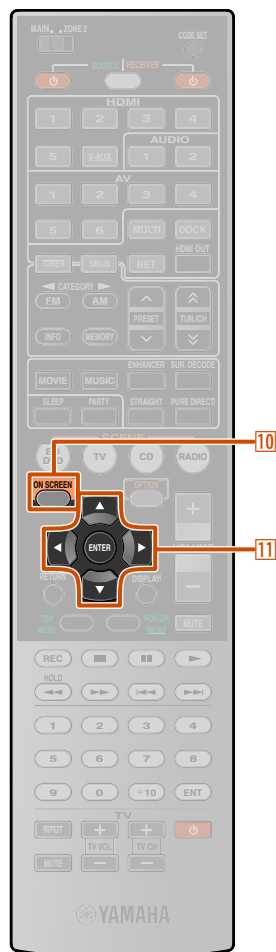

- 10** ON SCREEN
- 11** Cursor $\Delta / \nabla / \triangleleft / \triangleright$
- 11** ENTER

Parametric EQ

Adjusts sound quality of tone using a parametric equalizer.

PEQ Select

Select an equalizer type.

Manual	Manually adjust equalizer sound.
Flat	Adjust individual speakers to achieve the same characteristics. Select this option if speakers offer the same quality.
Front	Adjust individual speakers to achieve the same characteristics as the front left and right speakers. Select this option if front left and right speakers offer significantly greater quality than other speakers.
Natural	Adjust all speakers to achieve a natural sound. Select this if high-frequency sounds seem too strong when "PEQ Select" is set to "Flat."
Through (Default)	Disable the equalizer.

PEQ Data Copy

Select 1 of the 3 parametric equalizer types acquired with automatic setup and manually copy that information to the manual adjustments.

Flat > Manual	Copy the "Flat" parametric equalizer information acquired with automatic setup.
Front > Manual	Copy the "Front" parametric equalizer information acquired with automatic setup.
Natural > Manual	Copy the "Natural" parametric equalizer information acquired with automatic setup.

Front L / Front R / Center / Surround L / Surround R / Surround Back L / Surround Back R / Front Presence L / Front Presence R

The parametric equalizer can be used to manually adjust sound quality for individual speakers. Set "PEQ Select" to "Manual" and use "PEQ Data Copy" to copy information acquired with automatic setup. This information can be used as a basis for performing manual adjustments.

- 1** Use **11** Cursor Δ / ∇ repeatedly to select "Band / Gain," "Freq. / Gain," or "Q / Gain" and press **11** ENTER.
- 2** Use **11** Cursor $\triangleleft / \triangleright$ repeatedly to adjust the parameter and use **11** Cursor Δ / ∇ repeatedly to adjust the gain.
- 3** Press **11** ENTER to exit the edit window.
- 4** Repeat steps 1 to 3 to configure other parameters.

To reset all parameter settings for the selected speaker, select "Reset to Flat" and press **11** ENTER.

- 5** Press **10** ON SCREEN to close the menu.

Test Tone

Turns the test tone generator on or off.

Off (Default)	Does not generate test tones.
On	Generates test tones. While "On" is selected, test tones are produced constantly.

You can use the test tone in a variety of circumstances. For example, you can adjust the volume balance settings for each speaker, or whenever you adjust the settings on the internal parametric equalizer, you can listen to the actual effect while operating this unit. Turn the test tone off when you have finished making adjustments.

Setting the audio output function of this unit



Sound Setup items

Lipsync	Adjusts the delay between video and audio output.
Dynamic Range	Selects the dynamic range adjustment method for Dolby Digital and DTS playback.
Max Volume	Sets the maximum volume for this receiver.
Initial Volume	Sets the initial volume for when this receiver is turned on.
Adaptive DSP Level	Adjusts the level of DSP effect in conjunction with the volume level.

Synchronizing audio/video output

Lipsync

Adjusts the delay between audio and video output (Lipsync function).

Mode

Selects a compensation method for the delay between audio and video output.

Auto (Default)  1	When connecting to a TV via HDMI, automatically adjusts output timing if the TV supports an automatic lipsync function.
Manual	Manually adjusts the correction time. Select this when the monitor does not support the automatic lipsync function.

Delay

Adjustable range	0 ms to +250 ms
Default setting	0 ms
Adjustment increments	1 ms

Auto-adjusting Dolby Digital and DTS dynamic range

Dynamic Range

Selects the dynamic range adjustment method for audio bitstream (Dolby Digital and DTS) signal playback.

MAX (Default)	Produces audio without adjusting the dynamic range.
STD	Adjusts the dynamic range for optimum volume for regular home use.
MIN/AUTO	(MIN) Sets the dynamic range suitable for low volume or a quiet environment, such as at night, for bitstream signals except for Dolby TrueHD signals. (AUTO) Adjusts the dynamic range for Dolby TrueHD signals based on input signal information.

Setting the maximum volume

Max Volume

Specify the maximum volume level so that sound is not too loud. The default setting of +16.5 dB produces the highest volume.

Adjustable range	-30.0 dB to +16.5 dB (maximum volume)
Default setting	+16.5 dB
Adjustment increments	5.0 dB

 1: This setting is effective at the HDMI OUT jack selected by using **18** HDMI OUT.

Setting the startup volume

Initial Volume

Sets the initial volume for when this receiver is turned on. When this parameter is set to “Off,” the volume is set at the level when the receiver last entered standby mode. 1

Adjustable range	Off, Mute, -80 dB to +16.5 dB
Default setting	Off
Adjustment increments	0.5 dB

Adjusting DSP effect and volume level

Adaptive DSP Level

Automatically adjust the level of DSP effect in conjunction with the volume level.

Off	Disables automatic adjustment of the level of DSP effect.
On (Default)	Adjusts the degree of DSP effect in conjunction with volume level. The higher the volume level, the less the DSP effect applied. The lower the volume level, the greater the DSP effect applied.

Setting this unit's video output function

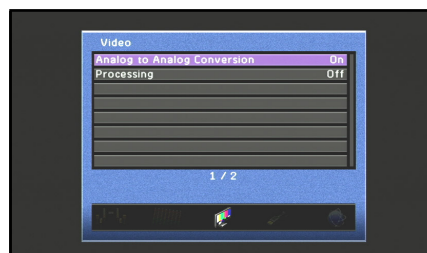

Video Setup items

Analog to Analog Conversion	Enable or disable video conversion between analog video jacks.
Processing	Enable or disable adjustment of resolution and aspect ratio for video signal converted to HDMI video.

Analog-to-analog video conversion

Analog to Analog Conversion

Enables or disables video conversion between analog video jacks.

Off	Disables video conversion between analog video jacks.
On (Default)	Enables video conversion between analog video jacks.

- Analog-to-HDMI video conversion is always possible unless video signals are being input at the HDMI input jacks or 1080p-resolution analog video signals are being input ([p. 136](#)).
- This unit does not convert 480 line video signals and 576 line video signals interchangeably.
- 480p-, 576p-, 1080i- and 720p-resolution video signals can not be output at the VIDEO MONITOR OUT jack ([p. 136](#)).
- The converted video signals are only output at the MONITOR OUT jacks.
- When composite video signals from a VCR are converted into component video signals, the picture quality may suffer depending on your VCR.
- Unconventional signals input at the composite video jacks cannot be converted or may be output abnormally. In such cases, set “Analog to Analog Conversion” to “Off.”

1 : When you set “Max Volume” at a lower level than “Initial Volume,” “Max Volume” has priority.

Adjusting resolution and aspect ratio with conversion of video signal to HDMI

Processing

Adjust resolution and aspect ratio with conversion of video input to HDMI video (upscaling).

Off (Default)	Resolution and aspect ratio are not adjusted with processing.
On	Resolution and aspect ratio are adjusted with processing.

Resolution

Auto (Default)	Automatic upscaling in accordance with TV resolution.
480p	Upscaling to 480p (576p).
720p	Upscaling to 720p.
1080i	Upscaling to 1080i.
1080p	Upscaling to 1080p.
Through	No upscaling.

- The 720p-, 1080i- and 1080p-resolution video signals cannot be upscaled (p. 136).
- When a TV is connected to this unit via the HDMI jack, this unit automatically detects a resolution that the TV supports. Only the detected resolution can be selected.
- If this unit cannot detect the resolution that the TV supports, set “MON.CHK” in the Advanced Setup menu to “SKIP” (p. 120) and try again.

Aspect

Through (Default)	The aspect ratio of HDMI video signal sources is not adjusted.
16:9 Normal	Transmits 4:3 aspect ratio video signals to a 16:9 TV with black bands on either side of the screen.

- The Aspect setting is automatically disabled when “Resolution” is set to “Through.”
- The Aspect setting is automatically disabled for video input with aspect ratios other than 4:3.
- Changing the aspect ratio of 720p, 1080i, or 1080p has no effect.

Setting HDMI functions



HDMI Setup items

HDMI Control	Turns the HDMI Control on or off.
Control Select	Choose an HDMI OUT jack on which HDMI Control function is enabled.
ARC (Audio Return Channel)	Turns the Audio Return Channel function on or off.
TV Audio Input	Chooses automatically selected audio input in conjunction with TV operation when the HDMI Control is turned on.
Audio Output	Specifies whether or not audio signal is output through this unit and a TV connected via the HDMI OUT 1-2 jacks.
Standby Through 	Turns the Standby Through function on or off.

 1 : This item appears depending on “HDMI Control!”

Receiver operation via TV (HDMI Control)

HDMI Control

Set the HDMI Control function to “On” to operate devices connected via HDMI. If the TV or other external components support HDMI Control (e.g., Panasonic VIERA Link), you can use the remote controls of those devices to operate some of this unit’s functions, and to synchronize this unit with the operation of those devices.

Refer to “Using the HDMI Control function” (p. 121) for setting instructions.

Off (Default)	Sets HDMI Control to “Off.”
On	Sets HDMI Control to “On.” 

If this unit is connected to HDMI devices that do not support the HDMI Control function, these functions will not operate.

Selecting an HDMI OUT jack for the HDMI Control function

Control Select

Select the HDMI OUT jack that utilizes the HDMI Control function.

Refer to “Using the HDMI Control function” (p. 121) for setting instructions.

OUT1(TV1)	Applies the HDMI Control function for the HDMI OUT 1 jack.
OUT2(TV2)	Applies the HDMI Control function for the HDMI OUT 2 jack.

Listening to TV audio via single HDMI cable (Audio Return Channel)

ARC (Audio Return Channel)

You can enable or disable the Audio Return Channel function. When using a TV that supports Audio Return Channel function and the function is enabled, the TV’s audio output is transmit to this unit via an HDMI cable.

The TV audio input to this unit is regarded as the input source selected in “TV Audio Input.” 
By means of this function, you do not need to connect the TV’s audio output (digital audio output or analog audio output) to the unit.

Off (Default)	Sets the Audio Return Channel to “Off.”
On	Sets the Audio Return Channel to “On.”

When the TV audio is input to the unit using Audio Return Channel, “TV” is displayed on the front panel display.



- “ARC (Audio Return Channel)” is enabled only for the HDMI OUT 1 or 2 jack selected with “Control Select.”
- Refer to “Single HDMI cable input to TV audio with Audio Return Channel function” (p. 123) for setting instructions.

Selecting an input source to assign audio input for the TV

TV Audio Input

Select the input source that receives audio signals from TV while the HDMI Control function is on.

When the TV is set to output sounds via this unit, the TV audio input is automatically selected to the input source assigned here. 

TV1

Audio input	AV1-6 or AUDIO1-2
Default setting	AV4

TV2

Audio input	AV1-6 or AUDIO1-2
Default setting	AV1

- “TV Audio Input” is enabled only for the HDMI OUT 1 or 2 jack selected with “Control Select.”
- Refer to “Switching the input source on this unit automatically when listening to TV audio” (p. 122) for instructions.

 1: When the HDMI Control is “On,” the Standby Through function is automatically enabled. When this unit enters standby mode, the audio and video signals from the last-selected HDMI input source will continue to be transmitted to the TV. The HDMI input source can only be changed using the remote control.

 2: While the Audio Return Channel function is on, the jack selected for the input source cannot be used.

Specify whether or not audio signal is output through this unit and a TV

Audio Output

Choose whether audio is played back through this unit or through a TV.

Amp

Specify whether or not audio signal is output through this unit.

Off	Audio is not output through this unit.
On (Default)	Audio is output through this unit. When this setting is selected, audio from the external component is output in a format compatible with this unit.

OUT1

Specify whether or not audio signal is output through a TV connected via the HDMI OUT 1 jack.

Off (Default)	Audio is not output through a TV connected via the HDMI OUT 1 jack.
On	Outputs audio through a TV connected via the HDMI OUT 1 jack. When this setting is selected, audio from the external component is output in a format compatible with the TV.

OUT2

Specify whether or not audio signal is output through a TV connected via the HDMI OUT 2 jack.

Off (Default)	Audio is not output through a TV connected via the HDMI OUT 2 jack.
On	Outputs audio through a TV connected via the HDMI OUT 2 jack. When this setting is selected, audio from the external component is output in a format compatible with the TV.

When "HDMI Control" is set to "On," the settings of "Amp" and the output jack (OUT1 or OUT2) selected with Control Select are interlocked with HDMI Control.

Transmitting HDMI audio/video to the TV during standby mode (Standby Through)

Standby Through

This function allows audio/video signals from HDMI inputs to continue to be transmitted to a TV when this unit is in standby mode.

When the Standby Through function is "On," audio/video signals continue to be output to the TV from the last HDMI input source before this unit enters standby mode. The HDMI input source can be selected using **[4]HDMI1-5** or **[4]V-AUX** in standby mode.

Off (Default)	Sets Standby Through to "Off."
On	Transmits audio/video signals from the selected HDMI input source to the TV.

- When "HDMI Control" is "On," Standby Through function is automatically enabled and "Standby Through" is not displayed.
- When the Standby Through function is on, the HDMI Through/iPod Charge indicator on the front panel lights during the standby mode. This unit consumes approximately 3 W of power.



Adjusting this unit's network parameters

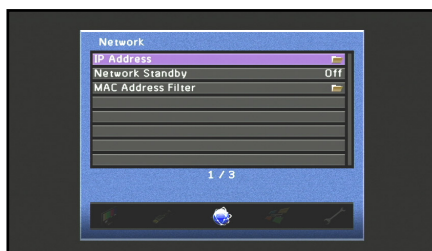

Network setup items

IP Address	Selects whether this unit acquires the network parameters (IP address, etc.) from the network's DHCP server automatically, or whether these parameters are specified manually.
Network Standby	Selects whether or not commands are accepted over the network when this unit is in standby mode.
MAC Address Filter	Sets the MAC address filter to restrict network access to this unit.

Setting the network parameters (IP address, etc.)

IP Address

Selects whether or not this unit automatically acquires network parameters (IP address, subnet mask, default gateway, primary DNS server and secondary DNS server) from a network device such as a router equipped with DHCP function.

DHCP

Off	Select this setting to specify IP address manually.
On (Default)	Select this setting to acquire IP address from the network's DHCP server automatically.

Manual Setup

IP Address	Specifies the IP address assigned to this unit. An IP address used by another device on the same network may not be used.
Subnet Mask	Specifies the subnet mask assigned to this unit.
Default Gateway	Specifies the IP address of the default gateway.
DNS Server (Primary)/DNS Server (Secondary)	Specifies the IP addresses of the primary and secondary Domain Name System (DNS) servers.

If you have only one DNS address, enter the DNS address in "DNS Server (Primary)." If the network has two or more DNS addresses, enter one of the addresses in "DNS Server (Primary)" and another in "DNS Server (Secondary)."

Turning this unit on by the command over the network when in the standby mode

Network Standby

Selects whether or not to turn this unit on by the command over the network when in the standby mode.

Off (Default)	Disables to turn this unit on by the command over the network.
On	Enables to turn this unit on by the command over the network.

When "Network Standby" is set to "On," this unit can be accessed from PC over a network during the standby mode with the power consumption of about only 5 W.

Setting the MAC Address Filter

MAC Address Filter

Sets MAC address filter to restrict access to this unit via LAN.

Mode

Off (Default)	Disables the MAC address filter function.
On	Permits access to this unit only from network devices with the specified MAC addresses.

Address Setup

Specifies the MAC addresses of network devices permitted to access to this unit when "MAC Address Filter" is set to "On."

Setting this unit's multi-zone function



Multi Zone Setup items

Zone2 Set	Adjusts Zone2 volume level.
Party Mode Set	Enable or disable the party mode function.
Zone Rename	Changes the name of each zone.

Adjusting Zone2 volume

Zone2 Set

Max Volume

Specify the maximum volume level in Zone2 so that sound is not too loud.

Adjustable range	-30.0 dB to +16.5 dB (maximum volume)
Default setting	+16.5 dB
Adjustment increments	5.0 dB

Initial Volume

Specify the initial volume level in Zone2 when this unit is turned on.

Adjustable range	Off, Mute, -80 dB to +16.5 dB
Default setting	Off
Adjustment increments	0.5 dB

Setting the party mode

Party Mode Set

In party mode, the main zone sources can be played in Zone2 simultaneously (see p. 126). Select "Zone2," and then select "Enable" or "Disable."

Enable (Default)	Enables the party mode function.
Disable	Disables the party mode function.

Changing Zone name

Zone Rename

Editing the name of the selected zone.

1 Use **Cursor** Δ / ∇ repeatedly to select "Zone Rename" and press **ENTER**.

2 Press **Cursor** Δ / ∇ to select a zone you want to rename and press **ENTER**.

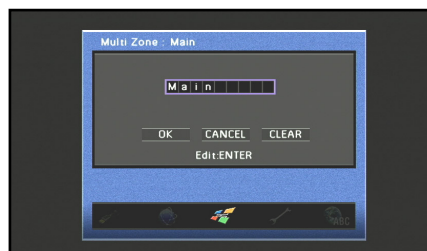

3 Press **ENTER**.
Editing the name is available.

4 Press **Cursor** Δ / ∇ to select a character and press **Cursor** \leftarrow / \rightarrow to enter the selected character.

5 Repeat step 4 to enter the desired zone name.

6 Confirm the zone name by pressing **ENTER**.

7 Press **Cursor** ∇ to select "OK" and press **ENTER** to register the new zone name.

- To cancel the operation without applying changes, select "CANCEL" and press **ENTER**.
- To clear the characters entered in step 4, select "CLEAR" and press **ENTER**.
- Zone names may consist of up to 9 characters.

Making the receiver easier to use



Function Setup items

Auto Power Down	This unit enters standby mode if no operations are performed.
Display Set	Specifies menu items displayed on TV screen and the front panel.
Trigger Output	Specifies TRIGGER OUT jack function.
Memory Guard	Protects some settings against accidental modification.

Goes enter standby mode automatically when you leave it without operating

Auto Power Down

If you do not operate this unit or use the remote control for an extended period of time, it will automatically go into standby mode (Auto Power Down function). This function's default setting is "Off." When you want to enable this function, set the amount of time to pass before this unit will enter standby.

4hours	Goes into standby mode, when you have not operated this unit for four hours.
8hours	Goes into standby mode, when you have not operated this unit for eight hours.
12hours	Goes into standby mode, when you have not operated this unit for twelve hours.
Off (Default)	Auto Power Down function is disabled.

This unit starts a countdown of 30 seconds before entering the standby mode. Pressing any key of the remote control during the countdown cancels entering the standby mode and reset the timer.

Specifying menu display

Display Set

Specify front panel display brightness and TV screen wall paper.

Front Panel Display

Specify front panel display brightness and message scroll pattern.

Dimmer	Adjustable range: -4 - 0 Reduce brightness of the front panel display. As the value is lowered, the panel display darkens.
Scroll	Selects the manner in which display scrolls when the total number of characters exceeds the display area on the front panel display. Select "Continue" for continuous scrolling of all characters. Select "Once" to scroll through all characters once and then halt scrolling for display of only the first 14 characters.

Wall Paper

Specify the wall paper displayed on the TV screen when no video signal is input. Select one that you prefer.

Picture 1-3	Displays an image on the TV screen when there is no video signal.
Gray	Displays a gray background on the TV screen when there is no video signal.



Setting TRIGGER OUT functions

Trigger Output

Sets the TRIGGER OUT jack to function synchronized with power status of each zone or input switching.

Trigger Mode

Specify the condition for the TRIGGER OUT jack to function.

Power (Default)	The TRIGGER OUT jack functions synchronized with the power status of the zone specified with "Target Zone."
Source	The TRIGGER OUT jack functions synchronized with the input switching in the zone specified with "Target Zone." Electronic signal is transmitted according to the setting made in "Target Source."
Manual	Select this to manually switch the output level for electronic signal transmission with "Manual."

Target Zone

Specify the zone with which the TRIGGER OUT jack functions synchronized.

Main (Default)	When "Trigger Mode" is set to "Power," electronic signal transmission is synchronized with power status of the main zone. When "Trigger Mode" is set to "Source," electronic signal transmission is synchronized with input switching in the main zone.
Zone2	When "Trigger Mode" is set to "Power," electronic signal transmission is synchronized with power status of Zone2. When "Trigger Mode" is set to "Source," electronic signal transmission is synchronized with input switching in Zone2.
All	When "Trigger Mode" is set to "Power," electronic signal transmission is synchronized with power status of the main zone or Zone2. When "Trigger Mode" is set to "Source," electronic signal transmission is synchronized with input switching in the main zone or Zone2.

Target Source

Specify the output level of the electronic signal transmitted with each input switching.

Low	Stops the electronic signal transmission when you switch to the input source specified in this option.
High (Default)	Transmits the electronic signal when you switch to the input source specified in this option.

This setting is available only when "Trigger Mode" is set to "Source."

Manual

Manually switch the output level for electronic signal transmission. This setting can also be used to confirm proper function of the external component connected via the TRIGGER OUT jack.

Low	Stops the electronic signal transmission.
High (Default)	Transmits the electronic signal.

This setting is available only when "Trigger Mode" is set to "Manual."

Prohibiting setting changes

Memory Guard

Prohibits setting changes to prevent careless changes being made to the settings on Setup menu.

Off (Default)	Settings are not protected.
On	Prohibits changes to the settings on Setup menu until it is returned to "Off." While set to "On," the unit displays "Memory Guard!" when an attempt is made to change the settings.

Language



Select the language used for display of menus and messages. 1
 Choices: English (English), 日本語 (Japanese), Français (French),
 Deutsch (German), Español (Spanish),
 Русский (Russian)

1 : Content window information is displayed in the language in which that information was released.

Confirming information of this unit (Information menu)

A variety of information for this unit can be displayed.

Selecting information

1 Press **[ON SCREEN]**.

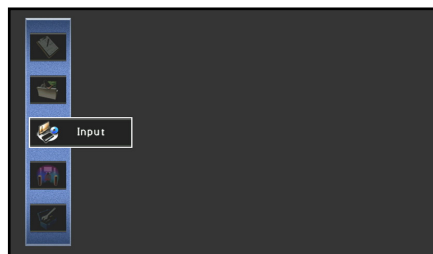

2 Use **[Cursor Δ / ▽]** to select "Information" and press **[ENTER]**.

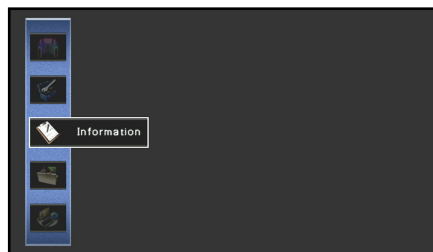

3 Use **[Cursor < / >]** to select an Information menu and press **[ENTER]**.



Audio information

Displays information on the current audio signal.

Format	Signal format. When this unit is unable to detect a digital signal, it automatically switches to analog input.
Sampling	The number of samples taken per second from a continuous signal to make a discrete signal.
Channel	The number of source channels in the input signal (front/surround/LFE). For example, a multi-channel soundtrack with 3 front channels, 2 surround channels and LFE is displayed as "3/2/0.1".
Bitrate	The number of bits passing a given point per second.
Dialogue	The dialogue normalization level preset to the current input bitstream signal.

- "—" is displayed when this unit cannot display the corresponding information.
- Some high-definition audio bitstream contents may not include the discrete surround back left and right channel signals, but are encoded at a bitrate of 192 kHz.
- Even when direct bitstream output settings are applied, some players convert the Dolby TrueHD or Dolby Digital Plus bitstreams to the Dolby Digital bitstreams, while converting DTS-HD Master Audio or DTS-HD High Resolution Audio bitstreams to DTS bitstreams.

Video information

Displays information on the current video signal.

HDMI signal	Source video signal type and video signal output to this unit's HDMI OUT 1-2 jacks.
HDMI Resolution	Input signal (analog or HDMI) and output signal (HDMI) resolution.
Analog Resolution	Resolution of the source video signal and the analog video signal output to this unit's COMPONENT MONITOR OUT jacks.
HDMI Error	Error message for HDMI sources or connected HDMI devices (p. 127).

HDMI monitor

Displays information on the TV screen connected to this unit's HDMI OUT 1-2 jacks.

Interface	Displays information on the current connection interface.
Video Resolution	Displays the frequency for each video resolution of the TV currently connected.

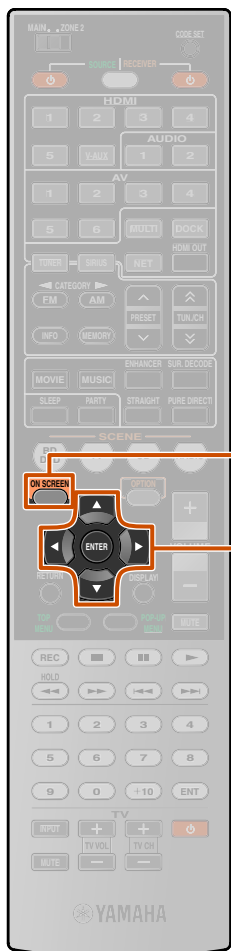

10 ON SCREEN

11 Cursor Δ / ▽ / < / >

11 ENTER

Network information

Displays information on the network status. Refer to “Adjusting this unit’s network parameters” ([p. 108](#)) for details on setting the network status.

IP Address / Subnet Mask / Default Gateway	Displays the status of the current IP address assigned to this unit.
DNS Server (P) / DNS Server (S)	Displays the IP address of the primary and secondary DNS (Domain Name System) servers.
MAC Address	Displays the MAC address filter set to this unit.
Status	Displays the network status of this unit.

System information

Displays information on the current settings of the advanced setup.

Remote ID	Displays the Remote ID set to this unit.
TV Format	Displays the TV format set to this unit.
Speaker Impedance	Displays the speaker impedance set to this unit.
System ID	Displays the system ID of this unit.
Firmware Version	Displays the current version of the firmware installed to this unit.

When detecting the latest firmware over a network:

- exclamation point appears on the Information menu icon
- message indicating that the latest firmware is released appears in the System information

In this case, update the latest firmware by using “NETWORK” of “FIRM UPDATE” in Advanced Setup menu.

Zone information

Displays information on the currently selected input and the volume of Zone2.

Controlling other components with the remote control

You can operate an external component such as TV and DVD player with the remote control of this unit by setting the code for external component (remote control code). The remote control code can be set for each input source. Individual setting allows you to switch external components seamlessly depending on the selected input source.

Selecting input source connected to DVD player

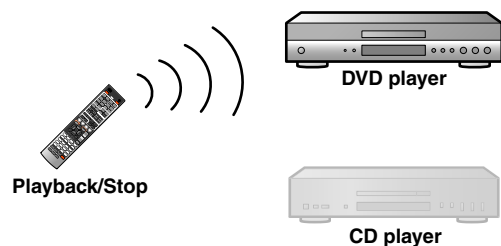

Selecting input source connected to CD player

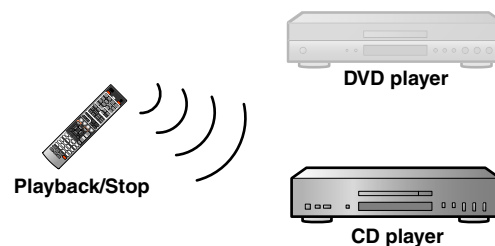

If you are unable to operate this unit after operating an external component, light up **16** SOURCE/RECEIVER in orange by pressing it, and then try operating the remote control again.

Keys connecting external components

The remote control keys for controlling external components are available only when the external components have corresponding control keys.

3 SOURCE

Switches an external component on and off.

11 Cursor, 11 ENTER, 11 RETURN

Operates the menus of external components.

12 DISPLAY

Switches an external component display.

12 External component operation keys

Functions as a recording or playback key of an external component, or a menu display key.

13 Numeric keys

Functions as numeric keys of an external component.

14 TV control keys

14 INPUT	Switches video inputs of TV.
14 MUTE	Mutes TV volume temporarily.
14 TV VOL +/-	Controls the volume of TV.
14 TV CH +/-	Switches TV channels.
14	Turns on and off TV.

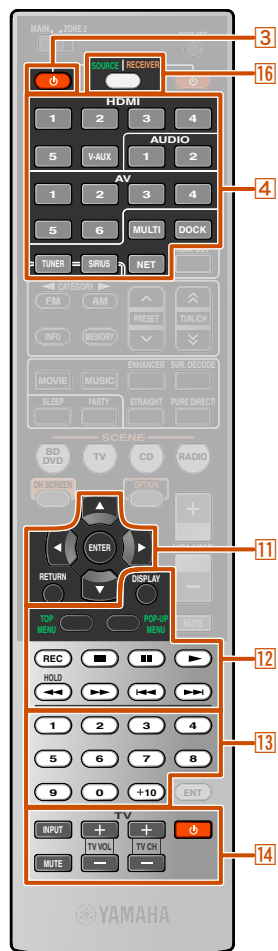

- 3 SOURCE
- 4 Input selector
- 11 Cursor
- 11 ENTER
- 11 RETURN
- 12 External component operation keys
- 12 DISPLAY
- 13 Numeric keys
- 14 TV control keys
- 14 INPUT
- 14 MUTE
- 14 TV VOL +/-
- 14 TV CH +/-
- 14
- 16 SOURCE/RECEIVER

- 1: When remote control codes for external components are registered with **4** Input selector or **14** (**14** TV control keys), the following operations are possible.
- When a TV remote control code is registered with **4** Input selector, the **11** Cursor, **13** Numeric keys and **14** TV control keys can be used to control the TV selected with

4 Input selector.

- When a remote control code for a device other than a TV is registered with **4** Input selector, keys including the **11** Cursor and **13** Numeric keys can be used to control external components, and the **14** TV control keys can be used to control the TV registered with **14** .

- When a TV remote control code is registered with **14** , only **14** TV control keys can be used to control the TV.



- 4 HDMI2
- 14 TV control keys
- 14 (TV control keys)
- 15 CODE SET

Default remote control code settings

The following remote control codes are assigned to input sources as factory default settings. For a complete list of available remote control codes, refer to “[Remote Control Code Search](#)” in the CD-ROM.

Input	Category	Manufacturer	Remote control code
HDMI1	Blu-ray player/recorder	Yamaha	2064
HDMI2	—	—	—
HDMI3	—	—	—
HDMI4	—	—	—
HDMI5	—	—	—
AV1	—	—	—
AV2	—	—	—
AV3	CD player	Yamaha	5095
AV4	—	—	—
AV5	—	—	—
AV6	—	—	—
AUDIO1	—	—	—
AUDIO2	—	—	—
NET	—	—	—
V-AUX	—	—	—
DOCK	—	—	—
TUNER	—	—	—
SIRIUS	—	—	—

Registering remote control codes for external component operations

The following section describes how to register remote control code using an example of the registration of the remote control codes of a Yamaha BD player connected to HDMI2 jack.

- Perform each of the following steps within 1 minute. Settings will be automatically stopped if more than 1 minute passes since the last operation. To reset, repeat from step 2.
- Remote control code of an external component cannot be set from the name or model number of a unit. Use “[Remote Control Code Search](#)” in the CD-ROM to search the available remote control codes from the category or manufacturer of external components.
- If multiple remote control codes exist, first set the first code in the list, if it does not work then try the other codes.

- 1 Use “[Remote Control Code Search](#)” in the CD-ROM to search the available remote control codes from the category or manufacturer of external components.

“2064” can be used for a Yamaha BD player.

- 2 Press 15 **CODE SET** using a pointed object such as the tip of a ballpoint pen.

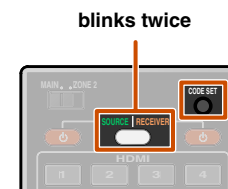

- 3 Press 4 **HDMI2** to switch the input source to HDMI2. 1

Perform the following steps to register the selected input source here to the remote control code.

Continues to the next page

1 : When you want to register a remote control code to the 14 TV control keys, press 14 (14 TV control keys) in step 3.



- 4 HDMl2
- 9 SCENE
- 13 Numeric keys
- 15 CODE SET
- 16 SOURCE/RECEIVER

4 Enter a remote control code “2064” using 13 Numeric keys. 1



Once the remote control code is registered successfully 16 SOURCE/RECEIVER will blink twice.

Registration successful: blinks twice
Registration failed: blinks 6 times

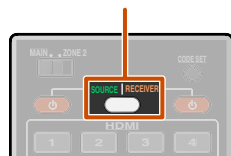

- If the registration fails, repeat from step 2.
- In case of an external component with multiple remote control codes, the other remote control codes may be supported. Repeat from step 2 with the other remote control codes.

5 To switch between BD player linked to scene selections, press 9 SCENE and at the same time press 4 HDMl2 and hold it for approximately 3 seconds.

Then you can operate the external components by switching the input source to HDMl2, or selecting HDMl2 in the registered scene.

Same steps for operating other external components, press 9 SCENE and at the same time press the input source key selected in step 3 and hold it for approximately 3 seconds.

Resetting all remote control codes

Resetting all remote control codes for external components to the initial factory settings.

Perform each of the following steps within 1 minute. Settings will be automatically stopped if more than 1 minute passes since the last operation. To reset, repeat from step 1.

1 Press 15 CODE SET using a pointed object such as the tip of a ballpoint pen.

blinks twice

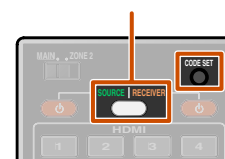

2 Press 16 SOURCE/RECEIVER on the remote control.

3 Enter “9981” using 13 Numeric keys.



Once the remote control code is reset successfully 16 SOURCE/RECEIVER will blink twice.

Reset successful: blinks twice
Reset failed: blinks 6 times

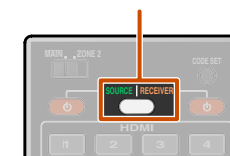

If setup fails, repeat from step 1.

1 : When you want to register a remote control code to the 14 TV control keys, enter the TV remote control code in step 4.

Extended functionality that can be configured as needed (Advanced Setup menu)

The Advanced Setup menu can be used for unit initialization and other useful extended functions. The Advanced Setup menu can be operated as follows.

Displaying/Setting the Advanced Setup menu

1 Switch this unit to the standby mode.

2 Press **MAIN ZONE** ϕ while pressing and holding **STRAIGHT** on the front panel.

Release **STRAIGHT** when “ADVANCED SETUP” is displayed on the front panel display.

After a few seconds, the top menu items are displayed.

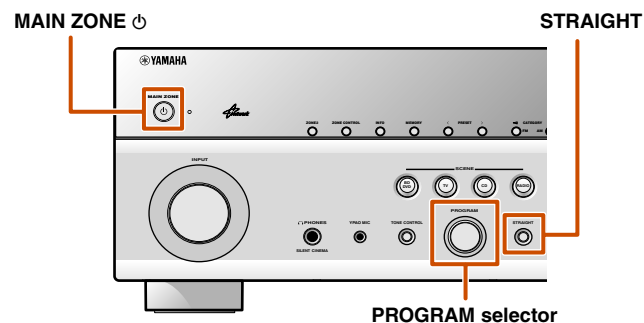

3 Rotate **PROGRAM** selector to select the item to be set from the following items.

In the Advanced Setup menu, you can set the following settings.

SP IMP.	Sets the impedance of speakers.
REMOTE ID	Changes the remote control ID of a receiver.
SR PIN	Resets the parental lock code for the SIRIUS Satellite Radio tuner.
TV FORMAT	Specifies the TV's color encoding format.
MON. CHK	Removes the up-scaling limitation on HDMI video output.
INIT	Initializes various settings for this unit.
FIRM UPDATE	Update the firmware of this unit.
VERSION	Check the version of firmware currently installed on this unit.

4 Press **STRAIGHT** repeatedly to select the value you want to change.

5 Switch this unit to the standby mode, and then switch it on again.

The settings become effective and the unit is powered on.

Setting the impedance of speakers



Changes the unit settings depending on the impedance of the speakers connected. \mathcal{L} 1

6ΩMIN	Select the impedance when 6 Ω speakers are connected.
8ΩMIN (Default)	Select the impedance when speakers above 8 Ω are connected.

\mathcal{L} 1: For detailed procedures of speaker impedance settings, refer to “Changing speaker impedance” ([see p. 18](#)).



- 13 Numeric keys
- 15 CODE SET
- 16 SOURCE/RECEIVER

Avoiding crossing remote control signals when using multiple Yamaha receivers



The remote control of the unit can only receive signals from a receiver which has an identical ID (remote control ID). When using multiple Yamaha AV receivers, you can set each remote control with a unique remote control ID for its corresponding receiver. On the contrary, if you are setting the same remote control ID for all receivers, you can use one remote control to operate 2 receivers.

ID1 (Default)	Receives the remote control signals set in ID1.
ID2	Receives the remote control signals set in ID2.

ID1 is set for both remote control and receiver by default. To avoid crossing remote control, change the remote control ID for both remote control and receiver.

■ To change the remote control ID

Perform each of the following steps within 1 minute. Settings will be automatically stopped if more than 1 minute passes since the last operation. To reset, repeat from step 1.

- 1 Press **15**CODE SET using a pointed object such as the tip of a ballpoint pen.
- 2 Press **16**SOURCE/RECEIVER.
- 3 Enter the desired remote control ID code.

To switch to ID1:

Enter "5019" using **13**Numeric keys.

To switch to ID2:

Enter "5020" using **13**Numeric keys.

Once the remote control code is registered successfully **16**SOURCE/RECEIVER will blink twice.

Registration successful: blinks twice
Registration failed: blinks 6 times

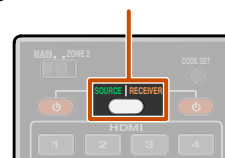

- If setup fails, repeat from step 1.
- Returns to ID1 after the remote control code is initialized ([step. 117](#)).

Resetting the SIRIUS Satellite Radio™ parental lock code



Reset the SIRIUS Satellite Radio parental lock code to the factory default setting. If you forget the code, it can be reset.

RESET	Resets the code to the factory default setting.
CANCEL (Default)	Cancels resetting of the parental lock code.

Changing TV format



Change the color encoding format of OSD to PAL or NTSC (default), to match the format used by the TV connected via the HDMI OUT 1-2 or VIDEO (MONITOR OUT) jack.

Removing HDMI video output up-scaling limits



Removes the up-scaling limitation on video resolution when this unit and a TV are connected via HDMI jacks. If a resolution supported by the monitor cannot be detected when configuring the up-scaling settings, this setting will remove the output limitation.

YES (Default)	Video output signals of a resolution not supported by the TV will not be transmitted.
SKIP	This unit ignores the TV's support capability and transmits input video signals to the TV.

Initializing various settings for this unit



Initializes various settings stored in this unit and sets it back to default.

Select the items to be initialized from the following.

DSP PARAM	Initializes all parameters for the sound programs.
VIDEO	Resets video conversion settings (resolution/aspect ratio) in the Setup menu.
NETWORK	Resets the settings of network such as IP address or the account of vTuner.
ALL	Resets this unit to default factory settings.
CANCEL (Default)	Does not initialize.

When an option other than CANCEL is selected, the applicable default settings will be restored when the unit switches to standby mode.

Firmware update



Update the firmware of this unit. For details on updating the firmware, refer to information supplied with updates.

When this unit detects the latest firmware over a network, the message indicating that the firmware is released is displayed in the System information ([p. 114](#)).

1 Press STRAIGHT repeatedly to select "NETWORK."

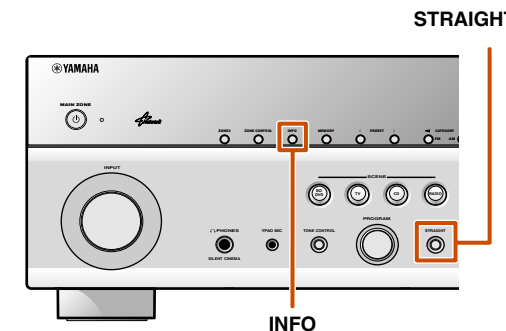

NETWORK	Updates the firmware of this unit via network.
---------	--

2 Press INFO to start update with the selected option.

- Do not use this feature unless the firmware must be updated.
- Be sure to read the information supplied with updates before updating firmware.

Firmware version



Check the version of firmware currently installed on this unit.

About the latest firmware

When installing the latest firmware, the new functions or fix of failure may be served.

- The latest firmware can be downloaded from our website.
- While displaying the ON SCREEN menu or "System" from Information menu, the information on the latest firmware is displayed via a network.

Using the HDMI Control function

This unit supports the HDMI Control function, which allows you to operate external components via HDMI. If devices that support HDMI Control (e.g., Panasonic VIERA Link-compatible TVs, DVD/Blu-ray Disc players, etc.) are connected 1, remote controls for those devices can be used to perform the following operations:

- Power synchronization (on/standby)
- Volume control, including Mute
- Changing the volume of the audio output signal device (either the TV or this unit)

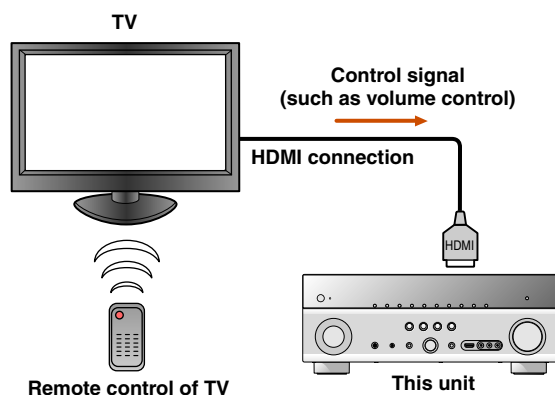

NOTE

The following is an example of how to connect this unit, a TV, and a BD/DVD player. Follow the instructions in your TV and BD/DVD player manuals, as well as the ones written below.

- Set the TV's HDMI Control function to "On"
- Follow the AV amplifier connection instructions, and connect this unit to the TV

1 Connect the TV that supports the HDMI Control function to this unit's HDMI output jack.

2 Connect the BD/DVD player that supports the HDMI Control function to this unit's HDMI input jack.

3 Turn on the TV and this unit.

Refer to the TV's instruction manual on how to operate external components.

4 Set the TV and this unit's HDMI Control function to "On."

This unit	Confirm that "HDMI Control" is set to "On" (e.g., p. 106) and select the HDMI OUT jack connected to the TV in "Control Select" (e.g., p. 106).  2
TV and BD/DVD player	Check the instruction manuals for those devices.

5 Turn the TV off.

Other synchronized HDMI Control devices are turned off with the TV. If they are not synchronized, turn them off manually.

6 Turn the TV on.

Confirm that this unit has turned on in conjunction with the TV. If it is still off, turn it on manually.

7 Change the TV's input setting to the input jack that is connected to this unit (e.g., HDMI1).

8 If BD/DVD player that supports the HDMI Control function are connected to this unit, turn them on.

This unit	Confirm that the input source for the BD/DVD players has been selected. If a different input source has been selected, change it manually.
TV and BD/DVD player	Confirm that the video signal from the player is being properly received by the TV.

Operations 1-8 will not be required more than twice.

9 Confirm that this unit is properly synchronized with the TV through the following operations by using the TV remote control.

- Power On/Off
- Volume Control
- Switching between audio output devices

If this unit is not synchronized to the TV's power operations, check that the HDMI Control function is set to "On" for both devices. If they will not properly synchronize, unplugging and re-plugging the devices and turning them on and off may solve the problem.

 1: We recommend that you use TVs and BD/DVD players from the same manufacturer whenever possible.

 2: The default setting for the HDMI Control function is "Off."

Switching the input source on this unit automatically when listening to TV audio

When the HDMI Control (see p. 121) is operating properly, the input source of this unit is automatically changed to match operations carried out on the TV. When the TV is connected with HDMI OUT 1, the default input jack is AV4. If the AV4 optical digital jack is connected to the TV's audio output jack, then you can enjoy TV sound through this unit right away.

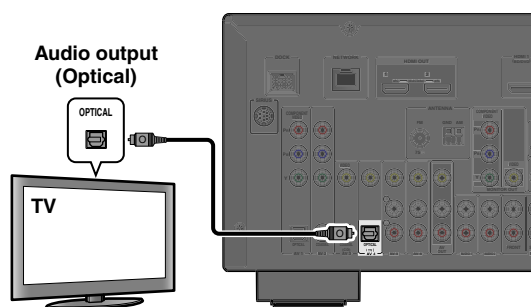

When the TV is connected with HDMI OUT 2, the default input jack is AV1. If the AV1 optical digital jack is connected to the TV's audio output jack, then you can enjoy TV sound through this unit right away.

To use other jacks to input audio signals from TV, carry out the following procedure.

1 Connect this unit and the TV with an HDMI cable.

2 Connect TV's audio output to this unit. The input jacks listed below are available to input TV's audio signals. Use the same jack type as used for the TV.

TV output jack	Input jack
Optical digital audio output	AV1 or AV4 (Default)
Coaxial digital audio output	AV2 or AV3
Analog stereo output	AV5, AV6, AUDIO1, or AUDIO2

Available input jacks

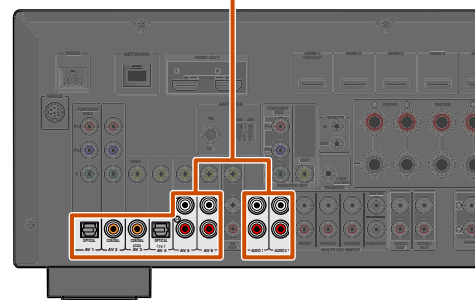

3 Press **ON SCREEN**.  1

4 Press **Cursor** Δ / ∇ repeatedly to select "Setup" and press **ENTER**.

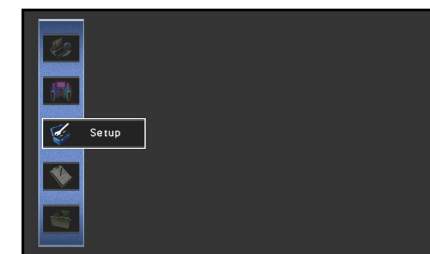

5 Press **Cursor** \leftarrow / \rightarrow repeatedly to select "HDMI" and press **ENTER**.



Continues to the next page 

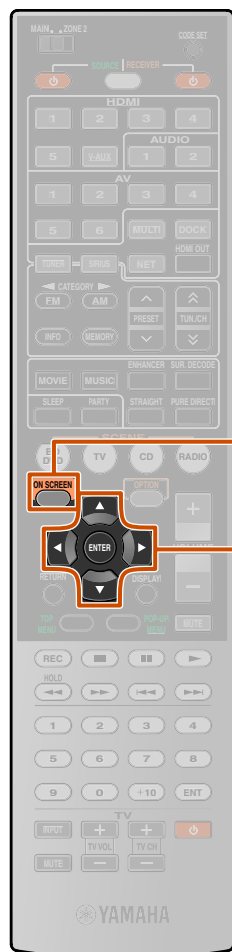

ON SCREEN

Cursor Δ / ∇ / \leftarrow / \rightarrow

ENTER

 1: Refer to the "Setting various functions (Setup menu)" (see p. 98) for details on the Setup menu.



- 10** ON SCREEN
- 11** Cursor $\Delta / \nabla / \triangleleft / \triangleright$
- 11** ENTER

- 6** Make sure that “HDMI Control” is “On”
When “HDMI Control” is set to “Off,” press **11**ENTER and **11**Cursor Δ / ∇ to set to “On.”
- 7** Press **11**Cursor ∇ to select “Control Select” and press **11**ENTER.
- 8** Use **11**Cursor Δ / ∇ to select the HDMI OUT jack connected to the TV.
- 9** Press **11**Cursor ∇ to select “TV Audio Input” and press **11**ENTER.
- 10** Use **11**Cursor Δ / ∇ to select the input jack connected in step 2.
- 11** Press **10**ON SCREEN when you have finished changing the settings.

If the TV hereafter transmits audio output signals, this unit will automatically switch to the input source chosen in step 10.

Single HDMI cable input to TV audio with Audio Return Channel function

When using a TV that supports HDMI functions and Audio Return Channel function, audio/video output from this unit to the TV or audio output from the TV to this unit can be transmitted through a single HDMI cable (Audio Return Channel function). Audio signals transmitted from the TV to this unit can be assigned to any input source.

- 1** Connect this unit and the TV with an HDMI cable.

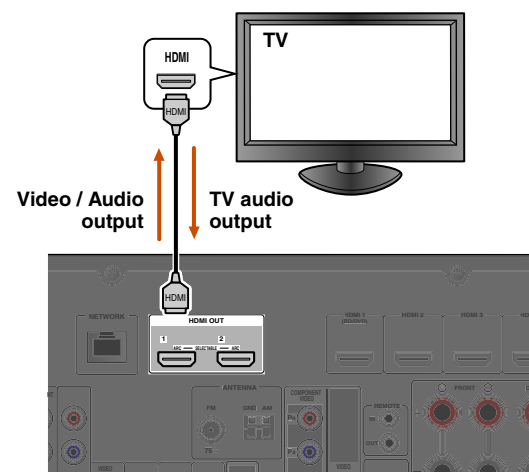

- 2** Press **10**ON SCREEN. **1**

- 3** Press **11**Cursor Δ / ∇ repeatedly to select “Setup” and press **11**ENTER.

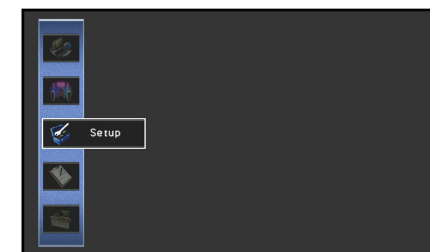

- 4** Press **11**Cursor $\triangleleft / \triangleright$ repeatedly to select “HDMI” and press **11**ENTER.



Continues to the next page

1 : Refer to the “Setting various functions (Setup menu)” ([p. 98](#)) for details on the Setup menu.

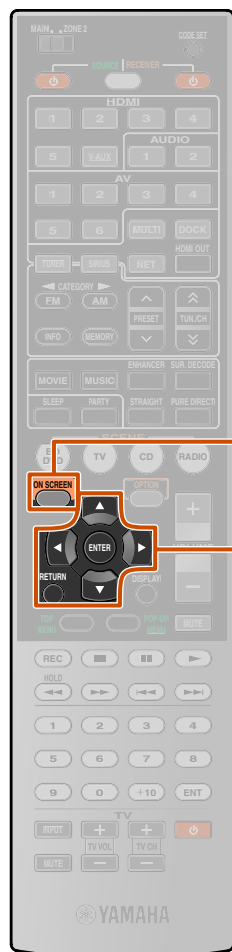

- 10 ON SCREEN**
- 11 Cursor Δ / ∇**
- 11 ENTER**
- 11 RETURN**

- 5 Make sure that “HDMI Control” is “On.”**
When “HDMI Control” is set to “Off,” press **11 ENTER** and **11 Cursor Δ / ∇** to set to “On.”
- 6 Press **11 Cursor ∇** to select “Control Select” and press **11 ENTER**.**
- 7 Use **11 Cursor Δ / ∇** to select the HDMI OUT jack connected to the TV.**
- 8 Press **11 Cursor ∇** to select “TV Audio Input” and press **11 ENTER**.**
- 9 Use **11 Cursor Δ / ∇** to select the input source to which the HDMI audio signals will be assigned, and press **11 RETURN**.**
- 10 Press **11 Cursor ∇** to select “ARC (Audio Return Channel)” and press **11 ENTER**.  1**
- 11 Press **11 Cursor ∇** to select “On.”**
The Audio Return Channel function will turn on.
- 12 Press **10 ON SCREEN** to close the Setup menu.**

If the TV hereafter transmits audio output signals, this unit will automatically switch to the input source chosen in step 9.

 1 : While the Audio Return Channel function is on, the jack selected for the input source cannot be used.

Using multi-zone configuration

This unit allows you to configure a multi-zone audio system. The Zone2 feature allows you to set this unit to reproduce separate input sources in the main zone and the second zone (Zone2). You can control this unit from the second zone using the supplied remote control.

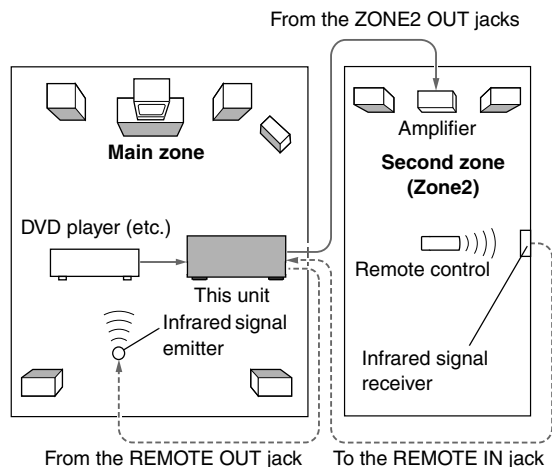

Only analog signal can be sent to Zone2. If you want to output sound from Zone2, connect an external component to AV5-6, AUDIO1-2, or VIDEO AUX by analog connection. For example, if you want to output sound from an HDMI DVD player in Zone2, you must connect the component to this unit by both HDMI and analog connections.

Connecting Zone2

You need the following additional equipment to use the multi-zone functions of this unit:

- An infrared signal receiver in the second zone.
- An infrared signal emitter in the main zone. This emitter transmits infrared signals from the remote control to a CD player or a DVD player, etc. in the main zone via the infrared signal receiver in the second zone.
- An amplifier and speakers in the second zone.

Since there are many possible ways to connect and use this unit in a multi-zone configuration, we recommend that you consult with your nearest authorized Yamaha dealer or service center about the Zone2 connections that best meet your requirements.

Using the external amplifier

An amplifier located in the secondary zone can be connected to this unit as shown below.

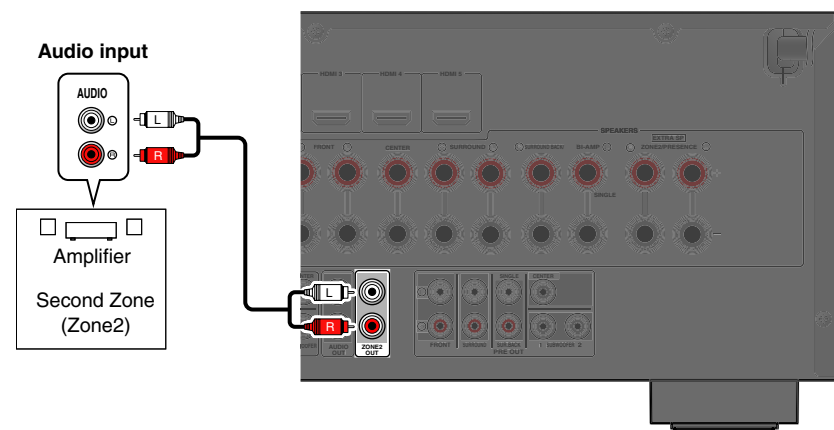

To avoid unexpected noise, DO NOT USE the Zone2 feature with CDs encoded in DTS.

Using the internal amplifier of this unit

Connect the speakers in the second zone to the EXTRA SP jacks directly ([p. 18](#)).

Using REMOTE IN/OUT jacks for multi-zone components

This unit is equipped with REMOTE IN and REMOTE OUT jacks. You can use these jacks to control this unit and other components from Zone2 ([p. 30](#)).

Some Yamaha models can be directly connected to the REMOTE jacks of this unit. These models may not require an infrared signal emitter. Up to 6 Yamaha components can be connected as shown below.

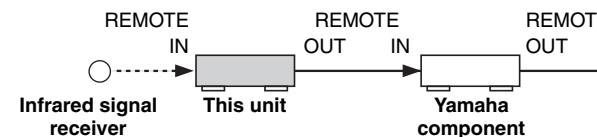

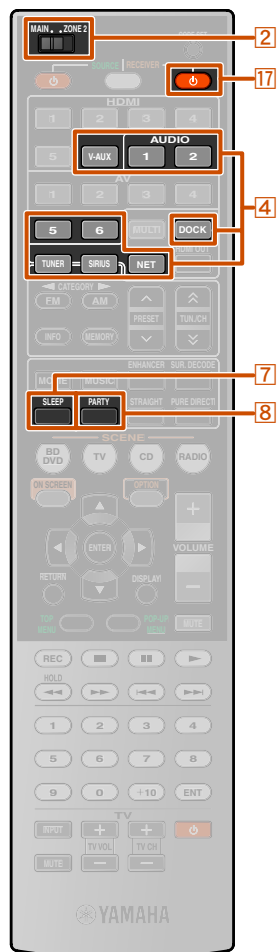

- 2 MAIN/ZONE2
- 4 Input selector
- 7 SLEEP
- 8 PARTY
- 17 RECEIVER

Controlling Zone2

The remote control can be used to select and control Zone2 devices. The available operations are as follows:

- Selecting the input source of Zone2.
- Tuning into FM or AM when “TUNER” is selected as the input source of Zone2.
- Tuning into SIRIUS Satellite Radio when “SIRIUS” is selected as the input source of Zone2.
- Adjust the volume of Zone2 devices (when connected via the built-in amplifier).

Activating the Zone2 operation mode

Set **2** MAIN/ZONE2 to ZONE2 before attempting to use the remote control to control Zone2 devices.

Operating Zone2

To enable and disable the audio output to Zone2

Press **17** RECEIVER .

To select an input source for Zone2

Press **4** Input selector.

Only the following sources are available for the Zone2.
 V-AUX (only analog audio input), AUDIO1-2 (only analog audio input), NET, DOCK, TUNER

To enable the sleep timer for Zone2

Automatically switch the Zone2 device to standby mode after a specified period of time has elapsed (sleep timer). Press **7** SLEEP repeatedly to specify a time for the sleep timer function.



Using the party mode

Use this feature to play main zone sources in Zone2 simultaneously. This feature is useful when you want to play back main sources as background music in a home party, etc. When using the party mode, set “Party Mode Set” to “Enable” ([p. 109](#)).

Press 8 PARTY to turn on or off the party mode.

“PARTY MODE ON” or “PARTY MODE OFF” appears on the front panel display or the TV screen. While this unit is in the party mode, the ZONE2 indicators turn on in the front panel display.

Input audio signals are mixed down to 2ch Stereo and output at the analog ZONE2 OUT jacks.

APPENDIX

Troubleshooting

Refer to the table below when this unit does not function properly.

If the problem you are experiencing is not listed below, or if the instructions below do not help, turn off this unit, disconnect the power cable, and contact the nearest authorized Yamaha dealer or service center.

General

Problem	Cause	Remedy	See page
The power will not turn on.	The protection circuitry operated 3 times consecutively.	As a safety precaution, when the protection circuitry operates 3 times consecutively, the capability to turn on the power is disabled. Contact your nearest Yamaha dealer or service center to request repair.	—
The unit enters standby mode soon after the power is turned on.	The power cable is not completely inserted.	Connect the power cable properly to an AC wall outlet.	—
	(When this unit is turned back on and “CHECK SP WIRES!” is displayed.) The protection circuitry has been activated because this unit was turned on while a speaker cable was shorted.	Make sure that all speaker cables between this unit and speakers are connected properly.	19
This unit cannot be turned off or does not work properly.	The internal microcomputer is hung-up due to an external electric shock (such as lightning or excessive static electricity) or by a drop in power supply voltage.	Disconnect the power cable from the AC wall outlet, wait about 30 seconds and then plug it in again.	—
	The batteries in the remote control may have lost their charge.	Replace all batteries.	7
The unit enters standby mode.	The protection circuitry has been activated because of a short circuit, etc.	Check that the speaker with an impedance of at least 6 Ω.	—
		Check that the speaker impedance settings are correct.	18
		Check that the speaker wires are not touching each other, then turn the unit back on.	—
	The sleep timer has turned off the unit.	Turn on the unit, and play the source again.	—

Problem	Cause	Remedy	See page
After display of a countdown on the front panel, the unit goes into standby mode.	If you do not use take any action, the Auto Power Down function operates.	Turn on the unit, and play the source again.	—
		In the Setup menu “Auto Power Down” (“Function” → “Auto Power Down”), increase the time until switching to standby mode, or turn off the Auto Power Down function.	110
No sound.	Incorrect input or output cable connections.	Connect the cables properly. If the problem persists, the cables may be defective.	25
	Speaker connections are not secure.	Secure the connections.	19
	The HDMI components connected to the unit do not support the HDCP copy protection standards.	Connect HDMI components that support the HDCP copy protection standards.	—
	The audio input into the device is set to playback through the TV.	In the Setup menu, set the “Amp” of “Audio Output” (“HDMI” → “Audio Output” → “Amp”) to “On.”	107
	No appropriate input source has been selected.	Select an appropriate input source with Input selector .	42
	The volume is turned down or muted.	Turn up the volume.	—
	Signals that this unit cannot reproduce are being input from a source component, such as a CD-ROM.	Use an input source that has signals that can be reproduced on this unit.	—



Problem	Cause	Remedy	See page
No picture.	The video signal output from this unit is not supported by a monitor connected to this unit via the HDMI OUT 1-2 jacks.	Displays the Advanced Setup menu and select "VIDEO" in "INIT" to reset the video parameters.	120
		Displays the Advanced Setup menu and set "MON.CHK" to "YES."	120
	An appropriate video input is not selected on the TV.	Select an appropriate video input on the TV.	—
No sound is output from a specific speaker.	The speaker is malfunctioning. Check the Speaker indicators on the front panel display. If the corresponding indicator lights up, connect another speaker and check if sound is output.	If sound is not output, the unit may be malfunctioning.	10
	The playback component or speakers are not connected properly.	Connect the cables properly. If the problem persists, the cables may be defective.	19, 25
	Output from that speaker is disabled.	Check the Speaker indicators on the front panel display. If the corresponding indicator is turned off, try the following. 1) Change to a different input source. 2) With the selected sound program, sound is not output from that speaker. Select another sound program. 3) "None" may have been selected for that speaker on this unit. Display "Speaker" in the Setup menu, and set respective parameters to enable output from that speaker ("Speaker" → "Manual Setup" → "Configuration").	10, 99
	The volume of that speaker is set to the minimum in "Speaker" in the Setup menu.	Display "Speaker" in the Setup menu and adjust the volume ("Speaker" → "Manual Setup" → "Level").	101
	(If hardly any sound comes from one channel) Speaker output balance is not set correctly.	Balance the volume of each speaker from "Level" in the Setup menu ("Speaker" → "Manual Setup" → "Level").	101
	Sound may not be output from certain channels, depending on the input source or sound program.	Try another sound program.	44

Problem	Cause	Remedy	See page
Only the center speaker outputs substantial sound.	When a monaural source sound program is applied, for some surround decoders, sound from all channels is output from the center speaker.	Try another sound program.	44
No sound is heard from the presence speakers.	This unit is in straight decoding mode and a monaural source is being played back.	Press STRAIGHT to exit straight decoding mode.	45
	Sound may not be output from certain channels depending on input sources or sound programs.	Try another sound program.	44
No sound is heard from the surround speakers.	This unit is in straight decoding mode and a monaural source is being played back.	Press STRAIGHT to exit straight decoding mode.	45
	Sound may not be output from certain channels depending on input sources or sound programs.	Try another sound program.	44
No sound is heard from the surround back speakers.	"Extended Surround" in the Option menu is set to "OFF," or an input signal does not contain a surround back flag with "Extended Surround" set to "Auto."	Set "Extended Surround" other than "OFF" or "Auto."	55
No sound is heard from the subwoofer.	A subwoofer is not connected, or it is inactive.	Check that a subwoofer is connected correctly, and from the Setup menu "Subwoofer" ("Speaker" → "Manual Setup" → "Configuration" → "Subwoofer"), set the subwoofer to "Use."	20, 101
	The subwoofer is turned off.	Turn the subwoofer power on. If the subwoofer includes an Auto Power Off function, then lower the Auto Power Off sensitivity settings.	—
	The source does not contain LFE (see p. 135) or low frequency signals.		—
The right combination of audio / video jacks to connect cannot be found.	Combine input connected to the external component video output with another input audio jack.	Display the Input menu for the connected video output, select "Audio In" and select the jack to use for audio input.	88



Problem	Cause	Remedy	See page
The audio input sources cannot be played in the desired digital audio signal format.	The connected component is not set to output the desired digital audio signals.	Set the playback component properly referring to its instruction manual.	—
There is noise interference from digital or radio frequency equipment.	This unit is too close to other digital or radio frequency equipment.	Move this unit further away from such equipment.	—
Noise/hum noise is heard.	Incorrect cable connection. Connect the audio cables properly.	If the problem persists, the cables may be defective.	—
	A DTS-CD is being played back.	1) When only noise is output If a DTS bitstream signal is not properly input to this unit, only noise is output. Connect the playback component to this unit by digital connection and playback the DTS-CD. If the condition is not improved, the problem may result from the playback component. Consult the manufacturer of the playback component. 2) When noise is output during playback or skip operation Before playing back the DTS-CD, display the Input menu after selecting the input source and set "Decoder Mode" to "DTS."	—
The volume cannot be increased, or the sound is distorted.	The component connected to the output jacks of this unit is not turned on.	When the component connected to the output jacks of this unit is not turned on, the sound may be distorted, or the volume may be decreased due to the nature of AV receivers. Turn on all components connected to this unit.	—
	"Max Volume" is set to a low value.	Set it to a higher value.	103



HDMI™

Problem	Cause	Remedy	See page
The front panel display HDMI indicator is flashing.	An error with the HDMI connection has occurred.	Try re-inserting the HDMI cable.	—
		Confirm that HDMI video that is not supported by the unit is not being input (Information menu → "Video information").	113
No picture or sound.	The number of components is over the limit.	Disconnect some of the HDMI components.	—
	The connected HDMI component does not support high-bandwidth digital copyright protection (HDCP).	Connect an HDMI component that supports HDCP.	—
(When using HDMI Control function) TV sound is not output from this unit when operating the remote control of the TV.	The TV audio output is not connected to this unit, or the setting to match operations carried out on TV is not set.	Connect the TV audio output to this unit, and then select the connected input source in "TV Audio Input" (Setup menu → HDMI → TV Audio Input).	106
	(When using Audio Return Channel function) The Audio Return Channel function is not working.	Make sure that your TV supports Audio Return Channel. Set the Audio Return Channel function to on (Setup menu → HDMI → ARC (Audio Return Channel)).	106



Tuner (FM/AM)

FM

Problem	Cause	Remedy	See page
FM stereo reception is noisy.	You are too far from the station transmitter, or the input from the antenna is weak.	Check the antenna connections.	33
		Switch to monaural mode.	59
		Replace the outdoor antenna with a more sensitive multi-element antenna.	—
There is distortion, and clear reception cannot be obtained even with a good FM antenna.	There is multi-path interference.	Adjust the antenna height or orientation, or place it in a different location.	—
The desired station cannot be tuned into with the automatic tuning method.	You are in an area far from a station, or input from the antenna is weak.	Replace the outdoor antenna with a more sensitive multi element antenna.	—
		Use TUN/CH   to manually select the station.	57
“No Presets” is displayed.	No preset stations are registered.	Register stations you want to listen to as preset stations before operation.	57
“Wrong Station” is displayed.	An invalid FM/AM frequency has been input.	Input a frequency that can be received.	—

AM

Problem	Cause	Remedy	See page
The desired station cannot be tuned into with the automatic tuning method.	The signal is weak, or the antenna connections are loose.	Adjust the AM loop antenna orientation.	33
		Use the manual tuning method.	57
Automatic station preset does not work.	Automatic station preset is not available for AM stations.	Use manual station preset.	57
Continuous crackling and hissing noises are heard.	The supplied AM loop antenna is not connected.	Connect the AM loop antenna correctly even if you use an outdoor antenna.	33
	The noises may be caused by lightning, fluorescent lamps, motors, thermostats, or other electrical equipment.	It is difficult to completely eliminate noise, but it can be reduced by installing and properly grounding an outdoor AM antenna.	33
Buzzing and whining noises are heard.	A TV set is being used nearby.	Move this unit away from the TV set.	—

SIRIUS Satellite Radio™

Problem	Cause	Remedy	See page
SIRIUS Satellite Radio information is not displayed properly.	The hold function is enabled.	Press HOLD to disable the hold function.	65

Display	Cause	Remedy	See page
ANTENNA ERROR	The antenna is not connected to the SiriusConnect tuner properly.	Check the connection of the antenna and SiriusConnect tuner.	61
SIRIUS LOADING	This unit is communicating with the SiriusConnect tuner.	The message disappears normally within several tens of seconds.	—



Display	Cause	Remedy	See page
CHECK SR TUNER	The SiriusConnect tuner is not connected to the SIRIUS jack of this unit correctly.	Check the connection of the SiriusConnect tuner and this unit.	61
	The SiriusConnect tuner is not connected to the AC wall outlet.	Connect the power cable of the SiriusConnect tuner to the AC wall outlet.	—
NOT SUPPORTED	This unit does not support the connected SIRIUS Satellite Radio tuner.	Connect the SiriusConnect tuner that this unit supports,	—
ACQUIRING	The signal is too weak.	Adjust the orientation of the antenna of the SiriusConnect tuner. Check the antenna reception level from the Antenna information on the front panel display, or the SIRIUS Information screen on the TV screen.	64 , 65
UPDATING	The SiriusConnect tuner is updating the channel list.	Wait until the updating is complete.	—
	The period of the subscription is end.	Contact SIRIUS Satellite Radio to renew the subscription.	—
F/W UPDATING	The SiriusConnect tuner is updating the firmware.	Wait until the updating is complete.	—
CALL SIRIUS (CALL 888-539- SIRIUS TO SUBSCRIBE)	The selected channel is not subscribed.	Contact SIRIUS Satellite Radio to subscribe the selected channel. URL: https://activate.siriusradio.com/ Phone: 1-888-539-SIRIUS (1-888-539-7474)	—
		Select another channel.	62
SUB UPDATED	The subscription information is updated.		
LOCK	The parental lock function is enabled.	Use Numeric keys to enter the 4-digit code, select OK and then press ENT .	66
		Reset the SIRIUS Satellite Radio parental lock code to the factory default setting.	119
INVALID	The selected channel is currently out of service.	Select another channel.	62
Not Available	The operation you made is not available.		

Network

Problem	Cause	Remedy	See page
The PC server/ Internet Radio does not function properly.	The IP address is not set properly.	Set the DHCP server function of the router to ON. Alternately, perform manual configuration according to the current operating environment.	108
	The network cable is not connected.	Connect it properly.	32
The music in the PC server cannot be played back.	The PC does not have Windows Media Player installed in it.	Install Windows Media Player in the PC.	—
	The music is recorded in a format that cannot be played on this unit. This unit cannot play music formats other than WMA, MP3, MPEG-4 AAC, FLAC and WAV (PCM format). Also note that it cannot play certain music files even if these are recorded in the WMA, MP3, MPEG-4 AAC, FLAC, or WAV format.	Play music recorded in a format that this unit is compatible with.	—
The Internet Radio cannot be played.	The firewall of the network device is activated. The Internet Radio can be played only when it passes through the port designated by each radio station. The port number is variable depending on radio station.	Check the firewall setting of the network device.	—
	Connection to the Internet is disconnected.	Check the configuration of the network device, and then contact the network connection provider.	—



Display	Cause	Remedy	See page
Connect error	There is a problem with the signal path from your network to this unit.	Check the connection between this unit and the LAN port on your router or hub.	32
		Make sure your router is properly connected and turned on. Also, make sure your modem is properly connected and turned on when you are attempting to listen to Internet Radio.	32
Disconnected	The PC server previously connected to this unit no longer exists.	Connect this unit to the available PC server.	32
Access denied	The PC you are attempting to connect has denied connection.	Configure the sharing setting of Window Media Player 11/12 and select this unit as a device to which music contents are shared.	67
Unable to play	This unit cannot play back the songs currently stored on your PC.	Make sure Windows Media Player is installed on your PC.	—
		Check that the songs currently stored on your PC are playable (MP3, WMA, MPEG-4 AAC, and WAV).	—
		Store some other playable music files (MP3, WMA, MPEG-4 AAC, and WAV) on your PC.	—
	The network may be overloaded with heavy traffic, and playback is interrupted.	Try preparing a network exclusively for use with this unit to separate it from general network traffic.	—
List updated	The list of the contents stored on your PC server has been updated.		—
Bookmark On	The desired Internet Radio station has been added to the Bookmarks list.		—
Bookmark Off	The stored Internet Radio station has been removed from the Bookmarks list.		—

iPod™/iPhone™

Display	Cause	Remedy	See page
Loading...	The unit is in the process of recognizing the connection with your iPod/iPhone.		—
	The unit is in the middle of acquiring song lists from your iPod/iPhone.		—
Connect error	There is a problem with the signal path from your iPod/iPhone to the unit.	Turn off the unit and reconnect the Universal Dock for iPod to the DOCK jack of the unit.	79
		Remove your iPod/iPhone from the Universal Dock for iPod and then place it back in the dock.	79
Unknown iPod	The iPod/iPhone being used is not supported by the unit.	Connect an iPod/iPhone supported by the unit.	—
iPod connected	Your iPod/iPhone is properly placed in the Universal Dock for iPod.		—
	Your iPod/iPhone is properly placed in the Yamaha iPod wireless transmitter and connected with this unit via wireless transmission.		81
Disconnected	Your iPod/iPhone is removed from the Universal Dock for iPod.		—
	Your iPod/iPhone is disconnected with this unit via wireless transmission.		—
Unable to play	The unit cannot playback the songs currently stored on your iPod/iPhone.	Check that songs are currently stored on your iPod/iPhone.	—



Bluetooth™

Display	Cause	Remedy	See page
Searching...	The Yamaha Bluetooth wireless audio receiver and the Bluetooth component are in the process of pairing.		—
	The Yamaha Bluetooth wireless audio receiver and the Bluetooth component are in the process of establishing a connection.		—
Completed	The pairing is completed.		—
Canceled	The pairing is canceled.		—
BT connected	The connection between the Yamaha Bluetooth wireless audio receiver and the Bluetooth component is established.		—
Disconnected	The Bluetooth component is disconnected from the Yamaha Bluetooth wireless audio receiver.		—
Not found	The Bluetooth component is not found.	During pairing: – pairing must be performed on the Bluetooth component and this unit simultaneously. Check if the Bluetooth component is in pairing mode.	—
		During connecting: – check if the Bluetooth component is turned on. – check if the Bluetooth component is within 32 ft. (10 m) of the Yamaha Bluetooth wireless audio receiver.	
	Pairing may not have been achieved.	Try pairing again.	83

Remote control

Problem	Cause	Remedy	See page
The remote control does not work or function properly.	Wrong distance or angle.	The remote control will function within a maximum range of 20 ft. (6 m), and no more than 30 degrees off-axis from the front panel.	—
	Direct sunlight or lighting (from an inverter type of fluorescent lamp, strobe light, etc.) is striking the remote control sensor of this unit.	Adjust the lighting angle, or reposition this unit.	—
	The batteries are weak.	Replace all batteries.	7
	The remote control ID of the remote control and this unit do not match.	Match the remote control ID of this unit and the remote control.	116
External components cannot be controlled using the remote control.	The remote control code is not correctly set.	Set the remote control code correctly using “ Remote control code search ” on the CD-ROM.	—
		Try setting another code for the same manufacturer using “ Remote control code search ” on the CD-ROM.	—
		If this unit does not work when you press Cursor $\Delta / \nabla / \triangleleft / \triangleright$, do the following. When the key does not work during DVD disc menu operation: press the Input selector again. When there is no response with remote control operation of the Option menu/Setup menu: press SOURCE/RECEIVER (it should glow orange) and try operating the remote control again.	—
	Even if the remote control code is correctly set, there are some models that do not respond to the remote control.		—



Glossary

Audio information

Audio and video synchronization (Lipsync)

Lip sync, an abbreviation for lip synchronization, is a technical term that involves both a problem, and the capability of maintaining audio and video signals synchronized during post-production and transmission.

Whereas the audio and video latency requires complex end-user adjustment, HDMI version 1.3 incorporates an automatic audio and video syncing capability that allows devices to perform this synchronization automatically and accurately without user interaction.

Bi-amplification connection (Bi-amp)

A bi-amplification connection uses two amplifiers for a speaker. One amplifier is connected to the woofer section of a loudspeaker while the other is connected to the combined mid and tweeter section. With this arrangement each amplifier operates over a restricted frequency range. This restricted range presents each amplifier with a much simpler job and each amplifier is less likely to influence the sound in some way.

Dolby Digital

Dolby Digital is a digital surround sound system that gives you completely independent multi-channel audio. With 3 front channels (front L/R and center), and 2 surround stereo channels, Dolby Digital provides 5 full-range audio channels. With an additional channel especially for bass effects, referred to as LFE (Low-Frequency Effect), the system has a total of 5.1-channels (LFE is counted as 0.1 channel). By using 2-channel stereo for the surround speakers, more accurate moving sound effects and surround sound environments are possible than with Dolby Surround. The wide dynamic range from maximum to minimum volumes that are reproduced by the 5 full-range channels, and the precise sound orientation generated using digital sound processing provides listeners with unprecedented excitement and realism. With this unit, any sound environment from monaural up to a 5.1-channel configuration can be freely selected for your enjoyment.

Dolby Pro Logic II

Dolby Pro Logic II is an improved technique used to decode vast numbers of existing Dolby Surround sources. This new technology enables a discrete 5-channel playback with 2 front left and right channels, 1 center channel, and 2 surround left and right channels, instead of only 1 surround channel for conventional Pro Logic technology. There are three modes available: “Music mode” for music sources, “Movie mode” for movie sources, and “Game mode” for game sources.

Dolby Pro Logic IIx

Dolby Pro Logic IIx is a new technology enabling discrete multichannel playback from 2-channel or multi-channel sources. There are three modes available: “Music mode” for music sources, “Movie mode” for movie sources (for 2-channel sources only) and “Game mode” for game sources.

Dolby Surround

Dolby Surround uses a 4-channel analog recording system to reproduce realistic and dynamic sound effects: 2 front left and right channels (stereo), a center channel for dialog (monaural), and a surround channel for special sound effects (monaural). The surround channel reproduces sound within a narrow frequency range. Dolby Surround is widely used with nearly all video tapes and laser discs, as well as in many TV and cable broadcasts. The Dolby Pro Logic decoder built into this unit employs a digital signal processing system that automatically stabilizes the volume on each channel to enhance moving sound effects and directionality.

Dolby TrueHD

Dolby TrueHD is an advanced lossless audio technology developed for high-definition disc-based media including Blu-ray Disc. Selected as an optional audio standard for Blu-ray Disc, this technology delivers sound that is bit-for-bit identical to the studio master, offering a high-definition home theater experience. Supporting bitrates up to 18.0 Mbps, Dolby TrueHD can carry up to 8 discrete channels of 24-bit/96 kHz audio simultaneously. Dolby TrueHD also remains fully compatible with the existing multichannel audio systems and retains the metadata capability of Dolby Digital, allowing dialog normalization and dynamic range control.

DTS 96/24

DTS 96/24 offers an unprecedented level of audio quality for multichannel sound on DVD video, and is fully backward-compatible with all DTS decoders. “96” refers to a 96 kHz sampling rate compared to the typical 48 kHz sampling rate. “24” refers to 24-bit word length. DTS 96/24 offers sound quality transparent to the original 96/24 master, and 96/24 5.1-channel sound with full-quality full-motion video for music programs and motion picture soundtracks on DVD video.

Dolby Digital Plus

Dolby Digital Plus is an advanced audio technology developed for high-definition programming and Blu-ray Disc. Selected as an optional audio standard for Blu-ray Disc, this technology delivers multichannel sound with discrete channel output. Supporting bitrates up to 6.0 Mbps, Dolby Digital Plus can carry up to 7.1 discrete audio channels simultaneously. Supported by HDMI version 1.3 and designed for the optical disc players and AV receivers/amplifiers of the future, Dolby Digital Plus also remains fully compatible with the existing multichannel audio systems that incorporate Dolby Digital.

DTS Digital Surround

DTS Digital Surround was developed to replace the analog soundtracks of movies with a 5.1-channel digital sound track, and is now rapidly gaining popularity in movie theaters around the world. DTS, Inc. has developed a home theater system so that you can enjoy the depth of sound and natural spatial representation of DTS Digital Surround in your home. This system produces practically distortion-free 5.1-channel sound (technically, left, right and center channels, 2 surround channels, plus an LFE 0.1 channel as a subwoofer, for a total of 5.1-channels). This unit incorporates a DTS-ES decoder that enables 6.1-channel reproduction by adding the surround back channel to the existing 5.1-channel format.

DTS Express

This is an audio format for next-generation optical discs such as Blu-ray discs. It uses optimized low bit rate signals for network streaming. In the case of a Blu-ray disc, this format is used with secondary audio, enabling you to enjoy the commentary of the movie producer via the Internet while playing the main program.

DTS-HD High Resolution Audio

DTS-HD High Resolution Audio is a high resolution audio technology developed for high-definition disc-based media including Blu-ray Disc. Selected as an optional audio standard for Blu-ray Disc, this technology delivers sound that is virtually indistinguishable from the original, offering a high-definition home theater experience.

Supporting bitrates up to 6.0 Mbps for Blu-ray Disc, DTS-HD High Resolution Audio can carry up to 7.1 discrete channels of 24-bit/96 kHz audio simultaneously.

DTS-HD High Resolution Audio also remains fully compatible with the existing multichannel audio systems that incorporate DTS Digital Surround.



DTS-HD Master Audio

DTS-HD Master Audio is an advanced lossless audio technology developed for high-definition disc-based media including Blu-ray Disc. Selected as an optional audio standard for Blu-ray Disc, this technology delivers sound that is bit-for-bit identical to the studio master, offering a high-definition home theater experience.

Supporting bitrates up to 24.5 Mbps for Blu-ray Disc, DTS-HD Master Audio can carry up to 7.1 discrete channels of 24-bit/96 kHz audio simultaneously. Supported by HDMI version 1.3 and designed for the optical disc players and AV receivers/amplifiers of the future, DTS-HD Master Audio also remains fully compatible with the existing multichannel audio systems that incorporate DTS Digital Surround.

DSD

Direct Stream Digital (DSD) technology stores audio signals on digital storage media, such as Super Audio CDs. Using DSD, signals are stored as single bit values at a high-frequency sampling rate of 2.8224 MHz, while noise shaping and oversampling are used to reduce distortion, a common occurrence with very high quantization of audio signals. Due to the high sampling rate, better audio quality can be achieved than that offered by the PCM format used for normal audio CDs. The frequency is equal to or higher than 100 kHz, with a dynamic range of 120 dB. This unit can transmit or receive DSD signals via the HDMI jack.

FLAC

This is a file format for lossless audio data compression. FLAC is inferior to lossy compression formats in compression rate but provides higher audio quality.

LFE 0.1 channel

This channel reproduces low-frequency bass signals, and has a frequency range from 20 Hz to 120 Hz. This channel is counted as 0.1, because it only enforces a low-frequency range compared to the full-range reproduced by the other 5-channels in Dolby Digital or DTS 5.1-channel systems.

MP3

One of the audio compression methods used by MPEG. It employs the irreversible compression method, which achieves a high compression rate by thinning out the data of hardly audible part to the human ears. It is said to be capable of compressing the data quantity by about 1/11 (128 kbps) while maintaining a similar audio quality to music CD.

MPEG-4 AAC

An MPEG-4 audio standard. As it allows compression of data at a bit rate lower than that of MPEG-2 AAC, it is used among others for mobile telephones, portable audio players and other low-capacity devices requiring high sound quality. In addition to the above types of devices, MPEG-4 AAC is also used to distribute contents on the Internet, and as such is supported by computers, media servers and many other devices.

Neo:6

Neo:6 decodes the conventional 2-channel sources for 6-channel playback by the specific decoder. It enables playback with the full-range channels with higher separation just like digital discrete signal playback. There are two modes available: "Music mode" for music sources and "Cinema mode" for movie sources.

PCM (Linear PCM)

Linear PCM is a signal format under which an analog audio signal is digitized, recorded and transmitted without using any compression. This is used as a method of recording CDs and DVD audio. The PCM system uses a technique for sampling the size of the analog signal per very small unit of time. Standing for "Pulse Code Modulation," the analog signal is encoded as pulses and then modulated for recording.

Sampling frequency and number of quantized bits

When digitizing an analog audio signal, the number of times the signal is sampled per second is called the sampling frequency, while the degree of accuracy when converting the sound level into a numeric value is called the number of quantized bits. The range of rates that can be played back is determined based on the sampling rate, whereas the dynamic range representing the sound level difference is determined by the number of quantized bits. In principle, the higher the sampling frequency, the wider the range of frequencies that can be played back, and the higher the number of quantized bits, the more accurately the sound level can be reproduced.

WAV

Windows standard audio file format, which defines the method of recording the digital data obtained by converting audio signals. It does not specify the compression (coding) method so a desired compression method can be used with it. By default, it is compatible with the PCM method (no compression) and some compression methods including the ADPCM method.

WMA

An audio compression method developed by Microsoft Corporation. It employs the irreversible compression method, which achieves a high compression rate by thinning out the data of hardly audible part to the human ears. It is said to be capable of compressing the data quantity by about 1/22 (64 kbps) while maintaining a similar audio quality to music CD.

Sound program information**CINEMA DSP**

Since the Dolby Surround and DTS systems were originally designed for use in movie theaters, their effect is best felt in a theater having many speakers designed for acoustic effects. Since home conditions, such as room size, wall material, number of speakers, and so on, can differ so widely, it is inevitable that there are differences in the sound that is heard. Based on a wealth of actually measured data, Yamaha CINEMA DSP uses Yamaha's original DSP technology to combine Dolby Pro Logic, Dolby Digital, and DTS systems to provide the audiovisual experience of a movie theater in the listening room of your own home.

CINEMA DSP 3D

The actually measured sound field data contain the information of the height of the sound images. CINEMA DSP 3D feature achieves the reproduction of the accurate height of the sound images so that it creates the accurate and intensive stereoscopic sound fields in a listening room.

Compressed Music Enhancer

The Compressed Music Enhancer feature of this unit enhances your listening experience by regenerating the missing harmonics in compression artifacts. As a result, it compensates for flattened complexity due to the loss of high-frequency fidelity as well as lack of bass due to the loss of low-frequency bass, providing improved performance for the overall sound system.

SILENT CINEMA

Yamaha has developed a natural, realistic sound effect DSP algorithm for headphones. Parameters for headphones have been set for each sound program, so that accurate representations of all the sound programs can be enjoyed on headphones.

Virtual CINEMA DSP

Yamaha has developed a Virtual CINEMA DSP algorithm that allows you to enjoy DSP surround effects even without any surround speakers, by using virtual surround speakers. It is even possible to enjoy Virtual CINEMA DSP using a minimal two-speaker system that does not include a center speaker.



Video information

Component video signal

With the component video signal system, the video signal is separated into the Y signal for luminance and the Pb and Pr signals for chrominance. Color can be reproduced more faithfully with this system because each of these signals is independent. The component signal is also called the “color difference signal” because the luminance signal is subtracted from the color signal. A monitor with component input jacks is required in order to output component signals.

Composite video signal

With the composite video signal system, the video signal comprises the three basic elements of a video picture: color, brightness and synchronization data. A composite video jack on a video component transmits these three elements combined.

Deep Color

Deep Color refers to the use of various color depths in displays, up from the 24-bit depths in previous versions of the HDMI specification. This extra bit depth allows HDTVs and other displays increase from millions of colors to billions of colors and eliminate on-screen color banding for smooth tonal transitions and subtle gradations between colors. The increased contrast ratio can represent many times more shades of gray between black and white. Additionally, Deep Color increases the number of available colors within the boundaries defined by the RGB or YCbCr color space.

HDMI

HDMI (High-Definition Multimedia Interface) is the first industry supported, uncompressed, all-digital audio/video interface. Providing an interface between any sources (such as set-top boxes or AV receivers) and audio/video monitors (such as digital televisions), HDMI supports standard, enhanced or high-definition video as well as multichannel digital audio using a single cable. HDMI transmits all ATSC HDTV standards and supports 8-channel digital audio, with bandwidth to spare to accommodate future enhancements and requirements.

When used in combination with HDCP (High-bandwidth Digital Content Protection), HDMI provides a secure audio/video interface that meets the security requirements of content providers and system operators. For further information on HDMI, visit the HDMI website at “<http://www.hdmi.org/>.”

“x.v.Color”

A color space standard supported by HDMI version 1.3. It is a more extensive color space than sRGB, and allows the expression of colors that were not hitherto possible. While remaining compatible with the color gamut of sRGB standards, “x.v.Color” expands the color space, and can thus produce more vivid, natural images. It is particularly effective for still pictures and computer graphics.

Video conversion

Analog-to-HDMI video conversion is performed according to resolution of video signals as shown below. Analog-to-analog video conversion is also possible when “Analog to Analog Conversion” is set to “On” ([p. 104](#)).

✓: available conversion

	Resolution	HDMI output					COMPONENT VIDEO output				VIDEO output
		480i/576i	480p/576p	720p	1080i	1080p	480i/576i	480p/576p	720p	1080i	480i/576i
HDMI input	480i/576i	✓	✓	✓	✓	✓					
	480p/576p		✓	✓	✓	✓					
	720p			✓							
	1080i				✓						
	1080p					✓					
COMPONENT VIDEO input	480i/576i	✓	✓	✓	✓	✓	✓				✓
	480p/576p		✓	✓	✓	✓		✓			
	720p			✓					✓		
	1080i				✓					✓	
VIDEO input	480i/576i	✓	✓	✓	✓	✓	✓				✓



Information on HDMI™

■ HDMI signal compatibility

Audio signals

Audio signal types	Audio signal formats	Compatible media
2ch Linear PCM	2ch, 32-192 kHz, 16/20/24 bit	CD, DVD-Video, DVD-Audio, etc.
Multi-ch Linear PCM	8ch, 32-192 kHz, 16/20/24 bit	DVD-Audio, Blu-ray Disc, HD DVD, etc.
DSD	2/5.1ch, 2.8224 MHz, 1 bit	SACD, etc.
Bitstream	Dolby Digital, DTS	DVD-Video, etc.
Bitstream (High definition audio)	Dolby TrueHD, Dolby Digital Plus, DTS-HD Master Audio, DTS-HD High Resolution Audio, DTS Express	Blu-ray Disc, HD DVD, etc.

- If the input source component can decode the bitstream audio signals of audio commentaries, you can playback the audio sources with the audio commentaries mixed down by using the digital audio input (optical or coaxial) connections.
- Refer to the supplied instruction manuals of the input source component, and set the component appropriately.

NOTES

- When CPPM copy-protected DVD-Audio is played back, video and audio signals may not be output, depending on the type of the DVD player.
- This unit is not compatible with HDCP-incompatible HDMI or DVI components.
- Refer to the supplied instruction manuals for details.
To decode audio bitstream signals on this unit, set the input source component appropriately so that the component outputs the bitstream audio signals directly (does not decode the bitstream signals on the component).
- This unit is not compatible with the audio commentary features (for example, the special audio contents downloaded via Internet) of Blu-ray Disc or HD DVD. This unit does not playback the audio commentaries of the Blu-ray Disc or HD DVD content.

Video signals

This unit is compatible with the video signals of the following resolutions:

- 480i/60 Hz
- 576i/50 Hz
- 480p/60 Hz
- 576p/50 Hz
- 720p/60 Hz, 50 Hz
- 1080i/60 Hz, 50 Hz
- 1080p/60 Hz, 50 Hz, 24 Hz



About trademarks



Manufactured under license from Dolby Laboratories. Dolby, Pro Logic and the double-D symbol are trademarks of Dolby Laboratories.



Manufactured under license under U.S. Patent #'s: 5,451,942; 5,956,674; 5,974,380; 5,978,762; 6,226,616; 6,487,535; 7,212,872; 7,333,929; 7,392,195; 7,272,567 & other U.S. and worldwide patents issued & pending. DTS and the Symbol are registered trademarks, & DTS-HD, DTS-HD Master Audio, and the DTS logos are trademarks of DTS, Inc. Product includes software. © DTS, Inc. All Rights Reserved.

iPod™, iPhone™

“iPod” is a trademark of Apple Inc., registered in the U.S. and other countries. “iPhone” is a trademark of Apple Inc.



Fraunhofer Institut
Integrierte Schaltungen

MPEG Layer-3 audio coding technology licensed from Fraunhofer IIS and Thomson.



This receiver supports network connections.

Bluetooth™

Bluetooth is a registered trademark of the Bluetooth SIG and is used by Yamaha in accordance with a license agreement.



HIGH DEFINITION MULTIMEDIA INTERFACE

“HDMI,” the “HDMI” logo and “High-Definition Multimedia Interface” are trademarks, or registered trademarks of HDMI Licensing LLC.

x.v.Color™

“x.v.Color” is a trademark of Sony Corporation.



“SILENT CINEMA” is a trademark of Yamaha Corporation.



SIRIUS, XM and all related marks and logos are trademarks of Sirius XM Radio Inc. and its subsidiaries. All rights reserved. **Service not available in Alaska and Hawaii.**



Rhapsody and the Rhapsody logo are registered trademarks of RealNetworks, Inc.

Windows XP, Windows Vista, Windows 7, Windows Media Audio, Windows Media Connect and Windows Media Player are either registered trademarks or trademarks of Microsoft Corporation in the United States and/or other countries.



Specifications

■ Input		■ HDMI		■ Remote	
• Analog Audio		• Input.....6 (HDMI 1-5, VIDEO AUX)		• REMOTE IN.....1	
RCA.....5 (AV 5-6, AUDIO 1-2, VIDEO AUX)		• Output.....2 (HDMI OUT 1-2)		• REMOTE OUT.....1	
MULTI CH INPUT.....8ch		• HDMI Specification.....HDMI Version 1.4a compatible		• TRIGGER OUT.....1	
FRONT L/R, CENTER, SURROUND L/R,		Deep Color, “x.v.Color,” Auto Lips Sync,			
SURROUND BACK L/R, SUBWOOFER		ARC (Audio Return Channel), 3D Video			
• Digital Audio		• Audio Format		■ Compatible Decoding Format	
Optical.....2 (AV 1, AV 4)		Dolby Digital, DTS, DSD 6ch, Dolby Digital Plus, Dolby TrueHD,		• Decoding Format	
Coaxial.....2 (AV 2, AV 3)		DTS-HD, PCM 2ch-8ch		Dolby TrueHD, Dolby Digital Plus, Dolby Digital,	
• Analog Video		• Content Protection.....HDCP compatible		Dolby Digital EX, DTS-HD Master Audio,	
Composite.....5 (AV 3-6, VIDEO AUX)				DTS-HD High Resolution, DTS Express, DTS,	
Component.....2 (AV 1-2)				DTS-ES Matrix 6.1, DTS-ES Discrete 6.1, DTS 96/24	
• Other		■ Tuner		• Post Decoding Format	
DOCK.....1 (Audio, Composite Video)		• Analog Tuner		Dolby Pro Logic, Dolby Pro Logic II Music,	
		FM/AM.....1 (TUNER)		Dolby Pro Logic II Movie, Dolby Pro Logic II Game,	
		• Satellite Radio Ready		Dolby Pro Logic IIX Music, Dolby Pro Logic IIX Movie,	
		SIRIUS Satellite Radio.....1 (SIRIUS)		Dolby Pro Logic IIX Game, DTS Neo:6 Music, DTS Neo:6 Cinema	
■ Output					
• Analog Audio		■ Network			
SPEAKERS.....9ch (7ch + Extra 2ch)		• Ethernet (100Base-TX/10Base-TX).....1			
FRONT L/R, CENTER, SURROUND L/R,		Internet Radio			
SURROUND BACK/BI-AMP L/R,		Audio Format.....MP3, WMA			
EXTRA SP (ZONE2/F.PRESENCE L/R)		PC Server			
PRE OUT.....9ch		Audio Format.....MP3, WMA, WAV, MPEG-4 AAC, FLAC			
FRONT L/R, CENTER, SURROUND L/R,		Max Audio Support fs.....96 kHz/24 bit			
SURROUND BACK L/R, SUBWOOFER [Mono 2ch]		Cover Art Format.....PNG, JPEG			
AV OUT.....1		DLNA			
AUDIO OUT.....1		Version.....1.5 (DMP & DMR support)			
ZONE2 OUT.....1		Audio Format.....MP3, WMA, WAV, MPEG-4 AAC, FLAC			
• Analog Video		Max Audio Support fs.....96 kHz/24 bit			
MONITOR OUT		Cover Art Format.....PNG, JPEG			
Composite.....1		Internet Music Service			
Component.....1		Rhapsody, SIRIUS Internet Radio			
AV OUT		Network Control			
Composite.....1		Web Browser Control (supporting Friendly Name only),			
		MusicCAST2 Commander Support, Yamaha Network Control			
		Support (YNC)			

Continues to the
next page



■ Audio Section

- Minimum RMS Output Power (20 Hz to 20 kHz, 0.09 % THD, 8 Ω)
 - FRONT L/R 95 W + 95 W
 - CENTER 95 W
 - SURROUND L/R 95 W + 95 W
 - SURROUND BACK L/R 95 W
- Dynamic Power (IHF)
 - FRONT L/R, 8/6/4/2 Ω 130/165/195/240 W
- Dynamic Headroom
 - 8 Ω 1.36 dB
- Damping Factor
 - FRONT L/R, 20 Hz to 20 kHz, 8 Ω 100 or more
- Input Sensitivity/Input Impedance
 - AV 5 etc. 200 mV/47 kΩ
 - MULTI CH IN 200 mV/47 kΩ
- Maximum Input Level
 - AV 5 etc. (1 kHz, 0.5 % THD) 2.3 V or more
- Output Level/Output Impedance
 - AV OUT 200 mV/1.2 kΩ
 - PRE OUT 1.0 V/1.2 kΩ
 - ZONE2 OUT 200 mV/1.2 kΩ
- Headphone Jack Rated Output/Impedance
 - AV 5 etc. (1 kHz, 50 mV, 8 Ω) 100 mV/560 Ω
- Frequency Response
 - AV 5 etc. to FRONT L/R (10 Hz to 100 kHz) +0/-3 dB
- Total Harmonic Distortion
 - AV 5 etc. (Pure Direct) to FRONT L/R
(20 Hz to 20 kHz, 50 W/8 Ω) 0.06 % or less
- Signal to Noise Ratio (IHF-A Network)
 - AV 5 etc. (Pure Direct, input shorted, 250 mV)
to FRONT L/R 100 dB or more
- Residual Noise (IHF-A Network)
 - FRONT L/R 150 μV or less
- Channel Separation (1 kHz/10 kHz)
 - AV 5 etc. (input 5.1 kΩ shorted) 60 dB/45 dB or more

- Volume Control MUTE/-80 dB to +16.5 dB
- Tone Control Characteristics
 - Bass Boost/Cut ±6 dB/50 Hz
 - Bass Turnover Frequency 350 Hz
 - Treble Boost/Cut ±6 dB/20 kHz
 - Treble Turnover Frequency 3.5 kHz
- Filter Characteristics (fc=40/60/80/90/100/110/120/160/200 Hz)
 - H.P.F.
(FRONT, CENTER, SURROUND,
SURROUND BACK: Small) 12 dB/oct.
 - L.P.F. (SUBWOOFER) 24 dB/oct.

■ Video Section

- Video Format (MONITOR OUT, Wall Paper/OSD) NTSC
- Video Signal Type (Video Conversion) NTSC/PAL
- Composite Video Signal Level 1 Vp-p/75 Ω
- Component Video Signal Level
 - Y 1 Vp-p/75 Ω
 - PB/PR 0.7 Vp-p/75 Ω
- Maximum Input Level (Video Conversion Off) 1.5 Vp-p or more
- Signal to Noise Ratio 50 dB or more
- Monitor Out Frequency Response (Video Conversion Off)
 - Component 5 Hz to 60 MHz, -3 dB

■ FM Section

- Tuning Range 87.5 to 107.9 MHz
- 50 dB Quieting Sensitivity (IHF)
 - Mono 3.0 μV (20.8 dBf)
- Signal to Noise Ration (IHF)
 - Mono/Stereo 74 dB/70 dB
 - [U.S.A. model] HD 80 dB
- Harmonic Distortion (1 kHz)
 - Mono/Stereo 0.3 %/0.3 %
- Antenna Input 75 Ω (unbalanced)

■ AM Section

- Tuning Range 530 to 1710 kHz

■ General

- Power Supply AC 120 V, 60 Hz
- Power Consumption 400 W/500 VA
- Standby Power Consumption (Reference Data)
 - HDMI Control Off/Standby Through Off 0.2 W or less
 - HDMI Control On/Standby Through On
(Input: HDMI 1, no HDMI signal is input) 2.7 W (typical)
 - NET Standby On 4.5 W (typical)
- Dimensions (W x H x D)
 - 435 x 171 x 363mm (17-1/8 x 6-3/4 x 14-1/2 in)
- Weight 11.3 kg (24.9 lbs.)

* Specifications are subject to change without notice.



Index

Numerics

5 channel speaker layout.....	16
5.1-channel speaker layout.....	15
7.1-channel speaker connection.....	17
7.1-channel speaker layout.....	14

A

Account Status, Input menu.....	88
Adaptive DRC, Option menu.....	54
Advanced Setup menu.....	118
All channel search mode.....	63
AM antenna connection.....	33
AM tuning.....	57
Analog to Analog Conversion, Video Setup.....	104
ARC (Audio Return Channel), HDMI Setup.....	106
Aspect, Processing, Video Setup.....	105
Audio information, Information menu.....	113
Audio Input, Input menu.....	88
AUDIO jack.....	21
Audio Output, HDMI Setup.....	107
Audio Return Channel function.....	123
Auto Power Down, Function Setup.....	110
Auto Preset.....	60
Auto Setup, Speaker Setup.....	99

B

BD player connection.....	25
Bi-amp connection, speaker.....	18
Bluetooth™ component playback.....	83
Bookmark Off, Internet Radio.....	69
Bookmark On, Internet Radio.....	69
Browse view.....	56

C

Cable plug.....	21
Category search mode.....	63
Center Image, Sound Program menu.....	97
Center Level, Sound Program menu.....	96

Center speaker.....	13
Center Width, Sound Program menu.....	97
Changing speaker impedance.....	18
CINEMA DSP 3D mode.....	46
CINEMA DSP 3D Mode, Option menu.....	54
CINEMA DSP indicator.....	10
Clear All Preset.....	60, 66
Clear Preset.....	60, 66
COAXIAL jack.....	21
COMPONENT VIDEO jack.....	21
Compressed Music Enhancer.....	47
Configuration, Manual Setup, Speaker Setup.....	100
Connect, Option menu.....	55
Connecting speakers.....	17
Connecting to network.....	32
Connections.....	13
Content window.....	56
Control Select, HDMI Setup.....	106
Cursor indicators.....	10

D

Decode Type, Sound Program menu.....	96, 97
Decoder Mode, Input menu.....	88
Dialogue Lift, Option menu.....	54
Dimension, Sound Program menu.....	97
Direct number access mode.....	63
Direct, Sound Program menu.....	96
Disconnect, Option menu.....	55
Display Set, Function Setup.....	110
Distance, Speaker Setup.....	101
DMC Control, Input menu.....	88
DSP Level, Sound Program menu.....	94
DVD player connection.....	25
Dynamic Range, Sound Setup.....	103

E

Enhancer, Input menu.....	89
Extended Surround, Option menu.....	55

External component connection.....	21
External decoder connection.....	29

F

FIRM UPDATE, Advanced Setup menu.....	120
FM antenna connection.....	33
FM Mode.....	59
FM tuning.....	57
Front panel.....	8
Front panel display.....	10
Front Presence L Level, Sound Program menu.....	96
Front Presence R Level, Sound Program menu.....	97
Front speaker.....	13
Function Setup.....	109

G

Game connection.....	29
----------------------	----

H

HDMI Control function.....	121
HDMI Control, HDMI Setup.....	106
HDMI indicator.....	10
HDMI jack.....	21
HDMI monitor, Information menu.....	113
HDMI Setup.....	105
High-frequency sound adjustment.....	43

I

Information menu.....	113
INIT, Advanced Setup menu.....	120
Initial Delay, Sound Program menu.....	94
Initial Volume, Sound Setup.....	104
Input menu.....	86
Input menu list.....	87
Internet Radio.....	69
IP Address, Network setup.....	108
iPhone™ playback.....	79
iPod Interlock, Input menu.....	89



iPod wireless system	81	O	Reset, Scene menu	92
iPod™ playback	79	ON SCREEN menu	Resolution, Processing, Video Setup	105
J		On-screen display	Reverb Delay, Sound Program menu	95
Jack	21	OPTICAL jack	Reverb Level, Sound Program menu	96
L		Option menu	Reverb Time, Sound Program menu	95
Language	112	Option menu list	Rhapsody Trial, Input menu	89
Level, Speaker Setup	101	P	Rhapsody®	71
Lipsync, Sound Setup	103	Pairing, Option menu	Room Size, Sound Program menu	94
Liveness, Sound Program menu	95	Panorama, Sound Program menu	S	
Load, SCENE menu	91	Parametric EQ, Speaker Setup	Satellite Radio	61
Low-frequency sound adjustment	43	Party Mode Set, Multi Zone	Save, SCENE menu	91
M		PC	SCENE function	44
MAC Address Filter, Network setup	108	PHONES jack	SCENE menu	90
Manual Preset	57	Play Control, DOCK (iPod)	Setup menu	98
Manual Setup, Speaker Setup	99	Play Control, Internet Radio	Shortcut function	78
Manual Tuning	59	Play Control, PC	Shuffle, Option menu	55
Max Volume, Sound Setup	103	Play Control, Rhapsody	Sign In, Input menu	89
Memory Guard, Function Setup	112	Play Control, SIRIUS Internet Radio	SILENT CINEMA mode	46
Menu browse control	80	Portable audio player connection	Simple remote control	81
MON.CHK, Advanced Setup menu	120	Power Amp Assign, Manual Setup, Speaker Setup	SIRIUS Internet Radio	75
Multi information display	10	PREOUT connection	SIRIUS Satellite Radio	61
Multi Zone	109	Presence speaker	SiriusConnect™ tuner	61
Multi-format player connection	29	Presence speaker layout	Sound program	44
Multi-zone function	125	Preset Select	Sound Program menu	93
MUTE indicator	10	Pure Direct mode	Sound Setup	103
N		R	SP IMP., Advanced Setup menu	118
Network connection	32	Radio Control	Speaker connection	13
NETWORK port	32	Rear panel	Speaker indicators	10
Network setup	108	Remote control	Speaker layout	14
Network Standby, Network setup	108	Remote control battery installation	Speaker setting	34
Network, Information menu	114	Remote control connection	Speaker Setup	99
Normal tuning	57	Remote control, Controlling other components	SR PIN, Advanced Setup menu	119
Now Playing view	56	REMOTE ID, Advanced Setup menu	Standby Charge, Input menu	89
		Remove Account, Input menu	Standby Through, HDMI Setup	107
		Rename/Icon Select, Input menu	Straight Decoding Mode	45
		Rename/Icon Select, Scene menu	Subwoofer	13
		Repeat, Option menu	Supplied accessories	7
			Surround Back Initial Delay, Sound Program menu	94
			Surround Back L Level, Sound Program menu	96



Surround Back Liveness, Sound Program menu	95
Surround Back R Level, Sound Program menu	96
Surround Back Room Size, Sound Program menu	94
Surround back speaker	13
Surround Initial Delay, Sound Program menu	94
Surround L Level, Sound Program menu	96
Surround Liveness, Sound Program menu	95
Surround R Level, Sound Program menu	96
Surround Room Size, Sound Program menu	94
Surround speaker	13

T

Test Tone, Speaker Setup	102
Tone control	43
Tone Control, Option menu	54
Trigger connection	31
Trigger Output, Function Setup	111
Tuner indicators	10
TV Audio Input, HDMI Setup	106
TV FORMAT, Advanced Setup menu	120
TV monitor connection	22

V

VERSION, Advanced Setup menu	120
VIDEO AUX input cover	7
Video information, Information menu	113
VIDEO jack	21
Video Out, Input menu	89
Video Setup	104
Virtual CINEMA DSP 3D mode	46
Virtual CINEMA DSP mode	46
VOLUME	8
VOLUME indicator	10
Volume Trim, Option menu	55

Y

YPAO	34
------------	----

Z

Zone Rename, Multi Zone setup	109
Zone2 Set, Multi Zone	109



