

DIGITAL WORKSTATION

PSR-S550

Owner's Manual



SPECIAL MESSAGE SECTION

This product utilizes batteries or an external power supply (adapter). DO NOT connect this product to any power supply or adapter other than one described in the manual, on the name plate, or specifically recommended by Yamaha.

This product should be used only with the components supplied or; a cart, rack, or stand that is recommended by Yamaha. If a cart, etc., is used, please observe all safety markings and instructions that accompany the accessory product.

SPECIFICATIONS SUBJECT TO CHANGE:

The information contained in this manual is believed to be correct at the time of printing. However, Yamaha reserves the right to change or modify any of the specifications without notice or obligation to update existing units.

This product, either alone or in combination with an amplifier and headphones or speaker/s, may be capable of producing sound levels that could cause permanent hearing loss. DO NOT operate for long periods of time at a high volume level or at a level that is uncomfortable. If you experience any hearing loss or ringing in the ears, you should consult an audiologist.

IMPORTANT: The louder the sound, the shorter the time period before damage occurs.

NOTICE:

Service charges incurred due to a lack of knowledge relating to how a function or effect works (when the unit is operating as designed) are not covered by the manufacturer's warranty, and are therefore the owners responsibility. Please study this manual carefully and consult your dealer before requesting service.

ENVIRONMENTAL ISSUES:

Yamaha strives to produce products that are both user safe and environmentally friendly. We sincerely believe that our products and the production methods used to produce them, meet these goals. In keeping with both the letter and the spirit of the law, we want you to be aware of the following:

Battery Notice:

This product MAY contain a small non-rechargeable battery which (if applicable) is soldered in place. The average life span of this type of battery is approximately five years. When replacement becomes necessary, contact a qualified service representative to perform the replacement.

This product may also use "household" type batteries. Some of these may be rechargeable. Make sure that the battery being charged is a rechargeable type and that the charger is intended for the battery being charged.

When installing batteries, do not mix batteries with new, or with batteries of a different type. Batteries MUST be installed correctly. Mismatches or incorrect installation may result in overheating and battery case rupture.

Warning:

Do not attempt to disassemble, or incinerate any battery. Keep all batteries away from children. Dispose of used batteries promptly and as regulated by the laws in your area. Note: Check with any retailer of household type batteries in your area for battery disposal information.

Disposal Notice:

Should this product become damaged beyond repair, or for some reason its useful life is considered to be at an end, please observe all local, state, and federal regulations that relate to the disposal of products that contain lead, batteries, plastics, etc. If your dealer is unable to assist you, please contact Yamaha directly.

NAME PLATE LOCATION:

The name plate is located on the bottom of the product. The model number, serial number, power requirements, etc., are located on this plate. You should record the model number, serial number, and the date of purchase in the spaces provided below and retain this manual as a permanent record of your purchase.

Model

Serial No.

Purchase Date

PLEASE KEEP THIS MANUAL

FCC INFORMATION (U.S.A.)

1. IMPORTANT NOTICE: DO NOT MODIFY THIS UNIT!

This product, when installed as indicated in the instructions contained in this manual, meets FCC requirements. Modifications not expressly approved by Yamaha may void your authority, granted by the FCC, to use the product.

2. IMPORTANT: When connecting this product to accessories and/or another product use only high quality shielded cables. Cable/s supplied with this product MUST be used. Follow all installation instructions. Failure to follow instructions could void your FCC authorization to use this product in the USA.

3. NOTE: This product has been tested and found to comply with the requirements listed in FCC Regulations, Part 15 for Class "B" digital devices. Compliance with these requirements provides a reasonable level of assurance that your use of this product in a residential environment will not result in harmful interference with other electronic devices. This equipment generates/uses radio frequencies and, if not installed and used according to the instructions found in the users manual, may cause interference harmful to the operation of other electronic devices. Compliance with FCC regulations does

not guarantee that interference will not occur in all installations. If this product is found to be the source of interference, which can be determined by turning the unit "OFF" and "ON", please try to eliminate the problem by using one of the following measures:

Relocate either this product or the device that is being affected by the interference.

Utilize power outlets that are on different branch (circuit breaker or fuse) circuits or install AC line filter/s.

In the case of radio or TV interference, relocate/reorient the antenna. If the antenna lead-in is 300 ohm ribbon lead, change the lead-in to co-axial type cable.

If these corrective measures do not produce satisfactory results, please contact the local retailer authorized to distribute this type of product. If you can not locate the appropriate retailer, please contact Yamaha Corporation of America, Electronic Service Division, 6600 Orangethorpe Ave, Buena Park, CA90620

The above statements apply ONLY to those products distributed by Yamaha Corporation of America or its subsidiaries.

* This applies only to products distributed by YAMAHA CORPORATION OF AMERICA.

(class B)

OBSERVERA!

Apparaten kopplas inte ur växelströmskällan (nätet) så länge som den är ansluten till vägguttaget, även om själva apparaten har stängts av.

ADVARSEL: Netspændingen til dette apparat er IKKE afbrudt, så længe netledningen sidder i en stikkontakt, som er tændt — også selvom der er slukket på apparatets afbryder.

VAROITUS: Laitteen toisiopiiriin kytketty käyttökyltkin ei irroita koko laitetta verkosta.

(standby)

This product contains a high intensity lamp that contains a small amount of mercury. Disposal of this material may be regulated due to environmental considerations. For disposal information in the United States, refer to the Electronic Industries Alliance web site: www.eiae.org

* This applies only to products distributed by YAMAHA CORPORATION OF AMERICA.

(mercury)

IMPORTANT NOTICE FOR THE UNITED KINGDOM Connecting the Plug and Cord

IMPORTANT. The wires in this mains lead are coloured in accordance with the following code:

BLUE : NEUTRAL
BROWN : LIVE

As the colours of the wires in the mains lead of this apparatus may not correspond with the coloured markings identifying the terminals in your plug proceed as follows:

The wire which is coloured BLUE must be connected to the terminal which is marked with the letter N or coloured BLACK.

The wire which is coloured BROWN must be connected to the terminal which is marked with the letter L or coloured RED.

Making sure that neither core is connected to the earth terminal of the three pin plug.

* This applies only to products distributed by Yamaha-Kemble Music (U.K.) Ltd.

(2 wires)

COMPLIANCE INFORMATION STATEMENT (DECLARATION OF CONFORMITY PROCEDURE)

Responsible Party : Yamaha Corporation of America

Address : 6600 Orangethorpe Ave., Buena Park, Calif.
90620

Telephone : 714-522-9011

Type of Equipment : Digital Keyboard

Model Name : PSR-S550/S550B

This device complies with Part 15 of the FCC Rules.

Operation is subject to the following two conditions:

- 1) this device may not cause harmful interference, and
- 2) this device must accept any interference received including interference that may cause undesired operation.

See user manual instructions if interference to radio reception is suspected.

* This applies only to products distributed by YAMAHA CORPORATION OF AMERICA.

(FCC DoC)

PRECAUTIONS

PLEASE READ CAREFULLY BEFORE PROCEEDING

* Please keep this manual in a safe place for future reference.



WARNING

Always follow the basic precautions listed below to avoid the possibility of serious injury or even death from electrical shock, short-circuiting, damages, fire or other hazards. These precautions include, but are not limited to, the following:

Power supply/AC power adaptor

- Only use the voltage specified as correct for the instrument. The required voltage is printed on the name plate of the instrument.
- Use the specified adaptor (PA-301/PA-300B/PA-300 or an equivalent recommended by Yamaha) only. Using the wrong adaptor can result in damage to the instrument or overheating.
- Check the electric plug periodically and remove any dirt or dust which may have accumulated on it.
- Do not place the AC adaptor cord near heat sources such as heaters or radiators, and do not excessively bend or otherwise damage the cord, place heavy objects on it, or place it in a position where anyone could walk on, trip over, or roll anything over it.

Do not open

- Do not open the instrument or attempt to disassemble the internal parts or modify them in any way. The instrument contains no user-serviceable parts. If it should appear to be malfunctioning, discontinue use immediately and have it inspected by qualified Yamaha service personnel.

Water warning

- Do not expose the instrument to rain, use it near water or in damp or wet conditions, or place containers on it containing liquids which might spill into any openings. If any liquid such as water seeps into the instrument, turn off the power immediately and unplug the power cord from the AC outlet. Then have the instrument inspected by qualified Yamaha service personnel.
- Never insert or remove an electric plug with wet hands.

Fire warning

- Do not put burning items, such as candles, on the unit. A burning item may fall over and cause a fire.

If you notice any abnormality

- If the AC adaptor cord or plug becomes frayed or damaged, or if there is a sudden loss of sound during use of the instrument, or if any unusual smells or smoke should appear to be caused by it, immediately turn off the power switch, disconnect the adaptor plug from the outlet, and have the instrument inspected by qualified Yamaha service personnel.



CAUTION

Always follow the basic precautions listed below to avoid the possibility of physical injury to you or others, or damage to the instrument or other property. These precautions include, but are not limited to, the following:

Power supply/AC power adaptor

- When removing the electric plug from the instrument or an outlet, always hold the plug itself and not the cord.
- Unplug the AC power adaptor when not using the instrument, or during electrical storms.
- Do not connect the instrument to an electrical outlet using a multiple-connector. Doing so can result in lower sound quality, or possibly cause overheating in the outlet.

Location

- Do not expose the instrument to excessive dust or vibrations, or extreme cold or heat (such as in direct sunlight, near a heater, or in a car during the day) to prevent the possibility of panel disfiguration or damage to the internal components.
- Do not use the instrument in the vicinity of a TV, radio, stereo equipment, mobile phone, or other electric devices. Otherwise, the instrument, TV, or radio may generate noise.

- Do not place the instrument in an unstable position where it might accidentally fall over.
- Before moving the instrument, remove all connected adaptor and other cables.
- When setting up the product, make sure that the AC outlet you are using is easily accessible. If some trouble or malfunction occurs, immediately turn off the power switch and disconnect the plug from the outlet. Even when the power switch is turned off, electricity is still flowing to the product at the minimum level. When you are not using the product for a long time, make sure to unplug the power cord from the wall AC outlet.
- Use only the stand specified for the instrument. When attaching the stand or rack, use the provided screws only. Failure to do so could cause damage to the internal components or result in the instrument falling over.

Connections

- Before connecting the instrument to other electronic components, turn off the power for all components. Before turning the power on or off for all components, set all volume levels to minimum. Also, be sure to set the volumes of all components at their minimum levels and gradually raise the volume controls while playing the instrument to set the desired listening level.

Maintenance

- When cleaning the instrument, use a soft, dry cloth. Do not use paint thinners, solvents, cleaning fluids, or chemical-impregnated wiping cloths.

Handling caution

- Do not insert a finger or hand in any gaps on the instrument.
- Never insert or drop paper, metallic, or other objects into the gaps on the panel or keyboard. If this happens, turn off the power immediately and unplug the power cord from the AC outlet. Then have the instrument inspected by qualified Yamaha service personnel.
- Do not place vinyl, plastic or rubber objects on the instrument, since this might discolor the panel or keyboard.
- Do not rest your weight on, or place heavy objects on the instrument, and do not use excessive force on the buttons, switches or connectors.
- Do not use the instrument or headphones for a long period of time at a high or uncomfortable volume level, since this can cause permanent hearing loss. If you experience any hearing loss or ringing in the ears, consult a physician.

Saving data

Saving and backing up your data

- The panel settings and some other types of data are not retained in memory when you turn off the power to the instrument. Save data you want to keep to the Registration Memory (page 85).

Saved data may be lost due to malfunction or incorrect operation. Save important data to a USB storage device/external device such as a computer (page 98).

Backing up the USB storage device/external media

- To protect against data loss through media damage, we recommend that you save your important data onto two USB storage devices/external media.

Yamaha cannot be held responsible for damage caused by improper use or modifications to the instrument, or data that is lost or destroyed.

Always turn the power off when the instrument is not in use.

Even when the power switch is in the "STANDBY" position, electricity is still flowing to the instrument at the minimum level. When you are not using the instrument for a long time, make sure you unplug the AC power adaptor from the wall AC outlet.

The illustrations and LCD screens as shown in this owner's manual are for instructional purposes only, and may appear somewhat different from those on your instrument.

● Trademarks

- The bitmap fonts used in this instrument have been provided by and are the property of Ricoh Co., Ltd.
- Windows is the registered trademarks of Microsoft® Corporation.
- The company names and product names in this Owner's Manual are the trademarks or registered trademarks of their respective companies.

This product incorporates and bundles computer programs and contents in which Yamaha owns copyrights or with respect to which it has license to use others' copyrights. Such copyrighted materials include, without limitation, all computer software, style files, MIDI files, WAVE data, musical scores and sound recordings. Any unauthorized use of such programs and contents outside of personal use is not permitted under relevant laws. Any violation of copyright has legal consequences. **DON'T MAKE, DISTRIBUTE OR USE ILLEGAL COPIES.**

Copying of the commercially available musical data including but not limited to MIDI data and/or audio data is strictly prohibited except for your personal use.

Logos



GM System Level 1

“GM System Level 1” is an addition to the MIDI standard which ensures that any GM-compatible music data can be accurately played by any GM-compatible tone generator, regardless of manufacturer. The GM mark is affixed to all software and hardware products that support GM System Level.



XG

XG is a major enhancement of the GM System Level 1 format, and was developed by Yamaha specifically to provide more Voices and variations, as well as greater expressive control over Voices and effects, and to ensure compatibility of data well into the future.



XF

The Yamaha XF format enhances the SMF (Standard MIDI File) standard with greater functionality and open-ended expandability for the future. The instrument is capable of displaying lyrics when an XF file containing lyric data is played.



STYLE FILE

The Style File Format is Yamaha's original style file format which uses a unique conversion system to provide high-quality automatic accompaniment based on a wide range of chord types.



USB

USB is an abbreviation for Universal Serial Bus. It is a serial interface for connecting a computer with peripheral Devices. It allows “hot swapping” (connecting peripheral devices while the power to the computer is on).

Congratulations and thank you for purchasing the Yamaha PSR-S550!

Please read this owner's manual carefully before using the instrument in order to take full advantage of its various features.

Make sure to keep this manual in a safe and handy place even after you finish reading, and refer to it often when you need to better understand an operation or function.

Accessories

The instrument package includes the following items. Please check that you have them all.

- Music rest
- Accessory CD-ROM
- Owner's manual (this book)
- AC Power Adaptor (May not be included depending on your particular area. Please check with your Yamaha dealer.)

Special Features of the PSR-S550

■ Play a Variety of Instrument Voices ▶ Page 17

The instrument voice that sounds when you play the keyboard can be changed to violin, flute, harp, or any of an extensive range of Voices. You can change the mood of a Song written for piano, for example, by using violin to play it instead. Experience a whole new world of musical variety.



■ Play Along with Styles ▶ Page 23

Want to play with full accompaniment? Try the auto-accompaniment Styles. The accompaniment styles provide the equivalent of a full backing band covering wide variety of Styles from waltzes to 8-beat to samba ... and much more. What's more, you can create and save your own original Styles for even greater versatility.

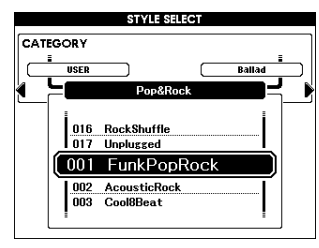

■ Save and Recall Panel Settings to Registration Memory ▶ Page 77

This convenient function lets you save a 'snapshot' of your custom panel settings—up to 64 complete “Registrations.” These can be called up instantly any time you need them—perfect for making broad sound/effect changes when playing live!

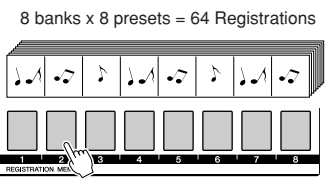

■ Easy Performance with Music Notation Display ▶ Page 30

When you play back a Song, the corresponding score will be shown on the display as the Song plays. This is a great way to learn how to read music. If the Song contains lyric and chord data*, the lyrics and chords will also appear on the score display.

* No lyrics or chords will appear on the display if the Song you are using with the score display function does not contain the appropriate lyric and chord data.

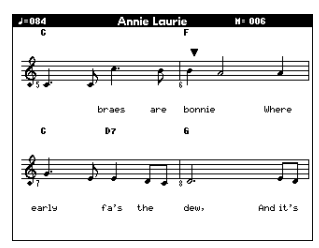

■ Save and Load Data to USB Flash Memory or Computer ▶ Pages 83 and 94

These data organization tools let you store your original User Songs or custom panel settings (Registration Memory) to a USB Flash Memory device or a computer, then load the data back to the instrument as needed.

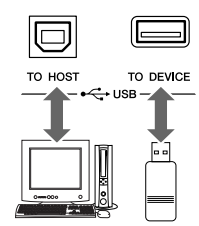

Contents

Logos.....	6
Accessories	7
Special Features of the PSR-S550	8
Setting Up	10
Power Requirements.....	10
Connecting Headphones (PHONES/OUTPUT Jack)	10
Connecting a Footswitch (SUSTAIN Jack).....	10
Connecting to a Computer (USB Terminal).....	11
Turning the Power On	11
Changing the Display language	12
Adjusting the LCD CONTRAST control.....	12
Panel Controls and Terminals	14
Front Panel.....	14
Rear Panel	15

Quick Guide

Playing Songs	16
Try playing a variety of Instrument Voices	17
Select and Play a Voice	17
Playing Two Voices Simultaneously—DUAL.....	18
Playing Different Voices with the Left and Right Hands —LEFT	19
Playing Drum Kits	21
Playing Styles	22
Select a Styles Rhythm	22
Playing Along with a Style	23
Playing Auto-accompaniment Chords	25
Playing with the Music Database	26
Using Songs	27
Selecting and Listening to a Song.....	27
Song Fast Forward, Fast Reverse, and Pause	28
Types of Songs	29
Displaying the Song Score	30
Displaying the Lyrics.....	31
Recording Your Own Performance	32
Track Configuration	32
Quick Recording Procedure	33
Multi-track Recording Procedure.....	34
Song Clear—Deleting User Songs.....	37
Track Clear—Deleting a Specified Track From a User Song.....	38

Backup and Initialization	39
Backup	39
Initialization.....	39
Basic Operation and Displays	40
Basic Operation.....	40
The Displays.....	42
MAIN Display Items.....	43

Reference

Playing with the Effects	44
Adding Harmony.....	44
Changing the Reverb Type	45
Changing the Chorus Type	46
Panel Sustain	47
Adding DSP	47
Pitch Bend	48
Using Various Functions	49
Playing with the metronome	49
Using Tap Start	51
Touch Response	51
EQ settings.....	52
Pitch Controls	53
Changing the pitch of the instrument in octaves	54

Style (Auto Accompaniment) Functions	55
Pattern Variation (sections)	55
One Touch Setting.....	58
Variation Change and OTS (OTS LINK).....	58
Setting the Split Point	59
Playing a Style with Chords but without Rhythm (Stop Accompaniment)	60
Adjusting the Style Volume.....	60
Chord Basics	61
User Style	63
Playing Styles Using the Entire Keyboard	63
Creating Original Styles (Style Creator)	64
Style Structure	64
Main Display of the Style Creator	64
Follow the Style Creator instructions.	65
Basic Operation	66
Parameter Settings, Recording and Saving	67
Song Settings	72
Song Volume	72
Changing the Tempo	72
A-B Repeat	73
Muting Independent Song Parts	74
MIXER	75
Mixer Display	75
Basic operation.....	75
Track ON/OFF and other parameter controls.....	76
Memorize Your Favorite Panel Settings	77
Saving to the Registration Memory	77
Recalling a Registration Memory.....	78
Registration Clear—Deleting a Specified Registration Memory.....	79
The Functions	80
Selecting and Setting Functions	80
Using USB Flash Memory	83
Using USB Flash Memory	83
Formatting USB Flash Memory	84
Saving the Registration Data.....	85
Saving a User Song or User Style.....	86
Loading Registration Files, Style Files, Song Files or MDB Files	87
Deleting Data from USB Flash Memory	88
Playing Songs or Styles Saved to USB Flash Memory	89
Connections	90
Connectors	90
Connection to a USB Storage Device	90
Connecting a Personal Computer	92
Transferring Performance Data to and from a Computer	94
Initial Send.....	95
Transferring Data Between the Computer and Instrument.....	96
Accessory CD-ROM Installation Guide	99
Important Notices about the CD-ROM.....	99
Contents of the CD-ROM	100
Software Installation	101

Appendix

Troubleshooting.....	107
Messages	108
Voice List.....	110
Drum Kit List	116
Style List	121
Music Database List	122
Voice Effect Type List.....	125
MIDI Implementation Chart.....	132
MIDI Data Format	134
Specifications	135
Index.....	136



Setting Up

Be sure to do the following operations **BEFORE** turning on the power.

Power Requirements

- 1 Make sure that the [STANDBY/ON] switch of the instrument is set to STANDBY.

⚠ WARNING

- Use **ONLY** a Yamaha PA-301/PA-300B/PA-300 AC Power Adaptor (or other adaptor specifically recommended by Yamaha) to power your instrument from the AC mains. The use of other adaptors may result in irreparable damage to both the adaptor and the instrument.

- 2 Connect the power adaptor's DC plug to the power supply jack.

- 3 Plug the AC adaptor into an AC outlet.

⚠ CAUTION

- Unplug the AC Power Adaptor when not using the instrument, or during electrical storms.

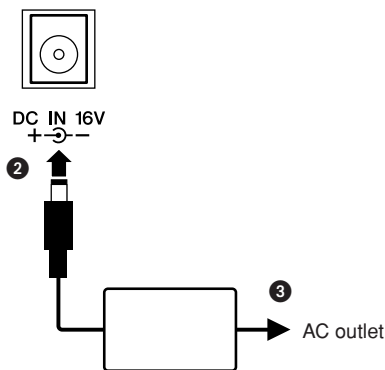

Make all necessary connections below **BEFORE** turning the power on.

Connecting Headphones (PHONES/OUTPUT Jack)

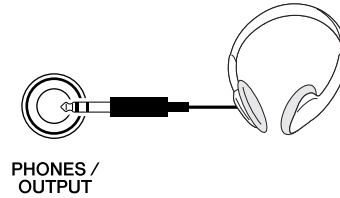

The instrument speakers are automatically shut off when a plug is inserted into this jack. The PHONES/OUTPUT jack also functions as an external output. You can connect the PHONES/OUTPUT jack to a keyboard amplifier, stereo system, mixer, tape recorder, or other line-level audio device to send the instrument's output signal to that device.

⚠ WARNING

- Avoid listening with the headphones at high volume for long periods of time; doing so may not only result in ear fatigue, it may be damaging to your hearing.

⚠ CAUTION

- To prevent damage to the speakers, set the volume of the external devices at the minimum setting before connecting them. Failure to observe these cautions may result in electric shock or equipment damage. Also, be sure to set the volumes of all devices at their minimum levels and gradually raise the volume controls while playing the instrument to set the desired listening level.

Connecting a Footswitch (SUSTAIN Jack)

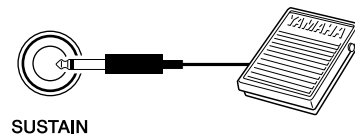

The sustain function lets you produce a natural sustain as you play by pressing a footswitch. Plug the Yamaha FC4 or FC5 footswitch into this jack and use it to switch sustain on and off.

NOTE

- Make sure that the footswitch plug is properly connected to the SUSTAIN jack before turning on the power.
- Do not press the footswitch while turning the power on. Doing this changes the recognized polarity of the footswitch, resulting in reversed footswitch operation.

Connecting to a Computer (USB Terminal)

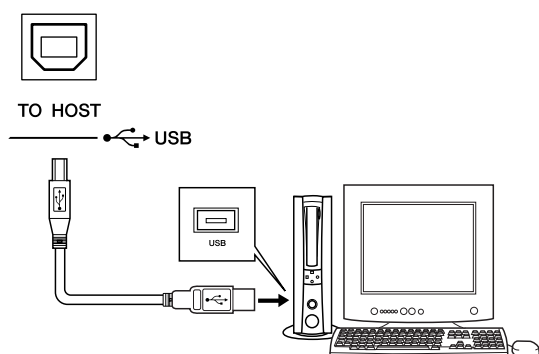

Connect the instrument's USB terminal to the USB terminal of a computer, and you can transfer performance data and Song files between the two (page 96). To use the USB data-transfer features you'll need to do the following:

- First, make sure the POWER switch on the instrument is set to OFF, then use a USB cable to connect the instrument to the computer. After making the connections, turn the instrument's power on.
- Install the USB MIDI driver on your computer from CD-ROM (see page 101).
- Install the MusicSoft downloader on your computer from the website (see page 103)

Turning the Power On

Turn down the volume by turning the [MASTER VOLUME] control to the left and press the [STANDBY/ON] switch to turn on the power. Press the [STANDBY/ON] switch again to turn the power OFF.

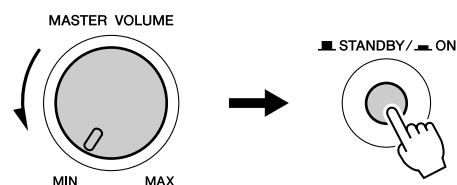

Backup data in the flash memory is loaded to the instrument when the power is turned on. If no backup data exists on flash memory, all instrument settings are restored to the initial factory defaults when the power is turned on.

CAUTION

- Even when the switch is in the "STANDBY" position, electricity is still flowing to the instrument at the minimum level. When you are not using the instrument for a long time, make sure you unplug the AC power adaptor from the wall AC outlet.

CAUTION

- Never attempt to turn the power off when a "Writing.." message is shown in the display. Doing so can damage the flash memory and result in a loss of data.

Changing the Display language

This instrument allows you to select English or Japanese as the display language. The default display language is English, but if you switch to Japanese the lyrics, file names and some messages will be displayed in Japanese where appropriate.

- 1 Press the [FUNCTION] button.

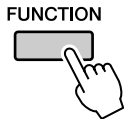

- 2 Press the CATEGORY [◀] and [▶] buttons a number of times until the “Language” item appears. The currently selected display language will appear below the “Language” item.

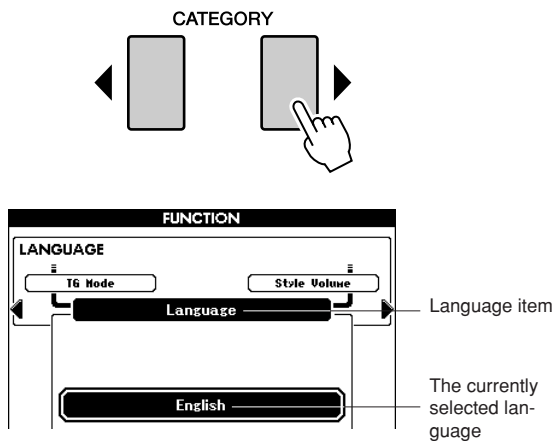

- 3 Select a display language. The [+] button selects English and the [-] button selects Japanese. The language selection will be stored in the internal flash memory so that it is retained even when the power is turned off.



- 4 Press the [EXIT] button to return to the MAIN display.

Adjusting the LCD CONTRAST control

Adjust the LCD CONTRAST control on the rear panel of the instrument for optimum display legibility.

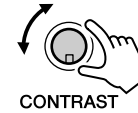

CAUTION

- Looking at the display for a long period of time in the dark may cause eyestrain or damage to your eyesight. Make sure to use the instrument with as much ambient light as possible and also take adequate breaks and rest from use.

● Music Rest

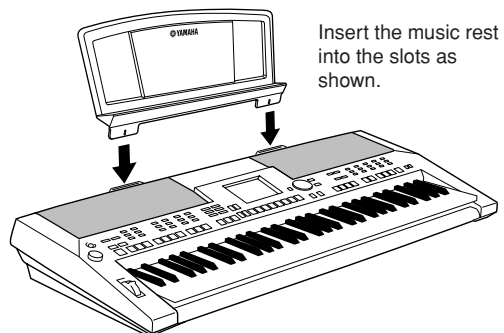

Insert the music rest into the slots as shown.



Panel Controls and Terminals

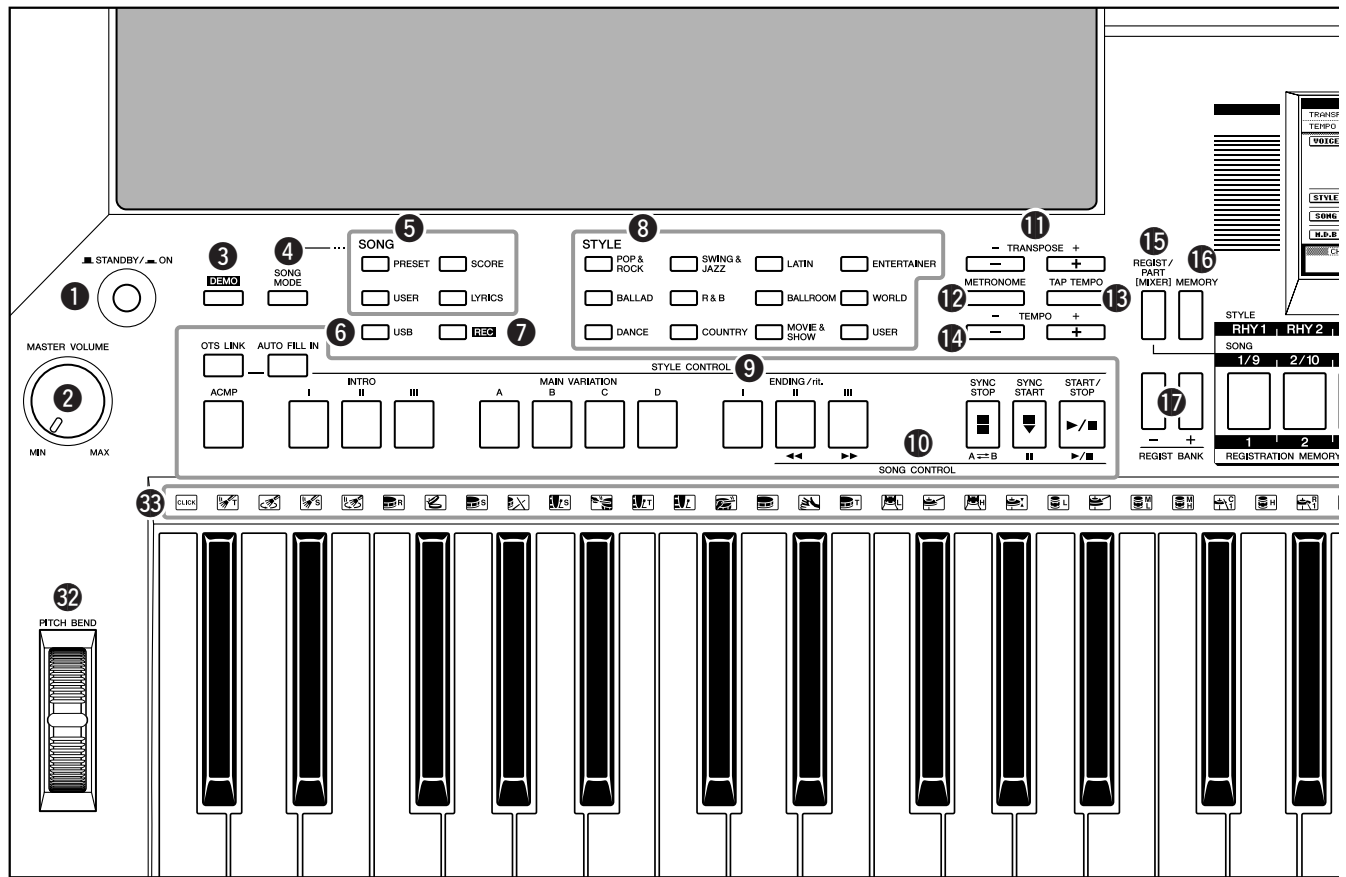

Front Panel

- ① [STANDBY/ON] switch page 16
- ② [MASTER VOLUME] control.... pages 16, 40
- ③ [DEMO] button page 16
- ④ [SONG MODE] button page 27
- ⑤ SONG
 - [PRESET], [USER] buttons page 27
 - [SCORE] button page 30
 - [LYRICS] button page 31
- ⑥ [USB] button page 27
- ⑦ [REC] button page 33
- ⑧ STYLE..... page 22
- ⑨ STYLE CONTROL
 - [OTS LINK] button page 58
 - [AUTO FILL IN] button page 55
 - [ACMP] button page 23
 - INTRO [I]–[III] buttons page 55
 - MAIN VARIATION [A]–[D] buttons
..... page 55
 - ENDING/rit. [I]–[III] buttons page 55
 - [SYNC STOP] button page 57
 - [SYNC START] button pages 23, 56
 - [START/STOP] button..... pages 22, 41
- ⑩ SONG CONTROL
 - [◀◀] button..... page 28
 - [▶▶] button page 28
 - [A ⇌ B] button page 73
 - [||] button..... page 28
 - [▶/■] button.....pages 28, 41
- ⑪ TRANSPOSE [+] and [-] buttons page 53
- ⑫ [METRONOME] button..... page 49
- ⑬ [TAP TEMPO] button page 51
- ⑭ TEMPO [+] and [-] buttons..... page 49
- ⑮ [REGIST/PART [MIXER]] button page 74
- ⑯ [MEMORY] button page 77
- ⑰ REGIST BANK [+] and [-] buttons.. page 77
- ⑱ Style Part/Song Part [1/9]–[8/16]/
REGISTRATION MEMORY [1]–[8]
buttons page 77
- ⑲ Displaypages 12, 42
- ⑳ [EXIT] button page 42
- ㉑ Dial page 41
- ㉒ [+ / YES] and [- / NO] buttons page 41

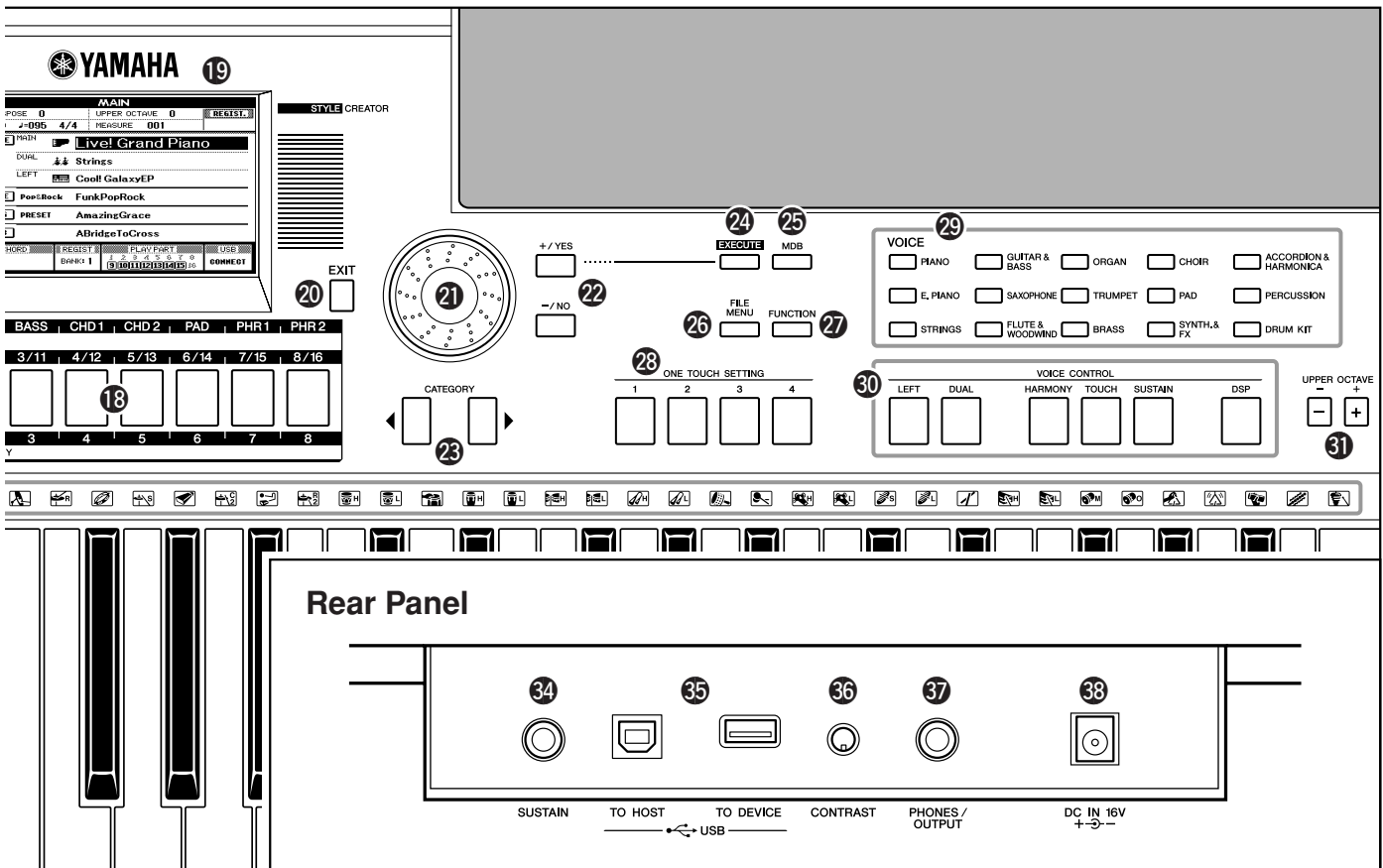

23 CATEGORY [◀] and [▶] buttons page 41

24 [EXECUTE] button page 68

25 [MDB] button page 26

26 [FILE MENU] button page 83

27 [FUNCTION] button page 80

28 ONE TOUCH SETTING [1]–[4] buttons page 58

29 VOICE page 17

30 VOICE CONTROL
 [LEFT] button page 19
 [DUAL] button page 18
 [HARMONY] button page 44
 [TOUCH] button page 51
 [SUSTAIN] button page 47
 [DSP] button page 47

31 UPPER OCTAVE [+] and [–] buttons page 54

32 [PITCH BEND] wheel page 48

33 Drum Kit page 21

Rear Panel

34 SUSTAIN jack page 10

35 USB TO HOST and TO DEVICE terminals page 90

36 CONTRAST knob page 12

37 PHONES/OUTPUT jack page 10

38 DC IN 16V jack page 10



Playing Songs

This instrument include a Demonstration Song. Let's start by playing the Demonstration Song.

1 Press the [STANDBY/ON] button until it locks in the ON position.

The Main display appears in the LCD.

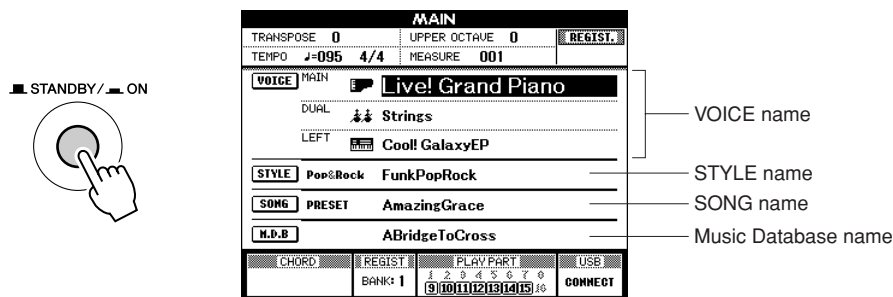

2 Press the [DEMO] button to start the Demo.

The Demo display appears in the LCD.

Gradually raise the [MASTER VOLUME] control while playing the instrument to set the desired listening level.

The Demo Song will restart when playback reaches the end.



3 Press the [▶/■] button to stop Demo.

Operation automatically returns to the Main display.

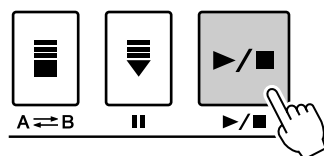

NOTE

- The [DEMO] button doesn't function when the Demo Cancel function is set to enable. (See page 82.)



Try playing a variety of Instrument Voices

In addition to piano, organ, and other “standard” keyboard instruments, this instrument has a large range of realistic Voices—including guitar, bass, strings, sax, trumpet, drums and percussion, sound effects, and a wide variety of other musical sounds.

Select and Play a Voice

In this operation, you’ll select a Main Voice and play it on the keyboard.

1 Select and press the desired Voice category button in the Voice section.

The Main Voice selection display will appear.

The currently selected category name, Voice number and name will be highlighted.

For this example, select the “Flute&Woodwind” category.

NOTE

- To change the Voice category, press another category button.

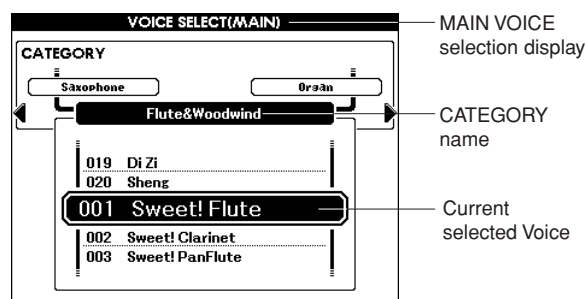
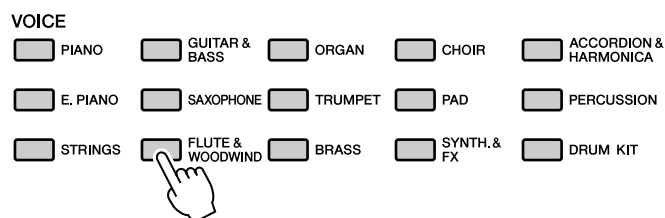

2 Select the Voice you want to play.

Look at the highlighted Voice name and rotate the dial. The available Voices will be selected and displayed in sequence. The Voice selected here becomes the Main Voice.

For this example, select the “010 Flute” Voice.

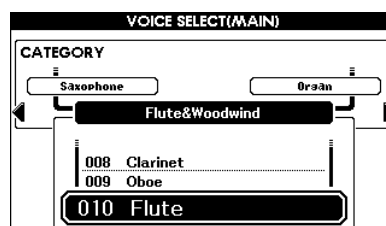
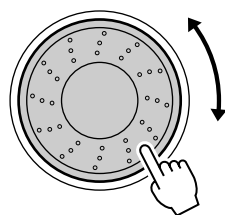

3 Play the keyboard.

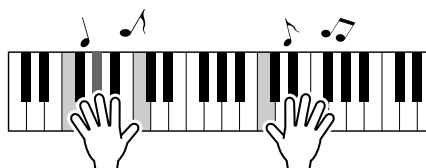

Try selecting and playing a variety of Voices.
Press the [EXIT] button to return to the MAIN display.

Playing Two Voices Simultaneously—DUAL

This lets you select a second Voice which you can play in addition to the Main Voice. The second Voice is known as the “Dual” Voice.

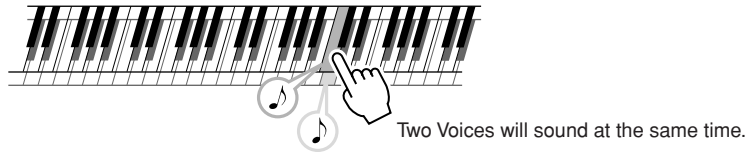

1 Press the [DUAL] button.

The [DUAL] button turns the Dual Voice on or off. When Dual Voice is turned on, the [DUAL] button is lit. The currently selected Dual Voice will sound in addition to the Main Voice when you play the keyboard.

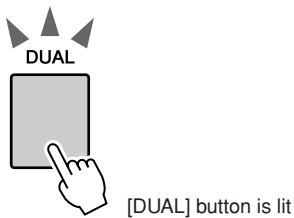

2 Press and hold the [DUAL] button for longer than a second.

The Dual Voice selection display appears. The currently selected category name, Voice number and name will be highlighted.

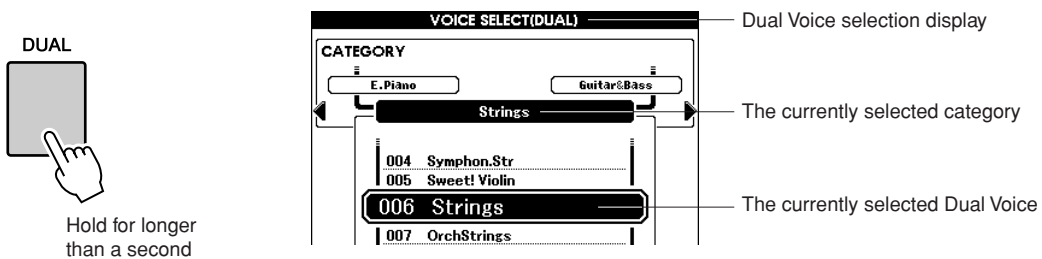

3 Select and press the desired Voice category button in the Voice section.

For this example, select the “Percussion” category.

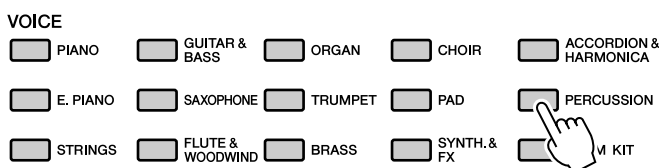

4 Select the Voice you want to play.

Look at the highlighted Voice name and rotate the dial. The available Voices will be selected and displayed in sequence. The Voice selected here becomes the Dual Voice.

For this example, select the “003 Marimba” Voice.



5 Play the keyboard.

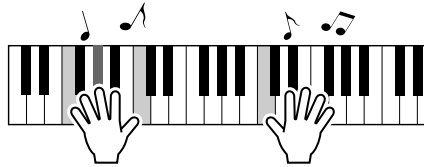

Try selecting and playing a range of Dual Voices.

Press the [EXIT] button to return to the MAIN display.

Playing Different Voices with the Left and Right Hands—LEFT

In the Left mode you can play different Voices from the keys to the left and right of the keyboard “split point.” The Main and Dual Voices can be played to the right of the split point, while the Voice played to the left of the split point is the Left Voice. The split point setting can be changed as required (page 59).

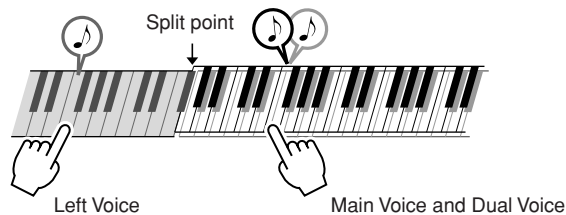

1 Press the [LEFT] button.

The [LEFT] button turns the left Voice on or off. The currently selected Left Voice will sound when you play keys to the left of the keyboard split point.

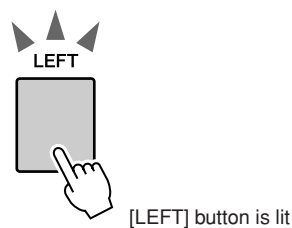

[LEFT] button is lit

2 Press and hold the [LEFT] button for longer than a second.

The LEFT Voice selection display will appear.
The currently selected category name, Voice number and name will be highlighted.

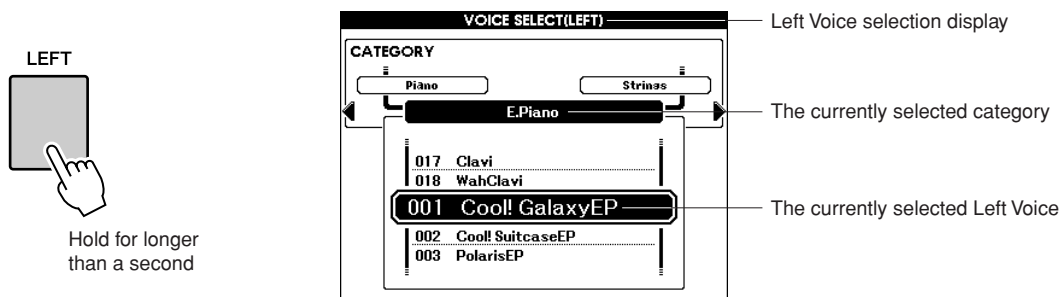

3 Select and press the desired Voice category button in the VOICE section.

For this example, select the “Guitar&Bass” category.

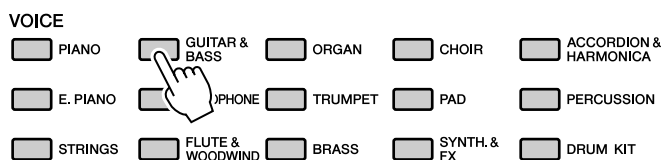

4 Select the Voice you want to play.

Look at the highlighted Voice name and rotate the dial. The available Voices will be selected and displayed in sequence. The Voice selected here becomes the Left Voice.

For this example, select the “041 FolkGuitar” Voice.

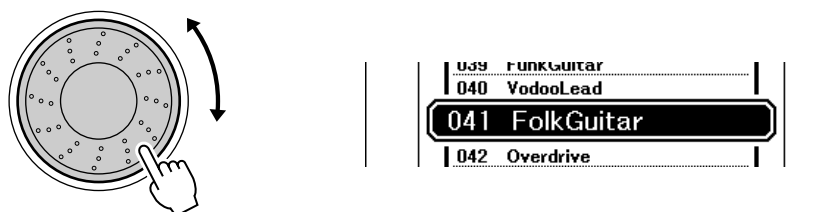

5 Play the keyboard.

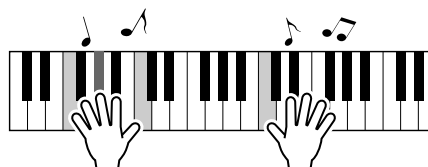

Try playing the selected Left Voice.

Press the [EXIT] button to return to the MAIN display.

Playing Drum Kits

Drum Kits are collections of drum and percussion instruments. When you select a violin or other normal instrument—as a Main Voice, for example—all keys produce the sound of the same violin, only at different pitches. If you select a Drum Kit as the Main Voice, however, each key produces the sound of a different drum or percussion instrument.

1 Press the [DRUM KIT] button.
The “Drum Kit” category appears.

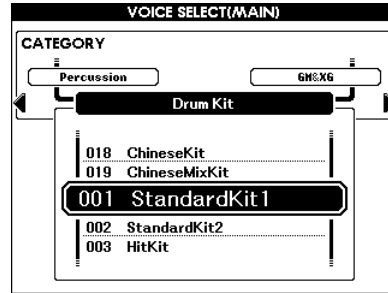
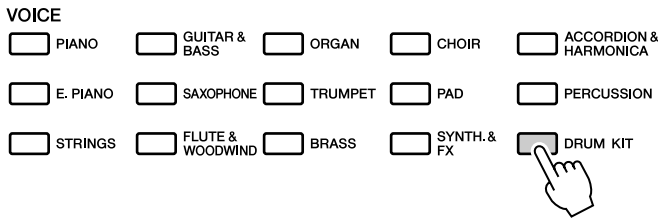

2 Rotate the dial and select the Drum Kit you want to play (001–019).

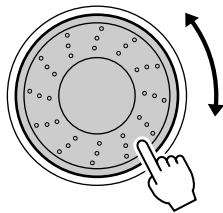

Drum Kits List

Voice No.	Drum Kit name	Voice No.	Drum Kit name	Voice No.	Drum Kit name	Voice No.	Drum Kit name
001	Standard Kit1	006	Room Kit	011	Symphony Kit	016	Arabic Mixture Kit
002	Standard Kit2	007	Rock Kit	012	Cuban Kit	017	Indian Kit
003	Hit Kit	008	Electro Kit	013	PopLatin Kit	018	Chinese Kit
004	Jazz Kit	009	Analog Kit	014	Arabic Kit	019	Chinese Mixture Kit
005	Brush Kit	010	Dance Kit	015	Arabic Kit2		

3 Play each key and enjoy the Drum Kit.
A good Drum Kit to start out with is 001, Standard Kit 1.

NOTE
• See the Drum Kit List on page 116.

Example: 001 Standard Kit 1

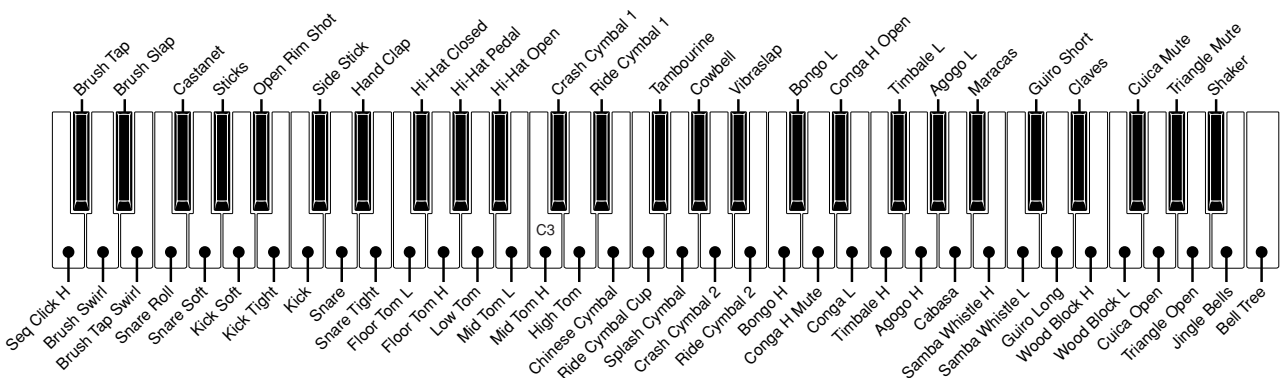



Playing Styles

This instrument includes an auto-accompaniment feature that plays appropriate “Styles” (rhythm + bass + chord accompaniment) when you play left-hand chords.

You can select from 176 different Styles covering a range of musical genres and time signatures (see page 121 for a complete list of the available Styles). You can also select from the original Styles you’ve created on your own. Here’s how you can use the auto-accompaniment feature.

Select a Styles Rhythm

Most Styles include a rhythm part. You can select from a wide variety of rhythmic types—rock, blues, samba, and many, many more. Let’s begin by listening to just the basic rhythm. The rhythm part is played using percussion instruments only.

1 Select and press the desired Style category button in the Style section.

The Style selection display appears.

The currently selected category name, Voice number and name will be highlighted.

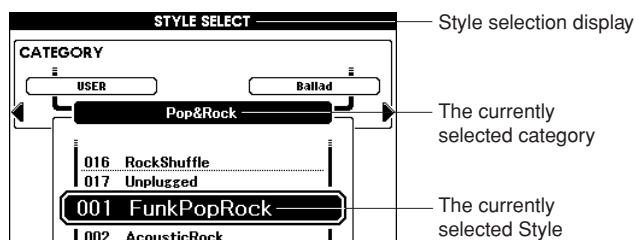
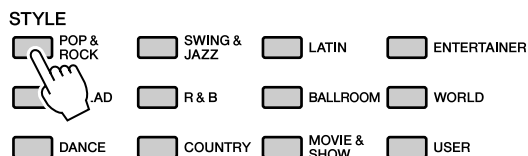

Your created Styles are stored to the [USER] button.

2 Select the Style you want to play.

Look at the highlighted Style name and rotate the dial. The available Styles will be selected and displayed in sequence.

See the Style list on page 121.

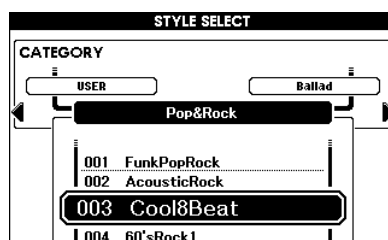
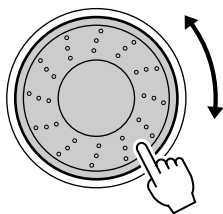

3 Press the [START/STOP] button.

The Style rhythm will start playing.

To stop playback, press the [START/STOP] button again.

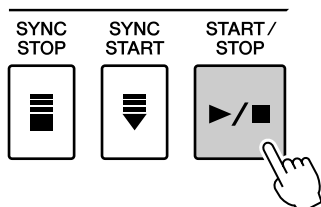

Playing Along with a Style

You learned how to select a Style rhythm on the preceding page.

Here we'll see how to add bass and chord accompaniment to the basic rhythm to produce a full, rich accompaniment that you can play along with.

1 Select and press the desired Style category button in the Style section.

Press the [EXIT] button to return to the Main display.

2 Turn automatic accompaniment on.

Press the [ACMP] button.

Pressing this button a second time will turn automatic accompaniment off.

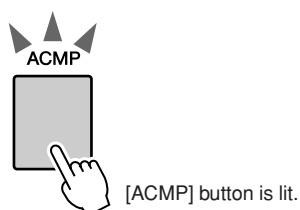

● When automatic accompaniment is on ...

The area of the keyboard to the left of the split point (54: F#2) becomes the "auto accompaniment region" and is used only for specifying the accompaniment chords.

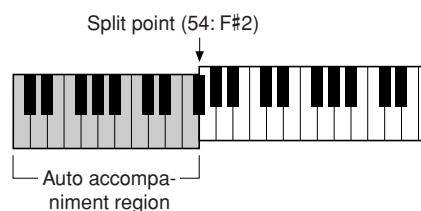

NOTE

- The Split point can be changed as required; refer to page 59.

3 Turn Sync Start on.

Press the [SYNC START] button to turn the Sync Start function on.

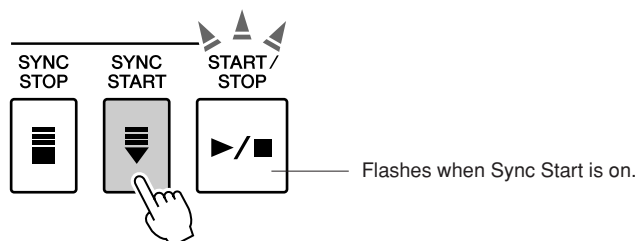

When Sync Start is on, the bass and chord accompaniment included in a Style will start playing as soon as you play a note to left of the keyboard split point. To cancel or disable Sync Start, press the button a second time to turn the Sync Start function off.

4 Play a left-hand chord to start the Style.

You can still “play” chords even if you don’t actually know any chords. This instrument will recognize even a single note as a chord. Try playing from one to three notes at the same time to the left of the split point. The chord will change according to the left-hand notes you play.

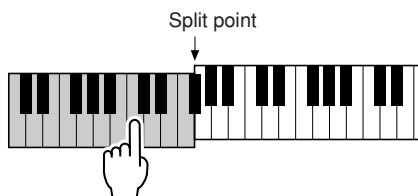

5 Play a variety of left-hand chords while playing a melody with your right hand.

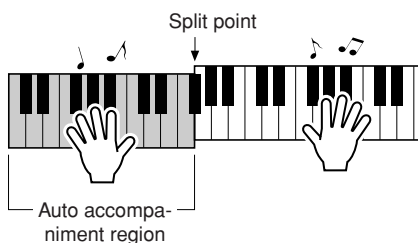

6 Press the [START/STOP] button to stop Style playback when you’re done.

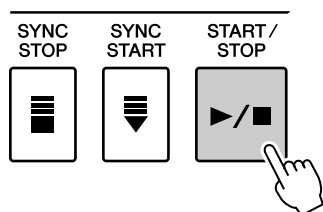

You can switch Style “sections” to add variety to the accompaniment. Refer to “Pattern Variation (sections)” on page 55.

Playing Auto-accompaniment Chords

There are two ways of playing auto-accompaniment chords:

- **Easy Chords**
- **Standard Chords**

The instrument will automatically recognize the different chord types.

The keyboard to the left of the split point (default: 54/F#2) becomes the “accompaniment range.” Play the accompaniment chords in this area of the keyboard.

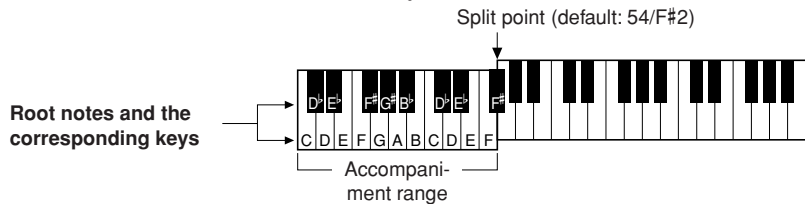

■ Easy Chords

This method lets you easily play chords in the accompaniment range of the keyboard using only one, two, or three fingers.

	<p>C</p> <ul style="list-style-type: none"> • To play a major chord Press the root note of the chord.
	<p>Cm</p> <ul style="list-style-type: none"> • To play a minor chord Press the root note together with the nearest black key to the left of it.
	<p>C7</p> <ul style="list-style-type: none"> • To play a seventh chord Press the root note together with the nearest white key to the left of it.
	<p>Cm7</p> <ul style="list-style-type: none"> • To play a minor seventh chord Press the root note together with the nearest white and black keys to the left of it (three keys altogether).

■ Standard Chords

This method lets you produce accompaniment by playing chords using normal fingerings in the accompaniment range of the keyboard.

● **How to play Standard Chords [Example for “C” chords]**

* Notes enclosed in parentheses () are optional; the chords will be recognized without them.

● **Multi Fingering and Full Keyboard**

These let you select the accompaniment section of the keyboard for chord playing. (See the “Chord Fingering” section in the Function Setting List on page 81.)

Multi Fingering: As explained above, the keys to the left of the split point (default: 54, F#2) become the accompaniment range. This method lets you play the accompaniment chords in the specified area of the keyboard, and is set as the default for the instrument.

Full Keyboard: This lets you play the accompaniment chords freely from anywhere on the keyboard.



Playing with the Music Database

You want to play music in your favorite Style, but you're not sure how to select the best Voice and Style for the type of music you want to play, simply select the appropriate Style from the Music Database. The panel settings will automatically be adjusted for the ideal combination of sounds and Style!

1 Press the [MDB] button.

The music database selection display will appear. The currently selected category name, MDB number and name will be highlighted.

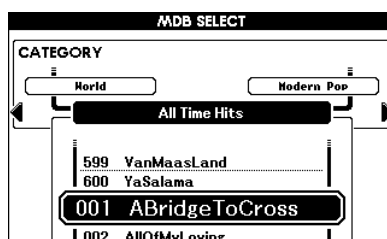
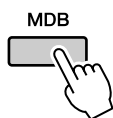

2 Select the desired Music Database which matches the music style or type you want to play.

Press [◀], [▶] category button when changing the MDB category. Referring to the Music Database List on page 122 of the manual, use the dial to select a music database. Select one that matches the music style of the Song you intend to play. For this example select "315 BigKissForDream" in the Swing category.

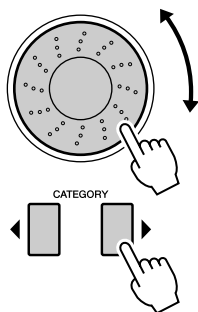

3 Play the chords with your left hand and the melody with your right.

The swing Style will start playing when you play a left-hand chord to the left of the split point (page 23). Refer to page 25 for information about playing chords.

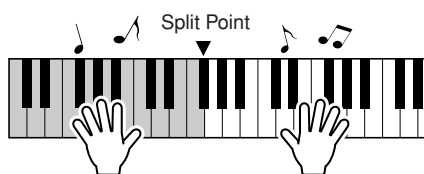

You can check the assigned Voice and Style at this point by pressing the [EXIT] button to return to the MAIN display.

4 Press the [▶/■] button to stop playback.



Using Songs

With this instrument the term “Song” refers the data that makes up a piece of music.
In this section we’ll learn how to select and play Songs.

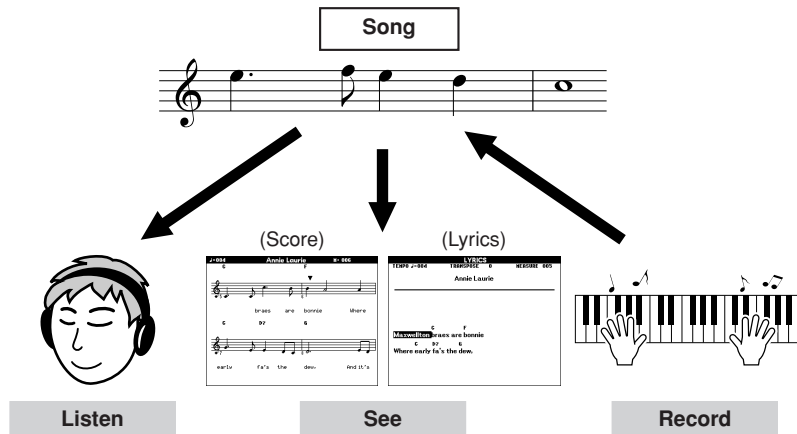

Selecting and Listening to a Song

1 Select and press one of the Song category buttons, which corresponds to the type of Song you want to listen to.

[PRESET]: Nine preset Songs are available here.

[USER] : This contains your recorded Songs and Songs loaded from USB flash memory/computer.

[USB] : This contains USB Songs when a USB flash memory device is connected to the USB TO DEVICE terminal. The file name in USB flash memory can be shown as long as you’ve saved the data to the root directory or the next two levels (see page 91).

The Song selection display will appear.

The currently selected Song number and name will be highlighted.

NOTE

- When the instrument is in the Song mode, the [SONG MODE] button is lit. When Style mode is enabled, the button is not lit.

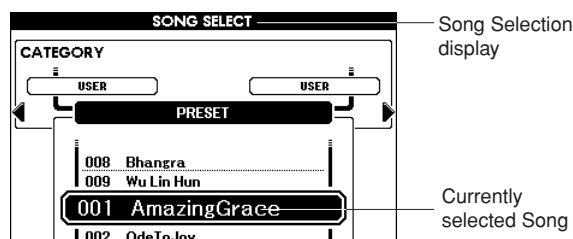
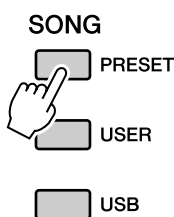
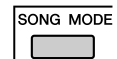

2 Select a Song.

Use the dial to select the Song you want to listen to.

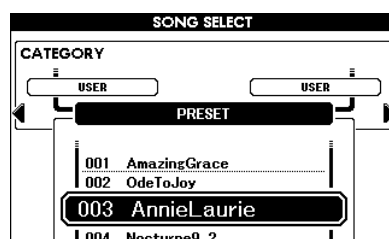
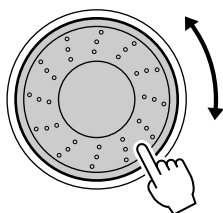

PRESET	<p>Built-in Songs</p> <ol style="list-style-type: none"> 1 Amazing Grace (Traditional) 2 OdeToJoy (L.v. Beethoven) 3 Annie Laurie (Traditional) 4 Nocturne 9-2 (Chopin) 5 Fossiles (Le Carnaval des Animaux) (C. Saint-Saëns) 6 Latin (Original) 7 Arabic (Original) 8 Bhangra (Original) 9 Wu Lin Hun (Original)
USER	User Songs (Songs you record yourself) or Songs transferred from a USB flash memory/computer (pages 96–98)
USB	Songs in a USB flash memory connected to the instrument (pages 87, 89)

3 Listen to the Song.

Press the [▶/■] button to begin playback of the selected Song. You can stop playback at any time by pressing the [▶/■] button again.

NOTE

• Some of the preset songs have been edited for length or arrangement, and may not be exactly the same as the original.

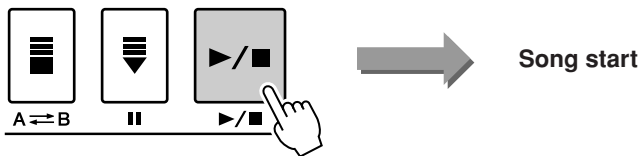

Song Fast Forward, Fast Reverse, and Pause

These are just like the transport controls on a CD player, letting you fast forward [▶▶], rewind [◀◀], and pause [||] playback of the Song.

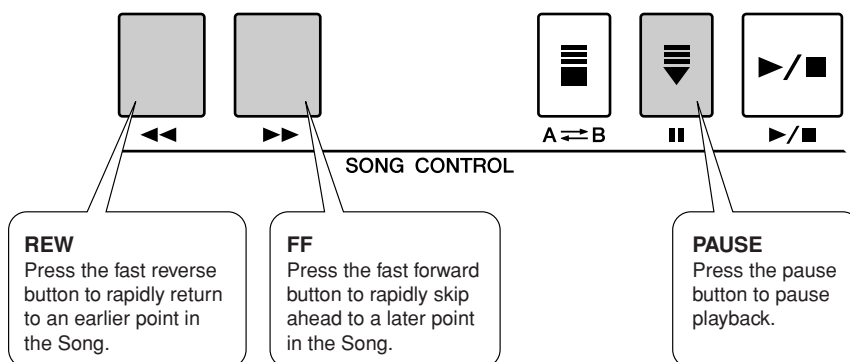

Types of Songs

The following four types of Songs can be used by this instrument.

- **Preset Songs** (the nine Songs built into the instrument)..... **Preset Song numbers 001–009.**
- **User Songs** (recordings of your own performances) **USER Song numbers 001–005.**
- **Loaded Songs** (Song data loaded from computer) **USER Song numbers 006–**
- **USB Songs** (Song data in the USB flash memory) **Song numbers**

The chart below shows the basic operation flow for using the preset Songs, user Songs, loaded Songs and USB Song from storage to playback.

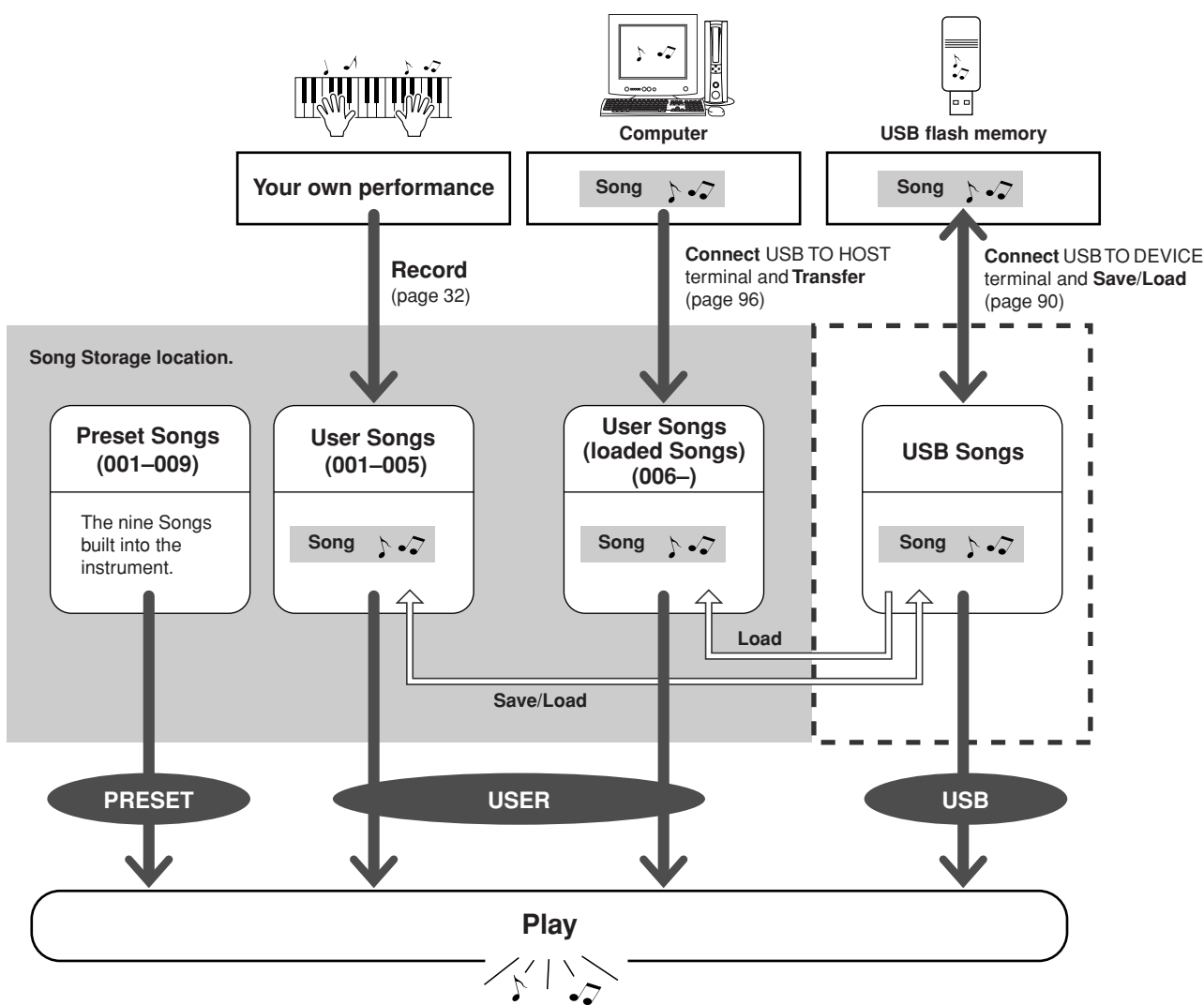

NOTE

• Different internal memory areas are used to store user Songs and loaded Song files transferred from a computer. User Songs cannot be directly transferred to the loaded Song area of the internal memory, and vice versa.

Displaying the Song Score

This instrument is capable of display the scores (notation) of Songs. Scores can also be displayed for Songs loaded from USB flash memory or computer.

1 Select a Song.

Follow steps 1 and 2 of the procedure described on page 27.

2 Press the [SCORE] button and a single-staff score will appear.

There are two types of score display: single-staff and double-staff. These are alternately selected each time the [SCORE] button is pressed.

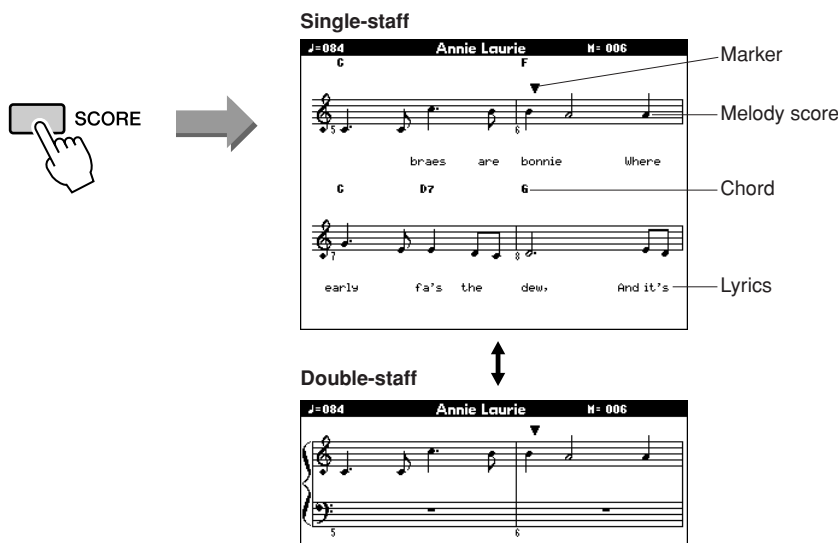

NOTE

- Both chords and lyrics will be shown in single-staff score display of a Song that includes chord and lyric data.
- When there are many lyrics in a Song, they may be displayed in two rows a measure.
- Some lyrics or chords may be abbreviated if the selected Song has a lot of lyrics.
- Small notes that are hard to read may be easier to read after you use the quantize function (page 82).

NOTE

- No lyrics are shown in double-staff display.

3 Press the [▶/■] button.

The Song will begin playing. The triangular cursor will move across the top of the score to indicate the current location.

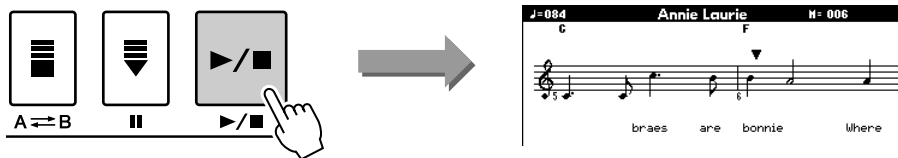

4 To return to the MAIN display, press the [EXIT] button.



Displaying the Lyrics

If a Song contains lyric data, the lyrics can be made to appear on the display.

No lyrics will be displayed for a Song that contains no lyric data, even if the [LYRICS] button is pressed.

1 Select a Song.

Follow steps 1 and 2 of the procedure described on page 27.
Try to select the Preset SONG 001 or 003.

2 Press the [LYRICS] button.

The title, lyricist, and composer of the Song will appear on the display.

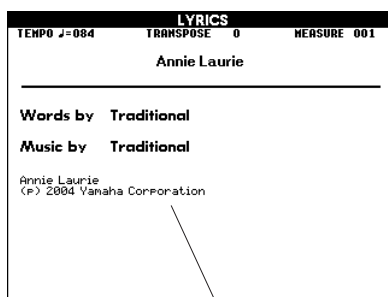

Song title, Lyricist, Composer

NOTE

- Songs downloaded from the Internet or commercially available Song files, including XF format files (page 6), are compatible with the lyrics display features as long as they are standard MIDI file format files containing lyric data. Lyrics display may not be possible with some files.

NOTE

- If the lyrics display shows garbled characters, try changing the display language (page 12).

3 Press the [▶/■] button.

The Song will play back while the lyrics and chords are shown on the display. The lyrics will be highlighted to show the current location in the Song.

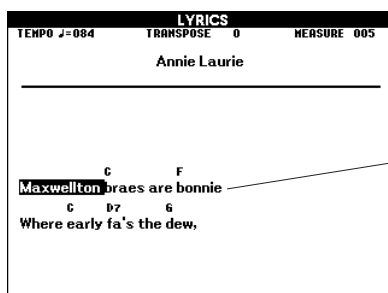
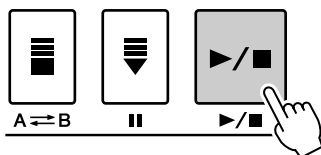

Lyrics and Chord

■ Preset Songs That Can be Used For Lyrics Display

Song No.	Song Name
001	Amazing Grace
003	Annie Laurie



Recording Your Own Performance

You can record up to five of your own performances and save them as user Songs 001 through 005. Additionally, when a Song is playing the score will be shown on the display. This is a great way to learn how to read music. If the Song contains lyric and chord data, the lyrics and chords will also appear on the score display.

■ Recordable data

When Style is off, tracks [1]–[16] can be recorded as melody tracks.

When Style is on, tracks [1]–[8] can be recorded as melody tracks, and tracks [9]–[16] can be recorded as accompaniment tracks.

NOTE

- Up to approximately 30,000 notes can be recorded, if you record only to the melody tracks.

■ Recording methods

- **Quick Recording**..... Immediately start recording by pressing the [REC] button. (see page 33)
- **Multi Recording**..... Specify the Song or Part number and then start recording. (see page 34)

Track Configuration

Generally, Song data consists of 16 tracks. On this instrument, you can record your performance step-by-step to each of tracks 1–16. For example, you can select the Main Voice for recording to Track 1, then set the Dual Voice to Track 2, and so on. (When the Quick Recording mode is selected, the playing parts and their corresponding tracks are set automatically.)

■ Recording track

When Multi track recording is selected and accompaniment is off, you can specify the recording track [1]–[16] for melody, or when accompaniment is on, you can specify the tracks [1]–[8] for melody and [9]–[16] for accompaniment. The track button in [1/9]–[8/16] that has recorded data in the tracks is indicated in green, while the button that contains no data is unlit. Also the track numbers containing recorded data are indicated with framed rectangles in the display.

Example: Part settings in Multi Recording

When Style is OFF

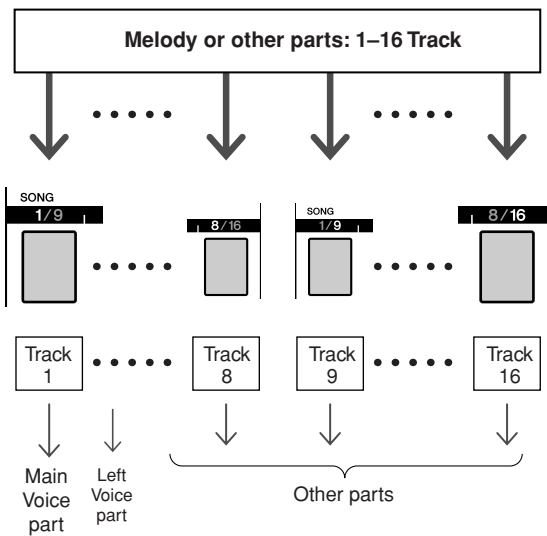

When Style is ON

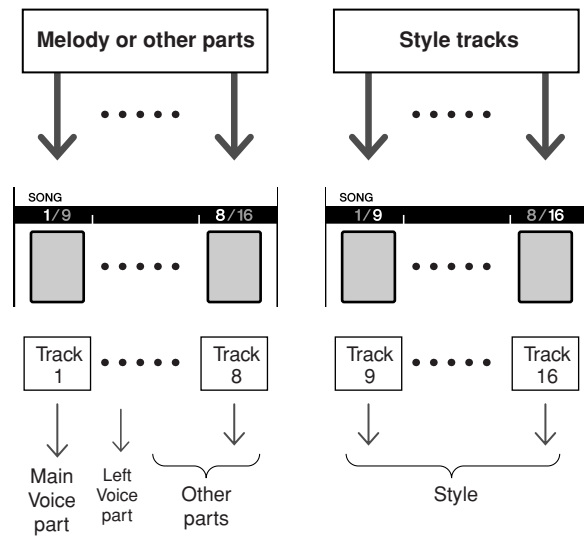

Quick Recording Procedure

You can easily start recording your performance by simply pressing the [REC] button in the [SONG] mode. In this case, the track number and part number of tracks are set automatically.

1 Press the [REC] button.

The User Song number for recording will be selected automatically. Performance parts are as follow:
Tracks [9]–[16] will be set to recording ready mode automatically.

NOTE

- You can manually select the recorded user Song number if you select it before pressing the [REC] button.
- Change the Style or Tempo if necessary.

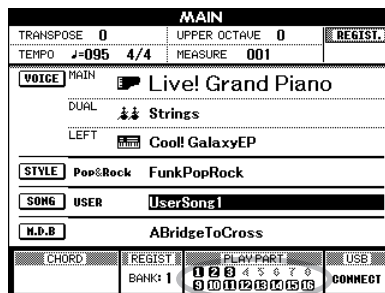

REC ready

Track 1	Main Voice part
Track 2	Left Voice part
Track 3	Dual Voice part
Tracks 9–16	Accompaniment part

Make sure to turn the Dual Voice or Left Voice on when recording the Dual Voice or Left Voice.

2 Recording will start when you play the keyboard.

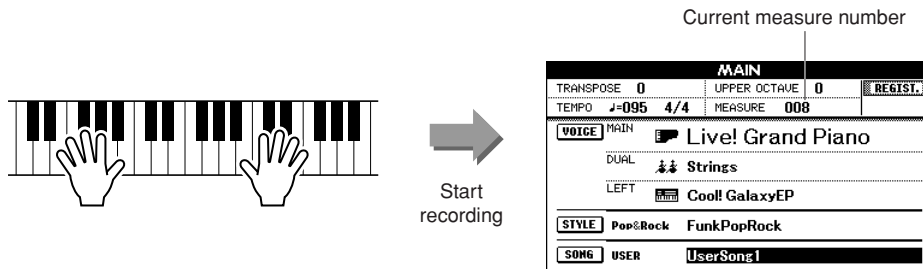

3 Stop recording by pressing the [▶/■] or [REC] button.

Track numbers containing recorded data are indicated with framed rectangles.

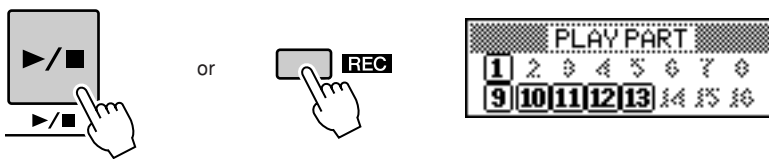

4 Press the [▶/■] button to play back the recording.

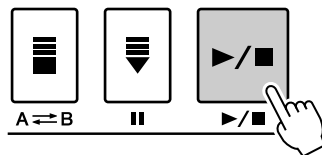

Multi-track Recording Procedure

You can set the recorded user Song number and the parts for tracks individually.

1 From the MAIN display press the [USER] button, then use the dial to select the user Song number (001–005) you want to record to.

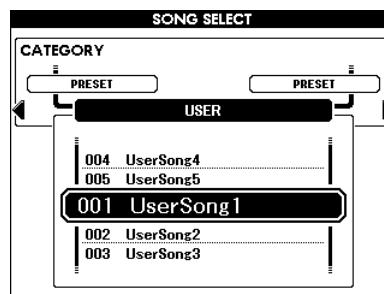
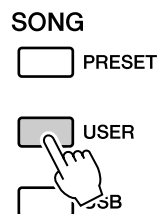

2 Press the [EXIT] button, then select the recording part for each track (Part Assign).

◆ Selecting the part for the Melody track

When Style is OFF: You can select the track for recording from [1]–[16].

When changing the track function between [TR 1–8] and [TR 9–16], press the [REGIST/PART [MIXER]] button repeatedly until the desired item appears at the top on the display.

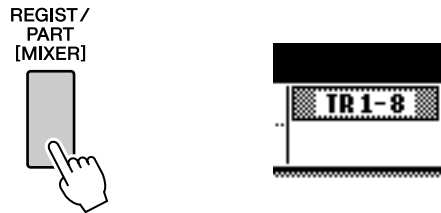

While holding down the [REC] button, press one of the track buttons [1/9]–[8/16] until the desired part is shown at the track button. Each time you press the button, the part is changed in order (e.g., MAIN, DUAL, LEFT) in the Main display.

When Style is ON: [TR 1–8] can only be selected for the Melody tracks.

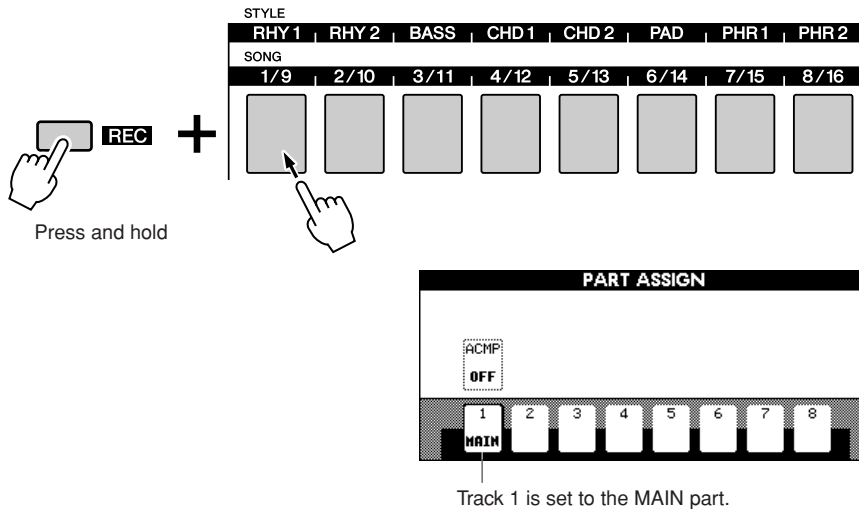

◆ Selecting the part for the Accompaniment track

While holding down the [REC] button, press the [ACMP] button. The REC indication will be highlighted in the display and operation will be set to record ready mode.

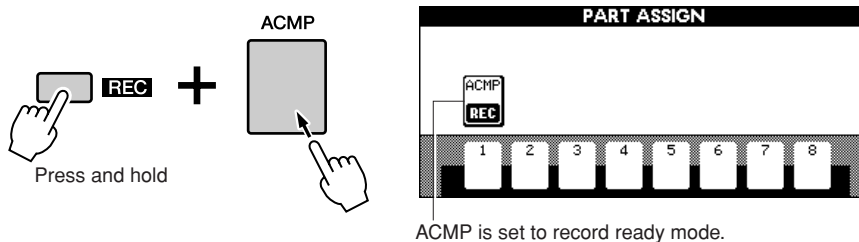

⚠ CAUTION

- If you record your performance to a track that contains previous data, the previous data will be overwritten by the new data.

NOTE

- When ACMP track is set to REC ON, the accompaniment will be automatically set to ON.
- ACMP ON/OFF does not change while recording is in progress.
- An assigned part cannot be specified to another track.
- A maximum of three melody tracks can be recorded simultaneously.

NOTE

- If you want to cancel the record ready mode of a track, simultaneously hold down the [REC] button and press again the track button you want to cancel.

3 Recording will start when you play the keyboard.

You can also start recording by pressing the [▶/■] button. When recording is started, the display automatically returns to the Main display, and the measure number is shown in the Main display.

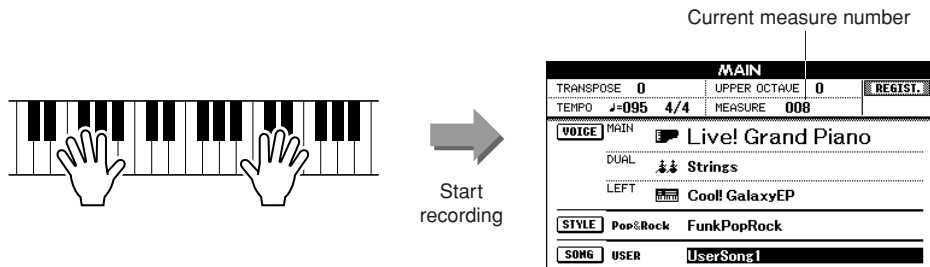

NOTE

- When Song memory is full, a corresponding message is shown in the display and recording will be stopped. In this case, delete any unnecessary Song data by using Song clear or track clear then start recording again. (See page 37.)

4 Stop recording by pressing the [▶/■] or [REC] button.

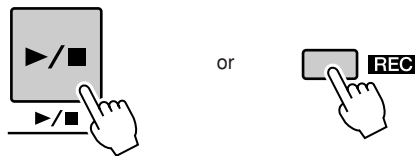

Alternately, if you press one of the ENDING/rit. [I]–[III] buttons while recording the ACMP track, an appropriate ending pattern will play and then recording will stop. When recording stops, the current measure number will return to 001 and the recorded track numbers in the display will be shown in a box border.

A message prompting you to confirm saving of the data will appear.

5 Save the recorded Song.

Press the [+ / YES] button.

■ To Record Other Tracks.

Repeat steps 2 through 4 to record any of the remaining tracks.

You can listen to the previously recorded tracks by pressing the appropriate [1/9]–[8/16] buttons while recording. Previously recorded track numbers are shown in a box border.

You can also mute previously recorded tracks (the muted tracks will not appear in the display) while recording new tracks (page 74).

■ Redo the Recording

Simply select the track you want to re-record for recording in the normal way.

The newly recorded material will overwrite the previous data.

6 After the recording is completed:

◆ Play the User Song

The operation is the same as that for Preset Songs (see page 27).

- 1 Press the [USER] button.
- 2 The current Song number/name will be highlighted—use the dial to select the user Song (001 to 005) you want to play.
- 3 Press the [▶/■] button.

◆ Save to USB flash Memory (see page 86)

● Data not to be recorded

The following data is recorded before the beginning of the Song. Even if you change the data while recording is in progress, the data will not be recorded.

Style number, Style volume, Time signature

Song Clear—Deleting User Songs

This function clears an entire user Song (all tracks).

1 From the MAIN display, select the user Song (001 to 005) you want to clear.

2 Press and hold the TRACK [8] button for longer than a second while holding the TRACK [1] button.

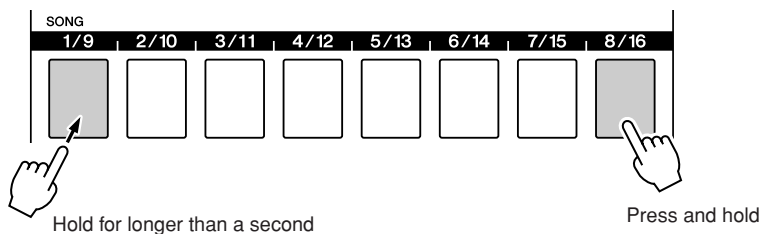

A confirmation message will appear on the display.

3 Press the [+ / YES] button to clear the Song.

The clear-in-progress message will appear briefly on the display while the Song is being cleared.

Songs can also be cleared in the following way.

- 1 Confirm that USB memory is not inserted on the instrument, then press the [FILE MENU] button.
- 2 Rotate the dial and select a Song.
- 3 Press the [EXECUTE] button.
A confirmation message will appear in the display.
- 4 Press [+ / YES] button to clear the Song.

NOTE

- If you want to clear a single, specified track, refer to the Track Clear operation on page 38.

NOTE

- To execute the Song Clear function press the [+ / YES] button. Press [- / NO] to cancel the Song Clear operation.

Track Clear—Deleting a Specified Track From a User Song

This function lets you delete a specified track from a User Song.

1 From the MAIN display select the User Song (001 to 005) you want to clear, then press the [EXIT] button.

2 Press the [REGIST/PART [MIXER]] button a number of times until the desired item appears on the display.

The item changes in order from “REGIST.” to “TR 1–8” to “TR 9–16”. Select the desired track: “TR 1–8” or “TR 9–16”.



3 Press and hold one of the track buttons ([1/9] to [8/16]) corresponding to the track you want to clear for longer than a second.

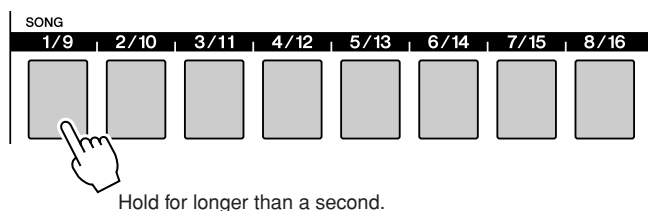

A confirmation message will appear on the display.

4 Press the [+ / YES] button to clear the track.

The clear-in-progress message will appear briefly on the display while the track is being cleared.

NOTE

- To execute the Track Clear function press the [+ / YES] button. Press [- / NO] to cancel the Track Clear operation.



Backup and Initialization

Backup

The following data items are automatically saved as backup data in the internal memory even if you turn the power off. To recall the default settings and data, use the Initialization operation.

● Backup data

- Registration memory
- Auto Fill In On/Off
- Following parameters in the Function display:
Tuning, Split point, Touch ON/OFF, Touch sensitivity, Style volume, Song volume, Metronome volume, Demo cancel, Language, Master EQ type, Chord fingering, SUSTAIN ON/OFF, TG mode

Initialization

This function erases all User Songs, User Styles, User MDB, and backup data in the instrument's internal memory and restores the initial default settings and data.

The following initialization procedures are provided.

■ Backup Clear

To clear backup data in the internal memory, simultaneously hold the highest white key on the keyboard and turn the power on by pressing the [STANDBY/ON] switch. The backed up data will be erased and the default values restored.

NOTE

- Language settings for the instrument cannot be changed in this operation. If you want to change the language, use the Function settings.

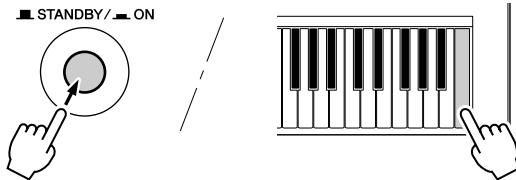

■ MEMORY Clear

To clear the User Song data, User Style data or User MDB data that has been transferred to the internal memory from a computer, simultaneously hold the highest white key on the keyboard and the three highest black keys and then turn the power on by pressing the [STANDBY/ON] switch.

CAUTION

- When you execute the Clear operation, User Song, User Style or User MDB you have purchased will also be cleared. Be sure to save any important data to a computer.

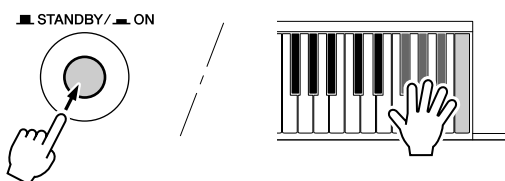



Basic Operation and Displays

Basic Operation

Overall PSR-S550 control is based on the following simple operations.

1 Use the category buttons to select a basic function or a CATEGORY.

2 Use the dial to select an item or value.

3 Starting/stopping a Song or Style.

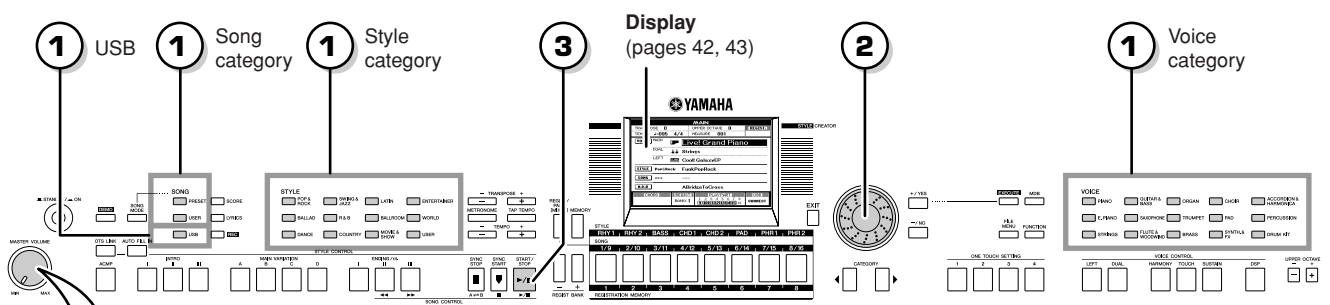

● Volume Adjustment

Adjusts the volume of the sound heard via the instrument's speakers or a pair of headphones plugged into the PHONES jack.

Rotate counterclockwise to lower the volume.

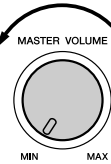

Rotate clockwise to increase the volume.

1 Use category buttons to select a CATEGORY.

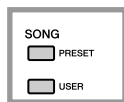

● Song category

Select the Song category you want to play



● USB

Select the Song, or Style in the USB memory.

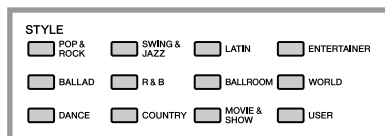

● Style category

Select the Style category you want to play

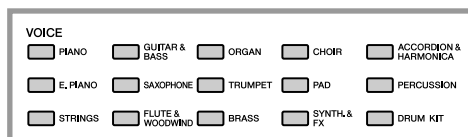

● Voice category

Select the Voice category you want to play

* If you want to change the category, press another category button or use the Category [◀], [▶] button.

● **Category buttons [◀], [▶]**

You can change the category after you've selected a Song, Style or Voice category. Pressing these buttons allow you to step in sequence through the categories.

Example: Voice selection display

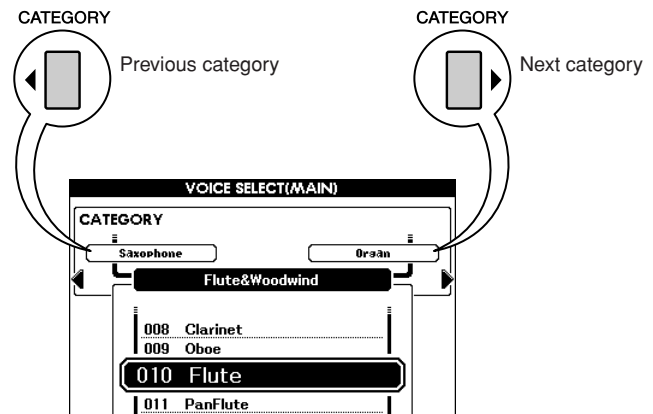

2 Use the dial to select an item or value.

When you select the category such as Song, Style or Voice, the selected category name and item is shown on the display. The item can be changed by using the dial or the [+ / YES], [- / NO] buttons.

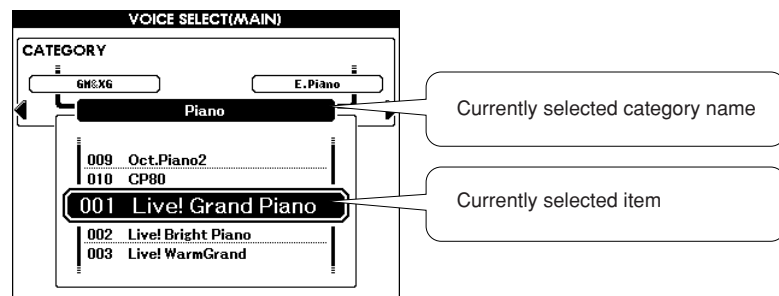

● **Dial**

Rotate the dial clockwise to increase the value of the selected item, or counter-clockwise to decrease its value. Rotate the dial to continuously increase or decrease the value.

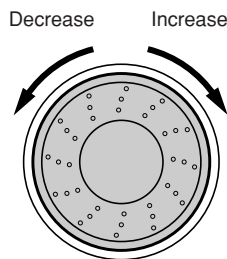

● **[+ / YES], [- / NO] buttons**

Press the [+ / YES] button briefly to increment the value by 1, or press the [- / NO] button briefly to decrement the value by 1. Press and hold either button to continuously increment or decrement the value in the corresponding direction.

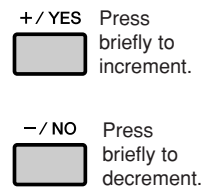

In most procedures described throughout this owner's manual, the dial is recommended for selection simply because it is the easiest and most intuitive selection method. Please note however, that most items or values that can be selected using the dial can also be selected using the [+ / YES] and [- / NO] buttons.

3 Starting/stopping a Song or Style.



Press the [START/STOP] button after selecting the Song category or Style category to start playback of the selected Song or Style (rhythm).

The Displays

● Display names

The display provides important, easy-to-understand indications for performing all operations. The name of the current display appears at the top of the display. You can see the “MAIN” indication at the top on the display.

● MAIN Display

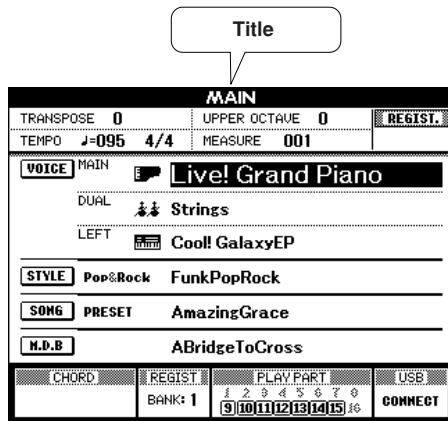

Call up the Main display



Most basic operations are carried out from the instrument’s MAIN display. You can return to the MAIN display from any other display by pressing the [EXIT] button near the lower right corner of the display panel.

● FUNCTION display (page 80)

The FUNCTION display provides access to 51 utility functions. The FUNCTION display appears when the [FUNCTION] button is pressed.

In the FUNCTION display you can use the CATEGORY [◀] and [▶] buttons (page 41) to select 51 different function items.

Press the CATEGORY button(s) as many times as necessary until the required function appears. You can then use the dial or the [+ / YES] and [- / NO] buttons to adjust the value of the function as required.

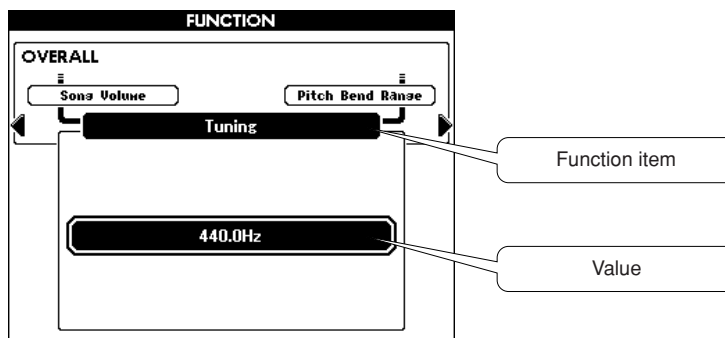

MAIN Display Items

The MAIN display shows all of the current basic settings: Song, Style, Voice. It also includes a range of indicators that show the on/off status of a range of functions.

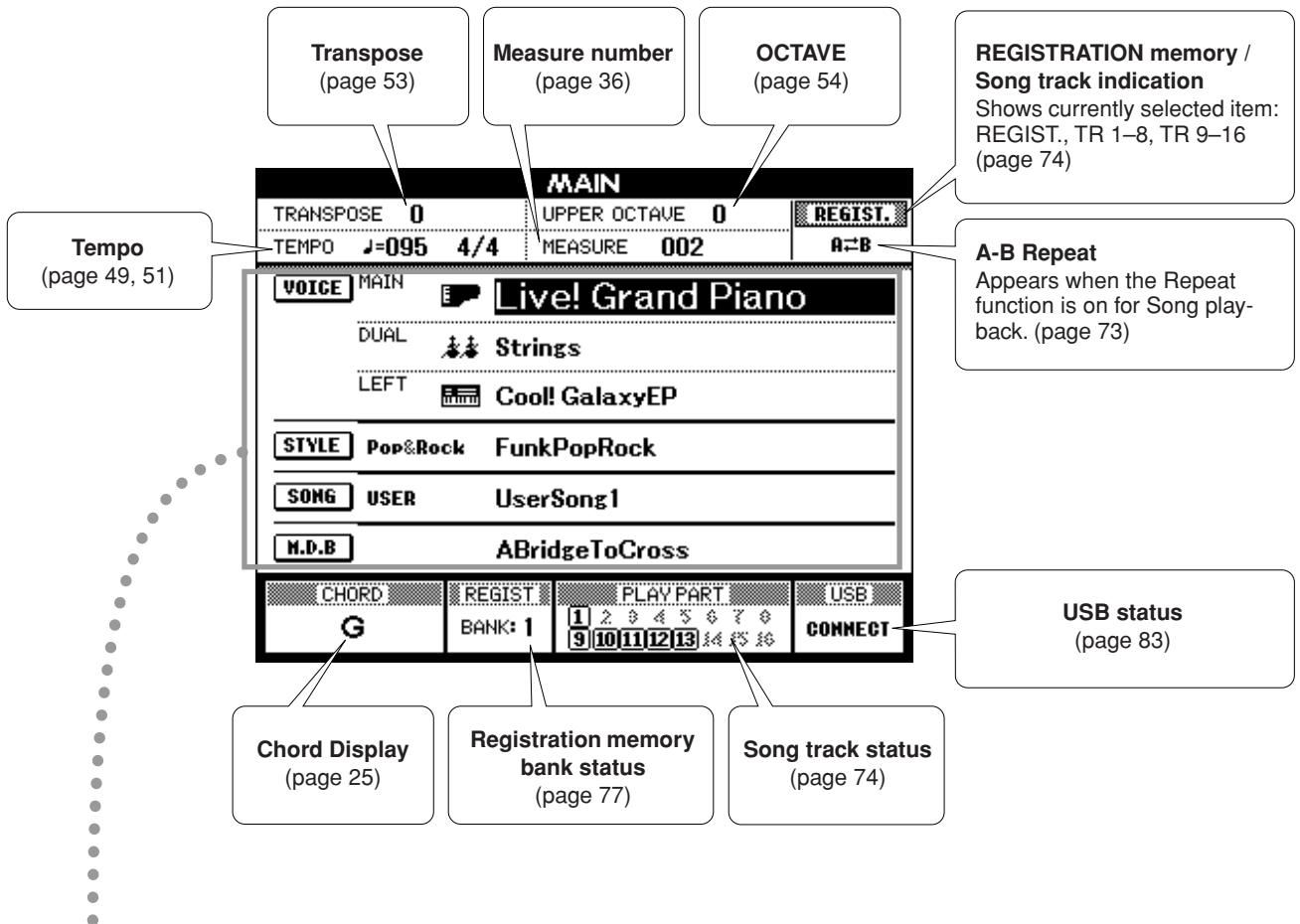

VOICE MAIN	Live! Grand Piano	Main Voice (page 17)
DUAL	Strings	Dual Voice (page 18)
LEFT	Cool! GalaxyEP	Left Voice (page 19)
STYLE Pop&Rock	FunkPopRock	Style (page 22)
SONG USER	UserSong1	Song (page 27)
M.D.B	ABridgeToCross	Music Database (page 26)

Playing with the Effects

Adding Harmony

This feature adds Harmony, Tremolo or Echo effects to the Main Voice.

1 Press the [HARMONY] button to turn the Harmony function on.

The [HARMONY] button lights indicating that Harmony is on.

To turn Harmony off, press the [HARMONY] button again.



NOTE

- When you press the [HARMONY] button to turn this feature on, the appropriate Harmony type for the currently selected Main Voice is automatically selected.

2 Press and hold the [HARMONY] button for longer than a second.

The currently selected Harmony type will be displayed.

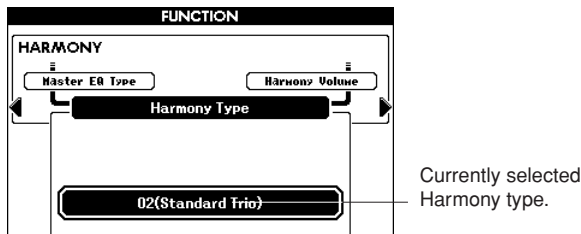
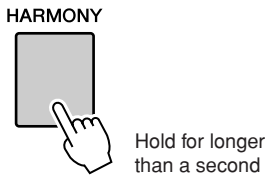

3 Use the dial to select a Harmony type.

Refer to the Effect Type List on page 125 for information about the available Harmony types.

Try playing the keyboard with the Harmony function. The effect and operation of each Harmony type is different—for details, refer to the section below “How to sound each Harmony Type” as well as the Effect Type List.

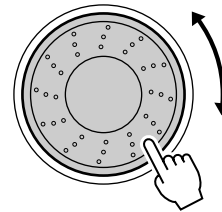

NOTE

- The Harmony notes can be added only to the Main Voice, not to Dual or Left Voices.
- The keys left of the Split Point of the keyboard produce no Harmony notes when the Auto Accompaniment is on (ACMP ON lights).
- When chord fingering is set to Full Keyboard, the Harmony function is turned off automatically.

● How to sound each Harmony Type

- Harmony types 01 to 14

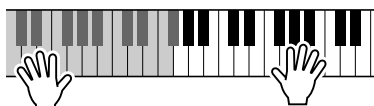

Press the right-hand keys while playing chords in the Auto Accompaniment range of the keyboard when the Auto Accompaniment is on (page 23).

- Harmony types 15 to 18 (Echo)

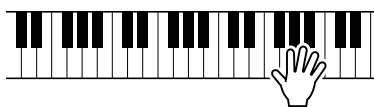

Keep holding down the keys.

- Harmony types 19 to 22 (Tremolo)



Keep holding down the keys.

- Harmony types 23 to 26 (Trill)

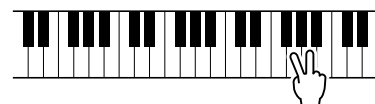

Hold down two keys.

You can adjust the Harmony Volume in the Function Settings (page 82).

Changing the Reverb Type

Reverb enhances the sound of the Voices with the rich ambience of a concert hall.

When you select a Style or Song the optimum reverb type for the Voice used is automatically selected. If you want to select a different reverb type, use the operation described below.

- 1 Press the [FUNCTION] button to call up the FUNCTION display.

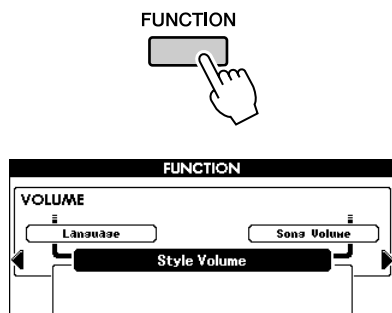

- 2 Press the CATEGORY [◀] and [▶] buttons as many times as necessary to call up Reverb Type.

The currently selected Reverb Type will be displayed.

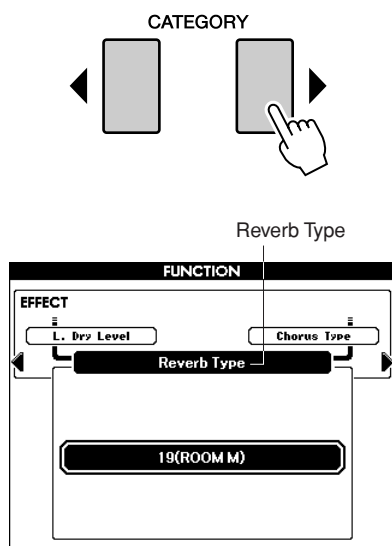

- 3 Use the dial to select a Reverb Type.

You can check the sound of the selected Reverb Type by playing the keyboard.

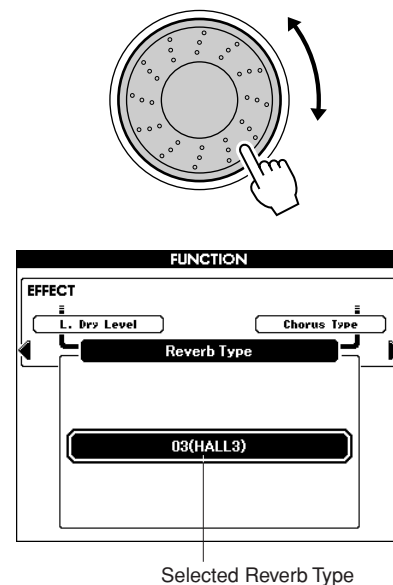

Refer to the Effect Type List on page 126 for information about the available Reverb Types.

● Adjusting the Reverb Level

You can individually adjust the amount of reverb that is applied to the Main, Dual, and Left Voices. (See page 81).

Changing the Chorus Type

The Chorus effect creates a thick sound that is similar to many of the same Voices being played in unison. When you select a Style or Song the optimum Chorus Type for the Voice used is automatically selected. If you want to select a different Chorus Type, use the procedure described below.

- 1 Press the [FUNCTION] button to call up the FUNCTION display.

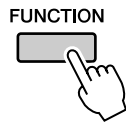

- 2 Press the CATEGORY [◀] and [▶] buttons as many times as necessary to call up Chorus Type.

The currently selected Chorus Type will be displayed.

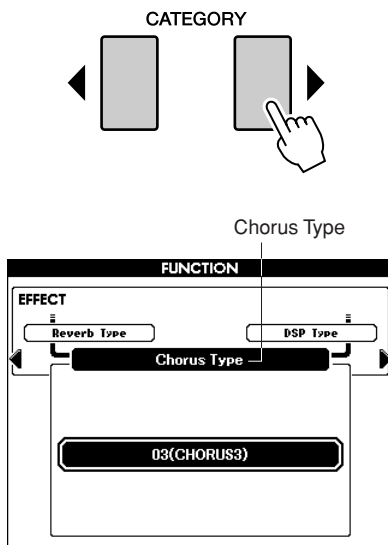

- 3 Use the dial to select a Chorus Type.

You can check the sound of the selected Chorus Type by playing the keyboard.

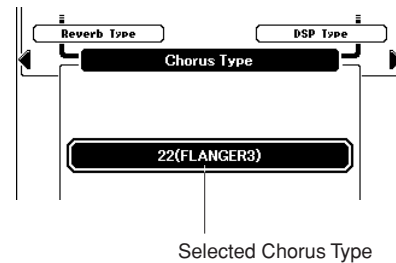
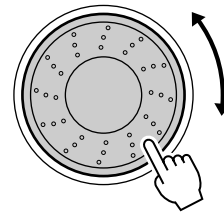

Refer to the Effect Type List on page 127 for information about the available Chorus Types.

● Adjusting the Chorus Level

You can individually adjust the amount of Chorus that is applied to the Main, Dual, and Left Voices. (See page 81).

Panel Sustain

This function adds sustain to the keyboard Voices. Use it when you want to add sustain to the Voices at all times, regardless of footswitch operation. The sustain function does not affect the Left Voice.

Press the [SUSTAIN] button to turn the sustain function on.

The [SUSTAIN] button lights indicating that Sustain is on.

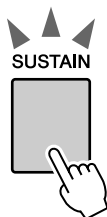

NOTE

• For certain Voices, the sustain effect may not be obvious or audible, even when the panel sustain function is turned on.

Adding DSP

A total of 178 DSP effects can be added to the Main, Dual and Left Voices. These range from reverb-like ambience effects to distortion and other dynamic processing tools that let you enhance the sound, or completely transform it.

NOTE

• DSP is term of abbreviated form of Digital Signal Processor and it uses a micro processor to change the audio in various ways.

1 Use the [DSP] button to turn the DSP function on.

The [DSP] button lights indicating that DSP is on. To turn DSP off, press the [DSP] button again.

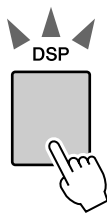

[DSP] button lights when DSP is on.

NOTE

- When DSP is turned on, the optimum DSP type for the current Voice is automatically selected.
- The volume of the currently playing Voice changes when turning DSP on or off. This is not a malfunction. The amount of change differs depending on the selected Voice.
- The DSP type is an overall setting—only one type can be selected. For this reason, when you play a newly loaded Song or Style, for example, the currently playing Voices may not sound as expected. This is normal, since the Song or Style has its own DSP type which replaces any selection you've made before loading. A similar phenomenon occurs when you use the [▶▶], [◀◀] buttons or A-B Repeat function during Song playback.

2 Press and hold the [DSP] button for longer than a second.

The currently selected DSP type will be displayed.

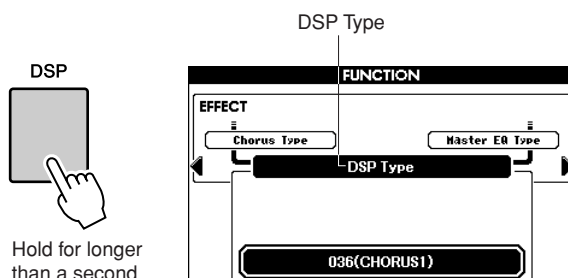

3 Use the dial to select a DSP type.

Refer to the DSP Type List on page 128 for information about the available DSP types.

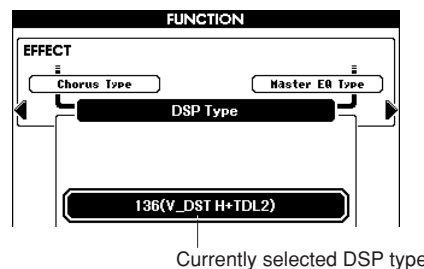
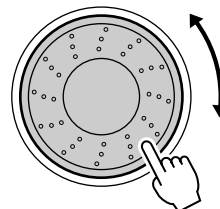

Pitch Bend

The pitch bend wheel can be used to add smooth pitch variations to notes you play on the keyboard. Roll the wheel upward to raise the pitch, or downward to lower the pitch. If you use this feature with a Voice such as the “042 Overdrive” guitar Voice (page 17), you can produce remarkably realistic string-bending effects.

You can change the amount of pitch bend produced by the wheel, as described on page 81.

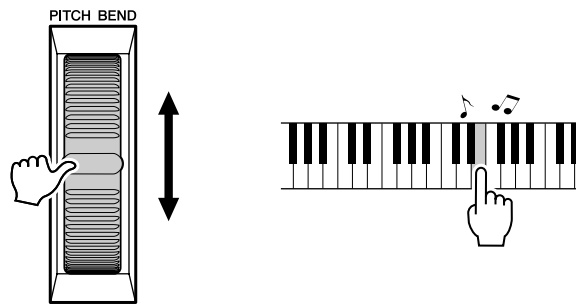

NOTE

- Pitch Bend is not applied to the Left Voice when accompaniment is turned on.

Using Various Functions

Playing with the metronome

This instrument includes a metronome with adjustable tempo and time signature. Play and set the tempo that is most comfortable for you.

■ Turn the metronome on.....

Press the [METRONOME] button to start the metronome.

To stop the metronome, press the [METRONOME] button again.

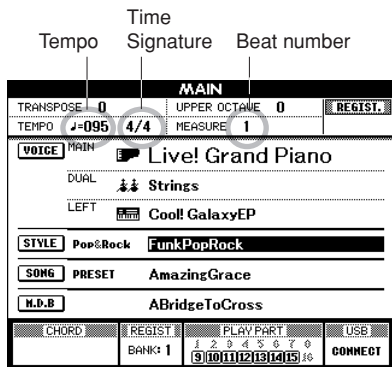
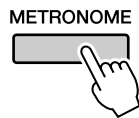

■ Set the metronome tempo

1 Press the TEMPO [+]/[-] buttons to call up the tempo setting and use the buttons to raise or lower the tempo.

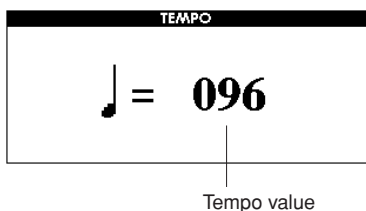
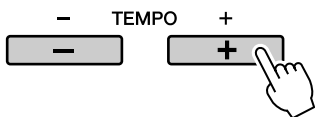

2 Use the dial to select a tempo from 5 to 280.

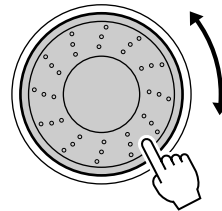

Press the [EXIT] button to return to the Main display.

NOTE

The tempo can be changed by either pressing the TEMPO [+]/[-] buttons repeatedly or holding them down.

■ Mute the bell

You can mute the Metronome bell which sounds at the first beat of each measure.

1 Press the [FUNCTION] button.

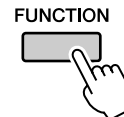

2 Press the CATEGORY [◀] and [▶] buttons as many times as necessary to call up "Bell."

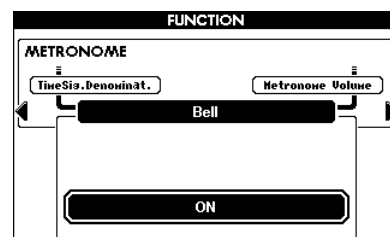
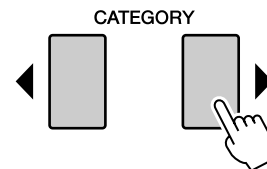

3 Rotate the dial and select ON (sound) or OFF (mute).

■ Changing the Time Signature . . .

In this example we'll set up a 3/8 time signature.

1 Press and hold the [METRONOME] button for longer than a second.

The currently selected time signature is displayed.

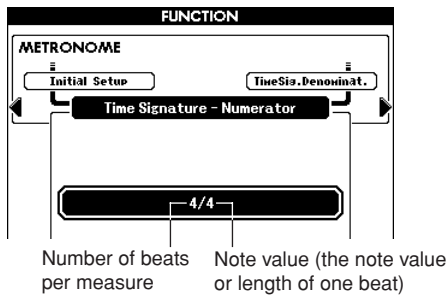
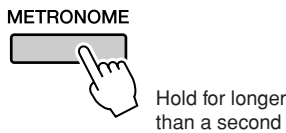

2 Use the dial to select the number of beats per measure.

When the Bell setting is on, the Bell will sound on the first beat of each measure, while a metronome "click" will sound on all others. You can set the time signature from 01 to 60. Select 3 for this example.

NOTE 1

• When playing the Song or Style the beat value cannot be changed, since the beat is synchronized to the selected Song or Style.

3 Press the CATEGORY [▶] button once to call up the Time Signature Denominator display.

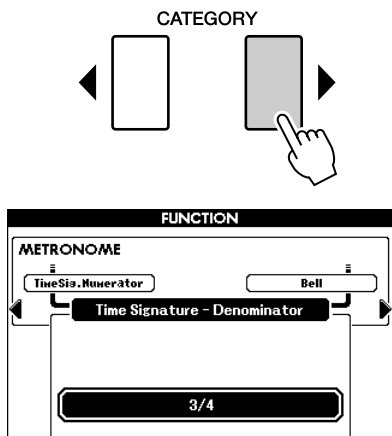

4 Use the dial to select a beat length.

Select the required length for each beat: 2, 4, 8, or 16 (half note, quarter note, eighth note, or 16th note). For this example, select 8. The time signature should now be set to 3/8.

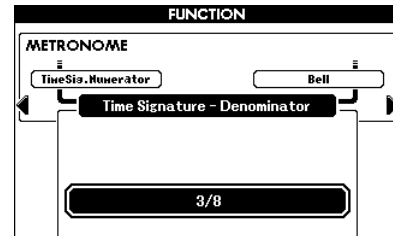

Press the [METRONOME] button to confirm the settings.

■ Adjusting the Metronome Volume

1 Press the [FUNCTION] button.

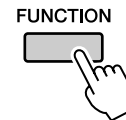

2 Press the CATEGORY [◀] and [▶] buttons as many times as necessary to call up Metronome Volume.

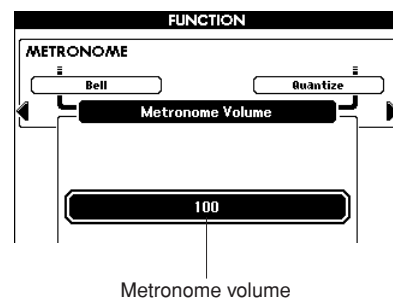
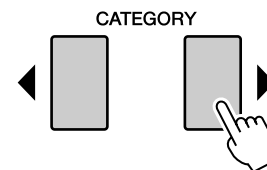

3 Use the dial to set the metronome volume.

Using Tap Start

You can also set the tempo by simply tapping the [TAP TEMPO] button at the required tempo—four times for time signatures in 4, and three times for time signatures in 3.

You can change the tempo during Song or Style playback by pressing the button just twice.

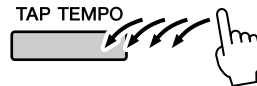

Touch Response

■ Turning Touch Response on/off..

Keyboard Touch Response can be turned on by pressing the [TOUCH] button.

When Touch Response is on you can control the volume of notes according to how hard you play the keys.

The [TOUCH] button lights indicating Touch Response is turned on.

To turn Touch Response off, press the [TOUCH] button again.

When Touch Response is off, the same volume will be produced no matter how hard or soft you play the keys.

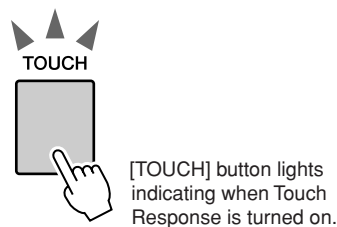

■ Adjusting the Touch Response Sensitivity

The sensitivity of the keyboard's Touch Response can be adjusted in three steps (1–3). The higher the number, the greater the volume variation produced by the variation in how hard you play the keys—i.e., the keyboard becomes more “sensitive.”

1 Press and hold the [TOUCH] button for longer than a second.

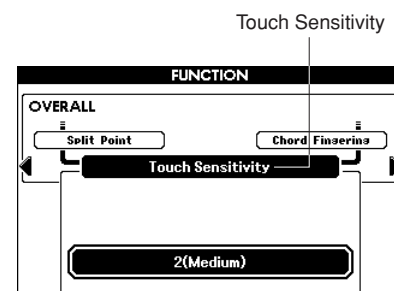
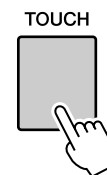

2 Use the dial to select a Touch Sensitivity setting between 1 and 3. Higher values produce greater (easier) volume variation in response to keyboard dynamics—i.e., greater sensitivity.

NOTE

- The initial default setting is 2.

EQ settings

Five pre-programmed EQ settings are available. Settings 1 and 2 are best for listening via the instrument's built-in speakers, setting 3 is for headphones, and settings 4 and 5 are ideal for listening via external speakers or when connecting to an external mixer.

1 Press the [FUNCTION] button.

The currently selected function will appear in the display.

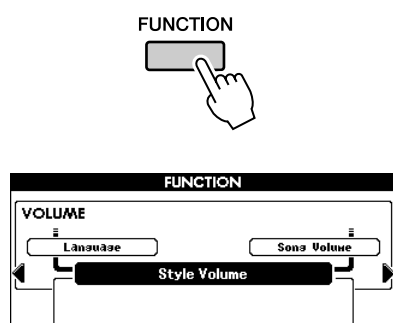

2 Press the CATEGORY [◀] and [▶] buttons as many times as necessary to call up Master EQ Type.

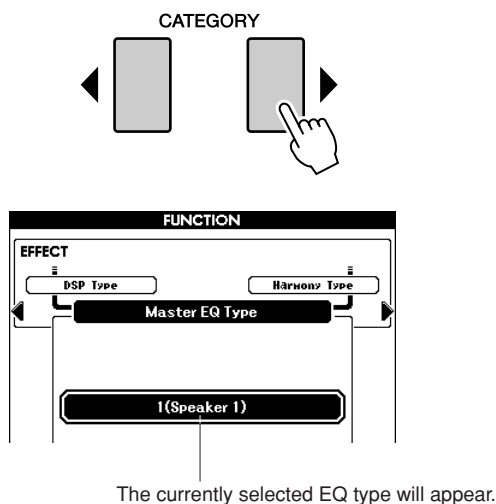

3 Use the dial to select an EQ Setting for the best sound.

Pitch Controls

◆ Large Pitch Changes (Transpose)

The overall pitch of the instrument can be shifted up or down by a maximum of one octave in semitone increments.

1 Press one of the TRANSPOSE [+] / [-] buttons.

The value is shown in the display, indicating the amount of transposition over or below the normal value.

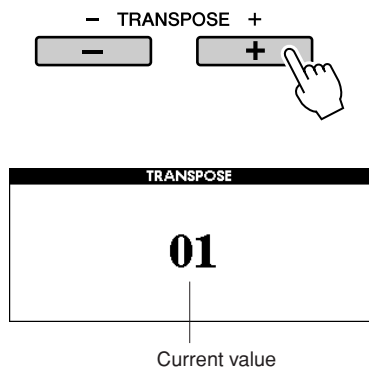

2 Use the dial to set the transpose value between -12 and +12 as required.

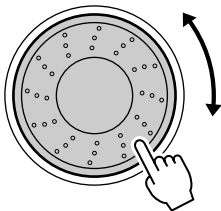

NOTE

• This setting does not affect Drum Kit Voices.

Press the [EXIT] button to return to the Main display.

Pressing the TRANSPOSE [+] / [-] buttons allows single-step changes. Pressing and holding either TRANSPOSE [+] / [-] button continuously increases or decreases the value.

◆ Small Pitch Changes (Tuning)

The overall tuning of the instrument can be shifted up or down by a maximum of 1 semitone. The default setting is 440 Hz.

1 Press the [FUNCTION] button.

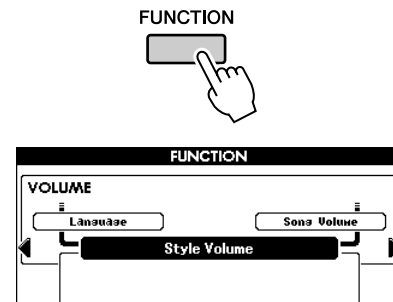

2 Press the CATEGORY [◀] and [▶] buttons as many times as necessary to call up Tuning.

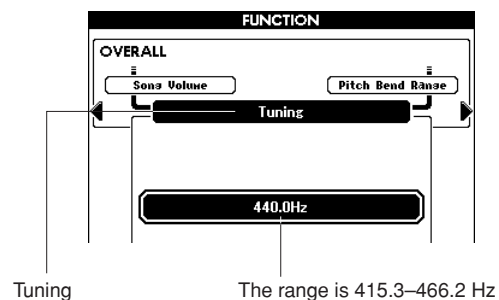

3 Use the dial to set the tuning value between 415.3–466.2Hz as required.

NOTE

• This setting does not affect Drum Kit Voices.

Changing the pitch of the instrument in octaves

You can change the playing pitch of the Main and Dual Voices in octave intervals.

1 Press the UPPER OCTAVE [+] button to raise the pitch by one octave.

The newly changed value is shown in the LCD. Press the [EXIT] button to return to the Main display.

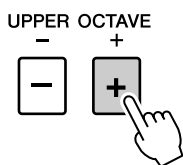

● In the case of UPPER OCTAVE +1

One octave up

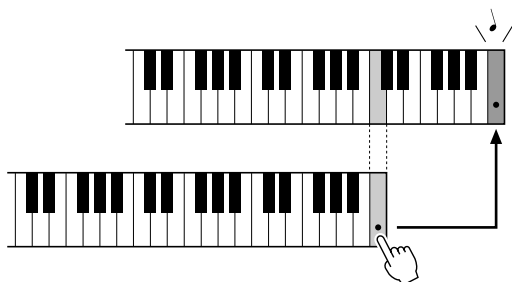

NOTE

• When a Drum Kit is selected, each percussion Voice assigned to the keyboard are shifted in location but not pitch.

2 Press the UPPER OCTAVE [-] button to lower the pitch by one octave.

The newly changed value—now one octave lower—is shown in the LCD.

Press the UPPER OCTAVE [-] button again to lower the pitch one more octave.

Press the [EXIT] button to return to the Main display.

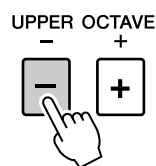

● In the case of UPPER OCTAVE -1

One octave down

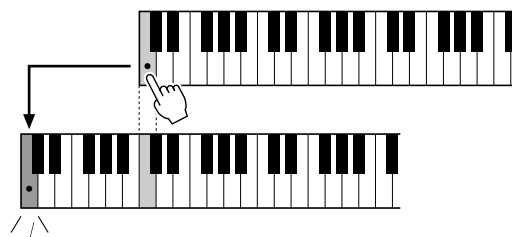

Style (Auto Accompaniment) Functions

Basic operation of the Style (Auto Accompaniment) feature is described on page 22 of the Quick Guide.

Included here is information on how you can play the Styles in various ways, how to adjust the Style volume, how you can play chords using the Styles, and more.

Pattern Variation (sections)

The instrument features a wide variety of Style “sections” that allow you to vary the arrangement of the accompaniment to match the Song you are playing.

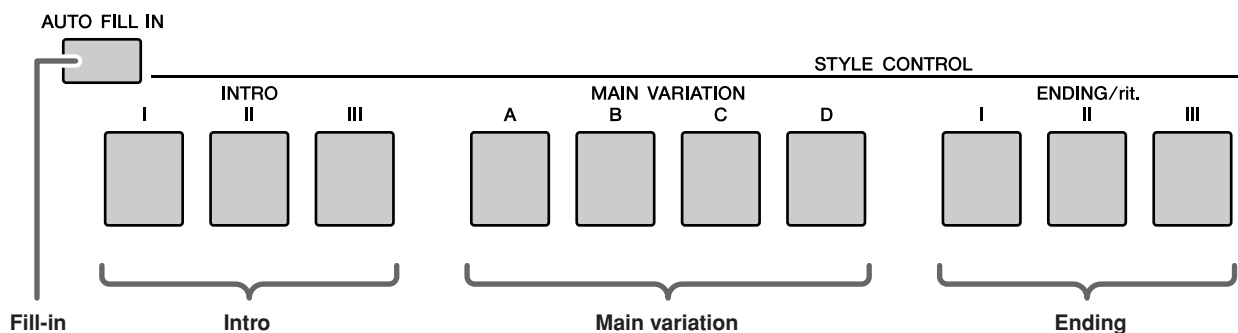

●INTRO section

This is used for the beginning of the Song. When the intro finishes playing, accompaniment shifts to the main section. The length of the intro (in measures) differs depending on the selected Style.

●MAIN VARIATION section

This is used for playing the main part of the Song. It plays a main accompaniment pattern, and repeats indefinitely until another section’s button is pressed. There are four variations on the basic pattern (A–D), and the Style playback sound changes harmonically based on the chords you play with your left hand.

●ENDING section

This is used for the ending of the Song. When the ending is finished, the Auto Accompaniment stops automatically. The length of the ending (in measures) differs depending on the selected Style.

●AUTO Fill-in section

This is automatically added before the current section changes to a newly selected section.

1 Select the desired Style. (See page 22.)

2 Press the [ACMP] button to turn Auto Accompaniment on.

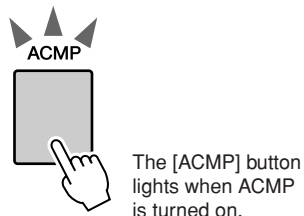

3 Press the [AUTO FILL IN] button to turn the Auto Fill In function on.

The initial default setting for Auto Fill In is “on.”



4 Press the [SYNC START] button to turn Synchro Start on.

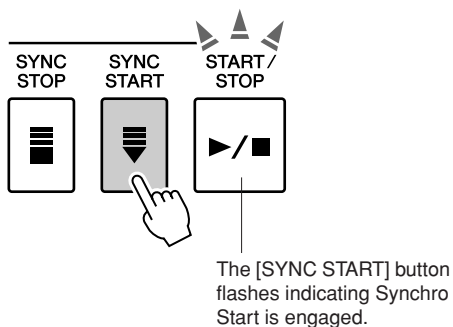

● Synchro Start

When Synchro Start is on you, can start the Style by playing any key in the accompaniment range of the keyboard.

5 Press one of the MAIN VARIATION [A]–[D] buttons.

The selected Main Variation button flashes.

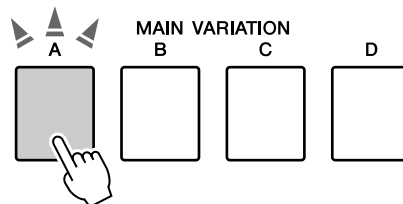

6 Press one of the INTRO [I]–[III] buttons.

The selected Intro button lights.

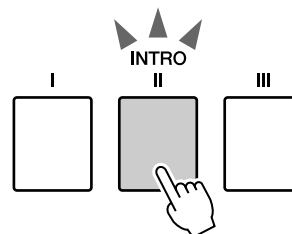

7 Play a chord in the accompaniment range and start the Intro section.

Try playing a C major chord. (See “Playing Auto-accompaniment Chords” on page 25.)

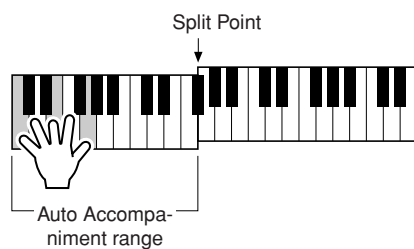

NOTE

• The Baroque Air Style in the MOVIE & SHOW category does not have a Rhythm part, so there is no rhythm sound for this Style.

- 8** Press one of the **MAIN VARIATION [A]–[D]** buttons.

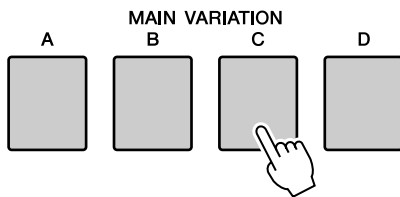

When the fill-in is finished, it leads smoothly into the selected Main section A–D.

- 9** Press one of the **ENDING/rit. [I]–[III]** buttons.

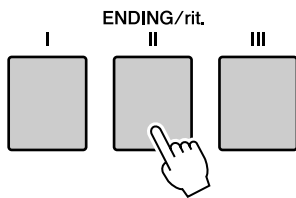

This switches to the Ending section. When the Ending is finished, the Auto Accompaniment stops automatically. You can have the Ending gradually slow down (ritardando) by pressing one of the ENDING/rit. [I]–[III] buttons again while the Ending is playing back.

● Synchro Stop

When this function is selected, the accompaniment Style will only play while you are playing chords in the accompaniment range of the keyboard.

Style playback will stop when you release the keys. To turn the function on, press the [SYNC STOP] button.

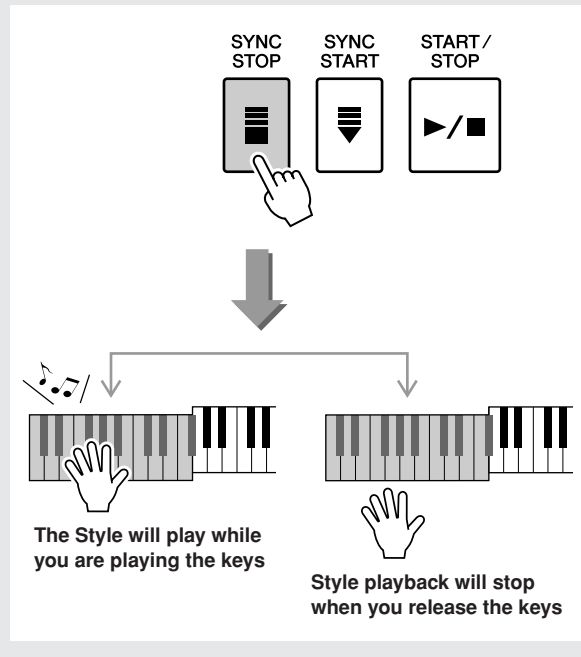

One Touch Setting

Sometimes selecting the ideal Voice to play with a Song or Style can be confusing. The One Touch Setting feature automatically selects four ideally matched Voices for the Style you've selected.

1 Select the desired Style. (See page 22.)

2 Press one of the ONE TOUCH SETTING [1]–[4] buttons.

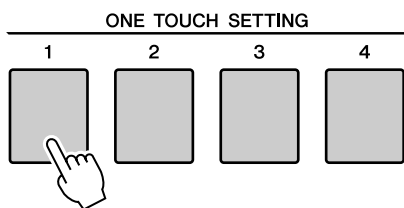

3 Play the chord in the accompaniment range and start the Style.

Try selecting other ONE TOUCH SETTING [1]–[4] buttons and listen to the results.

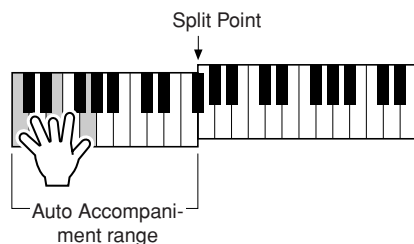

Variation Change and OTS (OTS LINK)

When change the MAIN VARIATION [A]–[D] to other MAIN VARIATION [A]–[D] during OTS LINK is on, OTS 1–4 automatically change the number according to the selected variation number. (see below)

Press the [OTS LINK] button to turn on the OTS link.

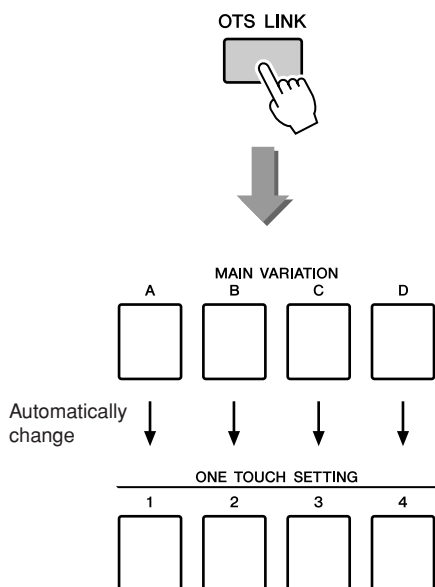

Setting the Split Point

The initial default Split Point is key number 54 (the F#2 key), but you can change it to another key using the procedure described below.

1 Press the [FUNCTION] button.

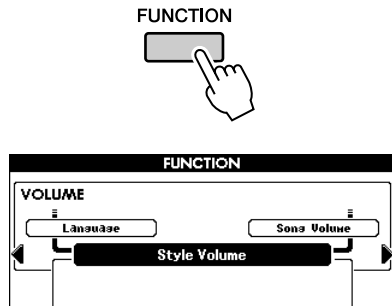

2 Use the CATEGORY [◀] and [▶] buttons as many times as necessary to call up Split Point.

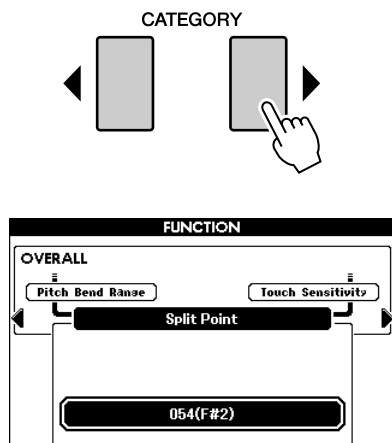

3 Use the dial to set the Split Point to any key from 036 (C1) through 096 (C6).

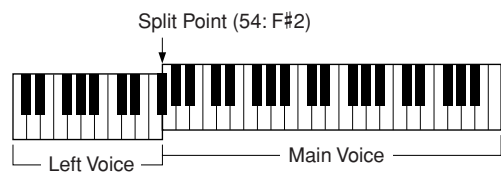

NOTE

- Changing the Split Point here also changes the Auto Accompaniment Split Point.
- The Left Voice sounds when the split-point key is played.

Playing a Style with Chords but without Rhythm (Stop Accompaniment)

When Auto Accompaniment is on (ACMP button lights) and Synchro Start is off, you can play chords in the left-hand accompaniment range of the keyboard while the Style is stopped and still hear the accompaniment chords. This is called “Stop Accompaniment,” and any of the chord fingerings recognized by the instrument can be used (page 25).

Select a Style, then press the [ACMP] button to turn Auto Accompaniment on.

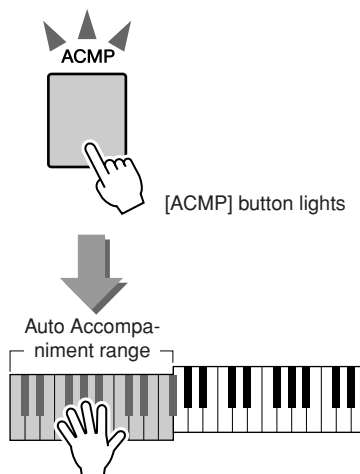

Adjusting the Style Volume

If the instrument is in the Song mode, press one of the Style category buttons to enter the Style mode. (page 22)

1 Press the [FUNCTION] button.

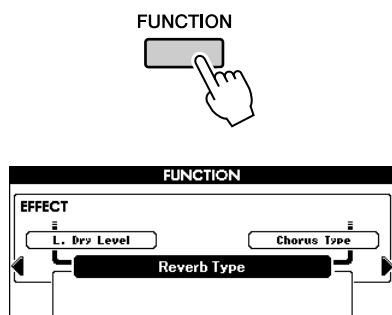

2 Use the CATEGORY [◀] and [▶] buttons as many times as necessary to call up Style Volume.

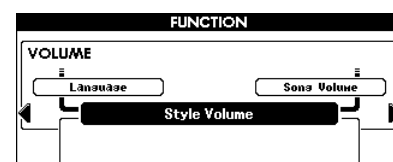
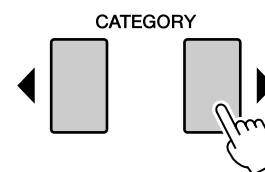

3 Use the dial to set the Style Volume between 000 and 127.

Chord Basics

Two or more notes played together constitute a “chord”.

The most basic chord type is the “triad” consisting of three notes: the root, third, and fifth degrees of the corresponding scale. A C major triad, for example, is made up of the notes C (the root), E (the third note of the C major scale), and G (the fifth note of the C major scale).

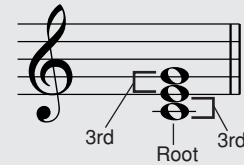

In the C major triad shown above, the lowest note is the “root” of the chord (this is the chord’s “root position” ... using other chord notes for the lowest note results in “inversions”). The root is the central sound of the chord, which supports and anchors the other chord notes. The distance (interval) between adjacent notes of a triad in root position is either a major or minor third.

Major third—four half steps (semitones)

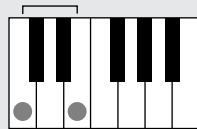

Minor third—three half steps (semitones)

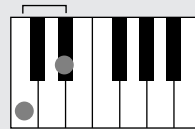

The lowest interval in our root-position triad (between the root and the third) determines whether the triad is a major or minor chord, and we can shift the highest note up or down by a semitone to produce two additional chords, as shown below.

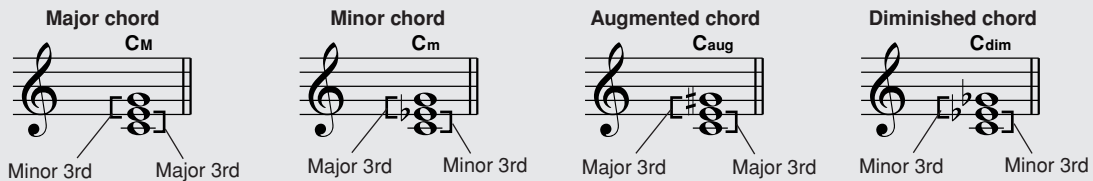

The basic characteristics of the chord sound remain intact even if we change the order of the notes to create different inversions. Successive chords in a chord progression can be smoothly connected, for example, by choosing the appropriate inversions (or chord “voicings”).

● Reading Chord Names

Chord names tell you just about everything you need to know about a chord (other than the inversion/voicing). The chord name tells you what the root of the chord is, whether it is a major, minor, or diminished chord, whether it requires a major or flatted seventh, what alterations or tensions it uses ... all at a glance.

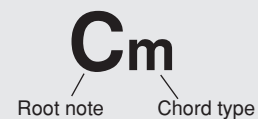

● Some Chord Types (These are just some of the “Standard” chord types recognized by the PSR-S550.)

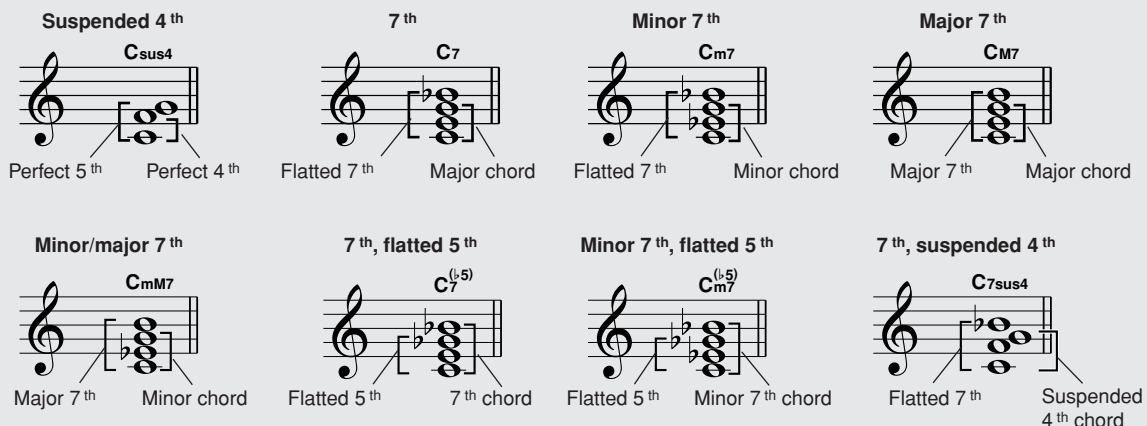

■ Recognized Standard Chords.....

All chords in the chart are “C-root” chords.

Chord Name/[Abbreviation]	Normal Voicing	Chord (C)	Display
Major [M]	1 - 3 - 5	C	C
Add ninth [(9)]	1 - 2 - 3 - 5	C ⁽⁹⁾	Cadd9
Sixth [6]	1 - (3) - 5 - 6	C ₆	C6
Sixth ninth [6(9)]	1 - 2 - 3 - (5) - 6	C ₆ ⁽⁹⁾	C6 ⁹
Major seventh [M7]	1 - 3 - (5) - 7	CM7	CM7
Major seventh ninth [M7(9)]	1 - 2 - 3 - (5) - 7	CM ₇ ⁽⁹⁾	CM7 ⁹
Major seventh add sharp eleventh [M7(#11)]	1 - (2) - 3 - #4 - 5 - 7 or 1 - 2 - 3 - #4 - (5) - 7	CM ₇ ^(#11)	CM7#11
Flatted fifth [(b5)]	1 - 3 - b5	C ^(b5)	C ^{b5}
Major seventh flatted fifth [M7b5]	1 - 3 - b5 - 7	CM ₇ ^(b5)	CM7 ^{b5}
Suspended fourth [sus4]	1 - 4 - 5	C _{sus4}	Csus4
Augmented [aug]	1 - 3 - #5	C _{aug}	Caug
Major seventh augmented [M7aug]	1 - (3) - #5 - 7	CM _{7aug}	CM7aug
Minor [m]	1 - b3 - 5	C _m	Cm
Minor add ninth [m(9)]	1 - 2 - b3 - 5	C _m ⁽⁹⁾	Cm add9
Minor sixth [m6]	1 - b3 - 5 - 6	C _{m6}	Cm6
Minor seventh [m7]	1 - b3 - (5) - b7	C _{m7}	Cm7
Minor seventh ninth [m7(9)]	1 - 2 - b3 - (5) - b7	C _{m7} ⁽⁹⁾	Cm7 ⁹
Minor seventh add eleventh [m7(11)]	1 - (2) - b3 - 4 - 5 - (b7)	C _{m7} ⁽¹¹⁾	Cm7 ¹¹
Minor major seventh [mM7]	1 - b3 - (5) - 7	C _{mM7}	CmM7
Minor major seventh ninth [mM7(9)]	1 - 2 - b3 - (5) - 7	C _{mM7} ⁽⁹⁾	CmM7 ⁹
Minor seventh flatted fifth [m7b5]	1 - b3 - b5 - b7	C _{m7} ^(b5)	Cm7 ^{b5}
Minor major seventh flatted fifth [mM7b5]	1 - b3 - b5 - 7	C _{mM7} ^(b5)	CmM7 ^{b5}
Diminished [dim]	1 - b3 - b5	C _{dim}	Cdim
Diminished seventh [dim7]	1 - b3 - b5 - 6	C _{dim7}	Cdim7
Seventh [7]	1 - 3 - (5) - b7 or 1 - (3) - 5 - b7	C ₇	C7
Seventh flatted ninth [7(b9)]	1 - b2 - 3 - (5) - b7	C ₇ ^(b9)	C7 ^{b9}
Seventh add flatted thirteenth [7(b13)]	1 - 3 - 5 - b6 - b7	C ₇ ^(b13)	C7 ^{b13}
Seventh ninth [7(9)]	1 - 2 - 3 - (5) - b7	C ₇ ⁽⁹⁾	C7 ⁹
Seventh add sharp eleventh [7(#11)]	1 - (2) - 3 - #4 - 5 - b7 or 1 - 2 - 3 - #4 - (5) - b7	C ₇ ^(#11)	C7#11
Seventh add thirteenth [7(13)]	1 - 3 - (5) - 6 - b7	C ₇ ⁽¹³⁾	C7 ¹³
Seventh sharp ninth [7(#9)]	1 - #2 - 3 - (5) - b7	C ₇ ^(#9)	C7#9
Seventh flatted fifth [7b5]	1 - 3 - b5 - b7	C _{7b5}	C7 ^{b5}
Seventh augmented [7aug]	1 - 3 - #5 - b7	C _{7aug}	C7aug
Seventh suspended fourth [7sus4]	1 - 4 - 5 - b7	C _{7sus4}	C7sus4
Suspended second [sus2]	1 - 2 - 5	C _{sus2}	Csus2

NOTE

- Notes in parentheses can be omitted.
- Playing two same root keys in the adjacent octaves produces accompaniment based only on the root.
- A perfect fifth (1 + 5) produces accompaniment based only on the root and fifth which can be used with both major and minor chords.

User Style

This instrument features 11 internal Style categories, but it also allows you to import additional Styles (only those with an “.sty” extension) that you’ve downloaded from the Internet or gotten from other sources, and load them into a User Style and use them in the same way as the internal Styles. For details on loading a Style file, see “Loading Registration Files, Style Files, Song Files or MDB Files” on page 87.

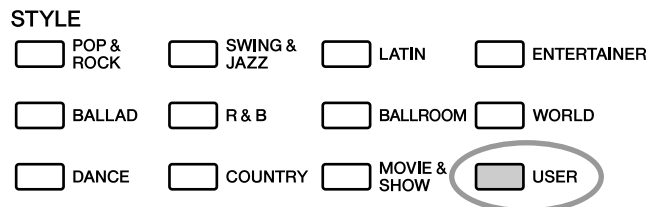

In order to load a Style file it is necessary to first either transfer the Style file to the instrument from a computer, or connect a USB flash memory containing the Style file to the USB TO DEVICE connector. Refer to “Transferring Data Between the Computer and Instrument” on page 96 for details on the file transfer procedure.

If you are using a USB flash memory device, refer to “Loading Registration Files, Style Files, Song Files or MDB Files” on page 87.

You can directly play the User Style in the USB memory without loading (page 89).

Playing Styles Using the Entire Keyboard

In “Playing Along with a Style” on page 23 we described two methods of playing Styles (Multi, Full Keyboard) in which chords were either detected only to the left of the keyboard Split Point or over the entire keyboard. By making the settings described below, chord detection for Style accompaniment occurs over the entire range of the keyboard, allowing for even more dynamic Style performance. In this mode only chords played in the normal way (page 25) can be detected.

1 Press the [ACMP] button for longer than a second.

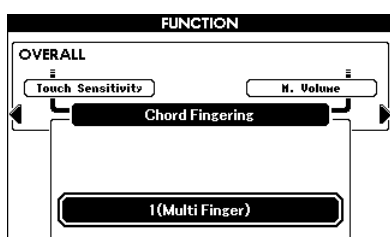
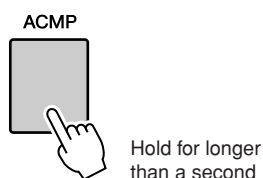

2 Use the dial to select 2 “FullKeyboard”.

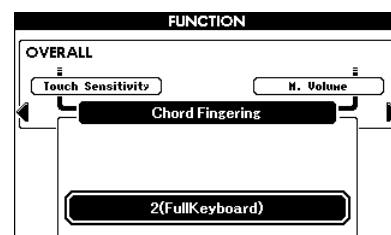
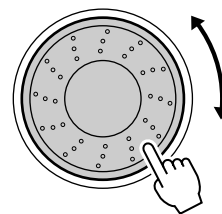

Creating Original Styles (Style Creator)

This instrument has a Style Creator feature that lets you record and save your own original Styles.

Recorded Styles can be played in the same manner as the preset Styles.

Style Structure

Style data consists of eighteen sections, each of which has eight separate Parts.

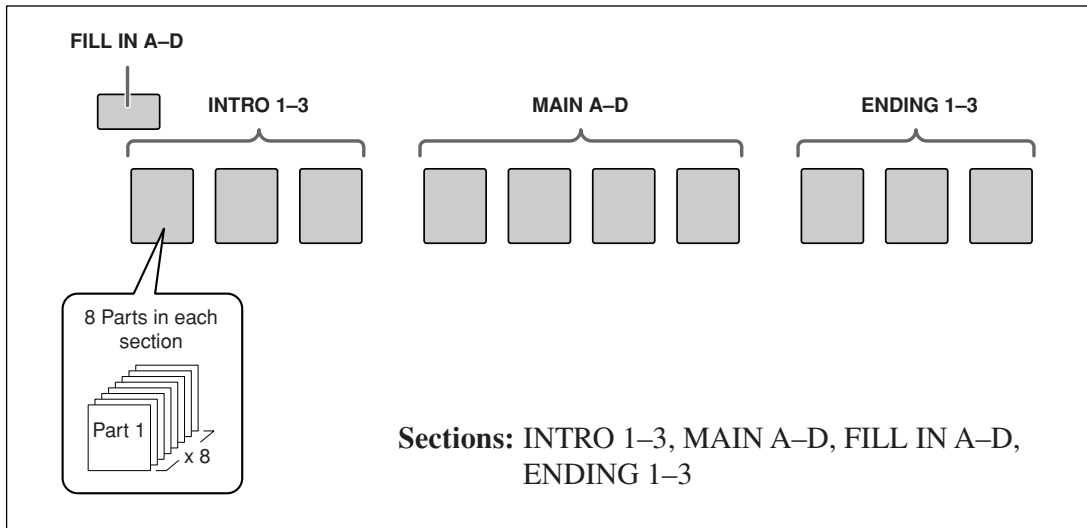

Main Display of the Style Creator

The following display appears when entering the Style Creator function.

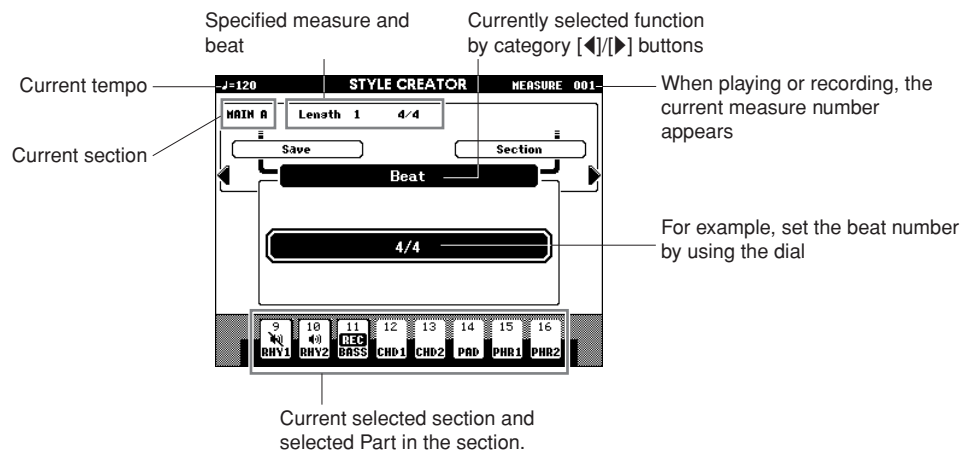

Follow the Style Creator instructions.

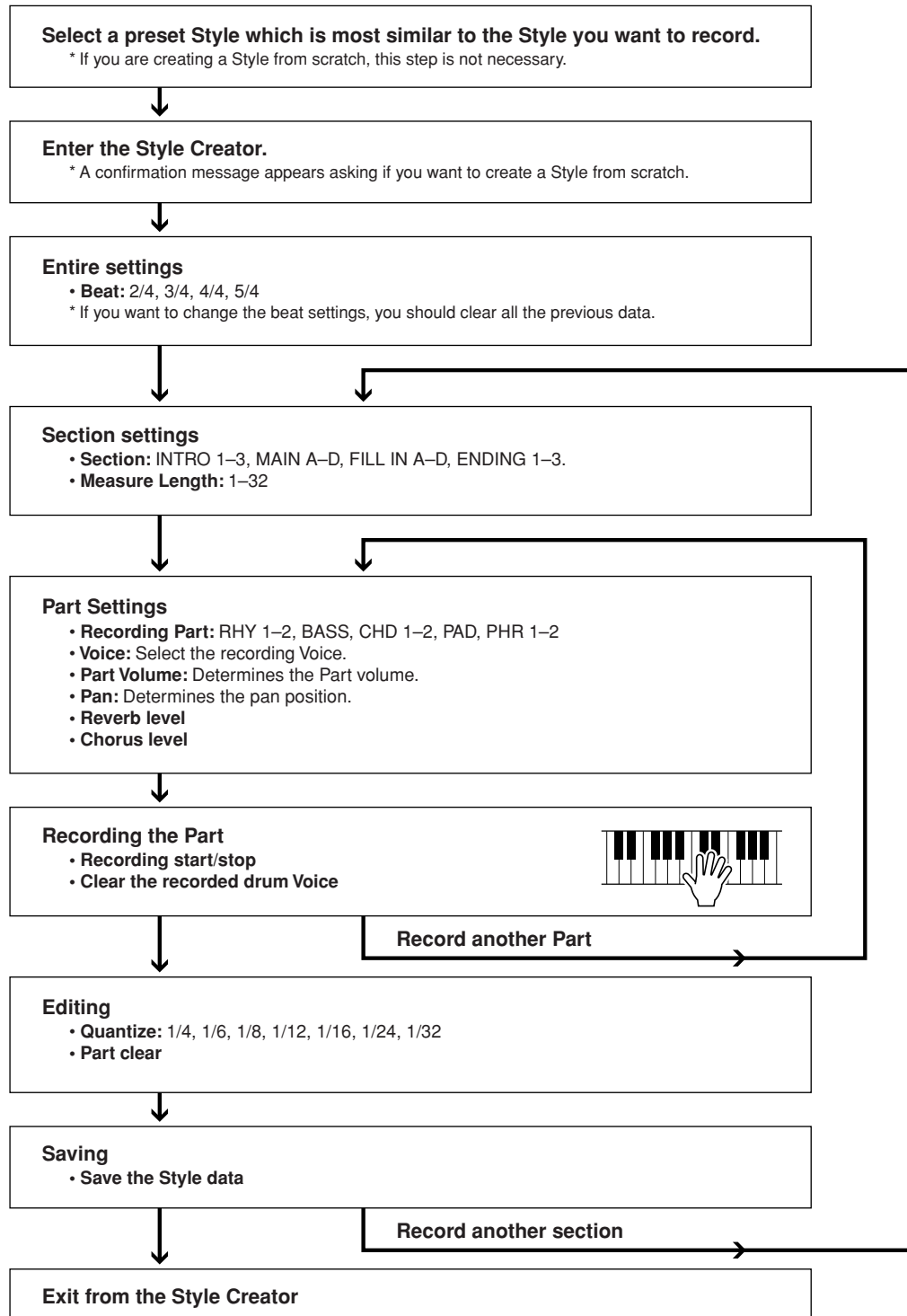

* Press the [EXIT] button whenever you want to exit from the Style Creator (except during recording).

Basic Operation

1 Press one of the [STYLE CATEGORY] buttons.

Select a [STYLE CATEGORY] button which is most similar to the Style you want to create.

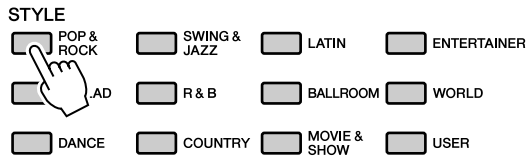

2 Select a Style which is most similar to the Style you want to create.

You can also select a Style from the User Styles.

If you are creating a Style from scratch, go on to the next step.

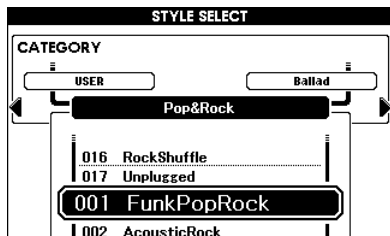
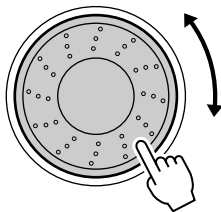

3 Press [REC] and enter the Style Creator operation.



NOTE

• If there is not enough capacity left on the instrument to save the data, an appropriate message will appear in the display. Erase unwanted data from the instrument to make more memory available.

A confirmation message appears.



4 Select the production manner of Style Creator.

If you are creating a Style from scratch, press the [YES] button.

If you are creating a Style by using a specified Style (step 2), press the [NO] button.

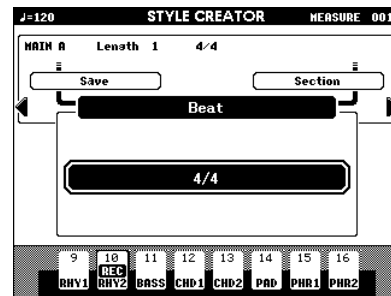

5 Set the desired measures and beats, and then record the Style for each Part and for each section.

6 Save the recorded Style data to a User Style.

7 Press [EXIT] to exit from the Style Creator.

- Adjust individual track volumes before recording.

You can use the mixer function (page 75) to adjust individual track volumes before proceeding with step 3.

Parameter Settings, Recording and Saving

Select the production manner of Style Creator (refer steps 1–4 on page 66) and go on to the next instructions.

■ Entire settings.....

Beat

If you change the Beat value, you will need to clear all data and then make a new Style from scratch.

- 1 Press the CATEGORY[◀]/[▶] button repeatedly until “Beat” appears in the display.

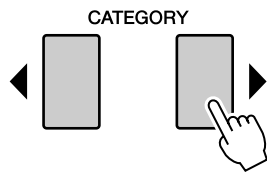

- 2 Rotate the dial and select the Beat number.
Range: 2/4, 3/4, 4/4, 5/4

- 3 Press the [EXECUTE] button to set the Beat.
When you create a Style based on another Style, the following message appears.



If you want to clear the Style and make a new one, press the [+ / YES] button.

■ Section Settings:.....

Select a section

- 1 Press the CATEGORY[◀]/[▶] button repeatedly until “Section” appears in the display.
- 2 Rotate the dial or directly press the [SECTION] button in the STYLE CONTROL area to select a recorded section.
Settings: INTRO 1–3, MAIN A–D, FILL IN A–D, ENDING 1–3

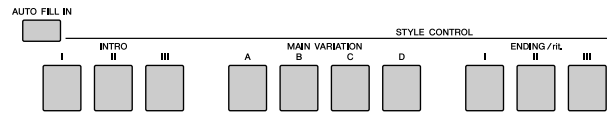
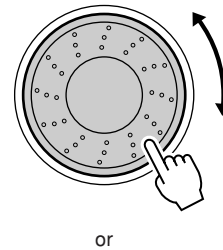

NOTE
• You can also select the FILL IN A–D section by pressing the [AUTO FILL IN] button and then select FILL IN A–D by using the dial.

- 3 Press the [EXECUTE] button to set the section.

Measure Length

- 1 Press the CATEGORY[◀]/[▶] button repeatedly until “Length” appears in the display.
- 2 Rotate the dial and select the Measure Length.
Range: 1–32

NOTE
• If you set a length smaller than that of the previous one, any data existing beyond the new length will be deleted.

- 3 Press the [EXECUTE] button to set the Measure Length.

■ Part Settings:.....

Select a Part

- 1 Press the CATEGORY[◀]/[▶] button repeatedly until “Part” appears in the display.
- 2 Rotate the dial and select a recorded Part.
Range: RHYTHM 1–2, BASS, CHORD 1–2, PAD, PHRASE 1–2
- 3 Press the [EXECUTE] button to set the Part.

Select a Voice

- 1 Press the CATEGORY[◀]/[▶] button repeatedly until “Voice” appears in the display.
- 2 Press a desired [VOICE CATEGORY] button to select the Voice category.
- 3 Rotate the dial to select a Voice.
Range: When **RHY 1** is selected as the Part, all Voices can be selected.
When **RHY 2** is selected as the Part, drum Voices can be selected.
When **other Part** is selected, all Voices excepting drums can be selected.

Part Volume

- 1 Press the CATEGORY[◀]/[▶] button repeatedly until “Part Volume” appears in the display.
- 2 Rotate the dial and set the Part Volume.
Range: 0–127

Pan

- 1 Press the CATEGORY[◀]/[▶] button repeatedly until “Pan” appears in the display.
- 2 Rotate the dial and set the Pan position.
Range: 0–64–127

Reverb Level

- 1 Press the CATEGORY[◀]/[▶] button repeatedly until “Reverb Level” appears in the display.
- 2 Rotate the dial and set the Reverb depth.
Range: 0–127

Chorus Level

- 1 Press the CATEGORY[◀]/[▶] button repeatedly until “Chorus Level” appears in the display.
- 2 Rotate the dial and set the Chorus depth.
Range: 0–127

■ Recording a Part

Part buttons indication

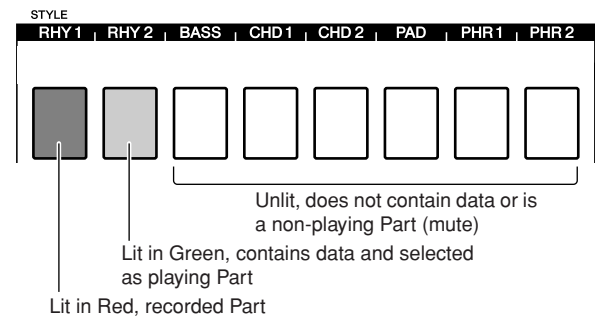

Rhythm Part recording

Confirm that desired section name appears at the upper right area in the display, and then follow the instructions below.

- 1 Simultaneously hold down the [REC] button and press a [RHY 1] or [RHY 2] button in the rhythm Part.
“RHYTHM1” or “RHYTHM2” appears in the display.
- 2 Press the [EXECUTE] button.
A REC mark appears at the recorded Part on the display. In this condition, the [PART] button also changes to red.

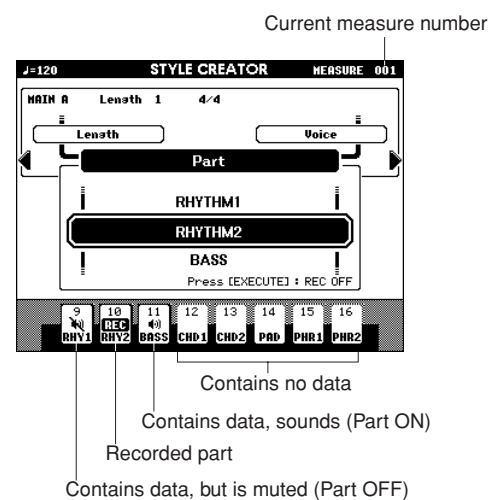

Play the keyboard to check that the appropriate drum Voices can be heard. You can mute the Parts during recording (except for the Part you’re recording), by simply pressing the [PART] button so that the mute mark is indicated at the Part. In this condition, the [PART] button also changes from green to unlit.

If you want to rehearse a part before recording, press the [EXECUTE] button. The REC mark for the Part in the display will turn off.

In this situation, you can start rehearsing by pressing the [START/STOP] button.

Return to the Part record standby mode, after stopping rehearsal by pressing the [START/STOP] button, and then press the [EXECUTE] button again.

3 Press the [START/STOP] button to begin recording.

4 Play the keyboard and record the drum Voices.

Since the entire Style plays repeatedly, you can record at any point you like.

5 Press the [START/STOP] button to stop recording.

Clear the recorded drum Voices

To clear the recorded drum Voices, after starting recording (refer to step 3 of the recording operation), follow the instructions below.

Only the rhythm Part can be cleared in this operation; other Parts (e.g., bass or chord) cannot be cleared.

1 Press and hold the [-] button and play the key or keys that correspond to the cleared Voice.

2 Press the [START/STOP] button to exit from the clear operation.

Bass, Chord, Pad and Phrase Part recording

1 Press and hold the [REC] button and press the appropriate [PART] button to which you want to record.

2 Press the [EXECUTE] button and check that the REC mark appears at the Part in the display. In this condition, the [PART] button also changes to red.

3 Press the [START/STOP] button to begin recording.

4 Play the keyboard and record your playing.

● **Rules for recording to non-rhythm Parts:**

- Use only the CM7 scale tones when recording the Bass and PHRASE Parts (i.e., C, D, E, G, A, and B).
- Use only the C chord tones when recording the CHORD and PAD Parts (i.e., C, E, G, and B).

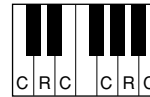

C = Chord notes
C, R = Recommended notes

Using the data recorded here, the auto accompaniment (Style playback) is appropriately converted depending on the chord changes you make during your performance.

NOTE

- Any desired chord or chord progression can be used for the INTRO and ENDING sections.

5 Press the [START/STOP] button to stop recording.

Record to other Parts in other sections.

6 Save the Style data (page 71)

■ Editing (Quantize and part clear)

Quantize

This function allows you to automatically align the timing of all recorded notes.

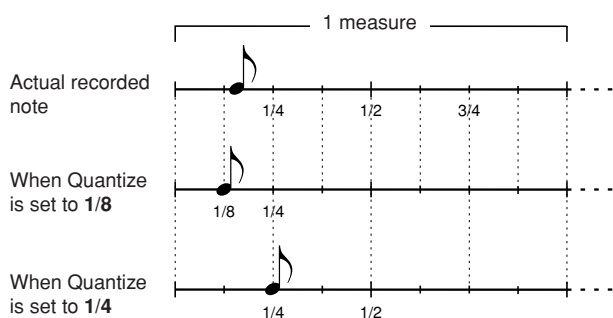

1 Press the CATEGORY[◀]/[▶] button repeatedly until “Quantize” appears in the display.

2 Rotate the dial and select the value.

Settings: 1/4, 1/6, 1/8, 1/12, 1/16, 1/24, 1/32

3 Press the [EXECUTE] button.



The “UNDO” message appears.

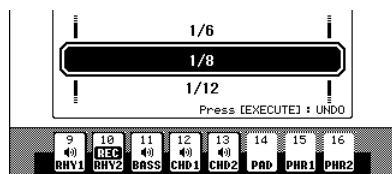

4 Press the [EXECUTE] button again if you want to replace with the previous Quantize value.

NOTE

- If the recorded Part is not specified, Quantize cannot be set. Specify the Part for recording and then use the quantize function.
- The undo icon on the display will disappear if you exit from the current display.

Clearing a recorded Part

Select a desired section for clearing, and then follow the instructions below.

1 Press the CATEGORY[◀]/[▶] button repeatedly until “Part Clear” appears in the display.

2 Press and hold a desired [PART] button for longer than a second.

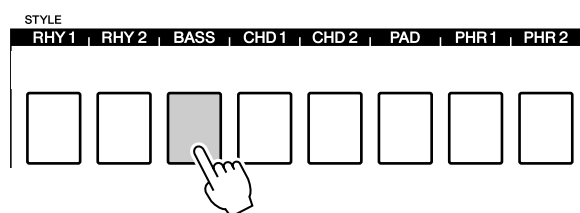

NOTE

- You can also select a Part by rotating the dial. In this case, press the [EXECUTE] button to clear.

A confirmation message appears.

3 Press the [+ / YES] button to clear the selected Part.

Saving the data

Saving the recorded data

1 Press the CATEGORY[◀]/[▶] button repeatedly until “Save” appears in the display.

A new user Style number is applied automatically and indicated in the display.

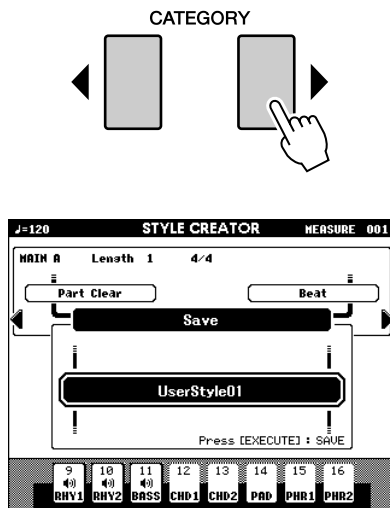

2 If you want to change the user Style number, select the number by using the dial.

CAUTION

- If you select a User Style Number that already contains data, the previous data is deleted and overwritten by the new data.

NOTE

- If you want to exit from the Style Creator without saving, press the [EXIT] button.
- A maximum of 50 Style files can be saved.

3 Press [EXECUTE] button to save the data.



A confirmation message appears.



4 Press [+ / YES] button to save the data.

NOTE

- If you select a User Style Number that already contains data, an “Overwrite?” confirmation prompt appears. If you wish to save and overwrite, press the [+ / YES] button.

The following display appears when saving is complete.

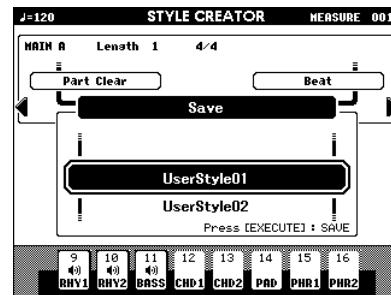

You can go back and set other sections with the Section Settings (page 67) and then record additional parts.

To save the Style to USB flash memory, refer to the “Saving a User Song or User Style” section on page 86.

● Deleting a User Style

- 1 Confirm that USB flash memory is not connected to the [TO DEVICE] terminal.
- 2 Press the [FILE MENU] button.
- 3 Use the Dial to select the user style data you want to delete.
- 4 Press the [EXECUTE] button.
- 5 Press the [+ / YES] button to delete the file.

Song Settings

Song Volume

1 Press the [FUNCTION] button.

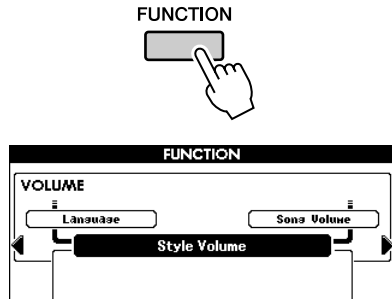

2 Use the CATEGORY [◀] and [▶] buttons as many times as necessary to call up Song Volume.

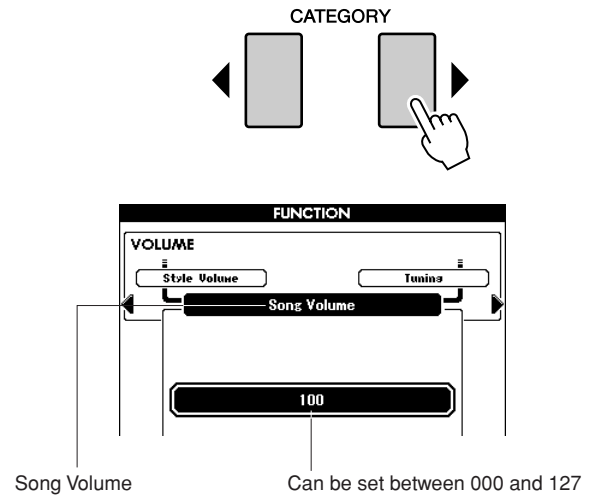

3 Use the dial to set the Song volume between 000 and 127.

NOTE

• Song volume can be adjusted while a Song is selected.

Changing the Tempo

When playing the Song you can change the tempo as required. Press the TEMPO [+] / [-] buttons. The tempo display will appear and you can use the dial or the TEMPO [+] / [-] buttons to set to tempo to anywhere from 5 and 280 quarter-note beats per minute.

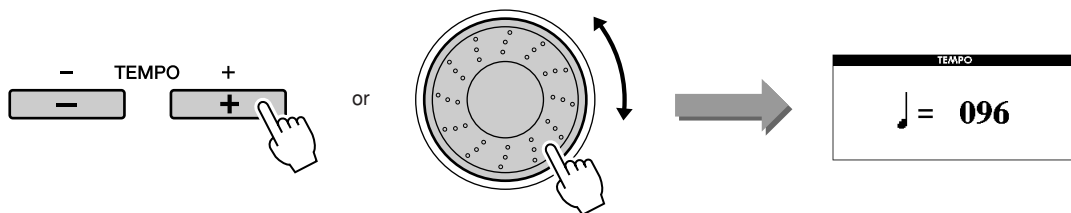

You can return to the original tempo by simultaneously pressing both the TEMPO [+] and [-] buttons. Press the [EXIT] button to return to the Main display. Pressing the TEMPO [+] / [-] buttons allows single-step changes. Pressing and holding either button continuously increases or decreases the value.

A-B Repeat

You can specify a section of a Song—"A" is the start point and "B" is the end point—for repeat playback. The A-B Repeat function is also very convenient for practicing when used along with the score display features of the instrument (page 30).



- 1 Play the Song (page 27) and press the [A ⇌ B] button at the beginning of the section you want to repeat (the "A" point).

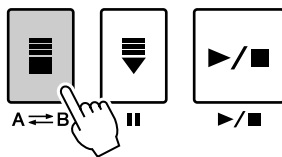

- 2 Press the [A ⇌ B] button a second time at the end of the section you want to repeat (the "B" point).

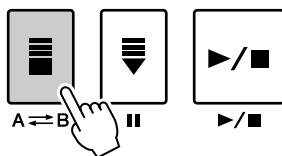

- 3 The specified A-B section of the Song will now play repeatedly.

You can cancel A-B repeat playback at any time by pressing the [A ⇌ B] button.

NOTE

- The current measure number is shown in the display during playback.
- If you want to set the start point "A" at the very beginning of the Song press the [A ⇌ B] button before starting playback of the Song.

Muting Independent Song Parts

Each “track” of a Song plays a different part of the Song—melody, percussion, accompaniment, etc. You can mute individual tracks and play the muted part on the keyboard yourself, or simply mute tracks other than the ones you want to listen to.

Use the [REGIST/PART [MIXER]] button to select the TR 1–8, TR 9–16 and use the SONG PART [1/9]–[8/16] buttons to mute or un-mute the corresponding tracks ([1]–[8], [9]–[16]). Each track button is lit in green when that track is not muted, and is unlit when the track is muted. Furthermore, the border around the track number in the display disappears when that track is muted.

Refer to page 32 for information about the Song track configuration.

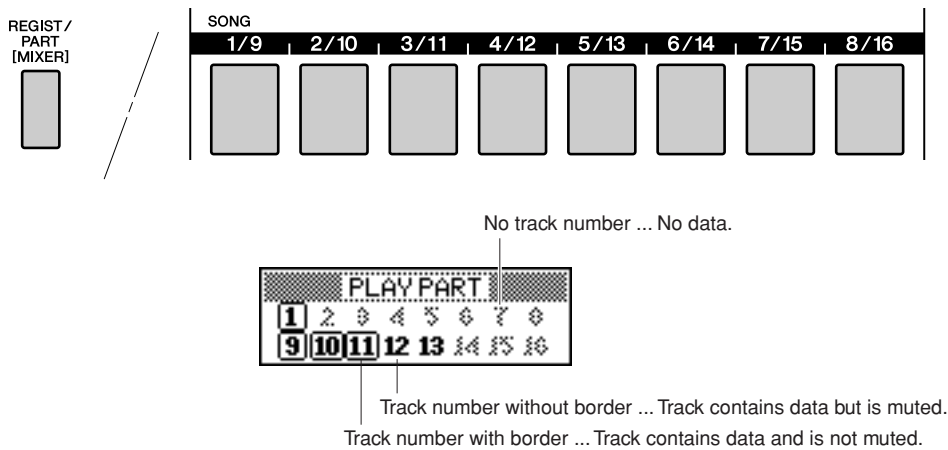

1 Press the [REGIST/PART [MIXER]] button until the desired track is shown on the display.

The following items appear on the display when you press the [REGIST/PART [MIXER]] button.

“REGIST” → “TR 1–8” → “TR 9–16”.

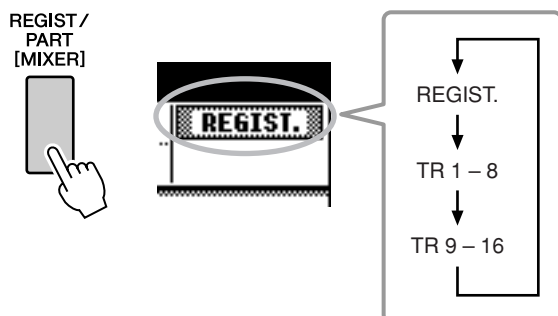

2 Press the desired TRACK [1/9]–[8/16] buttons to set the mute track.

To cancel the mute, press the appropriate REGISTRATION MEMORY [1/9]–[8/16] buttons again.

Display	Setting
TR 1–8	Specify the mute tracks of 1–8 by pressing the [1/9]–[8/16] buttons.
TR 9–16	Specify the mute tracks of 9–16 by pressing the [1/9]–[8/16] buttons.

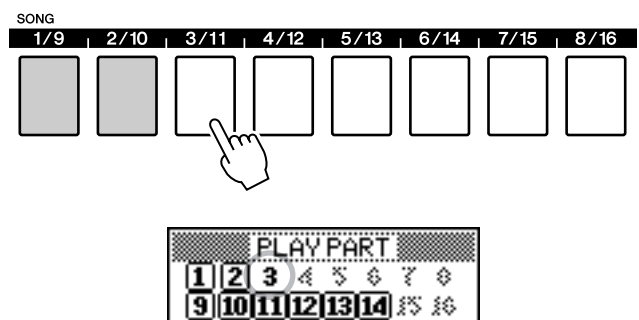

MIXER

This instrument has a MIXER feature that lets you control the Part Volume, Pan, Reverb Level and Chorus Level during playing of the Song or Style.

In the Song mode: Determine the group of track numbers, 1–8 or 9–16, then control the functions below.
 In the Style mode: Directly control the functions below.

- Track ON/OFF
- Select the Mixer Parameter (Volume, Pan, Reverb Level, Chorus Level)

Mixer Display

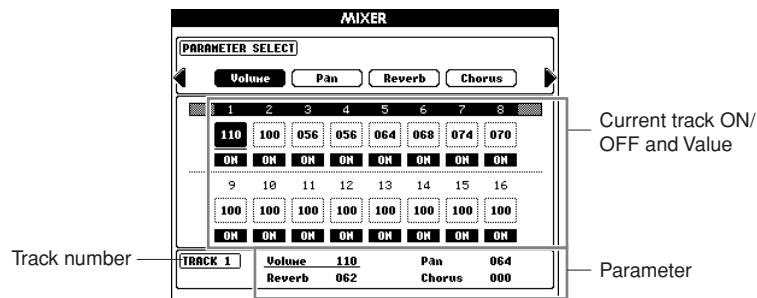

Current track and its value are highlighted on the display.
 In this example, Track 1 is selected and is set to ON, and its volume is 110.

Basic operation

1 Press and hold the [REGIST/PART [MIXER]] button for longer than a second so that the Mixer display appears.

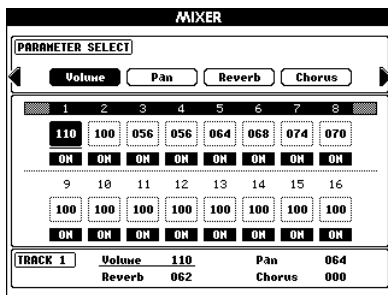

Control the parameter by using the dial or the [+ / YES], [- / NO] buttons.

To exit the mixer operation, press the [EXIT] button.

2 When in the Song mode, press the [REGIST/PART [MIXER]] button and select the desired group of tracks, 1–8 or 9–16.

The button toggles between tracks 1–8 and 9–16.

In the Style mode, tracks 9–16 are selected automatically.

When track 1–8 is selected

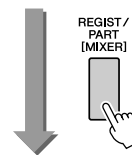
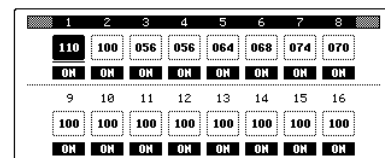

When track 9–16 is selected

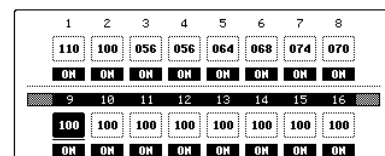

3 Press the desired [TRACK] button you want to control.

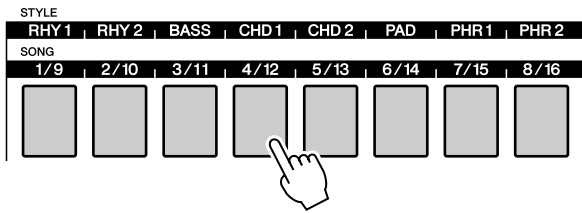

The selected track will be changed to ON automatically.

4 Control the Parameter ON/OFF or other parameters in each track.

(Refer to the following instructions.) Repeat steps 2–4 and set other tracks if necessary.

5 Press [EXIT] to exit from the mixer operation.



Track ON/OFF and other parameter controls

■ Track ON/OFF

Determines whether each is track ON or OFF (unmuted or muted)

Select the track you want to set ON/OFF (refer to steps 1–3 of basic operation on page 75), and then follow the instructions below.

The selected track will be changed to ON automatically.

1 Press the [TRACK] button again to set it to OFF.

The button toggles between ON and OFF, and the [TRACK] button also changes between Green to unlit.

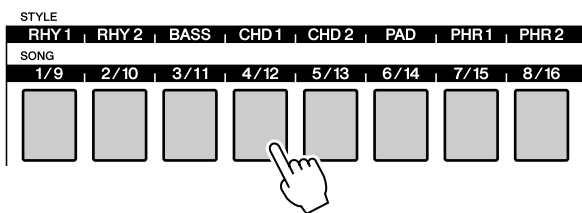

■ Parameter controls

Enter the Mixer mode (refer to steps 1–3 of basic operation on page 75), and then set the Volume, Pan, Reverb Level and Chorus Level.

Volume	Determines the Part volume.	Range: 0–127
Pan	Determines the Pan position.	Range: 0–64–127
Reverb Level	Determines the Reverb depth.	Range: 0–127
Chorus Level	Determines the Chorus depth.	Range: 0–127

1 Press the CATEGORY [◀/▶] button to select the desired item.

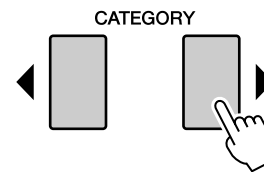

2 Rotate the dial and set the parameter.

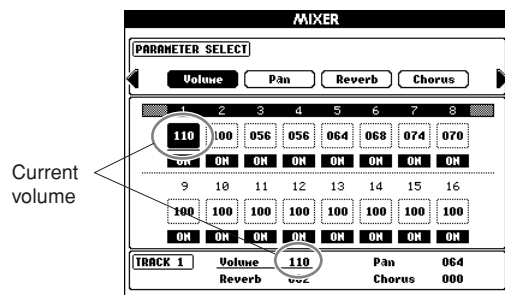
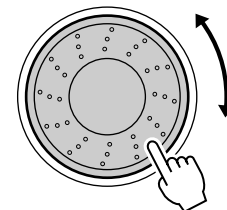

Repeat steps 1–2 and set other tracks if necessary.

3 Press the [EXIT] button to exit from the mixer operation.

Memorize Your Favorite Panel Settings

This instrument has a Registration Memory feature that lets you save your favorite settings for easy recall whenever they're needed. Up to 64 complete setups can be saved (8 banks of 8 setups each).

Up to 64 presets (eight banks of eight each) can be memorized.

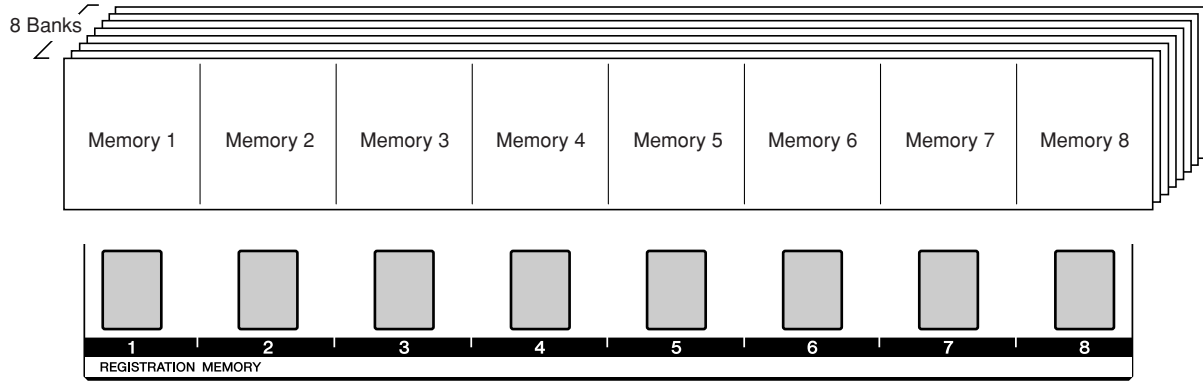

Color is used to indicate the status of individual memory buttons for the selected bank.

- Lit in GreenContains data
- UnlitDoes not contain data
- Lit in RedCurrently set button

Saving to the Registration Memory

- 1 Set the panel controls as required—select a Voice, accompaniment Style, etc.
- 2 Press the REGIST BANK [+]/[-] buttons until the desired bank number is shown on the display.

You can also use the dial in the Bank Select display.

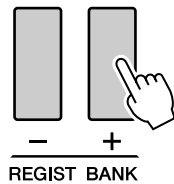

Bank number

NOTE

- Data cannot be saved to the registration memory during Song playback.

- 3 To store the current panel settings, simultaneously hold down the [MEMORY] button and press one of the REGISTRATION MEMORY [1]–[8] buttons.

The button corresponding to the stored Registration lights in Red.

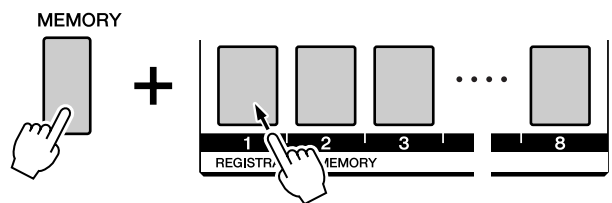

NOTE

- You can also save your panel settings memorized to registration memory button into USB flash memory as a user file (see page 85).

CAUTION

- If you select a Registration Memory number that already contains data, the previous data is deleted and overwritten by the new data.

CAUTION

- Do not turn off the power while saving settings to the registration memory, otherwise the data may be damaged or lost.

Recalling a Registration Memory

Make sure that “REGIST” appears in the display (press the [REGIST/PART [MIXER]] button until it is shown).



1 Press the REGIST BANK [+]/[-] button to select the desired bank.

You can also use the dial to select the bank number.

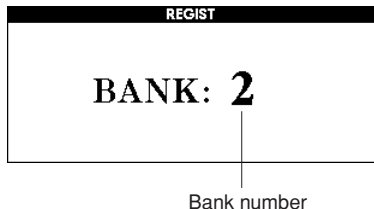
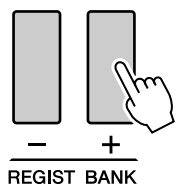

2 Press the REGISTRATION MEMORY button, [1]–[8], containing the settings you want to recall. The panel controls will be instantly set accordingly.

The button to which the data is stored lights in green and the currently set button is in red.

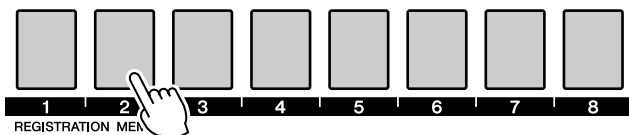

● Settings that can be saved to the Registration Memory

• Style settings*

Style number, Auto Accompaniment ON/OFF, Split Point, Style settings (Main A–D, INTRO 1–3, ENDING 1–3), Style Volume, Tempo, Chord Fingering, Upper Octave

• Voice settings

Main Voice setting (Voice number, Volume, Octave, Pan, Reverb Level, Chorus Level, DSP Level, Dry Level), Dual Voice settings (Dual ON/OFF, Voice number, Volume, Octave, Pan, Reverb Level, Chorus Level, DSP Level, Dry Level), Left Voice settings (Left ON/OFF, Voice number, Volume, Octave, Pan, Reverb Level, Chorus Level, DSP Level, Dry Level)

• Effect settings

Reverb Type, Chorus Type, Panel Sustain ON/OFF, DSP ON/OFF, DSP Type

• Harmony settings

Harmony ON/OFF, Harmony Type, Harmony Volume

• Other settings

Transpose, Pitch Bend Range, Upper Octave

*Style settings are not available for Registration Memory when using the Song features.

Registration Clear—Deleting a Specified Registration Memory

Keep in mind that groups of data cannot be deleted or cleared from the instrument at a single time.

- 1 Press the [REGIST/PART [MIXER]] button a number of times until the “REG-IST.” item appears.**

The item changes in order from “REGIST.” to “TR 1–8” to “TR 9–16”.

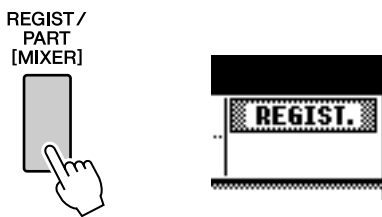

- 2 Press the REGIST BANK [+]/[-] button a number of times until the desired bank number appears.**

The Registration Memory button is lit in green if Registration data is stored to the memory.

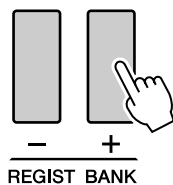

- 3 Press and hold the REGISTRATION MEMORY button corresponding to the Registration you want to clear for longer than a second.**

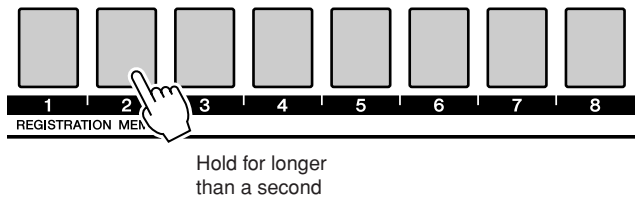

A confirmation message will appear in the display.

- 4 Press the [+ / YES] button to clear a Registration Memory.**

A confirmation message will appear again in the display. Use the [- / NO] button to cancel the clear operation.

- 5 Press the [+ / YES] button again to clear the Registration Memory.**

The clear-in-progress message will appear briefly on the display while the Song is being cleared.

The Functions

The “Functions” provide a wide range of both detailed and overall instrument parameters, such as adjusting the tuning, setting the split point, and editing the voices and effects.

Selecting and Setting Functions

There are 51 function parameters in all.

1 Find the function you want to set in the list that begins on page 81.

2 Press the [FUNCTION] button.

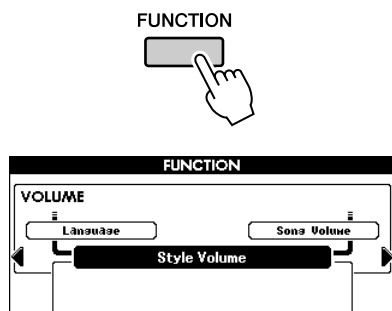

3 Select a function. Press the CATEGORY [◀] and [▶] buttons as many times as necessary until the function’s display name appears in the display.

Take a look at the function list starting on page 81.

The name of the previous item in the list appears to the upper left, and the name of the next item in the list appears to the upper right of the currently selected item.

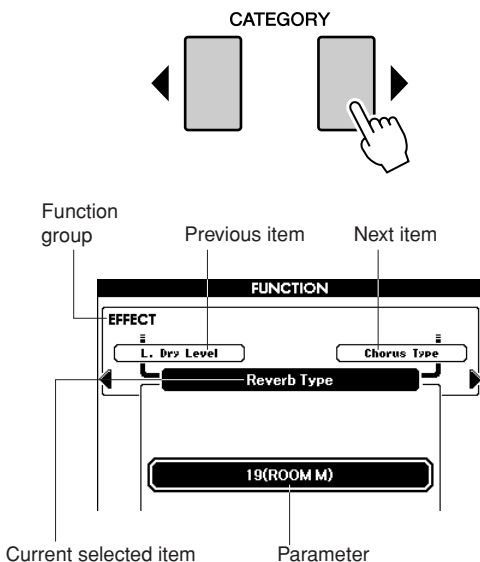

4 Use the dial or the [+ / YES] and [- / NO] buttons, to set the parameters.

The [+ / YES] and [- / NO] buttons are used to make ON / OFF type settings: [+ / YES] = ON, [- / NO] = OFF.

In some cases, pressing the [+ / YES] button will execute the selected function, and pressing [- / NO] will cancel the selection. Press the [+ / YES] and [- / NO] buttons simultaneously to recall the default setting (excepting the initial setup of MIDI).

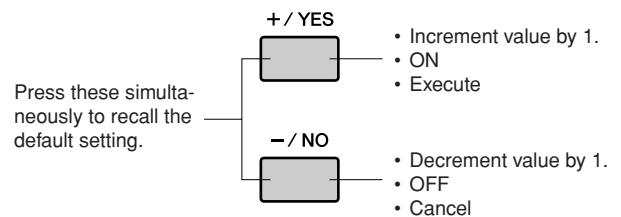

■ Function Setting List

Group	Function Item	Display Indication	Range/Settings	Description
VOLUME	Style Volume	Style Volume	000–127	Determines the volume of the Style.
	Song Volume	Song Volume	000–127	Determines the volume of the Song.
OVERALL	Tuning	Tuning	415.3–466.2	Sets the pitch of the instrument's sound.
	Pitch Bend Range	Pitch Bend Range	01–12	Sets the pitch bend range in semitone increments.
	Split Point	Split Point	036–096 (C1–C6)	Determines the highest key for the Split Voice and sets the Split "point"—in other words, the key that separates the Split (lower) and Main (upper) Voices. The Split Point setting and Accompaniment Split Point setting are automatically set to the same value.
	Touch Sensitivity	Touch Sensitivity	1 (Soft), 2 (Medium), 3 (Hard)	Determines the sensitivity of the feature.
	Chord Fingering	Chord Fingering	1 (Multi Finger), 2 (FullKeyboard)	Sets the chord detection mode. In the Multi Finger mode both normal chords and simple chords played to the left of the split point are detected. In the Full Keyboard mode normal chords played anywhere on the keyboard will be detected, and the notes played will sound as well.
MAIN VOICE	Volume	Main Volume	000–127	Determines the volume of the Main Voice.
	Octave	Main Octave	-2–+2	Determines the octave range for the Main Voice.
	Pan	Main Pan	000 (left)– 64 (center)– 127 (right)	Determines the pan position of the Main Voice in the stereo image. The value "0" results in the sound being panned full left; the value "127" results in the sound being panned full right.
	Reverb Level	Main Reverb Level	000–127	Determines how much of the Main Voice's signal is sent to the Reverb effect.
	Chorus Level	Main Chorus Level	000–127	Determines how much of the Main Voice's signal is sent to the Chorus effect.
	DSP Level	Main DSP Level	000–127	Determines how much of the Main Voice's signal is sent to the DSP effect.
	Dry Level	Main Dry Level	000–127	Determines how much of the Main Voice's unprocessed signal sounds (no Reverb, Chorus or DSP effect processing).
DUAL VOICE	Volume	Dual Volume	000–127	Determines the volume of the Dual Voice.
	Octave	Dual Octave	-2–+2	Determines the octave range for the Dual Voice.
	Pan	Dual Pan	000 (left)– 64 (center)– 127 (right)	Determines the pan position of the Dual Voice in the stereo image. The value "0" results in the sound being panned full left; the value "127" results in the sound being panned full right.
	Reverb Level	Dual Reverb Level	000–127	Determines how much of the Dual Voice's signal is sent to the Reverb effect.
	Chorus Level	Dual Chorus Level	000–127	Determines how much of the Dual Voice's signal is sent to the Chorus effect.
	DSP Level	Dual DSP Level	000–127	Determines how much of the Dual Voice's signal is sent to the DSP effect.
	Dry Level	Dual Dry Level	000–127	Determines how much of the Dual Voice's unprocessed signal sounds (no Reverb, Chorus or DSP effect processing).
LEFT VOICE	Volume	Left Volume	000–127	Determines the volume of the Left Voice.
	Octave	Left Octave	-2–+2	Determines the octave range for the Left Voice.
	Pan	Left Pan	000 (left)– 64 (center)– 127 (right)	Determines the pan position of the Left Voice in the stereo image. The value "0" results in the sound being panned full left; the value "127" results in the sound being panned full right.
	Reverb Level	Left Reverb Level	000–127	Determines how much of the Left Voice's signal is sent to the Reverb effect.
	Chorus Level	Left Chorus Level	000–127	Determines how much of the Left Voice's signal is sent to the Chorus effect.
	DSP Level	Left DSP Level	000–127	Determines how much of the Left Voice's signal is sent to the DSP effect.
	Dry Level	Left Dry Level	000–127	Determines how much of the Left Voice's unprocessed signal sounds (no Reverb, Chorus or DSP effect processing).

Group	Function Item	Display Indication	Range/Settings	Description
EFFECT	Reverb Type	Reverb Type	01–36	Determines the Reverb type, including off (36). (See the list on page 126)
	Chorus Type	Chorus Type	1–45	Determines the Chorus type, including off (45). (See the list on page 127)
	DSP Type	DSP Type	001–239	Determines the DSP type, including off (239). (See the list on page 128)
	Master EQ Type	Master EQ Type	1 (Speaker 1), 2 (Speaker 2), 3 (Headphones), 4 (Line Out 1), 5 (Line Out 2)	Sets the equalizer applied to the instrument output (including speakers, headphones or other output) for optimum sound in different listening situations.
HARMONY	Harmony Type	Harmony Type	01–26	Determines the Harmony type. (See the list on page 125)
	Harmony Volume	Harmony Volume	000–127	Determines the volume of the Harmony effect.
PC MODE	PC Mode	PC Mode	PC1/PC2/OFF	Optimizes the MIDI settings for connecting to a computer (page 95).
MIDI	Local ON/OFF	Local	ON/OFF	Determines whether the instrument's keyboard controls the internal tone generator (ON) or not (OFF). (page 94)
	External Clock ON/OFF	External Clock	ON/OFF	Determines whether the instrument synchronizes to the internal clock (OFF) or an external clock (ON). (page 94)
	Keyboard Out	Keyboard Out	ON/OFF	Determines whether keyboard performance data of the instrument is transmitted (ON) or not (OFF).
	Style Out	Style Out	ON/OFF	Determines whether Style data is transmitted (ON) via USB TO HOST or not (OFF) during Style playback.
	Song Out	Song Out	ON/OFF	Determines whether Song data is transmitted (ON) via USB TO HOST or not (OFF) during Song playback.
	Initial Setup	Initial Setup	YES/NO	Allows you to instantly send a data 'snapshot' of all panel settings to a computer or sequencer. Press [+ / YES] to send, or press [- / NO] to cancel.
METRONOME	Time Signature Numerator	Time Signature Numerator	00–60	Determines the time signature of the Metronome.
	Time Signature Denominator	Time Signature Denominator	2, 4, 8, 16	Sets the length of each metronome beat.
	Bell ON/OFF	Bell	ON/OFF	Determines whether the Metronome bell sounds at the first beat in each measure or not.
	Volume	Metronome Volume	000–127	Determines the volume of the Metronome.
SCORE	Quantize	Quantize	1 (1/4 note), 2 (1/4 note triplet), 3 (1/8 note), 4 (1/8 note triplet), 5 (1/16 note), 6 (1/16 note triplet), 7 (1/32 note), 8 (1/32 note triplet)	Depending on the Song data, you can make the score more readable by adjusting the timing of the notes. This determines the minimum timing resolution used in the Song. For example, if there are both quarter notes and eighth notes in the Song, you should set this value to "eighth note." Any notes or rests shorter than this value will not be shown in the score.
	Right-Part	Right-Part	GuideTrack 1–16	Determines the guide track number for your right hand lesson. The setting is effective for Songs except for preset Songs.
	Left-Part	Left-Part	GuideTrack 1–16	Determines the guide track number for your left hand lesson. The setting is effective for Songs except for preset Songs.
UTILITY	Demo Cancel	Demo Cancel	ON/OFF	Determines whether Demo cancel is enabled or not. When this is set to ON, the Demo Song will not play, even if the [DEMO] button is pressed.
	TG Mode	TG Mode	XG/Normal	Determines whether the external Song is played accurately in XG format or not. When it is set to XG, the external Song is played accurately in XG format, but the Song data may cause changes in the sound of your keyboard-played parts.
LANGUAGE	Language	Language	English/Japanese	Determines the display language for the demo displays, Song file names, lyrics and certain display messages. All other messages and names are displayed in English. When this is set to Japanese, the file names are displayed in the Japanese font. The lyrics display follows the language setting originally made in the Song data; however, when no such setting exists, the setting here is used.

* All these settings can be conveniently reset to their initial default values by pressing the [+ / YES] and [- / NO] buttons simultaneously. (The exception to this is Initial Send, which is an operation, not a setting.)

Using USB Flash Memory

USB flash memory is a memory medium used for storing data. When a USB flash memory device is inserted in this instrument's USB TO DEVICE terminal, user Songs and user Styles created on the instrument and the registered settings can be saved to or loaded from the device. USB flash memory can also be used to transfer Song, Style MDB data downloaded from the Internet to the instrument. Furthermore, user Songs saved to USB flash memory in MIDI file format can also be used with these features. In this section we'll look at the procedures for setting up and formatting USB flash memory devices, as well as for saving and loading data to and from them.

If you don't have a USB flash memory device, you will need to purchase one (or more, as needed).

The instrument does not necessarily support all commercially available USB storage devices. Yamaha cannot guarantee operation of USB storage devices that you purchase. Before purchasing a USB storage device, please consult your Yamaha dealer, or an authorized Yamaha distributor (see list at end of the Owner's Manual) for advice.

Before using a USB device, read through the "Precautions when using the [USB TO DEVICE] terminal" section on page 93. For information about USB devices compatible with the instrument, see "Connection to a USB Storage Device" on page 90.

Using USB Flash Memory

1 Connect a USB flash memory to the USB TO DEVICE terminal, being careful to insert it in the proper direction. (Do not try to force an improper connection.)

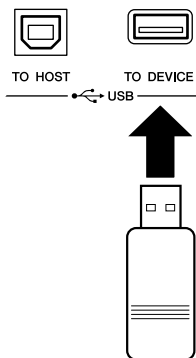

2 Check that the "CONNECT" message is shown in the MAIN display.

NOTE

No sound will be produced if you play the keyboard while the FILE CONTROL display is showing. Also, in this state only buttons related to file functions will be active.

NOTE

The FILE CONTROL display will not appear in any of the following cases:

- During style or song playback.
- While data is being loaded from a USB flash memory.

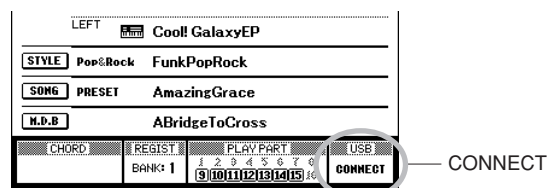

You can go to the FILE CONTROL display from which you can access USB flash memory operations by pressing the [FILE MENU] button from this display. (Do not press this button now, but only when instructed to in the sections below.)

Menu	Reference Page
USB Format	84
Load	87
Regist Save	85
User Song Save	86
User Style Save	86
USB Delete	88
*User Delete	88

* This particular menu item has no relation to USB operations, but it can be used to delete a User Song.

A message (information or confirmation dialog) sometimes appears in the display to facilitate operation. Refer to the "Messages" section on page 108 for an explanation of each message.

Formatting USB Flash Memory

A new USB flash memory device must be formatted before it can be used by this instrument.

CAUTION

• If you format a USB flash memory that already contains data, all of the data will be erased. Be careful not to erase important data when using the format function.

1 After connecting the USB flash memory to be formatted to the instrument's USB TO DEVICE terminal, check that the "CONNECT" message is shown in the MAIN display.

2 Press the [FILE MENU] button.



3 Use the CATEGORY [◀] and [▶] buttons to select the USB Format item.

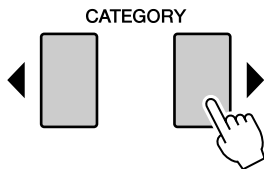

The display prompts you for confirmation.

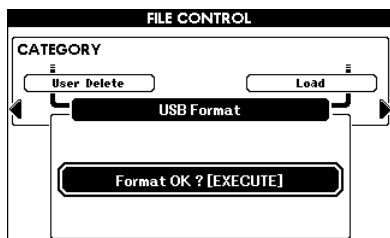

4 Press the [EXECUTE] button and the display prompts you for confirmation.

You can press the [-/NO] button at this point to cancel the operation.

5 Press the [EXECUTE] button again, or the [+ /YES] button, and the format operation will begin.

CAUTION

• Once the format-in-progress message appears in the display, the format operation cannot be canceled. Never turn off the power or remove the USB flash memory device during this operation.

6 A message appears in the display indicating that the operation is complete.

Press the [EXIT] button to return to the MAIN display.

NOTE

• If the USB flash memory device has been write-protected, an appropriate message will appear in the display and you will not be able to execute the operation.

Saving the Registration Data

The registration data you created in the instrument can be saved to a USB flash memory device.

1 Make sure that a appropriately formatted USB flash memory device has been properly connected to the instrument's USB TO DEVICE terminal, and that a "CONNECT" message is shown in the MAIN display.

2 Press the [FILE MENU] button.

3 Use the CATEGORY [◀] and [▶] buttons to locate the Regist Save item.

A default file name will automatically be created.

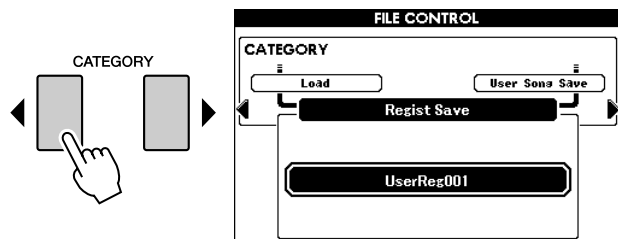

● To Overwrite an Existing File

If you want to overwrite a file that already exists on the USB flash memory device, use the dial or the [+ / YES] and [- / NO] buttons to select the file, then skip ahead to step 6.

NOTE

- If the USB flash memory has been write-protected, an appropriate message will appear in the display and you will not be able to execute the operation.
- If there is not enough capacity left on the USB flash memory device to save the data, an appropriate message will appear in the display and you will not be able to save the data. Erase unwanted files from the USB flash memory device to make more memory available (page 88), or use a different USB device.
- Refer to the "Messages" list on page 108 for other possible errors that might prevent you from completing the operation.

4 Press the [EXECUTE] button. A cursor will appear below the first character in the file name.

5 Change the file name as necessary.

- The [1] button moves the cursor to the left, and the [2] button moves it to the right.
- Use the dial to select a character for the current cursor location.
- The [8] button deletes the character at the cursor location.

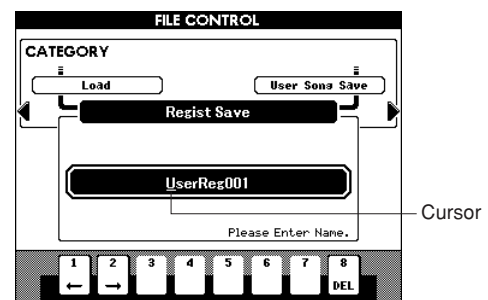
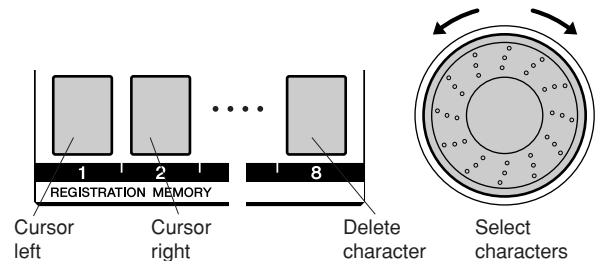

6 Press the [EXECUTE] button. The display prompts you for confirmation.

You can cancel the save operation at this point by pressing the [- / NO] button.

7 Press the [EXECUTE] button again, or the [+ / YES] button, and the save operation will begin.

The Registration data will be stored to the USER FILE folder in the USB flash memory device.

CAUTION

- Once the save-in-progress message appears in the display, the operation cannot be canceled. Never turn off the power or remove the USB flash memory device during this operation.

8 Press the [EXIT] button to return to the MAIN display.

NOTE

- If an existing filename is specified the display prompts you for confirmation. Press [EXECUTE] or [+ / YES] if it is OK to overwrite the file, or [- / NO] to cancel.
- The amount of time it will take to perform the save operation depends on the particular USB flash memory device you are using.

Saving a User Song or User Style

This operation saves user Songs (Song numbers 001–005) or user Styles to USB flash memory. Songs are saved in SMF Format 0.

● What is SMF (Standard MIDI File)?

The SMF (Standard MIDI File) format is one of the most common and widely compatible sequence formats used for storing sequence data. There are two variations: Format 0 and Format 1. A large number of MIDI devices are compatible with SMF Format 0, and most commercially available MIDI sequence data is provided in SMF Format 0.

1 Make sure that a properly formatted USB flash memory device has been properly connected to the instrument's USB TO DEVICE terminal, and that the "CONNECT" message is shown in the MAIN display.

2 Press the [FILE MENU] button.

3 Use the CATEGORY [◀] and [▶] buttons to locate the User Song or User Style Save item.

The SOURCE FILE—a user Song name or a user Style name—will be highlighted.

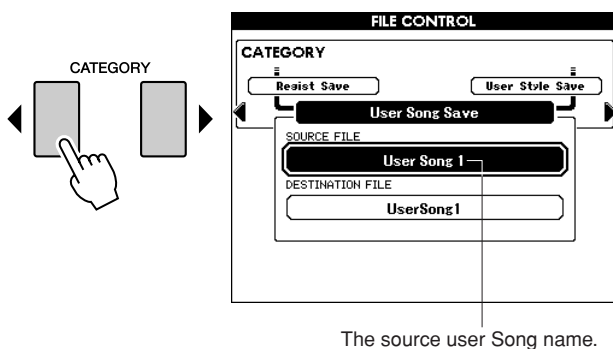

4 Use the dial to select the source user Song or Style.

You can press the [+ / YES] and [- / NO] buttons simultaneously to select the first user Song or Style.

5 Press the [EXECUTE] button.

The destination Song or Style will be highlighted, and a default name will appear for the converted Song or Style file.

● To Overwrite an Existing File

If you want to overwrite a file that already exists on the USB flash memory device, use the dial or the [+ / YES] and [- / NO] buttons to select the file, then skip ahead to step 8.

6 Press the [EXECUTE] button. A cursor will appear below the first character in the file name.

7 Change the file name as necessary.

Refer to "Saving the Registration Data" on page 85 for filename entry.

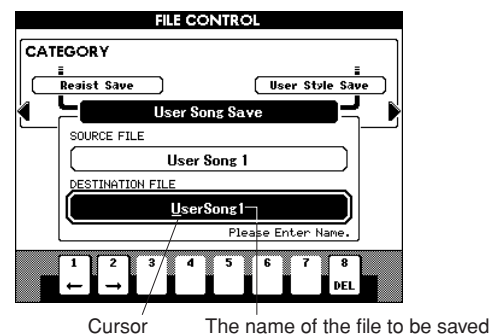

8 Press the [EXECUTE] button. The display prompts you for confirmation.

You can cancel the save operation at this point by pressing the [- / NO] button.

9 Press the [EXECUTE] button again, or the [+ / YES] button, and the save operation will begin.

The user Song will be stored to the USER FILE folder in the USB flash memory device.

⚠ CAUTION

- Once the save-in-progress message appears in the display, the operation cannot be canceled. Never turn off the power or remove the USB flash memory during this operation.

10 A message appears in the display indicating that the operation is complete.

Press the [EXIT] button to return to the MAIN display.

NOTE

- If an existing filename is specified, the display prompts you for confirmation. Press [EXECUTE] or [+ / YES] if it is OK to overwrite the file, or [- / NO] to cancel.
- The amount of time it will take to perform the save operation depends on the particular USB flash memory device you are using.

Loading Registration Files, Style Files, Song Files or MDB Files

Registration files, Style files, Song files and MDB files residing on a USB flash memory can be loaded to the instrument.

You can also play the Song or Style file directly without loading (see page 89).

CAUTION

- If the same file name already exists in the instrument's internal memory, it will be overwritten.

1 With the USB flash memory device containing the file you want to load connected to the USB TO DEVICE connector, check that the "CONNECT" message is shown in the MAIN display.

2 Press the [FILE MENU] button.

3 Use the CATEGORY [◀] and [▶] buttons to locate the Load item.

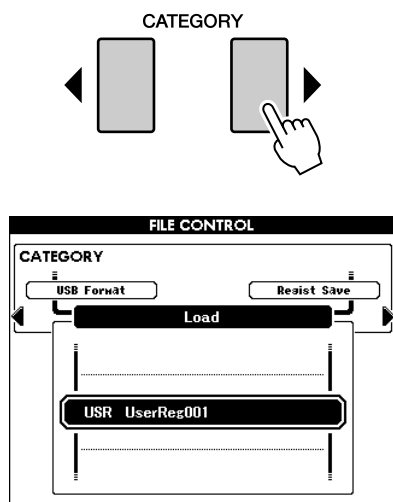

4 Use the dial to select the Registration, Style, Song or MDB file you want to load.

All user files in the USB flash memory device will be displayed first, followed by the Registration files.

NOTE

- The instrument will not recognize the style file if it is moved out of the USER FILES folder.

5 Press the [EXECUTE] button. The display prompts you for confirmation.

You can cancel the load operation at this point by pressing the [-/NO] button.

6 Press the [EXECUTE] button again, or the [+ /YES] button, and the load operation will begin.

CAUTION

- Once the load-in-progress message appears in the display, the operation cannot be canceled. Never turn off the power or remove the USB flash memory during this operation.

7 A message appears in the display indicating that the operation is complete.

Press the [EXIT] button to return to the MAIN display.

Deleting Data from USB Flash Memory

This procedure deletes selected Registration files, Song files and Style files from a USB flash memory device.

- 1** Make sure that the USB flash memory device containing the file(s) you want to delete has been properly connected to the instrument's USB TO DEVICE terminal, and that the "CONNECT" is shown in the MAIN display.
- 2** Press the [FILE MENU] button.
- 3** Use the CATEGORY [◀] and [▶] buttons to locate the USB Delete item.

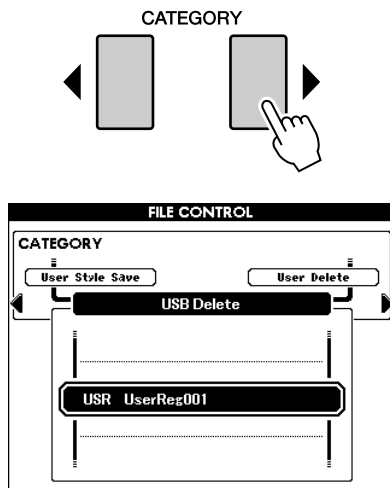

- 4** Select the file you want to delete.
You can press the [+ / YES] and [- / NO] buttons simultaneously to select the first Song or user file on the USB flash memory.

- 5** Press the [EXECUTE] button. The display prompts you for confirmation.
You can cancel the delete operation at this point by pressing the [- / NO] button.
- 6** Press the [EXECUTE] button again, or the [+ / YES] button, and the delete operation will begin.

⚠ CAUTION

- Once the delete-in-progress message appears in the display, the operation cannot be canceled. Never turn off the power or remove the USB flash memory during this operation.

- 7** A message appears in the display indicating that the operation is complete.
Press the [EXIT] button to return to the MAIN display.

NOTE

- If the USB flash memory has been write-protected, an appropriate message will appear in the display and you will not be able to execute the operation.

● User Delete

This procedure deletes the selected User Songs in the instrument's internal memory.

- 1** Press the [FILE MENU] button.
- 2** Use the CATEGORY [◀] and [▶] buttons to locate the User Delete item.
- 3** Follow the procedure described above from step 4.

Playing Songs or Styles Saved to USB Flash Memory

- 1** Make sure that the USB flash memory device containing the Song or Style you want to play has been properly connected to the instrument's USB TO DEVICE terminal, and that the "CONNECT" is shown in the MAIN display.
- 2** To play a Song file, press the [SONG MODE] button so that it lights. To play a Style file, press the [SONG MODE] button so that it is unlit.
- 3** Press the [USB] button.

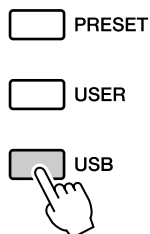

- 4** Use the dial to select a Song or a Style you want to play.

Songs can be saved in a hierarchy when saved to USB flash memory using a computer (refer to page 91).

You can move the directory in the USB memory by pressing the CATEGORY [◀]/[▶] button.

- 5** Press the [▶/■] button.

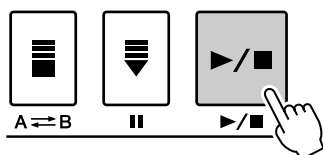

Connectors

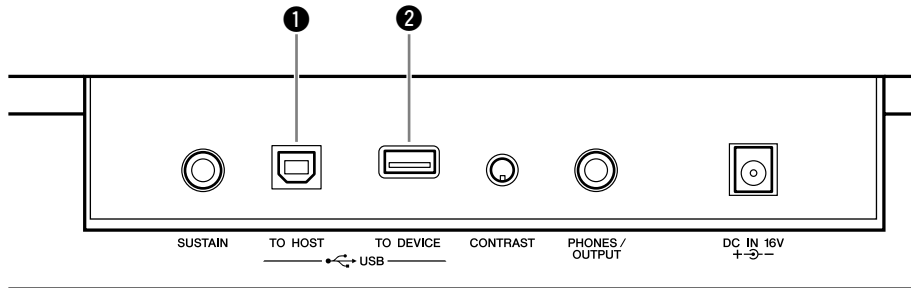

1 USB TO HOST terminal

This terminal allows direct connection to a personal computer. Refer to “Connecting a Personal Computer” on page 92 for more information.

2 USB TO DEVICE terminal

This terminal allows connection to USB storage devices. Refer to “Connection to a USB Storage Device” below.

Connection to a USB Storage Device

By connecting the instrument to a USB storage device, you can save data you’ve created, as well as read or play the data from the connected device.

Compatible USB storage devices

A USB storage device, such as a floppy disk drive and flash memory can be connected to the USB TO DEVICE terminal. Other USB devices such as a computer keyboard or mouse cannot be used.

Before purchasing USB storage devices, please consult your Yamaha dealer, or an authorized Yamaha distributor (see list at end of the Owner’s Manual) for advice.

CAUTION

- Avoid frequently turning the power on/off to the USB storage device, or connecting/disconnecting the cable too often. Doing so may result in the operation of the instrument “freezing” or hanging up. While the instrument is accessing data (such as in the Save and Delete operations), do NOT unplug the USB cable, do NOT remove the media from the device, and do NOT turn the power off to either device. Doing so may corrupt the data on either or both devices.

Connection to a USB storage device

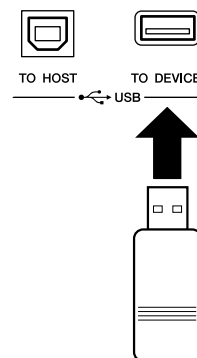

CAUTION

- Some USB memory devices may require more current than the instrument can supply, causing the instrument’s over-current protection function to be activated and making it impossible to use the device. If this occurs “OverCurrent” will appear in the lower-right area of the MAIN display. To restore normal operation remove the USB device from the USB TO DEVICE connector and turn the instrument’s power off and then back on again.

Backing up the instrument data to a computer

Once you've saved data to a USB flash memory device, you can copy the data to the hard disk of your computer, then archive and organize the files as desired. Simply reconnect the device as shown below.

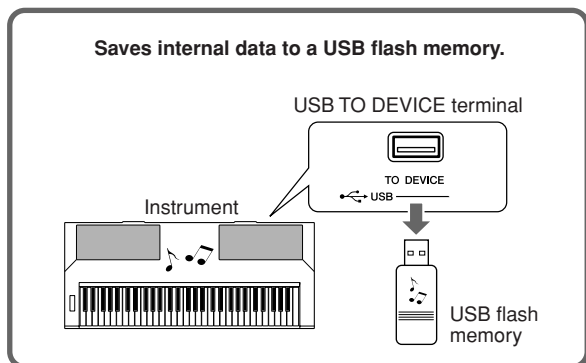

Disconnect the USB flash memory device from the computer and connect it to the instrument.

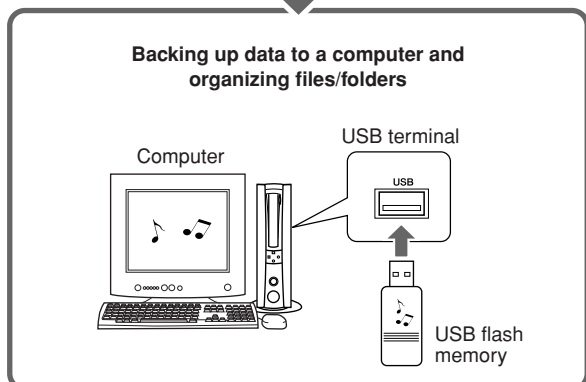

Copying files from a computer hard disk to USB flash memory and then playing back the Songs on the instrument

Files on a computer's hard disk can be transferred to the instrument by first copying them to a USB flash memory device, then connecting/inserting the media to the instrument. User files, Style files and MIDI Songs can be copied to a USB flash memory device from the hard disk of the computer. Once you've copied the data, connect the device to the USB TO DEVICE terminal of the instrument and play back the MIDI Songs, or load the user file or Style file on the instrument.

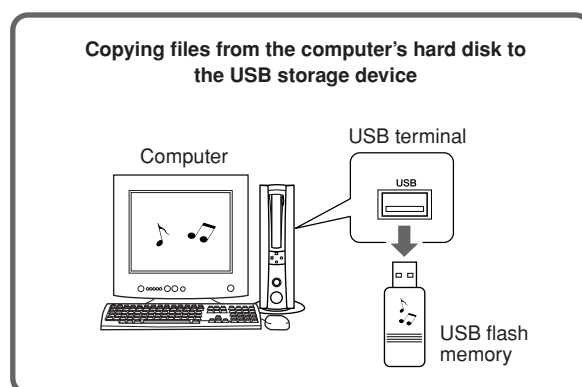

Disconnect the USB storage device from the computer and connect it to the instrument.

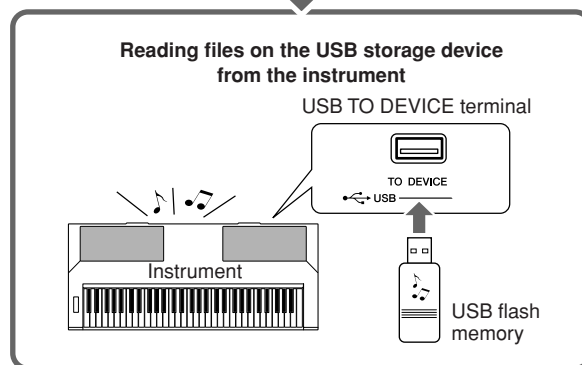

IMPORTANT

- In order to play Songs or Styles copied to a USB flash memory from a computer or other device, the files must be stored either in the USB flash memory's root directory or a first, second, or third level folder. Songs stored here can be selected and played as USB Song (page 28). Songs stored in fourth-level folders created inside a third-level folder cannot be selected and played by this instrument.

The directory can be moved using the CATEGORY [◀]/[▶] buttons.

USB flash memory (Root)

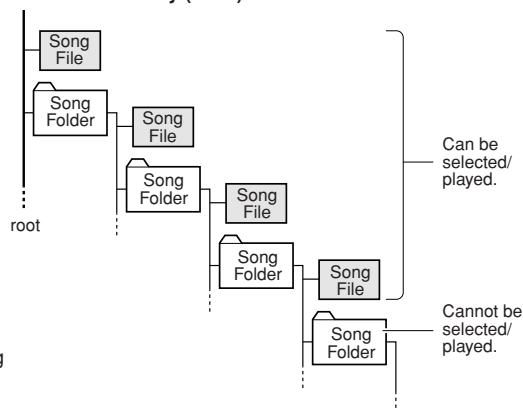

Connecting a Personal Computer

The following functions become available when this instrument is connected to a computer.

- Performance data can be transferred between the instrument and the computer (page 94).
- Files can be transferred between the instrument and the computer (page 96).

The connection procedure is as follows:

1 Install the USB-MIDI driver on your computer.

The USB-MIDI driver is included on the CD-ROM.

Installation of the USB MIDI driver is described on pages 101–102.

2 Connect the USB terminal of the computer to the USB terminal on the instrument using a standard USB cable (USB cable sold separately).

The supplied CD-ROM includes instructions on how to download the Musicsoft Downloader application from the Internet. This application lets you transfer Song files from your computer to the instrument's flash memory. For instructions about how to install Musicsoft Downloader and how to transfer Song files, see pages 103, 96.

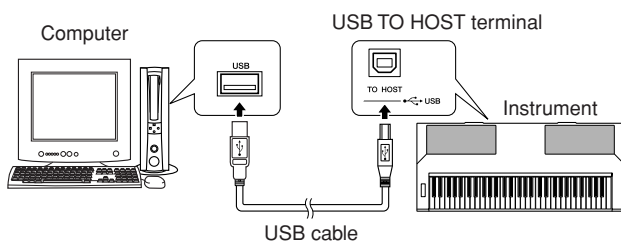

■ Precautions when using the [USB TO HOST] terminal

When connecting the computer to the [USB TO HOST] terminal, make sure to observe the following points. Failing to do so risks freezing the computer and corrupting or losing the data. If the computer or the instrument freezes, restart the application software or the computer OS, or turn the power to the instrument off then on again.

⚠ CAUTION

- Use an AB type USB cable of less than about 3 meters.
- Before connecting the computer to the [USB TO HOST] terminal, exit from any power-saving mode of the computer (such as suspended, sleep, standby).
- Before turning on the power to the instrument, connect the computer to the [USB TO HOST] terminal.
- Execute the following before turning the power to the instrument on/off or plugging/unplugging the USB cable to/from the [USB TO HOST] terminal.
 - Quit any open application software on the computer.
 - Make sure that data is not being transmitted from the instrument. (Data is transmitted only by playing notes on the keyboard or playing back a Song.)
- While the computer is connected to the instrument, you should wait for six seconds or more between these operations: (1) when turning the power of the instrument off then on again, or (2) when alternately connecting/disconnecting the USB cable.

■ Precautions when using the [USB TO DEVICE] terminal

This instrument features a built-in [USB TO DEVICE] terminal. When connecting a USB device to the terminal, be sure to handle the USB device with care. Follow the important precautions below.

NOTE

- For more information about the handling of USB devices, refer to the owner's manual of the USB device.

● Compatible USB devices

- USB storage devices (flash memory, floppy disk drive, hard disk drive, etc.)

The instrument does not necessarily support all commercially available USB devices. Yamaha cannot guarantee operation of USB devices that you purchase. Before purchasing a USB device for use with this instrument, please visit the following web page:

<http://music.yamaha.com/download/>

NOTE

- Other USB devices such as a computer keyboard or mouse cannot be used.

● Connecting USB device

- When connecting a USB device to the [USB TO DEVICE] terminal, make sure that the connector on the device is appropriate and that it is connected in the proper direction.
- Though the instrument supports the USB 1.1 standard, you can connect and use a USB 2.0 storage device with the instrument. However, note that the transfer speed is that of USB 1.1.

● Using USB Storage Devices

By connecting the instrument to a USB storage device, you can save data you've created to the connected device, as well as read data from the connected device.

NOTE

- Although CD-R/RW drives can be used to read data to the instrument, they cannot be used for saving data.

The number of USB storage device to be used

Up to one USB storage device can be connected to the [USB TO DEVICE] terminal.

Formatting USB storage media

When a USB storage device is connected or media is inserted, a message may appear prompting you to format the device/media. If so, execute the Format operation (page 84).

⚠ CAUTION

- The format operation overwrites any previously existing data. Make sure that the media you are formatting does not contain important data.

To protect your data (write-protect)

To prevent important data from being inadvertently erased, apply the write-protect provided with each storage device or media. If you are saving data to the USB storage device, make sure to disable write-protect.

Connecting/removing USB storage device

Before removing the media from the device, make sure that the instrument is not accessing data (such as in the Save, Copy and Delete operations).

⚠ CAUTION

- Avoid frequently turning the power on/off to the USB storage device, or connecting/disconnecting the device too often. Doing so may result in the operation of the instrument "freezing" or hanging up. While the instrument is accessing data (such as during Save, Copy, Delete, Load and Format operations) or is mounting the USB storage device (shortly after the connection), do NOT unplug the USB connector, do NOT remove the media from the device, and do NOT turn the power off to either device. Doing so may corrupt the data on either or both devices.

Transferring Performance Data to and from a Computer

By connecting the instrument to a computer, the instrument's performance data can be used on the computer, and performance data from the computer can be played on the instrument.

- When the instrument is connected with computer, it transmits/receives performance data.

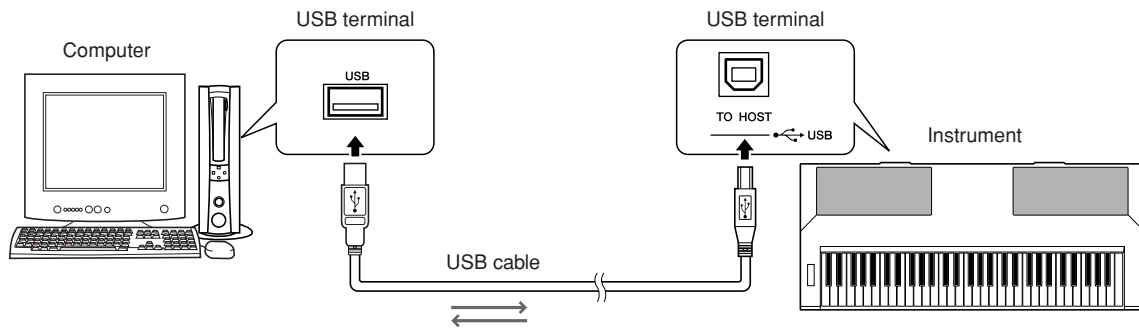

MIDI settings

These settings pertain to performance data transmission and reception.

Item	Range/Settings	Description
Local	ON/OFF	Local control determines whether or not notes played on the instrument are sounded by its internal tone generator system: the internal tone generator is active when local control is on, and inactive when local control is off.
External Clock	ON/OFF	These settings determine whether the instrument is synchronized to its own internal clock (OFF), or to a clock signal from an external device (ON).
Keyboard Out	ON/OFF	These settings determine whether keyboard performance data of the instrument is transmitted (ON) or not (OFF).
Style Out	ON/OFF	These settings determine whether Style data is transmitted (ON) or not (OFF) during Style playback.
Song Out	ON/OFF	These settings determine whether Song data is transmitted (ON) or not (OFF) during Song playback.

CAUTION

- If Local is set to OFF, the instrument will not produce any sound when the keyboard is played.

CAUTION

- If External Clock is ON and no clock signal is being received from an external device, the Song, Style, and Metronome functions will not start.

1 Press the [FUNCTION] button.

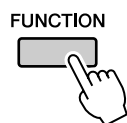

2 Use the CATEGORY [◀] and [▶] buttons to select the item you want to change its value.

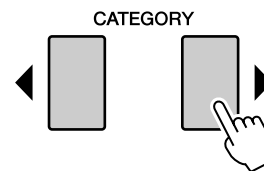

3 Use the dial to select ON or OFF.

■ PC Mode

A number of MIDI settings need to be made when you want to transfer performance data between the computer and the instrument. The PC Mode item can conveniently make multiple settings for you in one operation. Three settings are available: PC1, PC2, and OFF.

This setting is not necessary when transferring Song or backup data between the computer and the instrument.

* Set the PC mode to PC2 when using Digital Music Notebook.

	PC1	PC2*	OFF
Local	OFF	OFF	ON
External Clock	ON	OFF	OFF
Song Out	OFF	OFF	OFF
Style Out	OFF	OFF	OFF
Keyboard Out	OFF	ON	ON

1 Press and hold the [DEMO] button for longer than a second so that the PC Mode item appears.

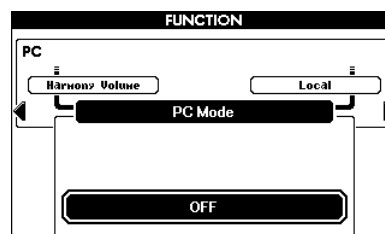
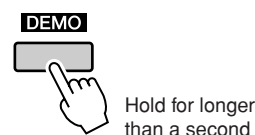

2 Use the dial to select PC1, PC2, or OFF.

NOTE

- When the PC2 setting is selected the instrument's Style, song, demo, song recording, and lesson features cannot be used.

NOTE

- You can also access the PC Mode item by first pressing the [FUNCTION] button and then using the CATEGORY [◀] and [▶] buttons to locate it (page 80).

Initial Send

This function lets you send the panel setup data to a computer. Before you record performance data to a sequencer application running on your computer, it is a good idea to first send and record the panel setup data before the actual performance data.

1 Press the [FUNCTION] button.

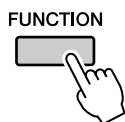

2 Use the CATEGORY [◀] and [▶] buttons to select the Initial Setup item.

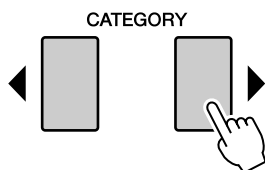

3 Press [+ / YES] to send, or press [- / NO] to cancel.

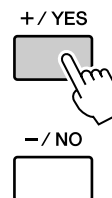

Transferring Data Between the Computer and Instrument

MIDI Songs and Style files stored to a computer can be transferred to the instrument. Backup data can also be transferred from the instrument to the computer and back. In order to transfer Songs between your computer and the instrument you will need to install the USB MIDI Driver included on the Accessory CD-ROM on your computer, and then install the Musicsoft Downloader from the Internet. Refer to Installation Guide on page 99 for details.

- **Data that can be transferred from a computer**
 - Data capacity (max): 1,895 KB
 - The number of files that can be shown on the display is as follows:
 - 100 Songs
 - 50 Styles
 - 50 MDBs
 - Data Format: SMF format 0, SMF format 1, Style file (extension: .sty), Backup data

NOTE

- Even if the number of Songs transferred is less than 100, if the amount of data exceeds 1,895 KB, the Song data cannot be transferred to the instrument.

With the Musicsoft Downloader You Can

- Transfer MIDI Songs and Style files you have downloaded from the Internet or created on your computer from the computer to the instrument's flash memory.
 - ⇒ Refer to the procedure described below.
- Backup data can be transferred from the instrument to a computer and back.
 - ⇒ Refer to the procedure described on page 98.

Use the Musicsoft Downloader application with Internet Explorer 5.5 or higher.

Use Musicsoft Downloader to Transfer Songs from the Computer to the Instrument's Flash Memory

NOTE

- If a Song or Style is being played, stop playback before proceeding.

- 1** Install the Musicsoft Downloader and USB MIDI driver to your computer, then connect the computer and the instrument (pages 103, 101).
- 2** After selecting the language, double-click the Musicsoft Downloader shortcut icon that is created on the desktop. This will launch the Musicsoft Downloader application and the main window will appear.

NOTE

- The instrument cannot be operated while the Musicsoft Downloader is running.

- 3** Click the "Add File" button and the Add File window will appear.
- 4** Click the button to the right of "Look in" and select the folder from the drop-down menu that appears. Double-click the "SongData" Folder on the window. Select the file you want to transfer to the instrument, and click "Open".

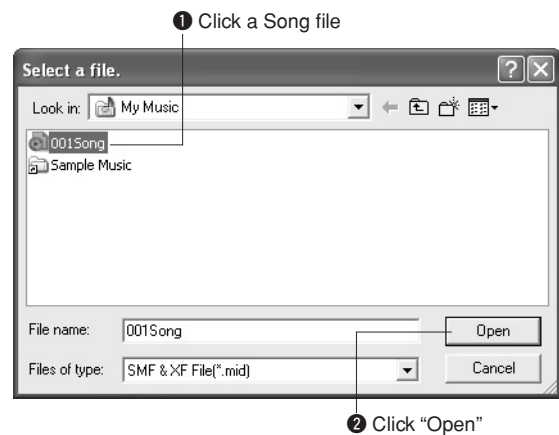

- 5** A copy of the selected MIDI Song file will appear in the “List of files stored temporarily” at the top of the window. The memory medium will also be displayed at the bottom of the window to specify the destination for the transfer. Click “Instrument,” and then “Flash memory.”

“Flash memory” here refers to the internal memory of the instrument.

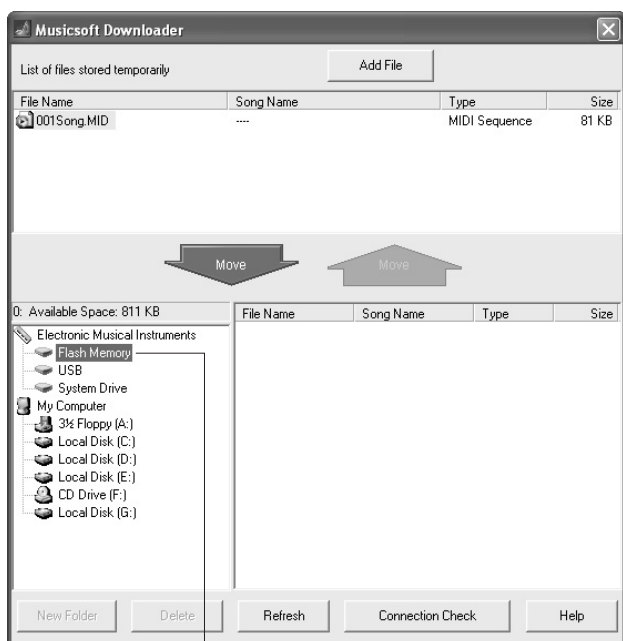

① Click “Electronic Musical Instruments”, and then “Flash Memory”

- 6** After selecting the file in the “List of files stored temporarily,” click the downward [Move] button and a confirmation message will appear. Click [OK] and the Song will be transferred from the “List of files stored temporarily” to the instrument’s memory.

- 7** Close the window to close the Musicsoft Downloader.

NOTE

- Before playing back the Song transferred from your computer, make sure to close the Musicsoft Downloader program.

- 8** To playback a Song stored in the memory of the instrument, press the [USER] button. Use the dial to select the Song you want to play, then press the [▶/■] button to start playback.

CAUTION

- Do not unplug the USB cable during a data transfer. Not only will the data not be transferred and saved, but operation of the memory media may become unstable and its contents may disappear.

CAUTION

- Stored data can be lost due to equipment malfunction or improper operation. For safety we recommend that you keep a copy of all important data stored on your computer.

■ Transferring Backup data from the Instrument to a Computer ●●

You can use the Musicsoft Downloader to transfer Backup data (page 39) to a computer. If you click “Electronic Musical Instruments” in the Musicsoft Downloader display, and then “System Drive,” a file named “PSR-S550.BUP” will appear in the lower right corner of the Musicsoft Downloader display. This is the backup data. For details about how to transfer backup data using the Musicsoft Downloader application, refer to the Online help in the application.

NOTE

- Preset Song data cannot be transmitted from the instrument.

CAUTION

- The backup data, including the five User Songs' is transmitted/received as a single file. As a result, all backup data will be overwritten every time you transmit or receive. Keep this in mind when transferring data.

CAUTION

- Do not rename the backup data on the computer. If you do so it will not be recognized when transferred to the instrument.

● Using Songs with Notation

In order to use Songs with notation (SMF format 0 only) transferred from a computer for lessons and practice, you'll need to specify which channels are to be played back as the right-hand and left-hand parts.

- 1 Press the [USER] button and select the Song residing in internal memory for which you want to set the guide track.
- 2 Press the [FUNCTION] button.
- 3 Use the CATEGORY [◀] and [▶] buttons to select the R-Part or L-Part item.
- 4 Use the dial to select the channel you want to play back as the specified right- or left-hand part.

We recommend that you select channel 1 for the right-hand part and channel 2 for the left-hand part.



Accessory CD-ROM Installation Guide

SPECIAL NOTICES

- The software and this Installation Guide are exclusive copyrights of Yamaha Corporation.
- Use of the software and this guide is governed by the SOFTWARE LICENSE AGREEMENT which the purchaser fully agrees to upon breaking the seal of the software packaging. (Please read carefully the AGREEMENT at the end of this guide before installing the application.)
- Copying of the software or reproduction of this guide in whole or in part by any means is expressly forbidden without the written consent of the manufacturer.
- Yamaha makes no representations or warranties with regard to the use of the software and documentation and cannot be held responsible for the results of the use of this guide and the software.
- Copying of the commercially available music data is strictly prohibited except for your personal use.
- Software such as the USB-MIDI driver may be revised and updated without prior notice. Make sure to check and download the latest version of the software from the following site.
<http://music.yamaha.com/download>
- Future upgrades of application and system software and any changes in specifications and functions will be announced separately.

Important Notices about the CD-ROM

● Data Types

This CD-ROM includes application software. Please refer to page 101 for software installation instructions.

CAUTION

- *This CD-ROM is not meant for use with an audio/visual system (CD player, DVD player, etc.). Never attempt to use the disk on equipment other than a computer.*

● Operating System (OS)

The applications in this CD-ROM are provided in versions for Windows operating systems.

■ CD-ROM Installation Procedure ●●

Before breaking the seal of the software packaging, please read carefully the Software License Agreement at the end of this guide.

- 1 Check the system requirements to make sure that the software will run on your computer (page 100).**
- 2 Insert the included CD-ROM into the CD-ROM drive.**

The Start window should appear automatically. (Users of Windows Vista will need to click [Start.exe] to open the Start window after inserting the CD-ROM.)
- 3 Connect the instrument to the computer (page 92).**
- 4 Install the USB-MIDI driver to the computer (pages 101–102).**
- 5 Install the software (page 103).**

6 Start up the software.

For subsequent operations, refer to the owner's manual for each software program (online help/PDF manual). If you have any problems in driver installation, refer to the "Troubleshooting" on page 104.

NOTE

- *To view PDF files, you must install Adobe Reader on your computer. If you do not have Adobe Reader, you can download the application from the Adobe website at the following URL:
<http://www.adobe.com>*

Contents of the CD-ROM

The start window as shown below will appear automatically when you insert the included CD-ROM. (Users of Windows Vista will need to click [Start.exe] to open the Start window after inserting the CD-ROM.) By clicking each menu on the Start window, you can access the User Registration page on the Internet and download some of the wide variety of application software available.



	Application / Data Name	Folder Name	Contents
①	USB-MIDI Driver (Windows 2000/XP)	USBdrv2k_	This software is necessary when using your instrument with a computer via a USB connection. It enables MIDI communication and control between the instrument and the computer.
	USB-MIDI Driver (Windows Vista/XP x64)	USBdrvVista_	
②	Digital Music Notebook	DMN_	Digital Music Notebook is a combination music learning program and online service that makes it easy and fun to practice and master your favorite Songs. You can use the convenient and powerful Digital Music Notebook functions with the demo song after installing Digital Music Notebook.
	Digital Music Notebook Flash Demo	DMN_FlashDemo	Full-motion demo software which introduces all features of the Digital Music Notebook, from within the program.
③	Microsoft Downloader	(Available at Yamaha website.)	Utilizing a connection between the instrument and a computer, this application allows you to directly download Song data to the instrument. Microsoft Downloader can be downloaded from the Internet.

* All the applications listed above are supplied with online/PDF manuals.

■ Minimum System Requirements.....

Application/Data	OS	CPU	Memory	Hard Disk	Display
USB Driver for Windows 2000/XP	Windows 2000/XP Home Edition/XP Professional	166 MHz or higher; Intel® Pentium®/Celeron® Processor family	32 MB or more (64 MB or more is recommended)	at least 3 MB of free space	-
USB Driver for Windows Vista/XP x64	Windows Vista/XP Professional x64 Edition	800 MHz or higher; Intel® Pentium®/Celeron® Processor family or Intel® 64 compatible processor	512 MB or more	at least 3 MB of free space	-
Digital Music Notebook	Windows XP Home/ Professional Edition, Service Pack 1a (SP1a) more/ Windows Vista * Only 32-bit is supported.	400 MHz or higher processor clock speed (Intel® Pentium®/Celeron® Processor family, or compatible processor recommended)	128 MB or more (256 MB or more is recommended)	at least 150 MB of free space	1024 x 768 HighColor (16-bit)
Digital Music Notebook (Requirements for playing content with video included.)	Windows 2000/XP Home Edition/XP Professional/ Vista * Only 32-bit is supported.	1 GHz or higher; Intel® Pentium®/Celeron® Processor family (1.4 GHz or more is recommended)	256 MB or more		

NOTE

• For the System Requirements of the other software available in the CD-ROM, see the respective download page on the web. The download page can be displayed by clicking the software menu on the Start window and the "download" button in the next page.

Software Installation

■ USB-MIDI Driver

To operate the instrument from your computer via USB, you'll need to install the appropriate driver software. The USB-MIDI driver is software that transfers MIDI data back and forth between sequence software and the instrument via a USB cable.

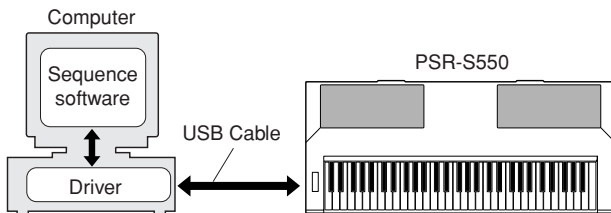

- For Windows XP: See below.
- For Windows 2000: See page 102.
- For Windows Vista: See page 102.

NOTE

- See the Yamaha Download page at the following URL for up-to-date news on USB-MIDI driver:
<http://music.yamaha.com/download/>

Check the drive name of the CD-ROM drive you will be using (D:, E:, Q:, etc.) The drive name is displayed beside the CD-ROM icon in your "My Computer" folder. The root directory of the CD-ROM drive will be D:\, E:\, or Q:\, respectively.

Installing the driver on Windows XP

- 1 Start the computer and use the "Administrator" account to log on to Windows XP.
- 2 Select [Start] → [Control Panel].
If the control panel appears as "Pick a category", click "Switch to Classic View" in the upper left of the window. All control panels and icons will be displayed.
- 3 Go to [System] → [Hardware] → [Driver Signing Options] and check the radio button to the left of "Ignore" and click [OK].
- 4 Click the [OK] button to close System Properties, and then click "X" in the upper right of the window to close the Control Panel.
- 5 Insert the included CD-ROM into the CD-ROM drive.

The Start window will appear automatically.

- 6 First, make sure the POWER switch on the instrument is set to OFF, then use a USB cable to connect the USB connector of the computer to the USB TO HOST connector of the instrument. When the instrument is turned on, the computer automatically displays the "Found New Hardware Wizard."

If the Wizard window is not displayed automatically, refer to "Troubleshooting."

If the system displays "Found New Hardware" in the lower right corner, wait until "Found New Hardware Wizard" is displayed. (The Wizard window may take a while to display on some computers.)

If the Wizard window prompts you to specify whether or not to connect to Windows Update, select the radio button for "No, not this time," then click [Next].

- 7 Check the radio button to the left of "Install the software automatically (Recommended)." Click [Next]. The system starts the installation.

NOTE

- If during the installation the system displays "...has not passed Windows Logo testing to verify its compatibility with Windows XP," click [Continue Anyway].

- 8 When the installation is complete, the system displays "Completing the Found New Hardware Wizard." Click [Finish].

(The Wizard window may take a while to display on some computers.)

- 9 Restart the computer.

If the system displays "Found New Hardware" in the lower right corner, wait until "System Settings Change" is displayed. (The Wizard window may take a while to display on some computers.)

NOTE

- This Wizard window will not appear when using Windows XP Professional x64 Edition. There is no need to restart the computer.

- 10 When using Windows XP Professional x64 Edition, the Support Module must be installed.

After installing the USB-MIDI drivers for all the connected USB devices, select "My Computer" from the Start menu. Right-click the CD-ROM icon and select "Open" from the pop-up menu. Select "USBdrvVista_" → "XPx64SupportModule" → "Setup.exe" and launch "Setup.exe." Follow the on-screen directions.

NOTE

- Once the Support Module is installed, this step is not necessary, even if you've connected a new USB device or updated the USB-MIDI driver.

The USB-MIDI driver installation is complete.

Installing the driver on Windows 2000

- 1** Start the computer and use the “Administrator” account to log on to Windows 2000.
- 2** Select [My Computer] → [Control Panel] → [System] → [Hardware] → [Driver Signing] → [File Signature Verification], and check the radio button to the left of “Ignore-Install all files, regardless of file signature” and click [OK].
- 3** Insert the included CD-ROM into the CD-ROM drive.
The Start window will appear automatically.
- 4** First, make sure the POWER switch on the instrument is set to OFF, then use a USB cable to connect the USB connector of the computer to the USB TO HOST connector of the instrument. When the instrument is turned on, the computer automatically displays the “Found New Hardware Wizard.” Click [Next].
(The Wizard window may take a while to display on some computers.)
If the Wizard window is not displayed automatically, refer to “Troubleshooting” (page 104).
- 5** Check the radio button to the left of “Search for a suitable driver for my device (Recommended).” Click [Next].
- 6** Check the “CD-ROM drives” box and uncheck all other items. Click [Next].

NOTE

• The system may ask you to insert a Windows CD-ROM while it checks for the driver. Specify the “USBdrv2k_” folder of the CD-ROM drive (such as D:\USBdrv2k_) and continue the installation.

- 7** Click [Next].

NOTE

• If the Wizard panel informs you that “The software you are about to install does not contain a Microsoft digital signature,” click [Yes].

- 8** When the installation is complete, the system displays “Completing the Found New Hardware Wizard.” Click [Finish].
(The Wizard window may take a while to display on some computers.)
- 9** Restart the computer.
The USB-MIDI driver installation is complete.

Installing the driver on Windows Vista

- 1** Start the computer and use the “Administrator” account to log on to Windows Vista.
- 2** Insert the included CD-ROM into the CD-ROM drive.
The AutoPlay window will appear.
- 3** Click [Run Start.exe].
The Start window will appear automatically.
- 4** First, make sure the POWER switch on the instrument is set to OFF, then use a USB cable to connect the USB connector of the computer to the USB TO HOST connector of the instrument. When the instrument is turned on, the computer automatically displays the “Found New Hardware” window. Click “Locate and install driver software (recommended).”
If the window is not displayed automatically, refer page 104 for “Troubleshooting.” (Some computers may take a while to display the window.)

NOTE

• If the “User Account Control” window appears, click [Continue].

- 5** If a message allowing Windows to search online for driver software appears, click “Don’t search online.”
- 6** If a message prompting you to insert the disk that came with your device appears, click [Next].
The system starts the installation.

NOTE

• If the “Windows Security” window appears, confirm this software is authored by Yamaha Corporation then click [Install].

- 7** When the installation is complete, the system displays the message “The software for this device has been successfully installed.” Click [Close].
(Some computers may take a while to display the window.)
The USB-MIDI driver installation is complete.

■ Digital Music Notebook.....

IMPORTANT

- When installing Digital Music Notebook to Windows XP, or Vista, make sure to log on to the Administrator account.
- When installing the Digital Music Notebook, make sure that Internet Explorer 6.0 (with SP1) or higher is installed to your computer.
- Credit card settlement is required to purchase Digital Music Notebook content. Credit card processing may not be possible for some areas, so please check with your local authorities to make sure that your credit card can be used.

NOTE

- Use of the DMN (Digital Music Notebook) is governed by the SIBEL-IUS SCORCH LICENSE AGREEMENT, which the purchaser fully agrees to when using the application. Please read carefully the AGREEMENT on page 106 in English, before using the application.

1 Insert the included CD-ROM into the CD-ROM drive of the computer.

The Start window appears on the screen. Each menu on the window indicates the application or data contained in the Accessory CD-ROM.

2 Click "DIGITAL MUSIC NOTEBOOK" on the Start window.

3 Click the "Install" button, and follow the on-screen instructions to install the software.

For Digital Music Notebook operating instructions see the help menu: launch the Digital Music Notebook application and click "Help".

■ Musicsoft Downloader.....

IMPORTANT

- When installing Musicsoft Downloader to Windows XP, 2000 or Vista, make sure to log on to the Administrator account.
- To install Musicsoft Downloader, your computer must be connected to the Internet and be online.
- For the instrument including this Accessory CD-ROM, you can use only the Musicsoft Downloader as a file transfer application software. Other applications such as File Utility and Song Filer cannot be used.

1 Insert the included CD-ROM into the CD-ROM drive of the computer.

The Start window appears on the screen. Each menu on the window indicates the application or data contained in the Accessory CD-ROM.

2 Click "Musicsoft Downloader" on the Start window.

The page which explains the details about Musicsoft Downloader is displayed on the window.

3 Click "Musicsoft Downloader Download" button at the bottom of the window.

The Download page on the web is displayed. Verify that your system meets the requirements before installing the software.

● Uninstall (Removing the installed application)

To remove any installed application software:
Select [START] → [Settings] → [Control Panel] → [Add/Remove Programs] → [Install/Uninstall], then select the application to be removed and click [Add/Remove...].

Follow the on-screen instructions to uninstall the application.

NOTE

- The button names or menus may differ depending on the computer OS.
- For instructions on uninstalling the USB-MIDI driver, refer to "How can I remove the driver?" in the "Troubleshooting" section (page 104).

■ Troubleshooting

● The driver cannot be installed.

- **Is the USB cable connected correctly?**
Check the USB cable connection.
Disconnect the USB cable, then connect it again.
- **Is the USB function enabled on your computer?**
When you connect the instrument to the computer for the first time, if the “Add New Hardware Wizard” does not appear, the USB function on the computer may be disabled. Perform the following steps.

1 Select [Control Panel]* → [System] → [Hardware] → [Device Manager] (for Windows XP/2000), or select [Control Panel] → [Device Manager] (for Windows Vista).

* Classic View only in Windows XP.

2 Make sure that no “!” or “x” marks appear at “Universal serial bus controller” or “USB Root Hub.” If you see an “!” or “x” mark, the USB controller is disabled.

- **Is any unknown device registered?**
If driver installation fails, the instrument will be marked as an “Unknown device,” and you will not be able to install the driver. Delete the “Unknown device” by following the steps below.

1 Select [Control Panel]* → [System] → [Hardware] → [Device Manager] (for Windows XP/2000), or select [Control Panel] → [Device Manager] (for Windows Vista).

* Classic View only in Windows XP.

2 Look for “Other devices” in the menu “View devices by type.”

3 If you find “Other devices,” double-click it to extend the tree to look for “Unknown device.” If one appears, select it and click the [Remove] button.

4 Remove the USB cable from the instrument, and make the connection again.

5 Install the driver again. (See pages 101–102.)

● When controlling the instrument from your computer via USB, the instrument does not operate correctly or no sound is heard.

- Did you install the driver (pages 101–102)?
- Is the USB cable connected correctly?
- Are the volume settings of the instrument, playback device, and application program set to the appropriate levels?
- Have you selected an appropriate port in the sequence software?
- Are you using the latest USB-MIDI driver?
The latest driver can be downloaded from the web site (page 101).

● Playback response is delayed.

- Does your computer satisfy the system requirements?
- Is any other application or device driver running?

● Cannot suspend or resume the computer correctly.

- Do not suspend the computer while the MIDI application is running.
- You may not be able to suspend/resume normally, depending on the particular environment (USB Host Controller, etc.). Even so, simply disconnecting and connecting the USB cable will allow you to use the instrument functions again.

● How can I remove the driver?

1 Start the computer and use the “Administrator” account to log on to Windows.
Close all applications and windows that are open.

2 Insert the included CD-ROM into the CD-ROM drive.

3 Select [Start] → [My Computer] (for Windows XP), or select [My Computer] (for Windows 2000), or select [Start] → [Computer] (for Windows Vista).

4 Right-click the CD-ROM icon and select “Open” from the pop-up menu.

5 Select “USBdrvVista_” or “USBdrv2k_” folder → “uninstall” folder → “uninstall.exe” file and launch the “uninstall.exe.” file.
Follow the on-screen instructions to uninstall the driver.

NOTE

- When using a 64-bit OS, click “uninstall_x64.exe.” from the “USBdrvVista_” folder.
- If the “User Account Control” window appears, click [Continue].

ATTENTION

SOFTWARE LICENSE AGREEMENT

PLEASE READ THIS SOFTWARE LICENSE AGREEMENT (“AGREEMENT”) CAREFULLY BEFORE USING THIS SOFTWARE. YOU ARE ONLY PERMITTED TO USE THIS SOFTWARE PURSUANT TO THE TERMS AND CONDITIONS OF THIS AGREEMENT. THIS AGREEMENT IS BETWEEN YOU (AS AN INDIVIDUAL OR LEGAL ENTITY) AND YAMAHA CORPORATION (“YAMAHA”). BY BREAKING THE SEAL OF THIS PACKAGE YOU ARE AGREEING TO BE BOUND BY THE TERMS OF THIS LICENSE. IF YOU DO NOT AGREE WITH THE TERMS, DO NOT INSTALL, COPY, OR OTHERWISE USE THIS SOFTWARE.

1. GRANT OF LICENSE AND COPYRIGHT

Yamaha hereby grants you the right to use one copy of the software program(s) and data (“SOFTWARE”) accompanying this Agreement. The term SOFTWARE shall encompass any updates to the accompanying software and data. The SOFTWARE is owned by Yamaha and/or Yamaha’s licensor(s), and is protected by relevant copyright laws and all applicable treaty provisions. While you are entitled to claim ownership of the data created with the use of SOFTWARE, the SOFTWARE will continue to be protected under relevant copyrights.

- You may use the SOFTWARE on a single computer.
- You may make one copy of the SOFTWARE in machine-readable form for backup purposes only, if the SOFTWARE is on media where such backup copy is permitted. On the backup copy, you must reproduce Yamaha’s copyright notice and any other proprietary legends that were on the original copy of the SOFTWARE.
- You may permanently transfer to a third party all your rights in the SOFTWARE, provided that you do not retain any copies and the recipient reads and agrees to the terms of this Agreement.

2. RESTRICTIONS

- You may not engage in reverse engineering, disassembly, decompilation or otherwise deriving a source code form of the SOFTWARE by any method whatsoever.
- You may not reproduce, modify, change, rent, lease, or distribute the SOFTWARE in whole or in part, or create derivative works of the SOFTWARE.
- You may not electronically transmit the SOFTWARE from one computer to another or share the SOFTWARE in a network with other computers.
- You may not use the SOFTWARE to distribute illegal data or data that violates public policy.
- You may not initiate services based on the use of the SOFTWARE without permission by Yamaha Corporation.

Copyrighted data, including but not limited to MIDI data for songs, obtained by means of the SOFTWARE, are subject to the following restrictions which you must observe.

- Data received by means of the SOFTWARE may not be used for any commercial purposes without permission of the copyright owner.
- Data received by means of the SOFTWARE may not be duplicated, transferred, or distributed, or played back or performed for listeners in public without permission of the copyright owner.
- The encryption of data received by means of the SOFTWARE may not be removed nor may the electronic watermark be modified without permission of the copyright owner.

3. TERMINATION

This Agreement becomes effective on the day that you receive the SOFTWARE and remains effective until terminated. If any copyright law or provisions of this Agreement is violated, the Agreement shall terminate automatically and immediately without notice from Yamaha. Upon such termination, you must immediately destroy the licensed SOFTWARE, any accompanying written documents and all copies thereof.

4. LIMITED WARRANTY ON MEDIA

As to SOFTWARE sold on tangible media, Yamaha warrants that the tangible media on which the SOFTWARE is recorded will be free from defects in materials and workmanship under normal use for a period of fourteen (14) days from the date of receipt, as evidenced by a copy of the receipt. Yamaha’s entire liability and your exclusive remedy will be replacement of the defective media if it is returned to Yamaha or an authorized Yamaha dealer within fourteen days with a copy of the receipt. Yamaha is not responsible for replacing media damaged by accident, abuse or misapplication. TO THE FULLEST EXTENT PERMITTED BY LAW, YAMAHA EXPRESSLY DISCLAIMS ANY IMPLIED WARRANTIES ON THE TANGIBLE MEDIA, INCLUDING THE IMPLIED WARRANTIES OF MERCHANTABILITY AND FITNESS FOR A PARTICULAR PURPOSE.

5. DISCLAIMER OF WARRANTY ON SOFTWARE

You expressly acknowledge and agree that use of the SOFTWARE is at your sole risk. The SOFTWARE and related documentation are provided “AS IS” and without warranty of any kind. NOTWITHSTANDING ANY OTHER PROVISION OF THIS AGREEMENT, YAMAHA EXPRESSLY DISCLAIMS ALL WARRANTIES AS TO THE SOFTWARE, EXPRESS, AND IMPLIED, INCLUDING BUT NOT LIMITED TO THE IMPLIED WARRANTIES OF MERCHANTABILITY, FITNESS FOR A PARTICULAR PURPOSE AND NON-INFRINGEMENT OF THIRD PARTY RIGHTS. SPECIFICALLY, BUT WITHOUT LIMITING THE FOREGOING, YAMAHA DOES NOT WARRANT THAT THE SOFTWARE WILL MEET YOUR REQUIREMENTS, THAT THE OPERATION OF THE SOFTWARE WILL BE UNINTERRUPTED OR ERROR-FREE, OR THAT DEFECTS IN THE SOFTWARE WILL BE CORRECTED.

6. LIMITATION OF LIABILITY

YAMAHA’S ENTIRE OBLIGATION HEREUNDER SHALL BE TO PERMIT USE OF THE SOFTWARE UNDER THE TERMS HEREOF. IN NO EVENT SHALL YAMAHA BE LIABLE TO YOU OR ANY OTHER PERSON FOR ANY DAMAGES, INCLUDING, WITHOUT LIMITATION, ANY DIRECT, INDIRECT, INCIDENTAL OR CONSEQUENTIAL DAMAGES, EXPENSES, LOST PROFITS, LOST DATA OR OTHER DAMAGES ARISING OUT OF THE USE, MISUSE OR INABILITY TO USE THE SOFTWARE, EVEN IF YAMAHA OR AN AUTHORIZED DEALER HAS BEEN ADVISED OF THE POSSIBILITY OF SUCH DAMAGES. In no event shall Yamaha’s total liability to you for all damages, losses and causes of action (whether in contract, tort or otherwise) exceed the amount paid for the SOFTWARE.

7. THIRD PARTY SOFTWARE

Third party software and data (“THIRD PARTY SOFTWARE”) may be attached to the SOFTWARE. If, in the written materials or the electronic data accompanying the Software, Yamaha identifies any software and data as THIRD PARTY SOFTWARE, you acknowledge and agree that you must abide by the provisions of any Agreement provided with the THIRD PARTY SOFTWARE and that the party providing the THIRD PARTY SOFTWARE is responsible for any warranty or liability related to or arising from the THIRD PARTY SOFTWARE. Yamaha is not responsible in any way for the THIRD PARTY SOFTWARE or your use thereof.

- Yamaha provides no express warranties as to the THIRD PARTY SOFTWARE. IN ADDITION, YAMAHA EXPRESSLY DISCLAIMS ALL IMPLIED WARRANTIES, INCLUDING BUT NOT LIMITED TO THE IMPLIED WARRANTIES OF MERCHANTABILITY AND FITNESS FOR A PARTICULAR PURPOSE, as to the THIRD PARTY SOFTWARE.
- Yamaha shall not provide you with any service or maintenance as to the THIRD PARTY SOFTWARE.
- Yamaha is not liable to you or any other person for any damages, including, without limitation, any direct, indirect, incidental or consequential damages, expenses, lost profits, lost data or other damages arising out of the use, misuse or inability to use the THIRD PARTY SOFTWARE.

8. GENERAL

This Agreement shall be interpreted according to and governed by Japanese law without reference to principles of conflict of laws. Any dispute or procedure shall be heard before the Tokyo District Court in Japan. If for any reason a court of competent jurisdiction finds any portion of this Agreement to be unenforceable, the remainder of this Agreement shall continue in full force and effect.

9. COMPLETE AGREEMENT

This Agreement constitutes the entire agreement between the parties with respect to use of the SOFTWARE and any accompanying written materials and supersedes all prior or contemporaneous understandings or agreements, written or oral, regarding the subject matter of this Agreement. No amendment or revision of this Agreement will be binding unless in writing and signed by a fully authorized representative of Yamaha.

SIBELIUS SCORCH LICENSE AGREEMENT

By installing and/or using this Product you (an individual or legal entity) agree with the Licensor to be bound by the terms of this License which will govern your use of the Product. If you do not accept these terms, do not install or use this Product. The Product is copyright © 1987-2007 Sibelius Software, a division of Avid Technology, Inc, and its licensors.

1. Definitions

In this License the following words and expressions have the following meanings:

“License”: this agreement between you and the Licensor and, if permitted by the context, the conditional license granted to you in this agreement.

“Licensor”: Avid Technology, Inc., of Avid Technology Park, One Park West, Tewksbury, MA 01876 USA, through its division Sibelius Software, of 20-23 City North, Fonthill Road, London N4 3HF, UK “Product”: the Software and the Documentation.

“Software”: the Sibelius Scorch web browser plug-in, Opus, Helsinki, Inkpen2 and Reprise font families, any other programs or files supplied by the Licensor which are included in or with the Sibelius Scorch installer, and the Sibelius Scorch installer.

“Documentation”: any documentation in any form relating to the Software supplied to you with the Software or by the Licensor.

2. License

- 2.1 The Licensor grants to you a non-exclusive non-transferable license to use this Software in accordance with the Documentation on any number of computers. Title to the Product is not transferred to you. Ownership of the Product remains vested in the Licensor and its licensors, subject to the rights granted to you under this License. All other rights are reserved.
- 2.2 You may make one printout for your own use of any part of the Documentation provided in electronic form. You shall not make or permit any third party to make any further copies of any part of the Product whether in eye or machine-readable form.
- 2.3 You shall not, and shall not cause or permit any third party to,
 - (1) translate, enhance, modify, alter or adapt the Product or any part of it for any purpose (including without limitation for the purpose of error correction);
 - (2) create derivative works based on the Product, or cause the whole or any part of the Product to be combined with or incorporated into any other program, file or product, for any purpose; or
 - (3) use the Software to create files in any format (other than temporary files created and required by your computer's operating system or web browser), including without limitation screen capture files, files generated from the Software's playback, graphics files and print files, for any purpose, except for creating MIDI files (if permitted by the Software) for private non-commercial use.
- 2.4 You shall not, and shall not cause or permit any third party to, decompile, decode, disassemble or reverse engineer the Software in whole or in part for any purpose.
- 2.5 You shall not, and shall not cause any third party to, translate, convert, decode or reverse engineer any file capable of being read by any copy or version of the Software or any data transmitted to or from any copy or version of the Software, in whole or in part for any purpose.
- 2.6 The Product or any part of it must not be used to infringe any right of copyright or right of privacy, publicity or personality or any other right whatsoever of any other person or entity.

3. Copyright

- 3.1 You acknowledge that copyright in the Product as a whole and in the components of the Product as between you and the Licensor belongs to the Licensor or its licensors and is protected by copyright laws, national and international, and all other applicable laws.

4. Disclaimer of Liability

- 4.1 In consideration of the fact that the Product is licensed hereunder free of charge, (a) the Licensor disclaims any and all warranties with respect to the Product, whether expressed or implied, including without limitation any warranties that the Product is free from defects, will perform in accordance with the Documentation, is merchantable, or is fit for any particular purpose, and (b) the Licensor shall not have or incur any liability to you for any loss, cost, expense or claim (including without limitation any liability for loss or corruption of data and loss of profits, revenue or goodwill and any type of special, indirect or consequential loss) that may arise out of or in connection with your installation and use of the Product.

5. Termination

- 5.1 This License shall terminate automatically upon your destruction of the Product. In addition, the Licensor may elect to terminate this License in the event of a material breach by you of any condition of this License or of any of your representations, warranties, covenants or obligations hereunder. Upon notification of such termination by the Licensor, you will immediately delete the Software from your computer and destroy the Documentation.

6. Miscellaneous

- 6.1 No failure to exercise and no delay in exercising on the part of the Licensor of any right, power or privilege arising hereunder shall operate as a waiver thereof, nor shall any single or partial exercise of any right, power or privilege preclude any other or further exercise thereof or the exercise of any other right, power or privilege. The rights and remedies of the Licensor in connection herewith are not exclusive of any rights or remedies provided by law.
- 6.2 You may not distribute, loan, lease, sub-license, rent or otherwise transfer the Product to any third party.
- 6.3 You agree to the use of your personal data in accordance with the Licensor's privacy policy (available from the Licensor or on www.sibelius.com), which may change from time to time.
- 6.4 This License is intended by the parties hereto to be a final expression of their agreement with respect to the subject matter hereof and a complete and exclusive statement of the terms of such agreement. This License supercedes any and all prior understandings, whether written or oral, between you and the Licensor relating to the subject matter hereof.
- 6.5 (This section only applies if you are resident in the European Union:) This License shall be construed and governed by the laws of England, and both parties agree to submit to the exclusive jurisdiction of the English courts.
- 6.6 (This section only applies if you are not resident in the European Union:) This License shall be construed and enforced in accordance with and governed by the laws of the State of California. Any suit, action or proceeding arising out of or in any way related or connected to this License shall be brought and maintained only in the United States District Court for the Northern District of California, sitting in the City of San Francisco. Each party irrevocably submits to the jurisdiction of such federal court over any such suit, action or proceeding. Each party knowingly, voluntarily and irrevocably waives trial by jury in any suit, action or proceeding (including any counterclaim), whether at law or in equity, arising out of or in any way related or connected to this License or the subject matter hereof.

(License v5.0 (DMN), 30 July 2007)



Troubleshooting

Problem	Possible Cause and Solution
When the instrument is turned on or off, a popping sound is temporarily produced.	This is normal and indicates that the instrument is receiving electrical power.
When using a mobile phone, noise is produced.	Using a mobile phone in close proximity to the instrument may produce interference. To prevent this, turn off the mobile phone or use it further away from the instrument.
There is no sound even when the keyboard is played or when a song or style is being played back.	Check that nothing is connected to the PHONES/OUTPUT jack on the rear panel. When a set of headphones is plugged into this jack, no sound is output.
	Check the Local Control on/off. (See page 94.)
	Is the FILE CONTROL display showing? The instrument's keyboard, etc., will not produce any sound while the FILE CONTROL display is showing. Press the [EXIT] button to return to the MAIN display.
The style or song does not play back when the [START/STOP] button is pressed.	Is External Clock set to ON? Make sure External Clock is set to OFF; refer to "External Clock" on page 94.
The style does not sound properly.	Make sure that the Style Volume (page 81) is set to an appropriate level.
	Is the split point set at an appropriate key for the chords you are playing? Set the split point at an appropriate key (page 59).
	Is the [ACMP] button lit? If it is not lit, press the [ACMP] button so it lights.
No rhythm accompaniment plays when the [START/STOP] button is pressed after selecting the BaroqueAir Style in the MOVIE & SHOW category.	This is not a malfunction. Style BaroqueAir Style does not have a Rhythm part, so there is no rhythm sound for this Style. Also, this Style does not have a Fill-In section. The other parts will begin playing when you play a chord in the accompaniment.
Not all of the voices seem to sound, or the sound seems to be cut off.	The instrument is polyphonic up to a maximum of 32 notes. If the Dual voice or Split voice is being used and a style or song is playing back at the same time, some notes/sounds may be omitted (or "stolen") from the accompaniment or song.
The footswitch (for sustain) seems to produce the opposite effect. For example, pressing the footswitch cuts off the sound and releasing it sustains the sounds.	The polarity of the footswitch is reversed. Make sure that the footswitch plug is properly connected to the SUSTAIN jack before turning on the power.
The sound of the voice changes from note to note.	This is normal. The AWM tone generation method uses multiple recordings (samples) of an instrument across the range of the keyboard; thus, the actual sound of the voice may be slightly different from note to note.
The Demo display is shown in Japanese, and/or there are Japanese characters in the display messages.	Make sure the Language setting in the FUNCTION display is set to English. (See page 12)
The ACMP indicator does not appear when the [ACMP] button is pressed.	Always press desired style category button first when you are going to use any style-related function.
There is no harmony sound.	The harmony effects (01–26) behave differently according to their type. Types 01–05 function when style playback is on, chords are played in the accompaniment range of the keyboard, and a melody is played in the right-hand range. Types 06–26 will function whether style playback is on or off. For types 06–12 you need to play two notes at the same time.



Messages

LCD Message	Comment
Access error!	Indicates the failure in reading or writing from/to the media, USB flash memory or the internal flash memory.
All Memory Clearing...	Displayed while erasing all data in the flash memory. Never turn the power off during data transmission.
Are you sure?	Confirms whether Song Clear or Track Clear is executed or not.
Backup Clearing...	Displayed while clearing the back-up data in the flash memory.
Cancel	Displayed when the transmission of Initial Send is cancelled.
Can't clear TrackA.	Displayed when a track clear error occurs.
Clearing...	Displayed while executing Song Clear or Track Clear of the user songs.
Com Mode	Displayed when the Musicsoft Downloader is started on the PC connected to the keyboard. This will not be displayed while the instrument is played back.
Completed	Indicates the specified job completion such as data saving and transmission.
Create Directory	Displayed while creating a folder in the Musicsoft Downloader application.
Data Error!	Displayed when the user song contains illegal data.
Delete File	Displayed while deleting a file in the Musicsoft Downloader.
Delete OK ?	Confirms whether the Delete job is executed or not.
Delete Directory	Displayed while deleting a folder in the Musicsoft Downloader.
Deleting...	Displayed while the delete function is engaged.
End	Displayed when the transmission of Initial Send has been completed.
Exit.	Displayed when the record standby mode is exited because an inappropriate style has been selected during style record standby.
"File information area is not large enough."	Indicates that saving data in the media cannot be executed since the total number of files have become too many.
File is not found.	Indicates there is no file.
"File too large. Loading is impossible."	Indicates that loading data cannot be executed since the file data is too large.
Flash Clearing...	Displayed while clearing the song or style data transmitted to the internal flash memory.
Format OK ? [EXECUTE]	Confirms whether formatting the media is executed or not.
Formatting...	Displayed while formatting.
Load OK ?	Confirms whether loading is executed or not.
Loading...	Displayed while loading data.
Media is not inserted.	Displayed when accessing the media while it is not inserted.
Media capacity is full.	Displayed when saving data cannot be executed since the media memory becomes full.
Memory Full	Displayed when the internal memory becomes full during recording.
"MIDI receive buffer overflow."	Displayed when too much MIDI data was received at one time and failed to proceed.
Move File	Displayed while moving a file in the Musicsoft Downloader.
"Now Writing... (Don't turn off the power now, otherwise the data may be damaged.)"	Displayed while writing data in the memory. Never turn the power off while writing. Doing so may result in data loss.

LCD Message	Comment
OverCurrent	Communication with the USB device has been shut down because of the overcurrent to the USB device. Disconnect the device from the USB TO DEVICE terminal, then turn on the power of the instrument.
Overwrite ?	Confirms whether overwriting is executed or not.
Please Wait...	Displayed when executing the jobs that take some time, such as displaying scores and lyrics, or stopping recording.
Rename File	Displayed while rewriting the file name in the Musicsoft Downloader.
Save OK ?	Confirms whether saving is executed or not.
Saved data is not found.	Displayed when the data to be saved doesn't exist.
Saving...	Displayed while saving data in the memory. Never turn the power off while saving. Doing so may result in data loss.
Send OK?	Confirms whether the data transmission is executed or not.
Sending...	Displayed while transmitting data.
"Since the media is in use now, this function is not available."	Indicates that the file control function is currently unavailable since the media is being accessed.
Sure ? [YES/NO]	Reconfirms whether each operation is executed or not.
"The limit of the media has been reached."	Indicates that saving data cannot be executed since the folder/directory structure has become too complicated.
The media is not formatted.	Indicates the inserted media has not been formatted.
"The media is write-protected."	Indicates that the inserted media cannot be written since it is write-protected. Set to the write-protect switch to the "overwrite" position before use.
"The song data is too large to be converted to notation."	Indicates that the score cannot be displayed since the song data is too large.
There are too many files.	Indicates that saving data cannot be executed since the total number of files exceeds the capacity.
"This function is not available now."	Indicates the designated function is not available since the instrument is executing another job.
[nnn] "file name"	Indicates the file name of the currently transmitting. "nnn" indicates the receiving block.

NOTE

- Not all the messages are listed in the table: the messages necessary to be explained only.



Voice List

■ Maximum Polyphony.....

The instrument has 64-note maximum polyphony. This means that it can play a maximum of up to 64 notes at once, regardless of what functions are used. Auto accompaniment uses a number of the available notes, so when auto accompaniment is used the total number of available notes for playing on the keyboard is correspondingly reduced. The same applies to the Split Voice and Song functions. If the maximum polyphony is exceeded, earlier played notes will be cut off and the most recent notes have priority (last note priority).

NOTE

- The Voice List includes MIDI program change numbers for each voice. Use these program change numbers when playing the instrument via MIDI from an external device.
- Program Numbers 001 to 128 directly relate to MIDI Program Change Numbers 000 to 127. That is, Program Numbers and Program Change Numbers differ by a value of 1. Remember to take this into consideration.
- Some voices may sound continuously or have a long decay after the notes have been released while the sustain pedal (footswitch) is held.

● Panel Voice List

Voice No.	Voice No. (category)	Bank Select		MIDI Program Change# (1-128)	Voice Name
		MSB (0-127)	LSB (0-127)		
Piano					
1	1	0	113	1	Live! Grand Piano
2	2	0	112	2	Live! Bright Piano
3	3	0	114	1	Live! WarmGrand
4	4	0	112	7	Harpsichord
5	5	0	113	7	GrandHarpsi
6	6	0	112	4	HonkyTonk
7	7	0	112	3	MidiGrand
8	8	0	113	4	Oct.Piano1
9	9	0	114	4	Oct.Piano2
10	10	0	113	3	CP80
E.Piano					
11	1	0	114	5	Cool! GalaxyEP
12	2	0	118	5	Cool! SuitcaseEP
13	3	0	115	5	PolarisEP
14	4	0	118	6	JazzChorus
15	5	0	113	6	HyperTines
16	6	0	119	5	Cool! E.Piano
17	7	0	120	5	PhaseEP
18	8	0	116	6	NewTines
19	9	0	112	5	FunkEP
20	10	0	112	6	DX Modern
21	11	0	116	5	VintageEP
22	12	0	114	6	VenusEP
23	13	0	115	6	ModernEP
24	14	0	113	5	TremoloEP
25	15	0	117	6	SuperDX
26	16	0	117	5	StageEP
27	17	0	112	8	Clavi
28	18	0	113	8	WahClavi
Strings					
29	1	0	117	50	Live! Strings
30	2	0	116	50	Live! Orchestra
31	3	0	122	50	Allegro Strings
32	4	0	114	49	Symphon.Str
33	5	0	113	41	Sweet! Violin
34	6	0	112	49	Strings
35	7	0	113	49	OrchStrings
36	8	0	112	52	AnalogStrs
37	9	0	112	50	ChamberStrs
38	10	0	116	49	BowStrings
39	11	0	113	50	SlowStrings
40	12	0	112	45	TremoloStrs
41	13	0	115	50	MarcatoStrs
42	14	0	112	51	SynStrings1
43	15	0	112	46	PizzStrings
44	16	0	125	49	Watariyat
45	17	0	112	42	Viola
46	18	0	112	43	Cello
47	19	0	112	44	Contrabass
48	20	0	113	111	Er Hu
49	21	0	112	47	Harp
50	22	0	113	47	Hackbrett
51	23	0	113	108	Kanoun

Voice No.	Voice No. (category)	Bank Select		MIDI Program Change# (1-128)	Voice Name
		MSB (0-127)	LSB (0-127)		
52	24	0	112	111	Fiddle
53	25	0	112	106	Banjo
54	26	0	112	108	Koto
55	27	0	112	107	Shamisen
56	28	0	113	106	Oud
57	29	0	112	105	Sitar1
58	30	0	113	105	Sitar2
59	31	0	119	106	Pi Pa
60	32	0	112	41	SoloViolin
61	33	0	112	56	Orch.Hit
Guitar&Bass					
62	1	0	116	25	Dynamic Nylon
63	2	0	117	26	Live! SteelGuitar
64	3	0	115	27	Cool! JazzGuitar
65	4	0	114	29	Cool! Elec.Gtr
66	5	0	114	26	Sweet! Mandolin
67	6	0	118	26	Live! SlideSteel
68	7	0	117	29	Cool! SlideClean
69	8	0	125	28	Cool! VintageLead
70	9	0	113	26	Live! 12StringGtr
71	10	0	115	31	Cool! PowerLead
72	11	0	116	26	Live! DynamicSteel
73	12	0	117	30	Cool! BluesGuitar
74	13	0	112	28	Cool! CleanGuitar
75	14	0	115	25	Classic Guitar
76	15	0	115	28	PedalSteel
77	16	0	116	30	RockGuitar
78	17	0	126	28	VintageStrum
79	18	0	117	31	PowerChord
80	19	0	117	28	60'sClean
81	20	0	119	27	SmoothLead
82	21	0	115	30	VintageAmp
83	22	0	113	31	CrunchGtr
84	23	0	115	26	CampfireGtr
85	24	0	118	28	SolidGuitar
86	25	0	123	28	VintageOpen
87	26	0	115	29	VintageMute
88	27	0	114	30	LeadGuitar
89	28	0	124	28	ChorusGtr
90	29	0	120	28	VintageTrem
91	30	0	113	27	OctaveGtr
92	31	0	114	28	DeepChorus
93	32	0	113	28	TremoloGtr
94	33	0	114	31	HeavyStack
95	34	0	122	28	WahGuitar
96	35	0	112	31	Distortion
97	36	0	119	28	Elec.12Str
98	37	0	113	30	FeedbackGtr
99	38	0	112	29	MutedGuitar
100	39	0	113	29	FunkGuitar
101	40	0	116	31	VoodooLead
102	41	0	112	26	FolkGuitar
103	42	0	112	30	Overdrive
104	43	0	114	34	Cool! ElectricBass

Voice List

Voice No.	Voice No. (category)	Bank Select		MIDI Program Change# (1-128)	Voice Name
		MSB (0-127)	LSB (0-127)		
105	44	0	112	33	Aco.Bass
106	45	0	112	35	PickBass
107	46	0	112	36	Cool! Fretless
108	47	0	112	37	SlapBass
109	48	0	114	40	SubBass
110	49	0	114	39	HardBass
111	50	0	112	39	ResoBass
112	51	0	113	36	SuperFretless
113	52	0	113	37	FusionBass
114	53	0	114	33	Bass&Cymbal
115	54	0	112	40	AnalogBass
116	55	0	116	40	DrySynBass
117	56	0	115	40	80'sSynBass
118	57	0	113	39	HiQBass
119	58	0	112	38	FunkBass
120	59	0	115	39	ClickBass
121	60	0	112	34	MellowFinger
Saxophone					
122	1	0	117	67	Sweet! TenorSax
123	2	0	114	66	Sweet! AltoSax
124	3	0	113	65	Sweet! SopranoSax
125	4	0	118	67	GrowlSax
126	5	0	112	68	BaritoneSax
127	6	0	112	65	SopranoSax
128	7	0	112	67	TenorSax
129	8	0	112	66	AltoSax
130	9	0	113	67	WoodwindEns
Flute&Woodwind					
131	1	0	114	74	Sweet! Flute
132	2	0	114	72	Sweet! Clarinet
133	3	0	113	76	Sweet! PanFlute
134	4	0	112	70	EnglishHorn
135	5	0	112	71	Bassoon
136	6	0	115	74	Sweet! Class.Flute
137	7	0	112	73	Piccolo
138	8	0	112	72	Clarinet
139	9	0	112	69	Oboe
140	10	0	112	74	Flute
141	11	0	113	74	PanFlute
142	12	0	112	79	Whistle
143	13	0	112	76	EthnicFlute
144	14	0	112	78	Shakuhachi
145	15	0	112	75	Recorder
146	16	0	112	80	Ocarina
147	17	0	112	110	Bagpipe
148	18	0	114	78	Nay
149	19	0	118	74	Di Zi
150	20	0	116	110	Sheng
Organ					
151	1	0	118	19	Cool! Organ
152	2	0	117	17	Cool! JazzOrgan
153	3	0	117	19	Cool! RotorOrgan
154	4	0	115	19	Cool! FullRocker
155	5	0	118	17	StadiumOrg
156	6	0	116	19	RotaryDrive
157	7	0	112	19	RockOrgan1
158	8	0	113	18	DanceOrgan
159	9	0	112	17	JazzOrgan1
160	10	0	114	19	PurpleOrg
161	11	0	118	18	Elec.Organ
162	12	0	115	17	DrawbarOrg
163	13	0	113	17	JazzOrgan2
164	14	0	113	19	RockOrgan2
165	15	0	112	18	ClickOrgan
166	16	0	119	17	GospelOrg
167	17	0	115	18	MellowDraw
168	18	0	116	17	BrightDraw
169	19	0	116	18	60'sOrgan
170	20	0	120	17	JazzOrgan3
171	21	0	114	17	Tibia 16+4
172	22	0	114	18	Tibia Full
173	23	0	113	20	ChapelOrgn1

Voice No.	Voice No. (category)	Bank Select		MIDI Program Change# (1-128)	Voice Name
		MSB (0-127)	LSB (0-127)		
174	24	0	114	20	ChapelOrgn2
175	25	0	115	20	ChapelOrgn3
176	26	0	112	20	PipeOrgan
177	27	0	112	21	ReedOrgan
178	28	0	114	21	Harmonium1
179	29	0	115	21	Harmonium2
Trumpet					
180	1	0	115	57	Sweet! Trumpet
181	2	0	117	58	Sweet! Trombone
182	3	0	116	57	JazzTrumpet
183	4	0	112	57	SoloTrumpet
184	5	0	113	57	FlugelHorn
185	6	0	116	58	Trombone
186	7	0	115	58	SoftTromb
187	8	0	112	58	SoloTromb
188	9	0	114	58	MellowTromb
189	10	0	112	60	MutedTrump
190	11	0	113	59	BaritonHorn
191	12	0	114	59	BaritonHit
192	13	0	112	59	Tuba
193	14	0	113	34	AlpBass
Brass					
194	1	0	117	63	Live! PopBrass
195	2	0	118	63	Live! HyperBrass
196	3	0	116	63	Live! OctaveBrass
197	4	0	112	61	Live! FrenchHorns
198	5	0	115	67	BrassCombo
199	6	0	112	62	BrassSection
200	7	0	125	62	Sforzando
201	8	0	121	62	BigBrass
202	9	0	113	60	BallroomBrs
203	10	0	120	62	BrightBrass
204	11	0	116	62	MellowBrass
205	12	0	113	63	80'sBrass
206	13	0	123	62	SoftBrass
207	14	0	114	62	FullHorns
208	15	0	118	58	SmoothTromb
209	16	0	115	62	HighBrass
210	17	0	113	64	OberBrass
211	18	0	122	62	TrumpetEns
212	19	0	119	62	MellowHorns
213	20	0	113	62	BigBandBrs
214	21	0	118	62	PopBrass
215	22	0	112	64	AnalogBrs
216	23	0	113	58	Trb.Section
217	24	0	117	62	SmallBrass
218	25	0	114	64	SoftAnalog
219	26	0	115	63	FunkyAnalog
220	27	0	114	63	TechnoBrass
221	28	0	112	63	SynthBrass
Choir					
222	1	0	112	55	AirChoir
223	2	0	113	54	GothicVox
224	3	0	118	89	SweetHeaven
225	4	0	121	89	DreamHeaven
226	5	0	112	53	Choir
227	6	0	112	54	VoxHumana
Pad					
228	1	0	113	95	Insomnia
229	2	0	115	90	NeoWarmPad
230	3	0	113	100	CyberPad
231	4	0	112	96	Wave2001
232	5	0	112	100	Atmosphere
233	6	0	112	92	XenonPad
234	7	0	112	95	Equinox
235	8	0	112	89	Fantasia
236	9	0	112	93	DX Pad
237	10	0	113	89	Symbiont
238	11	0	114	89	Stargate
239	12	0	112	90	Area51
240	13	0	113	90	DarkMoon
241	14	0	115	95	Ionosphere

Voice List

Voice No.	Voice No. (category)	Bank Select		MIDI Program Change# (1-128)	Voice Name
		MSB (0-127)	LSB (0-127)		
242	15	0	115	89	GoldenAge
243	16	0	114	95	Solaris
244	17	0	117	89	Millennium
245	18	0	114	90	Dunes
Synth.&FX					
246	1	0	122	82	Oxygen
247	2	0	123	82	Matrix
248	3	0	120	82	WireLead
249	4	0	113	81	HipLead
250	5	0	117	81	HopLead
251	6	0	116	82	FireWire
252	7	0	115	82	Analogon
253	8	0	114	82	Blaster
254	9	0	115	85	Skyline
255	10	0	112	81	SquareLead
256	11	0	112	82	Saw.Lead
257	12	0	118	81	TinyLead
258	13	0	121	82	FunkyLead
259	14	0	114	85	Paraglide
260	15	0	112	85	Portatone
261	16	0	113	82	BigLead
262	17	0	117	82	Warp
263	18	0	119	82	Fargo
264	19	0	113	85	Adrenaline
265	20	0	112	99	Stardust
266	21	0	112	84	AeroLead
267	22	0	114	81	MiniLead
268	23	0	113	88	Impact
269	24	0	113	99	SunBell
270	25	0	112	88	UnderHeim
271	26	0	116	81	HiBias
272	27	0	115	81	Vinylead
273	28	126	0	1	SFXKit1
274	29	126	0	2	SFXKit2
275	30	126	0	112	AnimalKit
Accordion&Harmonica					
276	1	0	112	22	Musette
277	2	0	117	22	Steirisch
278	3	0	113	22	TuttiAccrd
279	4	0	115	22	SmallAccrd
280	5	0	116	22	Accordion
281	6	0	112	24	BallroomAcc
282	7	0	113	24	Bandoneon
283	8	0	114	22	SoftAccrd
284	9	0	113	23	ModernHarp
285	10	0	114	23	BluesHarp
Percussion					
286	1	0	112	12	Vibraphone
287	2	0	113	12	JazzVibes
288	3	0	112	13	Marimba
289	4	0	112	14	Xylophone
290	5	0	112	115	SteelDrums
291	6	0	112	9	Celesta
292	7	0	112	10	Glocken
293	8	0	112	11	MusicBox
294	9	0	112	15	TubularBell
295	10	0	112	109	Kalimba
296	11	0	112	16	Dulcimer
297	12	0	112	48	Timpani
Drum Kit					
298	1	127	0	1	StandardKit1
299	2	127	0	2	StandardKit2
300	3	127	0	5	HitKit
301	4	127	0	33	JazzKit
302	5	127	0	41	BrushKit
303	6	127	0	9	RoomKit
304	7	127	0	17	RockKit
305	8	127	0	25	ElectroKit
306	9	127	0	26	AnalogKit
307	10	127	0	28	DanceKit
308	11	127	0	49	SymphonyKit

Voice No.	Voice No. (category)	Bank Select		MIDI Program Change# (1-128)	Voice Name
		MSB (0-127)	LSB (0-127)		
309	12	126	0	41	CubanKit
310	13	126	0	44	PopLatinKit
311	14	126	0	36	ArabicKit
312	15	126	0	37	ArabicKit 2
313	16	126	0	65	ArabicMixKit
314	17	126	0	115	IndianKit
315	18	126	0	125	ChineseKit
316	19	127	0	128	ChineseMixKit

● GM&XG Voice List

Voice No.	Voice No. (category)	Bank Select		MIDI Program Change# (1-128)	Voice Name
		MSB (0-127)	LSB (0-127)		
317	1	0	0	1	GrandPiano
318	2	0	1	1	GrndPianoKSP
319	3	0	18	1	MellowGrPno
320	4	0	40	1	PianoStrings
321	5	0	41	1	Dream
322	6	0	0	2	BrightPiano
323	7	0	1	2	BritePnoKSP
324	8	0	0	3	ElecGrandPno
325	9	0	1	3	ElecGrPnoKSP
326	10	0	32	3	DetunedCP80
327	11	0	40	3	LayeredCP1
328	12	0	41	3	LayeredCP2
329	13	0	0	4	Honkytonk
330	14	0	1	4	HonkytonkKSP
331	15	0	0	5	El.Piano1
332	16	0	1	5	El.Piano1KSP
333	17	0	18	5	MellowEP1
334	18	0	32	5	ChorusEP1
335	19	0	40	5	HardEl.Piano
336	20	0	45	5	VXfadeEl.P1
337	21	0	64	5	60sEl.Piano1
338	22	0	0	6	El.Piano2
339	23	0	1	6	El.Piano2KSP
340	24	0	32	6	ChorusEP2
341	25	0	33	6	DXEPHard
342	26	0	34	6	DXLegend
343	27	0	40	6	DXPhaseEP
344	28	0	41	6	DX+AnalogEP
345	29	0	42	6	DXKotoEP
346	30	0	45	6	VXfadeEl.P2
347	31	0	0	7	Harpsichord
348	32	0	1	7	Harpsi.KSP
349	33	0	25	7	Harpsichord2
350	34	0	35	7	Harpsichord3
351	35	0	0	8	Clavi.
352	36	0	1	8	Clavi.KSP
353	37	0	27	8	Clavi.Wah
354	38	0	64	8	PulseClavi.
355	39	0	65	8	PierceClavi.
356	40	0	0	9	Celesta
357	41	0	0	10	Glockenspiel
358	42	0	0	11	MusicBox
359	43	0	64	11	Orgel
360	44	0	0	12	Vibraphone
361	45	0	1	12	VibesKSP
362	46	0	45	12	HardVibes
363	47	0	0	13	Marimba
364	48	0	1	13	MarimbaKSP
365	49	0	64	13	SineMarimba
366	50	0	97	13	Balimba
367	51	0	98	13	LogDrums
368	52	0	0	14	Xylophone
369	53	0	0	15	TubularBells
370	54	0	96	15	ChurchBells
371	55	0	97	15	Carillon
372	56	0	0	16	Dulcimer

Voice List

Voice No.	Voice No. (category)	Bank Select		MIDI Program Change# (1-128)	Voice Name
		MSB (0-127)	LSB (0-127)		
373	57	0	35	16	Dulcimer2
374	58	0	96	16	Cimbalom
375	59	0	97	16	Santur
376	60	0	0	17	DrawbarOrgan
377	61	0	32	17	DetDrawOrgan
378	62	0	33	17	60sDrawOrg1
379	63	0	34	17	60sDrawOrg2
380	64	0	35	17	70sDrawOrg1
381	65	0	36	17	DrawbarOrg2
382	66	0	37	17	60sDrawOrg3
383	67	0	38	17	EvenBarOrg
384	68	0	40	17	16+2'2_3Org
385	69	0	64	17	OrganBass
386	70	0	65	17	70sDrawOrg2
387	71	0	66	17	CheezyOrgan
388	72	0	67	17	DrawbarOrg3
389	73	0	0	18	Perc.Organ
390	74	0	24	18	70sPercOrg1
391	75	0	32	18	DetPercOrgan
392	76	0	33	18	LightOrgan
393	77	0	37	18	Perc.Organ2
394	78	0	0	19	RockOrgan
395	79	0	64	19	RotaryOrgan
396	80	0	65	19	SlowRotary
397	81	0	66	19	FastRotary
398	82	0	0	20	ChurchOrgan
399	83	0	32	20	ChurchOrgan3
400	84	0	35	20	ChurchOrgan2
401	85	0	40	20	NotreDame
402	86	0	64	20	OrganFlute
403	87	0	65	20	Trem.OrganFl
404	88	0	0	21	ReedOrgan
405	89	0	40	21	PuffOrgan
406	90	0	0	22	Accordion
407	91	0	32	22	AccordIt
408	92	0	0	23	Harmonica
409	93	0	32	23	Harmonica2
410	94	0	0	24	TangoAccord
411	95	0	64	24	TangoAccord2
412	96	0	0	25	NylonGuitar
413	97	0	16	25	NylonGuitar2
414	98	0	25	25	NylonGuitar3
415	99	0	43	25	VelGtrHarmo
416	100	0	96	25	Ukulele
417	101	0	0	26	SteelGuitar
418	102	0	16	26	SteelGuitar2
419	103	0	35	26	12StrGuitar
420	104	0	40	26	Nylon&Steel
421	105	0	41	26	Steel&Body
422	106	0	96	26	Mandolin
423	107	0	0	27	JazzGuitar
424	108	0	18	27	MellowGuitar
425	109	0	32	27	JazzAmp
426	110	0	0	28	CleanGuitar
427	111	0	32	28	ChorusGuitar
428	112	0	0	29	MutedGuitar
429	113	0	40	29	FunkGuitar1
430	114	0	41	29	MuteSteelGtr
431	115	0	43	29	FunkGuitar2
432	116	0	45	29	JazzMan
433	117	0	0	30	Overdriven
434	118	0	43	30	GuitarPinch
435	119	0	0	31	Distortion
436	120	0	40	31	FeedbackGtr
437	121	0	41	31	FeedbackGtr2
438	122	0	0	32	GtrHarmonics
439	123	0	65	32	GtrFeedback
440	124	0	66	32	GtrHarmonic2
441	125	0	0	33	AcousticBass
442	126	0	40	33	JazzRhythm
443	127	0	45	33	VXUprghtBass

Voice No.	Voice No. (category)	Bank Select		MIDI Program Change# (1-128)	Voice Name
		MSB (0-127)	LSB (0-127)		
444	128	0	0	34	FingerBass
445	129	0	18	34	FingerDark
446	130	0	27	34	FlangeBass
447	131	0	40	34	Bass&DistEG
448	132	0	43	34	FingerSlap
449	133	0	45	34	FingerBass2
450	134	0	65	34	Mod.Bass
451	135	0	0	35	PickBass
452	136	0	28	35	MutePickBass
453	137	0	0	36	FretlessBass
454	138	0	32	36	Fretless2
455	139	0	33	36	Fretless3
456	140	0	34	36	Fretless4
457	141	0	96	36	Syn.Fretless
458	142	0	97	36	SmthFretless
459	143	0	0	37	SlapBass1
460	144	0	27	37	ResonantSlap
461	145	0	32	37	PunchThumb
462	146	0	0	38	SlapBass2
463	147	0	43	38	Velo.Sw.Slap
464	148	0	0	39	SynthBass1
465	149	0	18	39	SynBass1Dark
466	150	0	20	39	FastResoBass
467	151	0	24	39	AcidBass
468	152	0	35	39	ClaviBass
469	153	0	40	39	TechnoBass
470	154	0	64	39	Orbiter
471	155	0	65	39	SquareBass
472	156	0	66	39	RubberBass
473	157	0	96	39	Hammer
474	158	0	0	40	SynthBass2
475	159	0	6	40	MellowSyBass
476	160	0	12	40	SequenceBass
477	161	0	18	40	ClickSynBass
478	162	0	19	40	SynBass2Dark
479	163	0	32	40	SmoothSyBass
480	164	0	40	40	ModulrSyBass
481	165	0	41	40	DXBass
482	166	0	64	40	XWireBass
483	167	0	0	41	Violin
484	168	0	8	41	SlwAtkViolin
485	169	0	0	42	Viola
486	170	0	0	43	Cello
487	171	0	0	44	Contrabass
488	172	0	0	45	Trem.Strings
489	173	0	8	45	SlwAtTremStr
490	174	0	40	45	SuspenseStr
491	175	0	0	46	PizzicatoStr
492	176	0	0	47	Orch.Harp
493	177	0	40	47	YangChin
494	178	0	0	48	Timpani
495	179	0	0	49	Strings1
496	180	0	3	49	StereoStrngs
497	181	0	8	49	SlwAtkStrngs
498	182	0	24	49	ArcoStrings
499	183	0	35	49	60'sStrings
500	184	0	40	49	Orchestra
501	185	0	41	49	Orchestra2
502	186	0	42	49	TremOrchestra
503	187	0	45	49	Velo.Strings
504	188	0	0	50	Strings2
505	189	0	3	50	S.SlowStrngs
506	190	0	8	50	LegatoStrngs
507	191	0	40	50	WarmStrings
508	192	0	41	50	Kingdom
509	193	0	64	50	70'sStrings
510	194	0	65	50	Strings3
511	195	0	0	51	SynStrings1
512	196	0	27	51	ResoStrings
513	197	0	64	51	SynStrings4
514	198	0	65	51	SynStrings5

Voice List

Voice No.	Voice No. (category)	Bank Select		MIDI Program Change# (1-128)	Voice Name
		MSB (0-127)	LSB (0-127)		
515	199	0	0	52	SynStrings2
516	200	0	0	53	ChoirAahs
517	201	0	3	53	StereoChoir
518	202	0	16	53	ChoirAahs2
519	203	0	32	53	MellowChoir
520	204	0	40	53	ChoirStrings
521	205	0	0	54	VoiceOohs
522	206	0	0	55	SynthVoice
523	207	0	40	55	SynthVoice2
524	208	0	41	55	Choral
525	209	0	64	55	AnalogVoice
526	210	0	0	56	OrchestraHit
527	211	0	35	56	OrchestrHit2
528	212	0	64	56	Impact
529	213	0	0	57	Trumpet
530	214	0	16	57	Trumpet2
531	215	0	17	57	BriteTrumpet
532	216	0	32	57	WarmTrumpet
533	217	0	0	58	Trombone
534	218	0	18	58	Trombone2
535	219	0	0	59	Tuba
536	220	0	16	59	Tuba2
537	221	0	0	60	MutedTrumpet
538	222	0	0	61	FrenchHorn
539	223	0	6	61	Fr.HornSolo
540	224	0	32	61	FrenchHorn2
541	225	0	37	61	HornOrchestr
542	226	0	0	62	BrassSection
543	227	0	35	62	Tp&TbSection
544	228	0	40	62	BrassSect2
545	229	0	41	62	HighBrass
546	230	0	42	62	MellowBrass
547	231	0	0	63	SynthBrass1
548	232	0	12	63	QuackBrass
549	233	0	20	63	ResoSynBrass
550	234	0	24	63	PolyBrass
551	235	0	27	63	SynthBrass3
552	236	0	32	63	JumpBrass
553	237	0	45	63	AnaVelBrass1
554	238	0	64	63	AnalogBrass1
555	239	0	0	64	SynthBrass2
556	240	0	18	64	SoftBrass
557	241	0	40	64	SynthBrass4
558	242	0	41	64	ChoirBrass
559	243	0	45	64	AnaVelBrass2
560	244	0	64	64	AnalogBrass2
561	245	0	0	65	SopranoSax
562	246	0	0	66	AltoSax
563	247	0	40	66	SaxSection
564	248	0	43	66	HyperAltoSax
565	249	0	0	67	TenorSax
566	250	0	40	67	BreathyTenor
567	251	0	41	67	SoftTenorSax
568	252	0	64	67	TenorSax2
569	253	0	0	68	BaritoneSax
570	254	0	0	69	Oboe
571	255	0	0	70	EnglishHorn
572	256	0	0	71	Bassoon
573	257	0	0	72	Clarinet
574	258	0	0	73	Piccolo
575	259	0	0	74	Flute
576	260	0	0	75	Recorder
577	261	0	0	76	PanFlute
578	262	0	0	77	BlownBottle
579	263	0	0	78	Shakuhachi
580	264	0	0	79	Whistle
581	265	0	0	80	Ocarina
582	266	0	0	81	SquareLead
583	267	0	6	81	SquareLead2
584	268	0	8	81	LMSquare
585	269	0	18	81	Hollow

Voice No.	Voice No. (category)	Bank Select		MIDI Program Change# (1-128)	Voice Name
		MSB (0-127)	LSB (0-127)		
586	270	0	19	81	Shroud
587	271	0	64	81	Mellow
588	272	0	65	81	SoloSine
589	273	0	66	81	SineLead
590	274	0	0	82	SawtoothLead
591	275	0	6	82	SawtoothLd2
592	276	0	8	82	ThickSaw
593	277	0	18	82	DynamicSaw
594	278	0	19	82	DigitalSaw
595	279	0	20	82	BigLead
596	280	0	24	82	HeavySynth
597	281	0	25	82	WaspySynth
598	282	0	40	82	PulseSaw
599	283	0	41	82	Dr.Lead
600	284	0	45	82	VelocityLead
601	285	0	96	82	Seq.Analog
602	286	0	0	83	CalliopeLead
603	287	0	65	83	PureLead
604	288	0	0	84	ChiffLead
605	289	0	64	84	Rubby
606	290	0	0	85	CharangLead
607	291	0	64	85	DistortedLd
608	292	0	65	85	WireLead
609	293	0	0	86	VoiceLead
610	294	0	24	86	SynthAahs
611	295	0	64	86	VoxLead
612	296	0	0	87	FifthsLead
613	297	0	35	87	BigFive
614	298	0	0	88	Bass&Lead
615	299	0	16	88	Big&Low
616	300	0	64	88	Fat&Perky
617	301	0	65	88	SoftWhirl
618	302	0	0	89	NewAgePad
619	303	0	64	89	Fantasy
620	304	0	0	90	WarmPad
621	305	0	16	90	ThickPad
622	306	0	17	90	SoftPad
623	307	0	18	90	SinePad
624	308	0	64	90	HornPad
625	309	0	65	90	RotaryStrngs
626	310	0	0	91	PolySynthPad
627	311	0	64	91	PolyPad80
628	312	0	65	91	ClickPad
629	313	0	66	91	AnalogPad
630	314	0	67	91	SquarePad
631	315	0	0	92	ChoirPad
632	316	0	64	92	Heaven
633	317	0	66	92	ltopia
634	318	0	67	92	CCPad
635	319	0	0	93	BowedPad
636	320	0	64	93	Glacier
637	321	0	65	93	GlassPad
638	322	0	0	94	MetallicPad
639	323	0	64	94	TinePad
640	324	0	65	94	PanPad
641	325	0	0	95	HaloPad
642	326	0	0	96	SweepPad
643	327	0	20	96	Shwimmer
644	328	0	27	96	Converge
645	329	0	64	96	PolarPad
646	330	0	66	96	Celestial
647	331	0	0	97	Rain
648	332	0	45	97	ClaviPad
649	333	0	64	97	HarmoRain
650	334	0	65	97	AfricanWind
651	335	0	66	97	Carib
652	336	0	0	98	SoundTrack
653	337	0	27	98	Prologue
654	338	0	64	98	Ancestral
655	339	0	0	99	Crystal
656	340	0	12	99	SynthDr.Comp

Voice List

Voice No.	Voice No. (category)	Bank Select		MIDI Program Change# (1-128)	Voice Name
		MSB (0-127)	LSB (0-127)		
657	341	0	14	99	Popcorn
658	342	0	18	99	TinyBells
659	343	0	35	99	RoundGlocken
660	344	0	40	99	GlockenChime
661	345	0	41	99	ClearBells
662	346	0	42	99	ChorusBells
663	347	0	64	99	SynthMallet
664	348	0	65	99	SoftCrystal
665	349	0	66	99	LoudGlocken
666	350	0	67	99	ChristmasBel
667	351	0	68	99	VibeBells
668	352	0	69	99	DigitalBells
669	353	0	70	99	AirBells
670	354	0	71	99	BellHarp
671	355	0	72	99	Gamelimba
672	356	0	0	100	Atmosphere
673	357	0	18	100	WarmAtmos.
674	358	0	19	100	HollwRelease
675	359	0	40	100	NylonElPiano
676	360	0	64	100	NylonHarp
677	361	0	65	100	HarpVox
678	362	0	66	100	Atmos.Pad
679	363	0	67	100	Planet
680	364	0	0	101	Brightness
681	365	0	64	101	FantasyBells
682	366	0	96	101	Smokey
683	367	0	0	102	Goblins
684	368	0	64	102	GoblinsSynth
685	369	0	65	102	Creeper
686	370	0	66	102	RingPad
687	371	0	67	102	Ritual
688	372	0	68	102	ToHeaven
689	373	0	70	102	Night
690	374	0	71	102	Glisten
691	375	0	96	102	BellChoir
692	376	0	0	103	Echoes
693	377	0	8	103	Echoes2
694	378	0	14	103	EchoPan
695	379	0	64	103	EchoBells
696	380	0	65	103	BigPan
697	381	0	66	103	SynthPiano
698	382	0	67	103	Creation
699	383	0	68	103	StarDust
700	384	0	69	103	Reso&Panning
701	385	0	0	104	Sci-Fi
702	386	0	64	104	Starz
703	387	0	0	105	Sitar
704	388	0	32	105	DetunedSitar
705	389	0	35	105	Sitar2
706	390	0	96	105	Tambra
707	391	0	97	105	Tamboura
708	392	0	0	106	Banjo
709	393	0	28	106	MutedBanjo
710	394	0	96	106	Rabab
711	395	0	97	106	Gopichant
712	396	0	98	106	Oud
713	397	0	0	107	Shamisen
714	398	0	0	108	Koto
715	399	0	96	108	Taisho-kin
716	400	0	97	108	Kanoon
717	401	0	0	109	Kalimba
718	402	0	0	110	Bagpipe
719	403	0	0	111	Fiddle
720	404	0	0	112	Shanai
721	405	0	64	112	Shanai2
722	406	0	96	112	Pungi
723	407	0	97	112	Hichiriki
724	408	0	0	113	TinkleBell
725	409	0	96	113	Bonang
726	410	0	97	113	Altair
727	411	0	98	113	GamelanGongs

Voice No.	Voice No. (category)	Bank Select		MIDI Program Change# (1-128)	Voice Name
		MSB (0-127)	LSB (0-127)		
728	412	0	99	113	StereoGamlan
729	413	0	100	113	RamaCymbal
730	414	0	101	113	AsianBells
731	415	0	0	114	Agogo
732	416	0	0	115	SteelDrums
733	417	0	97	115	GlassPerc.
734	418	0	98	115	ThaiBells
735	419	0	0	116	Woodblock
736	420	0	96	116	Castanets
737	421	0	0	117	TaikoDrum
738	422	0	96	117	GranCassa
739	423	0	0	118	MelodicTom
740	424	0	64	118	MelodicTom2
741	425	0	65	118	RealTom
742	426	0	66	118	RockTom
743	427	0	0	119	SynthDrum
744	428	0	64	119	AnalogTom
745	429	0	65	119	ElectroPerc.
746	430	0	0	120	Rev.Cymbal
747	431	0	0	121	GtrFretNoise
748	432	0	0	122	BreathNoise
749	433	0	0	123	Seashore
750	434	0	0	124	BirdTweet
751	435	0	0	125	TelephonRing
752	436	0	0	126	Helicopter
753	437	0	0	127	Applause
754	438	0	0	128	Gunshot
755	439	64	0	1	CuttingNoise
756	440	64	0	2	CuttingNoiz2
757	441	64	0	4	StringSlap
758	442	64	0	17	Fl.KeyClick
759	443	64	0	33	Shower
760	444	64	0	34	Thunder
761	445	64	0	35	Wind
762	446	64	0	36	Stream
763	447	64	0	37	Bubble
764	448	64	0	38	Feed
765	449	64	0	49	Dog
766	450	64	0	50	Horse
767	451	64	0	51	BirdTweet2
768	452	64	0	55	Ghost
769	453	64	0	56	Maou
770	454	64	0	65	PhoneCall
771	455	64	0	66	DoorSqueak
772	456	64	0	67	DoorSlam
773	457	64	0	68	ScratchCut
774	458	64	0	69	ScratchSplit
775	459	64	0	70	WindChime
776	460	64	0	71	TelphonRing2
777	461	64	0	81	CarEngineIgn
778	462	64	0	82	CarTiresSql
779	463	64	0	83	CarPassing
780	464	64	0	84	CarCrash
781	465	64	0	85	Siren
782	466	64	0	86	Train
783	467	64	0	87	JetPlane
784	468	64	0	88	Starship
785	469	64	0	89	Burst
786	470	64	0	90	RollrCoaster
787	471	64	0	91	Submarine
788	472	64	0	97	Laugh
789	473	64	0	98	Scream
790	474	64	0	99	Punch
791	475	64	0	100	Heartbeat
792	476	64	0	101	FootSteps
793	477	64	0	113	MachineGun
794	478	64	0	114	LaserGun
795	479	64	0	115	Explosion
796	480	64	0	116	Firework



Drum Kit List

- “ ” indicates that the drum sound is the same as “Standard Kit 1”.
- Each percussion voice uses one note.
- The MIDI Note # and Note are actually one octave lower than keyboard Note # and Note. For example, in “1: Standard Kit 1”, the “Seq Click H” (Note# 36/Note C1) corresponds to (Note# 24/Note C0).
- Key Off: Keys marked “O” stop sounding the instant they are released.
- Voices with the same Alternate Note Number (*1 ... 4) cannot be played simultaneously. (They are designed to be played alternately with each other.)
- *: XG optional kit.

		Voice No.					1	2	3	4	5	6	
		MSB (0-127) / LSB (0-127) / PC (1-128)					127/000/001	127/000/002	127/000/005	127/000/033	127/000/041	127/000/009	
		Keyboard		MIDI		Key Off	Alternate Group	Standard Kit 1	Standard Kit 2	Hit Kit*	Jazz Kit	Brush Kit	Room Kit
		Note#	Note	Note#	Note								
		25	C# 0	13	C# -1		3	Surdo Mute					
		26	D 0	14	D -1		3	Surdo Open					
		27	D# 0	15	D# -1			Hi Q					
		28	E 0	16	E -1			Whip Slap					
		29	F 0	17	F -1		4	Scratch H					
		30	F# 0	18	F# -1		4	Scratch L					
		31	G 0	19	G -1			Finger Snap					
		32	G# 0	20	G# -1			Click Noise					
		33	A 0	21	A -1			Metronome Click					
		34	A# 0	22	A# -1			Metronome Bell					
		35	B 0	23	B -1			Seq Click L					
		36	C 1	24	C 0			Seq Click H					
C1	C#1	37	C# 1	25	C# 0			Brush Tap					
D1	D#1	38	D 1	26	D 0	O		Brush Swirl					
E1	E#1	39	D# 1	27	D# 0			Brush Slap					
F1	F#1	40	E 1	28	E 0	O		Brush Tap Swirl					
G1	G#1	41	F 1	29	F 0	O		Snare Roll	Snare Roll 2				
A1	A#1	42	F# 1	30	F# 0			Caanet					
B1	B#1	43	G 1	31	G 0			Snare Soft	Snare Soft 2	Snare Electro	Snare Jazz H	Brush Slap 2	
C2	C#2	44	G# 1	32	G# 0			Sticks					
D2	D#2	45	A 1	33	A 0			Kick Soft		Kick Tight L			
E2	E#2	46	A# 1	34	A# 0			Open Rim Shot	Open Rim Shot H Short	Snare Pitched			
F2	F#2	47	B 1	35	B 0			Kick Tight	Kick Tight Short	Kick Wet			
G2	G#2	48	C 2	36	C 1			Kick	Kick Short	Kick Tight H	Kick Jazz	Kick Small	
A2	A#2	49	C# 2	37	C# 1			Side Stick		Stick Ambient			
B2	B#2	50	D 2	38	D 1			Snare	Snare Short	Snare Ambient	Snare Jazz L	Brush Slap 3	Snare Snappy
C3	C#3	51	D# 2	39	D# 1			Hand Clap					
D3	D#3	52	E 2	40	E 1			Snare Tight	Snare Tight H	Snare Tight 2	Snare Jazz M	Brush Tap 2	Snare Tight Snappy
E3	E#3	53	F 2	41	F 1			Floor Tom L		Tom Jazz 1	Tom Brush 1	Tom Room 1	
F3	F#3	54	F# 2	42	F# 1	1		Hi-Hat Closed		Hi-Hat Close 2			
G3	G#3	55	G 2	43	G 1			Floor Tom H		Hybrid Tom 2	Tom Jazz 2	Tom Brush 2	Tom Room 2
A3	A#3	56	G# 2	44	G# 1	1		Hi-Hat Pedal		Hi-Hat Pedal 2			
B3	B#3	57	A 2	45	A 1			Low Tom		Hybrid Tom 3	Tom Jazz 3	Tom Brush 3	Tom Room 3
C4	C#4	58	A# 2	46	A# 1	1		Hi-Hat Open		Hi-Hat Open 2			
D4	D#4	59	B 2	47	B 1			Mid Tom L		Hybrid Tom 4	Tom Jazz 4	Tom Brush 4	Tom Room 4
E4	E#4	60	C 3	48	C 2			Mid Tom H		Hybrid Tom 5	Tom Jazz 5	Tom Brush 5	Tom Room 5
F4	F#4	61	C# 3	49	C# 2			Crash Cymbal 1					
G4	G#4	62	D 3	50	D 2			High Tom		Hybrid Tom 6	Tom Jazz 6	Tom Brush 6	Tom Room 6
A4	A#4	63	D# 3	51	D# 2			Ride Cymbal 1					
B4	B#4	64	E 3	52	E 2			Chinese Cymbal					
C5	C#5	65	F 3	53	F 2			Ride Cymbal Cup					
D5	D#5	66	F# 3	54	F# 2			Tambourine					
E5	E#5	67	G 3	55	G 2			Splash Cymbal					
F5	F#5	68	G# 3	56	G# 2			Cowbell					
G5	G#5	69	A 3	57	A 2			Crash Cymbal 2					
A5	A#5	70	A# 3	58	A# 2			Vibraslap					
B5	B#5	71	B 3	59	B 2			Ride Cymbal 2					
C6	C#6	72	C 4	60	C 3			Bongo H					
D6	D#6	73	C# 4	61	C# 3			Bongo L					
E6	E#6	74	D 4	62	D 3			Conga H Mute					
F6	F#6	75	D# 4	63	D# 3			Conga H Open					
G6	G#6	76	E 4	64	E 3			Conga L					
A6	A#6	77	F 4	65	F 3			Timbale H					
B6	B#6	78	F# 4	66	F# 3			Timbale L					
C7	C#7	79	G 4	67	G 3			Agogo H					
D7	D#7	80	G# 4	68	G# 3			Agogo L					
E7	E#7	81	A 4	69	A 3			Cabasa					
F7	F#7	82	A# 4	70	A# 3			Maracas					
G7	G#7	83	B 4	71	B 3	O		Samba While H					
A7	A#7	84	C 5	72	C 4	O		Samba While L					
B7	B#7	85	C# 5	73	C# 4			Guiro Short					
C8	C#8	86	D 5	74	D 4	O		Guiro Long					
D8	D#8	87	D# 5	75	D# 4			Claves					
E8	E#8	88	E 5	76	E 4			Wood Block H					
F8	F#8	89	F 5	77	F 4			Wood Block L					
G8	G#8	90	F# 5	78	F# 4			Cuica Mute					
A8	A#8	91	G 5	79	G 4			Cuica Open					
B8	B#8	92	G# 5	80	G# 4		2	Triangle Mute					
C9	C#9	93	A 5	81	A 4		2	Triangle Open					
D9	D#9	94	A# 5	82	A# 4			Shaker					
E9	E#9	95	B 5	83	B 4			Jingle Bells					
F9	F#9	96	C 6	84	C 5			Bell Tree					
G9	G#9	97	C# 6	85	C# 5								
A9	A#9	98	D 6	86	D 5								
B9	B#9	99	D# 6	87	D# 5								
C10	C#10	100	E 6	88	E 5								
D10	D#10	101	F 6	89	F 5								
E10	E#10	102	F# 6	90	F# 5								
F10	F#10	103	G 6	91	G 5								

		Voice No.						1	7	8	9	10
		MSB (0-127) / LSB (0-127) / PC (1-128)						127/000/001	127/000/017	127/000/025	127/000/026	127/000/28
		Keyboard		MIDI		Key Off	Alternate Group	Standard Kit 1	Rock Kit	Electronic Kit	Analog Kit	Dance Kit
		Note#	Note	Note#	Note							
		25	C# 0	13	C# -1		3	Surdo Mute				Kick Dance 1
		26	D 0	14	D -1		3	Surdo Open				Kick Dance 2
		27	D# 0	15	D# -1			Hi Q				
		28	E 0	16	E -1			Whip Slap				
		29	F 0	17	F -1		4	Scratch H				Scratch Dance 1
		30	F# 0	18	F# -1		4	Scratch L				Scratch Dance 2
		31	G 0	19	G -1			Finger Snap				
		32	G# 0	20	G# -1			Click Noise				
		33	A 0	21	A -1			Metronome Click				Dance Percussion 1
		34	A# 0	22	A# -1			Metronome Bell				Reverse Dance 1
		35	B 0	23	B -1			Seq Click L				Dance Percussion 2
		36	C 1	24	C 0			Seq Click H				Hi Q Dance 1
C1	C#1	37	C# 1	25	C# 0			Brush Tap				Snare Analog 3
D1	D#1	38	D 1	26	D 0	O		Brush Swirl				Vinyl Noise
E1	E#1	39	D# 1	27	D# 0	O		Brush Slap				Snare Analog 4
F1	F#1	40	E 1	28	E 0	O		Brush Tap Swirl		Reverse Cymbal	Reverse Cymbal	Reverse Cymbal
G1	G#1	41	F 1	29	F 0	O		Snare Roll				Reverse Dance 2
		42	F# 1	30	F# 0			Caanet		Hi Q 2	Hi Q 2	Hi Q 2
		43	G 1	31	G 0			Snare Soft	Snare Noisy	Snare Snappy Electro	Snare Noisy 4	Snare Techno
		44	G# 1	32	G# 0			Sticks				Snare Dance 1
A1	A#1	45	A 1	33	A 0			Kick Soft	Kick Tight 2	Kick 3	Kick Tight 2	Kick Techno Q
B1	B#1	46	A# 1	34	A# 0			Open Rim Shot				Rim Gate
C2	C#2	47	B 1	35	B 0			Kick Tight	Kick 2	Kick Gate	Kick Analog Short	Kick Techno L
D2	D#2	48	C 2	36	C 1			Kick	Kick Gate	Kick Gate Heavy	Kick Analog	Kick Techno
E2	E#2	49	C# 2	37	C# 1			Side Stick			Side Stick Analog	Side Stick Analog
F2	F#2	50	D 2	38	D 1			Snare	Snare Rock	Snare Noisy 2	Snare Analog	Snare Clap
G2	G#2	51	D# 2	39	D# 1			Hand Clap				Dance Clap
A2	A#2	52	E 2	40	E 1			Snare Tight	Snare Rock Rim	Snare Noisy 3	Snare Analog 2	Snare Dry
B2	B#2	53	F 2	41	F 1			Floor Tom L	Tom Rock 1	Tom Electro 1	Tom Analog 1	Tom Analog 1
C3	C#3	54	F# 2	42	F# 1		1	Hi-Hat Closed			Hi-Hat Closed Analog	Hi-Hat Closed Analog3
D3	D#3	55	G 2	43	G 1			Floor Tom H	Tom Rock 2	Tom Electro 2	Tom Analog 2	Tom Analog 2
E3	E#3	56	G# 2	44	G# 1		1	Hi-Hat Pedal			Hi-Hat Closed Analog 2	Hi-Hat Closed Analog 4
F3	F#3	57	A 2	45	A 1			Low Tom	Tom Rock 3	Tom Electro 3	Tom Analog 3	Tom Analog 3
G3	G#3	58	A# 2	46	A# 1		1	Hi-Hat Open			Hi-Hat Open Analog	Hi-Hat Open Analog 2
A3	A#3	59	B 2	47	B 1			Mid Tom L	Tom Rock 4	Tom Electro 4	Tom Analog 4	Tom Analog 4
B3	B#3	60	C 3	48	C 2			Mid Tom H	Tom Rock 5	Tom Electro 5	Tom Analog 5	Tom Analog 5
C4	C#4	61	C# 3	49	C# 2			Crash Cymbal 1			Crash Analog	Crash Analog
D4	D#4	62	D 3	50	D 2			High Tom	Tom Rock 6	Tom Electro 6	Tom Analog 6	Tom Analog 6
E4	E#4	63	D# 3	51	D# 2			Ride Cymbal 1				
F4	F#4	64	E 3	52	E 2			Chinese Cymbal				
G4	G#4	65	F 3	53	F 2			Ride Cymbal Cup				
A4	A#4	66	F# 3	54	F# 2			Tambourine				Tambourine Analog
B4	B#4	67	G 3	55	G 2			Splash Cymbal				
C5	C#5	68	G# 3	56	G# 2			Cowbell			Cowbell Analog	Cowbell Analog
D5	D#5	69	A 3	57	A 2			Crash Cymbal 2				
E5	E#5	70	A# 3	58	A# 2			Vibraslap				Vibraslap Analog
F5	F#5	71	B 3	59	B 2			Ride Cymbal 2				
G5	G#5	72	C 4	60	C 3			Bongo H				Bongo Analog H
A5	A#5	73	C# 4	61	C# 3			Bongo L				Bongo Analog L
B5	B#5	74	D 4	62	D 3			Conga H Mute			Conga Analog H	Conga Analog H
C6	C#6	75	D# 4	63	D# 3			Conga H Open			Conga Analog M	Conga Analog M
		76	E 4	64	E 3			Conga L			Conga Analog L	Conga Analog L
		77	F 4	65	F 3			Timbale H				
		78	F# 4	66	F# 3			Timbale L				
		79	G 4	67	G 3			Agogo H				
		80	G# 4	68	G# 3			Agogo L				
		81	A 4	69	A 3			Cabasa				
		82	A# 4	70	A# 3			Maracas			Maracas 2	Maracas 2
		83	B 4	71	B 3	O		Samba While H				
		84	C 5	72	C 4	O		Samba While L				
		85	C# 5	73	C# 4			Guiro Short				
		86	D 5	74	D 4	O		Guiro Long				
		87	D# 5	75	D# 4			Claves			Claves 2	Claves 2
		88	E 5	76	E 4			Wood Block H				Dance Percussion 3
		89	F 5	77	F 4			Wood Block L				Dance Percussion 4
		90	F# 5	78	F# 4			Cuica Mute	Scratch H 2		Scratch H 2	Dance Breath 1
		91	G 5	79	G 4			Cuica Open	Scratch L 2		Scratch L 3	Dance Breath 2
		92	G# 5	80	G# 4		2	Triangle Mute				
		93	A 5	81	A 4		2	Triangle Open				
		94	A# 5	82	A# 4			Shaker				
		95	B 5	83	B 4			Jingle Bells				
		96	C 6	84	C 5			Bell Tree				
		97	C# 6	85	C# 5							
		98	D 6	86	D 5							
		99	D# 6	87	D# 5							
		100	E 6	88	E 5							
		101	F 6	89	F 5							
		102	F# 6	90	F# 5							
		103	G 6	91	G 5							

Drum Kit List

		Voice No.				1	11	12	13	14			
		MSB (0-127) / LSB (0-127) / PC (1-128)				127/000/001	127/000/049	126/000/41	126/000/44	126/000/36			
		Keyboard		MIDI		Key Off	Alternate Group	Standard Kit 1	Symphony Kit	CubanKit	PopLatinKit	Alternate Group	ArabicKit
		Note#	Note	Note#	Note								
		25	C# 0	13	C# -1		3	Surdo Mute					
		26	D 0	14	D -1		3	Surdo Open					
		27	D# 0	15	D# -1			Hi Q					
		28	E 0	16	E -1			Whip Slap					
		29	F 0	17	F -1		4	Scratch H					
		30	F# 0	18	F# -1		4	Scratch L					
		31	G 0	19	G -1			Finger Snap			Hand Clap		
		32	G# 0	20	G# -1			Click Noise					
		33	A 0	21	A -1			Metronome Click					
		34	A# 0	22	A# -1			Metronome Bell					
		35	B 0	23	B -1			Seq Click L		Conga H Tip	Conga H Tip		
		36	C 1	24	C 0			Seq Click H		Conga H Heel	Conga H Heel		
C1	C#1	37	C# 1	25	C# 0			Brush Tap		Conga H Open	Conga H Open		Nakarazan Dom
D1	D#1	38	D 1	26	D 0	O		Brush Swirl		Conga H Mute	Conga H Mute		Cabasa
E1	E#1	39	D# 1	27	D# 0			Brush Slap		Conga H Slap Open	Conga H Slap Open		Nakarazan Edge
F1	F#1	40	E 1	28	E 0	O		Brush Tap Swirl		Conga H Slap	Conga H Slap		Hager Dom
G1	G#1	41	F 1	29	F 0	O		Snare Roll		Conga H Slap Mute	Conga H Slap Mute		Hager Edge
A1	A#1	42	F# 1	30	F# 0			Caanet		Conga L Tip	Conga L Tip		Bongo H
B1	B#1	43	G 1	31	G 0			Snare Soft		Conga L Heel	Conga L Heel		Bongo L
C2	C#2	44	G# 1	32	G# 0			Sticks		Conga L Open	Conga L Open		Conga H Mute
D2	D#2	45	A 1	33	A 0			Kick Soft	Kick Soft 2	Conga L Mute	Conga L Mute		Conga H Open
E2	E#2	46	A# 1	34	A# 0			Open Rim Shot		Conga L Slap Open	Conga L Slap Open		Conga L
F2	F#2	47	B 1	35	B 0			Kick Tight	Gran Cassa	Conga L Slap	Conga L Slap		Zagrouda H
G2	G#2	48	C 2	36	C 1			Kick	Gran Cassa Mute	Conga L Slide	Conga L Slide		Zagrouda L
A2	A#2	49	C# 2	37	C# 1			Side Stick		Bongo H Open 1 finger	Bongo H Open 1 finger		Kick Soft
B2	B#2	50	D 2	38	D 1			Snare		Bongo H Open 3 finger	Bongo H Open 3 finger		
C3	C#3	51	D# 2	39	D# 1			Hand Clap	Band Snare	Bongo H Rim	Bongo H Rim		Snare Soft
D3	D#3	52	E 2	40	E 1			Snare Tight	Band Snare 2	Bongo H Tip	Bongo H Tip		Arabic Hand Clap
E3	E#3	53	F 2	41	F 1			Floor Tom L	Tom Jazz 1	Bongo H Heel	Bongo H Heel		Snare
F3	F#3	54	F# 2	42	F# 1	1		Hi-Hat Closed		Bongo H Slap	Bongo H Slap		
G3	G#3	55	G 2	43	G 1			Floor Tom H	Tom Jazz 2	Bongo L Open 1 finger	Bongo L Open 1 finger		
A3	A#3	56	G# 2	44	G# 1	1		Hi-Hat Pedal		Bongo L Open 3 finger	Bongo L Open 3 finger		
B3	B#3	57	A 2	45	A 1			Low Tom	Tom Jazz 3	Bongo L Rim	Bongo L Rim		
C4	C#4	58	A# 2	46	A# 1	1		Hi-Hat Open		Bongo L Tip	Bongo L Tip		
D4	D#4	59	B 2	47	B 1			Mid Tom L	Tom Jazz 4	Bongo L Heel	Bongo L Heel		
E4	E#4	60	C 3	48	C 2			Mid Tom H	Tom Jazz 5	Bongo L Slap	Bongo L Slap		
F4	F#4	61	C# 3	49	C# 2			Crash Cymbal 1	Hand Cymbal	Timbale L Open	Timbale L Open		
G4	G#4	62	D 3	50	D 2			High Tom	Tom Jazz 6				
A4	A#4	63	D# 3	51	D# 2			Ride Cymbal 1	Hand Cymbal Short				
B4	B#4	64	E 3	52	E 2			Chinese Cymbal					Crash Cymbal 2
C5	C#5	65	F 3	53	F 2			Ride Cymbal Cup		Paila L	Paila L		Duhulla Dom
D5	D#5	66	F# 3	54	F# 2			Tambourine		Timbale H Open	Timbale H Open		
E5	E#5	67	G 3	55	G 2			Splash Cymbal					Duhulla Tak
F5	F#5	68	G# 3	56	G# 2			Cowbell					
G5	G#5	69	A 3	57	A 2			Crash Cymbal 2	Hand Cymbal 2				Duhulla Sak
A5	A#5	70	A# 3	58	A# 2			Vibraslap					Claves
B5	B#5	71	B 3	59	B 2			Ride Cymbal 2	Hand Cymbal 2 Short	Paila H	Paila H		Doff Dom
C6	C#6	72	C 4	60	C 3			Bongo H		Cowbell Top	Cowbell Top		Katem Dom
D6	D#6	73	C# 4	61	C# 3			Bongo L					Katem Tak
E6	E#6	74	D 4	62	D 3			Conga H Mute					Katem Sak
F6	F#6	75	D# 4	63	D# 3			Conga H Open					Katem Tak
G6	G#6	76	E 4	64	E 3			Conga L		Guiro Short	Guiro Short		Doff Tak
A6	A#6	77	F 4	65	F 3			Timbale H		Guiro Long	Guiro Long		Tabla Dom
B6	B#6	78	F# 4	66	F# 3			Timbale L					Tabla Tak1
C7	C#7	79	G 4	67	G 3			Agogo H					Tabla Tik
D7	D#7	80	G# 4	68	G# 3			Agogo L					Tabla Tak2
E7	E#7	81	A 4	69	A 3			Cabasa		Tambourine	Tambourine		Tabla Sak
F7	F#7	82	A# 4	70	A# 3			Maracas					Tabla Roll of Edge
G7	G#7	83	B 4	71	B 3	O		Samba While H					Tabla Flam
A7	A#7	84	C 5	72	C 4	O		Samba While L		Maracas	Maracas		Sagat 1
B7	B#7	85	C# 5	73	C# 4			Guiro Short		Shaker	Shaker		Tabel Dom
C8	C#8	86	D 5	74	D 4	O		Guiro Long		Cabasa	Cabasa		Sagat 3
D8	D#8	87	D# 5	75	D# 4			Claves			Cuica Mute		Tabel Tak
E8	E#8	88	E 5	76	E 4			Wood Block H			Cuica Open		Sagat 2
F8	F#8	89	F 5	77	F 4			Wood Block L					Rik Dom
G8	G#8	90	F# 5	78	F# 4			Cuica Mute					Rik Tak 2
A8	A#8	91	G 5	79	G 4			Cuica Open					Rik Finger 1
B8	B#8	92	G# 5	80	G# 4		2	Triangle Mute					Rik Tak 1
C9	C#9	93	A 5	81	A 4		2	Triangle Open			Triangle Mute	1	Rik Finger 2
D9	D#9	94	A# 5	82	A# 4			Shaker			Triangle Open	1	Rik Brass Tremolo
E9	E#9	95	B 5	83	B 4			Jingle Bells					Rik Sak
F9	F#9	96	C 6	84	C 5			Bell Tree			Bell Tree		Rik Tik
G9	G#9	97	C# 6	85	C# 5								
A9	A#9	98	D 6	86	D 5								
B9	B#9	99	D# 6	87	D# 5								
C10	C#10	100	E 6	88	E 5								
D10	D#10	101	F 6	89	F 5								
E10	E#10	102	F# 6	90	F# 5								
F10	F#10	103	G 6	91	G 5								

		Voice No.				1		15		16		17					
		MSB (0-127) / LSB (0-127) / PC (1-128)				127/000/001		126/000/037		126/000/065		126/000/115					
		Keyboard		MIDI		Key Off	Alternate Group	Standard Kit 1		Arabic Kit 2		Arabic Mix Kit		Alternate Group	Indian Kit		Alternate Group
		Note#	Note	Note#	Note			Standard Kit 1	Arabic Kit 2	Arabic Mix Kit	Indian Kit						
		25	C# 0	13	C# -1		3	Surdo Mute	Zarb Back mf	Conga Analog H							
		26	D 0	14	D -1		3	Surdo Open	Zarb Tom f	Conga Analog M					Indian Hand Clap		
		27	D# 0	15	D# -1			Hi Q	Zarb Eshareh	Conga Analog L					Daffi Open		
		28	E 0	16	E -1			Whip Slap	Zarb Whipping	Vibraslap					Daffi Slap	1	
		29	F 0	17	F -1		4	Scratch H	Tombak Tom f	Kick Techno L					Daffi Rim	1	
		30	F# 0	18	F# -1		4	Scratch L	Neghareh Tom f	Side Stick Arabic Mix					Duff Open		
		31	G 0	19	G -1			Finger Snap	Tombak Back f	Snare Techno					Duff Slap		
		32	G# 0	20	G# -1			Click Noise	Neghareh Back f	Guero Long					Duff Rim		
		33	A 0	21	A -1			Metronome Click	Tombak Snap f	Kick Techno Q					Hatheli Long	2	
		34	A# 0	22	A# -1			Metronome Bell	Neghareh Pelang f	Open Rim Shot					Hatheli Short	2	
		35	B 0	23	B -1			Seq Click L	Tombak Trill	Funk Snare 2					Baya ge	3	
		36	C 1	24	C 0			Seq Click H	Khaligi Clap 1	Kick Arabic Mix					Baya ke	3	
C1	C#1	37	C# 1	25	C# 0			Brush Tap	Arabic Zalgouta Open	Funk Snare 1				Baya ghe	3		
D1	D#1	38	D 1	26	D 0	O		Brush Swirl	Khaligi Clap 2	Snare Arabic Mix					Baya ka	3	
E1		39	D# 1	27	D# 0	O		Brush Slap	Arabic Zalgouta Close	Hand Clap					Tabla na	4	
F1	F#1	40	E 1	28	E 0	O		Brush Tap Swirl	Arabic Hand Clap	Snare					Tabla tin	4	
G1	G#1	41	F 1	29	F 0	O		Snare Roll	Tabel Tak 1	Tom Electro 1					Tabla baya dha	3	
		42	F# 1	30	F# 0			Caanet	Sagat 1	Hi-Hat Closed Arabic Mix	1				Dhol 1 Open		
		43	G 1	31	G 0			Snare Soft	Tabel Dom	Tom Electro 2					Dhol 1 Slap	5	
A1	A#1	44	G# 1	32	G# 0			Sticks	Sagat 2	Hi-Hat Half Arabic Mix	1				Dhol 1 Mute	5	
		45	A 1	33	A 0			Kick Soft	Tabel Tak 2	Tom Electro 3					Dhol 1 Open Slap	5	
B1		46	A# 1	34	A# 0			Open Rim Shot	Sagat 3	Hi-Hat Open Arabic Mix	1				Dhol 1 Roll		
C2	C#2	47	B 1	35	B 0			Kick Tight	Riq Tik 3	Tom Electro 4					Dandia Short	6	
		48	C 2	36	C 1			Kick	Riq Tik 2	Tom Electro 5					Dandia Long	6	
D2	D#2	49	C# 2	37	C# 1			Side Stick	Riq Tik Hard 1	Crash Cymbal 1					Chutki		
E2		50	D 2	38	D 1			Snare	Riq Tik 1	Tom Electro 6					Chipri		
F2	F#2	51	D# 2	39	D# 1			Hand Clap	Riq Tik Hard 2	Hi-Hat Open 3	1				Khanjira Open		
G2	G#2	52	E 2	40	E 1			Snare Tight	Riq Tik Hard 3	Reverse Cymbal					Khanjira Slap		
A2	A#2	53	F 2	41	F 1			Floor Tom L	Riq Tish	Timbale L					Khanjira Mute		
		54	F# 2	42	F# 1	1		Hi-Hat Closed	Riq Snouj 2	Conga H Open					Khanjira Bendup		
B2		55	G 2	43	G 1			Floor Tom H	Riq Roll	Timbale H					Khanjira Benddown		
C3	C#3	56	G# 2	44	G# 1	1		Hi-Hat Pedal	Riq Snouj 1	Conga H Mute					Dholak 1 Open		
D3	D#3	57	A 2	45	A 1			Low Tom	Riq Sak	Tambourine					Dholak 1 Mute	7	
E3		58	A# 2	46	A# 1	1		Hi-Hat Open	Riq Snouj 3	Conga L					Dholak 1 Slap	7	
F3	F#3	59	B 2	47	B 1			Mid Tom L	Riq Snouj 4	Cowbell					Dhol 2 Open		
G3	G#3	60	C 3	48	C 2			Mid Tom H	Riq Tak 1	Claves					Dhol 2 Slap	8	
A3	A#3	61	C# 3	49	C# 2			Crash Cymbal 1	Riq Brass 1	Bongo H					Dhol 2 Rim	8	
B3		62	D 3	50	D 2			High Tom	Riq Tak 2	Wood Block H					Mridangam na	9	
C4	C#4	63	D# 3	51	D# 2			Ride Cymbal 1	Riq Brass 2	Bongo L					Mridangam din	9	
D4	D#4	64	E 3	52	E 2			Chinese Cymbal	Riq Dom	Wood Block L					Mridangam ki	9	
E4		65	F 3	53	F 2			Ride Cymbal Cup	Katem Tak Doff	Kurdish Dohol Low f					Mridangam ta	9	
F4	F#4	66	F# 3	54	F# 2			Tambourine	Katem Dom	Cabasa					Mridangam Chapu	9	
G4	G#4	67	G 3	55	G 2			Splash Cymbal	Katem Sak 1	Kurdish Dohol High f					Mridangam Lo Closed	10	
A4	A#4	68	G# 3	56	G# 2			Cowbell	Katem Tak 1	Shaker					Mridangam Lo Open	10	
B4		69	A 3	57	A 2			Crash Cymbal 2	Katem Sak 2	Snap 1					Chimta Normal	11	
C5	C#5	70	A# 3	58	A# 2			Vibraslap	Katem Tak 2	Maracas					Chimta Ring	11	
D5	D#5	71	B 3	59	B 2			Ride Cymbal 2	Daholla Sak 2	Snap 2					Dholki Hi Open	12	
E5		72	C 4	60	C 3			Bongo H	Daholla Sak 1	Khaligi Twaisat 3	3				Dholki Hi Mute	12	
F5	F#5	73	C# 4	61	C# 3			Bongo L	Daholla Tak 1	Khaligi Twaisat 1	3				Dholki Lo Open	13	
G5	G#5	74	D 4	62	D 3			Conga H Mute	Daholla Dom	Khaligi Twaisat 2	3				Dholki Hi Slap	12	
A5	A#5	75	D# 4	63	D# 3			Conga H Open	Daholla Tak 2	Khaligi Twaisat 5 Open	3				Dholki Lo Slide	13	
B5		76	E 4	64	E 3			Conga L	Tablah Prok	Khaligi Twaisat 4 Open	3				Khol Open	14	
C6		77	F 4	65	F 3			Timbale H	Tablah Dom 2	Khaligi Tablah Small Dom	2				Khol slide		
D6		78	F# 4	66	F# 3			Timbale L	Tablah Roll of Edge	Khaligi Tar Barashim Group Dom					Khol Mute	14	
E6		79	G 4	67	G 3			Agogo H	Tablah Tak Finger 4	Khaligi Tablah Small Snap					Manjira Open	15	
F6		80	G# 4	68	G# 3			Agogo L	Tablah Tak Trill 1	Khaligi Tar Barashim Group Sak					Manjira Close	15	
G6		81	A 4	69	A 3			Cabasa	Tablah Tak Finger 3	Khaligi Tablah Small Sak	2				Jhanji Open	16	
A6		82	A# 4	70	A# 3			Maracas	Tablah Tak Trill 2	Khaligi Tar Barashim Group Tak					Jhanji Close	16	
B6		83	B 4	71	B 3	O		Samba While H	Tablah Tak Finger 2	Khaligi Tablah Small Tik	2				Mondira Open	17	
C7		84	C 5	72	C 4	O		Samba While L	Tablah Tak Finger 1	Khaligi Tablah Big Dom 1					Mondira Close	17	
D7		85	C# 5	73	C# 4			Guero Short	Tablah Tik 2	Khaligi Tar Segal Dom					Indian Bhangra Scat 1		
E7		86	D 5	74	D 4	O		Guero Long	Tablah Tik 4	Khaligi Tablah Big Tak 1					Indian Bhangra Scat 2		
F7		87	D# 5	75	D# 4			Claves	Tablah Tik 3	Khaligi Tar Segal Tak					Indian Bhangra Scat 3		
G7		88	E 5	76	E 4			Wood Block H	Tablah Tik 1	Khaligi Tablah Big Sak 1					Indian Bhangra Scat 4		
A7		89	F 5	77	F 4			Wood Block L	Tablah Tak 3	Tablah Dom 1					Khomokh Normal		
B7		90	F# 5	78	F# 4			Cuica Mute	Tablah Tak 1	Tablah Tak 1					Khomokh Mute		
C8		91	G 5	79	G 4			Cuica Open	Tablah Tak 4	Tablah Tremolo					Khomokh mlttak		
D8		92	G# 5	80	G# 4		2	Triangle Mute	Tablah Tak 2	Tablah Tak 2					Thavil Open		
E8		93	A 5	81	A 4		2	Triangle Open	Tablah Sak 2	Tablah Tik 1					Thavil Slap		
F8		94	A# 5	82	A# 4			Shaker	Tablah Tremolo	Tablah Sak 1					Thavil Mute		
G8		95	B 5	83	B 4			Jingle Bells	Tablah Sak 1	Tablah Tik 3					Khartaal		
A8		96	C 6	84	C 5			Bell Tree	Tablah Dom 1	Tablah Tik 2					Dholak 2 Open	18	
B8		97	C# 6	85	C# 5										Dholak 2 Slide	18	
C9		98	D 6	86	D 5										Dholak 2 Rim 1		
D9		99	D# 6	87	D# 5										Dholak 2 Rim 2		
E9		100	E 6	88	E 5										Dholak 2 Ring		
F9		101	F 6	89	F 5										Dholak 2 Slap		
G9		102	F# 6	90	F# 5										G Dholak Body		
A9		103	G 6	91	G 5												



Style List

Style No.	Style No. (Category)	Style Name
Pop&Rock		
1	1	FunkPopRock
2	2	AcousticRock
3	3	Cool8Beat
4	4	60'sRock1
5	5	60'sRock2
6	6	VintageGtrPop
7	7	60'sGuitarPop
8	8	70's8Beat
9	9	90'sGuitarPop
10	10	KoolShuffle
11	11	BubblegumPop
12	12	BritPopSwing
13	13	JazzPop
14	14	HardRock
15	15	RootRock
16	16	RockShuffle
17	17	Unplugged
Ballad		
18	1	8BeatAdria
19	2	OrganBallad
20	3	PianoBallad
21	4	8BeatBallad
22	5	EPBallad
23	6	6-8Modern
24	7	Chillout1
25	8	NewR&BBallad
26	9	16BeatBallad
27	10	PowerBallad
28	11	EasyBallad
Dance		
29	1	ModChartPop
30	2	RetroClub
31	3	USChartHit
32	4	ClubBeat
33	5	Electronica
34	6	FunkyHouse
35	7	ChartR&B
36	8	MellowHipHop
37	9	SoulR&B
38	10	Chillout2
39	11	Ibiza
40	12	TechnoParty
41	13	DiscoHouse
42	14	DiscoPhilly
43	15	70'sDisco
44	16	80'sDisco
45	17	DreamDance
46	18	House
47	19	FrenchHouse
48	20	Garage
49	21	ClassicHipHop
50	22	NewHipHop
51	23	HipHopGroove
52	24	LatinDJ's
Swing&Jazz		
53	1	OrchBigBand
54	2	OrchestraSwing1
55	3	OrchestraSwing2
56	4	BigBandFast
57	5	BigBandShuffle
58	6	MidnightSwing
59	7	JumpJive

Style No.	Style No. (Category)	Style Name
60	8	OrganGroove
61	9	JazzClub
62	10	Five-Four
63	11	JazzWaltzFast
64	12	Dixieland
65	13	Ragtime
66	14	Charleston
R&B		
67	1	BluesRock
68	2	BluesBallad
69	3	Soul
70	4	FranklySoul
71	5	6-8Soul
72	6	SoulBrothers
73	7	OldiesR&R
74	8	60'sRock&Roll
75	9	Rock&Roll
76	10	Twist
77	11	GospelSisters
78	12	WorshipMed
79	13	DetroitPop
80	14	ModernR&B
81	15	ComboBoogie
Country		
82	1	NewCountry
83	2	CountryHits
84	3	CountryBallad
85	4	CountryPop
86	5	CountryShuffle
87	6	Country2-4
88	7	FingerPickin
89	8	Bluegrass
90	9	Hoedown
91	10	CountryWaltz
Latin		
92	1	BrazilianSamba
93	2	BossaNova
94	3	FastBossa
95	4	Pop Bossa
96	5	Forro
97	6	Beguine
98	7	Mambo
99	8	Salsa
100	9	Calypso
101	10	Merengue
102	11	Bachata
103	12	CubanSon
104	13	Rumbalsland
105	14	RumbaFlamenca
106	15	HappyReggae
107	16	LatinDisco
108	17	Joropo
109	18	Parranda
110	19	Reggaeton
Ballroom		
111	1	VienneseWaltz
112	2	EnglishWaltz
113	3	Slowfox
114	4	Foxtrot
115	5	Quickstep
116	6	Tango
117	7	Swingfox
118	8	Pasodoble

Style No.	Style No. (Category)	Style Name
119	9	Samba
120	10	ChaChaCha
121	11	Rumba
122	12	Jive
123	13	OrganSwing
124	14	OrganSamba
125	15	OrganQuickstep
126	16	9-8Waltz
127	17	TraditionalWaltz
Movie&Show		
128	1	70'sTVTheme
129	2	Sci-fiMarch
130	3	WildWest
131	4	SaturdayNight
132	5	Showtune
133	6	Moonlight6-8
134	7	ClassicPianoBld
135	8	BaroqueAir
136	9	OrchestralBolero
137	10	OrchestralMarch
138	11	ChristmasSwing
139	12	ChristmasWaltz
Entertainer		
140	1	DiscoFox
141	2	DiscoHands
142	3	AlpBallad
143	4	ScandSlowRock
144	5	ScandShuffle
145	6	70'sFrenchHit
146	7	SchlagerPop
147	8	SchlagerBeat
148	9	SchlagerPolka
149	10	PolkaPop
150	11	Tijuana
151	12	Carnival
152	13	PubPiano
World		
153	1	IrishDance
154	2	SpanishPaso
155	3	FrenchMusette
156	4	Sirtaki
157	5	PopFlamenco
158	6	Reel
159	7	Jig
160	8	Tarantella
161	9	OberPolka
162	10	OberWaltzer
163	11	GermanMarch
164	12	USMarch
165	13	6-8March
166	14	Duranguense
167	15	CumbiaGrupera
168	16	Saeidy
169	17	WehdaSaghira
170	18	Laff
171	19	ArabicEuro
172	20	OrientalPop
173	21	Bhajan
174	22	Bhangra
175	23	Xi Qing Luo Gu
176	24	Jing Ju Jie Zou



Music Database List

No.	MDB Name
All Time Hits	
1	A Bridge To Cross Troubled Water
2	All Of My Loving
3	All OK Now
4	A Song For New England
5	Blowing In The Folk
6	Boots For Walking
7	Call Me When You Rock
8	Don't Be Bad To Me
9	Get Back To Where You Belong
10	Guitar Wheels
11	Heaven? Nobody Gets Too Much
12	I Was Born Smiling
13	I Watch My Tears Go By
14	Leave Me Tender, Love Me True
15	Let Me Hold Your Hand
16	Letters Of Love
17	Living In A Colored Submarine
18	Love? Don't Throw It Away
19	Makin' It Thru The Night
20	Mrs. Robin's Son
21	My Heart Is Very Simple
22	My Lover's A Dream
23	My Shell Swing
24	Party? Oh, Blah Di!
25	Please Do Love Me In Liverpool
26	Riding Ticket
27	These Ones Are Young
28	This Game Makes You Cry
29	This Night Has Been A Hard Day!
30	Till The Moon Deserts The Sky
31	Woods Of Norway
32	You're Just OK!
33	You're So Young At Heart
Modern Pop	
34	A Cosy Life In Italy
35	All Get Up
36	Angles of Charlie
37	A Sunshine Walk
38	Bossa Woman
39	Cross The Mersey By Ferry
40	Dream Of A Lover
41	Everything's Changed
42	I'm Torn
43	It Is Always Raining On Me
44	It's Only Words
45	It's Simply Love
46	Life Groove
47	Life's Walk
48	Love Goes This Way
49	Not Full Time Love
50	Our Current Love
51	Rollercoaster Through Life
52	Seriously Dippy
53	She's One For Me
54	Shining Light For Love
55	Sorry May Be Hard To Say
56	Stars To Reach For
57	Sure Of That?
58	Swinging Sultan
59	Tell Her Your Feelings
60	The Girl Belongs To Me
61	This Affair's In The Family
62	This Thing's Called Love
63	Time Riding
64	What's Taken So Long?
65	You Only Need Love
Sing Alongs	
66	Danny's Boy
67	Dear, My Clementine
68	Deep In Texas's Heart
69	Ease Up Mother Brown

No.	MDB Name
70	Espana Viva
71	Good Night For The Ladies
72	Here Are Happy Days Again
73	High Old Silver Lining
74	My Dad's A Dustman
75	My Man Is Old
76	My Sunshine Is You
77	Old Smokey
78	Smiling Irish Eyes
79	Song For Susanna
80	Song Of The Sideboard
81	This Iron Is Old!
82	Tipperary's A Long Way
Easy Listening	
83	Balloon Bossa
84	I'm Gonna Leave Durham
85	La Mer Is Swinging
86	Making It Through The Rain
87	Morning's New World
88	Mother!
89	Portugal In April
90	Raindrops On My Head
91	The Wind And Me
92	This Is Something Silly!
93	Whistling A Last Goodbye
Pop Classics	
94	All On My Own
95	Are You Standing Still?
96	Boxing Song
97	Broken Heart
98	Complete Eclipse
99	Don't Break My Heart Beat
100	Drifting On Broadway
101	Easier To Say It Than Do It
102	Girl Belonging To Bobby
103	Girl With Brown Eyes
104	Give Thanks For Music
105	Heartache Beat
106	Holiday In Summer Season
107	I'm Your Venus
108	It's Really Not Usual In Wales
109	John B's Sloop
110	Lane Of Pennies
111	Loves You She Does
112	My Religion Is Misaid
113	Paradise Can't Be As Nice
114	Portatone Man?
115	Raindrop Walk
116	Rocking My Life
117	Sally's Got A Mustang
118	Shape Me And Bend Me
119	Sky Spirits
120	Somebody Needs Someone Else
121	Spin The Wheel
122	Suzie Wake Up
123	Sweden Takes A Chance
124	Sweet Lord Song
125	This Afternoon's Sunny
126	This Day's Just Perfect
127	This Is My Party
128	To Love Some Reggae
129	Tulsa Is 24 Hours Away
130	We Are Together And Happy
131	With My Friends To Help Me
132	You Can Help Yourself
Pop Ballads	
133	Don't Let The Sun Set For Me
134	Heavenly Creatures With Halo
135	It's Crazy How I Miss You
136	Missing You Like Crazy
137	No Matter What The Boys Do Tell
138	What Is One More Year?

No.	MDB Name
139	Where Are You Going To?
Ballad	
140	At Once Ballad
141	Ballad For A Hero
142	Ballad For A Woman
143	Candle On The Piano
144	Don't Leave Me Now
145	Do You Know Me Yet
146	Eyes Of Blue
147	Friends Are For Singing
148	Hard To Say Sorry
149	Hello, Do You Hear Me Playing?
150	I Can't Live Without You
151	I Will Be There For You
152	I'll Make Soul With You
153	I Love You In French
154	I'm Saving It All For You!
155	I Will Fly Away One Day
156	London Streets
157	Love's Glory
158	Love's Vision
159	Nothing Will Change My Love
160	One Time When We Touch
161	San Francisco Heart
162	Soft Songs Are Killing Me!
163	Take It Back For Good
164	The World Is What We Are
165	Up? It's Where We Belong
166	You Are Inspiring
167	You Lift My Wings
168	Your True Color
Rock	
169	69 Summers Long
170	Alabama's Sweet Home
171	Born To Be Mild
172	Can't Get Satisfied
173	Can We Stick Together
174	Dave On The Road
175	Don't Think About Tomorrow
176	Dusting The Wind
177	Go For A Spin
178	Is The Heat On?
179	I Want You To Want Rock
180	Jumping Rock
181	Just Give Me Love And Rock
182	Last Countdown
183	Nobody Else Is A Champion
184	This Woman Plays Honky Tonk
185	Tiger's Eye
186	Velvet Is Black
187	Wanting To Break Free
188	Whatever You Rock
189	Your Kindness Is Magic
Rock&Roll	
190	All Shaken Up
191	Beethoven's Rocking
192	Crazy Little Love Thing
193	Don't Hurry Love
194	Good Looking Charm
195	Good Molly, Miss Golly
196	Great Fire Balls
197	I'm A Wanderer
198	I Won't Be Cruel
199	Julie Does The Twist
200	Let's Play The Twist
201	Let's Sue Peggy
202	Particularly No Place To Go
203	Rock & Roll Jail
204	Rocking Blue Shoes
205	Rocking For 24 Hours
206	Shouting Twist
207	Teddy Is A Bear

No.	MDB Name
208	The Music Is Rock&Roll
209	What A Day That Will Be
210	You Got Me Going, Really!
Oldies	
211	All I Need Is The Air
212	Are You Sorry Now?
213	Breaking Up Isn't Easy To Do
214	Diana's Twist
215	Final Waltz
216	Girl From Uptown
217	Going Down Town
218	Golden Silence
219	Guitar For An Apache
220	Have I Got It?
221	Heaven Has Three Steps
222	He Kissed Crystal!
223	Hey, Let's Rock Tonight!
224	I'm A Pola!
225	Magic Puff
226	Marina's Song
227	Mend A Chino
228	Motion Of Poetry
229	My Pillow Has Tears On
230	Pete Retite
231	Please Be Mine, Baby
232	Star Of Movie
233	Teenie Bikini
234	The Ghetto Is In Me
235	The Lovin' Feeling Has Gone
236	These Lips Are Lucky
237	This Doll's Alive!
238	This Land Is Wonderful!
239	This Woman's Pretty!
240	Tomorrow Will You Love Me
241	Tonight Do You Feel Lonesome
242	Twisting Again
243	Walking Right Back
244	We Don't Want Milk Today
245	Words Aren't Easy
246	You & You Alone
Organist	
247	Bamba Party
248	Cat Groove
249	El Ranchero
250	Face Of A Child
251	Form
252	Guagli On Organ
253	Guide Me To My Home
254	It's Dolly, Say Hello!
255	Nowhere It Came Out Of
256	Ribbon Of Yellow
257	Samba Cavaquinho
258	Samba Delicado
259	Side By Side In The Barn
260	Steam Train Samba
261	Tico Samba
262	Two Times Yeh!
263	Whispering Organ
264	White And Pale
Dance Floor	
265	Adagio From Ibiza
266	Baa Bee Girl
267	Baby I Love Loving You
268	Buy Me Bailame, Please
269	Catch 22
270	Children In Trance?
271	Girl
272	High In The Sky
273	It's So Horny
274	Janeiro Samba
275	Life Is High
276	London, R U Prepared?

No.	MDB Name
277	Love First Time I Saw You
278	My Eyes Can't Take Off!
279	No Dinero, No Tengo
280	Once More
281	Rose From The Desert
282	She Believes In Life After Love
283	Tambor DJ
284	This Song Is Something!
285	Up Is The Way To Move
Disco	
286	A Day's Difference
287	Babylon Rivers
288	Born Alive Disco
289	Brown Girl At The Disco
290	Cool Daddy Disco
291	Dee Eye Ess See Oh!
292	Disco Hustle
293	Don't Misunderstand Me
294	Do You Love To Love?
295	Fever At Night
296	Go Where The Music Takes You
297	I Love That Boat!
298	It Really Is A Funky Town
299	I've Never Known Love Likelt
300	Keepin' Alive
301	Khan Disco
302	Local New Yorker
303	Make My Fire Burn Again
304	Mother Is Baking
305	Never Give Up On You
306	Philadelphia Sound
307	Russia's Mad Priest
308	Searching For Freedom
309	Swedish Queen
310	Theme Of Love
311	Train Of Love
312	Wear It Out? Or Use It Up?
313	Why Am See A?
314	You're Everything For Me
Swing	
315	Big Kiss For Dream Building
316	Blue Roses For The Lady
317	Call The Whole Thing Off
318	Charles On
319	Get Out Of Bed
320	Goodbye To Blues Swing
321	High Hope Swing
322	Joy I Love Her So
323	Just Chickens Here!
324	My Shadow And Me
325	Not Forgettable
326	Not Misbehaving
327	Out Of Your Kick
328	Rag Band Time For Alex?
329	Ragtime Tiger
330	Safari Swing
331	Smiling Swing
332	Steam Train Boogie
333	Swing Yourself Up
334	Tap Dancing Bo
335	Thank You In Germany
336	The Importance Of Roses
337	The Sandman Gives Me A Dream
338	Two Foot Five
339	Yes Sir, My Baby Can Swing
340	You're My Coffee's Cream
Jazz	
341	I Have All That Rhythm
342	My Home Is Pasadena
343	Not Decided
344	That Indigo Feeling
345	These Winners Are Easy

No.	MDB Name
346	Wild Cat Dixie
BigBand	
347	Big Band Patrol
348	If Only I Could Chime
349	Jiving Wailing And Jumping
350	Leroy Is Bad. Very Bad
351	L Is For The Way You Look At Me
352	Please Fly And Swing With Me
353	So What Is Not Old?
354	Tasty Honey
355	This Lady? She's A Tramp
356	Wintry Wind Blowing
R&B/Gospel	
357	Admire
358	As Played On Portatone
359	Baby Groove
360	Boys At The End Of The Road
361	Don't Change Your Mind Baby
362	Don't Get Excited!
363	It's Soul, Man!
364	Knocking Wood
365	Loco Twist
366	On The Rivers Side
367	Sir Duke Is Wondering
368	Unchained Heart
369	When Man Loves Someone
370	Will I See You Again
371	Wish I Could Groove
372	You Should Think Frankly
Country	
373	A Boy From The Country
374	Back On The Road
375	Blue Grass Bonanza
376	Forever In My Mind
377	Hi, Mary
378	Home On Country Highways
379	I Only Ever Need You
380	Lucille Left Me
381	Road Of The King
382	Special Orange
383	This Song Is Crazy!
384	Waltz In Tennessee
Latin	
385	At Daylight The Bananaboat Comes
386	At The Copa
387	Bossa Gets The Blame
388	Bossa In Blue
389	Cherry And Apple - Colored
390	Corazon on Tengo
391	Don't Worry, Reggae!
392	Eyes From Spain
393	Farewell To Jamaica
394	Flea From Spain
395	Frenetic Beguine
396	Guitar For Volare
397	Have You Been In Guantanamo
398	I Can't Bear More Than This
399	Italian Mambo
400	It Is A Band, Aah!
401	Jamaican Sun
402	Just A Little Spanish City
403	Lots Of Besame
404	Love's Amor In Latin
405	Luminous
406	Mambo Jamming
407	Mentiroso Es
408	My Sweet Calypso Girl
409	Not Less
410	Only One Note Makes A Samba
411	Pasodoble Cani
412	Patricia Is Dancing The Cha Cha
413	Rumba For Volare

Music Database List

No.	MDB Name
414	Rushing Fools
415	Say No More In Brazil
416	Start The Beguine
417	Swaying Rumba
418	Taxi In Tijuana
419	Thirty Second Bossa
420	Three Times Perhaps
421	Vida De Los Caminos
Latin Pop	
422	Dance In The Morning
423	You're Mine Baby
Ballroom	
424	Cumparsita Tango
425	He's Got To Go
426	Moon Waltz
427	Old St. Bernards
428	On Sunday? I Never Will!
429	Perfidious One
430	Quando Samba
431	Say Magnifique!
432	This House Is Not Young
433	Yellow Bird Rumba
Christmas	
434	Christmas Jingle
435	It's The Most Wonderful Time
436	Rednosed Rudolph
437	Silent Christmas
438	This Boy Child Is Mary's
439	Waltz At Christmas
Classical	
440	Cannot Remember My Dreams
441	Classical Maria
442	Dream Of Love
443	Gladiators Entry
444	Skaters Dance
445	Sonata In The Moonlight
446	Song In The Key Of F
447	Spring Voices
448	Strings In The Air
449	The March Of Radetzky
450	Tristesse Third Etude
451	Waltz Of The Fledermaus
Family	
452	Califragidocilistic? It's Super!
453	Necessary Bear
454	Noisy Old Car?
Instrumentals	
455	Acapulco Swings In The 20s
456	Adagio Chillout
457	Birds Played At Night
458	Concerto Of Love
459	Dancing Musicbox
460	Infant's Pavane Chillout
461	Invitation To The Shak
462	Jerry's Binx
463	Lonely Piper
464	Maple Ragtime
465	Paris Has Many Poor People
466	Petite Clarinet
467	Piece Of Funk
468	Rumba For Elena
469	String Holiday
470	Waltz Around The World
471	Yak This Sax
Party Time	
472	Aga Doo
473	Big Samba Bamboo
474	Blankenesenolop
475	Dancing Bird
476	Going With A Good Thing
477	Hands Up Party

No.	MDB Name
478	I Love To Drink Cider
479	Kreuzberg
480	Louie's My Brother
481	Mexican Trumpet
482	Mr. Schmidtchen
483	No Beer on Hawaii
484	Russ' Ozone Party
485	Song Of The Chicken
486	The Bucklehuck
Schlager	
487	Autobahnpolka
488	Blind Passenger
489	Capri Beat
490	Deep Love
491	Glaube An Wunder
492	Goodbye Amor
493	I Have Sad Love
494	In Ewigkeit
495	Italian Guy
496	Mexican Fiesta
497	Moscow City
498	No Tears
499	Oh Maria
500	Paloma Pop
501	Spanish Island
502	The Little House
503	Where Can I Find Love?
504	Wonderful Blonde
Worship	
505	Forever Singing Your Love
506	I Am Everything
507	Lord Is Great
508	Love Cannot Be Greater
509	Our God Is Mighty
510	Rain Down Holy Spirit
511	With My Total Heart
Screen Theme	
512	Ark Raiders March
513	A Spy Does It Better
514	Bank Robbers Ballad
515	Best On The Bill
516	Bills Barnacles
517	Dart Playing TV Theme
518	Daughters And Sons
519	Don't Be A Muppet!
520	Do You Think England's Done?
521	Farm Based Soap Theme
522	Fighting Stars
523	Flash Disco
524	Holiday Camp Rock
525	It's A Big Country
526	June & Terry's Theme
527	Lovin' Summer
528	Magnificent Flying Men
529	Main For Rain
530	Mi-Re-Do
531	My Prince Will Come One Day
532	Only Friends But Good Ones
533	Paradise Conquest
534	Seven Magnificent Cowboys
535	Song Of The Trolley
536	The Fantastic Getaway
537	These Are My Favorites!
538	Tie, Tails, And A Hat
539	Twelve O'Clock Theme
540	You're The Only One I Want
Showtime	
541	A Nickel In The Nickelodeon
542	Dance Lord
543	Dance Of Fire
544	Entertainment That Is
545	It's Only A Day Away!

No.	MDB Name
546	It's Time For Cabaret!
547	I Wished I Danced All Night
548	No Business Like It!
549	Parade At Easter
550	The Cat's Memory
551	The Greatest Times
552	The Roses Are Coming Up
553	The Sun Sets, The Sun Rises
554	Tonight At The Westside
Traditional	
555	Abide This Hymn
556	Ave Maria No More
557	Can Can Orpheus?
558	Fun In The Forest
559	Moulin Heart
560	Texas Yellow Rose
March & Polka	
561	Marching RAF
562	Rosa
563	That Polka Is Happy!
564	Vienna Forever
Waltz	
565	Amsterdam's Favorite Flowers
566	Amsterdam's Old Windmill
567	Charmaine's Waltz
568	Daisy's Bicycle
569	Fascination Waltz
570	I'm Trying To Remember
571	Is It True Love?
572	Lover Waltz
573	Samson's Girl
574	Snow Waltz
575	The Little Pub
576	Waltzing To Whatever Will Be
577	Waltz In Raggy Time
578	Waltz Of Amore
579	Waltz Of The Cuckoo
580	Waltz Of The Emperor
581	Waltz To Skate In Wintertime
World	
582	Alabina Orient
583	Close Your Face
584	Die Sabber josija
585	Goodbye Roma
586	I Land On The Sun
587	La Ballade De Gerard
588	La Cucarumba
589	La Maison Viens
590	La Puntualidad
591	Latin Cuccuru
592	Musette De Reine
593	Oh Beautiful Italian Sun
594	Only Say Hello
595	Populaire Chanson
596	Santa Lou Cheer
597	Shenandoah's Far Away
598	The Classy Trumpeter
599	Van Maas Land
600	Ya Salama



Voice Effect Type List

● Harmony Types

No.	Harmony Type	Description
1	01(Standard Duet)	Harmony types 01–14 are pitch-based and add one-, two- or three-note harmonies to the single-note melody played in the right hand. These types sound when chords are played in the auto accompaniment range of the keyboard. These Harmony types will also work when playing songs that contain chord data.
2	02(Standard Trio)	
3	03(Full Chord)	
4	04(Rock Duet)	
5	05(Country Duet)	
6	06(Country Trio)	
7	07(Block)	
8	08(4-Way Close 1)	
9	09(4-Way Close 2)	
10	10(4-Way Open)	
11	11(1+5)	
12	12(Octave)	
13	13(Strum)	
14	14(Multi Assign)	
15	15(Echo 1/4)	Types 15–26 are rhythm-based effects and add embellishments or delayed repeats in time with the auto accompaniment. These types sound whether the auto accompaniment is on or not; however, the actual speed of the effect depends on the Tempo setting (page 72). The individual note values in each type let you synchronize the effect precisely to the rhythm. Triplet settings are also available: 1/6 = quarter-note triplets, 1/12 = eighth-note triplets, 1/24 = sixteenth-note triplets. <ul style="list-style-type: none">• The Echo effect Types (15–18) create delayed repeats of each note played.• The Tremolo effect Types (19–22) repeat all held notes (up to four).• The Trill effect Types (23–26) create two-note trills (alternating notes) when two notes are held.
16	16(Echo 1/6)	
17	17(Echo 1/8)	
18	18(Echo 1/12)	
19	19(Tremolo 1/8)	
20	20(Tremolo 1/12)	
21	21(Tremolo 1/16)	
22	22(Tremolo 1/32)	
23	23(Trill 1/12)	
24	24(Trill 1/16)	
25	25(Trill 1/24)	
26	26(Trill 1/32)	

● Reverb Types

No.	Type	Description	MSB	LSB
1	HALL1	Reverb simulating the acoustics of a hall.	1	0
2	HALL2		1	16
3	HALL3		1	17
4	HALL4		1	18
5	HALL5		1	1
6	HALL M		1	6
7	HALL L		1	7
8	BASIC HALL		1	30
9	LARGE HALL		1	31
10	ATMO HALL		1	23
11	ROOM1	Reverb simulating the acoustics of a room.	2	16
12	ROOM2		2	17
13	ROOM3		2	18
14	ROOM4		2	19
15	ROOM5		2	0
16	ROOM6		2	1
17	ROOM7		2	2
18	ROOM S		2	5
19	ROOM M		2	6
20	ROOM L		2	7
21	ACOSTIC ROOM		2	20
22	DRUMS ROOM		2	21
23	PERC ROOM		2	22
24	STAGE1	Reverb suitable for a solo instrument.	3	16
25	STAGE2		3	17
26	STAGE3		3	0
27	STAGE4		3	1
28	PLATE1	Reverb simulating a plate reverb unit.	4	16
29	PLATE2		4	17
30	PLATE3		4	0
31	GM PLATE		4	7
32	TUNNEL	Simulates a cylindrical space expanding to left and right.	17	0
33	CANYON	A hypothetical acoustic space which extends without limit.	18	0
34	BASEMENT	A bit of initial delay followed by reverb with a unique resonance.	19	0
35	WHITE ROOM	A unique short reverb with a bit of initial delay.	16	0
36	NO EFFECT	No effect.	0	0

● Chorus Types

No.	Type	Description	MSB	LSB
1	CHORUS1	Conventional chorus program with rich, warm chorusing.	66	17
2	CHORUS2		66	8
3	CHORUS3		66	16
4	CHORUS4		66	1
5	CHORUS5		65	2
6	CHORUS6		65	0
7	CHORUS7		65	1
8	CHORUS8		65	8
9	CHORUS FAST		65	16
10	CHORUS LITE		65	17
11	GM CHORUS1		65	3
12	GM CHORUS2		65	4
13	GM CHORUS3		65	5
14	GM CHORUS4		65	6
15	FB CHORUS		65	7
16	CELESTE1	A 3-phase LFO adds modulation and spaciousness to the sound.	66	0
17	CELESTE2		66	2
18	SYMPHONIC1	Adds more stages to the modulation of Celeste.	68	16
19	SYMPHONIC2		68	0
20	FLANGER1	Creates a sound reminiscent of a jet airplane.	67	8
21	FLANGER2		67	16
22	FLANGER3		67	17
23	FLANGER4		67	1
24	FLANGER5		67	0
25	GM FLANGER		67	7
26	ROTARY SP1	Simulates a rotary speaker.	69	16
27	ROTARY SP2		71	17
28	ROTARY SP3		71	18
29	ROTARY SP4		70	17
30	ROTARY SP5		66	18
31	ROTARY SP6		69	0
32	ROTARY SP7		71	22
33	2WAY ROT SP		86	0
34	AUTO PAN1	Several panning effects that automatically shift the sound position (left, right, front, back).	71	16
35	AUTO PAN2		71	0
36	EP AUTOPAN		71	21
37	T_AUTO PAN1	Tempo synchronized Auto PAN.	121	0
38	TREMOLO1	Rich Tremolo effect with both volume and pitch modulation.	70	16
39	TREMOLO2		71	19
40	TREMOLO3		70	0
41	EP TREMOLO		70	18
42	GT TREMOLO1		71	20
43	GT TREMOLO2		70	19
44	T_TREMOLO		120	0
45	NO EFFECT		No effect.	0

● DSP Types

No.	Type	Description	MSB	LSB
1	HALL1	Reverb simulating the acoustics of a hall.	1	0
2	HALL2		1	16
3	HALL3		1	17
4	HALL4		1	18
5	HALL5		1	1
6	HALL M		1	6
7	HALL L		1	7
8	BASIC HALL		1	30
9	LARGE HALL		1	31
10	ATMO HALL		1	23
11	ROOM1	Reverb simulating the acoustics of a room.	2	16
12	ROOM2		2	17
13	ROOM3		2	18
14	ROOM4		2	19
15	ROOM5		2	0
16	ROOM6		2	1
17	ROOM7		2	2
18	ROOM S		2	5
19	ROOM M		2	6
20	ROOM L		2	7
21	ACOSTIC ROOM		2	20
22	DRUMS ROOM	2	21	
23	PERC ROOM	2	22	
24	STAGE1	Reverb suitable for a solo instrument.	3	16
25	STAGE2		3	17
26	STAGE3		3	0
27	STAGE4		3	1
28	PLATE1	Reverb simulating a plate reverb unit.	4	16
29	PLATE2		4	17
30	PLATE3		4	0
31	GM PLATE		4	7
32	TUNNEL	Simulates a cylindrical space expanding to left and right.	17	0
33	CANYON	A hypothetical acoustic space which extends without limit.	18	0
34	BASEMENT	A bit of initial delay followed by reverb with a unique resonance.	19	0
35	WHITE ROOM	A unique short reverb with a bit of initial delay.	16	0
36	CHORUS1	Conventional chorus program with rich, warm chorusing.	66	17
37	CHORUS2		66	8
38	CHORUS3		66	16
39	CHORUS4		66	1
40	CHORUS5		65	2
41	CHORUS6		65	0
42	CHORUS7		65	1
43	CHORUS8		65	8
44	CHORUS FAST		65	16
45	CHORUS LITE		65	17
46	GM CHORUS1		65	3
47	GM CHORUS2		65	4
48	GM CHORUS3		65	5
49	GM CHORUS4		65	6
50	FB CHORUS		65	7
51	CELESTE1	A 3-phase LFO adds modulation and spaciousness to the sound.	66	0
52	CELESTE2		66	2
53	SYMPHONIC1	Adds more stages to the modulation of Celeste.	68	16
54	SYMPHONIC2		68	0
55	ENS DETUNE1	Chorus effect without modulation, created by adding a slightly pitch-shifted sound.	87	0
56	ENS DETUNE2		87	16
57	KARAOKE1	Echo for karaoke.	20	0
58	KARAOKE2		20	1
59	KARAOKE3		20	2
60	ER1	This effect isolates only the early reflection components of the reverb.	9	0
61	ER2		9	1
62	GATE REVERB	Simulation of gated reverb.	10	0
63	REVERS GATE	Simulation of gated reverb played back in reverse.	11	0
64	EQ DISCO	Equalizer effect that boosts both high and low frequencies, as is typical in most disco music.	76	16
65	EQ TEL	Equalizer effect that cuts both high and low frequencies, to simulate the sound heard through a telephone receiver.	76	17
66	2BAND EQ	A stereo EQ with adjustable LOW and HIGH. Ideal for drum Parts.	77	0
67	3BAND EQ	A mono EQ with adjustable LOW, MID, and HIGH equalizing.	76	0

No.	Type	Description	MSB	LSB
68	ST 3BAND EQ	Stereo EQ with adjustable LOW, MID and HIGH equalization.	76	18
69	HM ENHANCE1	Adds new harmonics to the input signal to make the sound stand out. Creates a sound reminiscent of a jet airplane.	81	16
70	HM ENHANCE2		81	0
71	FLANGER1		67	8
72	FLANGER2		67	16
73	FLANGER3		67	17
74	FLANGER4		67	1
75	FLANGER5		67	0
76	GM FLANGER		67	7
77	V_FLANGER	Flanger which simulates vintage tube and fuzz sounds.	104	0
78	TEMPO FLANGER	Tempo synchronized flanger.	107	0
79	DELAY LCR1	Produces three delayed sounds: L, R and C (center).	5	16
80	DELAY LCR2		5	0
81	DELAY LR	Produces two delayed sounds: L and R. Two feedback delays are provided.	6	0
82	ECHO	Two delayed sounds (L and R), and independent feedback delays for L and R.	7	0
83	CROSS DELAY	The feedback of the two delayed sounds is crossed.	8	0
84	TEMPO DELAY	Tempo synchronized delay.	21	0
85	TEMPO ECHO	Tempo synchronized delay.	21	8
86	TEMPO CROSS	Tempo synchronized L&R delay.	22	0
87	V_DST ROCA	Vintage Distortion.	103	18
88	V_DST FUSION		103	19
89	V_DST CRUNC		98	28
90	V_DST VINTAG		98	29
91	V_DST HARD2		98	30
92	V_DST HEAVY		98	31
93	V_DST HARD1		98	0
94	V_DST SOFT		98	2
95	DIST HARD1	Hard-edge distortion.	75	16
96	DIST HARD2		75	22
97	DIST SOFT1	Soft, warm distortion.	75	17
98	DIST SOFT2		75	23
99	DIST HEAVY	Heavy distortion.	73	0
100	OVERDRIVE1	Adds mild distortion to the sound.	74	0
101	OVERDRIVE2		74	9
102	ST DIST	Stereo distortion.	73	8
103	ST OD	Stereo Overdrive.	74	8
104	ST DIST HARD	Hard-edge stereo distortion.	75	18
105	ST DIST SOFT	Soft, warm soft distortion.	75	19
106	AMP SIM1	A simulation of a guitar amp.	75	0
107	AMP SIM2		75	1
108	ST AMP1		75	20
109	ST AMP2		75	21
110	ST AMP3		75	8
111	ST AMP4		75	24
112	ST AMP5		75	25
113	ST AMP6	75	26	
114	DST+DELAY1	Distortion and Delay are connected in series.	95	16
115	DST+DELAY2		95	0
116	OD+DELAY1	Overdrive and Delay are connected in series.	95	17
117	OD+DELAY2		95	1
118	CMP+DST+DLY1	Compressor, Distortion and Delay are connected in series.	96	16
119	CMP+DST+DLY2		96	0
120	CMP+OD+DLY1	Compressor, Overdrive and Delay are connected in series.	96	17
121	CMP+OD+DLY2		96	1
122	V_DST H+DLY	V Distortion and Delay are connected in series.	98	1
123	V_DST S+DLY		98	3
124	DST+TDLY	Distortion and Tempo Delay are connected in series.	100	0
125	OD+TDLY	Overdrive and Tempo Delay are connected in series.	100	1
126	COMP+DIST1	Compressor and Distortion are connected in series.	73	16
127	COMP+DIST2		73	1
128	CMP+DST+TDLY	Compressor, Distortion and Tempo Delay are connected in series.	101	0
129	CMP+OD+TDLY1	Compressor, Overdrive and Tempo Delay are connected in series.	101	1
130	CMP+OD+TDLY2		101	16
131	CMP+OD+TDLY3		101	17
132	CMP+OD+TDLY4		101	18
133	CMP+OD+TDLY5		101	19
134	CMP+OD+TDLY6		101	20

Voice Effect Type List

No.	Type	Description	MSB	LSB
135	V_DST H+TDL1	V Distortion and Tempo Delay are connected in series.	103	0
136	V_DST H+TDL2		103	17
137	V_DST S+TDL1		103	1
138	V_DST S+TDL2		103	16
139	COMP MED	Holds down the output level when a specified input level is exceeded. A sense of attack can also be added to the sound.	83	16
140	COMP HEAVY		83	17
141	COMP MELODY		105	16
142	COMP BASS		105	17
143	MBAND COMP	Multi-band compressor that allows you to adjust the compression effect for individual frequency bands.	105	0
144	COMPRESSOR	Holds down the output level when a specified input level is exceeded. A sense of attack can also be added to the sound.	83	0
145	NOISE GATE	Gates the input when the input signal falls below a specified level.	84	0
146	VCE CANCEL	Attenuates the vocal part of a CD or other source.	85	0
147	AMBIENCE	Blurs the stereo positioning of the sound to add spatial width.	88	0
148	TALKING MOD	Adds a vowel sound to the input signal.	93	0
149	ISOLATOR	Controls the level of a specified frequency band of the input signal.	115	0
150	PHASER1	Cyclically modulates the phase to add modulation to the sound.	72	0
151	PHASER2		72	8
152	PHASER3		72	19
153	T_PHASER1		108	0
154	T_PHASER2		108	16
155	EP PHASER1		72	17
156	EP PHASER2		72	18
157	EP PHASER3		72	16
158	PITCH CHG1		Changes the pitch of the input signal.	80
159	PITCH CHG2	80		0
160	PITCH CHG3	80		1
161	DUAL ROT BRT	Rotary speaker simulation with speed switching.	99	16
162	D ROT BRT F		99	30
163	DUAL ROT WRM		99	17
164	D ROT WRM F		99	31
165	DUAL ROT SP1		99	0
166	DUAL ROT SP2		99	1
167	ROTARY SP1	Simulates a rotary speaker.	69	16
168	ROTARY SP2		71	17
169	ROT SP2 FAST		71	23
170	ROTARY SP3		71	18
171	ROT SP3 FAST		71	24
172	ROTARY SP4		70	17
173	ROT SP4 FAST		70	20
174	ROTARY SP5		66	18
175	ROT SP5 FAST		66	19
176	ROTARY SP6		69	0
177	ROTARY SP7		71	22
178	ROT SP7 FAST		71	25
179	ROTARY SP8		69	17
180	ROT SP8 FAST		69	18
181	ROTARY SP9		69	19
182	ROT SP9 FAST		69	20
183	2WAY ROT SP	86	0	
184	DST+ROT SP	Distortion and rotary speaker connected in series.	69	1
185	DST+2ROT SP	Distortion and 2-way rotary speaker connected in series.	86	1
186	OD+ROT SP	Overdrive and rotary speaker connected in series.	69	2
187	OD+2ROT SP	Overdrive and 2-way rotary speaker connected in series.	86	2
188	AMP+ROT SP	Amp simulator and rotary speaker connected in series.	69	3
189	AMP+2ROT SP	Amp simulator and 2-way rotary speaker connected in series.	86	3
190	AUTO PAN1	Several panning effects that automatically shift the sound position (left, right, front, back).	71	16
191	AUTO PAN2		71	0
192	AUTO PAN3		71	1
193	EP AUTOPAN		71	21
194	T_AUTO PAN1	Tempo synchronized pan.	121	0
195	T_AUTO PAN2		121	1
196	TREMOLO1	Rich Tremolo effect with both volume and pitch modulation.	70	16
197	TREMOLO2		71	19
198	TREMOLO3		70	0
199	EP TREMOLO		70	18
200	GT TREMOLO1		71	20
201	GT TREMOLO2		70	19
202	VIBE VIBRATE		Vibraphone effect.	119

No.	Type	Description	MSB	LSB
203	T_TREMOLO	Tempo synchronized tremolo.	120	0
204	AUTO WAH1	Cyclically modulates the center frequency of a wah filter.	78	16
205	AUTO WAH2		78	0
206	AT WAH+DST1	The output of an Auto Wah can be distorted by Distortion.	78	17
207	AT WAH+DST2		78	1
208	AT WAH+OD1	The output of an Auto Wah can be distorted by Overdrive.	78	18
209	AT WAH+OD2		78	2
210	TEMPO AT WAH	Tempo synchronized auto wah.	79	0
211	TOUCH WAH1	Changes the center frequency of a wah filter according to the input level.	82	0
212	TOUCH WAH2		82	8
213	TOUCH WAH3		82	20
214	TC WAH+DST1	The output of an Touch Wah can be distorted by Distortion.	82	16
215	TC WAH+DST2		82	1
216	TC WAH+OD1	The output of an Touch Wah can be distorted by Overdrive.	82	17
217	TC WAH+OD2		82	2
218	WH+DST+DLY1	Wah, Distortion and Delay are connected in series.	97	16
219	WH+DST+DLY2		97	0
220	WH+DST+TDLY	WAH, Distortion and Tempo Delay are connected in series.	102	0
221	WH+OD+DLY1	Wah, Overdrive and Delay are connected in series.	97	17
222	WH+OD+DLY2		97	1
223	WH+OD+TDLY1	WAH, Overdrive and Tempo Delay are connected in series.	102	1
224	WH+OD+TDLY2		102	16
225	CLVI TC WAH1	Clavinet Touch Wah.	82	18
226	CLVI TC WAH2		82	28
227	EP TC WAH1	EP Touch Wah.	82	19
228	EP TC WAH2		82	29
229	PEDAL WAH	Pedal position changes the center frequency of the wah filter.	122	0
230	PEDAL WH+DST	Distortion applied to the pedal wah output.	122	1
231	P.WH+DIST HD		122	21
232	P.WH+DIST HV		122	23
233	P.WH+DIST LT		122	25
234	PEDAL WH+OD	Overdrive (distortion) applied to the pedal wah output.	122	2
235	P.WH+OD HD		122	22
236	P.WH+OD HV		122	24
237	P.WH+OD LT		122	26
238	NO EFFECT	No effect.	0	0
239	THRU	Bypass without applying an effect.	64	0



MIDI Implementation Chart

Date: 11-APR-2008
Version: 1.0

YAMAHA [Digital Keyboard]
Model PSR-S550 MIDI Implementation Chart

Function...	Transmitted	Recognized	Remarks
Basic Default Channel Changed	1 - 16 1 - 16	1 - 16 1 - 16	
Mode Default Messages Altered	3 x *****	3 x x	
Note Number : True voice	0 - 127 *****	0 - 127 0 - 127	
Velocity Note ON Note OFF	o 9nH, v=1-127 x 9nH, v=0	o 9nH, v=1-127 x	
After Touch Key's Ch's	x x	x o	
Pitch Bend	o 0-24 semi	o 0-24 semi	
Control	o 0, 32 o 1, 5, 7, 10, 11 o 6, 38 o 64-67 o 71-74 o 84	o o o o o o	Bank Select Data Entry Sound Controller Portament Cntrl Effect Depth
Change	o 91, 93, 94 o 96-97 o 98-99 o 100-101	o o o o	RPN Inc, Dec NRPN LSB, MSB RPN LSB, MSB

Prog Change : True #	o 0 - 127 *****	o 0 - 127	
System Exclusive	o	o	
: Song Pos.	x	x	
: Song Sel.	x	x	
: Tune	x	x	
System : Clock	o	o	
Real Time: Commands	o	o	
Aux :All Sound OFF	x	o (120, 126, 127)	
:Reset All Cntrls	x	o (121)	
:Local ON/OFF	x	o (122)	
:All Notes OFF	x	o (123-125)	
Mes- :Active Sense	o	o	
sages:Reset	x	x	
Notes:			

Mode 1 : OMNI ON , POLY Mode 2 : OMNI ON , MONO o : Yes
 Mode 3 : OMNI OFF, POLY Mode 4 : OMNI OFF, MONO x : No



MIDI Data Format

NOTE:

1 By default (factory settings) the instrument ordinarily functions as a 16-channel multi-timbral tone generator, and incoming data does not affect the panel voices or panel settings. However, the MIDI messages listed below do affect the panel voices, auto accompaniment, and songs.

- MIDI Master Tuning
- System exclusive messages for changing the Reverb Type, Chorus Type and DSP Type.

2 Messages for these control change numbers cannot be transmitted from the instrument itself. However, they may be transmitted when playing the accompaniment, song or using the Harmony effect.

3 Exclusive

<GM System ON> F0H, 7EH, 7FH, 09H, 01H, F7H

- This message automatically restores all default settings for the instrument, with the exception of MIDI Master Tuning.

<MIDI Master Volume> F0H, 7FH, 7FH, 04H, 01H, II, mm, F7H

- This message allows the volume of all channels to be changed simultaneously (Universal System Exclusive).
- The values of "mm" is used for MIDI Master Volume. (Values for "II" are ignored.)

<XG Master Tuning> F0H, 43H, 1nH, 4CH, 00H, 00H, 00H, ddH, ddH, ddH, ddH, F7H

- This message simultaneously changes the tuning value of all channels.
- The values of "dd" are used for XG Master Tuning.
- The default value of "dd" are 00H, 04H, 00H, 00H, respectively.

<Reverb Type> F0H, 43H, 1nH, 4CH, 02H, 01H, 00H, mmH, IIH, F7H

- mm : Reverb Type MSB
- II : Reverb Type LSB

Refer to the Effect Type List (page 126) for details.

<Chorus Type> F0H, 43H, 1nH, 4CH, 02H, 01H, 20H, mmH, IIH, F7H

- mm : Chorus Type MSB
- II : Chorus Type LSB

Refer to the Effect Type List (page 127) for details.

<DSP Type> F0H, 43H, 1nH, 4CH, 02H, 01H, 40H, mmH, IIH, F7H

- mm : DSP Type MSB
- II : DSP Type LSB

Refer to the Effect Type List (page 128) for details.

4 When the accompaniment is started, an FAH message is transmitted. When accompaniment is stopped, an FCH message is transmitted. When the clock is set to External, both FAH (accompaniment start) and FCH (accompaniment stop) are recognized.

5 Local ON/OFF

<Local ON> Bn, 7A, 7F

<Local OFF> Bn, 7A, 00

Value for "n" is ignored.



Specifications

Keyboards

- 61 Standard-size keys (C1–C6), with Touch Response.

Display

- 320 x 240 dots LCD display (backlit)

Setup

- STANDBY/ON
- MASTER VOLUME: MIN–MAX
- LCD CONTRAST

Panel Controls

- DEMO, SONG MODE
- SONG-PRESET, SONG-USER, SONG-SCORE, SONG-LYRICS, SONG-REC
- USB
- STYLE CATEGORY, VOICE CATEGORY
- TRANPOSE [-] [+], METRONOME, TAP TEMPO, TEMPO [-] [+]
- OTS LINK, AUTO FILL IN, ACMP, INTRO [1]–[3], MAIN VARIATION [A]–[D], ENDING/rit. [1]–[3] (REW) (FF), SYNC STOP (A-B REPEAT), SYNC START (PAUSE), START/STOP
- REGIST/PART [MIXER], MEMORY, REGIST BANK [-] [+], REGISTRATION MEMORY [1]–[8], STYLE [1]–[8], SONG [1/9]–[8/16], EXIT, CATEGORY [◀] [▶], Dial. [+ / YES] [- / NO]
- EXECUTE, MDB, FILE MENU, FUNCTION, ONE TOUCH SETTING [1]–[4], LEFT, DUAL, HARMONY, TOUCH, SUSTAIN, DSP, UPPER OCTAVE [-] [+]

Realtime Control

- Pitch Bend Wheel

Voice

- 294 Voices + 12 Drum Kits + 10 SFX kits + 480 XG Voices (Included 11 Regional Voices and 8 Regional Drum/Percussion Kits)
- Polyphony: 64
- LEFT
- DUAL

Style

- 176
- Style Control: ACMP ON/OFF, SYNC STOP, SYNC START, START/STOP, INTRO [1]–[3], MAIN VARIATION [A]–[D], ENDING/rit. [1]–[3], AUTO FILL IN
- Style Creator
- Fingering: Multi Finger, Full Keyboard
- Style Volume

Music Database

- 600

Registration Memory

- 8 banks x 8 memories
- Regist Clear

Mixer

- Volume, Pan, Reverb, Chorus

Function

- VOLUME: Style Volume, Song Volume
- OVERALL: Tuning, Pitch Bend Range, Split Point, Touch Sensitivity, Chord Fingering
- MAIN VOICE: Volume, Octave, Pan, Reverb Level, Chorus Level, DSP Level, Dry Level
- DUAL VOICE: Volume, Octave, Pan, Reverb Level, Chorus Level, DSP Level, Dry Level
- LEFT VOICE: Volume, Octave, Pan, Reverb Level, Chorus Level, DSP Level, Dry Level
- EFFECT: Reverb Type, Chorus Type, DSP Type, Master EQ Type
- HARMONY: Harmony Type, Harmony Volume
- PC: PC Mode
- MIDI: Local On/Off, External Clock, Keyboard Out, Style Out, Song Out, Initial Setup
- METRONOME: Time Signature Numerator, Time Signature Denominator, Bell On/Off, Metronome Volume Quantize, Right-Part, Left-Part
- SCORE: Demo Cancel, TG Mode
- UTILITY: Demo Cancel, TG Mode
- LANGUAGE: Language

Effects

- Harmony: 26 types
- Reverb: 35 types
- Chorus: 44 types
- DSP: 237 types

Song

- 9 Preset Songs + User Songs + USB Memory
- Song Clear, Track Clear
- Song Volume
- Song Control: A-B REPEAT, PAUSE, REW, FF, START/STOP

Recording

- Song
 - User Song: 5 Songs
 - Recording Tracks: 1–16, STYLE
- Style Creator

MIDI

- Local On/Off
- Initial Setup
- External Clock
- Keyboard Out
- Style Out
- Song Out

Auxiliary jacks

- PHONES/OUTPUT, DC IN 16V, USB TO HOST, USB TO DEVICE, SUSTAIN

Amplifier

- 12W x 2

Speakers

- (12cm + 3cm) x 2

Power Consumption

- 25W

Power Supply

- Adaptor: Yamaha PA-301 or PA-300 AC power adaptor

Dimensions (W x D x H)

- 946 x 402 x 130 mm (37-1/4" x 15-7/8" x 5-1/8")

Weight

- 7.5kg (16 lbs., 9 oz.)

Supplied Accessories

- Music Rest
- Accessory CD-ROM
- Owner's Manual
- AC Power adaptor (May not be included depending on your particular area.)

Optional Accessories

- Headphones: HPE-150
- Keyboard Stand: L6
- Footswitch: FC4/FC5

* Specifications and descriptions in this owner's manual are for information purposes only. Yamaha Corp. reserves the right to change or modify products or specifications at any time without prior notice. Since specifications, equipment or options may not be the same in every locale, please check with your Yamaha dealer.



Index

+ / YES, - / NO button	14, 41
▶ / ■ button	14, 28, 41
■ ■ button	14, 28
A ⇌ B button	14, 73
▶▶ button	14, 28
◀◀ button	14, 28

A	
A-B Repeat	73
Accessories	7
ACMP button	14, 23
Auto Accompaniment Region	23
AUTO FILL IN button	55
Auto Fill-in	55

B	
Backup	39
Backup Clear	39
Backup data (Transfer)	98
Bank	77
Beat	50

C	
Category	17, 22, 27, 40
Category ◀ and ▶ buttons	15, 41
CD-ROM	7, 99
Chord	23, 25, 61–62
Chord Fingering	25, 63
Chorus	46
Chorus Type	127
Clear (Song Track)	38
Clear (User Song)	37
Computer	91–92, 94, 96
Contrast	12
CONTRAST knob	12, 15

D	
DC IN 16V jack	10, 15
Delete (File Menu)	88
DEMO button	14, 16
Demo Cancel	82
Demo Song	16
Dial	14, 41
Display	42
Drum Kit	21
Drum Kit List	116
DSP	47
DSP button	15, 47
DSP Type	128
DUAL button	15, 18
Dual Voice	18
Dual Voice Chorus level	81
Dual Voice Dry Level	81

Dual Voice DSP Level	81
Dual Voice Octave	81
Dual Voice Pan	81
Dual Voice Reverb Level	81
Dual Voice Volume	81

E	
Effect Type List	125
Ending	55
ENDING/rit. I–III buttons	14, 55
EXECUTE button	15, 84
EXIT button	14, 42
External Clock	94
External Song	29

F	
FF	28
File Control	83
FILE MENU button	15, 83–84
File Save (File Menu)	85
Footswitch	10
Format (File Menu)	84
FullKeyboard	63
FUNCTION button	15, 80
FUNCTION display	42
Function Settings	80–82

H	
Harmony	44
HARMONY button	15, 44
Harmony Type	44, 125
Harmony Volume	82
Headphones	10

I	
Initial Send	95
Initial Setup	95
Initialization	39
INTRO I–III buttons	14, 55

K	
Keyboard Out	94

L	
Language	12
LEFT button	15, 19
Left Part	98
Left Voice	19
Left Voice Chorus Level	81
Left Voice Dry Level	81
Left Voice DSP Level	81
Left Voice Octave	81

Left Voice Pan	81
Left Voice Reverb Level	81
Left Voice Volume	81
Load (File Menu)	87
Loaded Song	29
Local	94
Lyrics	31
LYRICS button	14, 31

M	
Main	55
MAIN A–D buttons	14, 55
MAIN Display	42
MAIN VARIATION (Style)	55
Main Voice	17
Main Voice Chorus Level	81
Main Voice Dry Level	81
Main Voice DSP Level	81
Main Voice Octave	81
Main Voice Pan	81
Main Voice Reverb level	81
Main Voice Volume	81
Master EQ Type	52
MASTER VOLUME control ..	11, 14, 40
MDB button	15, 26
Measure	36
MEMORY button	14, 77
MEMORY Clear	39
Message (LCD)	108
Metronome	49
METRONOME button	14, 49–50
Metronome Volume	50
MIDI	94
MIDI Data Format	134
MIDI Implementation Chart	132
Multi Recording	34
Music Database	26
Music Database List	122
Music Rest	13
Mute	74

O	
Octave	54
One Touch Setting (OTS)	58
ONE TOUCH SETTING 1–4 buttons	15, 58
Options	135
OTS LINK button	14, 58

P	
Part Assign	35
PAUSE	28
PC	95
PHONES/OUTPUT jack	10, 15

Pitch Bend 48
 Pitch Bend Range 81
 PITCH BEND wheel 15, 48
 Power Adaptor 10
 PRESET button 14, 27
 Preset Song 29

Q

Quantize 82
 Quick Recording 33

R

REC button 14, 33
 Record 32
 REGIST BANK +, - buttons 14, 77
 REGIST/PART [MIXER] button.. 14, 74
 Registration Memory 77
 REGISTRATION MEMORY
 1–8 buttons 14, 77
 Repeat (A-B Repeat) 73
 Reverb 45
 Reverb Type 126
 REW 28
 Right Part 98

S

Score 30
 SCORE button 14, 30
 Section 55
 SMF (Standard MIDI File) 86
 SMF Save 86
 SOFTWARE LICENSE AGREEMENT
 105
 Song 27–29
 SONG category buttons 14, 27
 Song Clear 37
 Song Memory 32, 35
 SONG MODE button 14, 27
 Song Out 94
 Song Volume 72
 Specifications 135
 Split Point 19, 59
 STANDBY/ON switch 11, 14
 START/STOP button 14, 22, 41
 Stop Accompaniment 60
 Store (Registration) 77
 Style 22, 55
 STYLE category buttons 14, 22
 Style File 63
 Style List 121
 Style Out 94
 Style Volume 60
 SUSTAIN (Footswitch) 10
 Sustain (Panel) 47

SUSTAIN button 15, 47
 SUSTAIN jack 10, 15
 SYNC START button 14, 23, 56
 SYNC STOP button 14, 57
 Synchro Start 56
 Synchro Stop 57

T

Tap Start 51
 TAP TEMPO button 14, 51
 Tempo 72
 TEMPO +, - buttons 14, 49, 72
 Time Signature 50
 TOUCH button 15, 51
 Touch Sensitivity 51
 Track 32, 74
 Track Clear 38
 Transfer 96, 98
 Transpose 53
 TRANSPOSE +, - buttons 14, 53
 Troubleshooting (Installation Guide) 104
 Troubleshooting (Instrument) 107
 Tuning 53

U

UPPER OCTAVE +, - buttons 15, 54
 USB 90
 USB button 14, 27
 USB MIDI Driver 101–102
 USB Song 29
 USB TO DEVICE terminal 15, 83, 90
 USB TO HOST terminal 15, 90, 92
 USER (Song) button 14, 27
 USER (Style) button 63
 User File 85, 87
 User Song 29, 32
 User Style 63

V

Voice 17
 VOICE category buttons 15, 17
 Voice List 110
 Volume 40

X

XG 6

Information for Users on Collection and Disposal of Old Equipment



This symbol on the products, packaging, and/or accompanying documents means that used electrical and electronic products should not be mixed with general household waste.

For proper treatment, recovery and recycling of old products, please take them to applicable collection points, in accordance with your national legislation and the Directives 2002/96/EC.

By disposing of these products correctly, you will help to save valuable resources and prevent any potential negative effects on human health and the environment which could otherwise arise from inappropriate waste handling.

For more information about collection and recycling of old products, please contact your local municipality, your waste disposal service or the point of sale where you purchased the items.

[For business users in the European Union]

If you wish to discard electrical and electronic equipment, please contact your dealer or supplier for further information.

[Information on Disposal in other Countries outside the European Union]

This symbol is only valid in the European Union. If you wish to discard these items, please contact your local authorities or dealer and ask for the correct method of disposal.

For details of products, please contact your nearest Yamaha representative or the authorized distributor listed below.

Pour plus de détails sur les produits, veuillez-vous adresser à Yamaha ou au distributeur le plus proche de vous figurant dans la liste suivante.

Die Einzelheiten zu Produkten sind bei Ihrer unten aufgeführten Niederlassung und bei Yamaha Vertragshändlern in den jeweiligen Bestimmungsländern erhältlich.

Para detalles sobre productos, contacte su tienda Yamaha más cercana o el distribuidor autorizado que se lista debajo.

NORTH AMERICA

CANADA

Yamaha Canada Music Ltd.
135 Milner Avenue, Scarborough, Ontario,
M1S 3R1, Canada
Tel: 416-298-1311

U.S.A.

Yamaha Corporation of America
6600 Orangethorpe Ave., Buena Park, Calif. 90620,
U.S.A.
Tel: 714-522-9011

CENTRAL & SOUTH AMERICA

MEXICO

Yamaha de México S.A. de C.V.
Calz. Javier Rojo Gómez #1149,
Col. Guadalupe del Moral
C.P. 09300, México, D.F., México
Tel: 55-5804-0600

BRAZIL

Yamaha Musical do Brasil Ltda.
Rua Joaquim Floriano, 913 - 4º andar, Itaim Bibi,
CEP 04534-013 Sao Paulo, SP. BRAZIL
Tel: 011-3704-1377

ARGENTINA

Yamaha Music Latin America, S.A.
Sucursal de Argentina
Olga Cossetini 1553, Piso 4 Norte
Madero Este-C1107CEK
Buenos Aires, Argentina
Tel: 011-4119-7000

PANAMA AND OTHER LATIN AMERICAN COUNTRIES/ CARIBBEAN COUNTRIES

Yamaha Music Latin America, S.A.
Torre Banco General, Piso 7, Urbanización Marbella,
Calle 47 y Aquilino de la Guardia,
Ciudad de Panamá, Panamá
Tel: +507-269-5311

EUROPE

THE UNITED KINGDOM

Yamaha Music U.K. Ltd.
Sherbourne Drive, Tilbrook, Milton Keynes,
MK7 8BL, England
Tel: 01908-366700

IRELAND

Danfay Ltd.
61D, Sallynoggin Road, Dun Laoghaire, Co. Dublin
Tel: 01-2859177

GERMANY

Yamaha Music Central Europe GmbH
Siemensstraße 22-34, 25462 Rellingen, Germany
Tel: 04101-3030

SWITZERLAND/LIECHTENSTEIN

Yamaha Music Central Europe GmbH,
Branch Switzerland
Seefeldstrasse 94, 8008 Zürich, Switzerland
Tel: 01-383 3990

AUSTRIA

Yamaha Music Central Europe GmbH,
Branch Austria
Schleiergasse 20, A-1100 Wien, Austria
Tel: 01-60203900

CZECH REPUBLIC/SLOVAKIA/ HUNGARY/SLOVENIA

Yamaha Music Central Europe GmbH,
Branch Austria, CEE Department
Schleiergasse 20, A-1100 Wien, Austria
Tel: 01-602039025

POLAND

Yamaha Music Central Europe GmbH
Sp.z. o.o. Oddział w Polsce
ul. 17 Stycznia 56, PL-02-146 Warszawa, Poland
Tel: 022-868-07-57

THE NETHERLANDS/ BELGIUM/LUXEMBOURG

Yamaha Music Central Europe GmbH,
Branch Benelux
Clarissenhof 5-b, 4133 AB Vianen, The Netherlands
Tel: 0347-358 040

FRANCE

Yamaha Musique France
BP 70-77312 Marne-la-Vallée Cedex 2, France
Tel: 01-64-61-4000

ITALY

Yamaha Musica Italia S.P.A.
Viale Italia 88, 20020 Lainate (Milano), Italy
Tel: 02-935-771

SPAIN/PORTUGAL

Yamaha Música Ibérica, S.A.
Ctra. de la Coruna km. 17, 200, 28230
Las Rozas (Madrid), Spain
Tel: 91-639-8888

GREECE

Philippos Nakas S.A. The Music House
147 Skiathou Street, 112-55 Athens, Greece
Tel: 01-228 2160

SWEDEN

Yamaha Scandinavia AB
J. A. Wettergrens Gata 1, Box 30053
S-400 43 Göteborg, Sweden
Tel: 031 89 34 00

DENMARK

YS Copenhagen Liaison Office
Generatorvej 6A, DK-2730 Herlev, Denmark
Tel: 44 92 49 00

FINLAND

F-Musiikki Oy
Kluuvikatu 6, P.O. Box 260,
SF-00101 Helsinki, Finland
Tel: 09 618511

NORWAY

Norsk filial av Yamaha Scandinavia AB
Grini Næringspark 1, N-1345 Østerås, Norway
Tel: 67 16 77 70

ICELAND

Skifan HF
Skeifan 17 P.O. Box 8120, IS-128 Reykjavik, Iceland
Tel: 525 5000

RUSSIA

Yamaha Music (Russia)
Office 4015, entrance 2, 21/5 Kuznetskii
Most street, Moscow, 107996, Russia
Tel: 495 626 0660

OTHER EUROPEAN COUNTRIES

Yamaha Music Central Europe GmbH
Siemensstraße 22-34, 25462 Rellingen, Germany
Tel: +49-4101-3030

AFRICA

Yamaha Corporation,
Asia-Pacific Music Marketing Group
Nakazawa-cho 10-1, Naka-ku, Hamamatsu,
Japan 430-8650
Tel: +81-53-460-2312

MIDDLE EAST

TURKEY/CYPRUS

Yamaha Music Central Europe GmbH
Siemensstraße 22-34, 25462 Rellingen, Germany
Tel: 04101-3030

OTHER COUNTRIES

Yamaha Music Gulf FZE
LOB 16-513, P.O.Box 17328, Jubel Ali,
Dubai, United Arab Emirates
Tel: +971-4-881-5868

ASIA

THE PEOPLE'S REPUBLIC OF CHINA

Yamaha Music & Electronics (China) Co.,Ltd.
25/F., United Plaza, 1468 Nanjing Road (West),
Jingan, Shanghai, China
Tel: 021-6247-2211

HONG KONG

Tom Lee Music Co., Ltd.
11/F., Silvercord Tower 1, 30 Canton Road,
Tsimshatsui, Kowloon, Hong Kong
Tel: 2737-7688

INDONESIA

PT. Yamaha Music Indonesia (Distributor)
PT. Nusantik
Gedung Yamaha Music Center, Jalan Jend. Gatot
Subroto Kav. 4, Jakarta 12930, Indonesia
Tel: 21-520-2577

KOREA

Yamaha Music Korea Ltd.
8F, 9F, Dongsung Bldg. 158-9 Samsung-Dong,
Kangnam-Gu, Seoul, Korea
Tel: 080-004-0022

MALAYSIA

Yamaha Music Malaysia, Sdn., Bhd.
Lot 8, Jalan Perbandaran, 47301 Kelana Jaya,
Petaling Jaya, Selangor, Malaysia
Tel: 3-78030900

PHILIPPINES

Yupangco Music Corporation
339 Gil J. Puyat Avenue, P.O. Box 885 MCPO,
Makati, Metro Manila, Philippines
Tel: 819-7551

SINGAPORE

Yamaha Music Asia Pte., Ltd.
#03-11 A-Z Building
140 Paya Lebar Road, Singapore 409015
Tel: 747-4374

TAIWAN

Yamaha KHS Music Co., Ltd.
3F, #6, Sec.2, Nan Jing E. Rd. Taipei.
Taiwan 104, R.O.C.
Tel: 02-2511-8688

THAILAND

Siam Music Yamaha Co., Ltd.
4, 6, 15 and 16th floor, Siam Motors Building,
891/1 Rama 1 Road, Wangmai,
Pathumwan, Bangkok 10330, Thailand
Tel: 02-215-2626

OTHER ASIAN COUNTRIES

Yamaha Corporation,
Asia-Pacific Music Marketing Group
Nakazawa-cho 10-1, Naka-ku, Hamamatsu,
Japan 430-8650
Tel: +81-53-460-2317

OCEANIA

AUSTRALIA

Yamaha Music Australia Pty. Ltd.
Level 1, 99 Queensbridge Street, Southbank,
Victoria 3006, Australia
Tel: 3-9693-5111

NEW ZEALAND

Music Works LTD
P.O.BOX 6246 Wellesley, Auckland 4680,
New Zealand
Tel: 9-634-0099

COUNTRIES AND TRUST TERRITORIES IN PACIFIC OCEAN

Yamaha Corporation,
Asia-Pacific Music Marketing Group
Nakazawa-cho 10-1, Naka-ku, Hamamatsu,
Japan 430-8650
Tel: +81-53-460-2312

HEAD OFFICE Yamaha Corporation, Pro Audio & Digital Musical Instrument Division
Nakazawa-cho 10-1, Naka-ku, Hamamatsu, Japan 430-8650
Tel: +81-53-460-3273



Yamaha Home Keyboards Home Page
<http://music.yamaha.com/homekeyboard/>
Yamaha Manual Library
<http://www.yamaha.co.jp/manual/>

U.R.G., Pro Audio & Digital Musical Instrument Division, Yamaha Corporation
© 2008 Yamaha Corporation

WN55250 XXXPOXXX.X-01A0
Printed in China