

YDP-123

Digital piano

Owner's Manual Bedienungsanleitung Mode d'emploi Manual de instrucciones

Before using the YDP-123, be sure to read "Precautions,, on pages 6-7.
Achten Sie darauf, vor Einsatz des YDP-123 die "Vorsichtsmassnahmen,, auf Seite 6-7 durchzulesen.

Avant d'utiliser le YDP-123, lire attentivement la section «Precautions d'usage» aux pages 6-7.

Antes de utilizar el YDP-123, lea las "Precauciones,, que debe tener en cuenta en las páginas 6-7.

IMPORTANT

Check your power supply

Make sure that your local AC mains voltage matches the voltage specified on the name plate on the bottom panel. In some areas a voltage selector may be provided on the bottom panel of the main keyboard unit near the power cord. Make sure that the voltage selector is set for the voltage in your area. The voltage selector is set at 240V when the unit is initially shipped. To change the setting use a "minus" screwdriver to rotate the selector dial so that the correct voltage appears next to the pointer on the panel.

WICHTIG

Überprüfung der Stromversorgung

Vergewissern Sie sich vor dem Anschließen an das Stromnetz, daß die örtliche Netzspannung den Betriebsspannungswerten auf dem Typenschild an der Unterseite des Instruments entspricht. In bestimmten Verkaufsgebieten ist das Instrument mit einem Spannungswähler an der Unterseite neben der Netzkabeldurchführung ausgestattet. Falls vorhanden, muß der Spannungswähler auf die örtliche Netzspannung eingestellt werden. Der Spannungswähler wurde werkseitig auf 240 V voreingestellt. Zum Verstellen drehen Sie den Spannungsregler mit einem Schlitzschraubendreher, bis der Zeiger auf den korrekten Spannungswert weist.

IMPORTANT

Contrôler la source d'alimentation

Vérifiez que la tension spécifiée sur le panneau inférieur correspond à la tension du secteur. Dans certaines régions, l'instrument peut être équipé d'un sélecteur de tension situé sur le panneau inférieur du clavier à proximité du cordon d'alimentation.

Vérifiez que ce sélecteur est bien réglé en fonction de la tension secteur de votre région. Le sélecteur de tension est réglé sur 240 V au départ d'usine. Pour modifier ce réglage, utilisez un tournevis à lame plate pour tourner le sélecteur afin de mettre l'indication correspondant à la tension de votre région vis à vis du repère triangulaire situé sur le panneau.

IMPORTANTE

Verifique la alimentación de corriente

Asegúrese de que tensión de alimentación de CA de su área corresponde con la tensión especificada en la placa de características del panel inferior. En algunas zonas puede haberse incorporado un selector de tensión en el panel inferior de la unidad del teclado principal, cerca del cable de alimentación. Asegúrese de que el selector de tensión esté ajustado a la tensión de su área. El selector de tensión se ajusta a 240V cuando la unidad sale de fábrica. Para cambiar el ajuste, emplee un destornillador de cabeza "recta" para girar el selector de modo que aparezca la tensión correcta al lado del indicador del panel.

ENGLISH

DEUTSCH

FRANÇAIS

ESPAÑOL

SPECIAL MESSAGE SECTION

PRODUCT SAFETY MARKINGS: Yamaha electronic products may have either labels similar to the graphics shown below or molded/stamped facsimiles of these graphics on the enclosure. The explanation of these graphics appears on this page. Please observe all cautions indicated on this page and those indicated in the safety instruction section.

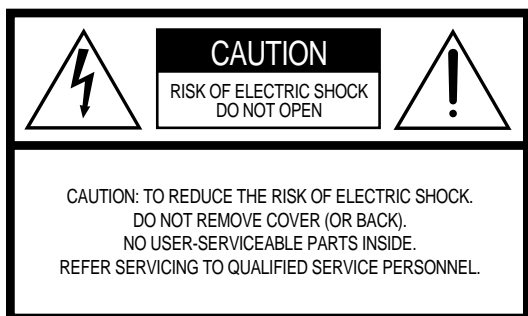

See bottom of Keyboard enclosure for graphic symbol markings.



The exclamation point within the equilateral triangle is intended to alert the user to the presence of important operating and maintenance (servicing) instructions in the literature accompanying the product.

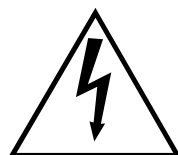

The lightning flash with arrowhead symbol, within the equilateral triangle, is intended to alert the user to the presence of uninsulated “dangerous voltage” within the product’s enclosure that may be of sufficient magnitude to constitute a risk of electrical shock.

IMPORTANT NOTICE: All Yamaha electronic products are tested and approved by an independent safety testing laboratory in order that you may be sure that when it is properly installed and used in its normal and customary manner, all foreseeable risks have been eliminated. DO NOT modify this unit or commission others to do so unless specifically authorized by Yamaha. Product performance and/or safety standards may be diminished. Claims filed under the expressed warranty may be denied if the unit is/has been modified. Implied warranties may also be affected.

SPECIFICATIONS SUBJECT TO CHANGE: The information contained in this manual is believed to be correct at the time of printing. However, Yamaha reserves the right to change or modify any of the specifications without notice or obligation to update existing units.

ENVIRONMENTAL ISSUES: Yamaha strives to produce products that are both user safe and environmentally friendly. We sincerely believe that our products and the production methods used to produce them, meet these goals. In keeping with both the letter and the spirit of the law, we want you to be aware of the following:

Battery Notice: This product MAY contain a small non-rechargeable battery which (if applicable) is soldered in place. The average life span of this type of battery is approximately five years. When replacement becomes necessary, contact a qualified service representative to perform the replacement.

Warning: Do not attempt to recharge, disassemble, or incinerate this type of battery. Keep all batteries away from children. Dispose of used batteries promptly and as regulated by applicable laws. Note: In some areas, the servicer is required by law to return the defective parts. However, you do have the option of having the servicer dispose of these parts for you.

Disposal Notice: Should this product become damaged beyond repair, or for some reason its useful life is considered to be at an end, please observe all local, state, and federal regulations that relate to the disposal of products that contain lead, batteries, plastics, etc.

NOTICE: Service charges incurred due to lack of knowledge relating to how a function or effect works (when the unit is operating as designed) are not covered by the manufacturer’s warranty, and are therefore the owners responsibility. Please study this manual carefully and consult your dealer before requesting service.

NAME PLATE LOCATION: The graphic below indicates the location of the name plate. The model number, serial number, power requirements, etc., are located on this plate. You should record the model number, serial number, and the date of purchase in the spaces provided below and retain this manual as a permanent record of your purchase.

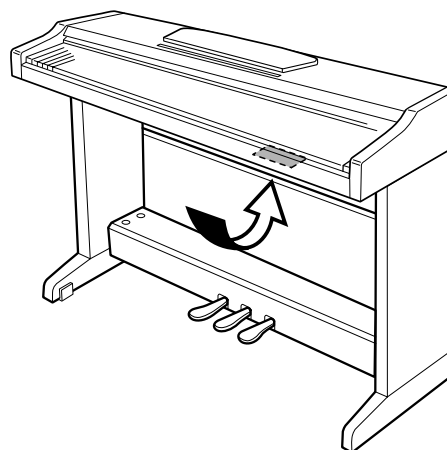

Model _____

Serial No. _____

Purchase Date _____

Thank you for purchasing the Yamaha YDP-123 Digital Piano! We recommend that you read this manual carefully so that you can fully take advantage of the advanced and convenient functions of the YDP-123.

We also recommend that you keep this manual in a safe and handy place for future reference.

About this Owner's Manual

This manual consists of three main sections: "Introduction," "Reference" and "Appendix."

■ Introduction (page 2):

Please read this section first.

■ Reference (page 13):

This section explains how to make detailed settings for the YDP-123's various functions.

■ Appendix (page 33):

This section introduces reference material.

- * The illustrations of the controls in this owner's manual are for instructional purposes only and actual appearance of the controls may be somewhat different on your instrument.

COPYRIGHT NOTICE

This product incorporates and bundles computer programs and contents in which Yamaha owns copyrights or with respect to which it has license to use others' copyrights. Such copyrighted materials include, without limitation, all computer software, MIDI files and WAVE data. Any unauthorized use of such programs and contents outside of personal use is not permitted under relevant laws. Any violation of copyright has legal consequences. DON'T MAKE, DISTRIBUTE OR USE ILLEGAL COPIES.

Trademarks:

- Apple and Macintosh are trademarks of Apple Computer, Inc.
- Windows is a registered trademark of Microsoft® Corporation.
- All other trademarks are the property of their respective holders.

Table of Contents

Introduction

SPECIAL MESSAGE SECTION	2
About this Owner's Manual	3
Application Index.....	5
PRECAUTIONS.....	6
Accessories	8
Maintenance	8
Features.....	9
Before Using the YDP-123	10
Key Cover	10
Music Rest	10
Turning the Power On.....	11
Setting the Volume.....	11
Using Headphones.....	12

Reference

Part Names.....	14
Listening to the Demo Songs	15
Listening to 50 Piano Preset Songs	16
Selecting & Playing Voices.....	17
Selecting Voices.....	17
Using the Pedals	17
Adding Variations to the Sound – Reverb.....	18
Combining Two Voices (Dual mode).....	19
Transposition	20
Fine-tuning the Pitch	20
Using the Metronome.....	21
About MIDI	23
Connecting a Personal Computer	24
MIDI Functions.....	26
MIDI Transmit/Receive Channel Selection.....	26
Local Control ON/OFF.....	26
Program Change ON/OFF.....	27
Control Change ON/OFF	27
Troubleshooting	28
Options & Expander Modules	28
Keyboard Stand Assembly	29
Index	32

Appendix

MIDI Data Format / MIDI-Datenformat / Format des données MIDI / Formato de datos MIDI	34
MIDI Implementation Chart	38
Specifications / Technische Daten / Caractéristiques techniques / Especificaciones	39

Application Index

Use this index to find reference pages that may be helpful for your particular application and situation.

Listening

- Listening to demo songs with different voices..... “Listening to the Demo Songs” on page 15
Listening to songs from “50 Greats for the Piano” “Listening to 50 Piano Preset Songs” on page 16

Playing

- Using three pedals “Using the Pedals” on page 17
Playing an accompaniment that matches pitch “Transposition” on page 20
Fine-tuning the pitch of the entire instrument when you play the YDP-123
along with other instruments or CD music..... “Fine-tuning the Pitch” on page 20

Changing voices

- Viewing the list of voices..... “Selecting Voices” on page 17
Simulating a concert hall “Adding Variations to the Sound – Reverb” on page 18
Combining two voices..... “Combining Two Voices (Dual mode)” on page 19

Practicing

- Practicing with an accurate and steady tempo “Using the Metronome” on page 21

Connecting the YDP-123 to other devices

- What is MIDI? “About MIDI” on page 23
Connecting the computer “Connecting a Personal Computer” on page 24

Assembling

- Assembling and disassembling the YDP-123 “Keyboard Stand Assembly” on pages 29–31

PRECAUTIONS

PLEASE READ CAREFULLY BEFORE PROCEEDING

* Please keep this manual in a safe place for future reference.



WARNING

Always follow the basic precautions listed below to avoid the possibility of serious injury or even death from electrical shock, short-circuiting, damages, fire or other hazards. These precautions include, but are not limited to, the following:

Power supply/Power cord

- Only use the voltage specified as correct for the instrument. The required voltage is printed on the name plate of the instrument.
- Check the electric plug periodically and remove any dirt or dust which may have accumulated on it.
- Use only the supplied power cord/plug.
- Do not place the power cord near heat sources such as heaters or radiators, and do not excessively bend or otherwise damage the cord, place heavy objects on it, or place it in a position where anyone could walk on, trip over, or roll anything over it.

Do not open

- Do not open the instrument or attempt to disassemble the internal parts or modify them in any way. The instrument contains no user-serviceable parts. If it should appear to be malfunctioning, discontinue use immediately and have it inspected by qualified Yamaha service personnel.

Water warning

- Do not expose the instrument to rain, use it near water or in damp or wet conditions, or place containers on it containing liquids which might spill into any openings.
- Never insert or remove an electric plug with wet hands.

Fire warning

- Do not put burning items, such as candles, on the unit. A burning item may fall over and cause a fire.

If you notice any abnormality

- If the power cord or plug becomes frayed or damaged, or if there is a sudden loss of sound during use of the instrument, or if any unusual smells or smoke should appear to be caused by it, immediately turn off the power switch, disconnect the electric plug from the outlet, and have the instrument inspected by qualified Yamaha service personnel.



CAUTION

Always follow the basic precautions listed below to avoid the possibility of physical injury to you or others, or damage to the instrument or other property. These precautions include, but are not limited to, the following:

Power supply/Power cord

- When removing the electric plug from the instrument or an outlet, always hold the plug itself and not the cord. Pulling by the cord can damage it.
- Remove the electric plug from the outlet when the instrument is not to be used for extended periods of time, or during electrical storms.
- Do not connect the instrument to an electrical outlet using a multiple-connector. Doing so can result in lower sound quality, or possibly cause overheating in the outlet.

Assembly

- Read carefully the attached documentation explaining the assembly process. Failure to assemble the instrument in the proper sequence might result in damage to the instrument or even injury.

Location

- Do not expose the instrument to excessive dust or vibrations, or extreme cold or heat (such as in direct sunlight, near a heater, or in a car during the day) to prevent the possibility of panel disfiguration or damage to the internal components.
- Do not use the instrument in the vicinity of a TV, radio, stereo equipment, mobile phone, or other electric devices. Otherwise, the instrument, TV, or radio may generate noise.
- Do not place the instrument in an unstable position where it might accidentally fall over.
- Before moving the instrument, remove all connected cables.
- Do not place the instrument against a wall (allow at least 3 cm/ one-inch from the wall), since this can cause inadequate air circulation, and possibly result in the instrument overheating.

Connections

- Before connecting the instrument to other electronic components, turn off the power for all components. Before turning the power on or off for all components, set all volume levels to minimum. Also, be sure to set the volumes of all components at their minimum levels and gradually raise the volume controls while playing the instrument to set the desired listening level.

Maintenance

- When cleaning the instrument, use a soft, dry or slightly damp cloth. Do not use paint thinners, solvents, cleaning fluids, or chemical-impregnated wiping cloths.

Handling caution

- Take care that the key cover does not pinch your fingers, and do not insert a finger or hand in any gaps on the key cover or instrument.
- Never insert or drop paper, metallic, or other objects into the gaps on the key cover, panel or keyboard. If this happens, turn off the power immediately and unplug the power cord from the AC outlet. Then have the instrument inspected by qualified Yamaha service personnel.
- Do not place vinyl, plastic or rubber objects on the instrument, since this might discolor the panel or keyboard.
- Do not rest your weight on, or place heavy objects on the instrument, and do not use excessive force on the buttons, switches or connectors.
- Do not operate the instrument for a long period of time at a high or uncomfortable volume level, since this can cause permanent hearing loss. If you experience any hearing loss or ringing in the ears, consult a physician.

Using the bench (If included)

- Do not place the bench in an unstable position where it might accidentally fall over.
- Do not play carelessly with or stand on the bench. Using it as a tool or step-ladder or for any other purpose might result in accident or injury.
- Only one person should sit on the bench at a time, in order to prevent the possibility of accident or injury.
- If the bench screws become loose due to extensive long-term use, tighten them periodically using the included tool.

Yamaha cannot be held responsible for damage caused by improper use or modifications to the instrument, or data that is lost or destroyed.

Always turn the power off when the instrument is not in use.

Accessories

- “50 Greats for the Piano” (Music Book)
- Owner’s Manual
This manual contains complete instructions for operating your YDP-123.
- Quick Operation Guide
- Bench
A bench may be included or optional, depending on your locale.

Maintenance

Clean the instrument using a dry or slightly damp soft cloth (wring well).

CAUTION

Do not use benzene, thinner, detergent, or chemically-treated cloth for cleaning. Do not place vinyl, plastic or rubber products on the instrument.

Otherwise, the panel or keys may become discolored or degraded.

CAUTION

Before using the YDP-123, be sure to read “Precautions” on pages 6 – 7.

■ **Tuning**

Unlike an acoustic piano, the YDP-123 does not need to be tuned. It always stays perfectly in tune.

■ **Transporting**

If you move to another location, you can transport the YDP-123 along with your other belongings. You can move the unit as it is (assembled) or you can disassemble the unit before moving.

Transport the keyboard horizontally. Do not lean it up against a wall or stand it up on its side. Do not subject the instrument to excessive vibration or shock.

Features

The Yamaha YDP-123 digital piano offers unmatched sonic realism and natural grand-piano type playability as well as Yamaha's original "AWM Stereo Sampling" tone-generation technology for rich, musical voices, and a special "Graded Hammer" keyboard that provides graded key weight and response throughout the keyboard range.

The Grand Piano 1 and 2 voices feature totally new samples painstakingly recorded from a full concert grand piano. The E. Piano 1 voice features a single velocity-switched sample (Dynamic Sampling) and E. Piano 2 voice features two velocity-switched sample.

The YDP-123 sounds much closer to a true acoustic piano.

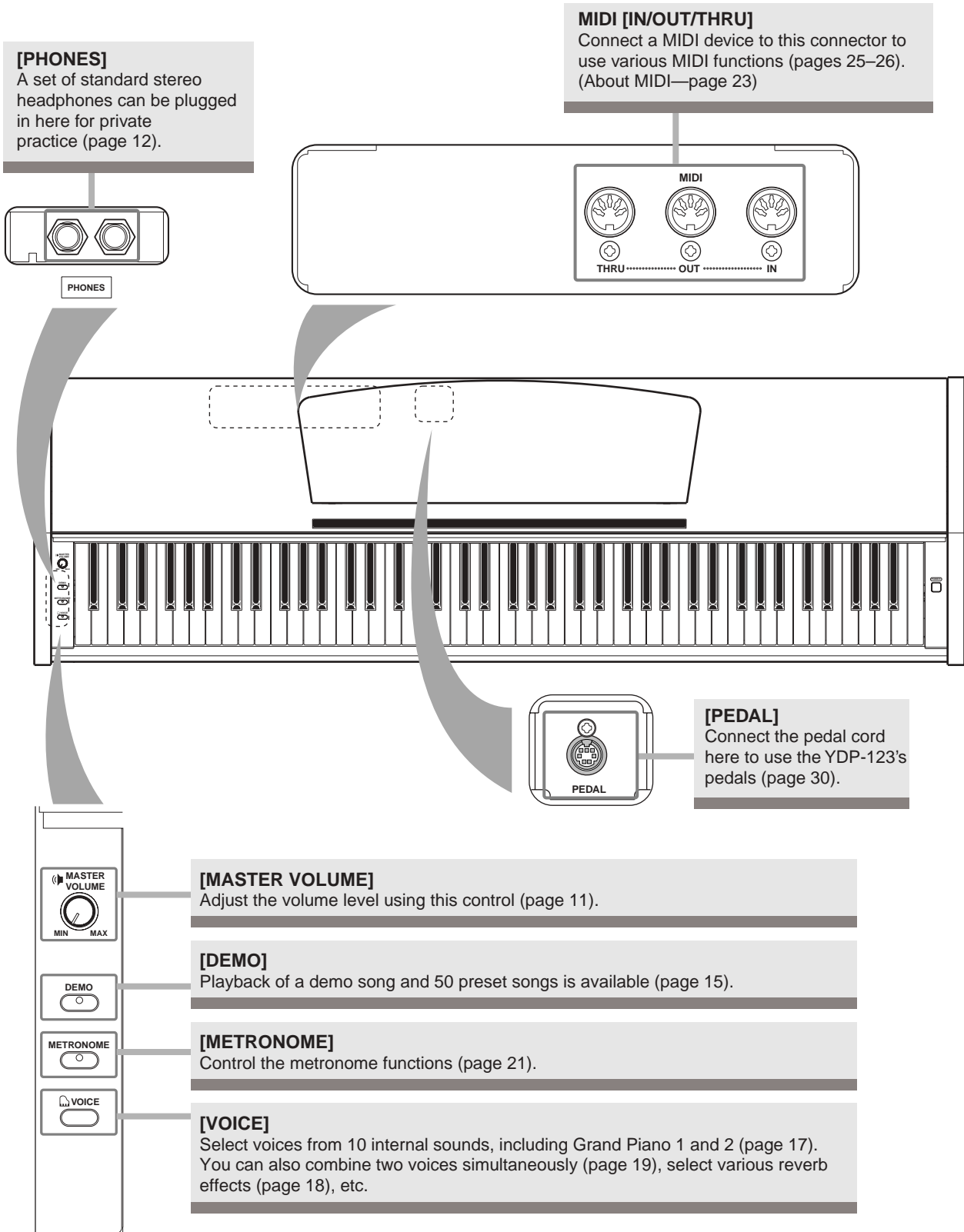

Before Using the YDP-123

Key Cover

To open the key cover:

Lift the cover slightly, then push and slide it open.

To close the key cover:

Slide the cover toward you and gently lower the cover over the keys.

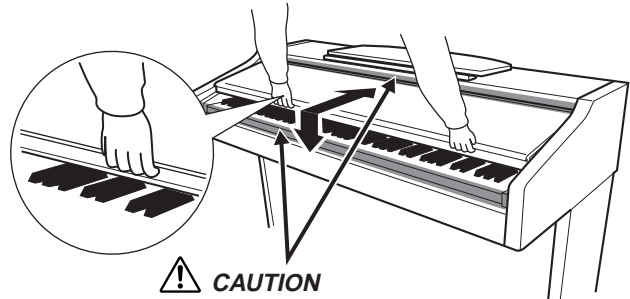

⚠ CAUTION

Be careful to avoid catching your fingers when opening or closing the cover.

⚠ CAUTION

Hold the cover with both hands when opening or closing it. Do not release it until it is fully opened or closed. Be careful to avoid catching fingers (yours or others, especially children's) between the cover and main unit.

⚠ CAUTION

Do not place objects, such as a piece of metal or paper, on top of the key cover. Small objects placed on the key cover may fall inside the unit when the cover is opened and may be nearly impossible to remove. This could cause electric shock, short circuit, fire or other serious damage to the instrument.

Music Rest

To raise the music rest:

1. Pull the music rest up and toward yourself as far as it will go.
2. Flip down the two metal supports at the left and right on the rear of the music rest.
3. Lower the music rest so that it rests on the metal supports.

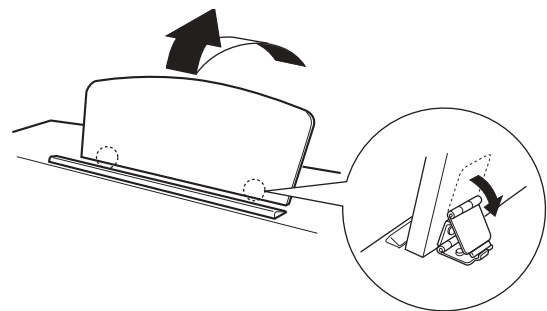

To lower the music rest:

1. Pull the music rest toward yourself as far as it will go.
2. Raise the two metal supports (at the rear of the music rest).
3. Gently lower the music rest backward until it is all the way down.

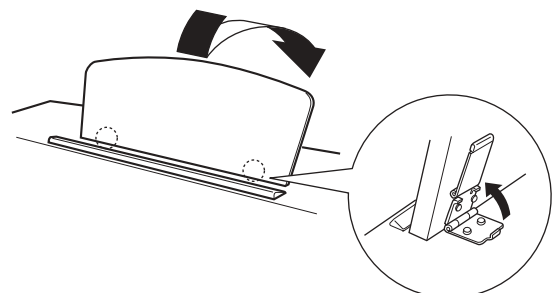

⚠ CAUTION

Do not try to use the music rest in a half-raised position. When lowering the music rest, do not release your hands from the music rest until it is all the way down.

Turning the Power On

1. Connect the power cord.

Insert the plugs at the ends of the cord: one into the AC INLET on the YDP-123, and the other into a standard AC outlet.

In some areas, a plug adaptor may be provided to match the pin configuration of AC wall outlets in your area.

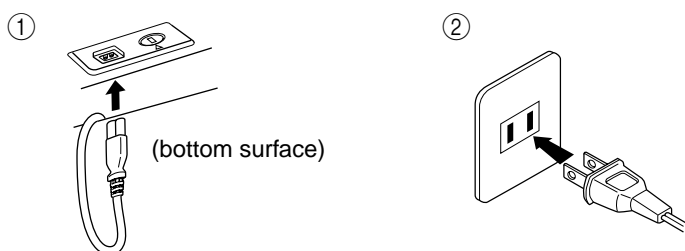

(The shape of the plug differs depending on locale.)

2. Turn the power on.

Press the **[POWER]** button.

- The power indicator located below the left end of the keyboard lights up.

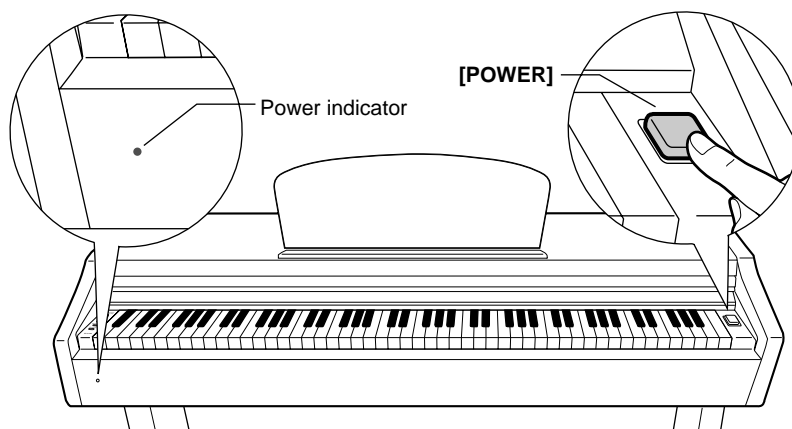

When you're ready to turn off the power, press the **[POWER]** button again.

- The power indicator turns off.

TIP

Power indicator

If you close the key cover without turning the power off, the power indicator remains lit, indicating that the power is still on.

Setting the Volume

When you start playing, adjust the **[MASTER VOLUME]** control to the most comfortable listening level.



CAUTION

Do not use the YDP-123 at a high volume level for a long period of time, or your hearing may be damaged.

TERMINOLOGY

MASTER VOLUME:

The volume level of the entire keyboard sound

TIP

You can also adjust the **[PHONES]** output level using the **[MASTER VOLUME]** control.

Using Headphones

Connect a pair of headphones to one of the [PHONES] jacks.

Two [PHONES] jacks are provided.

You can connect two sets of standard stereo headphones. (If you are using only one pair of headphones, you can plug them into either jack.)

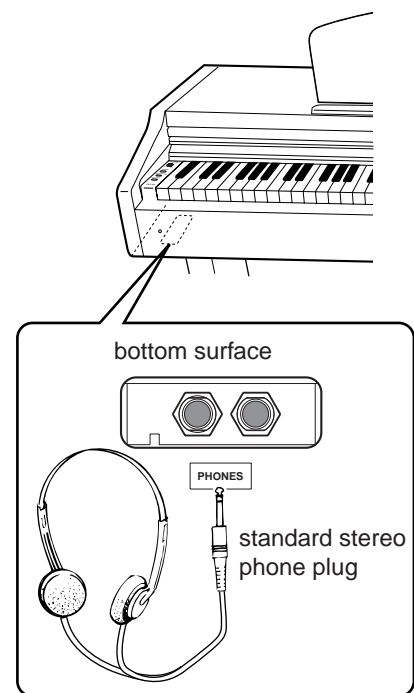

Using the Headphone Hanger

A headphone hanger is included in the YDP-123 package so that you can hang the headphones on the YDP-123. Install the headphone hanger using the included two screws ($4 \times 10\text{mm}$) as shown in the figure.

CAUTION

Do not hang anything other than the headphones on the hanger. Otherwise, the YDP-123 or the hanger may be damaged.

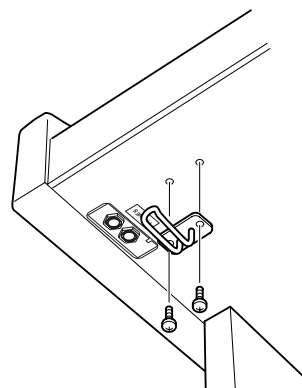

Reference

This section explains how to make detailed settings for the YDP-123's various functions.

Part Names.....	14
Listening to the Demo Songs.....	15
Listening to 50 Piano Preset Songs.....	16
Selecting & Playing Voices	17
Selecting Voices	17
Using the Pedals	17
Adding Variations to the Sound – Reverb.....	18
Combining Two Voices (Dual mode).....	19
Transposition.....	20
Fine-tuning the Pitch	20
Using the Metronome.....	21
About MIDI.....	23
Connecting a Personal Computer	24
MIDI Functions.....	26
MIDI Transmit/Receive Channel Selection	26
Local Control ON/OFF.....	26
Program Change ON/OFF	27
Control Change ON/OFF	27
Troubleshooting	28
Options & Expander Modules	28
Keyboard Stand Assembly.....	29
Index	32

Part Names

Top panel

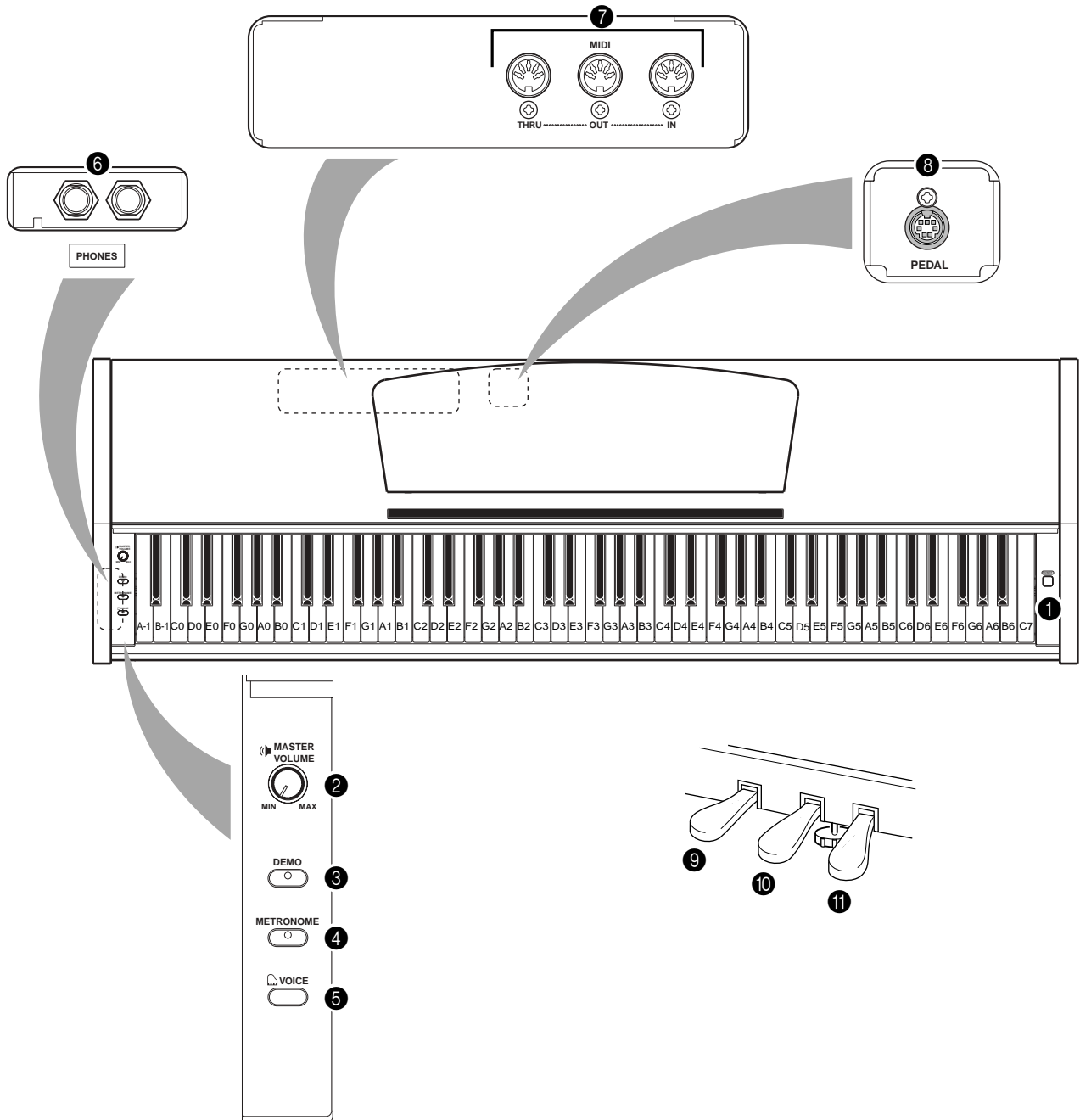

- ❶ [POWER] P11
- ❷ [MASTER VOLUME] P11
- ❸ [DEMO] P15
- ❹ [METRONOME]..... P21
- ❺ [VOICE].....P17–19
- ❻ [PHONES] P12
- ❼ MIDI [IN] [OUT] [THRU]..... P23

- ❽ [PEDAL]..... P30
- ❾ Soft (Left) Pedal P18
- ❿ Sostenute (Center) Pedal..... P18
- ⓫ Damper (Right) Pedal P17

Listening to the Demo Songs

Demo songs are provided that effectively demonstrate each of the YDP-123's voices.

Procedure

1. Turn on the power.

(In case the power is not turned ON) Press the [POWER] button.

When you start playing, adjust the [MASTER VOLUME] control to the most comfortable listening level.

2. Engage Demo mode.

Press the [DEMO] button to engage Demo mode. The [DEMO] button indicator will light.

3. Play a Voice demo.

While holding down the [DEMO] button, press one of the C1–A1 keys to select and start the corresponding demo song. Starting with the selected tune, the demo songs will play in sequence until stopped.

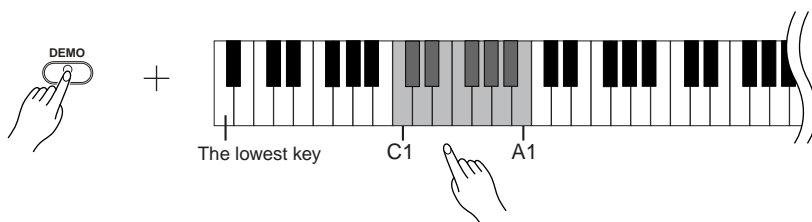

Demo Song List

Demo songs are original (©2002 Yamaha Corporation) except for the three songs listed below.

Refer to the voice list on page 17 for voice key assignments.

The demo songs listed below are short re-arranged excerpts from the original compositions.

Key	Voice Name	Title	Composer
C1	GrandPiano1	Consolation No.3	F. Liszt
E1	Harpsichord1	Gavotte	J.S. Bach
F1	Harpsichord2	Invention No.1	J.S. Bach

Adjusting the Volume

Use the [MASTER VOLUME] control to adjust the volume.

4. Stop the Voice demo.

Press the [DEMO] button to stop playback.

NOTE

Refer to the voice list on page 17 for more information on the characteristics of each pre-set voice.

TERMINOLOGY

Mode:

A mode is a condition or status under which you can execute a certain function. In Demo mode, you can play back demo songs.

NOTE

You cannot adjust the tempo of demo songs.

Listening to 50 Piano Preset Songs

The YDP-123 provides performance data for 50 piano songs. You can simply listen to these songs. You can also refer to the included "50 Greats for the Piano" that contains scores for 50 piano preset songs.

Procedure

1. Engage Preset Song mode.

Press the [DEMO] button to engage Preset Song mode. The [DEMO] button indicator will light.

2. Play a preset song.

While holding down the [DEMO] button, press one of the C2–C#6 keys to select and start the corresponding tune. To play all preset songs in sequence, while holding down the [DEMO] button, press the D6 key.

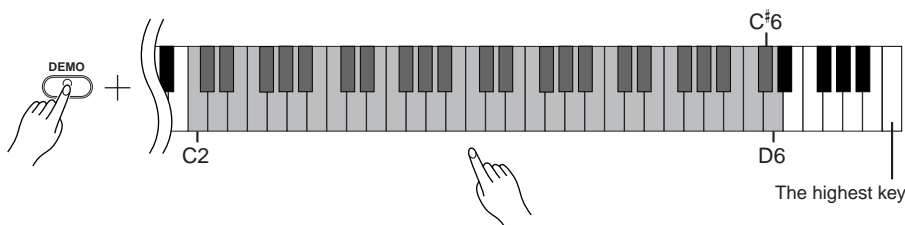

Adjusting the Volume

Use the [MASTER VOLUME] control to adjust the volume.

3. Stop playback.

Playback will stop automatically when the selected preset song has finished. To stop the song during playback (or continuous playback), press the [DEMO] button.

- To continue playing other songs, see procedure 2 above.

TERMINOLOGY

Song:

On the YDP-123, performance data is called a "Song." This includes demo songs and piano preset tunes.

TIP

You can play the keyboard along with the preset song. You can change the voice playing on the keyboard.

TIP

You can adjust the Reverb type (page 18) that is applied to the voice you play on the keyboard and to the preset song playback.

NOTE

The default tempo is automatically selected whenever a new preset song is selected, and when a new preset song begins playback.

NOTE

To adjust the tempo of the preset song playback, see page 21.

NOTE

When you select a different song (or a different song is selected during chained playback), an appropriate reverb type will be selected accordingly.

NOTE

MIDI reception is not possible in Piano Song mode. Piano song data is not transmitted via the MIDI connectors.

Selecting & Playing Voices

Selecting Voices

Procedure

While holding down the [VOICE] button, press one of the C1–A1 keys to select and start the corresponding voice.

Then, when you start playing, adjust the [MASTER VOLUME] control to the most comfortable listening level.

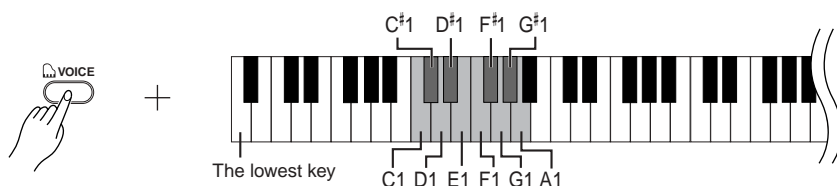

Key	Voice Name	Description
C1	Grand Piano 1	Recorded samples from a full concert grand piano. Perfect for classical compositions as well as any other style that requires acoustic piano.
C#1	Grand Piano 2	Spacious and clear piano with bright reverb. Good for popular music.
D1	E.Piano 1	An electronic piano sound created by FM synthesis. Good for popular music.
D#1	E.Piano 2	The sound of an electric piano using hammer-struck metallic "tines." Soft tone when played lightly, and an aggressive tone when played hard.
E1	Harpsichord 1	The definitive instrument for baroque music. Since harpsichord uses plucked strings, there is no touch response.
F1	Harpsichord 2	Mixes the same voice an octave higher for a more brilliant tone.
F#1	Vibraphone	Vibraphone played with relatively soft mallets. It has a tremolo effect that is typical for vibraphone.
G1	Church Organ 1	This is a typical pipe organ sound (8 feet + 4 feet + 2 feet). Good for sacred music from the Baroque period.
G#1	Church Organ 2	This is the organ's full coupler sound, often associated with Bach's "Toccatina and Fugue".
A1	Strings	Spacious and large-scale string ensemble. Try combining this voice with piano in DUAL mode.

Using the Pedals

Damper (Right) Pedal

The damper pedal functions in the same way as a damper pedal on an acoustic piano. When the damper pedal is pressed, notes sustain longer. Releasing the pedal immediately stops (damps) any sustained notes.

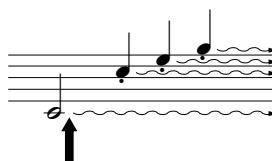

When you press the damper pedal here, the notes you play before you release the pedal sustain longer.

TIP

To understand the characteristics of various voices, listen to demo songs for each voice (page 15).

TERMINOLOGY

Voice:
On the YDP-123, a voice means a "tone" or "tonal color."

NOTE

Selecting a voice automatically engages the best-suited reverb type and depth (page 18) for that particular voice.

NOTE

If the damper pedal doesn't work, make sure that the pedal cord is properly plugged into the main unit (page 30).

Sostenuto (Center) Pedal

If you play a note or chord on the keyboard and press the sostenuto pedal while the note(s) are held, those notes will sustain as long as you hold the pedal (as if the damper pedal had been pressed) but all subsequently played notes will not be sustained. This makes it possible to sustain a chord, for example, while other notes are played “staccato.”

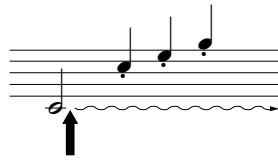

When you press the sostenuto pedal here while holding the note, the note will sustain as long as you hold the pedal.

Soft (Left) Pedal

The soft pedal reduces the volume and slightly changes the timbre of notes played while the pedal is pressed. The soft pedal will not affect notes that are already playing when it is pressed.

Adding Variations to the Sound – Reverb

This control enables you to select various digital reverb effects that add extra depth and expression to the sound to create a realistic acoustic ambience.

Procedure

When you select a reverb, the reverb is automatically turned on. While holding down the [VOICE] button, press one of the C2–E2 keys to select a reverb type.

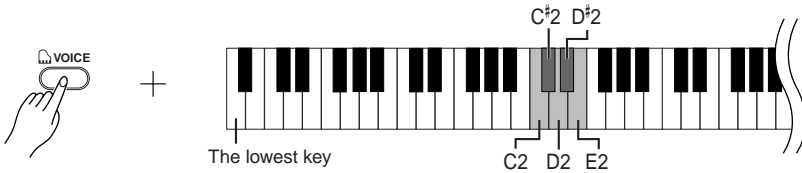

Key	Reverb Type	Description
C2	Room	This setting adds a continuous reverb effect to the sound, similar to the acoustic reverberation you would hear in a room.
C#2	Hall1	For a “bigger” reverb sound, use the HALL 1 setting. This effect simulates the natural reverberation of a small-size concert hall.
D2	Hall2	For a truly spacious reverb sound, use the HALL 2 setting. This effect simulates the natural reverberation of a large concert hall.
D#2	Stage	Simulates the reverb of a stage environment.
E2	Off	No effect is applied.

Adjusting Reverb Depth

Adjust the reverb depth for the selected voice by pressing one of the C3–G#4 keys while holding down the [VOICE] button. The depth range is from 0 through 20.

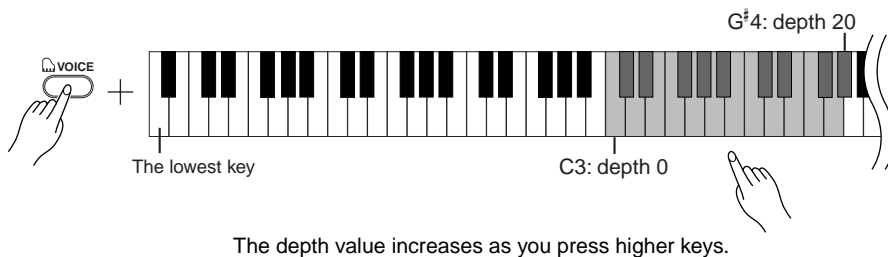

TIP

The default reverb type (including OFF) and depth settings are different for each voice.

TIP

depth 0: no effect
depth 20: maximum reverb depth

Combining Two Voices (Dual mode)

You can play two voices simultaneously across the entire range of the keyboard. In this way, you can simulate a melody duet or combine two similar voices to create a thicker sound.

Procedure

1. Engage Dual mode.

While holding down the [VOICE] button, press two of the C1–A1 keys at simultaneously (or press one key while holding another). Refer to the voice list on page 17 for available voices.

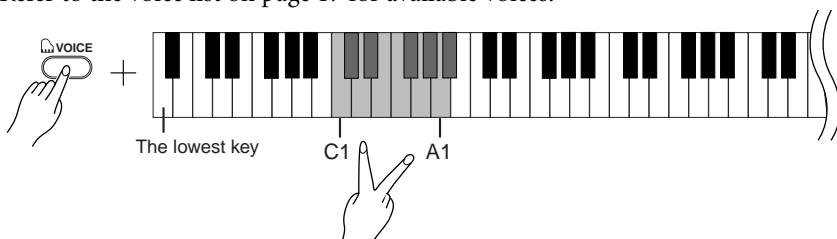

According to the voice priority shown in the voice list (page 17), the voice assigned to the lower keyboard will be designated as Voice 1 (the other voice will be designated as Voice 2).

You can make the following settings only in Dual mode:

Setting the Octave

You can shift the pitch up and down in octave steps for Voice 1 and Voice 2 independently. Depending on which voices you combine in Dual mode, the combination may sound better if one of the voices is shifted up or down an octave.

While holding down the [VOICE] button, press one of the C5–F5 keys.

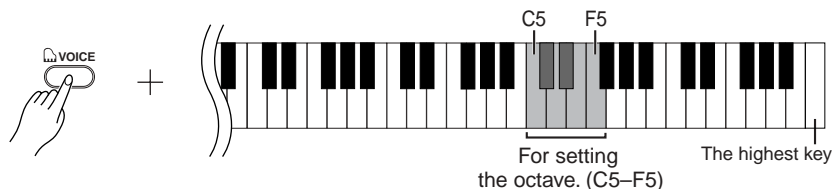

C5 key: -1 (Voice 1), C#5 key: 0 (Voice 1), D5 key: +1 (Voice 1),
D#5 key: -1 (Voice 2), E5 key: 0 (Voice 2), F5 key: +1 (Voice 2)

Setting the Balance

You can set one voice as the main voice, and another voice as a softer, mixed voice.

While holding down the [VOICE] button, press one of the F#5–F#6 keys.

A setting of “0” produces an equal balance between the two Dual mode voices. Settings below “0” increases the volume of Voice 2 in relation to Voice 1, and settings above “0” increases the volume of Voice 1 in relation to Voice 2.

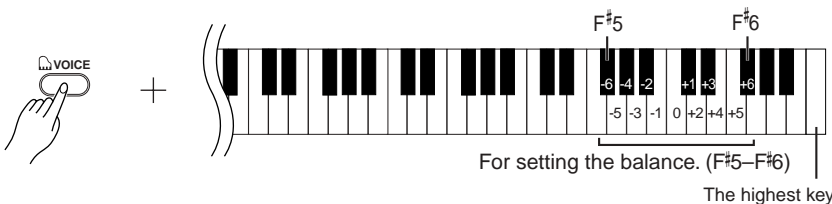

NOTE

You cannot assign the same voice to Voice 1 and Voice 2 simultaneously in Dual mode.

TIP

Reverb in Dual Mode

The reverb type assigned to Voice 1 will take priority over the other. (If the reverb is set to OFF, Voice 2 reverb type will be in effect.) Reverb depth setting (page 18) will be applied only to Voice 1.

2. Exit Dual mode and return to normal play mode.

While holding down the [VOICE] button, press one of the C1–A1 keys.

Transposition

The YDP-123's Transpose function makes it possible to shift the pitch of the entire keyboard up or down in semitone intervals up to a maximum of six semitones, and lets you easily match the pitch of the keyboard to the range of a singer or other instruments.

For example, if you set the transposition amount to "5," playing key C produces pitch F. In this way, you can play a song as though it were in C major, and the YDP-123 will transpose it to the key of F.

Procedure

While holding down the A-1 and C#0 keys, press one of the F#2-F#3 keys to set the desired amount of transposition.

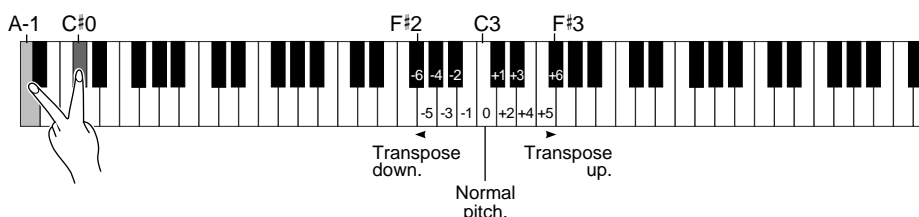

Pressing the C3 key produces normal keyboard pitch. Pressing the key to the left of C3 (=B2) transposes the pitch of the keyboard down a semitone, the next key to the left (=Bb2) transposes down a whole tone (two semitones), etc., down to the F#2 key, which transposes down six semitones. Upward transposition is accomplished in the same way using the keys to the right of C3, up to F#3, which transposes up six semitones.

TERMINOLOGY

Transpose:

Changing the key signature of a song. On the YDP-123, transposing shifts the pitch of the entire keyboard.

TIP

Notes below and above the A-1 ... C7 range of the YDP-123 sound one octave higher and lower, respectively.

Fine-tuning the Pitch

You can fine-tune the pitch of the entire instrument. This function is useful when you play the YDP-123 along with other instruments or CD music.

Procedure

To tune up (in about 0.2Hz steps):

Hold down the A-1 and B-1 keys simultaneously and press any key between C3 and B3.

To tune down (in about 0.2Hz steps):

Hold down the A-1 and A#-1 keys simultaneously and press any key between C3 and B3.

To restore standard pitch:

Hold down the A-1, A#-1 and B-1 simultaneously and press any key between C3 and B3.

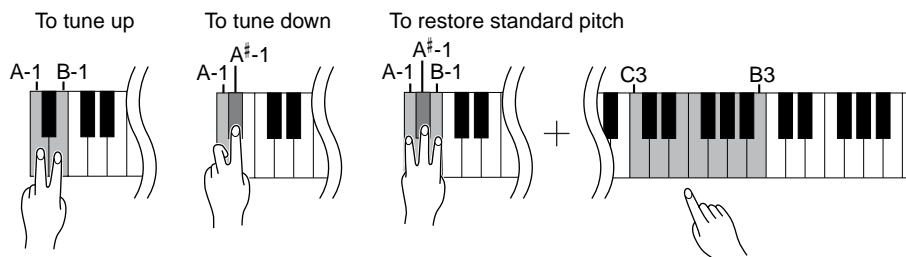

Setting range: 427.0-453.0 Hz

Standard pitch: 440.0 Hz

TERMINOLOGY

Hz (Hertz):

This unit of measurement refers to the frequency of a sound and represents the number of times a sound wave vibrates in a second.

Using the Metronome

The YDP-123 features a built-in metronome (a device that keeps an accurate tempo) that is convenient for practicing.

Procedure

1. Start the metronome.

Press the [METRONOME] button to turn on the metronome.

Determines the time signature

While holding down the [METRONOME] button, press one of the C3–F3 keys.

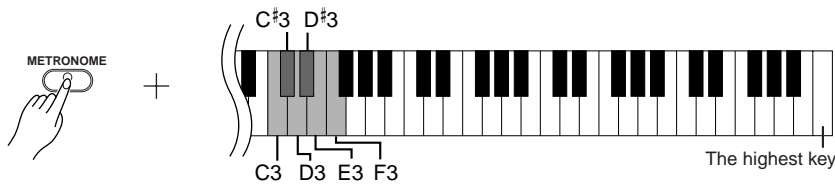

C3 key: No downbeat, C#3 key: 2/4, D3 key: 3/4, D#3 key: 4/4, E3 key: 5/4, F3 key: 6/4

Adjusting the tempo

The tempo of the metronome and preset song playback can be set from 32 to 280 beats per minute.

While holding down the [METRONOME] button, press a sequence of C4–A4 keys to specify a three-digit number.

Select a number starting from the left-most digit. For example, to set the tempo “95,” press the C4 (0), A4 (9) and F4 (5) keys in sequence.

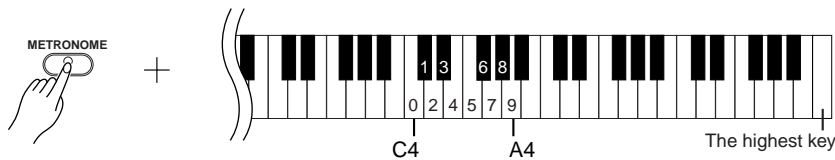

To increase the tempo value in steps of one, while holding down the [METRONOME] button, press the C#5 key. To decrease the tempo value in steps of one, while holding down the [METRONOME] button, press the B4 key.

To increase the tempo value in steps of ten, while holding down the [METRONOME] button, press the D5 key. To decrease the tempo value in steps of ten, while holding down the [METRONOME] button, press the A#4 key.

To set the default tempo (the metronome’s original tempo or the song’s original tempo), while holding down the [METRONOME] button, press the C5 key.

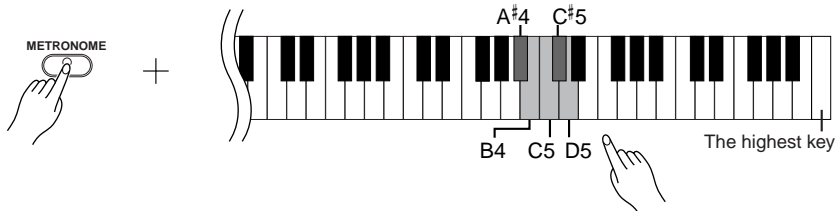

NOTE

During preset song playback, you can set the tempo from 20 to 400 beats per minute, depending on the song data.

Adjusting the volume

You can change the volume of the metronome sound.

While holding down the **[METRONOME]** button, press one of the C1–G2 keys to determine the volume.

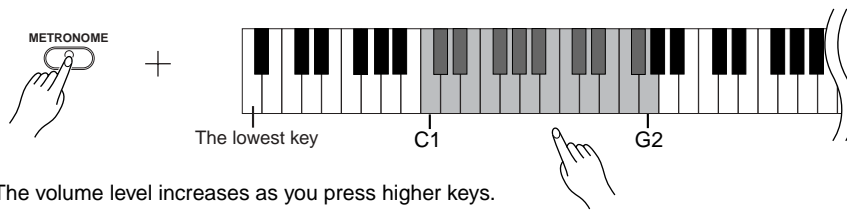

The volume level increases as you press higher keys.

2. Stop the metronome.

Turn off the metronome by pressing the **[METRONOME]** button.

About MIDI

MIDI (Musical Instrument Digital Interface) is a standard format for data transmission and reception. It enables the transfer of performance data and commands between MIDI devices and personal computers. Using MIDI, you can control a connected MIDI device from the YDP-123, or control the YDP-123 from a connected MIDI device or computer.

MIDI connectors

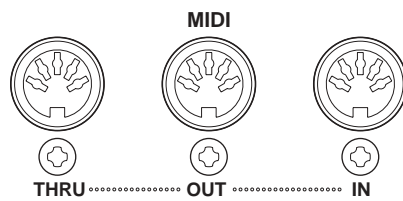

MIDI [IN]: Receives MIDI data.

MIDI [OUT]: Transmits MIDI data.

MIDI [THRU]: Transmits data received at the MIDI [IN] connector, passing it through the unit unmodified.

MIDI cables

Prepare dedicated MIDI cables.

TIP

MIDI performance data and commands are transferred in the form of numeric values.

TIP

Since MIDI data that can be transmitted or received varies depending on the type of MIDI device, check the "MIDI Implementation Chart" to find out what MIDI data and commands your devices can transmit or receive. The YDP-123's MIDI Implementation Chart appears on page 38.

TIP

You can also obtain detailed information about MIDI from various music books and other publications.

Connecting a Personal Computer

You can enjoy computer music data on the YDP-123 by connecting a computer to the MIDI jack.

NOTE

When the YDP-123 is used as a tone module, performance data with voices that are not found on the YDP-123 will not be played correctly.

“The Clavinova-Computer Connection,” is a supplementary guidebook that describes, for beginners, what you can do with your YDP-123 and a personal computer and how to set up a YDP-123-Computer system (although the guidebook only mentions the Clavinova, it applies equally to the YDP-123 digital piano). The document is available as a PDF file (in English) at the following Internet address:

Clavinova Web site (English only):

<http://www.yamahaclavinova.com/>

Yamaha Manual Library:

<http://www2.yamaha.co.jp/manual/english/>

There are two methods by which to connect the YDP-123 to a personal computer:

1. Use a MIDI interface and the YDP-123's MIDI connectors (page 25).
2. Use the USB port on the computer and a USB interface (model UX16, UX96, or UX256) (page 25).

NOTE

Before you connect the YDP-123 to a personal computer, first turn off the power to both the YDP-123 and the computer. After you make the connections, turn on the power to the computer first, then turn on the power to the YDP-123.

1. Using a MIDI interface and the YDP-123's MIDI connectors

Connection

Use a MIDI interface to connect a computer to the YDP-123 using special MIDI cables.

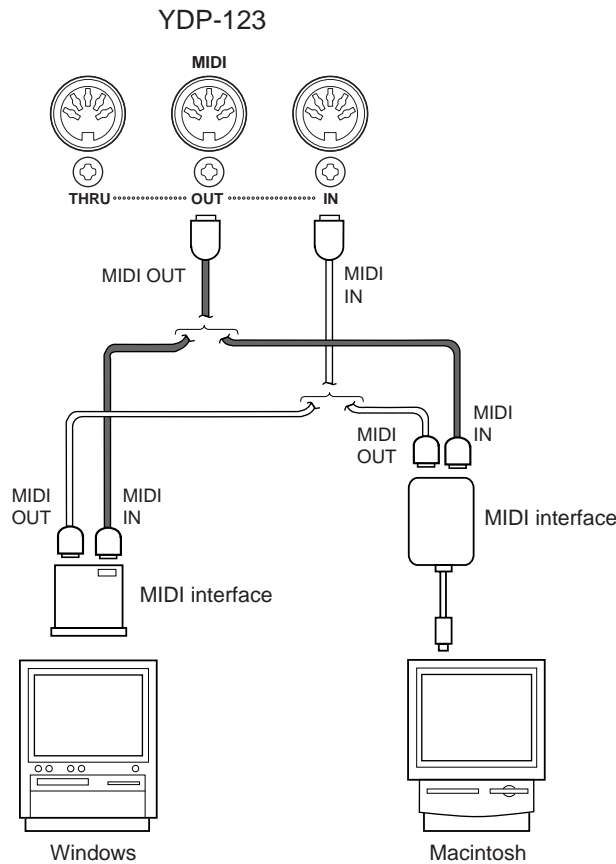

2. Connecting the computer's USB port to the YDP-123 via a USB interface, such as the UX16, UX96, or UX256

Connect the computer's USB port to the USB interface (such as the UX16, UX96, or UX256) using a USB cable. Install the driver (that came with the USB interface) on the computer, and connect the USB interface to the YDP-123 using a serial cable or MIDI cables.

For more information, refer to the instruction manual for the USB interface.

An example of connecting the USB interface to the YDP-123 using MIDI cables

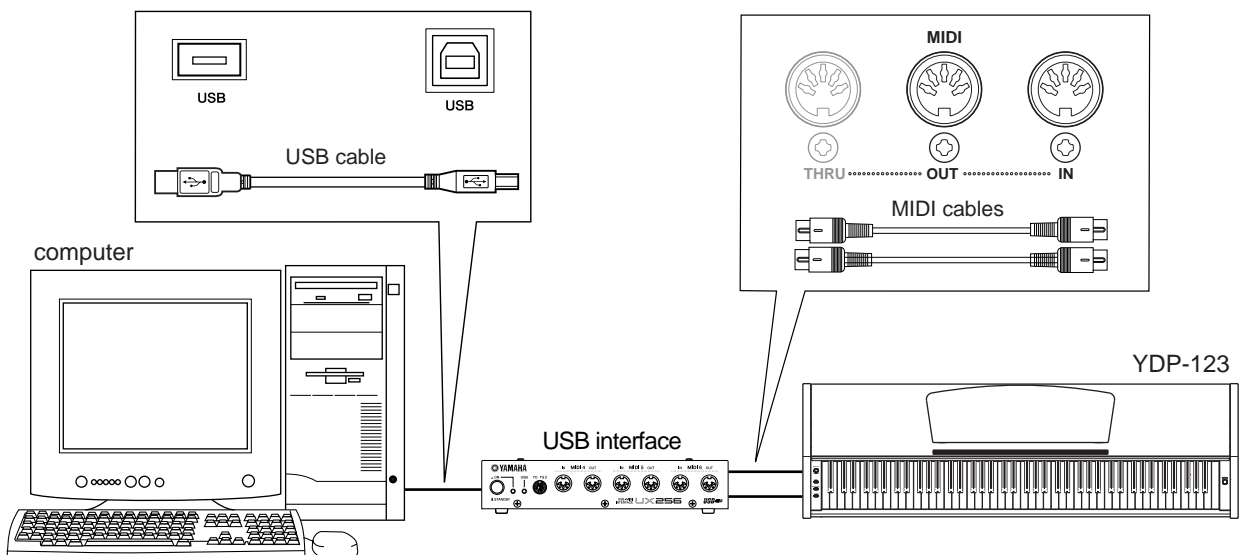

MIDI Functions

You can make detailed adjustments to MIDI settings.

For more information about MIDI, see the “About MIDI” section (page 23).

MIDI Transmit/Receive Channel Selection

In any MIDI control setup, the MIDI channels of the transmitting and receiving equipment must be matched for proper data transfer.

This parameter enables you to specify the channel on which the YDP-123 transmits or receives MIDI data.

Procedure

Setting the transmit channel

While holding down the A-1 and C[#]0 keys, press one of the C1–E2 keys.

Setting the receive channel

While holding down the A-1 and C[#]0 keys, press one of the C4–F5 keys.

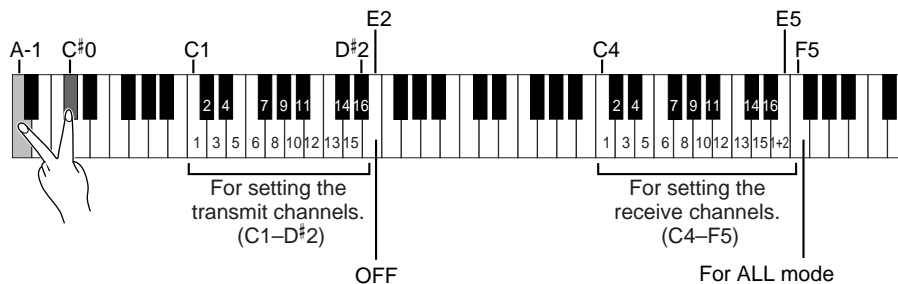

Local Control ON/OFF

“Local Control” refers to the fact that, normally, the YDP-123 keyboard controls its internal tone generator, allowing the internal voices to be played directly from the keyboard. This situation is “Local Control On,” since the internal tone generator is controlled locally by its own keyboard.

Local control can be turned OFF, however, so that the YDP-123 keyboard does not play the internal voices, but the appropriate MIDI information is still transmitted via the MIDI OUT connector when notes are played on the keyboard. At the same time, the internal tone generator responds to MIDI information received via the MIDI IN connector.

Procedure

While holding down the A-1 and C[#]0 keys, press the C6 key.

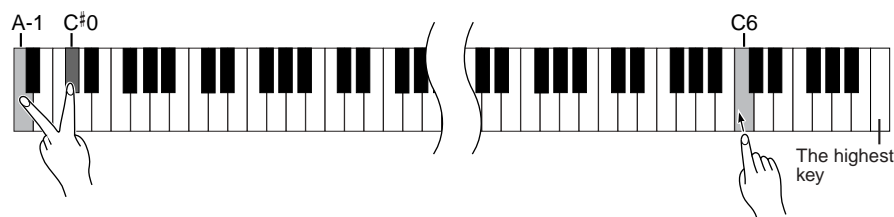

NOTE

Demo and preset song data are not transmitted via MIDI.

NOTE

In Dual mode, Voice 1 data is transmitted on its specified channel and Voice 2 data is transmitted on the next greater channel number relative to the specified channel. In this mode, no data is transmitted if the transmit channel is set to “OFF.”

TIP

ALL:

A “Multi-timbre” Receive mode is available. It allows simultaneous reception of different parts on all 16 MIDI channels, enabling the YDP-123 to play multi-channel song data received from a music computer or sequencer.

1+2:

A “1+2” Receive mode is available. It allows simultaneous reception on channels 1 and 2 only, enabling the YDP-123 to play 1 and 2 channel song data received from a music computer or sequencer.

TIP

Program change and other like channel messages received will not affect the YDP-123’s panel settings or the notes you play on the keyboard.

NOTE

The YDP-123 does not receive MIDI data when it is in Demo or Preset Song mode.

Program Change ON/OFF

Normally the YDP-123 will respond to MIDI program change numbers received from an external keyboard or other MIDI device, causing the correspondingly-numbered voice to be selected on the corresponding channel (the keyboard voice does not change). The YDP-123 will normally also send a MIDI program change number whenever one of its voices is selected, causing the correspondingly-numbered voice or program to be selected on the external MIDI device if the device is set up to receive and respond to MIDI program change numbers.

This function makes it possible to cancel program change number reception and transmission so that voices can be selected on the YDP-123 without affecting the external MIDI device.

Procedure

While holding down the A-1 and C[#]0 keys, press the C[#]6 key.

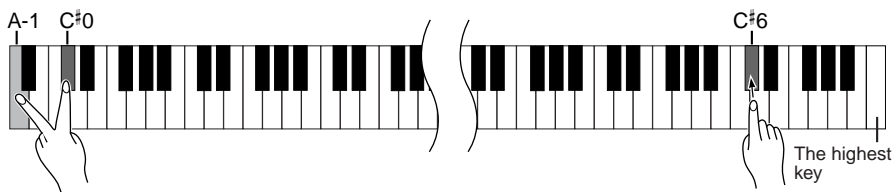

Control Change ON/OFF

Normally the YDP-123 will respond to MIDI control change data received from an external MIDI device or keyboard, causing the voice on the corresponding channel to be affected by pedal and other “control” settings received from the controlling device (the keyboard voice is not affected). The YDP-123 also transmits MIDI control change information when the pedal or other appropriate controls are operated.

This function makes it possible to cancel control change data reception and transmission so that, for example, the YDP-123’s pedal and other controls can be operated without affecting an external MIDI device.

Procedure

While holding down the A-1 and C[#]0 keys, press the D6 key.

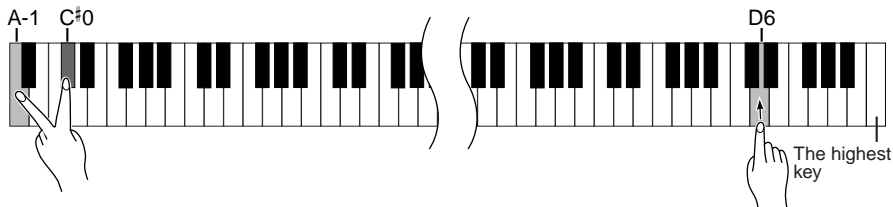

TIP

For information on program change numbers for each of the YDP-123’s voices, refer to page 34 in the MIDI Data Format section.

TIP

For information on control changes that can be used with the YDP-123, refer to the MIDI Data Format on page 34.

Troubleshooting

Problem	Possible Cause and Solution
The YDP-123 does not turn on.	The YDP-123 has not been plugged in properly. Securely insert the female plug into the socket on the YDP-123, and the male plug into a proper AC outlet (page 11).
A click or pop is heard when the power is turned on or off.	This is normal when electrical current is being applied to the instrument.
Noise from the speakers or headphones is audible.	The noise may be due to interference caused by the use of a mobile phone in close proximity to the YDP-123. Turn off the mobile phone, or move it further away from the YDP-123.
The overall volume is low, or no sound is heard.	<ul style="list-style-type: none">• The Master Volume is set too low. Set it to an appropriate level using the [MASTER VOLUME] control.• Make sure a pair of headphones is not connected to the headphones jack.• Make sure that Local Control (page 26) is ON.
The damper pedal has no effect, or the sound continuously sustains even when the damper pedal is not pressed.	The pedal cord may not be properly connected. Make sure to securely insert the pedal cord into the [PEDAL] jack (page 30).

Options & Expander Modules

Options

BC-100 Bench

A comfortable bench styled to match your Yamaha YDP-123.

HPE-160 Stereo Headphones

High-performance lightweight dynamic headphones with extra-soft ear pads.

Keyboard Stand Assembly

⚠ CAUTION

- Be careful not to confuse parts, and be sure to install all parts in the correct direction. Please assemble in accordance with the sequence given below.
- Assembly should be carried out by at least two persons.
- Be sure to use the correct screw size, as indicated below. Use of incorrect screws can cause damage.
- Be sure to tighten up all screws upon completing assembly of each unit.
- To disassemble, reverse the assembly sequence given below.

Have a Phillips-head (+) screwdriver ready

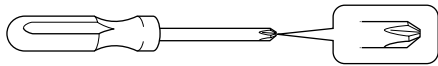

Remove the following parts from the package.

Assembly Parts

6 × 20 mm long screws × 4 ① 4 × 20 mm tapping screws × 4 ④



6 × 16 mm short screws × 4 ②

Cord holders × 2



4 × 12 mm thin screws × 2 ③

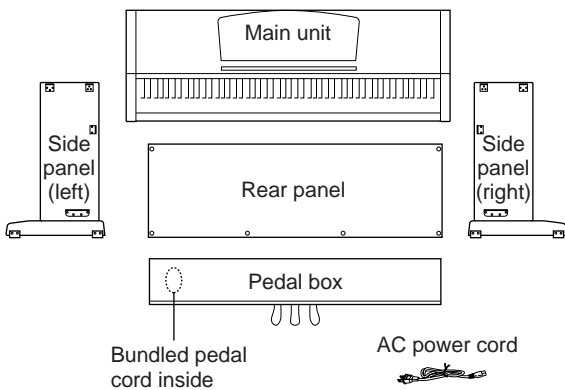

TIP

A headphone hanger is included in the YDP-123 package. You can attach a headphone hanger on the YDP-123 to hang the headphones (page 12).

1. Attach the side panels to the pedal box.

-
- (1) Untie and straighten out the bundled cord attached to the bottom of the pedal box. Don't discard the vinyl tie, you'll need it later in step 5.
 - (2) Align the sides of the pedal box with the left and right side panels.
 - (3) Use the four 6×20 mm long screws ① to attach the pedal box.

2. Attach the rear panel.

-
- (1) Secure the top of the rear panel to the side panel brackets using two 4×12 mm thin screws ③.
 - (2) Secure the bottom of the rear panel to the pedal box using four 4×20 mm tapping screws ④.

3. Mount the main unit.

CAUTION

- Fingers can become pinched between the main unit and the rear or side panels, be extra careful so as not to drop the main unit.
- Do not hold the keyboard in any position other than the position shown in the illustration.

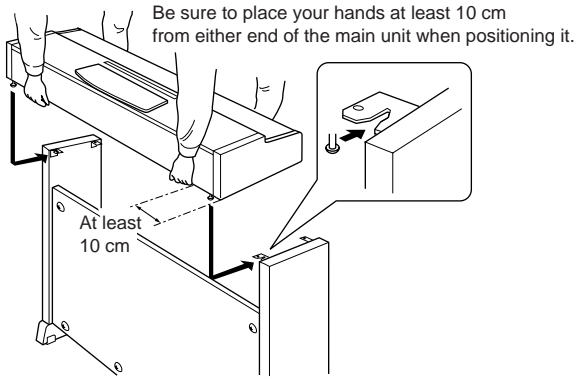

4. Fix the main unit.

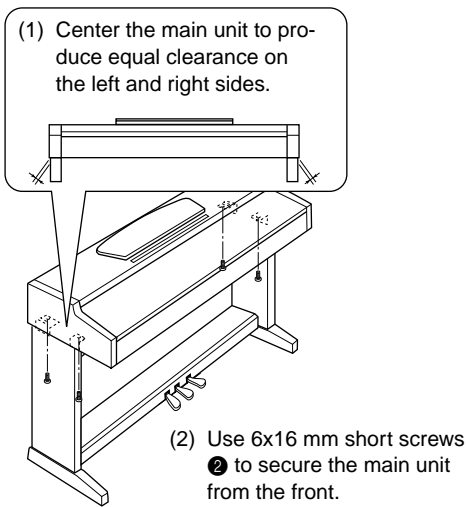

5. Connect the pedal cord.

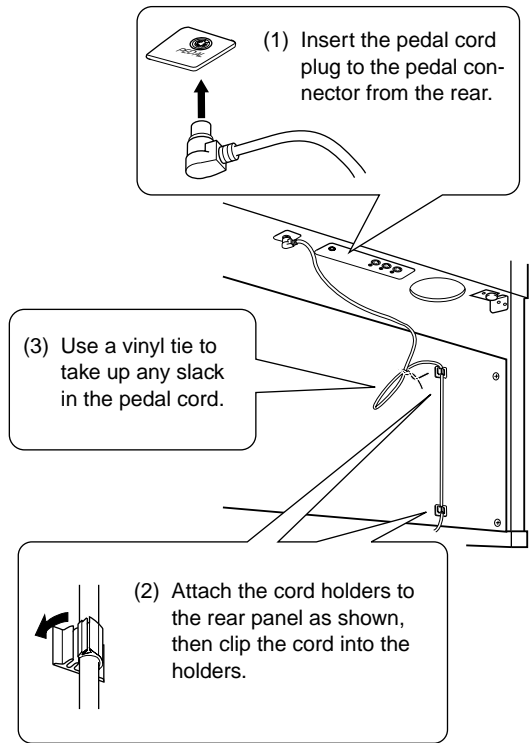

6. Set the voltage selector and connect the power cord.

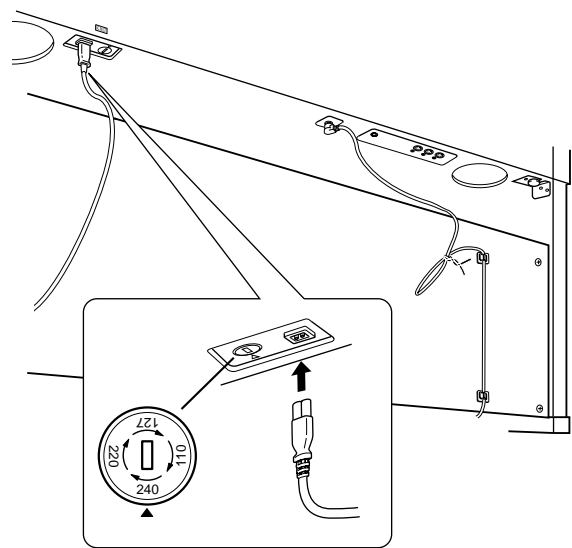

Voltage Selector

Before connecting the AC power cord, check the setting of the voltage selector which is provided in some areas. To set the selector for 110V, 127V, 220V or 240V main voltages, use a “minus” screwdriver to rotate the selector dial so that the correct voltage for your region appears next to the pointer on the panel. The voltage selector is set at 240V when the unit is initially shipped. After the proper voltage has been selected, connect the AC power cord to the AC INLET and an AC wall outlet. A plug adaptor may also be provided in some areas to match the pin configuration of the AC wall outlets in your area.

⚠ WARNING

An improper voltage setting can cause serious damage to the YDP-123 or result in improper operation.

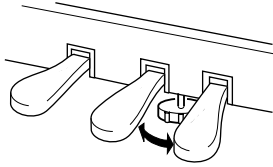
7. Set the adjuster.

Rotate the adjuster until it comes in firm contact with the floor surface.

After completing the assembly, please check the following.

- **Are there any parts left over?**
→ Review the assembly procedure and correct any errors.
- **Is the YDP-123 clear of doors and other movable fixtures?**
→ Move the YDP-123 to an appropriate location.
- **Does the YDP-123 make a rattling noise when you shake it?**
→ Tighten all screws.
- **Does the pedal box rattle or give way when you step on the pedals?**
→ Turn the adjuster so that it is set firmly against the floor.
- **Are the pedal and power cords inserted securely into the sockets?**
→ Check the connection.
- **If the main unit creaks or is otherwise unsteady when you play on the keyboard, refer to the assembly diagrams and retighten all screws.**

When moving the instrument after assembly, always hold the bottom of the main unit.

⚠ CAUTION

Do not hold the key cover or top portion. Improper handling can result in damage to the instrument or personal injury.

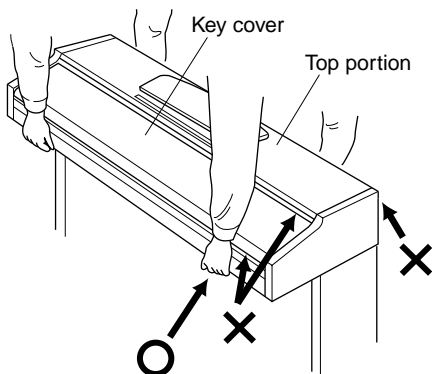

Index

Numerics

- 50 Greats for the Piano 16
- 50 Piano Preset Songs 16

A

- Accessories 8
- Adjust
 - Reverb Depth 18
 - Tempo (metronome) 21
 - Volume (50 Piano Preset Songs) 16
 - Volume (Demo) 15
 - Volume (metronome) 22
- Assembly 29–31

C

- Center Pedal 14, 18
- Combining Two Voices (Dual mode) 19
- Connecting a Personal Computer 24

D

- Damper Pedal 14, 17
- DEMO 14, 15
- Dual mode 19

K

- Key Cover 10

L

- Left Pedal 14, 18

M

- MASTER VOLUME 11, 14
- METRONOME 14, 21
- MIDI 23
- MIDI [IN] [OUT] [THRU] 14
- MIDI cables 23, 25
- MIDI connectors 23, 25
- MIDI Data Format 34
- MIDI Implementation Chart 38
- Music Rest 10

P

- PEDAL 14, 30
- PHONES 12, 14
- POWER 11, 14
- Precautions 6–7
- Preset songs → 50 Piano Preset Songs 16

R

- Reverb 18
- Right Pedal 14, 17

S

- Soft Pedal 14, 18
- Song 16
- Sostenute Pedal 14, 18
- Specifications 39
- Start/Stop playback
 - 50 Piano Preset Songs 16
 - Demo Songs 15

T

- Transporting 8
- Transposition 20
- Troubleshooting 28

V

- VOICE 14, 17–19

Appendix / Anhang / Annexe / Apéndice

This section introduces reference material.

In diesem Abschnitt finden Sie Referenzmaterial.

Cette section présente le matériel de référence.

En esta sección se incluye material de referencia.

MIDI Data Format / MIDI-Datenformat / Format des données MIDI / Formato de datos MIDI	34
MIDI Implementation Chart / MIDI Implementierung stabelle / Feuille d'implantation MIDI / Gráfica de implementación MIDI	38
Specifications / Technische Daten / Caractéristiques techniques / Especificaciones	39

MIDI Data Format / MIDI-Datenformat / Format des données MIDI / Formato de datos MIDI

If you're already very familiar with MIDI, or are using a computer to control your music hardware with computer-generated MIDI messages, the data provided in this section can help you to control the YDP-123.

Falls Sie bereits mit MIDI vertraut sind oder einen Computer zur Erzeugung von MIDI-Steuermeldungen für die Instrumente verwenden, können Sie sich zur Steuerung des YDP-123 nach den im folgenden Abschnitt aufgeführten Spezifikationen richten.

1. NOTE ON/OFF

Data format: [9nH] -> [kk] -> [vv]

9nH = Note ON/OFF event (n = channel number)
kk = Note number (Transmit: 09H ~ 78H = A-2 ~ C8 /
Receive: 00H ~ 7FH = C-2 ~ G8)*
vv = Velocity (Key ON = 01H ~ 7FH, Key OFF = 00H)

Data format: [8nH] -> [kk] -> [vv] (reception only)

8nH = Note OFF event (n = channel number)
kk = Note number: 00H ~ 7FH = C-2 ~ G8
vv = Velocity

* If received value exceeds the supported range for the selected voice, the note is adjusted by the necessary number of octaves.

2. CONTROL CHANGE

Data format: [BnH] -> [cc] -> [vv]

BnH = Control change (n = channel number)
cc = Control number
vv = Data Range

(1) Bank Select

ccH	Parameter	Data Range (vvH)
00H	Bank Select MSB	00H:Normal
20H	Bank Select LSB	00H...7FH

Bank selection processing does not occur until receipt of next Program Change message.

(2) Main Volume (reception only)

ccH	Parameter	Data Range (vvH)
07H	Volume MSB	00H...7FH

(3) Expression

ccH	Parameter	Data Range (vvH)
0BH	Expression MSB	00H...7FH

(4) Damper

ccH	Parameter	Data Range (vvH)
40H	Damper MSB	00H...7FH

(5) Sostenuto

ccH	Parameter	Data Range (vvH)
42H	Sostenuto	00H-3FH:off, 40H-7FH:on

(6) Soft Pedal

ccH	Parameter	Data Range (vvH)
43H	Soft Pedal	00H-3FH:off, 40H-7FH:on

(7) Effect1 Depth (Reverb Send Level)

ccH	Parameter	Data Range (vvH)
5BH	Effect1 Depth	00H...7FH

Adjusts the reverb send level.

(8) Effect4 Depth (Variation Effect Send Level)

ccH	Parameter	Data Range (vvH)
5EH	Effect4 Depth	00H...7FH

Si vous êtes très familier avec l'interface MIDI ou si vous utilisez un ordinateur pour commander votre matériel de musique au moyen de messages MIDI générés par ordinateur, les données suivantes vous seront utiles et vous aideront à commander le YDP-123.

Si usted está ya familiarizado con MIDI, o si emplea una computadora para controlar sus aparatos musicales con mensajes MIDI generados por computadora, los datos proporcionados en esta sección le ayudarán a controlar la YDP-123.

3. MODE MESSAGES

Data format: [BnH] -> [cc] -> [vv]

BnH = Control event (n = channel number)
cc = Control number
vv = Data Range

(1) All Sound Off

ccH	Parameter	Data Range (vvH)
78H	All Sound Off	00H

Switches off all sound from the channel. Does not reset Note On and Hold On conditions established by Channel Messages.

(2) Reset All Controllers

ccH	Parameter	Data Range (vvH)
79H	Reset All Controllers	00H

Resets controllers as follows.

Controller	Value
Expression	127 (max)
Damper Pedal	0 (off)
Sostenuto	0 (off)
Soft Pedal	0 (off)

(3) Local Control (reception only)

ccH	Parameter	Data Range (vvH)
7AH	Local Control	00H (off), 7FH (on)

(4) All Notes Off

ccH	Parameter	Data Range (vvH)
7BH	All Notes Off	00H

Switches OFF all the notes that are currently ON on the specified channel. Any notes being held by the damper or sostenuto pedal will continue to sound until the pedal is released.

(5) Omni Off (reception only)

ccH	Parameter	Data Range (vvH)
7CH	Omni Off	00H

Same processing as for All Notes Off.

(6) Omni On (reception only)

ccH	Parameter	Data Range (vvH)
7DH	Omni On	00H

Same processing as for All Notes Off.

(7) Mono (reception only)

ccH	Parameter	Data Range (vvH)
7EH	Mono	00H

Same processing as for All Sound Off.

(8) Poly (reception only)

ccH	Parameter	Data Range (vvH)
7FH	Poly	00H

Same processing as for All Sound Off.

- When control change reception is turned OFF, control change data will not be transmitted or received except for Bank Select and Mode messages.
- Local on/off, OMNI on/off are not transmitted. (The appropriate note off number is supplied with "All Note Off" transmission).
- When a voice bank MSB/LSB is received, the number is stored in the internal buffer regardless of the received order, then the stored value is used to select the appropriate voice when a program change message is received.
- The Multi-timbre and Poly modes are always active. No change occurs when OMNI ON, OMNI OFF, MONO, or POLY mode messages are received.

4. PROGRAM CHANGE

Data format: [CnH] -> [ppH]

CnH = Program event (n = channel number)

ppH = Program change number

P.C.#=Program Change number

YDP-123	MSB	LSB	P.C.#
Grand Piano 1	0	122	0
Grand Piano 2	0	112	0
E.Piano 1	0	122	5
E.Piano 2	0	122	4
Harpsichord 1	0	122	6
Harpsichord 2	0	123	6
Vibraphone	0	122	11
Church Organ 1	0	123	19
Church Organ 2	0	122	19
Strings	0	122	48

- When program change reception is turned OFF, no program change data is transmitted or received. Also, Bank MSB/LSB is not transmitted or received.

5. SYSTEM REALTIME MESSAGES

[rrH]

F8H: Timing clock

FAH: Start

FCH: Stop

FEH: Active sensing

Data	Transmission	Reception
F8H	Transmitted every 96 clocks	Received as 96-clock tempo timing when MIDI clock is set to External.
FAH	Song start	Song start Not received when the MIDI clock is set to Internal.
FCH	Song stop	Song stop Not received when the MIDI clock is set to Internal.
FEH	Transmitted every 200 milliseconds	If a signal is not received via MIDI for more than 400 milliseconds, the same processing will take place for All Sound Off, All Notes Off and Reset All Controllers as when those signals are received.

- Caution: If an error occurs during MIDI reception, the Damper, Sostenuto, and Soft effects for all channels are turned off and an All Note Off occurs.

6. SYSTEM EXCLUSIVE MESSAGES (Universal System Exclusive)

(1) Universal Realtime Message

Data format: [F0H] -> [7FH] -> [XnH] -> [04H] -> [01H] -> [IH] -> [mmH] -> [F7H]

MIDI Master Volume

- Simultaneously changes the volume of all channels.
- When a MIDI master volume message is received, the volume only has affect on the MIDI receive channel, not the panel master volume.

F0H = Exclusive status
 7FH = Universal Realtime
 7FH = ID of target device
 04H = Sub-ID #1=Device Control Message
 01H = Sub-ID #2=Master Volume
 IH = Volume LSB
 mmH = Volume MSB
 F7H = End of Exclusive

or

F0H = Exclusive status
 7FH = Universal Realtime
 XnH = When n is received n=0~F, whichever is received.
 X = don't care
 04H = Sub-ID #1=Device Control Message
 01H = Sub-ID #2=Master Volume
 IH = Volume LSB
 mmH = Volume MSB
 F7H = End of Exclusive

(2) Universal Non-Realtime Message (GM On)

General MIDI Mode On

Data format: [F0H] -> [7EH] -> [XnH] -> [09H] -> [01H] -> [F7H]

F0H = Exclusive status
 7EH = Universal Non-Realtime
 7FH = ID of target device
 09H = Sub-ID #1=General MIDI Message
 01H = Sub-ID #2=General MIDI On
 F7H = End of Exclusive

or

F0H = Exclusive status
 7EH = Universal Non-Realtime
 XnH = When received, n=0~F.
 X = don't care
 09H = Sub-ID #1=General MIDI Message
 01H = Sub-ID #2=General MIDI On
 F7H = End of Exclusive

When the General MIDI mode ON message is received, the MIDI system will be reset to its default settings.

This message requires approximately 50ms to execute, so sufficient time should be allowed before the next message is sent.

7. SYSTEM EXCLUSIVE MESSAGES (XG Standard)

(1) XG Native Parameter Change

Data format: [F0H] -> [43H] -> [1nH] -> [4CH] -> [hhH] -> [mmH] -> [//H] -> [ddH] -> [F7H]

F0H = Exclusive status
 43H = YAMAHA ID
 1nH = When received, n=0~F.
 When transmitted, n=0.
 4CH = Model ID of XG
 hhH = Address High
 mmH = Address Mid
 //H = Address Low
 ddH = Data
 |
 F7H = End of Exclusive

Data size must match parameter size (2 or 4 bytes).

When the XG System On message is received, the MIDI system will be reset to its default settings.

The message requires approximately 50ms to execute, so sufficient time should be allowed before the next message is sent.

(2) XG Native Bulk Data (reception only)

Data format: [F0H] -> [43H] -> [0nH] -> [4CH] -> [aaH] -> [bbH] -> [hhH] -> [mmH] -> [//H] -> [ddH] ->...-> [ccH] -> [F7H]

F0H = Exclusive status
 43H = YAMAHA ID
 0nH = When received, n=0~F.
 When transmitted, n=0.
 4CH = Model ID of XG
 aaH = ByteCount
 bbH = ByteCount
 hhH = Address High
 mmH = Address Mid
 //H = Address Low
 ddH = Data
 | |
 | |
 ccH = Check sum
 F7H = End of Exclusive

- Receipt of the XG SYSTEM ON message causes reinitialization of relevant parameters and Control Change values. Allow sufficient time for processing to execute (about 50 msec) before sending the YDP-123 another message.
- XG Native Parameter Change message may contain two or four bytes of parameter data (depending on the parameter size).
- For information about the Address and Byte Count values, refer to Table 1 below. Note that the table's Total Size value gives the size of a bulk block. Only the top address of the block (00H, 00H, 00H) is valid as a bulk data address.

8. SYSTEM EXCLUSIVE MESSAGES (Digital Piano MIDI Format)

Data format: [F0H] -> [43H] -> [73H] -> [xxH] -> [nnH] -> [F7H]

F0H = Exclusive status
 43H = Yamaha ID
 73H = Digital Piano ID
 01H = Product ID (digital piano common)
or
 7F = Extended Product ID
 24H = Product ID
 nnH = Substatus
 nn Control
 02H Internal MIDI clock
 03H External MIDI clock
 06H Bulk Data (the bulk data follows 06H)
 F7H = End of Exclusive

- * When nn=02H or 03H, YDP common ID (01H) is recognized as well as 75H.

9. SYSTEM EXCLUSIVE MESSAGES (Special Control)

Data format: [F0H] -> [43H] -> [73H] -> [66H] -> [11H] -> [0nH] -> [ccH] -> [vvH] -> [F7H]

F0H = Exclusive status
 43H = Yamaha ID
 73H = Digital Piano ID
 7FH = Extended Product ID
 24H = Product ID
 11H = Special control
 0nH = Control MIDI change (n=channel number)
 cc = Control number
 vv = Value
 F7H = End of Exclusive

Control	Channel	ccH	vvH
Metronome	Always 00H	1BH	00H : off
			01H : -
			02H : 2/4
			03H : 3/4
			04H : 4/4
			05H : 5/4
			06H : 6/4
Channel Detune ch:	00H-0FH	43H	(Sets the Detune value for each channel) 00H-7FH
			Voice Reserve ch: 00H-0FH
		45H	00H : Reserve off
			7FH : on*

- * When Volume, Expression is received for Reserve On, they will be effective from the next Key On. Reserve Off is normal.

10. SYSTEM EXCLUSIVE MESSAGES (Others)

Data format: [F0H] -> [43H] -> [1nH] -> [27H] -> [30H] -> [00H] -> [00H] -> [mmH] -> [//H] -> [ccH] -> [F7H]

Master Tuning (XG and last message priority) simultaneously changes the pitch of all channels.

F0H = Exclusive Status
 43H = Yamaha ID
 1nH = When received, n=0~F.
 When transmitted, n=0.
 27H = Model ID of TG100
 30H = Sub ID
 00H =
 00H =
 mmH = Master Tune MSB
 //H = Master Tune LSB
 ccH = don't care (under 7FH)
 F7H = End of Exclusive

<Table 1>**MIDI Parameter Change table (SYSTEM)**

Address (H)	Size (H)	Data (H)	Parameter	Description	Default value (H)
00 00 00	4	020C - 05F4(*1)	MASTER TUNE	-50 - +50[cent]	00 04 00 00
01				1st bit 3 - 0 → bit 15 - 12	400
02				2nd bit 3 - 0 → bit 11 - 8	
03				3rd bit 3 - 0 → bit 7 - 4	
				4th bit 3 - 0 → bit 3 - 0	
04	1	00 - 7F	MASTER VOLUME	0 - 127	7F
05	1	—	—		
06	1	34 - 4C(*2)	TRANSPOSE	-12 - +12[semitones]	40
7E		00	XG SYSTEM ON	00=XG system ON	
7F		00	RESET ALL PARAMETERS	00=ON (receive only)	
TOTAL SIZE 07					

*1: Values lower than 020CH select -50 cents. Values higher than 05F4H select +50 cents.

*2: Values from 28H through 33H are interpreted as -12 through -1. Values from 4DH through 58H are interpreted as +1 through +12.

<Table 2>**MIDI Parameter Change table (EFFECT 1)**

Refer to the "Effect MIDI Map" for a complete list of Reverb, Chorus and Variation type numbers.

Address (H)	Size (H)	Data (H)	Parameter	Description	Default value (H)
02 01 00	2	00-7F	REVERB TYPE MSB	Refer to Effect MIDI Map	01(=HALL1)
		00-7F	REVERB TYPE LSB	00 : basic type	00
02 01 40	2	00-7F	VARIATION TYPE MSB	Refer to Effect MIDI Map	00(=Effect off)
		00-7F	VARIATION TYPE LSB	00 : basic type	00

• "VARIATION" refers to the EFFECT on the panel.

<Table 3>**MIDI Parameter Change table (MULTI PART)**

Address (H)	Size (H)	Data (H)	Parameter	Description	Default value (H)
08 nn 11	1	00 - 7F	DRY LEVEL	0 - 127	7F
nn = Part Number					

• Effect MIDI Map**REVERB**

	MSB	LSB
ROOM	02H	10H
HALL 1	01H	10H
HALL 2	01H	11H
STAGE	03H	10H

EFFECT

	MSB	LSB
CHORUS	42H	10H
PHASER	48H	10H
TREMOLO	46H	10H
DELAY	05H	10H

Function		Transmitted	Recognized	Remarks
Basic Channel	Default Changed	1 1 - 16	1 1 - 16	
Mode	Default Messages Altered	3 X *****	1 X X	*1 Poly Mode only
Note Number	: True voice	9 - 120 *****	0 - 127 0 - 127	
Velocity	Note ON Note OFF	O 9nH, v=1 - 127 O 9nH, v=0	O 9nH, v=1 - 127 O 9nH, v=0 or 8nH	
After Touch	Key's Ch's	X X	X X	
Pitch Bender		X	X	
Control Change	0, 32 7 11 64 66 67 91 94	O O X O X X O X	O O O O O O O O	Bank Select Volume Expression Damper Sostenuto Soft pedal Reverb Depth Effect Depth
Program Change	: True #	O *****	O	
System Exclusive		O	O	
Common	: Song Position : Song Select : Tune	X X X	X X X	
System Real Time	: Clock : Commands	O O	O O	
Aux Messages	: All sounds off : Reset All Controllers : Local ON/OFF : All Notes OFF : Active Sense : Reset	O O X O O X	O (120, 126, 127) O (121) O (122) O (123 - 125) O X	
Notes : *1 = Recieve Mode is always multi timbre and Poly mode.				

Mode 1: OMNI ON, POLY
Mode 3: OMNI OFF, POLY

Mode 2: OMNI ON, MONO
Mode 4: OMNI OFF, MONO

O : Yes
X : No

Specifications / Technische Daten / Caractéristiques techniques / Especificaciones

Item	YDP-123
Keyboard	88 keys (A-1 - C7)
Sound Source	AWM Stereo Sampling
Polyphony	32 Notes Max.
Voice Selection	10
Effect	Reverb
Volume	Master Volume
Controls	Dual, Metronome, Transpose
Pedal	Damper, Sostenuto, Soft
Demo Songs	10 voice Demo Songs, 50 preset Songs
Jacks/Connectors	MIDI (IN/OUT/THRU), PHONES × 2
Main Amplifiers	20W × 2
Speakers	Oval (12cm × 6cm) × 2
Dimensions (W × D × H) (with music rest)	1345mm × 426mm × 815mm [52-15/16" × 16-3/4" × 32-1/16"] (1345mm × 426mm × 968mm) [53-15/16" × 16-3/4" × 38-1/8"]
Weight	41kg (90lbs., 6oz)
Accessories	Owner's Manual, "50 greats for the Piano" (Music Book), Bench (included or optional depending on locale), Quick Operation Guide

- * Specifications and descriptions in this owner's manual are for information purposes only. Yamaha Corp. reserves the right to change or modify products or specifications at any time without prior notice. Since specifications, equipment or options may not be the same in every locale, please check with your Yamaha dealer.
- * Die technischen Daten und Beschreibungen in dieser Bedienungsanleitung dienen nur der Information. Yamaha Corp. behält sich das Recht vor, Produkte oder deren technische Daten jederzeit ohne vorherige Ankündigung zu verändern oder zu modifizieren. Da die technischen Daten, das Gerät selbst oder Sonderzubehör nicht in jedem Land gleich sind, setzen Sie sich im Zweifel bitte mit Ihrem Yamaha-Händler in Verbindung.
- * Les caractéristiques techniques et les descriptions du mode d'emploi ne sont données que pour information. Yamaha Corp. se réserve le droit de changer ou modifier les produits et leurs caractéristiques techniques à tout moment sans aucun avis. Du fait que les caractéristiques techniques, les équipements et les options peuvent différer d'un pays à l'autre, adressez-vous au distributeur Yamaha le plus proche.
- * Las especificaciones y descripciones de este manual del propietario tienen sólo el propósito de servir como información. Yamaha Corp. se reserva el derecho a efectuar cambios o modificaciones en los productos o especificaciones en cualquier momento sin previo aviso. Puesto que las especificaciones, equipos u opciones pueden no ser las mismas en todos los mercados, solicite información a su distribuidor Yamaha.

MEMO

IMPORTANT SAFETY INSTRUCTIONS

INFORMATION RELATING TO PERSONAL INJURY, ELECTRICAL SHOCK, AND FIRE HAZARD POSSIBILITIES HAS BEEN INCLUDED IN THIS LIST.

WARNING- When using any electrical or electronic product, basic precautions should always be followed. These precautions include, but are not limited to, the following:

- 1.** Read all Safety Instructions, Installation Instructions, Special Message Section items, and any Assembly Instructions found in this manual **BEFORE** making any connections, including connection to the main supply.
- 2.** Main Power Supply Verification: Yamaha products are manufactured specifically for the supply voltage in the area where they are to be sold. If you should move, or if any doubt exists about the supply voltage in your area, please contact your dealer for supply voltage verification and (if applicable) instructions. The required supply voltage is printed on the name plate. For name plate location, please refer to the graphic found in the Special Message Section of this manual.
- 3.** This product may be equipped with a polarized plug (one blade wider than the other). If you are unable to insert the plug into the outlet, turn the plug over and try again. If the problem persists, contact an electrician to have the obsolete outlet replaced. Do **NOT** defeat the safety purpose of the plug.
- 4.** Some electronic products utilize external power supplies or adapters. Do **NOT** connect this type of product to any power supply or adapter other than one described in the owners manual, on the name plate, or specifically recommended by Yamaha.
- 5.** **WARNING:** Do not place this product or any other objects on the power cord or place it in a position where anyone could walk on, trip over, or roll anything over power or connecting cords of any kind. The use of an extension cord is not recommended! If you must use an extension cord, the minimum wire size for a 25' cord (or less) is 18 AWG. **NOTE:** The smaller the AWG number, the larger the current handling capacity. For longer extension cords, consult a local electrician.
- 6.** Ventilation: Electronic products, unless specifically designed for enclosed installations, should be placed in locations that do not interfere with proper ventilation. If instructions for enclosed installations are not provided, it must be assumed that unobstructed ventilation is required.
- 7.** Temperature considerations: Electronic products should be installed in locations that do not significantly contribute to their operating temperature. Placement of this product close to heat sources such as; radiators, heat registers and other devices that produce heat should be avoided.
- 8.** This product was **NOT** designed for use in wet/damp locations and should not be used near water or exposed to rain. Examples of wet/damp locations are; near a swimming pool, spa, tub, sink, or wet basement.
- 9.** This product should be used only with the components supplied or; a cart, rack, or stand that is recommended by the manufacturer. If a cart, rack, or stand is used, please observe all safety markings and instructions that accompany the accessory product.
- 10.** The power supply cord (plug) should be disconnected from the outlet when electronic products are to be left unused for extended periods of time. Cords should also be disconnected when there is a high probability of lightning and/or electrical storm activity.
- 11.** Care should be taken that objects do not fall and liquids are not spilled into the enclosure through any openings that may exist.
- 12.** Electrical/electronic products should be serviced by a qualified service person when:
 - a. The power supply cord has been damaged; or
 - b. Objects have fallen, been inserted, or liquids have been spilled into the enclosure through openings; or
 - c. The product has been exposed to rain; or
 - d. The product does not operate, exhibits a marked change in performance; or
 - e. The product has been dropped, or the enclosure of the product has been damaged.
- 13.** Do not attempt to service this product beyond that described in the user-maintenance instructions. All other servicing should be referred to qualified service personnel.
- 14.** This product, either alone or in combination with an amplifier and headphones or speaker/s, may be capable of producing sound levels that could cause permanent hearing loss. **DO NOT** operate for a long period of time at a high volume level or at a level that is uncomfortable. If you experience any hearing loss or ringing in the ears, you should consult an audiologist. **IMPORTANT:** The louder the sound, the shorter the time period before damage occurs.
- 15.** Some Yamaha products may have benches and/or accessory mounting fixtures that are either supplied as a part of the product or as optional accessories. Some of these items are designed to be dealer assembled or installed. Please make sure that benches are stable and any optional fixtures (where applicable) are well secured **BEFORE** using. Benches supplied by Yamaha are designed for seating only. No other uses are recommended.

PLEASE KEEP THIS MANUAL

FCC INFORMATION (U.S.A.)

1. **IMPORTANT NOTICE: DO NOT MODIFY THIS UNIT!**

This product, when installed as indicated in the instructions contained in this manual, meets FCC requirements. Modifications not expressly approved by Yamaha may void your authority, granted by the FCC, to use the product.

2. **IMPORTANT:** When connecting this product to accessories and/or another product use only high quality shielded cables. Cable/s supplied with this product **MUST** be used. Follow all installation instructions. Failure to follow instructions could void your FCC authorization to use this product in the USA.

3. **NOTE:** This product has been tested and found to comply with the requirements listed in FCC Regulations, Part 15 for Class "B" digital devices. Compliance with these requirements provides a reasonable level of assurance that your use of this product in a residential environment will not result in harmful interference with other electronic devices. This equipment generates/uses radio frequencies and, if not installed and used according to the instructions found in the users manual, may cause interference harmful to the operation of

other electronic devices. Compliance with FCC regulations does not guarantee that interference will not occur in all installations. If this product is found to be the source of interference, which can be determined by turning the unit "OFF" and "ON", please try to eliminate the problem by using one of the following measures:

Relocate either this product or the device that is being affected by the interference.

Utilize power outlets that are on different branch (circuit breaker or fuse) circuits or install AC line filter/s.

In the case of radio or TV interference, relocate/reorient the antenna. If the antenna lead-in is 300 ohm ribbon lead, change the lead-in to co-axial type cable.

If these corrective measures do not produce satisfactory results, please contact the local retailer authorized to distribute this type of product. If you can not locate the appropriate retailer, please contact Yamaha Corporation of America, Electronic Service Division, 6600 Orangethorpe Ave, Buena Park, CA90620

The above statements apply **ONLY** to those products distributed by Yamaha Corporation of America or its subsidiaries.

* This applies only to products distributed by YAMAHA CORPORATION OF AMERICA.

(class B)

IMPORTANT NOTICE FOR THE UNITED KINGDOM

Connecting the Plug and Cord

IMPORTANT. The wires in this mains lead are coloured in accordance with the following code:

BLUE : NEUTRAL

BROWN : LIVE

As the colours of the wires in the mains lead of this apparatus may not correspond with the coloured markings identifying the terminals in your plug proceed as follows:

The wire which is coloured BLUE must be connected to the terminal which is marked with the letter N or coloured BLACK.

The wire which is coloured BROWN must be connected to the terminal which is marked with the letter L or coloured RED.

Making sure that neither core is connected to the earth terminal of the three pin plug.

(2 wires)

- This applies only to products distributed by Yamaha-Kemble Music (U.K.) Ltd.

CAUTION: TO PREVENT ELECTRIC SHOCK, MATCH WIDE BLADE OF PLUG TO WIDE SLOT, FULLY INSERT.

ATTENTION: POUR ÉVITER LES CHOCS ÉLECTRIQUES, INTRODUIRE LA LAME LA PLUS LARGE DE LA FICHE DANS LA BORNE CORRESPONDANTE DE LA PRISE ET POUSSER JUSQU' AU FOND.

(polarity)

- This applies only to products distributed by Yamaha Canada Music Ltd.
- Ceci ne s'applique qu'aux produits distribués par Yamaha Canada Musique Ltée.

For details of products, please contact your nearest Yamaha or the authorized distributor listed below.

Pour plus de détails sur les produits, veuillez-vous adresser à Yamaha ou au distributeur le plus proche de vous figurant dans la liste suivante.

Die Einzelheiten zu Produkten sind bei Ihrer unten aufgeführten Niederlassung und bei Yamaha Vertragshändlern in den jeweiligen Bestimmungsländern erhältlich.

Para detalles sobre productos, contacte su tienda Yamaha más cercana o el distribuidor autorizado que se lista debajo.

NORTH AMERICA

CANADA

Yamaha Canada Music Ltd.
135 Milner Avenue, Scarborough, Ontario,
M1S 3R1, Canada
Tel: 416-298-1311

U.S.A.

Yamaha Corporation of America
6600 Orangethorpe Ave., Buena Park, Calif. 90620,
U.S.A.
Tel: 714-522-9011

CENTRAL & SOUTH AMERICA

MEXICO

**Yamaha de Mexico S.A. De C.V.,
Departamento de ventas**
Javier Rojo Gomez No.1149, Col. Gpe Del
Moral, Deleg. Iztapalapa, 09300 Mexico, D.F.
Tel: 686-00-33

BRAZIL

Yamaha Musical do Brasil LTDA.
Av. Rebouças 2636, São Paulo, Brasil
Tel: 011-853-1377

ARGENTINA

Yamaha de Panamá S.A. Sucursal de Argentina
Viamonte 1145 Piso2-B 1053,
Buenos Aires, Argentina
Tel: 1-4371-7021

PANAMA AND OTHER LATIN AMERICAN COUNTRIES/ CARIBBEAN COUNTRIES

Yamaha de Panamá S.A.
Torre Banco General, Piso 7, Urbanización Marbella,
Calle 47 y Aquilino de la Guardia,
Ciudad de Panamá, Panamá
Tel: 507-269-5311

EUROPE

THE UNITED KINGDOM

Yamaha-Kemble Music (U.K.) Ltd.
Sherbourne Drive, Tilbrook, Milton Keynes,
MK7 8BL, England
Tel: 01908-366700

IRELAND

Danfay Ltd.
61D, Sallynoggin Road, Dun Laoghaire, Co. Dublin
Tel: 01-2859177

GERMANY

Yamaha Europa GmbH.
Siemensstraße 22-34, 25462 Rellingen, Germany
Tel: 04101-3030

SWITZERLAND

Yamaha Europa GmbH. Zweigniederlassung Zürich
Seefeldstrasse 94, 8008 Zürich, Switzerland
Tel: 01-383 3990

AUSTRIA

Yamaha Europa GmbH. Zweigniederlassung Wien
Schleiergasse 20, A-1100 Wien, Austria
Tel: 01-60203900

THE NETHERLANDS

Yamaha Music Nederland
Clarissenhof 5-b, 4133 AB Vianen, The Netherlands
Tel: 0347-358 040

BELGIUM

Yamaha Music Belgium
Rue de Geneve (Genevastraat) 10, 1140 - Brussels,
Belgium
Tel: 02-726 6032

FRANCE

**Yamaha Musique France,
Division Professionnelle**
BP 70-77312 Marne-la-Vallée Cedex 2, France
Tel: 01-64-61-4000

ITALY

**Yamaha Musica Italia S.P.A.,
Combo Division**
Viale Italia 88, 20020 Lainate (Milano), Italy
Tel: 02-935-771

SPAIN/PORTUGAL

Yamaha-Hazen Música, S.A.
Ctra. de la Coruna km. 17, 200, 28230
Las Rozas (Madrid) Spain
Tel: 91-201-0700

GREECE

Philippe Nakas S.A.
Navarinou Street 13, P.Code 10680, Athens, Greece
Tel: 01-364-7111

SWEDEN

Yamaha Scandinavia AB
J. A. Wettergrens Gata 1
Box 30053
S-400 43 Göteborg, Sweden
Tel: 031 89 34 00

DENMARK

YS Copenhagen Liaison Office
Generatorvej 8B
DK-2730 Herlev, Denmark
Tel: 44 92 49 00

FINLAND

F-Musiikki Oy
Kluuvikatu 6, P.O. Box 260,
SF-00101 Helsinki, Finland
Tel: 09 618511

NORWAY

Norsk filial av Yamaha Scandinavia AB
Grini Næringspark 1
N-1345 Østerås, Norway
Tel: 67 16 77 70

ICELAND

Skifan HF
Skeifan 17 P.O. Box 8120
IS-128 Reykjavik, Iceland
Tel: 525 5000

OTHER EUROPEAN COUNTRIES

Yamaha Europa GmbH.
Siemensstraße 22-34, 25462 Rellingen, Germany
Tel: 04101-3030

AFRICA

**Yamaha Corporation,
Asia-Pacific Music Marketing Group**
Nakazawa-cho 10-1, Hamamatsu, Japan 430-8650
Tel: 053-460-2312

MIDDLE EAST

TURKEY/CYPRUS

Yamaha Europa GmbH.
Siemensstraße 22-34, 25462 Rellingen, Germany
Tel: 04101-3030

OTHER COUNTRIES

Yamaha Music Gulf FZE
LB21-128 Jebel Ali Freezone
P.O.Box 17328, Dubai, U.A.E.
Tel: 971-4-881-5868

ASIA

HONG KONG

Tom Lee Music Co., Ltd.
11/F., Silvercord Tower 1, 30 Canton Road,
Tsimshatsui, Kowloon, Hong Kong
Tel: 2737-7688

INDONESIA

**PT. Yamaha Music Indonesia (Distributor)
PT. Nusantik**
Gedung Yamaha Music Center, Jalan Jend. Gatot
Subroto Kav. 4, Jakarta 12930, Indonesia
Tel: 21-520-2577

KOREA

Yamaha Music Korea Ltd.
Tong-Yang Securities Bldg. 16F 23-8 Yoido-dong,
Yongdungpo-ku, Seoul, Korea
Tel: 02-3770-0661

MALAYSIA

Yamaha Music Malaysia, Sdn., Bhd.
Lot 8, Jalan Perbandaran, 47301 Kelana Jaya,
Petaling Jaya, Selangor, Malaysia
Tel: 3-703-0900

PHILIPPINES

Yupangco Music Corporation
339 Gil J. Puyat Avenue, P.O. Box 885 MCPO,
Makati, Metro Manila, Philippines
Tel: 819-7551

SINGAPORE

Yamaha Music Asia Pte., Ltd.
11 Ubi Road #06-00, Meiban Industrial Building,
Singapore
Tel: 65-747-4374

TAIWAN

Yamaha KHS Music Co., Ltd.
10F, 150, Tun-Hwa Northroad,
Taipei, Taiwan, R.O.C.
Tel: 02-2713-8999

THAILAND

Siam Music Yamaha Co., Ltd.
121/60-61 RS Tower 17th Floor,
Ratchadaphisek RD., Dindaeng,
Bangkok 10320, Thailand
Tel: 02-641-2951

THE PEOPLE'S REPUBLIC OF CHINA AND OTHER ASIAN COUNTRIES

**Yamaha Corporation,
Asia-Pacific Music Marketing Group**
Nakazawa-cho 10-1, Hamamatsu, Japan 430-8650
Tel: 053-460-2317

OCEANIA

AUSTRALIA

Yamaha Music Australia Pty. Ltd.
Level 1, 99 Queensbridge Street, Southbank, Victoria
3006, Australia
Tel: 3-9693-5111

NEW ZEALAND

Music Houses of N.Z. Ltd.
146/148 Captain Springs Road, Te Papapa,
Auckland, New Zealand
Tel: 9-634-0099

COUNTRIES AND TRUST TERRITORIES IN PACIFIC OCEAN

**Yamaha Corporation,
Asia-Pacific Music Marketing Group**
Nakazawa-cho 10-1, Hamamatsu, Japan 430-8650
Tel: 053-460-2312

HEAD OFFICE Yamaha Corporation, Pro Audio & Digital Musical Instrument Division
Nakazawa-cho 10-1, Hamamatsu, Japan 430-8650
Tel: 053-460-3273



Yamaha Manual Library
<http://www2.yamaha.co.jp/manual/english/>