

 **YAMAHA**

MODULATION DELAY
UD-Stomp

Owner's Manual



FCC INFORMATION (U.S.A.)

1. IMPORTANT NOTICE: DO NOT MODIFY THIS UNIT!

This product, when installed as indicated in the instructions contained in this manual, meets FCC requirements. Modifications not expressly approved by Yamaha may void your authority, granted by the FCC, to use the product.

2. IMPORTANT: When connecting this product to accessories and/or another product use only high quality shielded cables. Cable/s supplied with this product MUST be used. Follow all installation instructions. Failure to follow instructions could void your FCC authorization to use this product in the USA.

3. NOTE: This product has been tested and found to comply with the requirements listed in FCC Regulations, Part 15 for Class "B" digital devices. Compliance with these requirements provides a reasonable level of assurance that your use of this product in a residential environment will not result in harmful interference with other electronic devices. This equipment generates/uses radio frequencies and, if not installed and used according to the instructions found in the users manual, may cause interference harmful to the operation of other electronic devices. Compliance with FCC regulations does not guarantee that

interference will not occur in all installations. If this product is found to be the source of interference, which can be determined by turning the unit "OFF" and "ON", please try to eliminate the problem by using one of the following measures:

Relocate either this product or the device that is being affected by the interference.

Utilize power outlets that are on different branch (circuit breaker or fuse) circuits or install AC line filter/s.

In the case of radio or TV interference, relocate/reorient the antenna. If the antenna lead-in is 300 ohm ribbon lead, change the lead-in to co-axial type cable.

If these corrective measures do not produce satisfactory results, please contact the local retailer authorized to distribute this type of product. If you can not locate the appropriate retailer, please contact Yamaha Corporation of America, Electronic Service Division, 6600 Orangethorpe Ave, Buena Park, CA90620

The above statements apply ONLY to those products distributed by Yamaha Corporation of America or its subsidiaries.

* This applies only to products distributed by YAMAHA CORPORATION OF AMERICA.

CANADA

This Class B digital apparatus complies with Canadian ICES-003.

Cet appareil numérique de la classe B est conforme à la norme NMB-003 du Canada.

* This applies only to products distributed by Yamaha Canada Music Ltd.
* Ceci ne s'applique qu'aux produits distribués par Yamaha Canada Musique Ltée.

ADVARSEL!

Lithiumbatteri—Eksplodingsfare ved fejlagtig håndtering. Udskiftning må kun ske med batteri af samme fabrikat og type. Levér det brugte batteri tilbage til leverandøren.

VARNING

Explosionsfara vid felaktigt batteribyte. Använd samma batterityp eller en ekvivalent typ som rekommenderas av apparattillverkaren. Kassera använt batteri enligt fabrikantens instruktion.

VAROITUS

Paristo voi räjähtää, jos se on virheellisesti asennettu. Vaihda paristo ainoastaan laitevalmistajan suosittelemaan tyyppiin. Hävitä käytetty paristo valmistajan ohjeiden mukaisesti.



The exclamation point within the equilateral triangle is intended to alert the user to the presence of important operating and maintenance (servicing) instructions in the literature accompanying the product.



The lightning flash with arrowhead symbol, within the equilateral triangle, is intended to alert the user to the presence of uninsulated "dangerous voltage" within the product's enclosure that may be of sufficient magnitude to constitute a risk of electrical shock.

NEDERLAND / NETHERLAND

- Dit apparaat bevat een lithium batterij voor geheugen back-up.
- This apparatus contains a lithium battery for memory back-up.
- Raadpleeg uw leverancier over de verwijdering van de batterij op het moment dat u het apparaat aan het einde van de levensduur afdankt of de volgende Yamaha Service Afdeling:
Yamaha Music Nederland Service Afdeling
Kanaalweg 18-G, 3526 KL UTRECHT
Tel. 030-2828425
- For the removal of the battery at the moment of the disposal at the end of the service life please consult your retailer or Yamaha Service Center as follows:
Yamaha Music Nederland Service Center
Address : Kanaalweg 18-G, 3526 KL UTRECHT
Tel : 030-2828425
- Gooi de batterij niet weg, maar lever hem in als KCA.
- Do not throw away the battery. Instead, hand it in as small chemical waste.

IMPORTANT SAFETY INSTRUCTIONS

INFORMATION RELATING TO PERSONAL INJURY, ELECTRICAL SHOCK, AND FIRE HAZARD POSSIBILITIES HAS BEEN INCLUDED IN THIS LIST.

WARNING- When using any electrical or electronic product, basic precautions should always be followed. These precautions include, but are not limited to, the following:

1. Read all Safety Instructions, Installation Instructions, Special Message Section items, and any Assembly Instructions found in this manual **BEFORE** making any connections, including connection to the main supply.

2. Do not attempt to service this product beyond that described in the user-maintenance instructions. All other servicing should be referred to qualified service personnel.

3. Main Power Supply Verification: Yamaha products are manufactured specifically for the supply voltage in the area where they are to be sold. If you should move, or if any doubt exists about the supply voltage in your area, please contact your dealer for supply voltage verification and (if applicable) instructions. The required supply voltage is printed on the name plate. For name plate location, please refer to the graphic found in the Special Message Section of this manual.

4. DANGER-Grounding Instructions: This product must be grounded and therefore has been equipped with a three pin attachment plug. If this product should malfunction, the ground pin provides a path of low resistance for electrical current, reducing the risk of electrical shock. If your wall socket will not accommodate this type plug, contact an electrician to have the outlet replaced in accordance with local electrical codes. Do NOT modify the plug or change the plug to a different type!

5. WARNING: Do not place this product or any other objects on the power cord or place it in a position where anyone could walk on, trip over, or roll anything over power or connecting cords of any kind. The use of an extension cord is not recommended! If you must use an extension cord, the minimum wire size for a 25' cord (or less) is 18 AWG. NOTE: The smaller the AWG number, the larger the current handling capacity. For longer extension cords, consult a local electrician.

6. Ventilation: Electronic products, unless specifically designed for enclosed installations, should be placed in locations that do not interfere with proper ventilation. If instructions for enclosed installations are not provided, it must be assumed that unobstructed ventilation is required.

7. Temperature considerations: Electronic products should be installed in locations that do not seriously contribute to their operating temperature. Placement of this product close to heat sources such as; radiators, heat registers etc., should be avoided.

8. This product was NOT designed for use in wet/damp locations and should not be used near water or exposed to rain. Examples of wet /damp locations are; near a swimming pool, spa, tub, sink, or wet basement.

9. This product should be used only with the components supplied or; a cart ,rack, or stand that is recommended by the manufacturer. If a cart, rack, or stand is used, please observe all safety markings and instructions that accompany the accessory product.

10. The power supply cord (plug) should be disconnected from the outlet when electronic products are to be left unused for extended periods of time. Cords should also be disconnected when there is a high probability of lightning and/or electrical storm activity.

11. Care should be taken that objects do not fall and liquids are not spilled into the enclosure through any openings that may exist.

12. Electrical/electronic products should be serviced by a qualified service person when:

- The power supply cord has been damaged; or
- Objects have fallen, been inserted, or liquids have been spilled into the enclosure through openings; or
- The product has been exposed to rain; or
- The product does not operate, exhibits a marked change in performance; or
- The product has been dropped, or the enclosure of the product has been damaged.

13. This product, either alone or in combination with an amplifier and headphones or speaker/s, may be capable of producing sound levels that could cause permanent hearing loss. DO NOT operate for a long period of time at a high volume level or at a level that is uncomfortable. If you experience any hearing loss or ringing in the ears, you should consult an audiologist.

IMPORTANT: The louder the sound, the shorter the time period before damage occurs.

14. Some Yamaha products may have benches and/or accessory mounting fixtures that are either supplied as a part of the product or as optional accessories. Some of these items are designed to be dealer assembled or installed. Please make sure that benches are stable and any optional fixtures (where applicable) are well secured **BEFORE** using. Benches supplied by Yamaha are designed for seating only. No other uses are recommended.

PLEASE KEEP THIS MANUAL

Thank you for purchasing the Yamaha UD-Stomp.

To fully understand the functions and to obtain maximum life from this device, please read this Owner's Manual carefully before using. Also, after reading this manual please keep it in a safe place for future reference.

Contents

Precautions	5	• Selecting a Wave (WAVE)	17
Nomenclature	6	• Setting the Phase (PHASE)	18
■ Top Panel	6	• Setting the Effect and Direct Volume Levels ...	18
■ Rear Panel	9	• Setting the Pan of the Direct Sound	18
Connections	10	• Setting the Output Volume	18
■ Connecting the Power	10	Selecting and Saving Patches	19
■ Connecting the UD-Stomp	10	■ Try Selecting Another Patch	19
■ Connecting Headphones	11	■ Create and Store a Patch	21
■ Digital Output	11	Convenient Functions	22
■ Connecting an Expression (EXP) Pedal	11	External Control Settings	24
■ Connecting MIDI Devices	11	Utility Mode	25
Using the UD-Stomp	12	■ About the Utility Mode	25
■ Preparation	12	■ MIDI Functions	25
• Selecting an Effect Band	13	■ External Control Settings	26
• Setting the Delay Time	13	■ EXP Pedal Settings	27
• Setting the Feedback	14	Trouble Shooting	28
• Setting the Filters	14	Error Messages	28
• Setting the Pan	14	Specifications	29
• Setting the Delay Level	14	MIDI Implementation Chart	30
• Setting the Tap	14		
• Setting the Modulation	15		
• Connecting Multiple Effect Bands (CONNECT)	15		
• Grouping Multiple Effect Bands (GROUP)	16		
• Syncing Multiple Effect Bands (SYNC)	17		

Precautions

- Avoid using the UD-Stomp in the following locations to prevent possible damage:
 - In direct sunlight or next to heating equipment.
 - In extremely cold or hot locations.
 - Locations exposed to high humidity or excessive dust.
 - Locations subject to strong shocks or vibration.
- Before making any connections, make sure that the power is switched OFF on the UD-Stomp and any external devices.
- To protect speakers from possible damage, always set the OUTPUT knob to “0” before switching the power ON/OFF.
- When connecting any devices to this unit, make sure that the power is switched OFF first.
- Do not apply excessive force to the switches, knobs and controls.
- The UD-Stomp is a precision device. Handle it with care and avoid dropping or jarring it.
- Operating temperatures will rise during use. Make sure the UD-Stomp is used in a well-ventilated area.
- For safety, always remove the power adaptor from the AC wall outlet if there is any danger of lightning striking in your area.
- Keep the UD-Stomp away from neon signs or fluorescent lighting to prevent noise pickup.
- To prevent damage and possibly electrical shock, never open the case and tamper with the internal circuitry.
- Never use benzene, thinner or other volatile liquids for cleaning, as these chemicals may cause damage or discoloration to the finish. Always use a dry, soft cloth to wipe off dust and dirt.

About the Backup Battery

A backup battery (lithium battery) is used to keep internal data (settings) from being lost, even when the power cord is unplugged. Internal data will be lost when battery power is depleted, so it is recommended that data be stored to an external data recorder such as the Yamaha MIDI Data Filer MDF3 (→ page 26), or keep records of settings in memo form. The average battery life span is about 3 years. When replacement becomes necessary contact the music store where the unit was purchased, or a qualified service representative, to perform the replacement.

- *Do not attempt to replace the backup battery by yourself.*
- *Keep the backup battery out of reach of children.*
- *“E 5” appears in the display when the battery becomes depleted. Internal data may be lost.*
- *Data may be lost if the unit is improperly handled or if repairs are performed.*

Nomenclature

■ Top Panel

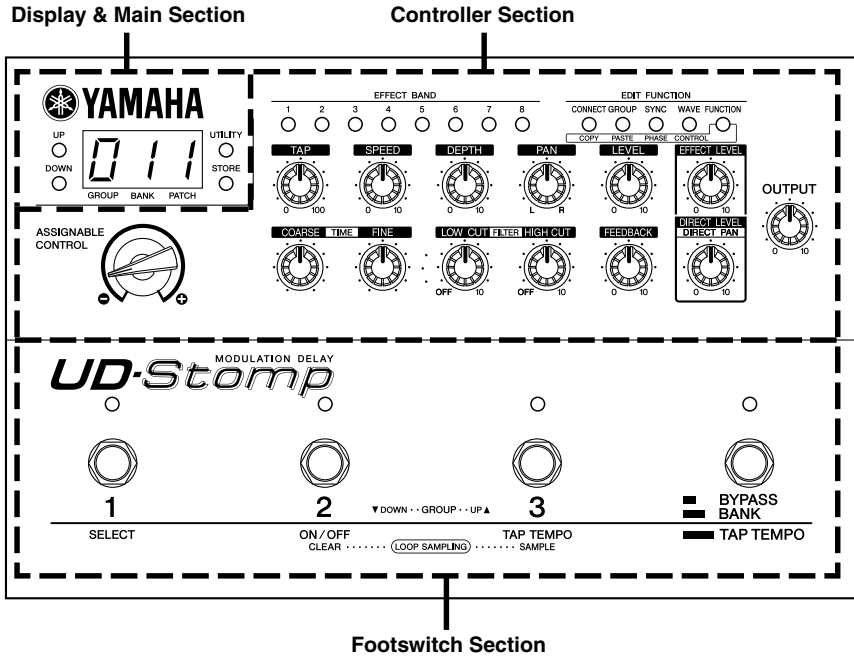

● Display & Main Section

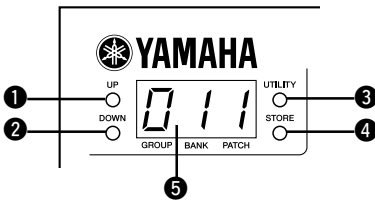

1 Up Button (UP)

2 Down Button (DOWN)

Press to change the Patch Number by +1/-1. Hold to change the Group Number by +1/-1. Simultaneously press the [UP] and [DOWN] buttons to switch between the USER ↔ PRESET Areas.

Also, their flashing lamps are used to indicate the relationship between the patch data value and the knob's position.

3 Utility Button (UTILITY)

Enters the Utility Mode. (→ page 25)

4 Store Button (STORE)

Enters the Store Mode. (→ page 21)

5 Display

Displays memory numbers, parameter setting values, etc.

● Controller Section

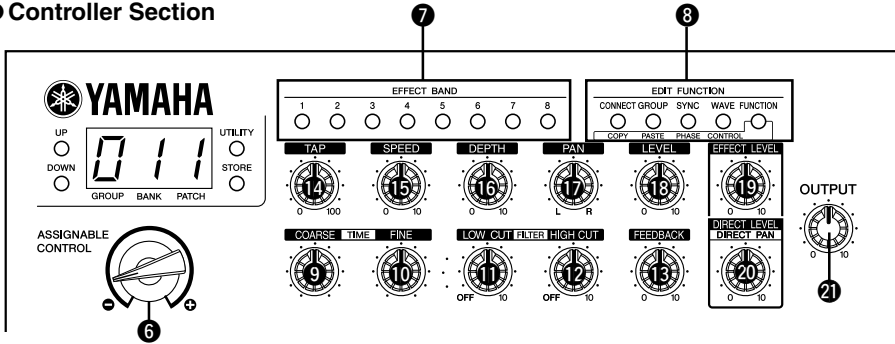

⑥ ASSIGNABLE CONTROL

You can assign one of the functions of Effect Parameter Controllers ⑨ - ⑳ to this knob. (→ page 24)

⑦ EFFECT BAND 1-8

Switches the corresponding EFFECT BAND 1-8 ON/OFF and selects an Effect Band for editing.

* To switch the effect ON→OFF, hold the button down until “OFF” appears in the display.

* You can also “tap” on the button to set the delay time according to the tempo at which the button was tapped. (→ page 13)

The EFFECT BAND lamps will light in the following manner to indicate the current condition of the Effect Band’s settings.

- Lamp lights: Effect is ON
- Lamp off: Effect is OFF
- Lamp flashes (rapidly): Editing
- Lamp flashes (slowly): Input is switched OFF (→ page 22)

* When an Effect Band is switched ON, holding the [FUNCTION] button and pressing the EFFECT BAND button will switch the input for that Effect Band ON/OFF. However, when a group is selected, only the Effect Band that is at the head of the selected group can be switched ON/OFF.

In the Utility Mode, this button is used to select system settings such as Footswitch Functions, MIDI Functions, etc.

⑧ EDIT FUNCTION

These buttons are used to set parameters that determine how multiple Effect Bands are connected, made into groups, synced and for setting the type of modulation wave, etc.

- **CONNECT:** Connects Effect Bands
- **GROUP:** Groups multiple Effect Bands
- **SYNC:** Synchronizes the modulation speed between multiple Effect Bands.

- **WAVE:** Selects the modulation wave to be used.
- **FUNCTION:** Provides access to the secondary functions of those buttons or controllers that have secondary functions (COPY, PASTE, PHASE, CONTROL setting, DIRECT PAN).

The lamps indicate current parameter conditions for the currently selected Effect Band.

Controllers ⑨ - ⑬ listed below are used to settings for individual parameters for each of the Effect Bands. Parameter changes will be made to the Effect Band that is currently selected with the EFFECT BAND Switch. Also, when the selected Effect Bands are combined into a Group, parameters ⑨ - ⑬ will be set in the Effect Band that is at the head of the selected group.

⑨ Delay Time Control: Coarse (TIME COARSE)

⑩ Delay Time Control: Fine (TIME FINE)

Sets the delay time.

The TIME COARSE knob is used to set the approximate time while the TIME FINE knob is used to set the precise time.

⑪ LOW CUT FILTER Control

Sets the cut off frequency of the low cut filter. This is used to cut frequencies that are lower than the cut off frequency.

When the knob is rotated fully to the left (OFF) the filter is OFF. Rotate the knob to the right to raise the cut off frequency.

⑫ HIGH CUT FILTER Control

Sets the cut off frequency of the high cut filter. This is used to cut frequencies that are higher than the cut off frequency.

Nomenclature

When the knob is rotated fully to the left (OFF) the filter is OFF. Rotate the knob to the right to lower the cut off frequency.

13 FEEDBACK Control

Sets the how many times the delay will repeat.

14 TAP Control

Sets the timing for when the delayed sound is taken from the delay loop.

The value of the parameter is expressed as a percentage of the delay time setting.

15 SPEED Control

Sets the speed of the modulation.
When multiple Effect Bands are Synced together, this knob adjusts the phase angle.

16 DEPTH Control

Sets the intensity of the modulation.

17 PAN Control

Sets the position of the delay within the stereo field.

18 Delay Level Control (LEVEL)

Sets the output level of the delay.

** Rotating the knob fully to the left (OFF) mutes the delay sound.*

Controllers 19 - 21 listed below are global parameters for Effect Bands 1-8. They can be set at any time, even if no Effect Bands are selected.

19 EFFECT LEVEL Control

Sets the overall level of the signal sent to the effect.

20 DIRECT LEVEL/DIRECT PAN Control

Sets the output level of the direct sound.
Hold the FUNCTION button and rotate this knob to set the stereo position of the direct sound.

21 OUTPUT Level Control

Controls the signal level that is sent from the UD-Stomp's output jack (OUTPUT, PHONES).

● Footswitch Section

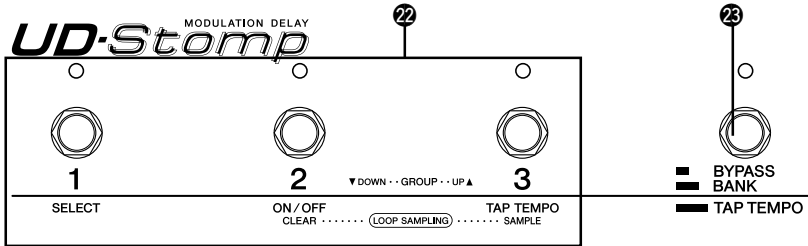

22 Footswitches 1, 2, 3

These are used to select a patch (1, 2, 3) in the currently selected Group/Bank. The lamp for the selected patch number will light. Pressing the Footswitch that has its lamp lit will switch the effect OFF as well as the Footswitch's lamp.

Depending upon the BANK switch setting, these switches can also be used to select the patch's Area/Group/Bank, set the Tap Tempo, and for the Sampling function.

** When the effect is switched OFF with the Footswitches 1, 2 or 3, the delayed sound up to that point will remain. When the BYPASS switch is pressed to bypass the effect, the delay sound will be muted momentarily.*

23 Bank Switch (BYPASS, BANK, TAP TEMPO)

- **Press and release the switch quickly (BYPASS):** All Effect Bands are bypassed leaving only output of the direct sound. When the Bypass is switch ON, the lamp lights.

** In the bypass mode, the input signal from the instrument is sent directly to the output (DIRECT LEVEL and DIRECT PAN settings will have no effect).*

- **Hold the switch until all footswitch lamps (1-3) light (BANK):** Use Footswitches 1-3 to select an Area/Group/Bank. (→ page 20)
- **Hold the switch until "LRP" appears in the display (TAP TEMPO):** Tap the Footswitch set the delay time to the tempo at which the footswitch is tapped. The Loop Sampling Function is also available. (→ page 22)

■ Rear Panel

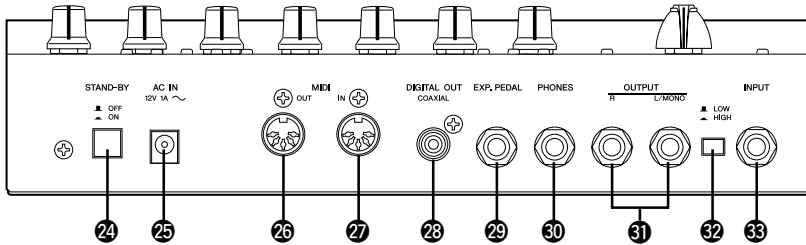

24 Power Switch (STAND-BY ON/OFF)

Power switch for the main unit.

* To protect the speakers, set the OUTPUT knob 21 to "0" before switching the power ON/OFF.

25 Power Adaptor Jack (AC IN 12V 1A)

Connect the supplied power adaptor to this jack.

* Never use a power adaptor other than the supplied adaptor. Use of any other power adaptor may cause damage, overheating, fire, etc.

26 MIDI OUT Jack

This jack is used for transmitting MIDI data from the UD-Stomp such as control changes, program changes, data in the UD-Stomp's memory, etc. (→ page 26).

27 MIDI IN Jack

This jack is used for receiving MIDI data from a MIDI device, such as a MIDI foot controller, that can be used to select patches, volume, or control each of the effects in the UD-Stomp. (→ page 20)

Also, UD-Stomp memory data saved to an external MIDI device can be returned to the UD-Stomp via this jack. (→ page 26)

28 DIGITAL OUT Jack

This Jack is used for sending the output of the UD-Stomp as digital data.

Connect to a device equipped with a digital input jack (COAXIAL) such as a digital mixer, etc. (→ page 11).

29 Expression Pedal Jack (EXP. PEDAL)

This jack is used to connect a foot controller (expression pedal) (optional) such as a Yamaha FC-7 to control individual UD-Stomp parameters. (→ page 24, 26, 27).

30 Headphones Jack (PHONES)

Connect a pair of headphones (optional) to this jack for private practice or practicing at night when you don't want to disturb others. (→ page 11).

* Even when headphones are used, the audio signal is delivered from the OUTPUT jack 31 and the DIGITAL OUT jack 28.

31 Output Jacks (OUTPUT R, L/MONO)

The analog output jacks for the UD-Stomp. Connect these jacks to the input jack on a power amplifier + speaker set or guitar amp, mixer, etc. (→ page 10)

* Use the L/MONO jack when connecting to a monaural device.

32 Input Level Switch (LOW/HIGH)

33 INPUT Jack

This is the UD-Stomp's input jack. Connect a guitar or other electric musical instrument to this jack. Select either HIGH or LOW to match UD-Stomp's input jack to the output level of the instrument connected to the jack.

* Make sure the power is switched OFF before connecting the instrument.

Connections

! Before making any connections to any of the UD-Stomp's INPUT and/or OUTPUT jacks, make sure that the power on the UD-Stomp and all other devices is turned OFF to prevent electrical shock or damage to the devices.

■ Connecting the Power

Use the supplied power adaptor (AC-10) to supply power to the UD-Stomp.

1. Make sure the UD-Stomp's Power Switch (STAND-BY) is in the OFF (■) position.
2. Connect the power adaptor's plug to the AC IN jack on the UD-Stomp.
3. Connect the power adaptor to an electric outlet.

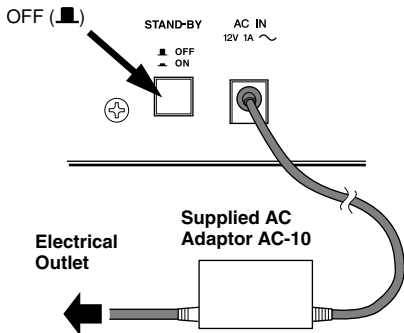

! Only use the supplied AC-10 adaptor to power the unit. Using another adaptor may result in damage, overheating or fire, which can be very dangerous.

! Make sure to use the recommended AC voltage as indicated on the power adaptor.

! The supplied power adaptor AC-10 is designed specifically for use with the UD-Stomp. Never use this adaptor with any other device.

■ Connecting the UD-Stomp

Since the UD-Stomp is a delay effect, it should be connected to the end of the effect chain when used with other effects. If the guitar amplifier or mixer you are using is equipped with a Send/Return circuit, we recommend that the UD-Stomp be connected to these jacks.

The Input Level switch should be set according to the output level of the device connected to the UD-Stomp (set to LOW if the device's output level is high, set to HIGH if the output is low).

Also, for maximum effect, connect the OUTPUT jacks to a stereo system.

When connecting to a monaural device, make sure you use the OUTPUT's L/MONO jack.

● Connecting to the Effect Send and Return circuit

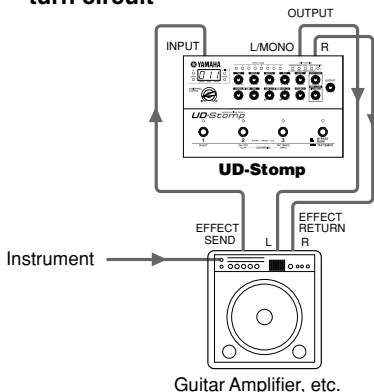

● Connecting at the end of an effects chain

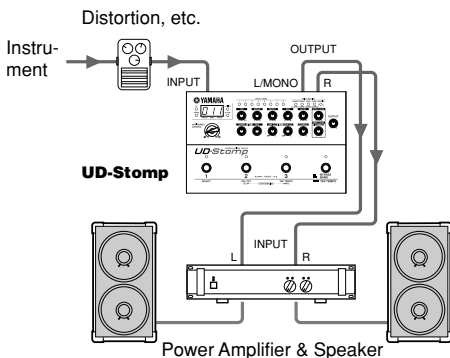

■ Connecting Headphones

Connect a pair of headphones to the PHONES jack (standard stereo) on the UD-Stomp to play or practice in private.

The volume of the headphones can be controlled with the OUTPUT knob.

** When a pair of headphones is connected, the output from the OUTPUT jack and the DIGITAL OUT jack will still deliver sound output.*

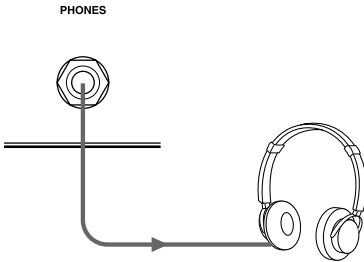

When using headphones, use at a comfortable volume so as not to cause shock to your hearing.

■ Digital Output

The UD-Stomp is equipped with a DIGITAL output jack (COAXIAL, 44.1 kHz), that can be connected to the DIGITAL INPUT jack on a digital mixer, MD recorder, etc.

** The output level of the DIGITAL OUT jack cannot be controlled with the OUTPUT knob (fixed).*

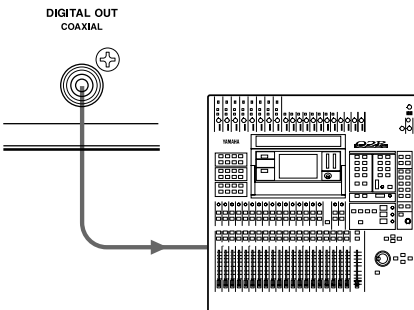

Digital Mixer, MD Recorder, etc.

■ Connecting an Expression (EXP) Pedal

A foot controller (expression pedal), such as the Yamaha FC-7 (optional) connected to the UD-Stomp's EXP. PEDAL jack allows control of the UD-Stomp's individual parameters with your foot. (→ page 24, 26, 27)

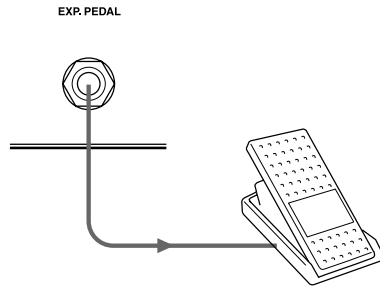

■ Connecting MIDI Devices

The UD-Stomp's MIDI IN/OUT jacks allow the exchange of MIDI information between the UD-Stomp and an external MIDI device.

Using MIDI you can take data from the UD-Stomp and store it in a MIDI device such as the Yamaha MIDI Data Filer MDF3, etc. or load data from the external device into the UD-Stomp.

You can also use a MIDI foot controller, etc. connected to the UD-Stomp to select patches, control individual parameters, etc., and an external MIDI device can be controlled from the UD-Stomp. Refer to the [Utility Mode] (page 25) for more information on MIDI functions.

Using the UD-Stomp

The UD-Stomp is an effects processor that is equipped with eight identical delay circuits. It provides you with the power and freedom to create complex sounds by connecting multiple delay circuits in a series, or combine any or all of the individual circuits into a single, long delay, etc.

This section will use some of the UD-Stomp's preset programs as examples to help you understand how the parameters and functions work.

■ Preparation

1. Connect your instrument, amplifier, a pair of headphones, etc. to the UD-Stomp. (→ page 10, 11)

Before making any connections, make sure that the power is switched OFF on all devices.

2. Set the OUTPUT knob to "0", and then set the Power Switch (STAND-BY) to ON (▲).

! If the Power Switch is switched ON with the OUTPUT knob turned up, a sudden outburst of sound due to the high volume setting may damage your hearing, or damage devices connected to the unit such as the amplifier, speaker, headphones, etc.

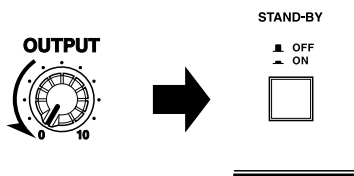

3. A 3-digit number, such as "0 1 1", appears in the display.



These numbers (Group Number: 0, Bank Number: 1, Patch Number: 1) refer to the currently selected patch program.

Note: When the patch program number is shown in the display, this condition is known as the Play Mode. When in the Play Mode, it is possible to select patches for playing and edit parameters.

For now, use this patch program to get some sound from the system, and adjust the sound volume.

While playing your instrument, rotate the OUTPUT knob to the right and adjust the volume to an optimum level.



4. Let's recall patch number "9 1 1" which is an empty patch.

Press and hold the [DOWN] button, located to the left of the display, and the Group number will decrease one by one. If the number goes past the Group number you want, press and hold the [UP] button to increase the value by one. Simply pressing the [UP]/[DOWN] button causes the Patch number to increase/decrease by one.

Let's try and set a delay.

Selecting an Effect Band

Let's first select a delay circuit and set its parameters.

The [EFFECT BAND 1-8] buttons are used to switch the eight effect circuits ON/OFF.

1. Press the [EFFECT BAND 1] button to select Effect Band 1 (the selected button's lamp will flash rapidly).

* When an EFFECT BAND button's lamp is flashing rapidly, it indicates that that Effect Band is currently being edited.

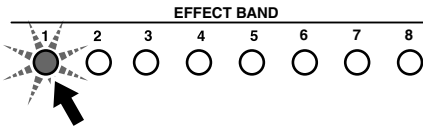

Setting the Delay Time

Next, let's set the Delay Time.

Use the TIME COARSE (rough setting) and TIME FINE (precise setting) knobs to set the Delay Time.

2. In this step, we will set a delay time of 250msec. Rotate the TIME COARSE knob until "200." appears in the display.

* The value for time used in the delay is msec (milliseconds). The dot indicates the position of the decimal point.

Example) 200. = 200 msec

When the value is over 1000msec (no dot in the display), the value in the display should be multiplied by 10.

Example) 123 = 1230 msec

If "0.02" is flashing in the display and the [DOWN] lamp flashes when you rotate the knob, it indicates that the knob's position is not aligned with the value set for the parameter. First rotate the knob all the way to the left, then rotate to the right to set the value.

Using the Knobs

Since the position of each knob on the panel is not always aligned with the value set in the parameter of the current patch, please follow the rules described below to align the knob with the parameter value.

- If the [UP] lamp flashes when the knob is rotated, rotate the knob to the right (toward 10), and if the [DOWN] lamp flashes, rotate the knob to the left (toward 0).

At this time, the knob's parameter value set in the current patch is flashing in the display.

* As long as the lamp is flashing, neither the value in the display nor the sound will change even though the knob is being rotated.

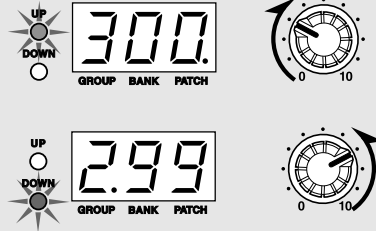

- Continue rotating the knob in the direction described above. Once the knob has reached the position that corresponds to the parameter value, the value in the display and the [UP]/[DOWN] lamp will stop flashing and the value will now change according to the position of the knob.

* After you stop moving the knob, the value will continue to be displayed for about 2 seconds, after which it will return to the normal display.

- Once the knob is aligned with the value and can be used to edit the value, rotating the knob will result in the value shown in the display changing in regards to the knob's position and a relative change in the effect's sound.

These rules apply to all knobs with the exception of the OUTPUT knob.

3. Next, rotate the TIME FINE knob so that "250." is shown in the display. If "200." is flashing in the display, rotate the knob all the way to the left and then to the right as described in step 2 and above.

* The delay time of an individual Effect Band can be set to a maximum of 696msec. Using the Group setting, a maximum delay of 5890msec can be obtained by grouping all 8 Effect Bands together. (→ page 16)

* The delay time can also be set by tapping the [EFFECT BAND 1-8] button twice in tempo, after the Effect Band has been selected. The delay time will be set to the tempo at which the button is pressed.

* You can also tap the Footswitch twice in tempo to set the delay time to the tempo at which the Footswitch was tapped. (→ page 22)

Using the UD-Stomp

Setting the Feedback

Up to this point we have set the delay time so a single delay sound is produced 250msec after the original sound. Next, set the Feedback parameter to determine how many times the delay will repeat.

4. Rotate the FEEDBACK knob so that “10.0” appears in the display. The delay sound is repeated infinitely without fading out. When the FEEDBACK is set to a lower value, the number of times the delay is repeated will decrease and the delay sound will fade out. In this step, set the FEEDBACK level to “5.0”.

Setting the Filters

The delay circuit also includes a HCF (High Cut Filter) which, cuts high frequencies, and a LCF (Low Cut Filter) which, cuts low frequencies. Since these filters are incorporated in the delay loop, the cutting of the effected frequencies will be greater each time the delay is repeated.

5. Rotate the LOW CUT FILTER knob or HIGH CUT FILTER knob and see how the filters change the sound.

** For both knobs, a setting of 10 (10.0) equals a cutoff frequency of 1kHz and setting of 0 equals off (OFF).*

** The cutoff is also applied to the first delay.*

The use of these filters offers analog simulation, etc. Once you understand how the filters operate, set both knobs to “OFF” and let’s move on to the next step.

Setting the Pan

The term “Pan” refers to the position of the delayed sound within the stereo field of the left and right speakers. Use the PAN knob to set the position of the delayed sound somewhere between left (L 10), center (C) and right (r 10) as shown in the illustration below.

6. Rotate the PAN knob and see how the delay sound moves between the left and right speakers. Once you understand how the PAN knob operates, set the PAN knob to “C” and let’s move on to the next step.

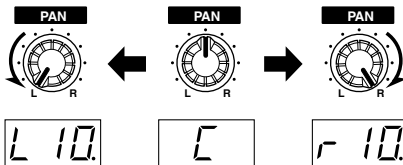

Setting the Delay Level

The LEVEL knob is used to control the volume level of the delay sound.

7. First, rotate the FEEDBACK knob and set its value to “0.0” so that it is easier to hear how the sound changes.

Rotate the LEVEL knob and adjust the volume level of the delay sound. Rotating the knob all the way to the right (10.0) will make the delay’s volume equal to the volume of the original sound. Rotate the knob all the way to the left (0.0) and the delay sound will not be heard.

Setting the Tap

In this case, the term “Tap” refers to the timing at which the delay sound is taken out of the delay loop. Try the next steps and see how this effect works.

8. Use the [UP] button and recall patch “9. 12”. This patch will make it easy to understand how this effect works.

In this patch a 360msec delay is already set to both Effect Bands 1 and 2. Notice that the delay sound is louder than the original. That’s because both delay sounds, which are heard simultaneously, are set at the same level as the original sound.

9. Press the [EFFECT BAND 1] button and rotate the TAP knob to change Tap Value of Effect Band 1.

When the value is around “66.6” % notice how the sound of the two delays creates a shuffle rhythm. What happens is the delay sound from Effect Band 1 is being produced at 240msec, which is 2/3 (66.6%) of its 360msec delay time.

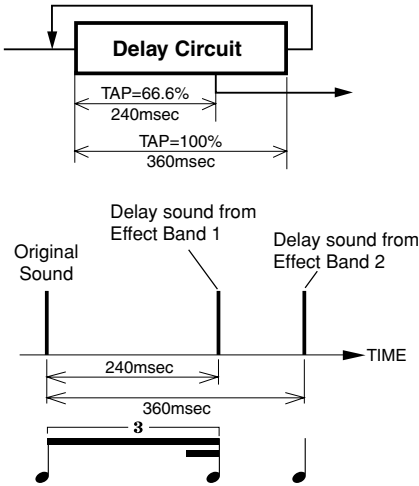

- 10.** In this step, set the FEEDBACK of Effect Band 1 to “5.0”. Now the first delay is produced after 240msec but the delays that follow that are produced at 360msec.

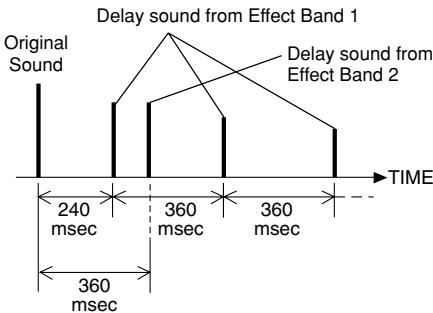

- 11.** Next, set the FEEDBACK of Effect Band 2 to “5.0” as well. First press the [EFFECT BAND 2] button to select Effect Band 2, then use the FEEDBACK knob. Now, the shuffle rhythm is repeated.
- 12.** Now, try setting the PAN of Effect Band 1 all the way to the left (L 1.0) and the PAN of Effect Band 2 all the way to the right (R 1.0). Now you’ve created a stereo ping-pong delay effect.

Setting the Modulation

Adding Modulation to the Delay Time causes the delay sound’s pitch to change. This can be used to create effects such as chorus, flanger, etc.

- 13.** Recall patch “9.11” again.
- 14.** Press the [EFFECT BAND 1] button and use the TIME COARSE knob to set the delay time to “50.0”.
- 15.** Set the SPEED knob to “4.0” and the DEPTH knob to “10.0” and listen to the resulting sound. The pitch of the delayed sound goes up and down. This is a Modulation effect.
- 16.** To get a Chorus effect, set the delay time somewhere between 5 and 20msec, then adjust the SPEED (to make the pitch fluctuating) and DEPTH (to increase the intensity of the effect). Also, you create a richer sound by using multiple Effect Bands or by changing the PAN position from right to left. Try varying these parameters and see what you get.
- 17.** To get a Flanger effect, set the Delay Time shorter than that for the Chorus effect (less than 5msec) then use the SPEED and DEPTH knobs to produce the Flanger effect. To get a deeper Flanger effect, increase the FEEDBACK level.

Connecting Multiple Effect Bands (CONNECT)

Try connecting the 8 Effect Bands together. You can create a wide variety of delays by connecting multiple Effect Bands into series or parallel arrangements.

- 18.** Recall patch “9.13”. This patch uses two delay circuits (Effect Bands 1 and 2) with a parallel connection. Effect Band 1 has a long delay of 600msec while Effect Band 2 has a short delay time of 80msec. FEEDBACK on both Effect Bands is set to 0. Press the [EFFECT BAND 1] button (this selects Effect Band 1) then press the [CONNECT] button at which time “11” appears in the display. This indicates that the signal received by the delay circuit of Effect Band 1 is coming directly from the UD-Stomp’s INPUT jack. Effect Band 2 is also set to “11”.

Using the UD-Stomp

Now Effect Bands 1 and 2 are connected as shown in the illustration below.

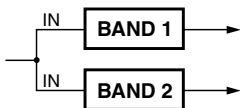

You can hear a single short delay and a single long delay being produced.

19. Next, try and connect Effect Bands 1 and 2 in a series.

Press the [EFFECT BAND 2] button, then hold the [CONNECT] button and press the [UP] button so that "1" is shown in the display.

The output signal of Effect Band 1 (the original sound mixed with the delay sound) is now sent to the input of Effect Band 2. Effect Band 1 and Effect Band 2 are now connected in a series.

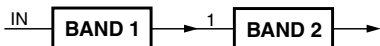

Now you can hear a short delay applied to both the original sound and the long delay sound.

20. Now let's try and make a complex delay using these two Effect Band circuits.

Set the Delay Time of Effect Band 2 to 419msec and increase the FEEDBACK of both Effect Bands equally. With the two Effect Bands connected in a series, the delay effect becomes more and more complex as the delay is repeated. Try changing Delay Time for each Effect Band to create some other effects.

** Parallel and series connections can be mixed together. You can also synchronize the modulation between Effect Bands (→ page 17) to create a more complex delay effect.*

• Example Connections

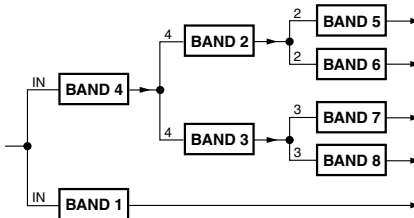
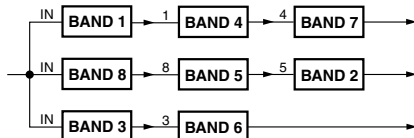
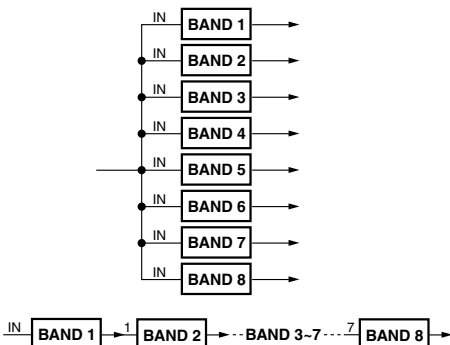

Grouping Multiple Effect Bands (GROUP)

The Group function makes possible longer delay times by combining multiple Effect Bands into a single delay circuit.

21. Let's try and make a long delay time. Recall patch "9. 1 1" and press the [EFFECT BAND 1] button, then use the TIME COARSE knob and TIME FINE knob to set the delay time to its maximum of "596" msec.

22. Hold the [GROUP] button and use the [UP] button to set the parameter to "1-2". Now Effect Bands 1 and 2 are combined into a single delay circuit that is referred to as a Group. Notice now that the delay time is longer. Rotate the TIME COARSE knob a little and notice that the Delay Time shown in the display is "143" (1430msec). Using this method, you can group together all 8 Effect Bands (set to "1-8") to create a maximum delay of "596" (5890msec).

** When creating a Group, you must first select the Effect Band that will be at the head of the Group, then assign the Effect Band that is at the end of the Group.*

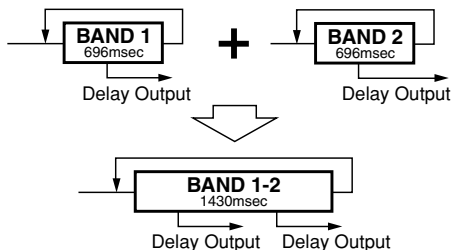

Also, once a Group has been set, you can access any of the outputs from the individual delay units that make up the group.

23. Confirm that Effect Bands 1 and 2 are still combined into a Group (1-2) as explained above. Next, press the [EFFECT BAND 2] button to switch ON Effect Band 2. Since Effect Bands 1 and 2 the same delay time, two delay sounds, of the same level, can be heard simultaneously. Using the same technique as explained in the “Setting the Tap” section (→ page 14) use the TAP knob to create a shuffle rhythm. You can also use the PAN knob to create a ping-pong delay effect. The difference between the TAP setting and the previous one is that in this step, changing the Delay Time lets you alter the tempo of the shuffle rhythm without changing the rhythm itself.

Now press the [EFFECT BAND 1] button and rotate the TIME FINE knob and listen to what happens.

Patch “9.2 1” produces a 16-beat type effect that can also be set to different tempos for keeping rhythm.

** When Effect Bands are combined into a Group, TIME COARSE/FINE, FILTER LOW CUT/HIGH CUT and FEEDBACK knob settings are applied to the lowest numbered Effect Band in the Group.*

Syncing Multiple Effect Bands (SYNC)

When modulation is used in multiple delays, the SYNC function let’s you sync the modulation speed of multiple delay bands.

24. Recall patch number “9.2 2”

This patch uses two Effect Bands; one panned left the other right and each using a monaural chorus effect with synchronized modulation. In this patch, the modulation of Effect Band 2 is synchronized with Effect Band 1. Let’s switch the synchronization OFF in Effect Band 2 and see what happens.

25. Select Effect Band 2 then hold the [SYNC] button and use the [UP] button to set the value in the display to “2”. This indicates that Effect Band 2 is synchronized with Effect Band 2 and no longer synchronized to another Effect Band. In this condition, the modulation can be heard

in the left channel but not in the right because Effect Band 2’s SPEED setting is set to “0.0”. Try setting the SYNC again.

26. Hold the [SYNC] button and press the [DOWN] button to set the value in the display to “1”. Now the modulation in Effect Band 2 is synchronized with the modulation in Effect Band 1.

When the modulation is synchronized, the SPEED knob can be used to create differences in the phase between the synchronized bands. Rotating the SPEED knob creates a greater stereo effect. At this time the modulation speed is the same. The difference in their phase can be set between greater than 0° and less than 360°. Setting the SPEED knob to “5.0” creates a reverse phase (180°). After setting the SPEED to “5.0”, next select Effect Band 1 and rotate the SPEED knob and in this reverse phase condition, the speed can be changed simultaneously in both left and right sides.

Selecting a Wave (WAVE)

When the delay uses modulation, you can choose the wave that is used in the modulation.

27. Recall patch number “9.2 3”.

The sound in the left channel of this patch oscillates. This heavy modulation uses a sine wave. Let’s try changing the wave type.

28. Select Effect Band 1 then holding the [WAVE] button, press the [UP]/[DOWN] buttons and compare the difference between the four waves described below.

** The [WAVE] + [UP] buttons select progress through the waves in the following order,*

5 0 → 5UP → 5dn → tr 1.

The [WAVE] + [DOWN] buttons select 5 0.

- 5 0 A sine wave. The pitch goes smoothly up and down following the curve of a sine wave.
- tr 1 A triangle wave. The pitch jumps up and down.
- 5UP Saw Up. Raises the pitch.
- 5dn Saw Down. Lowers the pitch.

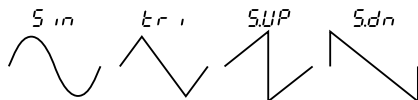

Using the UD-Stomp

Two modulation waves (sine plus one more) can be used at the same time. Press the [EFFECT BAND 2] button to switch Effect Band 2 ON, and you'll hear the sine wave modulation on the right channel while the other wave type modulation is heard on the left.

Setting the Phase (PHASE)

When mixing the delay sound with the direct sound, the phase can be set to normal or reverse. Mixing the direct sound with the sound of the delay with its phase reversed is a good way to create an image of spaciousness with the sound.

29. Recall patch number “9.2 1”

After selecting Effect Band 1, hold the [FUNCTION] button and the [SYNC] button, and press the [UP]/[DOWN] buttons to set either “r E u” (Reverse: reverse phase) or “n o r” (Normal: normal phase) and listen to how the sound changes.

Setting the Effect and Direct Volume Levels

The EFFECT LEVEL knob is used to set the volume level of the delay sound.

The DIRECT LEVEL knob is used to set the volume level of the direct sound.

30. Recall patch number “9.2 1”.

Set the EFFECT LEVEL knob to “0.0” and the DIRECT LEVEL knob to “10.0”. Only the direct sound is produced.

31. Next, set the EFFECT LEVEL knob to “10.0” and the DIRECT LEVEL knob to “0.0”. Now the delay sound is produced and the direct sound is not.

These two knobs are used to control the sound balance between the direct sound and the delay sound.

** The EFFECT LEVEL knob is used to set the level of the signal that is sent to the connected or grouped Effect Bands.*

** Both the EFFECT LEVEL and DIRECT LEVEL knobs can also be set when an Effect Band is not selected.*

Setting the Pan of the Direct Sound

The DIRECT PAN knob is used to set the direct sound's position within the stereo field.

32. With patch number “9.2 1” still selected, hold down the [FUNCTION] button and rotate the DIRECT PAN knob to set the Pan to “L 10”.

The direct sound is heard from the left channel only.

** This is effective only when the direct sound and effect sound are produced from different speakers.*

** The knob's center (L) position = the center of the stereo field. Rotating the knob to the left moves the sound's position to the left (L 0.0 - L 10.) and rotating to the right moves the sound's position to the right (r 0.0 - r 10.).*

** This parameter can be set if an Effect Band is not selected.*

Setting the Output Volume

Use the OUTPUT knob to adjust the UD-Stomp's overall output volume (OUTPUT jack, PHONES jack).

** The Output volume can be set at anytime, even if an Effect Band is not selected.*

This completes explanation of the UD-Stomp's Effect Band parameters.

Use the knowledge you've gained here to create your own original effects or edit the pre-set patches.

Any changes you make to a patch are returned to their original condition when another patch is selected. If you want to save your changes, please use the Store Operation explained on page 21.

Selecting and Saving Patches

■ Try Selecting Another Patch

The UD-Stomp holds a total of 180 patch programs (patch) in its internal memory. The 180 patches are divided into two areas each containing 10 groups, 3 banks and 3 patches.

• AREA

There are two areas, the **USER AREA** and the **PRESET AREA**. When the Store operation is used, data in the USER AREA (90 patches) can be freely rewritten. You can change settings in the PRESET AREA (90 patches) data but you can not rewrite the contents to the PRESET AREA memory.

When a PRESET AREA patch is selected, a dot will appear to the lower right of the hundred's digit on the display (0.11-9.33) When the dot is not lit (011-933), it indicates that a patch in the USER AREA is selected.

** When the UD-Stomp is shipped from the factory, the same patch data as found in the PRESET AREA is used in the USER AREA. Refer to the [Patch List] on the separate "Patch List" sheet.*

• GROUP

The 90 patches in each area are divided into 10 groups (0-9).

• BANK

Each group is divided into 3 banks (1-3).

• PATCH

Each bank contains 3 patches (1-3).

Try selecting some of the different patches and try out some of the different sounds.

To select a different patch, use one of the three methods described below.

● Using the [UP]/[DOWN] buttons on the panel

- Each time the [UP] button is pressed, the next greater **patch number** is selected.

011 → 012 → 013 → 021 → 022 →
023..033 → 111.....933 → 0.11 →
0.12.....9.33 → 0.11 (returns to the top)...

Every time the [DOWN] button is pressed, the next lower **patch number** is selected.

- Press the [UP] button continuously increases the **group number** by one (1).

011 → 111 → 211.....911 → 0.11 →
1.11 → 2.11.....9.11 → 0.11 (returns to the top)...

Press the [DOWN] button continuously decreases the **group number** by one (1).

- Press the [UP] and [DOWN] button simultaneously to switch between the **USER AREA** ↔ **PRESET AREA**.

011 ↔ 0.11

• Patch Characteristics

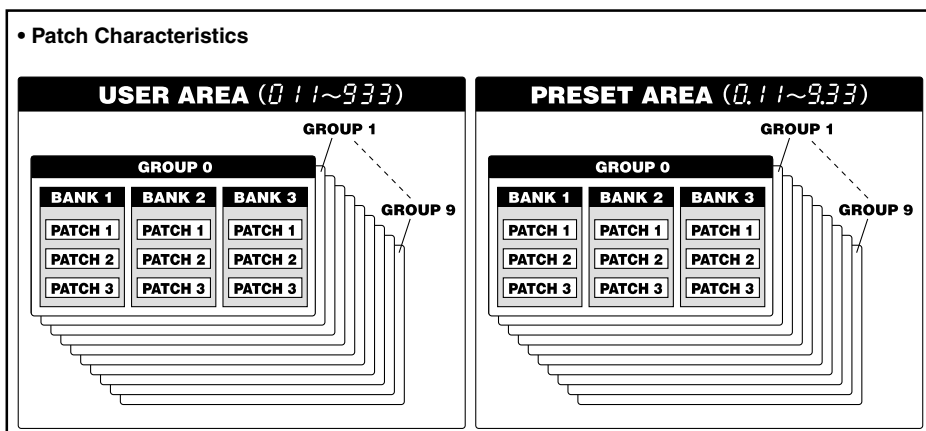

Selecting and Saving Patches

● Using the Foot Switch and the Bank Switch

- Press a foot switch (1-3) to select the corresponding patch number 1-3 in the currently selected group/bank.
 - Press and hold the BANK switch until all foot switch lamps (1-3) light then remove your foot. In this condition, the following procedure can be used.
1. Hold Foot Switch 1 for more than one second to switch between the **USER AREA** ↔ **PRESET AREA**.
 2. Hold Foot Switch 2 for more than one second to decrease the **group number** by a value of one.
 3. Hold Foot Switch 3 for more than one second to increase the **group number** by a value of one.
 4. Press a Foot Switch (1-3) to select the corresponding **bank number (1-3)**.
 5. When a BANK is selected, the lamp in the display and foot switch lamp will flash quickly. Press a Foot Switch (1-3) at this time to select the corresponding **patch number (1-3)**.

* To cancel the selected patch, press the BANK switch. It will return to the previous condition.

● Using MIDI Control

MIDI program change data transmitted from an external MIDI device such as the YAMAHA MIDI Foot Controller MFC10, etc. can be used to select patches in the UD-Stomp.

1. Use a MIDI cable to connect the MIDI IN jack on the UD-Stomp to the MIDI OUT jack on an external MIDI device.

* Make sure to use a MIDI cable that conforms to the MIDI standard. Also, limit the length of the MIDI cable to 15 meters. Use of a long cable may result in trouble such as inferior performance of the device, etc.

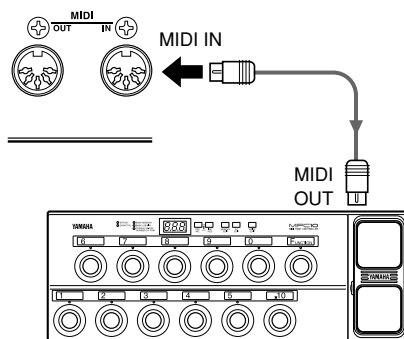

MFC10, etc

2. Match the UD-Stomp's MIDI receive channel with the MIDI transmit channel on the external MIDI device.
→ page 25 [Set the MIDI Receive Channel]
3. Create a Program Change Table*. (Factory default → Program Change No : Patch No. = 1:011, 2:012...128:4.12)

→ page 25 [Create a Program Change Table]

* This operation is used to assign patch numbers to a corresponding program change number received from an external device. For example, when the program change number "1" is received, the UD-Stomp's patch number "113" is recalled.

4. When program change data is transmitted from an external MIDI device, the patch is selected that corresponds to the program change table you created.

* Refer to the owner's manual for your external MIDI device for instructions on how to transmit program change data.

■ Create and Store a Patch

Original settings can be stored in the USER AREA (011-933). Try creating an original patch and then store it.

● Storing Procedure

1. Press the [STORE] button.
When you enter the Store Mode, the display, the [STORE] lamp and the foot switch lamp corresponding to the patch number will flash.
2. Select the patch (group, bank, patch number) to which you want to store the patch.
Use the same procedure as described in [Try Selecting Another Patch] (page 19) to select a patch. You can use the [UP]/[DOWN] buttons, the foot switches and the BANK switch to select the patch number. However, you cannot change the AREA (it can only be assigned to the USER AREA).
3. After select the patch you want to store your patch in, hold the [STORE] button.
The store operation is complete when all lamps light.

** To interrupt the Store operation, quickly press and release the [STORE] button.*

** Utility mode settings are not stored with patch data. As common settings for all patches, their contents are stored in the UD-Stomp memory.*

** The OUTPUT knob's setting is not stored with the patch data.*

** Data in the USER AREA (011-933) can be stored in an external MIDI device. (→ page 26)*

** MIDI cannot be received while storing.*

This procedure can be used to store original patches and also used to rearrange the order of patches for use during live performance.

Convenient Functions

Here are some convenient functions that make using the UD-Stomp easier.

● Use the Footswitch to set the Delay Time (Tap Tempo)

With the UD-Stomp you can tap on the Footswitch to set the Delay Time parameter.

1. Step on and hold the BANK Footswitch until “L AP” appears in the display.
2. Step on Footswitch 1 and select the Effect Band to which you want to set the delay time.



* When multiple delays are combined into a Group, only the Effect Band at the head of the group can be selected. If the [EFFECT BAND 1-8] buttons on the panel are used to select any other Effect Band, the Tap Tempo function can not be carried out.

3. Use Footswitch 2 to switch the selected Effect Band ON/OFF.

* Each Effect Band has two switches, one on the effect input side, another on the output side, that can be used to switch the Effect Band ON/OFF.

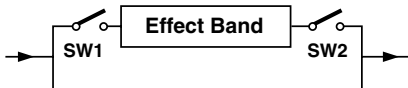

- When the currently selected Effect Band is set OFF, stepping on Footswitch 2 will switch both SW1 and SW2 ON and the Effect Band will be switched ON (the Footswitch 2 lamp lights).
- When the currently selected Effect Band is set ON, stepping on Footswitch 2 will switch only SW1 OFF (SW2 is still ON) (the Footswitch 2 lamp flashes). The delay that is present up until Footswitch 2 was depressed will continue to sound but the delay circuit will not accept additional input.
- When only SW1 in the currently selected Effect Band is switched OFF, stepping on Footswitch 2 will switch SW1 ON. In this condition both SW1 and SW2 are switched ON which means that the Effect Band is also ON (the Footswitch 2 lamp lights).
- To switch the Effect Band OFF, hold the desired [EFFECT BAND 1-8] button on the panel.

4. Step (tap) on Footswitch 3 in the tempo you want to set the delay time to.

* In step 4, the Delay Time will be rewritten every time the Footswitch is pressed.

5. Step on the BANK Footswitch to return to the Play Mode.

● Loop Sampling

With the UD-Stomp, you can sample a phrase (the input signal) that will playback in a loop (the phrase will continue to playback, feedback is unlimited).

1. Step on the BANK Footswitch until “L AP” appears in the display.
2. Step on Footswitch 1 and select an Effect Band that has sufficient delay time required for the phrase you want to record.

* When multiple Effect Bands are grouped to form a long delay time, only the Effect Band at the head of the group can be selected. If the [EFFECT BAND 1-8] buttons on the panel are used to select any other Effect Band, the Loop Sampling function can not be carried out.

3. Step on and hold Footswitch 2 until “L 5.?” (?= the selected Effect Band number) appears in the display.

The display flashes and the Loop Sampling function is in standby mode (maximum delay time, SW1=OFF, SW2=ON, RAM clear).

4. Step on Footswitch 3 (SW1=ON) to start sampling, and release the switch to stop sampling (SW1=OFF, FEEDBACK=10)

The delay time is set according to the length of time that the Footswitch is depressed (from when you step on it until it's released), and the phrase you play is recorded while the Footswitch is held down. When the Footswitch is released, the phrase starts continuous playback.

* If the length of the sample exceeds the set delay time, the sample will be ignored.

5. If you want to mix another phrase into the sample, first step and release (quickly) on Footswitch 2 (SW1=ON) then add new material on top of your previous phrase. Once you are done adding to the loop, step and release (quickly) on Footswitch 2 again (SW1=OFF).

6. To stop playback of the loop sample, first step on Footswitch 2 until “L 5.?” appears in the display (clear the sample), and the step on the BANK Footswitch to return to the Play Mode.

* If you want to stop loop sample playback temporarily, step on the BANK Footswitch to enter the Bypass Mode. To restart loop sample playback, press the BANK Footswitch again.

* The sample loop can also be cleared by setting the FEEDBACK knob to "0" or using the [EFFECT BAND 1-8] buttons switch the Effect Band OFF.

* The preset patches listed below are set for loop sampling.

9.3 1 This is the longest loop sampling patch using all 8 Effect Bands.

9.32 Effect Bands 1-7 are used for loop sampling. Effect Band 8 applies delay only to the input sound.

9.33 Effect Bands 1-7 are used for sampling. Effect Band 8 applies delay to both the loop sample's sound and the input sound.

● Copy/Paste Functions

These functions are used to copy the parameter's value (set with the knobs) on the top panel from one Effect Band and paste them into another. This is convenient when you want to set the same parameters to a number of Effect Bands.

1. Select the parameters you want to copy. Select an Effect Band set its parameters.
2. Press and hold the [FUNCTION] button and press the [CONNECT] button ("C P Y" appears in the display). The parameters are copied.
3. Select the Effect Band to which you want to paste the copied parameters.
Hold the [FUNCTION] button and press the [GROUP] button ("P S E" appears in the display). The parameters you copied from the Effect Band selected in step 1 are now pasted into the Effect Band selected here.

● Using a foot pedal (Controller)

With a foot controller (Expression Pedal) (optional) such as the Yamaha FC-7, etc., connected to the EXP. PEDAL jack you can control the UD-Stomp's parameters (setting values) with your foot.

→ page 24 [External Control Settings]

● Controlling the UD-Stomp with an external MIDI device

Connect the UD-Stomp's MIDI IN jack to the MIDI OUT jack on an external MIDI device with a MIDI cable to control the UD-Stomp's parameters (setting values) with an external MIDI device.

→ page 24 [External Control Settings]

● Factory Default

To return the UD-Stomp to its factory-preset condition, hold the buttons [UP] and [UTILITY] and turn the Power ON (⏻). The UD-Stomp will then be reset to its factory defaults and all data in the USER AREA will be rewritten with data for the patches listed in the Patch List (on the separate "Patch List" sheet).

When the UD-Stomp is reset to its factory default condition, all data stored in memory is erased. We recommend that any important data be stored in an external MIDI device or that notes be taken of the settings.

External Control Settings

The ASSIGNABLE CONTROL knob on the top panel can be used to control any one of the effect's parameters. You can also use a foot controller (Expression Pedal) (optional) such as the Yamaha FC-7, etc., connected to the EXP. PEDAL jack or an external MIDI device connected to the MIDI IN jack to control UD-Stomp parameters.

* In this section, some button names have been shortened, for instance [EFFECT BAND 1] button is written as [BAND 1] button.

■ Procedure

1. In the Play Mode, simultaneously press the [FUNCTION] button and the [WAVE] button.

Enter the external control setting mode and "C t L" will appear on the display.

2. Press the [BAND 1] button.

A control number will appear on the display.

Use the [UP]/[DOWN] buttons to set the control number.

Up to 8 programmed control settings can be assigned to control numbers 1-8 in the UD-Stomp.

A separate controller can be used to control each programmed control setting or a single controller can be used to control all control settings separately.

3. Press the [BAND 2] button.

The controller type will appear in the display.

Use the [UP]/[DOWN] buttons to set the type of controller.

• $E.P$: Control is by the foot controller connected to the EXP. PEDAL jack.

• $R.C$: Control is by the [ASSIGNABLE CONTROL] knob on the top panel.

• $1-3$, $54-95$: Control is by control change data received from an external MIDI device connected to the MIDI IN jack. Select the control change number. (Refer to the Owner's Manual for the external MIDI device for information in MIDI control change numbers.)

4. Press the [BAND 3] button.

The parameter type will appear in the display. The number indicates the Effect Band number.

Use the [UP]/[DOWN] buttons to select the parameter to be controlled.

• OFF : off (no control)
• t , $1-t$, tB : TIME (Delay Time)
• LF , LFB : LOW CUT FILTER
• HF , HFB : HIGH CUT FILTER

• Fb , FbB : FEEDBACK
• tP , tPB : TAP
• SP , SPB : SPEED
• dP , dPB : DEPTH
• Pn , PnB : PAN
• LE , LEB : LEVEL
• EFL : EFFECT LEVEL
• dL : DIRECT LEVEL
• dP : DIRECT PAN

The controller that was assigned in step 3 can be used to control these parameters (setting values).

* The TIME controller listed above alters the delay time between 0 and 100% without changing the actual delay time value that is set with the panel knob, so changes resulting from the TIME controller will not be saved when the patch is stored.

* Controllers other than TIME, change the value of the corresponding parameter so when the patch is stored those changes will also be saved to memory, rewriting previous data.

5. Press the [BAND 4] button.

The parameter's adjustable minimum value (the parameter's value when the controller is set to its minimum) is shown in the display.

Use the [UP]/[DOWN] buttons to set the value.

6. Press the [BAND 5] button,

The parameter's adjustable maximum value (the parameter's value when the controller is set to its maximum) is shown in the display.

Use the [UP]/[DOWN] buttons to set the value.

7. Press the [FUNCTION] button to return to the Play Mode.

These external control settings are saved with patch data.

Also, there are other functions not related to patch settings that set the Utility Mode's External Controller to always ON (active) or set the External Controller to always OFF (inactive). (→ page 26)

Utility Mode

The Utility Mode is used for settings that cover the overall system of the UD-Stomp such as the foot switch, MIDI, external control, EXP. pedal jack, etc.

* In this section, some button names have been shortened, for instance [EFFECT BAND 1] button is written as [BAND 1] button.

■ About the Utility Mode

When in the Play Mode, press the [UTILITY] button to enter the Utility Mode (the lamp lights).

When in the Utility Mode press the [UTILITY] button to return to the Play Mode (the lamp goes off).

When in the Utility Mode MIDI messages can not be received. Use the Play Mode to receive MIDI messages.

In the Utility Mode, the three following functions are available. Use the [UP]/[DOWN] buttons to select a function.

- **MIDI Functions** (f f f d)
- **External Control Settings** (E E L)
- **EXP. Pedal Settings** (E P)

■ MIDI Functions

After pressing the [UTILITY] button, use the [UP]/[DOWN] buttons to select "f f f d" in the display. Then press the [STORE] button to enter the MIDI Functions Setting Mode.

● Create a MIDI Program Change Receive Table

Sets the corresponding patch that will be recalled when a MIDI Program Change No. (referred to as PRG No. from here on) is received.

Press the [BAND 1] button to set the receiving MIDI PRG No. Use the [UP]/[DOWN] buttons to select the number.

- 1- 128 : MIDI Program Change No.

Press the [BAND 2] button to set the UD-Stomp's patch number. Just as in selecting a patch in the Play Mode, use the [UP]/[DOWN] buttons or the footswitch.

• 0 11-933, 0.11-933 :

The patch number to be recalled.

● Create a MIDI Program Change Transmit Table

When a footswitch (1-3) is pressed to recall a patch a MIDI Program Change Number can be transmit-

ted from the UD-Stomp's MIDI OUT jack to a control an external effector, etc. from the UD-Stomp. Assigns to the patch, a MIDI PRG No. that will be transmitted when the patch is recalled.

* When a patch is recalled with a MIDI program change command, MIDI PRG. Numbers can not be transmitted.

Press the [BAND 3] button to set the UD-Stomp's patch number. Just as in selecting a patch in the Play Mode, use the [UP]/[DOWN] buttons or the footswitch.

• 0 11-933, 0.11-933 :

The patch number to be recalled.

Press the [BAND 4] button to set the MIDI PRG No. to be transmitted. Use the [UP]/[DOWN] buttons to select the number.

- 1- 128 : MIDI Program Change No.

● Set the MIDI Receive Channel

Sets the UD-Stomp's MIDI Receive Channel. The MIDI channel set in this step is also used as the device number for the bulk receive function.

Press the [BAND 5] button and use the [UP]/[DOWN] buttons to set the MIDI receive channel.

- 1- 16 : MIDI channel over which messages are received.
- ALL : MIDI messages from all channels are received
- OFF : MIDI messages are not received

● Set the MIDI Transmit Channel

Sets the UD-Stomp's MIDI Transmit Channel. The MIDI channel set in this step is also used as the device number for the bulk out function.

Press the [BAND 6] button and use the [UP]/[DOWN] buttons to set the MIDI transmit channel.

- 1- 16 : MIDI channel over which messages are transmitted.

● ON/OFF Setting for MIDI Merge

Sets whether or not the MIDI signal that is received via the UD-Stomp's MIDI IN jack will also be retransmitted via the MIDI OUT jack.

Utility Mode

Press the [BAND 7] button and use the [UP]/[DOWN] buttons to set the merge setting.

- ON : Data is retransmitted via the MIDI OUT jack
- OFF : Data is not retransmitted via the MIDI OUT jack

* When the merge is on, data retransmitted via the MIDI OUT jack is not confined to the MIDI Receive Channel setting so all data from all channels will be transmitted.

● MIDI Bulk Out

This operation transmits data stored in the UD-Stomp's USER AREA as well as Utility Mode settings to an external device, such as the YAMAHA MDF3, etc., for back up or storage.

Use a MIDI cable to connect the UD-Stomp's MIDI OUT jack to the MIDI IN jack of an external MIDI device.

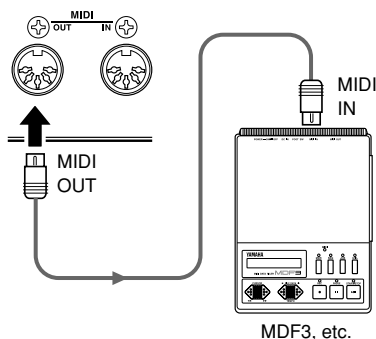

To send all USER AREA data (011-933) plus Utility settings with the Bulk Out operation.

Press the [BAND 8] button ("RL L" will appear on the display), then press the [STORE] button to carry out the MIDI Bulk Out.

To send a single USER AREA patch (data) with the Bulk Out operation.

After pressing the [CONNECT] button, select the patch number you want to send with the bulk out. Just as in selecting a patch number in the Play Mode, use the [UP]/[DOWN] buttons or the foot switches to select the patch.

After selecting a patch, press the [STORE] button to carry out the MIDI Bulk Out operation with a single patch.

* After transmitting the data the device will return to the previous condition, ready to select another patch number.

● About the MIDI Bulk In

This operation is used to return data stored in an external MIDI device such as the YAMAHA MDF3, etc., to the UD-Stomp.

Use a MIDI cable to connect the MIDI OUT jack on the external MIDI device to the UD-Stomp's MIDI IN jack.

When Bulk Out data is sent from the external device, the UD-Stomp will receive the bulk data.

* Use the UD-Stomp's Play Mode to receive MIDI Bulk In data.

When the MIDI Bulk In is carried out, the contents of the patches in the USER AREA will be rewritten.

Please make sure any important data is saved before carrying out the MIDI Bulk In operation.

■ External Control Settings

Just as described in the "External Control Settings" section on page 24, these settings can be used to control each of the UD-Stomp's effect parameters from the ASSIGNABLE CONTROL, a foot controller connected to the EXP. PEDAL jack, or a MIDI device connected to the MIDI IN jack.

● External Control Operating Mode

After pressing the [UTILITY] button, use the [UP]/[DOWN] buttons to select "CL L" in the display. Next press the [STORE] button to enter the External Control Operation Mode.

Press the [BAND 1] button and use the [UP]/[DOWN] buttons to select an Operating Mode for the external control.

- PRG : The external control setting that is set in the patch is available.
- CL b : The external control setting in the Utility Mode is always available.
- OFF : The external control is always OFF.

The following five functions can be used when the Operating Mode is set to "CL b".

● Set the External Control Number

Press the [BAND 2] button and use the [UP]/[DOWN] buttons to set a control number (1-8).

* Refer to [External Control Settings] (page 24)

● Set the External Controller

Press the [BAND 3] button and use the [UP]/[DOWN] buttons to select the type of controller (EXP, 1-3 I, 54-95).

* Refer to [External Control Settings] (page 24)

● Set the Parameter to be Controlled

Press the [BAND 4] button and use the [UP]/[DOWN] buttons to select the parameter to be controlled (L, I-).

* Refer to [External Control Settings] (page 24)

● Set the Parameter's Minimum Value

Press the [BAND 5] button and use the [UP]/[DOWN] buttons to set the parameter's minimum value (the parameter's value when the controller is set to its minimum: 0.0 - 10.0).

* Refer to [External Control Settings] (page 24)

● Set the Parameter's Maximum Value

Press the [BAND 6] button and use the [UP]/[DOWN] buttons to set the parameter's maximum value (the parameter's value when the controller is set to its maximum: 0.0 - 10.0).

* Refer to [External Control Settings] (page 24)

■ EXP Pedal Settings

These settings are available when the EXP Pedal "EXP" is selected as the controller in the External Control Settings Section. (→ page 24)

After pressing the [UTILITY] button, use the [UP]/[DOWN] buttons to select "EXP" in the display. Then press the [STORE] button to enter the EXP Pedal setting mode.

● Set the Minimum Value of the EXP Pedal

Sets the minimum value that indicates the position of the EXP Pedal.

Press the [BAND 1] button and use the [UP]/[DOWN] buttons to set the position (0 - 128).

You can also hold the [BAND 1] button and move the EXP Pedal to set the position.

* Due to the relationship between the maximum and minimum value, a value which results in a practical range (refer to the illustration below) of less than 128 can not be used.

● Set the Maximum Value of the EXP Pedal

Sets the maximum value that indicates the position of the EXP Pedal.

Press the [BAND 2] button and use the [UP]/[DOWN] buttons to set the position (127-255).

You can also hold the [BAND 2] button and move the EXP Pedal to set the position.

* Due to the relationship between the maximum and minimum value, a value which results in a practical range (refer to the illustration below) of less than 128 can not be used.

* The value can not be set greater than that of the EXP Pedal's Switch Setting.

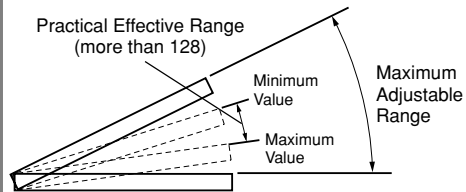

● Transmitting Control Change Numbers from the EXP Pedal

Set the MIDI control change number that is to be transmitted when the EXP pedal is used.

Press the [BAND 3] button and use the [UP]/[DOWN] buttons to set the control change number.

- OFF : MIDI is not transmitted
- 1-32, 54-95 :

Control change number that is to be transmitted.

Error Messages

If an error occurs during operation, one of the following error message numbers will appear in the display. Stop operation of the device and follow the proper solution described below.

E 1: MIDI Receive Buffer Full

CAUSE: Too much MIDI data is being received at one time.

SOLUTION: Try reducing the amount of data being sent or, break the data into smaller blocks.

E 2: Communication Error.

CAUSE: An abnormality is detected during MIDI communications.

SOLUTION: Check all connections, etc. and try again.

E 3: Bulk Receive Check Sum Error.

CAUSE: The check sum does not match the received MIDI bulk data.

SOLUTION: Check all connections and data, and try again.

E 4: Bulk Receive Data Abnormality.

CAUSE: An abnormality is detected in the received MIDI bulk data.

SOLUTION: Check all connections and data, and try again.

E 5: Backup Battery Error.

CAUSE: Backup battery power is depleted.

SOLUTION: Continued use of the device will result in the loss of data. Return the device to the music dealer where you purchased it or, the nearest Yamaha Service center and have the battery replaced.

Trouble Shooting

No Sound

- Is the power adaptor properly connected?
- Is the volume level of the instrument connected to the INPUT jack turned up?
- Are the EFFECT LEVEL knob and the DIRECT LEVEL knob values set to "0"?
- Is the OUTPUT LEVEL knob value set to "0"?
- If an EXP. Pedal is being used to control the volume, try stepping on the pedal.

No Effect

- Is the LEVEL knob value set to "0"?
- Is the EFFECT LEVEL knob value set to "0"?
- Is the TIME setting's value set to "0"?
- Is the BYPASS mode switched ON with the BANK Footswitch (the BANK Footswitch lamp lights)?
- Is the effect switched OFF with the Footswitch (1, 2, 3) (the lights for the Footswitches are off)?

- If an EXP. Pedal is being used to control the volume, try stepping on the pedal.

Turning the Knobs Does Not Change the Sound

- First, rotate the knob until the value in the display changes and then set. (→ page 13)
- Is an Effect Band selected? After selecting an Effect Band with one of the [EFFECT BAND 1-8] buttons, rotate the knob to set. (→ page 13)

Can Not Transmit MIDI

- Is the MIDI channel matched with MIDI channel on the receiving device? (→ page 25)
- Is the MIDI Merge set to "OFF"? (→ page 25)

Can Not Receive MIDI

- Is the UD-Stomp in the Play Mode? Return to the Play Mode and try receiving again.
- Is the UD-Stomp's MIDI channel set to "OFF"? (→ page 25)

Specifications

Digital Section

- 8-Band Delay (Delay Time: 696msec max per band)
- Delay Time, Loop Filter (High Cut, Low Cut), Feedback, Tap, Pan, Level parameters can be set for each individual Effect Band.
- Effect Bands can be connected in series or parallel
- Effect Bands can be grouped together
- Maximum delay time (8 bands grouped) is 5890msec
- The same number of delay outputs as the number of delays used in the Group are available.
- Tap Tempo Function (Delay Time)
- Loop Sampling Function
- Individual Modulation Settings (Speed, Depth) for each Effect Band are available.
- Two types of modulation waves can be set simultaneously (Sine + Triangle/Saw Up/Saw Down).
- Modulation sync between bands is available.

MIDI Functions

Receive: Program Change (Program Change Table can be created), Control Change, Bulk In

Transmit: Program Change, Control Change, Bulk Out, Merge Out

Controller Switch

Top Panel

Push Switch x17

UP, DOWN, UTILITY, STORE, EFFECT BAND (1 - 8), CONNECT, GROUP, SYNC, WAVE, FUNCTION

Knob x14

ASSIGNABLE CONTROL, TIME COARSE, TIME FINE, LOW CUT FILTER, HIGH CUT FILTER, FEEDBACK, DIRECT LEVEL/PAN, TAP, SPEED, DEPTH, PAN, LEVEL, EFFECT LEVEL, OUTPUT

Footswitch x4

1, 2, 3, BANK

Rear Panel

STAND-BY ON/OFF, INPUT LOW/HIGH

Display

7 Segment LED (3 digit) x1

Push Switch LED x17

Foot Switch LED x4

Connections/Jacks

INPUT: Standard Monaural Phone Jack

OUTPUT L/MONO, R: Standard Monaural Phone Jack

PHONES: Standard Stereo Phone Jack

EXP. PEDAL: Standard Stereo Phone Jack

DIGITAL OUT: COAXIAL (Sampling Rate : 44.1 kHz)

MIDI IN, MIDI OUT: 5 pin DIN

A/D Converter

20 bit + 3 bit Floating

D/A Converter

20 bit

Sampling Frequency

44.1 kHz

Memory Allocations

Preset: 90

User: 90

Input Level/Impedance

(When using preamp bypass)

INPUT HIGH: -25dBm/1M Ω

INPUT LOW: -15dBm/1M Ω

Output Level/Impedance

OUTPUT L/MONO, R: 0dBm/1k Ω

PHONES: 0dBm/47 Ω (47 Ω load)

Power

Exclusive Power Adaptor (AC-10)

AC Output: AC12V, 1000mA

Power Consumption

15W

Dimensions (WxHxD)

280x70x184mm (11.0"x2.8"x7.2")

Weight

2.2kg (4lbs 14oz)

Accessories

Power Adaptor (AC-10)

Owner's Manual (this booklet)

* Specifications and design may change without notice.

MIDI Implementation Chart

YAMAHA	[Modulation Delay]	Date:14-Dec-2001	
Model	UD stomp MIDI Implementation Chart	Version : 1.0	
Function ...	Transmitted	Recognized	Remarks
: Basic Default	: 1 - 16	: 1 - 16, off	: memorized
: Channel Changed	: 1 - 16	: 1 - 16, off	:
: Default	: 1,3	: 1,3	: memorized
: Mode Messages	: x	: x	:
: Altered	: *****	: x	:
: Note	: x	: x	:
: Number : True voice	: *****	: x	:
: Velocity Note ON	: x	: x	:
: Note OFF	: x	: x	:
: After Key's	: x	: x	:
: Touch Ch's	: x	: x	:
: Pitch Bender	: x	: x	:
: 0	: x	: x	:
: 1 - 31	: 0	: 0	:
: 32 - 63	: x	: x	:
: 64 - 95	: 0	: 0	:
: Control 95 -127	: x	: x	:
: Change	:	:	:

MIDI Implementation Chart

Prog	: 0 0 - 127	: 0 0 - 127				
Change : True #	: *****	: *****				
System Exclusive	: 0	: 0				Bulk Dump
System : Song Pos.	: x	: x				
: Song Sel.	: x	: x				
common : Tune	: x	: x				
System :Clock	: x	: x				
Real Time :Commands	: x	: x				
Aux :All Sound OFF	: x	: x				
:Reset All Cntrls	: x	: x				
:Local ON/OFF	: x	: x				
:All Notes OFF	: x	: x				
Mes- :Active Sense	: 0	: x				
sages:Reset	: x	: x				
Mode 1	: OMNI ON, POLY	Mode 2	: OMNI ON, MONO			o : Yes
Mode 3	: OMNI OFF, POLY	Mode 4	: OMNI OFF, MONO			x : NO

