



UCA

HTR-5250

Natural Sound AV Receiver
Ampli-tuner audio-vidéo

OWNER'S MANUAL
MODE D'EMPLOI

SAFETY INSTRUCTIONS

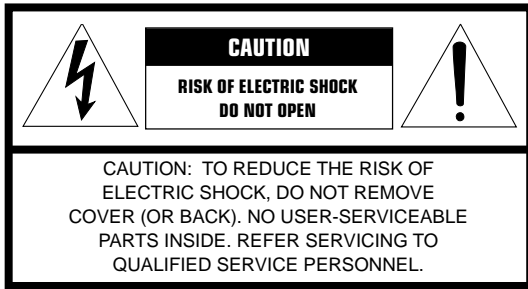

• Explanation of Graphical Symbols

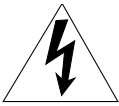

The lightning flash with arrowhead symbol, within an equilateral triangle, is intended to alert you to the presence of uninsulated "dangerous voltage" within the product's enclosure that may be of sufficient magnitude to constitute a risk of electric shock to persons.



The exclamation point within an equilateral triangle is intended to alert you to the presence of important operating and maintenance (servicing) instructions in the literature accompanying the appliance.

WARNING

TO REDUCE THE RISK OF FIRE OR ELECTRIC SHOCK, DO NOT EXPOSE THIS UNIT TO RAIN OR MOISTURE.

- 1 Read Instructions – All the safety and operating instructions should be read before the unit is operated.
- 2 Retain Instructions – The safety and operating instructions should be retained for future reference.
- 3 Heed Warnings – All warnings on the unit and in the operating instructions should be adhered to.
- 4 Follow Instructions – All operating and other instructions should be followed.
- 5 Water and Moisture – The unit should not be used near water – for example, near a bathtub, washbowl, kitchen sink, laundry tub, in a wet basement, or near a swimming pool, etc.
- 6 Carts and Stands – The unit should be used only with a cart or stand that is recommended by the manufacturer.
- 6A A unit and cart combination should be moved with care. Quick stops, excessive force, and uneven surfaces may cause the unit and cart combination to overturn.
- 7 Wall or Ceiling Mounting – The unit should be mounted to a wall or ceiling only as recommended by the manufacturer.



- 8 Ventilation – The unit should be situated so that its location or position does not interfere with its proper ventilation. For example, the unit should not be situated on a bed, sofa, rug, or similar surface, that may block the ventilation openings; or placed in a built-in installation, such as a bookcase or cabinet that may impede the flow of air through the ventilation openings.
- 9 Heat – The unit should be situated away from heat sources such as radiators, stoves, or other appliances that produce heat.
- 10 Power Sources – The unit should be connected to a power supply only of the type described in the operating instructions or as marked on the unit.
- 11 Power-Cord Protection – Power-supply cords should be routed so that they are not likely to be walked on or pinched by items placed upon or against them, paying particular attention to cords at plugs, convenience receptacles, and the point where they exit from the unit.
- 12 Cleaning – The unit should be cleaned only as recommended by the manufacturer.
- 13 Nonuse Periods – The power cord of the unit should be unplugged from the outlet when left unused for a long period of time.
- 14 Object and Liquid Entry – Care should be taken so that objects do not fall into and liquids are not spilled into the inside of the unit.
- 15 Damage Requiring Service – The unit should be serviced by qualified service personnel when:
 - A. The power-supply cord or the plug has been damaged; or
 - B. Objects have fallen, or liquid has been spilled into the unit; or
 - C. The unit has been exposed to rain; or
 - D. The unit does not appear to operate normally or exhibits a marked change in performance; or
 - E. The unit has been dropped, or the cabinet damaged.
- 16 Servicing – The user should not attempt to service the unit beyond those means described in the operating instructions. All other servicing should be referred to qualified service personnel.
- 17 Power Lines – An outdoor antenna should be located away from power lines.
- 18 Grounding or Polarization – Precautions should be taken so that the grounding or polarization is not defeated.

19 For US customers only:

Outdoor Antenna Grounding – If an outside antenna is connected to this unit, be sure the antenna system is grounded so as to provide some protection against voltage surges and built-up static charges. Article 810 of the National Electrical Code, ANSI/NFPA 70, provides information with regard to proper grounding of the mast and supporting structure, grounding of the lead-in wire to an antenna discharge unit, size of grounding conductors, location of antenna discharge unit, connection to grounding electrodes, and requirements for the grounding electrode.

Note to CATV system installer:

This reminder is provided to call the CATV system installer's attention to Article 820-40 of the NEC that provides guidelines for proper grounding and, in particular, specifies that the cable ground shall be connected to the grounding system of the building, as close to the point of cable entry as practical.

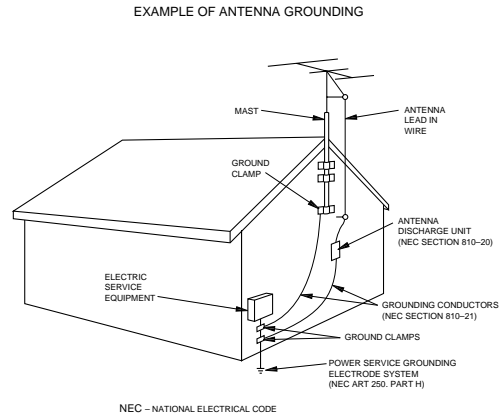
**FCC INFORMATION (for US customers only)****1. IMPORTANT NOTICE : DO NOT MODIFY THIS UNIT!**

This product, when installed as indicated in the instructions contained in this manual, meets FCC requirements. Modifications not expressly approved by Yamaha may void your authority, granted by the FCC, to use the product.

2. IMPORTANT : When connecting this product to accessories and/or another product use only high quality shielded cables. Cable/s supplied with this product MUST be used. Follow all installation instructions. Failure to follow instructions could void your FCC authorization to use this product in the USA.**3. NOTE :** This product has been tested and found to comply with the requirements listed in FCC Regulations, Part 15 for Class "B" digital devices. Compliance with these requirements provides a reasonable level of assurance that your use of this product in a residential environment will not result in harmful interference with other electronic devices.

This equipment generates/uses radio frequencies and, if not installed and used according to the instructions found in the users manual, may cause interference harmful to the operation of other electronic devices.

Compliance with FCC regulations does not guarantee that interference will not occur in all installations. If this product is found to be the source of interference, which can be determined by turning the unit "OFF" and "ON", please try to eliminate the problem by using one of the following measures:

Relocate either this product or the device that is being affected by the interference.

Utilize power outlets that are on different branch (circuit breaker or fuse) circuits or install AC line filter/s.

In the case of radio or TV interference, relocate/reorient the antenna. If the antenna lead-in is 300 ohm ribbon lead, change the lead-in to coaxial type cable.

If these corrective measures do not produce satisfactory results, please contact the local retailer authorized to distribute this type of product. If you can not locate the appropriate retailer, please contact Yamaha Electronics Corp., U.S.A. 6660 Orangethorpe Ave, Buena Park, CA 90620.

The above statements apply ONLY to those products distributed by Yamaha Corporation of America or its subsidiaries.

We Want You Listening For A Lifetime

YAMAHA and the Electronic Industries Association's Consumer Electronics Group want you to get the most out of your equipment by playing it at a safe level. One that lets the sound come through loud and clear without annoying blaring or distortion – and, most importantly, without affecting your sensitive hearing.

Since hearing damage from loud sounds is often undetectable until it is too late, YAMAHA and the Electronic Industries Association's Consumer Electronics Group recommend you to avoid prolonged exposure from excessive volume levels.



CAUTION: READ THIS BEFORE OPERATING YOUR UNIT.

1. To assure the finest performance, please read this manual carefully. Keep it in a safe place for future reference.
2. Install this unit in a cool, dry, clean place — away from windows, heat sources, sources of excessive vibration, dust, moisture and cold. Avoid sources of humming (transformers, motors). To prevent fire or electrical shock, do not expose the unit to rain or water.
3. Never open the cabinet. If something drops into the unit, contact your dealer.
4. Do not use force on switches, controls or connection cables. When moving the unit, first disconnect the power cord and then the cables connected to other component. Never pull the cables themselves.
5. The openings on the cover assure proper ventilation of the unit. If these openings are obstructed, the temperature inside the unit will rise rapidly. Therefore, avoid placing objects against these openings, and install the unit in a well-ventilated area to prevent fire and damage.
6. The voltage used must be the same as that specified on this unit. Using this unit with a higher voltage than specified is dangerous and may result in fire or other accidents. YAMAHA will not be held responsible for any damage resulting from the use of this unit with a voltage other than that specified.
7. Digital signals generated by this unit may interfere with other component such as tuners, receivers and TVs. Move this unit farther away from such component if interference is observed.
8. Always set VOLUME to the “∞” position before starting the audio source play. Increase the volume gradually to an appropriate level after playback has been started.
9. Do not attempt to clean the unit with chemical solvents; this might damage the finish. Use a clean, dry cloth.
10. Be sure to read the “TROUBLESHOOTING” section regarding common operating errors before concluding that the unit is faulty.
11. When not planning to use this unit for a long period of time (e.g., a vacation), disconnect the AC power cord from the wall outlet.
12. To prevent lightning damage, disconnect the AC power cord and disconnect the antenna cable when there is an electrical storm.
13. Grounding or polarization — Precautions should be taken so that the grounding or polarization of the unit is not defeated.
14. AC outlet — Do not connect audio component to the AC outlet on the rear panel if that component requires more power than the outlet is rated to provide.

This unit is not disconnected from the AC power source as long as it is connected to the wall outlet, even if this unit itself is turned off. This state is called the standby mode. In this state, this unit is designed to consume a very small quantity of power.

IMPORTANT

Please record the serial number of this unit in the space below.

MODEL:

Serial No.:

The serial number is located on the rear of the unit. Retain this Owner's Manual in a safe place for future reference.

WARNING

TO REDUCE THE RISK OF FIRE OR ELECTRIC SHOCK, DO NOT EXPOSE THIS UNIT TO RAIN OR MOISTURE.

FOR CANADIAN CUSTOMERS

To prevent electric shock, match wide blade of plug to wide slot and fully insert.

This Class B digital apparatus complies with Canadian ICES-003.



FEATURES

5-Channel Power Amplification

- ◆ Minimum RMS Output (0.06% THD, 20 Hz – 20 kHz)
[U.S.A. and Canada models]
Main: 100 W + 100 W (8 Ω)
Center: 100 W (8 Ω)
Rear: 100 W + 100 W (8 Ω)
[Australia model]
Main: 70 W + 70 W (8 Ω)
Center: 70 W (8 Ω)
Rear: 70 W + 70 W (8 Ω)

Multi-Mode Digital Sound Field Processing

- ◆ Digital Sound Field Processor (DSP)
- ◆ Dolby Pro Logic Decoder
- ◆ Dolby Digital Decoder
- ◆ DTS Decoder
- ◆ CINEMA DSP: Combination of YAMAHA DSP Technology and Dolby Pro Logic, Dolby Digital or DTS

Sophisticated FM/AM Tuner

- ◆ 40-Station Random Access Preset Tuning
- ◆ Automatic Preset Tuning
- ◆ Preset Station Shifting Capability (Preset Editing)

Other Features

- ◆ 96-kHz/24-bit D/A Converter
- ◆ “SET MENU” which Provides You with 12 Items for Optimizing This Unit for Your Audio/Video System
- ◆ Test Tone Generator for Easier Speaker Balance Adjustment
- ◆ 6-Channel External Decoder Input for Other Future Formats
- ◆ S Video Signal Input/Output Capability
- ◆ 3 Optical/2 Coaxial Digital Signal Input Terminals
- ◆ SLEEP Timer
- ◆ Remote Control with Preset Manufacturer Codes



Manufactured under license from Dolby Laboratories. “Dolby”, “Pro Logic” and the double-D symbol are trademarks of Dolby Laboratories. Confidential Unpublished Works. ©1992 – 1997 Dolby Laboratories, Inc. All rights reserved.



Manufactured under license from Digital Theater Systems, Inc. US Pat. No. 5,451,942 and other world-wide patents issued and pending. “DTS”, “DTS Digital Surround”, are trademarks of Digital Theater Systems, Inc. Copyright 1996 Digital Theater Systems, Inc. All Rights Reserved.

CONTENTS

INTRODUCTION		INTRODUCTION
FEATURES	1	
CONTENTS	1	
GETTING STARTED	2	
CONTROLS AND FUNCTIONS	4	

PREPARATION		PREPARATION
SPEAKER SETUP	9	
CONNECTIONS	10	
ADJUSTING THE SPEAKER BALANCE	19	

BASIC OPERATION		BASIC OPERATION
PLAYING A SOURCE	21	
DIGITAL SOUND FIELD PROCESSOR (DSP) EFFECT	25	
TUNING	27	
RECORDING A SOURCE ON TAPE, MD OR VIDEO CASSETTE	31	

ADVANCED OPERATION		ADVANCED OPERATION
SOUND FIELD PROGRAM	32	
SET MENU	35	
DELAY TIME AND SPEAKER OUTPUT LEVELS	39	
SLEEP TIMER	41	
PRESET REMOTE CONTROL	42	

APPENDIX		APPENDIX
TROUBLESHOOTING	50	
SPECIFICATIONS	54	
GLOSSARY	55	
INDEX	56	

indicates a tip for your operation.

- When buttons on this unit and the remote control are noted together in this Owner’s Manual, these button names are in principle noted in the order of “button name (remote control button name)”.



GETTING STARTED

Checking the Package Contents

Check that the following items are included in your package.

Remote control

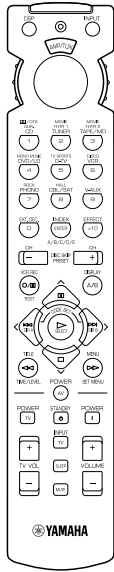

Batteries (AAA, R03, UM-4 type)

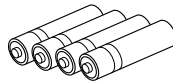

Antenna adapter
(U.S.A. and Canada models only)

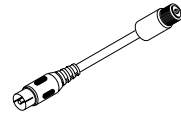

Indoor FM antenna

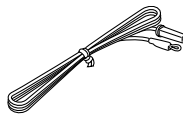

Quick reference card

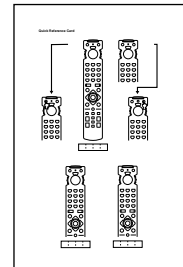

AM loop antenna



Connection guide

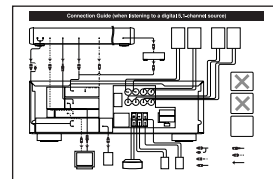

Battery Installation in the Remote Control

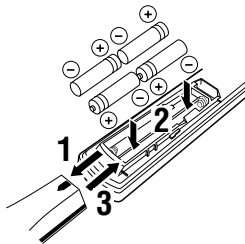

- 1** Turn the remote control over and slide the battery compartment cover in the direction of the arrow.
- 2** Insert the batteries (AAA, R03 or UM-4 type) according the polarity markings on the inside of the battery compartment.
- 3** Close the battery compartment cover.

Battery Replacement

If the remote control operates only when it is close to the unit, the batteries are weak. Replace all the batteries with new ones.

Be sure to replace the batteries within about two minutes. If it takes longer than two minutes, the codes set for the remote control will return to the factory settings. (Refer to pages 42 to 49 about the remote control.)

Notes

- Use only AAA, R03 or UM-4 batteries for replacement.
- Be sure the battery polarity is correct. (See the illustration inside the battery compartment.)
- Remove the batteries if the remote control will not be used for an extended period of time.
- If the batteries have leaked, dispose of them immediately. Avoid touching the leaked material or letting it come into contact with clothing, etc. Clean the battery compartment thoroughly before installing new batteries.

Using the Remote Control

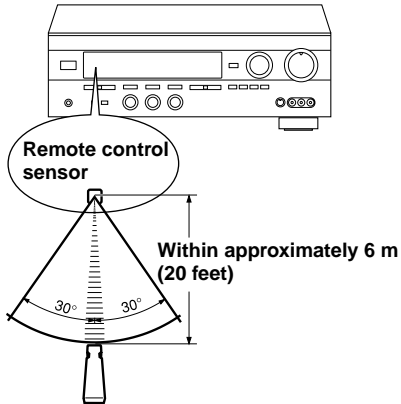

The remote control transmits a directional infrared beam. Be sure to aim the remote control directly at the infrared sensor during operation. When the sensor is covered or there is a large object between the remote control and the sensor, the sensor cannot receive signals. The sensor may not be able to receive signals properly when it is exposed to direct sunlight or a strong artificial light (such as a fluorescent or strobe light). In this case, change the direction of the light or reposition the unit to avoid direct lighting.

Notes

- Handle the remote control with care.
- Do not spill water, tea or other liquids on the remote control.
- Do not drop the remote control.
- Do not leave or store the remote control in the following conditions:
 - high humidity or temperature such as near a heater, stove or bath;
 - dusty places; or
 - extremely low temperature.



CONTROLS AND FUNCTIONS

Front Panel

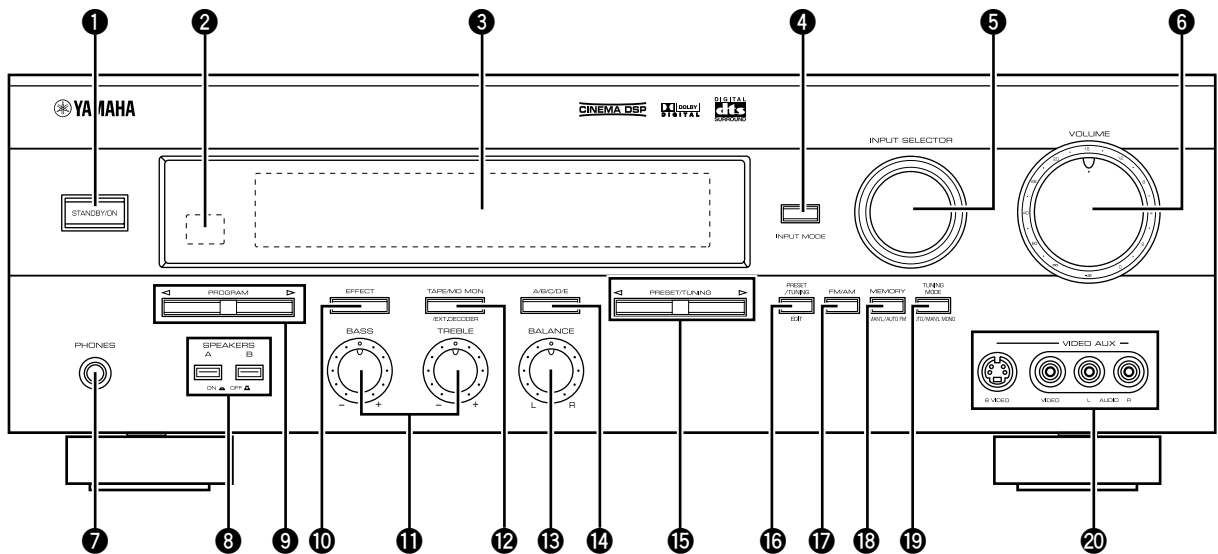

1 STANDBY/ON

Press this switch to turn on the power of this unit or to set this unit in the standby mode. Before turning the power on, set VOLUME to the “∞” position.

Standby mode

In this mode, this unit consumes a very small quantity of power to receive infrared-signals from the remote control.

2 Remote control sensor

This receives signals from the remote control.

3 Display

This shows various information. (Refer to page 6 for details.)

4 INPUT MODE

Press this button to select the input mode among AUTO, DTS and ANALOG for the DVD/LD, TV/digital TV and cable TV/satellite tuner sources.

5 INPUT SELECTOR

Turn this selector to select the input source (TUNER, CD, PHONO, CBL/SAT, V-AUX, VCR, D-TV, DVD/LD) that you want to listen to or watch. The arrow for the selected input source indicator lights up on the display.

6 VOLUME

Turn this control to turn up or down the volume.

7 PHONES jack

Connect the headphones to the PHONES jack. You can listen to the sound to be output from the main speakers through the headphones.

When listening with headphones privately, set both SPEAKERS A and B to the OFF position, press EFFECT to turn off the effect speakers (center and rear) and set “BASS OUT” on the SET MENU to the MAIN position (so that no DSP program name appears on the display).

8 SPEAKERS

Set A or B (or both A and B) to the ON position for the main speaker system (connected to this unit) that you want to use. Set the button(s) to the OFF position for the main speaker system that you don’t want to use.

9 PROGRAM selector

Press < or > to select a DSP program when the effect speakers (center and rear) are turned on. The name of the selected program appears on the display.

10 EFFECT

Press this button to turn on or off the effect speakers (center and rear). If you turn them off, the signals of the center and rear channels are directed to the right and left main speakers when playing a source encoded with Dolby Digital and DTS. In this case, the output levels of the right and left speakers may not match.

11 Tone controls

These controls are only effective for the sound from the main speakers.

a) BASS

Turn this control clockwise to increase or counterclockwise to decrease the low-frequency response. The “0” position produces a flat response.

b) TREBLE

Turn this control clockwise to increase or counterclockwise to decrease the high-frequency response. The “0” position produces a flat response.

12 TAPE/MD MON / EXT. DECODER

Press this button to select a tape or an MD source. The “TAPE/MD MONITOR” indicator lights up on the display. When you press the button again, the “TAPE/MD MONITOR” indicator goes off, “EXT. DECODER” appears on the display and you can listen to a source connected to the EXTERNAL DECODER INPUT terminals.

13 BALANCE

This control is only effective for the sound from the main speakers.

Turn the control to adjust the balance of the output volume from the right and left main speakers to compensate for sound imbalance caused by the speaker location or listening room conditions.

14 A/B/C/D/E

Press this button to select one of a group (A to E) of preset stations.

15 PRESET/TUNING

When “>” appears on the display

This button is used to select a preset station number (1 to 8). Press \triangleright to select a higher and \triangleleft to select a lower preset station number.

When “>” goes off from the display

This button is used for tuning. Press \triangleright to tune in to higher frequencies, and \triangleleft to tune in to lower frequencies.

16 PRESET/TUNING, EDIT

Press this button to turn on or off “>” on the display, and switch the function between storing a broadcasting station (preset tuning) and tuning. This button is also used to exchange the assignment of two preset stations with each other.

17 FM/AM

Press this button to switch the reception band between FM and AM.

18 MEMORY (MAN'L/AUTO FM)

Press this button to store broadcasting stations. Hold down this button for more than three seconds to begin automatic preset tuning.

19 TUNING MODE (AUTO/MAN'L MONO)

Press this button to switch the tuning mode between automatic and manual. To use the automatic tuning method, press this button so that the “AUTO” indicator lights up on the display. To use the manual tuning method, press this button so that the “AUTO” indicator goes off.

20 VIDEO AUX terminals

Connect an auxiliary audio or video input source such as a camcorder to these terminals. If the connected video unit has an S video output terminal, connect it to the S VIDEO terminal to obtain a high-resolution picture. Use INPUT SELECTOR to select the source connected to these terminals.

Display

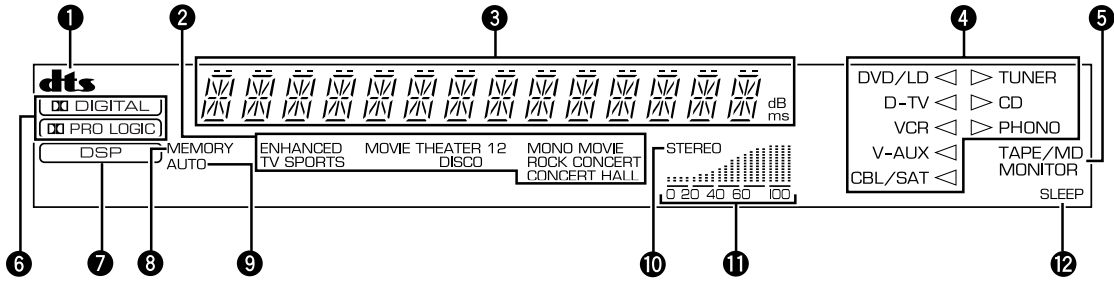

1 **dts** indicator

The “**dts**” indicator lights up when the built-in DTS decoder is on.

2 **DSP program indicators**

The name of the selected DSP program lights up in the following cases:

- When the tuner is selected as the input source.
- When DSP program No. 2, 3 or the subprogram “ENHANCED” of No. 1 is selected.

3 **Multi-information display**

This display shows various information: for example the name of the selected DSP program and the various settings during adjustment with the SET MENU. The current station frequency and band (FM or AM) also appear when the tuner is selected as the input source.

4 **Input source indicators**

One of the arrows for these indicators lights up depending on which source is selected.

5 **TAPE/MD MONITOR indicator**

This lights up when the tape deck or MD recorder, etc. is selected as the input source by pressing TAPE/MD MON / EXT. DECODER (or TAPE/MD).

6 **DIGITAL and PRO LOGIC indicators**

“**DIGITAL**” lights up when the built-in Dolby Digital decoder is on. “**PRO LOGIC**” lights up when the built-in Dolby Pro Logic decoder is on.

7 **DSP indicator**

“**DSP**” lights up when the built-in digital sound field processor is on.

8 **MEMORY indicator**

This flashes for about five seconds after pressing MEMORY. During this period, the displayed station can be stored in the memory.

9 **AUTO indicator**

This lights up when the unit is in the automatic tuning mode.

10 **STEREO indicator**

This lights up when an FM stereo broadcast with sufficient signal strength is being received.

11 **Signal-level indicator**

This indicates the signal level of the station being received. If multipath interference is detected, the indication decreases.

12 **SLEEP indicator**

This lights up while the built-in SLEEP timer is on.

Remote Control

This section describes the basic operation of this unit with the remote control. First, set the selector dial to the AMP/TUN position. Refer to “PRESET REMOTE CONTROL” on page 42 for full details.

1 DSP

Press this button to switch the function of the numeric buttons to the DSP program selector. (Refer to page 8.)

2 Indicator window

This displays the name of components which can be controlled.

3 Numeric buttons (Input selector buttons)

These buttons select the input source.

- CD: To play a CD
- TUNER: To listen to an FM or AM broadcast
- TAPE/MD: To play a tape or MD
- DVD/LD: To play a DVD or LD
- D-TV: To watch a TV
- VCR: To play a video cassette
- PHONO: To play an analog record
- CBL/SAT: To watch cable TV or satellite broadcast
- V-AUX: To use a camcorder
- EXT. DEC.: To play another multi-channel source

Refer to page 8 for details.

4 TEST

Press this button to output the test tone for each speaker.

5 < (left), > (right)

These buttons adjust the settings of the SET MENU and TIME/LEVEL mode.

6 TIME/LEVEL

Press this button to select the items in the TIME/LEVEL mode.

7 SLEEP

Press this button to set the SLEEP timer.

8 INPUT

Press this button to switch the function of the numeric buttons to the input selector. (Refer to page 8.)

9 Indicator

This flashes in red when pressing a button on the remote control.

10 Selector dial

Turn this dial to select the position for the component to be controlled. (The proper code must be set for your component. Refer to “Setup codes” on page 48.) When the position is selected, the remote control is set to that component operation mode.

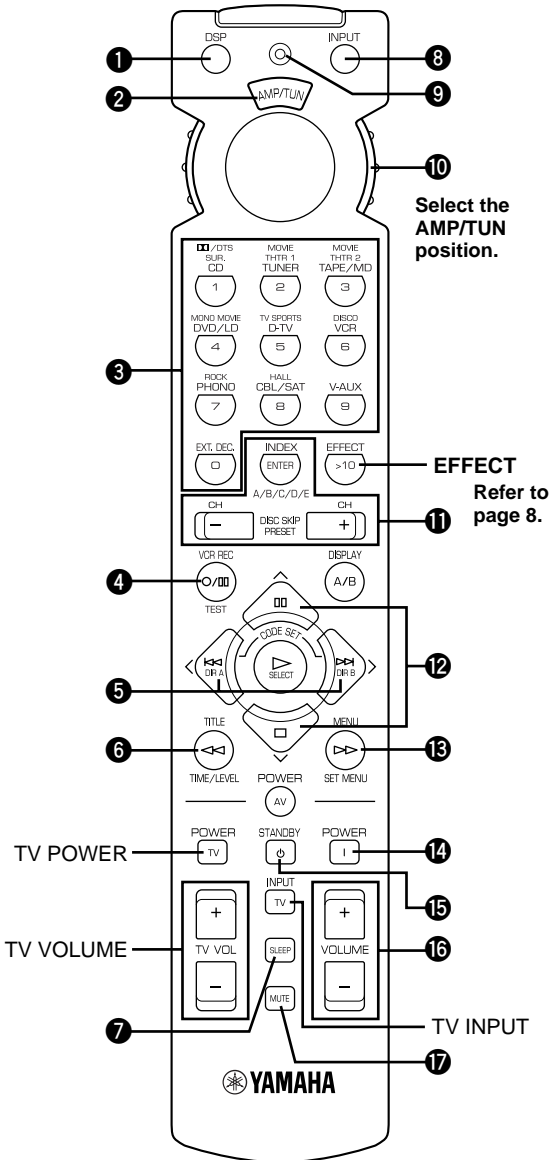

11 A/B/C/D/E, PRESET +/-

These buttons are used to select a preset station.

A/B/C/D/E: To select one of a group (A to E) of preset stations

PRESET +/-: To select a preset station number (1 to 8)

12 ∨ (next), ∧ (back)

These buttons are used to advance or go back one selection on the SET MENU and TIME/LEVEL mode.

13 SET MENU

Press this button to select the items on the SET MENU.

14 POWER

Press this button to turn this unit on.

15 STANDBY

Press this button to set this unit in the standby mode.

16 VOLUME (+/-)

These buttons are used to adjust the volume level.

17 MUTE

Press this button to mute the sound. To cancel mute, press this button again.

EFFECT

Press this button to turn on or off the effect speakers (center and rear) in the following cases:

- When the selector dial is set to the DSP/TUN position.
- While the indicator is lit for about three seconds after pressing DSP.

Description of the Numeric Buttons

The Numeric buttons function in various ways depending on the position of the selector dial or the combination of other instructions.

When selecting an input source

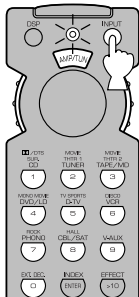

1 Press INPUT regardless of the position of the selector dial.

The indicator lights up for about three seconds.

2 You can select an input source with the numeric buttons (1 to 8) while the indicator is lit.

When selecting a DSP program and turning on or off the effect speakers (center and rear)

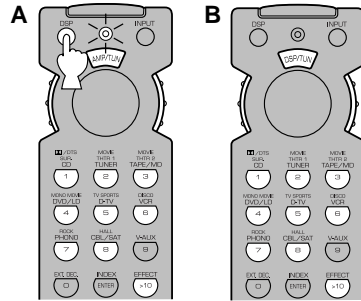

A

1 Press DSP regardless of the position of the selector dial.

The indicator lights up for about three seconds.

2 You can select a DSP program with the numeric buttons (1 to 8) and turn on or off the effect speakers (center and rear) by pressing EFFECT while the indicator is lit.

B

1 Set the selector dial to the DSP/TUN position.

2 You can select a DSP program directly with the numeric buttons (1 to 8) and turn on or off the effect speakers (center and rear) by pressing EFFECT.

When selecting a preset station number

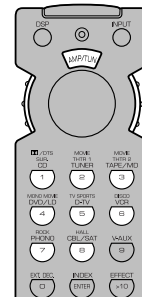

1 Set code number "0023" in the AMP/TUN (or DSP/TUN) position.

Refer to page 48 for setting the code.

2 Set the selector dial to the AMP/TUN (or DSP/TUN) position.

3 You can select a preset station number directly with the numeric buttons (1 to 8).

Refer to page 29.



SPEAKER SETUP

Speakers to Be Used

This unit is designed to provide the best sound-field quality with a 5-speaker system, using main speakers, rear speakers and a center speaker. If you use different brands of speakers (with different tonal qualities) in your system, the tone of a moving human voice and other types of sound may not shift smoothly. We recommend that you use speakers from the same manufacture or speakers with the same tonal quality.

The main speakers are used for the main source sound plus the effect sounds. They will probably be the speakers from your present stereo system. The rear speakers are used for the effect and surround sounds, and the center speaker is for the center sounds (dialog, vocals, etc.). If for some reason it is not practical to use a center speaker, you can do without it. Best results, however, are obtained with the full system.

The main speakers should be high-performance models and have enough power-handling capacity to accept the maximum output of your audio system. The other speakers do not have to be equal to the main speakers. For precise sound localization, however, it is ideal to use high-performance models that can reproduce sounds over the full range for the center speaker and the rear speakers.

■ Use of a subwoofer expands your sound field

It is also possible to further expand your system with the addition of a subwoofer. The use of a subwoofer is effective not only for reinforcing bass frequencies from any or all channels, but also for reproducing the LFE (low frequency effect) channel with high fidelity when playing back a source encoded with Dolby Digital or DTS. The YAMAHA Active Servo Processing Subwoofer System is ideal for natural and lively bass reproduction.

Speaker Placement

Refer to the following diagram when you place the speakers.

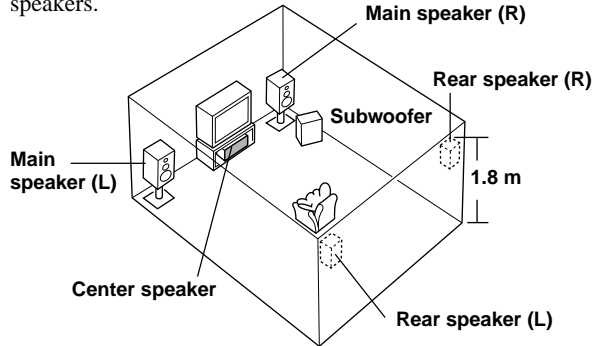

■ Main speakers

Place the right and left main speakers an equal distance from the ideal listening position. The distance of each speaker from each side of the TV monitor should be the same.

■ Rear speakers

Place these speakers behind your listening position, facing slightly inwards, nearly 1.8 m (approx. 6 feet) above the floor.

■ Center speaker

Align the front face of the center speaker with the front face of your TV monitor. Place the speaker as close to the monitor as possible, such as directly over or under the monitor and centrally between the main speakers.

Note

- If the center speaker is not used, the center channel sound will be heard from the right and left main speakers. In that case, "CENTER SP" on the SET MENU is set to the NONE position. (Refer to page 36 for details.)

■ Subwoofer

The position of the subwoofer is not so critical, because low bass sounds are not highly directional. But it is better to place the subwoofer near the main speakers. Turn it slightly toward the center of the room to reduce the wall reflections.

CAUTION

Some types of speakers interfere with a TV monitor. If this problem occurs, move the speakers away from the monitor. If you cannot avoid installing the center speaker or subwoofer near the TV monitor, use magnetically shielded speakers.



CONNECTIONS

Before Connecting Components

CAUTION

Never connect this unit and other components to mains power until all connections between components have been completed.

Be sure all connections are made correctly, that is to say L (left) to L, R (right) to R, “+” to “+” and “-” to “-”. Some components require different connection methods and have different terminal names. Refer to the instructions for each component to be connected to this unit.

When you connect other YAMAHA audio components (such as a tape deck, MD recorder and CD player or changer), connect it to the terminals with the same number labels as **1**, **3**, **4** etc. YAMAHA applies this labeling system to all its products.

Use RCA-type pin plug cables for connecting audio/video components with the exception described later.

The input and output terminals for pin plugs can be distinguished as follows:

Yellow	video signals (composite)	
White	analog audio signals for the left channel	
Red	analog audio signals for the right channel	
	coaxial digital signals	

After completing all connections, check them again to make sure they are correct.

Connecting the Antenna
(pages 11 and 12)

Connecting to an External
Decoder (page 15)

Connecting the Speakers
(pages 16 and 17)

Connecting the Power
Supply Cords (page 18)

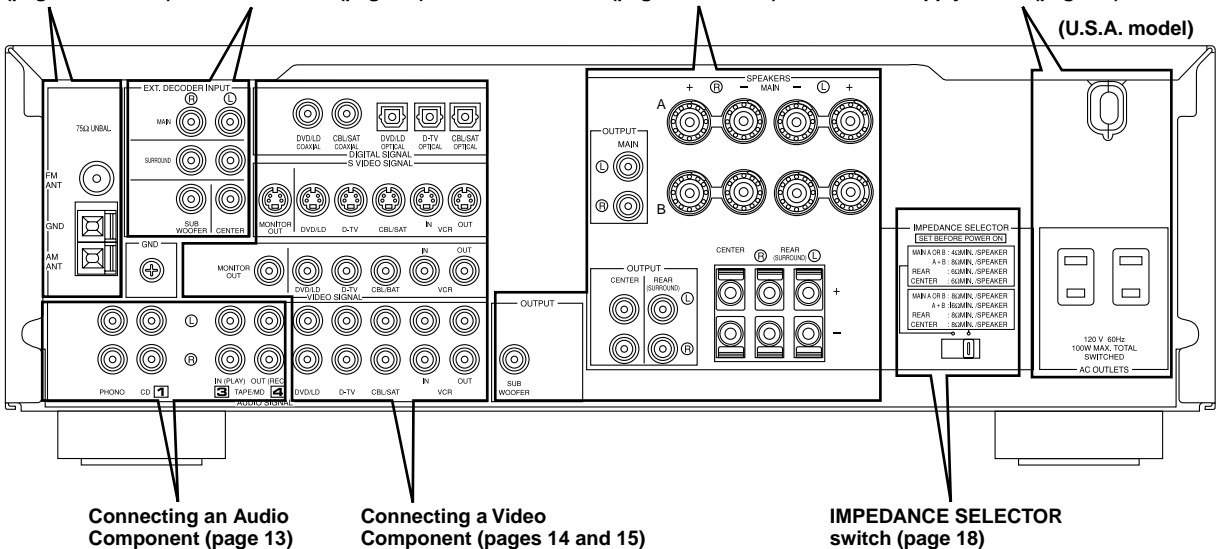

Connecting the Antennas

Both AM and FM indoor antennas are included with this unit. In general, these antennas should provide sufficient signal strength. However, a properly installed outdoor antenna provides clearer reception than an indoor one. If you experience poor reception quality, an outdoor antenna may improve the quality.

Connect each antenna correctly to the designated terminals.

Indoor FM antenna (included)

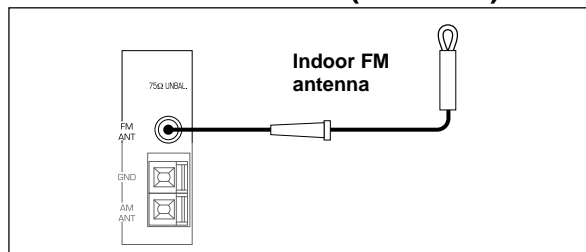

Firmly insert the connector into the FM ANT terminal. The indoor FM antenna is only a simple antenna. For reception with better sound quality, installing the outdoor FM antenna (commercially available) is recommended.

Note

- Do not connect an outdoor FM antenna and the indoor FM antenna at the same time.

Outdoor FM antenna

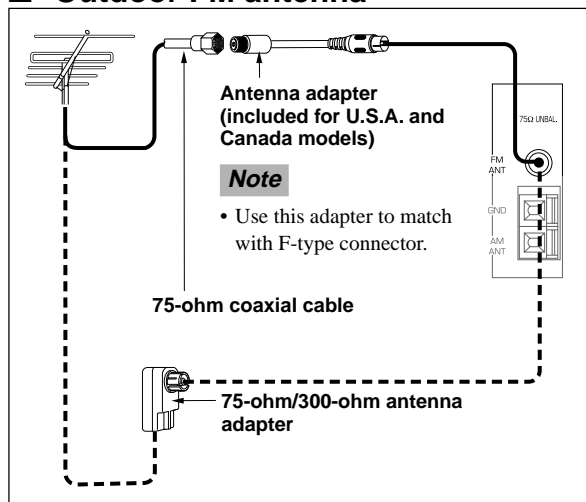

Note

- Use this adapter to match with F-type connector.

You may be unable to obtain good FM radio reception depending on your local conditions (distance from the broadcasting station, interposing buildings and mountains, etc.). Consult your dealer or authorized service center and be sure to install an antenna that suits your local conditions.

Install the outdoor FM antenna (commercially available) in a high place as far away from any roads as possible to avoid being affected by automobile ignition noise.

■ AM loop antenna (included)

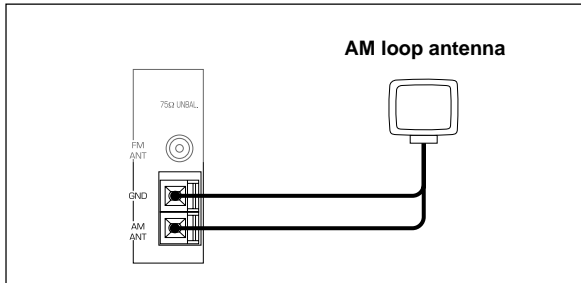

The AM loop antenna can be removed from the stand and attached to a wall, etc. However, note that the reception sensitivity may deteriorate if the antenna is attached to a metal or steel reinforced wall.

Notes

- The AM loop antenna should be placed away from this unit.
- The AM loop antenna should always be connected, even if an outdoor AM antenna is connected to this unit.

■ Connecting the AM loop antenna

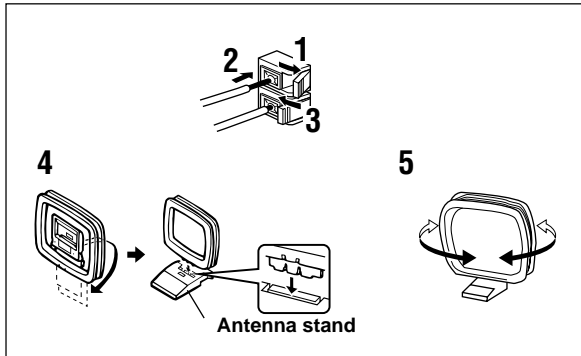

- 1** Press the tab and unlock the terminal hole.
- 2** Insert the AM loop antenna lead wires into the AM ANT and GND terminals.
- 3** Return the tab to its original position to lock the lead wires. Lightly pull the lead wires to confirm a good connection.
- 4** Attach the loop antenna to the antenna stand.
- 5** Orient the AM loop antenna so that the best reception is obtained.

■ Outdoor AM antenna

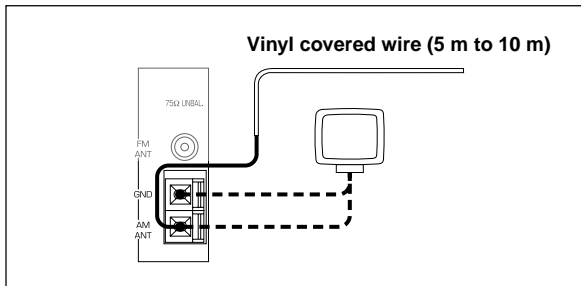

If you cannot obtain good reception with the AM loop antenna, connect 5 m to 10 m of vinyl covered wire to the AM ANT terminal and extend it outdoors from a window.

■ Ground (GND terminal)

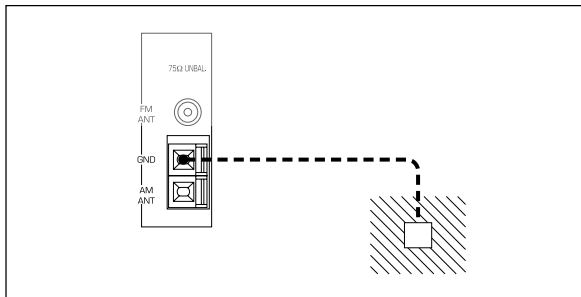

For maximum safety and minimum interference, connect the antenna GND terminal to a good earth ground. A good earth ground is a metal stake driven into moist earth.

Connecting an Audio Component

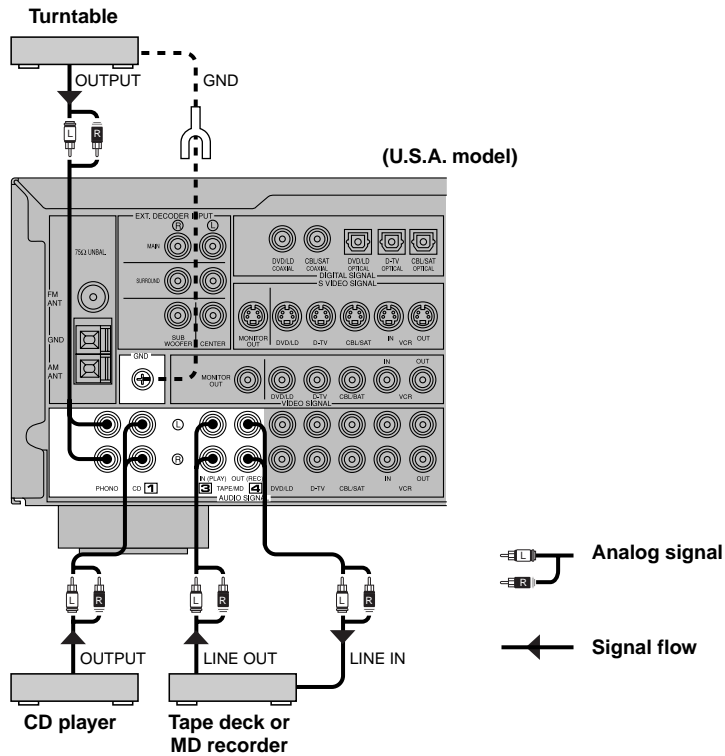

Be sure to connect the right channel (R), left channel (L), input (IN) and output (OUT) properly.

■ PHONO terminals

These terminals are used to connect a turntable with an MM or high-output MC cartridge. If you have a turntable with a low-output MC cartridge, use an inline boosting transformer or MC head amplifier when connecting to these terminals.



Connecting the ground (earth) wire of the turntable to the GND terminal will normally minimize hum, but in some cases, better results may be obtained with the ground wire disconnected.

Connecting a Video Component

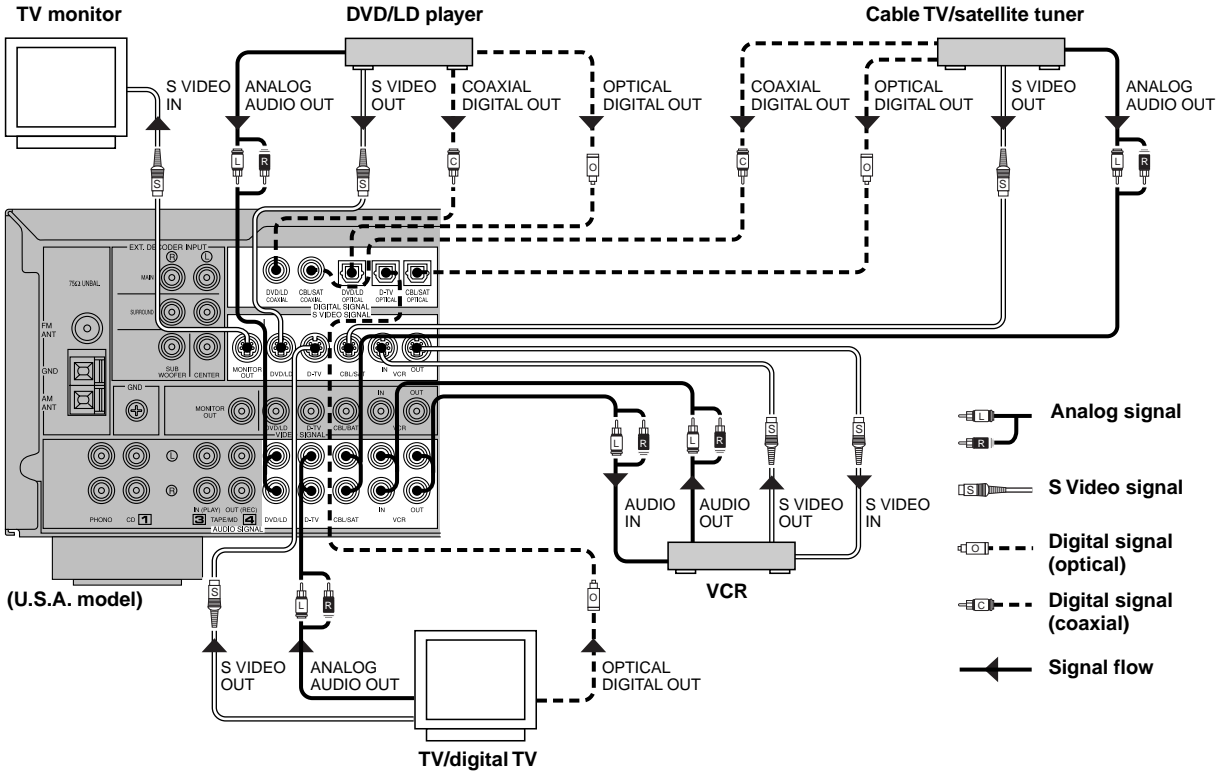

■ Audio signal terminals

Be sure to connect the right channel (R), left channel (L), input (IN) and output (OUT) properly.

■ S Video signal terminals

Use a special S VIDEO cable (commercially available) for the S VIDEO connection.

■ Digital audio signal terminals

If your DVD/LD player, TV/digital TV or cable TV/satellite tuner, etc. has coaxial or optical digital signal output terminals, they can be connected to this unit's COAXIAL and/or OPTICAL digital signal input terminals. To make a connection between the optical digital signal terminals, remove the cover from each terminal, and then connect them by using a commercially available optical fiber cable that conforms to EIA standards. Other cables might not function correctly.

When making connections between the digital signal terminals, you should connect the components to the same-named analog audio signal terminals of this unit, because a digital signal cannot be recorded by a tape deck, MD recorder or VCR connected to this unit.

Notes

- Be sure to attach the covers when the OPTICAL terminals are not being used in order to protect them from dust.
- If your LD player has a Dolby Digital RF signal output terminal, be sure to use the RF demodulator (separately purchased).
- No sound will be heard when connecting your LD player's Dolby Digital RF signal output terminal directly to this unit's COAXIAL DVD/LD digital signal input terminal.



- The input signal from the DVD/LD or CBL/SAT input terminals is selected in the following order of priority with the input mode set to AUTO: COAXIAL terminal → OPTICAL terminal → Analog terminal. Refer to page 23 for details.
- All digital signal input terminals are applicable to sampling frequencies of 32 kHz, 44.1 kHz, 48 kHz and 96 kHz. (Refer to page 24 about 96-kHz sampling 24-bit digital signals.)

VIDEO terminals (composite)

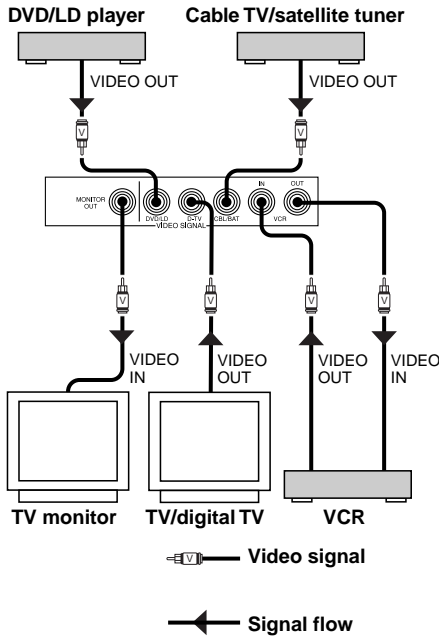

If your video components do not have “S” video terminals, they can be connected to this unit’s VIDEO terminals. Be sure to connect the input (IN) and output (OUT) properly.

Note

- If video signals are input from both the S VIDEO input and composite input terminals, the signals will be directed to their respective output terminals.

VIDEO AUX terminals (on the front panel)

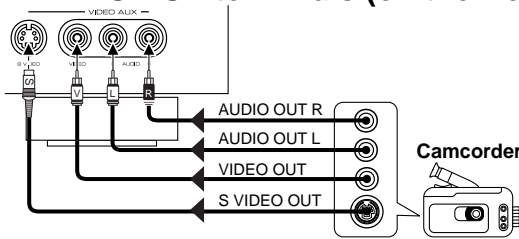

These terminals are used to connect any video input source such as a camcorder to this unit.

Connecting to an External Decoder

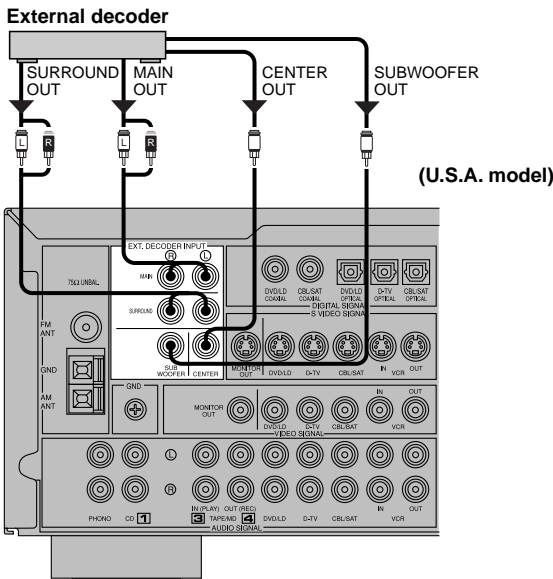

This unit has additional 6-channel audio signal input terminals for connecting an external decoder to this unit. Connect the 6-channel audio signal output terminals of the decoder to the EXTERNAL DECODER INPUT terminals of this unit.

Notes

- When a source connected to these terminals is selected, the digital sound field processor cannot be used.
- The settings of “CENTER SP”, “REAR SP”, “MAIN SP” and “BASS OUT” on the SET MENU have no effect on a source connected to these terminals. The setting of “MAIN LVL” is effective. (Refer to pages 36 and 37 for details.)
- Adjustment of the output level of the center speaker, rear speakers and subwoofer is effective when a source connected to these terminals is selected as the input source. (Refer to page 39 for details.)

Connecting the Speakers

Subwoofer connection

When using a subwoofer with built-in amplifier, including the YAMAHA Active Servo Processing Subwoofer System, connect the input terminal of the subwoofer system to the SUBWOOFER OUTPUT terminal of this unit. Low bass signals distributed from the main, center and/or rear channels are directed to this terminal. (The cut-off frequency of this terminals is 90 Hz.) The LFE (low frequency effect) signals generated when Dolby Digital or DTS is decoded are also directed if they are assigned to this terminal.

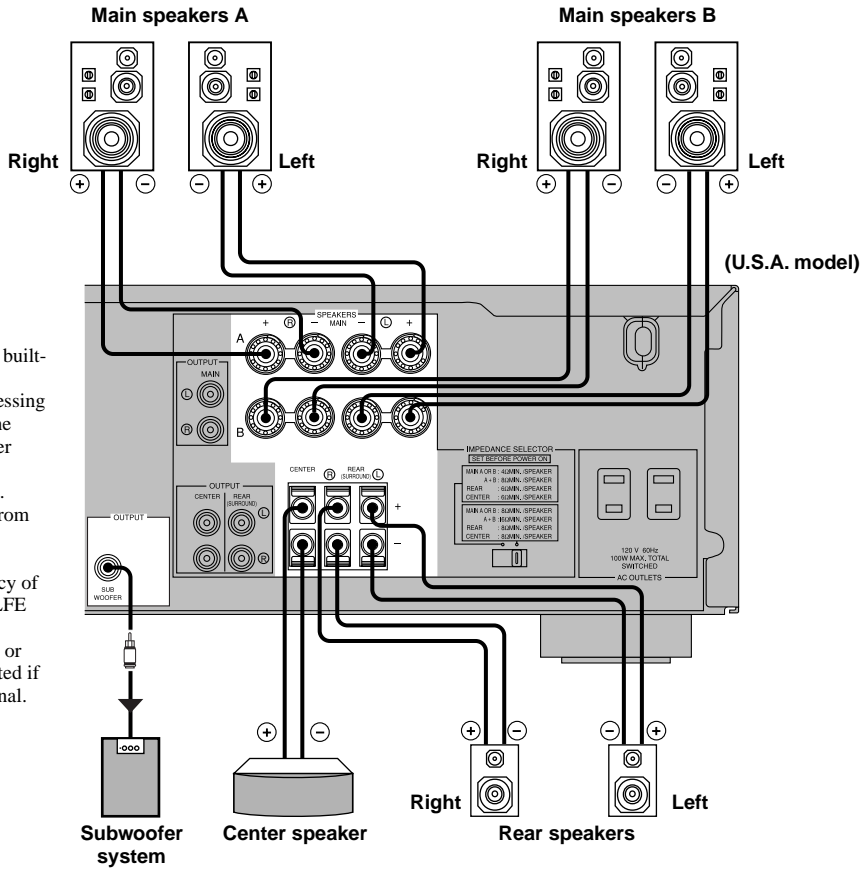

Be sure to connect the right channel (R), left channel (L), “+” (red) and “-” (black) properly. If the connections are faulty, no sound will be heard from the speakers, and if the polarity of the speaker connections is incorrect, the sound will be unnatural and lack bass.

CAUTIONS

- Use speakers with the specified impedance shown on the rear panel of this unit.
- Do not let the bare speaker wires touch each other and do not let them touch any metal part of this unit. This could damage the unit and/or speakers.

■ MAIN SPEAKERS terminals

One or two speaker systems can be connected to these terminals. If you use only one speaker system, connect it to either of the SPEAKERS A or B terminals.

■ REAR SPEAKERS terminals

A rear speaker system can be connected to these terminals.

■ CENTER SPEAKER terminals

A center speaker can be connected to these terminals.

Speaker cables

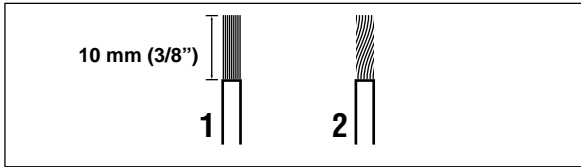

- 1** Remove approx. 10 mm (3/8") of insulation from each of the speaker cables.
- 2** Twist the exposed wires of the cable together to prevent short circuits.

Connecting to the MAIN SPEAKERS terminals

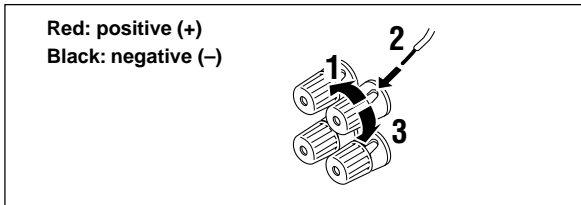

- 1** Unscrew the knob.
- 2** Insert one bare wire into the hole in the side of each terminal.
- 3** Tighten the knob to secure the wire.

Connecting to the REAR and CENTER SPEAKERS terminals

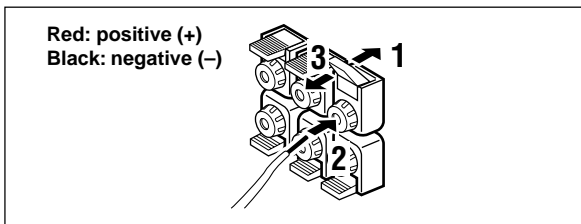

- 1** Open the tab.
- 2** Insert one bare wire into the hole of each terminal.
- 3** Return the tab to secure the wire.

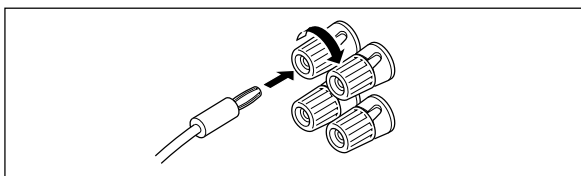

Banana plug connections are also possible. First, tighten the knob and then insert the banana plug connector into the end of the corresponding terminal.

Connecting to an external amplifier

The speaker connections described on page 16 are fine for most applications. If you wish to drive your existing amplifier, the following terminals are available for connecting an external amplifier(s) to this unit.

Note

- Output signals from these terminals are affected by the use of VOLUME, BASS, TREBLE and BALANCE.

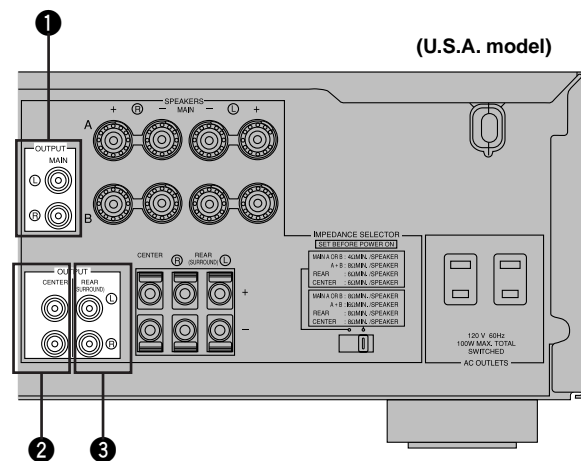

1 MAIN OUTPUT terminals

These terminals are for the main channel line output. Connect the input terminals of the external amplifier to these terminals.

2 CENTER OUTPUT terminals

These terminals are for the center channel line output. Connect the input terminals of the external amplifier to these terminals.

3 REAR (SURROUND) OUTPUT terminals

These terminals are for the rear channel line output. Connect the input terminals of the external amplifier to these terminals.

Note

- If an external amplifier is connected to the MAIN, CENTER or REAR OUTPUT terminals, disconnect the corresponding speakers (main, center or rear) from the SPEAKERS terminals.

IMPEDANCE SELECTOR Switch

WARNING

Do not change the IMPEDANCE SELECTOR switch setting while the power of this unit is on, otherwise the unit may be damaged.

If this unit fails to turn on when STANDBY/ON (or POWER) is pressed, the IMPEDANCE SELECTOR switch may not be fully slide to either position. If so, slide the switch to either position fully when this unit is in the standby mode.

Select the right or left position according to the impedance of speakers in your system. Be sure to move this switch only when this unit is in the standby mode.

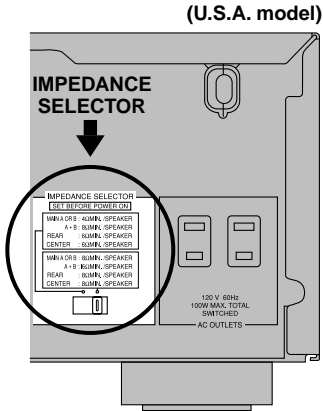

If you use	left position	right position
Main speakers	If you use one pair of main speakers, the impedance of each speaker must be 4 Ω or higher.	If you use one pair of main speakers, the impedance of each speaker must be 8 Ω or higher.
	If you use two pairs of main speakers, the impedance of each speaker must be 8 Ω or higher.	If you use two pairs of main speakers, the impedance of each speaker must be 16 Ω or higher. [Canada model only] The impedance of each speaker must be 8 Ω or higher.
Rear speakers	The impedance of each speaker must be 6 Ω or higher.	The impedance of each speaker must be 8 Ω or higher.
Center speaker	The impedance must be 6 Ω or higher.	The impedance must be 8 Ω or higher.

Connecting the Power Supply Cords

After completing all connections, connect the AC power cord to an AC power outlet. Disconnect the AC power cord if you will not use this unit for a long period of time.

AC OUTLETS (SWITCHED)

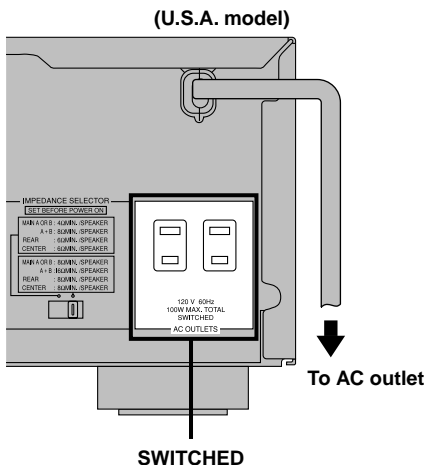

U.S.A. and Canada models 2 OUTLETS
 Australia model 1 OUTLET
 Use these outlets to connect the power cords from your components to this unit. The power to the AC OUTLET(S) is controlled by this unit's STANDBY/ON (or POWER and STANDBY). These outlets will supply power to any connected component whenever this unit is turned on. The maximum power (total power consumption of components) that can be connected to the AC OUTLET(S) is 100 W.



ADJUSTING THE SPEAKER BALANCE

This procedure lets you adjust the sound output level balance between the main, center and rear speakers by using the built-in test tone generator. When this adjustment is performed, the sound output level heard at the listening position will be the same from each speaker. This is important for the best performance of the digital sound field processor, the Dolby Pro Logic decoder, Dolby Digital decoder and DTS decoder.

Before You Start Adjusting

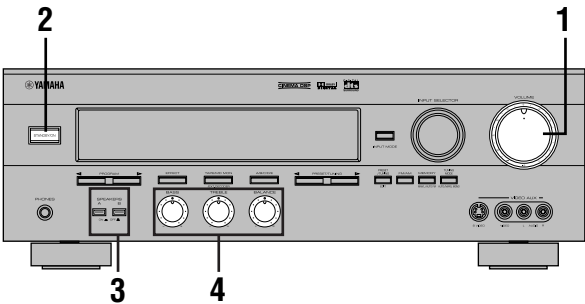

1 Set VOLUME to the “∞” position.

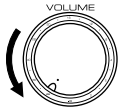

2 Turn the power on.



3 Press SPEAKERS A or B to select the main speakers to be used. If you use two main speaker systems, press both A and B.

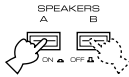

4 Set BASS, TREBLE and BALANCE to the “0” position.



Using the Test Tone

The adjustment of each speaker sound output level should be performed at your listening position with the remote control. After completing the adjustments, use VOLUME (+/-) at your listening position to check if the adjustments are satisfactory.

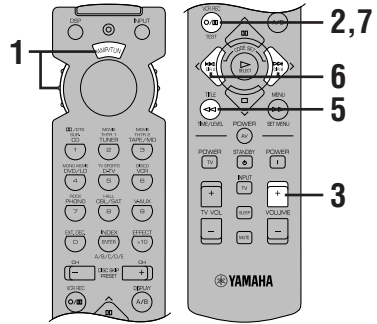

1 Set the selector dial to the AMP/TUN (or DSP/TUN) position.



2 Press TEST. “TEST LEFT” appears on the display.

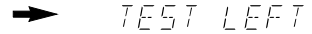

3 Turn up the volume. You will hear a test tone (like pink noise) from each speaker for about two seconds in the following order: left main speaker, center speaker, right main speaker, right rear speaker and left rear speaker. The display changes as shown below.

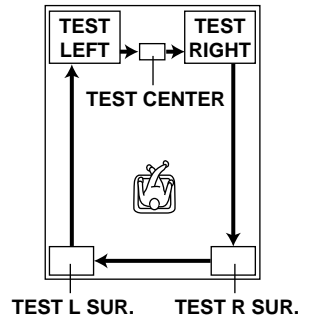
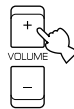

- Notes**
- If the test tone cannot be heard, turn down the volume, set the unit in the standby mode and check the speaker connections.
 - If the test tone cannot be heard from the center speaker, check the setting of “CENTER SP” on the SET MENU.

PREPARATION

English

4 Adjust **BALANCE** on the front panel so that the sound output level of the right main speaker and the left main speaker is the same.

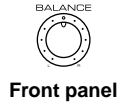

5 Press **TIME/LEVEL** repeatedly to select the speaker to be adjusted. "CENTER", "R SUR." or "L SUR." appears on the display.



After pressing TIME/LEVEL once, you can also select the item by pressing ∇ . (Pressing \wedge changes the selection in the reverse order.)

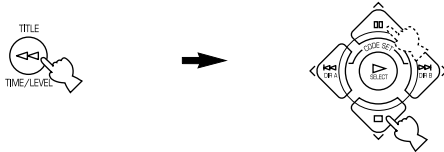

6 Press \triangleright to raise and \triangleleft to lower the level. Adjust the sound output levels of the center speaker and the rear speakers so that they become almost the same as that of the main speakers.

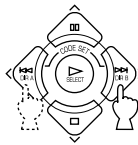

While adjusting, the test tone is heard from the selected speaker.

Note

- You cannot adjust the delay time while the test tone is being heard even if "DELAY" appears on the display.

7 When the adjustment is complete, press **TEST**. "TEST OFF" appears on the display and the test tone stops.



TEST OFF

Note

- If "CENTER SP" on the SET MENU is set to the NONE position, the sound output level of the center speaker cannot be adjusted in step 6. The center channel sound is automatically output from the right and left main speakers.



- Once you have completed the adjustments, you can only adjust the overall volume level of your audio system by using VOLUME (or VOLUME (+/-)).
- If you use external amplifiers, you may also use their volume controls to achieve the proper balance.
- If there is insufficient sound output from the center and rear speakers, you may decrease the main speaker output level by setting "MAIN LVL" on the SET MENU to "-10 dB". (Refer to page 37 for details.)

PLAYING A SOURCE

When using the remote control, set the selector dial to the AMP/TUN position.

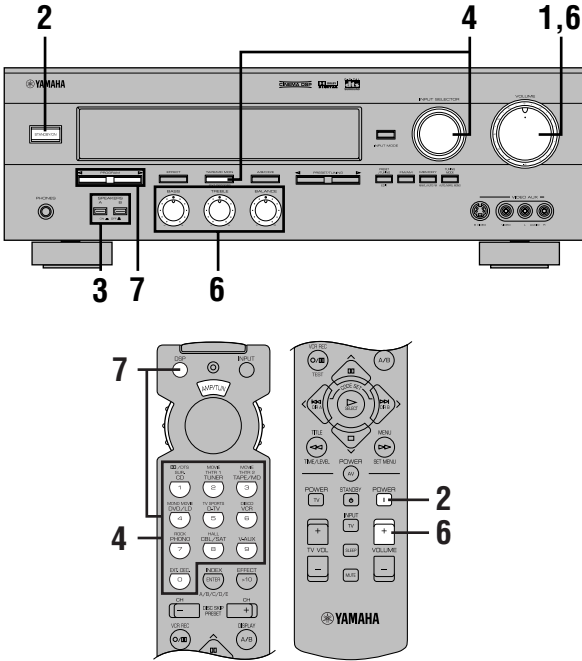

4 Select the desired input source with INPUT SELECTOR (or the input selector buttons). (Turn on the TV monitor for video sources.)

The name of the selected input source appears for a moment and the arrow for the selected input source indicator lights up on the display.

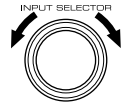

Front panel or

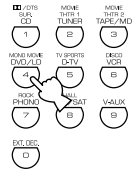

Remote control



Input source

a. To select a tape or an MD source

Press TAPE/MD MON / EXT. DECODER (or TAPE/MD MONITOR) indicator lights up on the display.

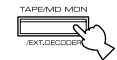

Front panel

b. To select a source connected to the EXTERNAL DECODER INPUT terminals

Press TAPE/MD MON / EXT. DECODER repeatedly (or EXT. DEC.) until "EXT. DECODER" appears on the display.

Notes

- If the "TAPE/MD MONITOR" indicator lights up or "EXT. DECODER" is shown on the display, no other audio source except a tape/MD source and a source connected to the EXTERNAL DECODER INPUT terminals can be played. To select another input source with INPUT SELECTOR (or the input selector buttons):
 - Press TAPE/MD MON / EXT. DECODER twice (or TAPE/MD once) to turn off the "TAPE/MD MONITOR" indicator.
 - Press TAPE/MD MON / EXT. DECODER once (or EXT. DEC.) to turn off "EXT. DECODER".
- If you select and play a video source when the "TAPE/MD MONITOR" indicator lights up, the play back result will be a video image from the video source and the sound from the audio source connected to the TAPE/MD IN (PLAY) terminals.
- A video source cannot be selected when "EXT. DECODER" is shown on the display. If you want to enjoy an audio source connected to the EXTERNAL DECODER INPUT terminals together with a video source, first select the video source and then select the source connected to the EXTERNAL DECODER INPUT terminals.



For the DVD/LD, TV/digital TV and cable TV/satellite tuner sources, the current input mode is also shown. Refer to page 23 for details about the input mode.

1 Set VOLUME to the "∞" position.

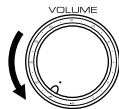

Front panel

2 Turn the power on.



Front panel



Remote control

3 Press SPEAKERS A or B to select the main speakers to be used.

If you use two main speaker systems, press both A and B.

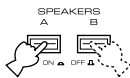

Front panel

5 Play the source.

Refer to the instructions for the source component (and page 27 for details about tuning).

Note

- When controlling an audio/video component (tape deck, MD recorder, CD player, DVD/LD player, etc.) with the remote control, set the selector dial to the appropriate position (TAPE/MD, CD, DVD/LD, etc.), corresponding to the component you want to control. Refer to “PRESET REMOTE CONTROL” on page 42.

6 Adjust the volume to the desired output level.

If desired, adjust BASS, TREBLE, BALANCE, etc. These controls are only effective for sound from the main speakers.

- BASS controls the low-frequency response.
- TREBLE controls the high-frequency response.
- BALANCE adjusts the balance of the output volume from the right and left main speakers.

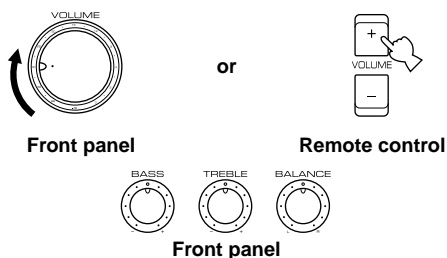
**To mute the sound**

Press **MUTE** on the remote control.



To cancel mute, press MUTE.

Note

- During muting, “MUTE ON” appears on the display.

When you have finished using this unit

Press **STANDBY/ON** (or **STANDBY**) to set this unit in the standby mode.

BGV (background video) function

The BGV function allows you to combine a video image from a video source with a sound from an audio source. (For example, you can listen to classical music while you are watching a video.) This function can only be controlled with the remote control.

Play a video source, and then select an audio source with the input selector buttons on the remote control. The BGV function does not work if you select the audio source with **INPUT SELECTOR** on the front panel.

7 Use the digital sound field processor.

Refer to page 25.

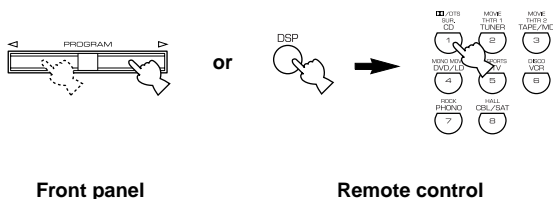

Input Mode (for the DVD/LD, TV/digital TV and cable TV/satellite tuner sources)

This unit allows you to switch the input mode for sources that send both digital and analog signals to this unit. The AUTO, DTS and ANALOG input modes are provided.

When you turn on the power of this unit, the input mode for the DVD/LD source is always set to AUTO and for TV/digital TV or cable TV/satellite tuner source is set according to “TV INPUT” and “CBL INPUT” on the SET MENU. (Refer to page 38 for details.)

■ AUTO

In this mode, the input signal is selected in the following order of priority:

1. Digital signal encoded with Dolby Digital or DTS
2. Normal digital signal (PCM)
3. Analog signal (ANALOG)

Note

- If digital signals are input from both the OPTICAL and COAXIAL terminals, the digital signal from the COAXIAL terminal is selected.

■ DTS

In this mode, only a digital signal encoded with DTS is selected, even if other signals are being input at the same time.

■ ANALOG

In this mode, only an analog signal is selected, even if a digital signal is being input at the same time. Select this mode when you want to use an analog signal instead of a digital signal.

■ Switching the input mode

Press INPUT MODE (or the input selector button that you have pressed to select the input source on the remote control) repeatedly until the desired input mode is shown on the display.

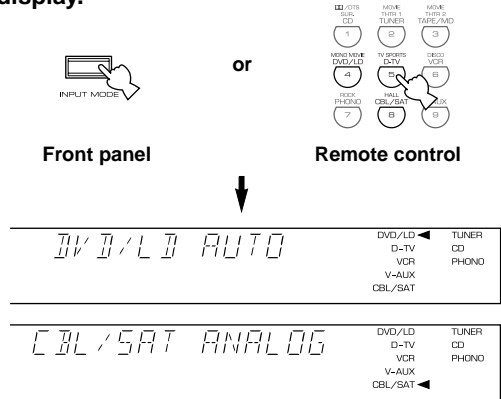

Notes

- Set the input mode to AUTO to play a DVD/LD source encoded with Dolby Digital.
- The sound output may be interrupted for some LD and DVD players in the following situation: The input mode is set to AUTO. A search is performed while playing the disc encoded with Dolby Digital or DTS, and then disc playing is restored. The sound output is interrupted for a moment because the digital signal was selected again.
- The input mode cannot be changed for the CD, TUNER, TAPE/MD, VCR, PHONO and VIDEO AUX sources because only analog signals are used for these.
- The current input mode appears on the display when the DVD/LD, TV/digital TV or cable TV/satellite tuner source is selected, or the input mode is changed.

■ Notes on playing a source encoded with DTS

- If “DATA ERROR” appears on the display while playing an LD source encoded with DTS, stop playback and turn the player off and then on again.
- If the digital output data of the player has been processed in any way, you may not be able to perform DTS decoding even if you make a digital connection between this unit and the player.
- If you play an LD source encoded with DTS and set the input mode to ANALOG, there will be the noise of an unprocessed DTS signal. When you want to play a DTS source, be sure to connect the source to the digital input terminal and set the input mode to AUTO or DTS.
- If you play a source encoded with DTS and set the input mode to AUTO, there will be a short noise at first while the unit recognizes the DTS signal and turns on the DTS decoder. This is not a malfunction, and can be avoided by setting the input mode to DTS beforehand. In addition, if you continue to play a source encoded with DTS with the input mode setting left to AUTO, this unit automatically switches to the “DTS-decoding” mode to prevent noise from being generated during subsequent operation. (The “**dts**” indicator lights up on the display.) The “**dts**” indicator will flash immediately after playback of a source encoded with DTS has finished. Only a source encoded with DTS can be played back while this indicator is flashing. If you want to play a normal PCM source soon, set the input mode back to AUTO.

■ Notes on playing an LD source

- Some audio/video components, such as an LD player, output different audio signals through their analog and digital terminals. Change the input mode as necessary.
- If the input mode is set to AUTO for the LD source, this unit automatically determines which type of signal the LD source contains. If this unit detects a Dolby Digital or DTS signal, the decoder automatically switches to the appropriate setting and reproduces 5.1 channel sound.
- If the LD player is transmitting signals by a non-normal method, this unit cannot detect the Dolby Digital or DTS signal. In this case, the decoder automatically switches to PCM or analog.
- If the LD source does not contain a digital soundtrack, connect the LD player to the analog terminals and set the input mode to AUTO or ANALOG.
- While you are operating the LD player and playing a disc encoded with Dolby Digital, if you switch from the pause or chapter forwarding function to normal playback, you may hear the PCM or analog sound an instant before the Dolby Digital sound is played.

■ Notes on the digital signal

The digital input terminal of this unit can also handle 96-kHz sampling 24-bit digital signals. (To utilize this, use a source that supports 96-kHz sampling 24-bit digital signals and set the player for digital output. Refer to the instructions for the player.) Note the following when a 96-kHz sampling 24-bit digital signal is input to this unit.

1. The following indicator will appear on the display.

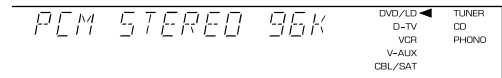

2. DSP programs cannot be selected. Sound will be output as normal 2-channel stereo sound using only the right and left main speakers.
3. Delay time and speaker output level cannot be adjusted.

DIGITAL SOUND FIELD PROCESSOR (DSP) EFFECT

Selecting a DSP Program

You can enhance your listening experience by selecting a DSP program. Refer to pages 32 to 34 for details about each program.

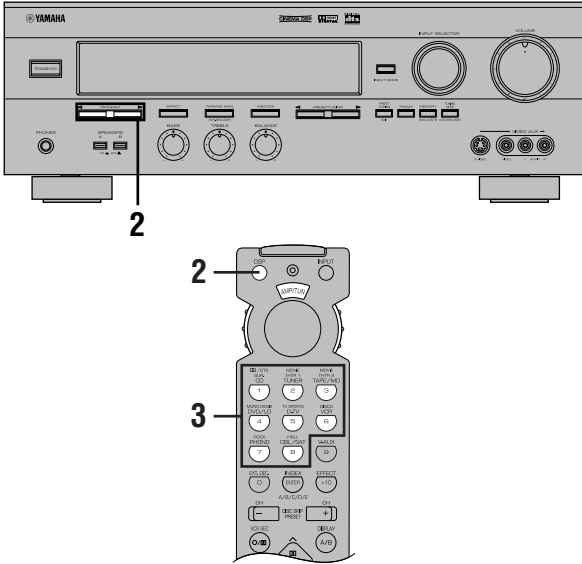

On the remote control

1 Make sure that the effect speakers (center and rear) and subwoofer are turned on.

2 Press DSP.

The indicator lights up for about three seconds.



3 Use the numeric buttons (1 to 8) to select the desired program before the indicator goes off.

The name of the selected program appears on the display.

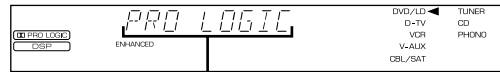
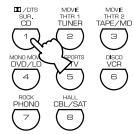

DSP program name

If the selector dial is set to the DSP/TUN position, you can select a DSP program directly with the numeric buttons.



If desired, adjust the delay time and the sound output level of each speaker. (Refer to pages 39 and 40 for details.)

On the front panel

1 Make sure that the effect speakers (center and rear) and subwoofer are turned on.

2 Press PROGRAM \blacktriangleright or \blacktriangleleft repeatedly to select the desired program.

The name of the selected program appears on the display.

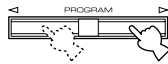

DSP program name

Notes

- You can select a DSP program for each of the input sources. Once you select a program, it is linked with the input source selected at that time. So, when you select the input source next time, the same program is automatically selected.
- When a monaural source is being played with PRO LOGIC/Normal or PRO LOGIC/ENHANCED, no sound will be heard from the main speakers and the rear speakers. Sound can only be heard from the center speaker. However, if "CENTER SP" on the SET MENU is set to the NONE position, the center channel sound is output from the main speakers.
- When a source connected to the EXTERNAL DECODER INPUT terminals of this unit is selected, the digital sound field processor cannot be used.
- When high-rate 96-kHz sampling 24-bit digital signals are input to this unit, no DSP program can be selected and the sound is only output from right and left main speakers as a normal 2-channel stereo sound.

Canceling the Sound Effect (turning off the effect speakers)

Press **EFFECT** to cancel the sound effect and monitor only the main sound.

Press **EFFECT** again to turn the sound effect back on.



Front panel
or



Remote control



If the selector dial is set to a position other than the DSP/TUN position, first press DSP and then EFFECT on the remote control.



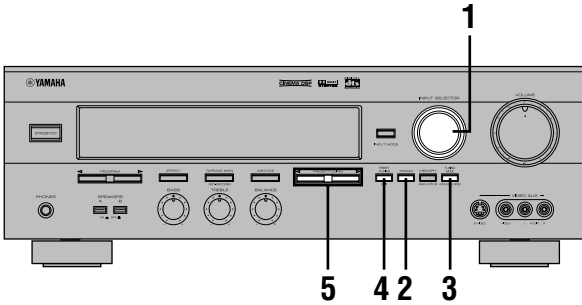

Notes

- If you turn off the sound effect when Dolby Digital or DTS is decoding, the sounds of the center and rear channels are mixed and output from the main speakers.
- If you turn off the sound effect when Dolby Digital or DTS is decoding, it may happen that the sound is output faintly or not output normally, depending on the source. In this case, turn sound effect back on.

Automatic tuning is effective when station signals are strong and there is no interference. However, if the signal from the station you want to select is weak, you must tune in to it manually (manual tuning).

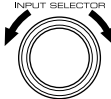

Automatic Tuning

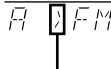

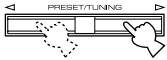



- 1** Use **INPUT SELECTOR** to select the tuner as the input source. 
- 2** Press **FM/AM** to select the reception band (FM or AM).
“FM” or “AM” appears on the display.  → FM or AM
- 3** Press **TUNING MODE** so that the “AUTO” indicator lights up on the display.  → AUTO Lights up
- 4** Press **PRESET/TUNING (EDIT)** to turn “>” off.  → 
Turn “>” off

- 5** Press **PRESET/TUNING** **>** once to tune in to a higher frequency or **<** once to tune in to a lower frequency.
Press the button again if the tuning search does not stop at the desired station. 

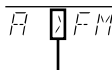

- Use the manual tuning method if the tuning search does not stop at the desired station (because the signal from the station is weak).
- When tuned in to a station, the frequency of the received station is shown on the display.

Manual Tuning

- 1** Use **INPUT SELECTOR** to select the tuner as the input source. 
- 2** Press **FM/AM** to select the reception band (FM or AM).
“FM” or “AM” appears on the display.  → FM or AM
- 3** Press **TUNING MODE** so that the “AUTO” indicator goes off.  → AUTO Goes off
- 4** Press **PRESET/TUNING (EDIT)** to turn “>” off.  → 
Turn “>” off
- 5** Press **PRESET/TUNING** **>** or **<** to tune in to the desired station.
To continue the tuning search, hold down the button. 

Note

- If you tune in manually to an FM station, it will be automatically received in monaural mode to increase the signal quality.

Automatic Preset Tuning (for FM stations only)

You can make use of the automatic preset tuning function for FM stations only. This function enables the unit to automatically tune in with strong signals and to sequentially store up to 40 FM stations (5 groups x 8 stations).

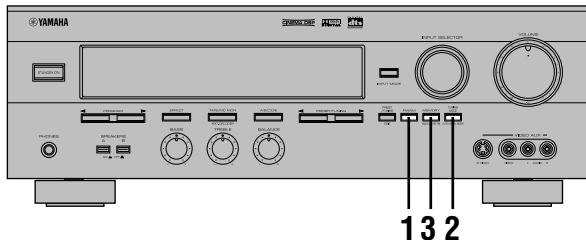

1 Press FM/AM to select the FM band.



2 Press TUNING MODE so that the "AUTO" indicator lights up on the display.



3 Hold down MEMORY for about three seconds.

The preset number, the "MEMORY" and "AUTO" indicators flash. After about five seconds, automatic preset tuning begins from the frequency currently displayed toward the higher frequencies.

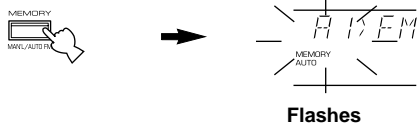

Received stations are sequentially stored as A1, A2 ... A8. If more than 8 stations have been tuned, they are stored as preset station numbers in other groups (B, C, D and E) in that order.

Memory back-up

The memory back-up circuit prevents the stored data from being lost when this unit is set in the standby mode. If, however, the power cord is disconnected from the AC power outlet or the power is cut for more than one week, the memory will be erased. If so, store the stations again by using preset tuning methods.

Automatic preset tuning options

You can select the preset number from which the unit will store FM stations and/or begin tuning toward lower frequencies. Before automatic preset tuning begins (after pressing MEMORY in step 3):

1. Press A/B/C/D/E and PRESET/TUNING > or < to select the preset number with which the first station will be stored. The automatic preset tuning will stop when stations have all been stored up to E8.
2. Press PRESET/TUNING (EDIT) to turn ">" off and then press PRESET/TUNING < to begin tuning toward lower frequencies.

When automatic preset tuning is completed

The display shows the frequency of the last preset station. Check the contents and the number of preset stations by following the procedure in the section "To Recall a Preset Station" on page 29.

Notes

- A new setting can be stored in place of the former one.
- You can manually replace a preset station with another FM or AM station by simply using the manual preset tuning method.
- Even if the number of received stations is not enough to be stored up to E8, automatic preset tuning is automatically ended after searching for all stations.
- Only FM stations with sufficient signal strength are stored by automatic preset tuning. If the station you want to store is weak in signal strength, tune in to it manually in monaural mode and store it by using the manual preset tuning method.

Manual Preset Tuning

You can also store up to 40 stations (5 groups x 8 stations) manually.

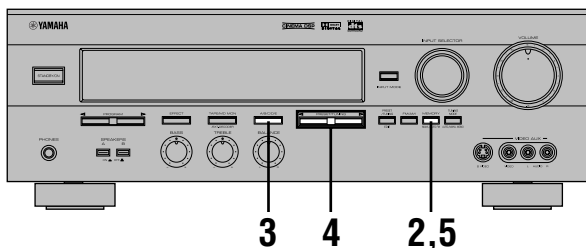

1 Tune in to the desired station.

Refer to page 27 for the tuning procedure.

2 Press MEMORY.

The “MEMORY” indicator flashes for about five seconds.

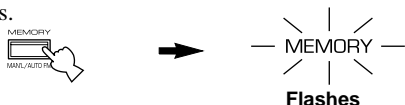

3 Press A/B/C/D/E repeatedly to select the desired group (A to E) of preset stations before the “MEMORY” indicator goes off.

Make sure that “>” appears on the display. The selected group appears on the display.



4 Press PRESET/TUNING > or < to select a preset station number (1 to 8) with which you want to store the station before the “MEMORY” indicator goes off.

Press > to select a higher preset station number and < to select a lower preset station number.



5 Press MEMORY before the “MEMORY” indicator goes off.

The displayed station has been stored as the preset group and number you have selected, and the reception band and frequency appear on the display.



6 Repeat steps 1 to 5 to store other stations.

Notes

- A new setting can be stored in place of the former one.
- The reception mode (stereo or monaural) is stored along with the station frequency.

To Recall a Preset Station

You can recall any desired station simply by selecting the preset station number with which it was stored.

You can also recall a preset station with the remote control. Set the selector dial to the AMP/TUN position and press TUNER (number 2) to select the tuner as the input source.

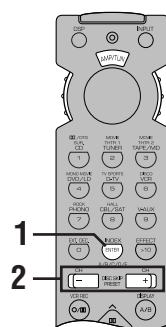
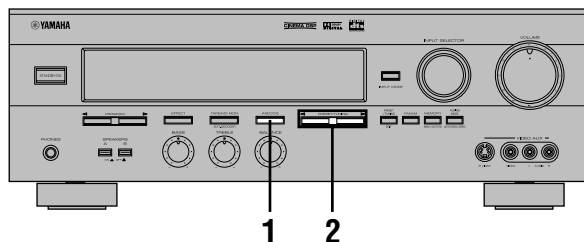

1 Press A/B/C/D/E to select the required group of preset stations.

Make sure that “>” appears on the display.



Front panel

Remote control

2 Press PRESET/TUNING > or < (or PRESET +/-) to select a preset station number (1 to 8).

The preset group and number appear on the display along with the reception band, frequency and signal strength information.

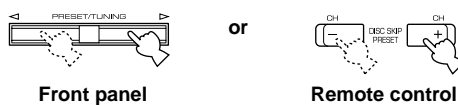

Front panel

Remote control



You can select the preset station number with the numeric buttons (1 to 8) on the remote control if code number “0023” has been set in the AMP/TUN (or DSP/TUN) position.

Exchanging Preset Stations

You can exchange the assignment of two preset stations with each other.

■ **Example: If you want to exchange preset station “E1” with “A5”**

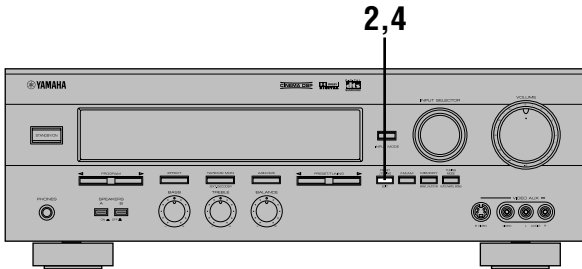

1 Recall preset station “E1”.

Refer to the procedure in the section “To Recall a Preset Station” on page 29.

2 Hold down (PRESET/TUNING) EDIT for about three second.

“E1” and the “MEMORY” indicator flash.

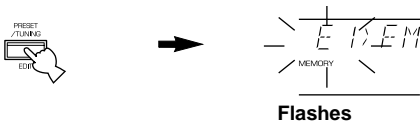

3 Recall preset station “A5” by using the buttons on the front panel.

“A5” and the “MEMORY” indicator flash.

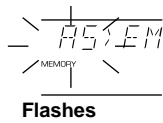

4 Press (PRESET/TUNING) EDIT again.

The display shows the exchange of stations has been completed.

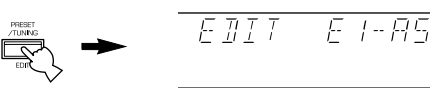

RECORDING A SOURCE ON TAPE, MD OR VIDEO CASSETTE

Recording adjustments and other operations are performed from the tape deck, MD recorder or VCR. Refer to the instructions for these components.



If a tape deck or MD recorder is being used for recording, you can monitor the sounds being recorded by pressing TAPE/MD MON / EXT. DECODER (or TAPE/MD).

Notes

- The DSP program and the setting of VOLUME, BASS, TREBLE and BALANCE have no effect on the material being recorded.
- Composite video and S video signals pass independently through this unit's video circuits. Therefore, when recording or dubbing video signals, if your video source component is connected to provide only an S video (or only a composite video) signal, you can record only an S video (or only a composite video) signal by your VCR.
- A source connected to this unit only through the digital terminals cannot be recorded by the tape deck, MD recorder or VCR connected to this unit.
- A source connected to the EXTERNAL DECODER INPUT terminals of this unit cannot be recorded.
- Check the copyright laws in your country to record from records, CDs, radio, etc. Recording of copyrighted material may infringe copyright laws.

If you play back a video source that uses scrambled or encoded signals to prevent it from being dubbed, the picture itself may be disturbed due to those signals.

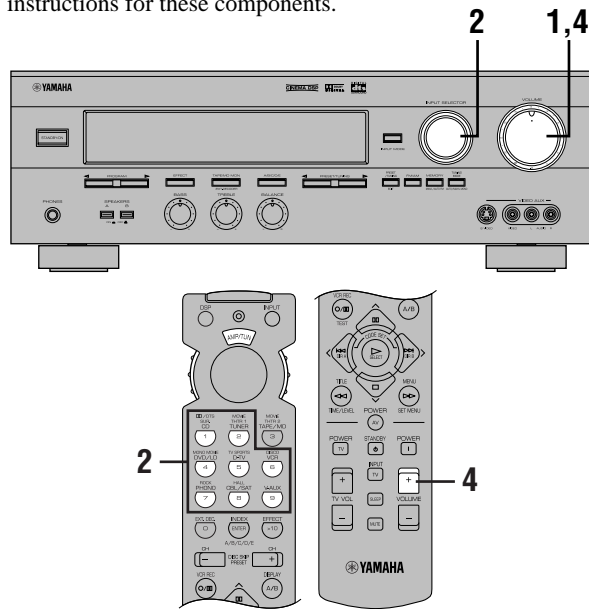

1 Set VOLUME to the "∞" position.

Front panel

2 Select the source you want to record.

Front panel or Remote control

3 Begin recording by the tape deck, MD recorder or VCR connected to this unit.

4 Play the source and then turn up the volume to confirm the input source.

Front panel or Remote control



SOUND FIELD PROGRAM

This unit incorporates a sophisticated, multi-program digital sound field processor (DSP). This processor allows you to electronically expand and change the shape of the audio sound field from both audio and video sources, creating a theater-like experience in your listening room. You can create outstanding audio sound by selecting a suitable DSP program (this will, of course, depend on what you are listening to).

When you select a CINEMA DSP program, one of the built-in decoders (Dolby Pro Logic, Dolby Digital and DTS) is turned on according to which type of signals the source being played contains.

The following list gives you a brief description of the sound fields produced by each of the DSP programs. Keep in mind that most of these are precise digital re-creations of actual acoustic environments.

- The input source given in the following table for programs 4 through 8 indicates that input source which each program is best suited for.
- Select the DSP program that you feel sounds best regardless of the name and description given for it below.

■ For movie or audio/video sources (Program No. 1 to No. 5: CINEMA DSP programs)

No.	PROGRAM	SUBPROGRAM	FEATURES
1	DD/DTS SURROUND	[1] PRO LOGIC/Normal (<input checked="" type="checkbox"/> PRO LOGIC) • Input source: Dolby Surround 2-ch Dolby Digital • Output channel: 4 channels • DSP: —	The built-in Dolby Pro Logic decoder, Dolby Digital decoder or DTS decoder precisely reproduces the sound and effect of a source encoded with Dolby Surround, Dolby Digital or DTS. The realization of a highly efficient decoding process improves cross talk and channel separation, and makes sound positioning smoother and more precise. In this program, the digital sound field processor is not turned on.
		[2] DOLBY DIGITAL/Normal (<input checked="" type="checkbox"/> DIGITAL) • Input source: Dolby Digital • Output channel: 5.1 channels • DSP: —	
		[3] DTS DGTL SUR/Normal (dts) • Input source: DTS • Output channel: 5.1 channels • DSP: —	
		[4] PRO LOGIC/ENHANCED (<input checked="" type="checkbox"/> PRO LOGIC <input type="checkbox"/> DSP) • Input source: Dolby Surround 2-ch Dolby Digital • Output channel: 4 channels • DSP: 1 (surround)	This program ideally simulates the multi-surround speaker systems of the 35 mm-film movie theater. Dolby Pro Logic decoding, Dolby Digital decoding or DTS decoding and digital sound field processing are precisely performed without altering the original sound orientation. The surround effect produced by the sound field folds around the viewer naturally from the rear to the right and left, and toward the screen.
		[5] DOLBY DIGITAL/ENHANCED (<input checked="" type="checkbox"/> DIGITAL <input type="checkbox"/> DSP) • Input source: Dolby Digital • Output channel: 5.1 channels • DSP: 2 (surround L, R)	
		[6] DTS DGTL SUR/ENHANCED (dts <input type="checkbox"/> DSP) • Input source: DTS • Output channel: 5.1 channels • DSP: 2 (surround L, R)	

No.	PROGRAM	SUBPROGRAM	FEATURES
2	MOVIE THEATER 1	<p>[1] 70 mm SPECTACLE (<input checked="" type="checkbox"/> PRO LOGIC <input type="checkbox"/> DSP)</p> <ul style="list-style-type: none"> • Input source: Dolby Surround • Output channel: 2-ch Dolby Digital • DSP: 3 channels • DSP: 2 (presence & surround) <p>[2] DGTL SPECTACLE (<input checked="" type="checkbox"/> DIGITAL <input type="checkbox"/> DSP)</p> <ul style="list-style-type: none"> • Input source: Dolby Digital • Output channel: 5.1 channels • DSP: 3 (presence & surround L, R) <p>[3] DTS SPECTACLE (<input checked="" type="checkbox"/> DTS <input type="checkbox"/> DSP)</p> <ul style="list-style-type: none"> • Input source: DTS • Output channel: 5.1 channels • DSP: 3 (presence & surround L, R) 	<p>This program creates the extremely wide sound field of a movie theater. It precisely reproduces the source sound in detail, giving both the video and the sound field incredible reality. It is ideal for any kind of video source encoded with Dolby Surround, Dolby Digital or DTS (especially large-scale movie productions).</p>
3	MOVIE THEATER 2	<p>[4] 70 mm SCI-FI (<input checked="" type="checkbox"/> PRO LOGIC <input type="checkbox"/> DSP)</p> <ul style="list-style-type: none"> • Input source: Dolby Surround • Output channel: 2-ch Dolby Digital • DSP: 3 channels • DSP: 2 (presence & surround) <p>[5] DGTL SCI-FI (<input checked="" type="checkbox"/> DIGITAL <input type="checkbox"/> DSP)</p> <ul style="list-style-type: none"> • Input source: Dolby Digital • Output channel: 5.1 channels • DSP: 3 (presence & surround L, R) <p>[6] DTS SCI-FI (<input checked="" type="checkbox"/> DTS <input type="checkbox"/> DSP)</p> <ul style="list-style-type: none"> • Input source: DTS • Output channel: 5.1 channels • DSP: 3 (presence & surround L, R) 	<p>Clearly reproduces dialog and sound effects in the latest sound form of science fiction films, thus creating a broad and expansive cinematic space amid the silence. You can enjoy science fiction films in a virtual-space sound field that includes Dolby Surround, Dolby Digital and DTS-encoded software employing the most advanced techniques.</p>
		<p>[1] 70 mm ADVENTURE (<input checked="" type="checkbox"/> PRO LOGIC <input type="checkbox"/> DSP)</p> <ul style="list-style-type: none"> • Input source: Dolby Surround • Output channel: 2-ch Dolby Digital • DSP: 3 channels • DSP: 2 (presence & surround) <p>[2] DGTL ADVENTURE (<input checked="" type="checkbox"/> DIGITAL <input type="checkbox"/> DSP)</p> <ul style="list-style-type: none"> • Input source: Dolby Digital • Output channel: 5.1 channels • DSP: 3 (presence & surround L, R) <p>[3] DTS ADVENTURE (<input checked="" type="checkbox"/> DTS <input type="checkbox"/> DSP)</p> <ul style="list-style-type: none"> • Input source: DTS • Output channel: 5.1 channels • DSP: 3 (presence & surround L, R) 	<p>Ideal for precisely reproducing the sound of the newest multi-track films. The sound field is made to be similar to that of the newest movie theaters, so the reverberations of the sound field itself are restrained as much as possible. The data for the sound field of an opera house are used for the front presence, so the three-dimensional feeling of the sound field is emphasized, and dialog is precisely oriented on the screen. By using the data for the sound field of a concert hall on the surround sound field, powerful reverberations are generated. You can enjoy watching action, adventure movies, etc. with strong presence.</p>
		<p>[4] 70 mm GENERAL (<input checked="" type="checkbox"/> PRO LOGIC <input type="checkbox"/> DSP)</p> <ul style="list-style-type: none"> • Input source: Dolby Surround • Output channel: 2-ch Dolby Digital • DSP: 3 channels • DSP: 2 (presence & surround) <p>[5] DGTL GENERAL (<input checked="" type="checkbox"/> DIGITAL <input type="checkbox"/> DSP)</p> <ul style="list-style-type: none"> • Input source: Dolby Digital • Output channel: 5.1 channels • DSP: 3 (presence & surround L, R) <p>[6] DTS GENERAL (<input checked="" type="checkbox"/> DTS <input type="checkbox"/> DSP)</p> <ul style="list-style-type: none"> • Input source: DTS • Output channel: 5.1 channels • DSP: 3 (presence & surround L, R) 	<p>This program is for reproducing sounds on a multi-track film, and is characterized by a soft and extensive sound field. The front presence of the sound field is relatively narrow. It spatially spreads all around and toward the screen, restraining echo effect of conversations without losing clarity. For the surround sound field, the harmony of music or chorus sounds beautifully in a wide space at the rear of the sound field.</p>

No.	PROGRAM	FEATURES
4	MONO MOVIE (<input type="checkbox"/> DSP) <ul style="list-style-type: none"> • Input source: Monaural • Output channel: 1 channel • DSP: 1 	This program is designed specifically to enhance monaural sources. Compared to a strictly mono setting, the sound image is wider and slightly forward of the speaker pair, lending an immediacy to the overall sound. It is particularly effective for old mono movie, news broadcasts and dialog.
5	TV SPORTS (<input type="checkbox"/> DSP) <ul style="list-style-type: none"> • Input source: Audio/Video • Output channel: 2 to 5.1 channels • DSP: 2 to 3 (presence & surround) 	This program is furnished with a tight sound field in which the sound will not spread excessively at the front, but the rear surround produces dynamic sound expansion. It is the most suitable for sports programs.

■ **For Hi-Fi audio sources**

No.	PROGRAM	FEATURES
6	DISCO (<input type="checkbox"/> DSP) <ul style="list-style-type: none"> • Input source: 2-ch PCM/Analog audio • Output channel: 2 channels • DSP: 1 	This program simulates the acoustic environment of a disco in the heart of a lively city. The sound is dense and highly concentrated.
7	ROCK CONCERT (<input type="checkbox"/> DSP) <ul style="list-style-type: none"> • Input source: 2-ch PCM/Analog audio • Output channel: 2 channels • DSP: 1 	This program is ideally suited for rock music. You will experience a dynamic and lively sound field.
8	CONCERT HALL (<input type="checkbox"/> DSP) <ul style="list-style-type: none"> • Input source: 2-ch PCM/Analog audio • Output channel: 2 channels • DSP: 1 	This program creates the expansive ambience of a large concert hall. It is suited for orchestra and opera music.

CINEMA DSP: Dolby Surround + DSP/Dolby Digital + DSP/DTS + DSP

■ **Dolby Pro Logic + 2 digital sound fields**

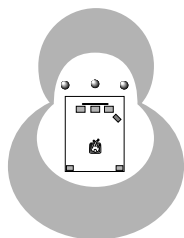

Digital sound fields are created in both the presence and rear surround zones of the Dolby Pro Logic-decoded sound field. They create a wide acoustic environment and emphasize the surround effect in the room, letting you feel as much presence as if you were watching a movie in a popular Dolby Stereo theater.

■ **Dolby Digital or DTS + 3 digital sound fields**

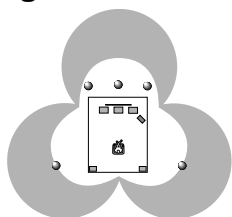

Digital sound fields are created in the presence zone and independently on the left and right surround zones of the Dolby Digital-decoded or DTS-decoded sound field. They create a wide acoustic environment and strong surround effect in the room without losing high channel separation. With the wide dynamic range of Dolby Digital or DTS sound, this sound field combination lets you feel as if you were watching a movie in the newest Dolby Digital theater or DTS-installed theater. This is the most ideal home theater sound at the present time.



SET MENU

This unit provides you with the following items on the SET MENU to maximize the performance of your system and expand your enjoyment for audio listening and video watching.

1. CENTER SP
2. REAR SP
3. MAIN SP
4. BASS OUT
5. MAIN LVL
6. D.D. LFE
7. D-RANGE
8. DTS LFE
9. CNTR DELAY
10. MEM. GUARD
11. TV INPUT
12. CBL INPUT

Adjusting Items on the SET MENU

Adjustments should be performed with the remote control while watching the information on the display.

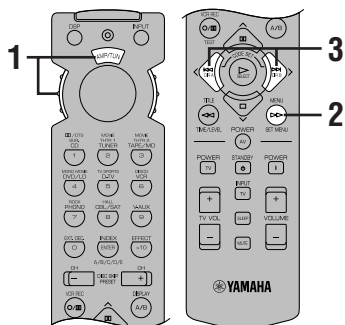

- 1 Set the selector dial to the AMP/TUN (or DSP/TUN) position.



- 2 Press SET MENU repeatedly to select the item you want to adjust.

The selected item appears on the display.



CENTER SP>LRG



After pressing SET MENU once, you can also select the item by pressing ∨. (Pressing ^ goes back one selection.)

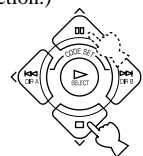

- 3 Press > or < repeatedly to adjust the setting.

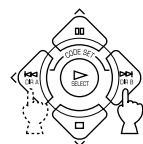

CENTER SP>SML

- 4 Repeat steps 2 and 3 to adjust the setting of any other item in the same way.

Memory back-up

The memory back-up circuit prevents the stored data from being lost when this unit is set in the standby mode. If, however, the power cord is disconnected from the AC power outlet or the power is cut for more than one week, the settings of the SET MENU will automatically return to the preset positions and values. If so, adjust the settings of the SET MENU again.

Description of Each Item

1. CENTER SP

Choices: LRG (Large)/SML (Small)/NONE

Preset position: LRG (Large)

CENTER SP>LRG

LRG (Large)

Select this position if your center speaker is approximately the same size as the main speakers. In this position, full-range signals on the center channel are directed to the center speaker.

SML (Small)

Select this position if you use a center speaker that is smaller than the main speakers. In this position, low bass signals (below 90 Hz) on the center channel are distributed to the SUBWOOFER OUTPUT terminal (or to the right and left main speakers if "BASS OUT" is set to the MAIN position).

NONE

Select this position if you do not have a center speaker (4-speaker system). In this position, full-range signals on the center channel are directed to the right and left main speakers.

2. REAR SP

Choices: LARGE/SMALL

Preset position: LARGE

REAR SP>LARGE

LARGE

Select this position if your rear speakers have high ability for bass reproduction, or if a subwoofer is connected in parallel to the rear speaker. In this position, full-range signals on the rear channels are directed to the rear speakers.

SMALL

Select this position if your rear speakers do not have high ability for bass reproduction. In this position, low bass signals (below 90 Hz) on the rear channels are distributed to the SUBWOOFER OUTPUT terminal (or to the right and left main speakers if "BASS OUT" is set to the MAIN position).

3. MAIN SP

Choices: LARGE/SMALL

Preset position: LARGE

MAIN SP>LARGE

LARGE

Select this position if your main speakers have high ability for bass reproduction. In this position, full-range signals on the main channels are directed to the right and left main speakers.

SMALL

Select this position if your main speakers do not have high ability for bass reproduction. However, if your system does not include a subwoofer, do not select this position. In this position, low bass signals (below 90 Hz) on the main channels are distributed to the SUBWOOFER OUTPUT terminal if "BASS OUT" is set to the SW position.

4. BASS OUT

Choices: SW/MAIN/BOTH

Preset position: BOTH

BASS OUT>BOTH

SW/BOTH

Select either the SW or BOTH position if your system includes a subwoofer. In either position, signals on the LFE channel and low bass signals (below 90 Hz) on the center and rear channels are directed to the SUBWOOFER OUTPUT terminal if "CENTER SP" is set to the SML or NONE position and "REAR SP" is set to the SMALL position. In the SW position, low bass signals on the main channels are directed to the SUBWOOFER OUTPUT terminal if "MAIN SP" is set to the SMALL position. In the BOTH position, low bass signals on the main channels are directed to both the main speakers and the SUBWOOFER OUTPUT terminal.

Note

- When playing a 2-channel source (tape, MD, CD, video cassette etc.), select the BOTH position to direct low bass signals (below 90 Hz) to the SUBWOOFER OUTPUT terminal.

MAIN

Select this position if your system does not include a subwoofer. In this position, besides full-range signals on the main channels, signals on the LFE channel and other low bass signals (below 90 Hz) that are distributed from other channels are directed to the right and left main speakers.

5. MAIN LVL

Choices: NORM (Normal)/-10 dB

Preset position: NORM (Normal)

MAIN LVL > NORM

NORM (Normal)

Normally select this position.

-10 dB

Select this position if the sound output from the main speakers is too loud and cannot be balanced with the sound output from the center and rear speakers. In this position, the sound output from the main speakers is attenuated.

Notes

- The setting of “CENTER SP”, “REAR SP”, “MAIN SP” and “BASS OUT” have no effect on a source connected to the EXTERNAL DECODER INPUT terminals on the rear of this unit.
- Once you have adjusted appropriately for “CENTER SP”, “REAR SP”, “MAIN SP”, “BASS OUT” and “MAIN LVL”, you do not have to change any settings unless your speaker system is modified.

6. D.D. LFE (Adjusting the output level of the LFE channel for Dolby Digital)

Control range: -20 dB to 0 dB (in 1 dB steps)

Preset value: 0 dB

D \ D \ LFE 0dB

Note

- This adjustment is only effective when Dolby Digital is being decoded and the selected source encoded with Dolby Digital contains LFE signals.

This adjusts the output level of the LFE channel. If the LFE signals are mixed with signals of other channels and they are directed to the same speakers, the ratio of the LFE signal level to the level of the other signals can be adjusted.

7. D-RANGE (Adjusting the dynamic range)

Choices: MAX/STD (Standard)/MIN

Preset position: MAX

D-RANGE > MAX

Note

- This adjustment is only effective when Dolby Digital is being decoded.

“Dynamic range” is the difference between the maximum level and the minimum level of sounds. Sounds on a movie originally designed for movie theaters feature a very wide dynamic range. Dolby Digital technology can modify the original sound track into a home audio format with this wide dynamic range unchanged. Powerful sounds of extremely wide dynamic range are not always suitable for home use. Depending on the condition of your listening environment, it may not be possible to increase the sound output to a level as high as that in a movie theater. However, at the normal level suitable for listening in your room, the low-level parts of source sound often cannot be heard well because they will be lost among noise in your environment. Dolby Digital technology has also made it possible to reduce an original sound track’s dynamic range for a home audio format by “compressing” the sound data.

MAX

In this position, a source encoded with Dolby Digital is reproduced in the original sound track’s wide dynamic range to provide you with powerful sounds just like those in a movie theater. Selecting this position will be even better if you can listen to a source at a high output level in a room specially soundproofed for audio/video enjoyment.

STD (Standard)

In this position, a source encoded with Dolby Digital is reproduced in the “compressed” dynamic range of the source that is suitable for low-level listening.

MIN

In this position, the dynamic range is more reduced than in the STD position. Selecting this position will be effective when you must listen to a source at a low level.

Note

- It may happen that sound is output faintly or not output normally depending on the source. In that case, select the MAX or STD position.

8. DTS LFE (Adjusting the output level of the LFE channel for DTS)

Control range: -10 dB to +10 dB (in 1 dB steps)

Preset value: 0 dB

DTS LFE 0^{dB}

Note

- This adjustment is effective only when DTS is being decoded and the selected source encoded with DTS contains LFE signals.

This adjusts the output level of the LFE channel. If the LFE signals are mixed with signals of other channels and they are directed to the same speakers, the ratio of the LFE signal level to the level of the other signals can be adjusted.

9. CNTR DELAY (Adjusting the delay of the sound from the center speaker)

Control range: 0 ms to 5 ms (in 1 ms steps)

Preset value: 0 ms

CNTR DELAY 0_{ms}

This adjusts the delay between the main sound (on the main channels) and dialog, etc. (on the center channel). The larger the value, the later the dialog, etc. is generated.

This makes sounds from the left main, center and right main speakers reach your listening position at the same time. This is achieved by delaying the sound from the center speaker if the distance from the center speaker to your listening position is shorter than the distance from the right and left main speaker to your listening position.

10. MEM. GUARD (Locking the settings)

Choices: ON/OFF

Preset position: OFF

MEM. GUARD > OFF

If you wish to prevent accidental alterations to the settings of the SET MENU and other adjustments on this unit, select the ON position. The following settings on this unit can be locked:

- Settings of other items on the SET MENU
- Settings in the TIME/LEVEL mode
- Settings when using TEST

11. TV INPUT (Selecting the initial input mode for a source connected to the D-TV input terminals)

Choices: AUTO/LAST

Preset position: AUTO

TV INPUT > AUTO

The input mode for a source connected to the D-TV input terminals of this unit can be automatically set when the power of this unit is turned on. Refer to page 23 for details about the input mode.

AUTO

In this position, the input mode is always set to AUTO.

LAST

In this position, the input mode is automatically set to that selected the last time when the power of this unit was turned on.

12. CBL INPUT (Selecting the initial input mode for a source connected to the CBL/SAT input terminals)

Choices: AUTO/LAST

Preset position: AUTO

CBL INPUT > AUTO

The input mode for a source connected to the CBL/SAT input terminals of this unit can be automatically set when the power of this unit is turned on. Refer to page 23 for details about the input mode.

AUTO

In this position, the input mode is always set to AUTO.

LAST

In this position, the input mode is automatically set to that selected the last time when the power of this unit was turned on.



DELAY TIME AND SPEAKER OUTPUT LEVELS

When using the digital sound field processor with the Dolby Pro Logic decoder, Dolby Digital decoder or DTS decoder, you can adjust the delay time between the main sound and sound effect, and each speaker's output level as you wish.

Note

- When high-rate 96-kHz sampling 24-bit digital signals are input to this unit, the delay time and speaker output levels cannot be adjusted.

Delay Time

You can adjust the time difference between the beginning of the sound from the main speakers and the beginning of the sound effect from the rear speakers. The larger the value, the later the sound effect is generated. The delay time can be individually adjusted to all DSP programs.

Notes

- Adding too much delay will cause an unnatural effect with some sources.
- The sound is momentarily interrupted while adjusting the delay time.

	Program	Control range (ms)	Preset value
1.	PRO LOGIC/Normal	15 to 30	20
	DOLBY DIGITAL/Normal	0 to 15	5
	DTS DGTL SUR/Normal	0 to 15	5
	PRO LOGIC/ENHANCED	15 to 30	20
	DOLBY DIGITAL/ENHANCED	0 to 15	5
	DTS DGTL SUR/ENHANCED	0 to 15	5
2.	70 mm SPECTACLE	15 to 30	23
	DGTL SPECTACLE	1 to 99	15
	DTS SPECTACLE	1 to 99	15
	70 mm SCI-FI	15 to 30	20
	DGTL SCI-FI	1 to 99	16
	DTS SCI-FI	1 to 99	16
3.	70 mm ADVENTURE	15 to 30	20
	DGTL ADVENTURE	1 to 99	15
	DTS ADVENTURE	1 to 99	15
	70 mm GENERAL	15 to 30	20
	DGTL GENERAL	1 to 99	15
	DTS GENERAL	1 to 99	15
4.	MONO MOVIE	1 to 99	49
5.	TV SPORTS	1 to 99	9
6.	DISCO	1 to 99	40
7.	ROCK CONCERT	1 to 99	16
8.	CONCERT HALL	1 to 99	44

Sound Output Level of the Center, Right Rear and Left Rear Speakers, and Subwoofer

If desired, you can adjust the sound output level of each speaker even if it has already been adjusted in "ADJUSTING THE SPEAKER BALANCE" on pages 19 and 20.

Notes

- The sound output level of the center speaker cannot be adjusted when the input signal is analog, PCM audio, or encoded with Dolby Digital in 2-channel.
- If "CENTER SP" on the SET MENU is set to the NONE position, the sound output level of the center speaker cannot be adjusted. This is because the center channel sound is automatically output from the right and left main speakers.
- Once the sound output level has been adjusted, the level will be the same for all DSP programs.

Speaker	Control range (dB)	Preset value
Center	MIN, -20 to +10	0
Right rear	MIN, -20 to +10	0
Left rear	MIN, -20 to +10	0
Subwoofer	MIN, -20 to 0	0

Adjusting Method

Adjustments should be performed with the remote control while watching the information on the display.

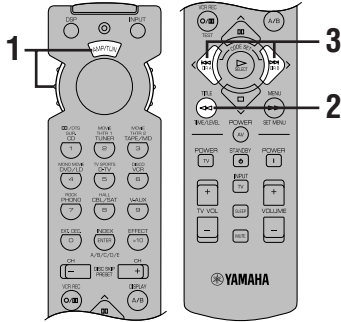

- 3** Press > or < to adjust the delay time or speaker output levels.

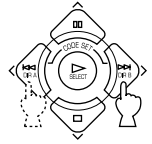

- 4** Repeat steps 2 and 3 to adjust the settings of any other item.

- 1** Set the selector dial to the AMP/TUN (or DSP/TUN) position.



- 2** Press TIME/LEVEL repeatedly to select the item you want to adjust.

Each time you press TIME/LEVEL, the selected item changes and appears on the display as shown below.

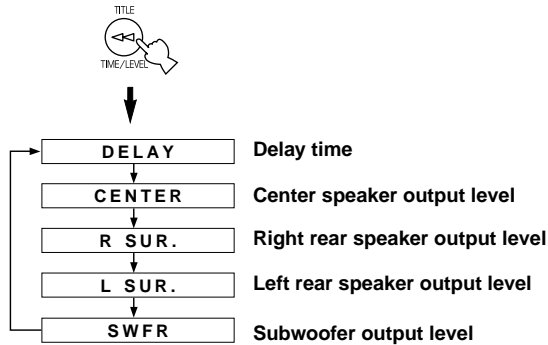

You can also select the item by pressing ∨. (Pressing ∧ changes the selection in the reverse order.)

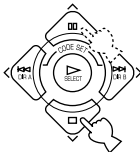

Note

- Depending on the setting of the SET MENU, you may not be able to select all these items.



SLEEP TIMER

The SLEEP timer can be used to automatically set this unit in the standby mode. This timer is useful when you are going to sleep while enjoying the desired input source. The SLEEP timer can only be set with the remote control.

Note

- The SLEEP timer is effective for the components connected to the AC OUTLET(S) on the rear panel of this unit.

Setting the SLEEP Timer

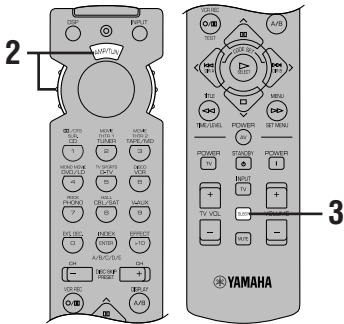

1 Play a source you want to enjoy when you are going to sleep.

2 Set the selector dial to a position other than the TV position.



3 Press SLEEP repeatedly to select the desired SLEEP time.



Each time you press SLEEP, the SLEEP time will change as below:

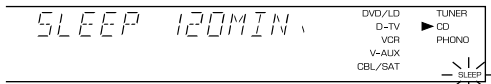
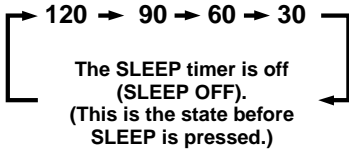

Flashes

4 The "SLEEP" indicator soon lights up on the display after the SLEEP timer has been set. The display returns to the previous indication.

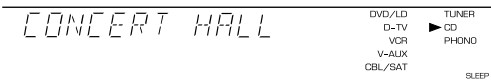

Lights up

Canceling the Selected SLEEP Timer

Press SLEEP repeatedly until "SLEEP OFF" appears on the display.

It will soon disappear and the "SLEEP" indicator will go off.

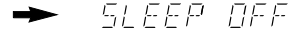

Note

- The SLEEP timer can also be canceled by setting the unit in the standby mode by using STANDBY on the remote control (or STANDBY/ON on the front panel), or by disconnecting the AC power cord from the AC power outlet.



PRESET REMOTE CONTROL

The provided remote control is factory set to control not only this unit but also most YAMAHA audio components connected to it.

Selector Dial

There are nine positions that you can select to control connected components with this remote control. For example, if the CD position is selected, the remote control is set in the CD operation mode, allowing the CD player to be operated by the buttons on the remote control. When turning the selector dial, the position changes as follows:

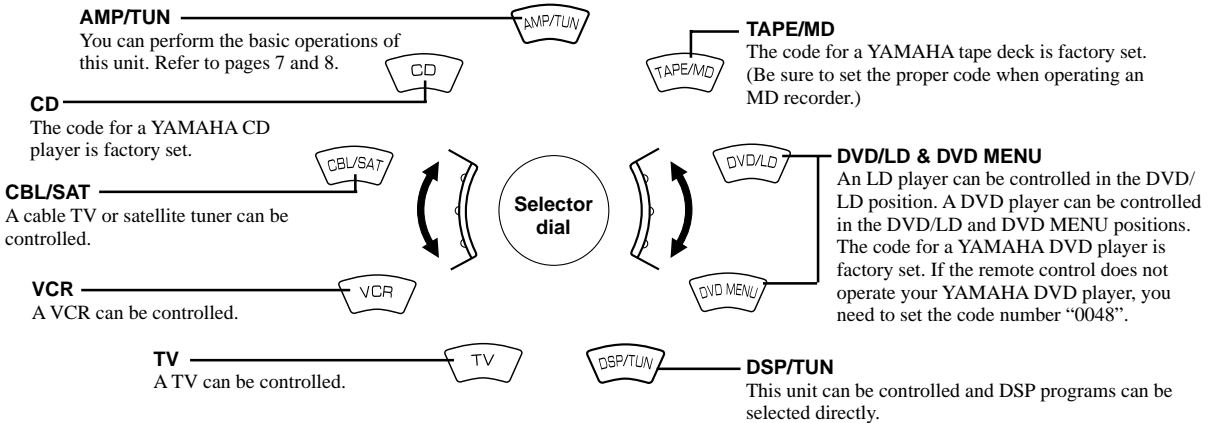

Note

- The button functions on the remote control differ depending on the position of the selector dial. Refer to the following pages for details.

Commonly used buttons in any position of the selector dial

Regardless of the position of the selector dial, you can control this unit and your TV with the following buttons.

Note

- You have to set the code for your TV before you can control the TV.

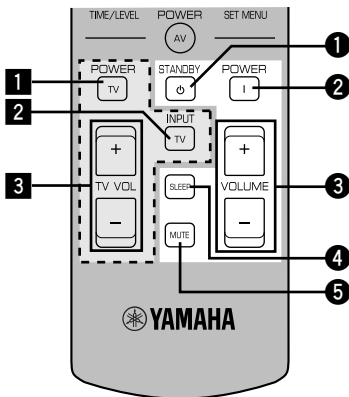

Controlling this unit

Refer to pages 7 and 8.

- STANDBY
- POWER
- VOLUME (+/-)
- SLEEP

Note

- If you have set the code for your TV and set the selector dial to the TV position, this button is used to set the SLEEP timer for the TV.

- MUTE

Note

- If you have set the code for your TV and set the selector dial to the TV position, this button is used to mute the TV sound.

Controlling your TV

- TV POWER
- TV INPUT
- TV VOLUME

Controlling the Components Connected to This Unit

■ Example: To control a YAMAHA CD player

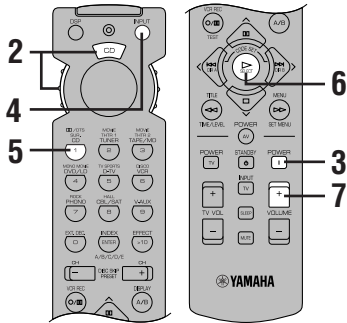

1 Make sure that **VOLUME** is set to the “∞” position.

2 Set the selector dial to the CD position.



3 Turn on the power.



4 Press **INPUT**.

The indicator lights up for about three second.



5 Press **CD** (number 1) while the indicator is lit.



6 Press **▶**.

Refer to page 45 for the CD player operation buttons.

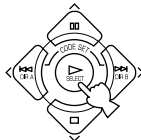

7 Adjust the volume.

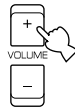

If you set the remote control with the manufacturers' codes **listed from page i at the end of this manual**, you can control other brands of components. Refer to “Setup codes” on page 48 for details.

Description of Each Position

■ TAPE/MD position

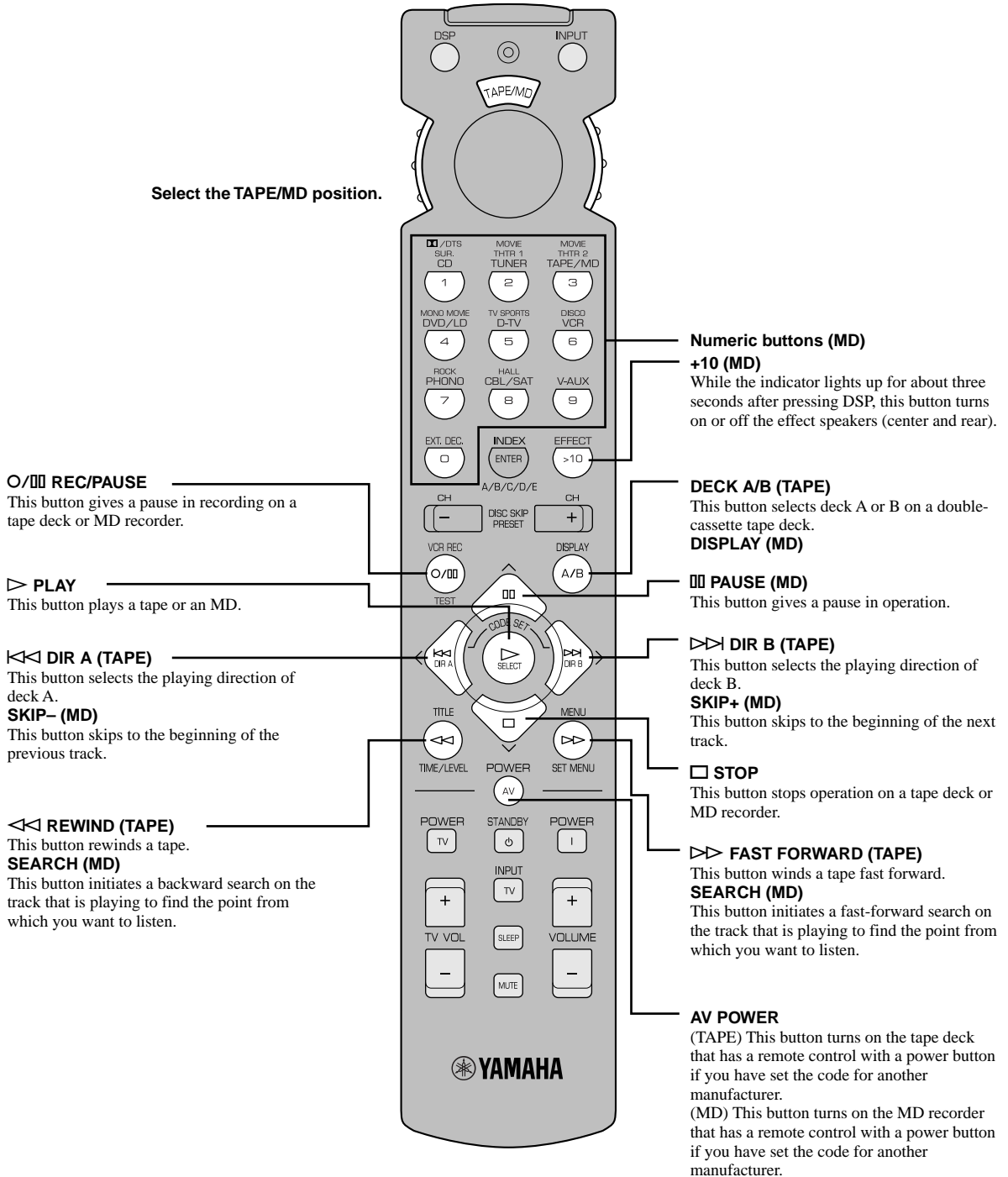

- The dark-shaded buttons do not function.
- If your component does not respond to any of the codes listed for the manufacturer, use the original remote control supplied with your component.

■ CD position

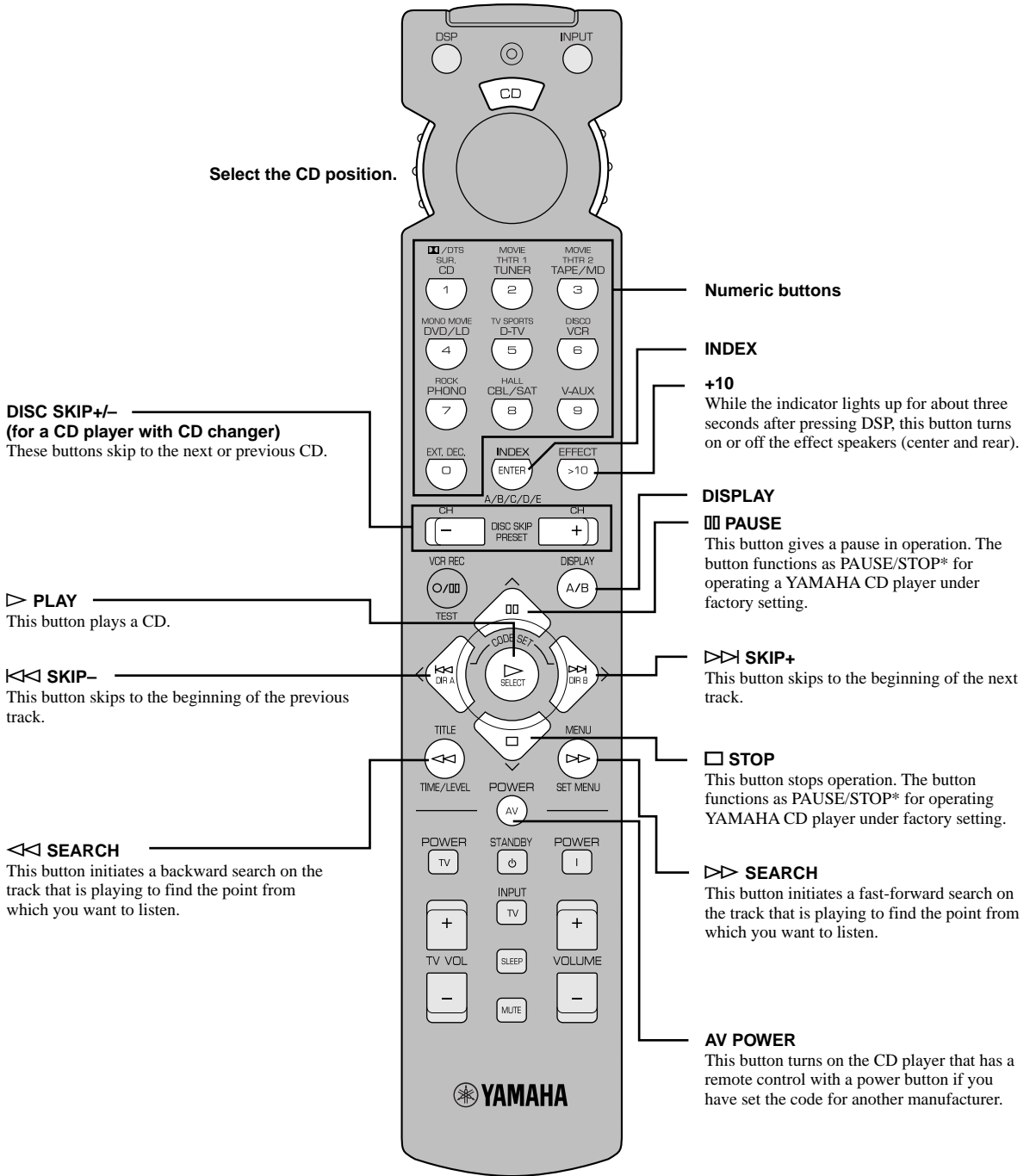

ADVANCED OPERATION

PAUSE/STOP function

Press the button once to give a pause in operation and press once more to stop operation.

- The dark-shaded buttons do not function.
- If your component does not respond to any of the codes listed for the manufacturer, use the original remote control supplied with your component.

English

DVD/LD position

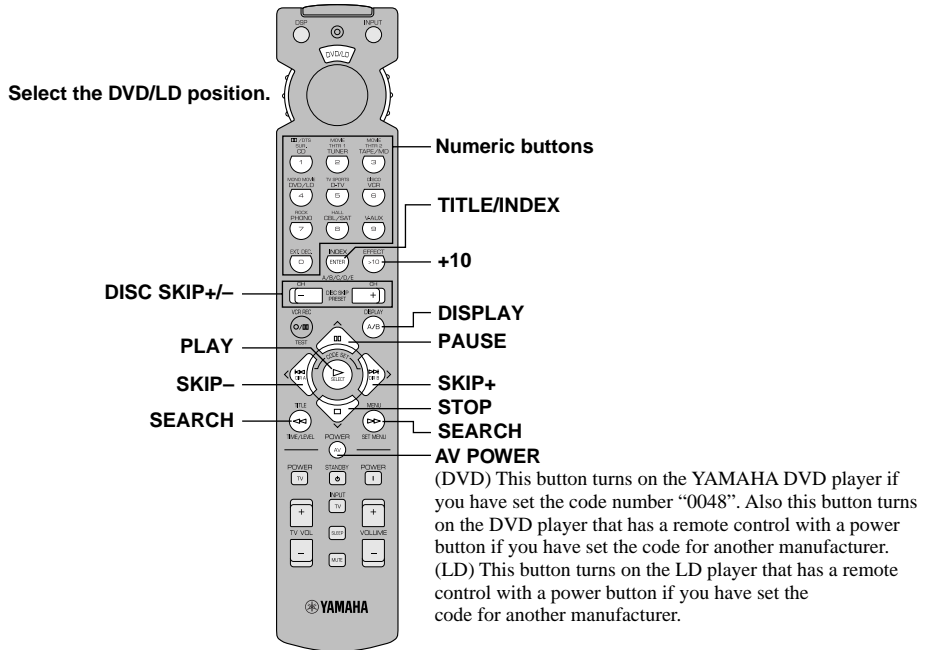

DVD MENU position

Note

- DVD MENU operations cannot be performed for some DVD players.

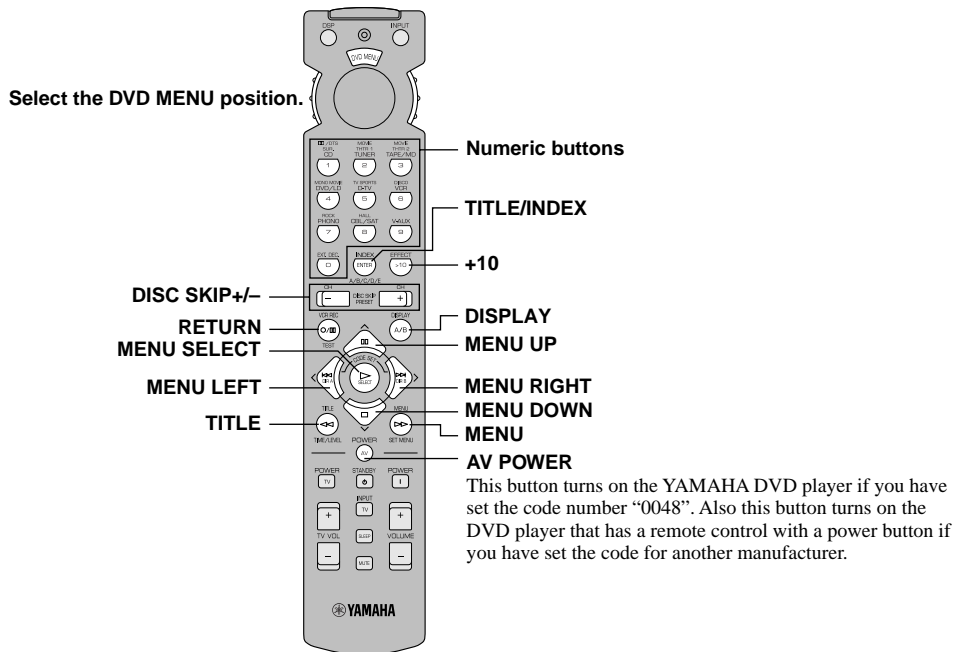

- The dark-shaded buttons do not function.
- If your component does not respond to any of the codes listed for the manufacturer, use the original remote control supplied with your component.

■ VCR position

■ CBL/SAT position

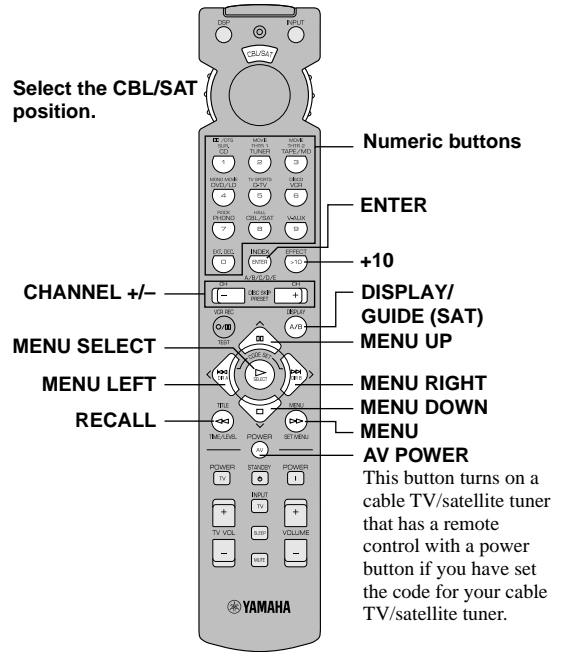
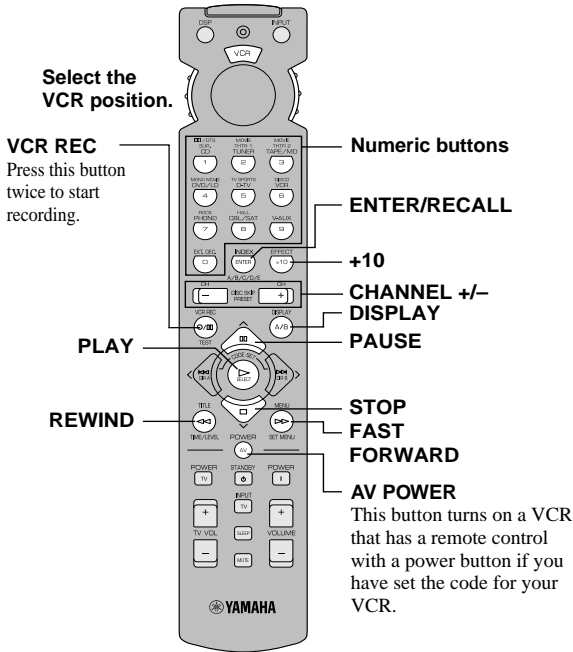

■ TV position

Note

- You can control your VCR if you have set the code for it.

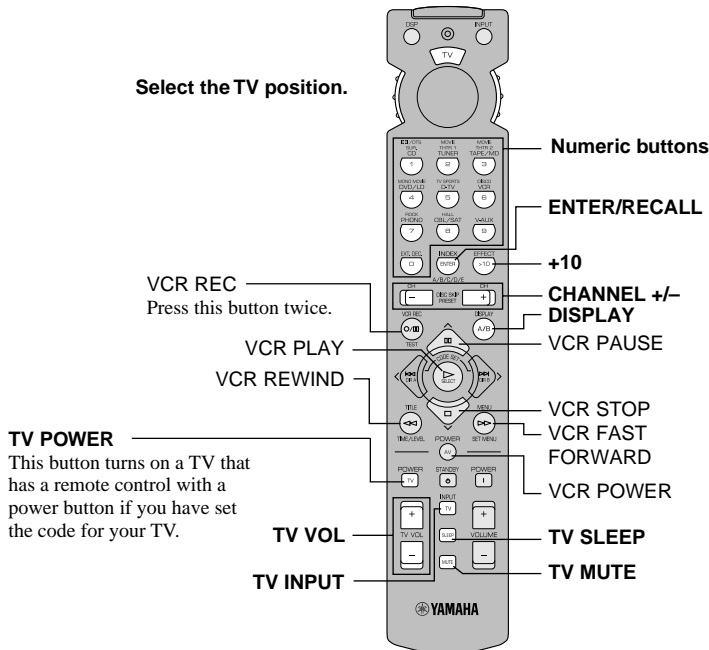

- The dark-shaded buttons do not function.
- If your component does not respond to any of the codes listed for the manufacturer, use the original remote control supplied with your component.

Advanced Information

■ Setup codes

You can set the code for the manufacturer of your component in each position of the selector dial.

1 Turn on your component to be used.

2 Set the selector dial to the desired position for the component (TAPE/MD, CD, DVD/LD, etc.).

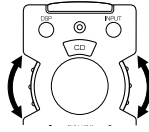

3 Press > (right) and < (left) at the same time for about four seconds.

The indicator flashes twice.

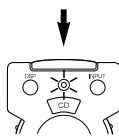
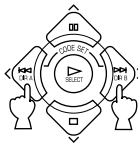

4 Use the numeric buttons to enter the four-digit manufacturer's code for the component to be used. Make sure that the indicator flashes twice.

If the indicator does not flash or flashes rapidly several times, repeat step 3 and re-enter the code.

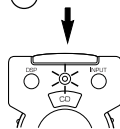
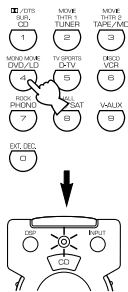

5 Press AV POWER (or any other button) on the remote control to check if you have set the code correctly.

If your component cannot be controlled with the remote control, try setting another code for the same manufacturer.



Notes

- You can set only one code for one position.
- In the DVD/LD and DVD MENU positions:
 - Be sure to set the selector dial to the DVD/LD position before entering the code for the DVD/LD player. The code set in the DVD/LD position is also simultaneously set in the DVD MENU position. You cannot set the code for a DVD player when the selector dial is set to the DVD MENU position.
- If your component does not respond to any of the codes listed for the manufacturer, use the original remote control supplied with your component.

■ To use a second (and third) VCR

You can control a second (and third) VCR in the CBL/SAT and DVD MENU positions if a cable TV or satellite tuner, or DVD player is not being used.

Note

- If you want to control a second (and third) VCR in the DVD MENU position, you must set the code for an LD player in the DVD/LD position.

1 Turn on the VCR to be used.

2 Set the selector dial to the CBL/SAT or DVD MENU position.

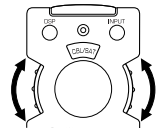

3 Press > (right) and < (left) at the same time for about four seconds.

The indicator flashes twice.

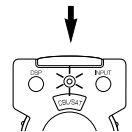
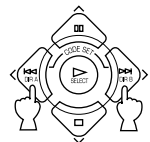

4 Use the numeric buttons to enter the four-digit code for the second (and third) VCR. Make sure that the indicator flashes twice.

If the indicator does not flash or flashes rapidly several times, repeat step 3 and re-enter the code.

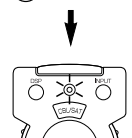
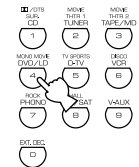

5 Press AV POWER (or any other button) on the remote control to check if you have set the code correctly.

If the VCR cannot be controlled with the remote control, try setting another code for the same manufacturer.



■ Returning to the factory-set codes

To return to the factory-set codes in all positions, follow these steps.

- 1 Press > (right) and < (left) at the same time for about four seconds.**

The indicator flashes twice.

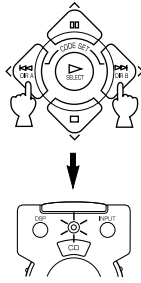

- 2 Enter the code number "9990".**

Make sure that the indicator flashes twice.

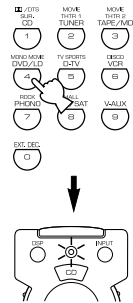

To return to the factory-set codes in each position, follow these steps.

- 1 Set the selector dial to the position for the component to be returned to the factory-set code.**

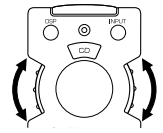

- 2 Press > (right) and < (left) at the same time for about four seconds.**

The indicator flashes twice.

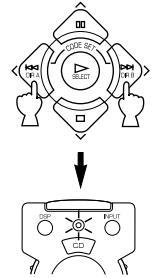

- 3 Enter the code number "0000".**

Make sure that the indicator flashes twice.

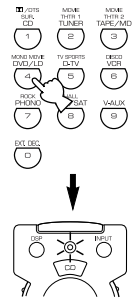

The following codes are factory set.

Selector dial position	Component	Code
TV	TV	0101
CBL/SAT	Satellite tuner	0006
VCR	VCR	0002
DVD/LD	DVD player	0008 (YAMAHA DVD player)
CD	CD player	0005 (YAMAHA CD player)
TAPE/MD	Tape deck	0004 (YAMAHA Tape deck)
AMP/TUN	this unit	0003
DSP/TUN	this unit	0013

We recommend that you write all the code numbers you have set on the "Quick Reference Card".



TROUBLESHOOTING

If the unit fails to operate normally, check the following points to determine whether the fault can be corrected by the simple measures suggested. If it cannot be corrected, or if the fault is not listed in the SYMPTOM column, disconnect the power cord and contact your authorized YAMAHA dealer or service center.

■ General

SYMPTOM	CAUSE	REMEDY	Refer to page
The unit fails to turn on when STANDBY/ON (or POWER) is pressed, or enters in the standby mode soon after the power has been turned on.	The power cord is not connected or the plug is not completely inserted.	Firmly connect the power cord.	18
	The IMPEDANCE SELECTOR switch on the rear panel is not fully set to the right or left position.	Set the switch fully to the right or left position when the unit is in the standby mode.	18
The unit does not work normally.	The internal microcomputer has been frozen by an external electric shock (lightning, excessive static electricity, etc.) or by a power supply with low voltage.	Set the unit in the standby mode and disconnect the AC power cord from the AC power outlet. After about 30 seconds have passed, connect the power and operate the unit again.	—
No sound and/or no picture.	Incorrect input or output cable connections.	Connect the cables properly. If the problem persists, the cables may be defective.	13, 14
	An appropriate input source has not been selected.	Select an appropriate input source with INPUT SELECTOR or TAPE/MD MON / EXT. DECODER (or the input selector buttons).	21
	The speaker connections are not secure.	Secure the connections.	16
	SPEAKERS have not been set properly.	Set SPEAKERS corresponding to the speakers in use to the ON position.	21
	The sound is muted.	Set VOLUME to the "∞" position, press MUTE to cancel a mute and adjust the volume.	22
	Digital signals other than PCM audio and the signals encoded with Dolby Digital or DTS which this unit cannot reproduce are being input to this unit by a CD-ROM, etc.	Play a source whose signals this unit can reproduce.	—
No picture.	There is no S VIDEO connection between this unit and the TV monitor, although S video signals are being input to this unit.	Connect the monitor's "S" video input terminal to this unit's S VIDEO MONITOR OUT terminal.	14
The sound suddenly goes off.	The protection circuit has been activated because of a short circuit, etc.	Set the unit in the standby mode and then turn on to reset the protection circuit.	—
	The SLEEP timer has functioned.	Turn on the power, and play the source again.	41
Only the speaker on one side can be heard.	Incorrect cable connections.	Connect the cables properly. If the problem persists, the cables may be defective.	16
	Incorrect setting of BALANCE.	Adjust it to the appropriate position.	22
No sound from the effect speakers.	The sound effect is off.	Press EFFECT to turn it on.	26
	A Dolby Surround, Dolby Digital or DTS decoding DSP program is being used with material not encoded with Dolby Surround, Dolby Digital or DTS.	Select another DSP program.	34
	The 96-kHz sampling 24-bit digital signals are input to this unit.		24

SYMPTOM	CAUSE	REMEDY	Refer to page
No sound from the center speaker.	The sound output level of the center speaker is set to minimum.	Raise the level of the center speaker.	39
	“CENTER SP” on the SET MENU is set to the NONE position.	Select the LRG or SML position.	36
	Incorrect DSP program is selected.	Select the appropriate program.	32, 33, 34
	The source encoded with Dolby Digital or DTS does not have a center channel signal.		—
No sound from the rear speakers.	The output level of the rear speakers is set to minimum.	Raise the output level of the rear speakers.	39
	A monaural source is being played with the PRO LOGIC/Normal or PRO LOGIC/ENHANCED program.	Select another DSP program suitable for the monaural source.	34
No sound from the subwoofer.	“BASS OUT” on the SET MENU is set to the SW or MAIN position when playing a 2-channel source.	Select the BOTH position.	36
	The source does not contain low bass signals (below 90 Hz).		—
A “humming” sound can be heard.	Incorrect cable connections.	Firmly connect the audio plugs. If the problem persists, the cables may be defective.	13, 14
	No connection from the turntable to the GND terminal.	Make the GND connection between the turntable and this unit.	13
The volume level is low while playing a record.	The record is being played on a turntable with an MC cartridge.	The turntable should be connected to the unit through the MC head amplifier.	13
The volume level cannot be increased, or the sound is distorted.	The component connected to the TAPE/MD OUT (REC) terminals of this unit is in the standby mode.	Turn on the power to the component.	—
The sound effect cannot be recorded.	It is not possible to record the sound effect by a tape deck or MD recorder connected to the TAPE/MD OUT (REC) terminals of this unit.		31
The DVD/LD, TV/digital TV or cable TV/satellite tuner source cannot be recorded by a tape deck, MD recorder or VCR connected to this unit.	The DVD/LD player, TV/digital TV or cable TV/satellite tuner is connected to the unit only through the digital terminals.	Make additional connections between the analog terminals.	14
Adjusting this unit by using SET MENU, TIME/LEVEL or TEST cannot be performed.	“MEM. GUARD” on the SET MENU is set to the ON position.	Set “MEM. GUARD” to the OFF position.	38

■ Tuner

	SYMPTOM	CAUSE	REMEDY	Refer to page
FM	FM stereo reception is noisy.	The characteristics of FM stereo broadcasts may cause this problem when the transmitter is too far away or the antenna input is poor.	Check the antenna connections. Try using a high-quality directional FM antenna. Use the manual tuning method.	11, 27
	There is distortion, and clear reception cannot be obtained even with a good FM antenna.	There is multipath interference.	Adjust the antenna position to eliminate multipath interference.	11
	The desired station cannot be tuned in with the automatic tuning method.	The station is too weak.	Use the manual tuning method. Use a high-quality directional FM antenna.	11, 27
	Previously preset stations can no longer be tuned in.	The unit has been disconnected for a long period.	Re-store the stations.	28
AM	The desired station cannot be tuned in with the automatic tuning method.	The signal is weak or the antenna connections are loose.	Tighten the AM loop antenna connections and orient it for best reception. Use the manual tuning method.	12, 27
	There are continuous crackling and hissing noises.	Noises result from lightning, fluorescent lamps, motors, thermostats and other electrical equipment.	Use an outdoor antenna and a ground wire. This will help somewhat, but it is difficult to eliminate all noise.	12
	There are buzzing and whining noises (especially in the evening).	A TV set is being used nearby.	Move this unit away from the TV.	—

■ Remote control

	SYMPTOM	CAUSE	REMEDY	Refer to page
	The remote control does not work.	Direct sunlight or lighting (from an inverter type of fluorescent lamp, etc.) is striking the remote control sensor of this unit.	Reposition the unit.	3
		The batteries are weak.	Replace all batteries with new ones.	2
	The unit or other component cannot be controlled.	The component to be controlled has not been selected.	Set the selector dial to the appropriate position, corresponding to the component to be controlled.	42
		The remote control cannot control system components.		—
		The manufacturer's code has not been set properly.	Enter the code again.	48
			Try setting another code for the same manufacturer.	
Depending on the manufacturer or the model, some components cannot be controlled with this unit's remote control even though the code has been set properly.	Use the original remote control supplied with your component.	—		

■ Others

	SYMPTOM	CAUSE	REMEDY	Refer to page
	The sound is degraded when listening with headphones to a tape deck or CD player connected to this unit.	This unit is in the standby mode.	Turn on the power of the unit.	—
	There is noise interference from digital or high-frequency equipment, or the unit.	The unit is too close to the digital or high-frequency equipment.	Move the unit further away from such equipment.	—

■ When playing back a source encoded with DTS

SYMPTOM	CAUSE	REMEDY	Refer to page
A loud hissing noise is heard when playing back a source encoded with DTS.	The player which plays back the source is not connected to a digital audio signal input terminal of this unit.	The player must be connected to a digital audio signal input terminal of this unit besides the analog audio signal terminal connections.	14
	The input mode is set to ANALOG on this unit.	Set a proper input mode to turn on the built-in DTS decoder.	23
A percussive noise is heard when playing back a source encoded with DTS.	If the input mode is set to AUTO, depending on some sources, there may be a noise heard while this unit is identifying the format of the input signal.	Set the input mode of the currently selected input source to DTS.	23
No sound is heard when playing back a source encoded with DTS, even if the input mode is set to AUTO on this unit.	The built-in DTS decoder does not function because the player has a digital volume control and it is set at a position other than "maximum," "neutral" or "ineffective."	Set the player's digital volume control at the maximum, neutral or ineffective position.	—
No sound is heard when playing back an MD or DAT on which has been recorded a source encoded with DTS.	A source encoded with DTS cannot be recorded on an MD or DAT.		—
No sound is heard when playing back a source (CD, etc.) even if the currently selected input mode is AUTO.	In the AUTO mode, the DTS-decoding mode cannot be automatically changed to the normal (PCM) digital signal input mode.	Set the input mode to AUTO again.	24

Notes

- It is necessary to use a DTS decoder to play back a source encoded with DTS, so the player which plays back the source must be connected to a digital audio input terminal of this unit in the way described in this manual. If this connection is not made or only a D-to-A converter is being used without using a DTS decoder, only a loud hissing noise will be heard when you play back the source.
- The "**dts**" indicator will flash when the input mode is set to AUTO and a search or skip operation is performed while playing back a source encoded with DTS. If this status continues for 30 or more seconds, the unit will automatically switch from DTS-decoding mode to PCM digital signal input mode and the "**dts**" indicator will go out.



SPECIFICATIONS

AUDIO SECTION

- Minimum RMS Output Power
20 Hz to 20 kHz, 0.06% THD, 8 ohms
Main L/R, Center, Rear L/R 100 W*/70 W
1 kHz, 0.09% THD, 8 ohms
Main L/R, Center, Rear L/R 110 W*/80 W
- Maximum Output Power (EIAJ)
1 kHz, 10% THD, 8 ohms 105 W
- DIN Standard Output Power
1 kHz, 0.7% THD, 4 ohms 110 W
- IEC Output Power
1 kHz, 0.06% THD, 8 ohms 75 W
- Dynamic Power (IHF)
8/6/4/2 ohms 130/150/190/240 W*, 90/110/135/160 W
- Damping Factor
20 Hz to 20 kHz, 8 ohms 80
- Frequency Response
CD etc. to MAIN L/R 10 Hz to 100 kHz, -3 dB
- Total Harmonic Distortion (20 Hz to 20 kHz)
CD etc. to MAIN L/R, 1/2 power, 8 ohms 0.06%
- Signal-to-Noise Ratio (IHF-A Network)
CD etc. to MAIN L/R
(150 mV, Input Shorted) 99 dB
- Residual Noise (IHF-A Network)
MAIN L/R 150 μ V
- Input Sensitivity/Impedance
CD etc. 150 mV/47 k-ohms
EXT. DECODER 150 mV/40 - 47 k-ohms
- Output Level/Impedance
REC OUT 150 mV/1.2 k-ohms
PRE OUT 2.1 V/1.2 k-ohms
SUBWOOFER 4.0 V/1.2 k-ohms
PHONES 0.34 V/560 ohms
- Channel Separation (Vol. -30 dB)
CD etc. (Input 5.1 k-ohms Terminated, 1 kHz/10 kHz)
..... 60 dB/45 dB
- Tone Control Characteristics
BASS: Boost/cut \pm 10 dB/50 Hz
TREBLE: Boost/cut \pm 10 dB/20 kHz

* for U.S.A. and Canada models

VIDEO SECTION

- Video Signal Type NTSC or PAL
- Video Signal Level 1 Vp-p/75 ohms
- Signal-to-Noise Ratio 50 dB
- Monitor Out Frequency Response 5 Hz to 10 MHz, -3 dB

FM SECTION

- Tuning Range 87.5/87.50 to 107.9/108.00 MHz
- Usable Sensitivity (DIN)
Mono (S/N 26 dB) 0.9 μ V
Stereo (S/N 46 dB) 28 μ V
- Selectivity (two signals, 40 kHz Dev., \pm 300 kHz) 55 dB
- Signal-to-Noise Ratio (Mono/Stereo)
DIN 75 dB/69 dB
IHF 81 dB/75 dB
- Harmonic Distortion (1 kHz)
Mono/Stereo 0.1/0.2%
- Stereo Separation (1 kHz) 48 dB
- Frequency Response 20 Hz to 15 kHz, \pm 1 dB
- Antenna Input 75 ohms, Unbalanced

AM SECTION

- Tuning Range 530/531 to 1,710/1,611 kHz
- Usable Sensitivity 300 μ V/m
- Signal-to-Noise Ratio 52 dB
- Antenna Loop antenna

GENERAL

- Power Supply
[U.S.A. and Canada models] AC 120 V, 60 Hz
[Europe, U.K. and Singapore models] AC 230 V, 50 Hz
[Australia model] AC 240 V, 50 Hz
[China model] AC 220 V, 50 Hz
[General model] AC 110/120/220/240 V, 50/60 Hz
- Power Consumption approx. 310 W
- Power Consumption (standby mode) approx. 1 W
- AC Outlets (100 W max. total)
[U.K. and Australia models] 1 (SWITCHED)
[Other models] 2 (SWITCHED)
- Dimensions (W x H x D)
..... 435 x 151 x 391 mm (17-1/8" x 5-15/16" x 15-3/8")
- Weight 11.2 kg (25 lbs.)
- Accessories AM loop antenna
..... Indoor FM antenna
..... 75-ohm/300-ohm antenna adapter (U.K. model only)
..... Antenna adapter (U.S.A. and Canada models only)
..... Remote control
..... Batteries

Specifications are subject to change without notice.



GLOSSARY

■ Dolby Surround

Dolby Surround uses four discrete channels and five speakers to reproduce realistic and dynamic sound effects: two main channels (left and right), a center channel for dialog, and a rear channel for special sound effects. The rear channel reproduces sound within a narrow frequency range. Most video tapes and laser discs include Dolby Surround encoding, as do many TV and cable broadcasts. The Dolby Pro Logic decoder built into this unit employs a digital signal processing system that stabilizes each channel for even more accurate sound positioning than is available with standard analog processors.

■ Dolby Digital

Dolby Digital is a digital surround sound system that provides completely independent multi-channel audio to you. Dolby Digital provides five full-range channels in what is sometimes referred to as a “3/2” configuration: three front channels (left, center and right), and two surround channels. A sixth bass-only effect channel is also provided for output of LFE (low frequency effect), or low bass effects that are independent of other channels. (This is called the “LFE channel”.) This channel is counted as 0.1, thus giving rise to the term 5.1 channels in total.

The wide dynamic range of sound reproduced by the five full-range channels and precise sound orientation by digital sound processing provides listeners with excitement and realism that have never been experienced before.

■ DTS (Digital Theater System) Digital Surround

DTS was developed to replace the analog soundtracks of movies with six discrete channels of digital soundtracks, and it is now installed in many theaters around the world. The DTS digital playback system changed the way we experienced movies in theaters with six discrete channels of superb digital audio.

DTS technology, through intense research and development has made it possible to deliver similar encode/decode discrete technology to home audio surround-sound entertainment.

DTS Digital Surround is an encode/decode system which delivers six channels of master-quality, 20-bit audio; technically, it is 5.1 channels, which means 5 full-range (left, center, right and two surround) channels, plus a subwoofer (LFE) channel (as “0.1”). It is compatible with the 5.1 speaker configurations that are currently available for home theater systems.

■ CINEMA DSP CINEMA DSP

The Dolby Surround and Dolby Digital sound and DTS systems show their full ability in a large movie theater, because movie sounds are originally designed to be reproduced in a large movie theater that uses a multitude of speakers. Trying to create a sound environment similar to that of a movie theater in your home is difficult because of the room size, material inside the walls, the number of speakers, and so on. In other words, your listening room is very different from a movie theater.

However, YAMAHA DSP technology allows you to create nearly the same sound experience as that of a large movie theater in your home by compensating for the lack of presence and dynamics in the listening room with original digital sound fields combined with Dolby Surround, Dolby Digital or DTS Digital Surround sounds.

The YAMAHA “CINEMA DSP” logo indicates those programs that are created by the combination of YAMAHA DSP technology and Dolby Surround, Dolby Digital or DTS.

■ LFE 0.1 Channel

This channel is for reproduction of low bass signals. The frequency range for this channel is 20 Hz to 120 Hz. This channel is called the channel 0.1 because it only reproduces a low frequency range compared to the full-range from 20 Hz to 20 kHz that is reproduced by the 5 channels in a Dolby Digital or DTS 5.1 channel system.

■ S VIDEO Signal

The S VIDEO signal is separated and transmitted as the Y signal which indicates the luminance and the C signal which indicates the chroma of the video signal (composite signal). Using the S VIDEO terminal eliminates video signal transmission loss and allows recording and playback of even more beautiful images.



INDEX

A		
Accessories	2	
AC outlet	18	
Antennas	11, 12	
B		
BALANCE	22	
BGV (background video) function	22	
C		
Canceling sound effect	26	
CINEMA DSP	34, 55	
Connections		
Antennas	11, 12	
Audio components (tape deck/MD recorder, CD player and turntable)	13	
Digital connections	14	
Speakers	16	
TV monitor	14	
Video components (DVD/LD player, VCR, TV/digital TV and cable TV/satellite tuner)	14	
D		
Delay time (TIME/LEVEL mode)	39	
Display	6	
Dolby Digital	55	
Dolby Surround	55	
DSP program	25, 32 to 34	
DTS Digital Surround	55	
E		
External decoder	15	
F		
Front panel	4	
I		
IMPEDANCE SELECTOR switch	18	
Input mode	23	
L		
LFE	37, 38, 55	
M		
Muting	22	
P		
Playing	21	
Preset stations		
To recall a preset station	29	
Exchanging preset stations	30	
Preset tuning		
Automatic preset tuning	28	
Manual preset tuning	29	
R		
Recording	31	
Remote control		
Basic operations	7, 8	
Batteries	2	
Factory-set code	49	
Manufacturer's codes	i (at the end of this manual)	
Selector dial	7, 42	
Setup codes	48	
S		
SET MENU	35	
Sleep timer	41	
Speaker		
Output levels (TIME/LEVEL mode)	39	
Output mode (SET MENU)	36, 37	
Speaker balance (test tone)	19	
Placement	9	
STANDBY/ON	4	
T		
Test tone	19, 20	
Tone controls	22	
Tuning		
Automatic tuning	27	
Manual tuning	27	

LIST OF MANUFACTURER'S CODES

LISTES DES CODES FABRICANT

TV	ELECTRON	0941	JINXING	1531, 1541, 1551,	PANASONIC	0101, 0191, 0251,
A-MARK	ELIN	1001		1561, 1571, 1621,		0751, 1041, 1311,
A TANDY	ELTA	0331		1631, 1641, 1651,		1371, 1431
ABEX	EMERSON	0001, 0021, 0061,		1691, 1731	PANDA	1541, 1721
ADMIRA		0071, 0081, 0091,	JVC	0261, 0281, 0641,	PENNY	0161, 0361, 0521,
ADVENTURA		0111, 0811, 0821,		0651, 0661, 0841		0531, 0621, 0731,
AIKO		0831, 0841, 0851,	KAWASHO	0901		0751, 0761, 0781,
AIWA		0861, 0871, 0901,	KAYPANI	1021		0791, 0861, 0931,
AKAI		0921, 0941, 0981,	KENWOOD	0361, 1031, 1111		0941, 1031, 1041,
ALBA		1011, 1031, 1051,	KLOSS	0631, 0721, 1131		1111, 1151, 1161
ALLERON		1081, 1091	KTV	0921, 0941, 1011,	PEONY	1561, 1621
AMBASSADOR	ENVISION	0361, 1111		1051, 1111	PHILCO	0361, 0581, 0591,
AMSTRAD	ERRES	1001	LEYCO	1001		0601, 0611, 0631,
ANAM	ETRON	0331	LIESENK & TTER	1001		0961, 1031, 1111
	FERGUSON	1001	LLOYTRON	0941	PHILIPS	0101, 0401, 1001
ANAM NATIONAL	FINLUX	1001	LOEWE	1001	PHONOLA	1001
AOC	FISHER	0171, 0801, 0981	LOGIK	0991, 1771	PILOT	0941, 1031, 1111
	FORMENTI	0441	LUXMAN	0351, 0971	PIONEER	0511, 0551, 0871,
	FORMONTI	1001	LXI	0101, 0621, 0761,		1331
ARCHER	FORTRESS	1141		0861, 0981	PORTLAND	0941, 1031, 1121
AUDIOSONIC	FUJITSU	1091	MAGNAVOX	0101, 0341, 0391,	PRICECLUB	0931
AUDIOVOX	FUNAI	1051, 1091, 1341,		0401, 0411, 0421,	PRISM	0751
BAUER		1361, 1411, 1451,		0581, 0591, 0601,	PROSCAN	0761
BAUR		1501, 1521		0611, 0631, 0661,	PROTECH	1001
BEIJING	FUTURETECH	1051		0961, 1111	PROTON	0501, 0861, 0941,
BELCOR	GE	0131, 0161, 0201,	MAJESTIC	0991		1021, 1161
BELL & HOWELL		0751, 0761, 0771,	MARANTZ	0101, 0221, 0361,	PULSAR	0891
BEON		0781, 0791, 0811,		1001, 1111	PULSER	1031
BRADFORD		0861, 1041	MARK	1001	QUASAR	0251, 0751, 1041
BROCKWOOD	GEC	0271, 1001	MATSUI	0271, 0331, 1001	QUELLE	1001
BROKSONIC	GEMINI	0391	MEDIATOR	1001	RADIO SHACK	0541, 0941,
BUSH	GENEXXA	0431	MEGATRON	0691, 0861, 1161		1031, 1051,
CANDLE	GIBRALTER	0891, 1031, 1111	MEI	1011		1151
	GOLDSTAR	0031, 0121, 0351,	M-ELECTRONIC	1001	RADIOLA	1001
CAPEHART		0411, 0731, 0741,	MEMOREX	0331, 0571, 0861,	RCA	0051, 0141, 0151,
CARVER		0861, 0941, 0971,		0971, 0981, 0991,		0181, 0411, 0491,
CATHAY		1001, 1031, 1111,		1771		0531, 0761, 0771,
CELEBRITY		1151	METZ	1791, 1831, 1891,		0871, 1031
CENTURION	GOODMANS/TASHIKO	0271, 0661, 1001		1901, 1911, 1921,	REALISTIC	0541, 0861, 0941,
CHANGHONG				1931, 1941		0971, 0981, 1031,
	GRANADA	1001	MGA	0361, 0561, 0571,		1051, 1111, 1151
CITIZEN	GRUNDIG	1781, 1791, 1801,		0861, 1031, 1111	RHAPSODY	1011
		1811, 1821, 1831,	MIDLAND	0751, 0761, 0891,	R-LINE	1001
		1841, 1851, 1861,		0941, 1151	RUNCO	0891, 1111
		1871, 1881	MITSUBISHI	0221, 0321, 0561,	SAISHO	0331, 1081
CLAIRTONE	GUNPY	1051, 1091		0571, 0661, 0861,	SAMPO	0361, 0941, 1021,
CLARIVOX	H/K	0721		1031, 1101, 1381		1111, 1151
CONCERTO	HALLMARK	0861	MONTGOMERY	1091	SAMSUNG	0331, 0341, 0351,
CONROWA	HANSEATIC	1001	MOTOROLA	1041, 1141		0361, 0861, 0931,
CONTEC	HARVARD	1051, 1061	MTC	0351, 0361, 0881,		0941, 0971, 1001,
	HINARI	1001, 1091		0931, 0971, 1011,		1031, 1111, 1151,
CORANDO	HITACHI	0181, 0351, 0671,		1031, 1111		1461
CRAIG		0681, 0691, 0701,	MULTITECH	0881, 1051	SAMSUX	0941
CROWN		0711, 0871, 0941,	NAD	0551, 0621, 0861	SANYO	0171, 0231, 0271,
CURTIS MATHES		0971, 1351	NEC	0241, 0351, 0361,		0661, 0801, 0911,
	HYPSON	1001		0661, 0971, 1031,		0981, 1231, 1251,
	IMA	1051		1111, 1321, 1711		1261
CXC	INDIANA	1001	NECKERMANN	1001	SBR	1001
DAEWOO	INFINITY REFERENCE	0101	NEI	1001	SCHEIDER	1001
			NIKKAI	0271, 0431, 1001,	SCIMITSU	1031
	INTERFUNK	1001		1151	SCOTCH	0861
	IMA	1051	NIKKO	0861, 1111, 1121	SCOTT	0831, 0861, 0941,
DANSAI	INDIANA	1001	NOVABEAM	0721		1031, 1051, 1091
DAYTRON	INFINITY REFERENCE	0101	NTC	1121	SEARS	0101, 0161, 0171,
DECCA			ONWA	1051		0351, 0481, 0521,
DIXI	INTERFUNK	1001	OPTIMUS	0551		0621, 0761, 0801,
DUMONT	ITT	0611	OPTONICA	0541, 1141		0861, 0971, 0981,
DYNATECH	JANEIL	1131	ORION	0831, 1001		1091
	JBL	0101	OSAKI	0271, 1151	SHANGHAI	1561, 1681
ELECTROBAND	JCB	0951	OTTO VERSAND	1001		
ELECTROHOME	JENSEN	0311				

SHARP 0461, 0471, 0541, 0661, 0911, 0941, 1141, 1241, 1271

SHOGUN 1031

SIGNATURE 0991, 1771

SIMPSON 0581, 0961

SOLAVOX 1151

SONOKO 1001

SONTEC 1001

SONY 0371, 0451, 0661, 0841, 0951, 1281, 1441

SOUNDESIGN 0861, 0961, 1051, 1091

SOUNDWAVE 1001

SPECTRICON 1161

SQUAREVIEW 0481

SSS 1031, 1051

STAR-LITE 1051

SUPREM 0951

SUPRE-MACY 1131

SURPA 0351, 0971

SYLVANIA 0101, 0361, 0441, 0581, 0591, 0601, 0611, 0631, 0961, 1111

SYMPHONIC 0481

SYSLINE 1001

TANDY 0271, 0431, 1141

TATUNG 0271, 0881, 1001, 1041, 1161

TCL 1561, 1631, 1701

TECHNICS 0751

TECHWOOD 0351, 0751, 0971

TEKNIKA 0101, 0351, 0571, 0931, 0941, 0961, 0971, 0991, 1031, 1051, 1091, 1121, 1131, 1771

TELETECH 0331

TERA 0501

THAKRAL 1671

THORM 1001

TMK 0351, 0861, 0971, 1081

TOSHIBA 0381, 0521, 0621, 0661, 0931, 0981, 1301

TOSONIC 1011

TOTEVISION 0941

TRICAL 0911

UNIVERSAL 0781, 0791

UNIVERSUM 1001

VECTOR RESEARCH 0361, 1111

VESTEL 1001

VICTOR 0641, 0651, 1201, 1211, 1221

VIDEO CONCEPT 1101

VIDIKRON 0101, 0211

VIDTECH 0861, 1031

VIKING 1131

WARDS 0101, 0361, 0451, 0541, 0581, 0591, 0601, 0611, 0771, 0781, 0791, 0861, 0971, 0991, 1031, 1091, 1111, 1771

WATSON 1001

XOGEKO 1611, 1621, 1661, 1741, 1761

YAMAHA 0221, 0361, 0571, 1031, 1111, 1141, 1381

YOKO 1001

ZENITH 0011, 0041, 0891, 0991, 1771

ZONDA 1161

CABLE TV

ABC 0256, 0376

ANTRONIX 0136

ARCHER 0136, 0286

BBT 0076

CABLETIME 0166

CABLEVISION 0196

COLOUR VOICE 0306, 0346

COMTRONICS 0216, 0276

EAGLE COMTRONICS 0276

EASTERN 0066

ELECTRICORD 0206

ELECTUS 0266

GE 0116, 0126

GEC CABLE SYSTEM 0196

HAMLIN H5 0676

HAMLIN H6 0666

HAMLIN H6S 0656

HAMLIN H8 0646

HAMLIN H9 0636

JERROLD 0256

JERROLD 400L 0626

JERROLD 450L 0616

JERROLD 550 0606

JERROLD OSD CATV 0596

JERROLD SPRUCER 0436

MAGNAVOX/PHILIPS 0416, 0426

MAMM 0296

MEMOREX 0386

MOVIE TIME 0146, 0206

NORTHCOAST 0016

NSC 0146

OAK 0106

OAK SIGMA 450 0546

OAK SIGMA 550 0536

PANASONIC TZ 120/130 0476

PANASONIC TZ 170/180 0446

PANASONIC TZ140 0466

PANASONIC TZ150/160 0456

PARAGON 0386

PHILIPS 0036, 0216, 0306, 0316, 0326, 0336, 0346

PIONEER 0006, 0086

PIONEER BR500846

PIONEER BR60/70/80/81/82 0696

PIONEER BR90 0556

PULSAR 0386

RCA DIGITAL SATELLITE SYSTEM 0396, 0406

REALISTIC 0136

REGENCY/EASTERN 0686

RUNCO 0386

SAMSUNG 0276

SCIENTIFIC ATLANTA 175/475 0576

SCIENTIFIC ATLANTA 75 0366, 0586

SCIENTIFIC ATLANTA 8650 0566

SIGNAL 0276

SL MARX 0276

SPECTAVISION 0236

STANDARD COMPONENTS 0186

STARCOM V 0256

STARGATE 0276

SYLVANIA/TEXSCAN

0376, 0496

TEKNIKA 0176

TELESERVICE 0056

TELEVIEW 0276

TEXSCAN 0186, 0376

TFC 0026

TOCOM 0226, 0356

TOCOM 5503A 0526

TOCOM 5503VIP/5507 0516

TOCOM TC56 0506

TOSHIBA 0386

TUDI 0046

UNIKA 0136

UNIVERSAL 0136, 0156, 0206, 0286

VIDEOWAY 0096

VIEWSTAR 0216

ZENITH 0246, 0386, 0486

SATELLITE TUNER

ALPHA STAR 0826

CHAPARRAL 0756

ECHOSTAR 0836

GENERAL INSTRUMENT 0776, 0876

HTS 0836

HUGHES NETWORK SYSTEMS 0816

JERROLD 0776, 0786

PANASONIC 0806

PRIMESTAR 0776, 0786

RCA 0766

SONY 0796

(DSS)

HITACHI 0856

MAGNAVOX 0886

MEMOREX 0886

PHILIPS 0886

STAR CHOICE 0876

TOSHIBA 0866

UNIDEN 0886

VCR

A TANDY 0902

ADVENTURA 0992

AIKO 0982

AIWA 0992

AKAI 0262, 0942, 0952, 0962, 0972

AMERICAN HIGH 0932

AMSTRAD 0992

ASA 0002, 0912

ASHA 0922

AUDIO DYNAMICS 0202

AUDIOVOX 0912

BEAUMARK 0922

BELL & HOWELL 0902

BLAUPUNKT 0412

BROKSONIC 0872, 0882, 0892

BUSH 0852

CALIX 0912

CANON 0862, 0932

CCE 0852, 0982

CITIZEN 0912, 0982

COLT 0852

CRAIG 0832, 0842, 0852, 0912, 0922

CURTIS MATHES 0662, 0822, 0932

CYBERNEX 0922

DAEWOO 0802, 0812, 0982

DBX 0202

DYNATECH 0472, 0992

ELECTROHOME 0912

ELECTROPHONIC 0912

EMEREX 0792

EMERSON 0072, 0132, 0142, 0152, 0162, 0172, 0182, 0192, 0212, 0702, 0712, 0722, 0732, 0742, 0752, 0762, 0772, 0782, 0872, 0882, 0892, 0912, 0952, 0992, 1072

FINLUX 0002, 0992

FISHER 0682, 0692, 0842, 0902

FUJI 0672, 0932

FUNAI 0992

GARRARD 0992

GE 0662, 0822, 0932

GO VIDEO 0642, 0652

GOLDSTAR 0082, 0632, 0912

GOODMANS 0402

GRADIENTE 0992

GRANDA 0612, 0902

GRUNDIG 0002

H/K 1082

HARLEY DAVIDSON 0992

HARMAN/KARDON 0632, 1082

HARWOOD 0752, 0852

HEADQUARTER 0612

HI-Q 0842

HINARI 0852

HITACHI 0102, 0562, 0572, 0582, 0592, 0602, 0992

ITT 0942

JVC 0202, 0522, 0532, 0542, 0552

KENWOOD 0202, 0542, 0612, 0632, 0902

KLH 0852

KODAK 0912, 0932

LLOYD 0992

LOGIK 0852

LUXOR 0942

LXI 0022, 0912

MAGNAVOX 0002, 0482, 0492, 0502, 0512, 0932

MAGNIN 0922

MARANTZ 0002, 0202, 0402, 0632, 0932

MARTA 0912

MATSUSHITA 0932

MATSUI 0722

MEI 0222, 0932

MEMOREX 0232, 0242, 0472, 0512, 0612, 0842, 0902, 0912, 0922, 0932, 0992

MGA 0762, 0952

MGA TECHNOLOGY 0922

MINOLTA 0592, 0602

MITSUBISHI 0452, 0462, 0542, 0762, 0952, 1082

MOTOROLA 0472, 0932

MTC 0922, 0992

MULTITECH 0852, 0992

NAD 0442

NEC 0122, 0202, 0292, 0422, 0432, 0542, 0632

NIKKO 0912

NOBLEX 0922

OLYMPUS 0412, 0932

OPTIMUS 0442, 0472, 0912

OPTONICA	0402	UNITECH	0922	CURTIS MATHS	0345	SONY	0065, 0565, 0865, 1145
ORION	0212, 0722, 0742, 0772	VECTOR RESEARCH	0202, 0432, 0632	DENON	0275, 0875, 0885	STARON	1235
OSAKI	0912	VICTOR	0202, 0532, 0552	DEUAL (E)	0505	STS	0025
PANASONIC	0012, 0052, 0092, 0222, 0372, 0382, 0392, 0412, 0932	VIDEO CONCEPTS	0202, 0432, 0632, 0952	DYNAMIC BASS (H)	0555	SYLVANIA	0215
PENNY	0202, 0432, 0602, 0632, 0692, 0912, 0922, 0932	WARDS	0322, 0402, 0472, 0482, 0602, 0712, 0842, 0852, 0922, 0932, 0992	EMERSON	0205, 0325, 1105	SYMPHONIC	0335
PENTAX	0592, 0602	YAMAHA	0202, 0632, 0762	EROICA	1275	TANDY	0305
PERDIO	0992	ZENITH	0042, 0362, 0512, 0672	FISHER	0095, 0555, 0925, 1005	TANGBERG	1195
PHILCO	0002, 0932			GARRARD	0365	TEAC	0235, 0335, 0385, 0525, 0795, 0835, 1355
PHILIPS	0002, 0282, 0402, 0492, 0932			GENEXXA	0305, 0325, 1105	TECHNICS	0055, 0605, 1095
PILOT	0912			GOLDSTAR	1135, 1225, 1265, 1335	TECHWOOD	1325
PIONEER	0442, 0542			H/K	0105, 0175, 0465, 0995	TELEFUNKEN (E)	0505
PROSCAN	1002, 1012, 1022, 1032, 1042, 1052, 1062	DVD PLAYER		HITACHI	0195, 0205, 0505, 0815	THOMSON (E)	0505
PULSAR	0512	AKAI	0108	INTEL	0115, 0395	TOSHIBA	0035, 0685
QUARTER	0612	KENWOOD	0288	JVC	0315	VECTOR RESEARCH	0065, 1135
QUARTZ	0272, 0612	MAGNAVOX	0248	KENWOOD	0045, 0095, 0405, 0585, 0725, 0735, 0745, 0755, 0895	VICTOR	0315
QUASAR	0382, 0392, 0932	MITSUBISHI	0268	KYOCERA	0025	WARDS	0175
RADIO SHACK	0912, 0992	ONKYO	0128, 0248	LUXMAN	0075, 0425, 0675, 0705, 0715, 0985	YAMAHA	0005, 0015, 1065
RADIX	0912	PANASONIC	0048	MAGNAVOX	0165, 0215, 0645, 0955		
RANDEX	0912	PHILIPS	0188, 0248	MARANTZ	0215, 0235, 0375, 0785, 1345	MD RECORDER	
RCA	0112, 0382, 0392, 0482, 0592, 0602, 0662, 0822, 0942	PIONEER	0208, 0228	MCINTOSH	0355, 1085	YAMAHA	0024, 0394
REALISTIC	0402, 0472, 0612, 0682, 0842, 0902, 0912, 0922, 0932, 0992	PROSCAN	0308	MCS	0905, 1315	KENWOOD	0384
RICOH	0352, 0362	RCA	0308	MEMOREX	0205, 0225, 0235, 0305, 0325, 1105	SONY	0394
SAISHO	0212, 0582, 0722, 0732, 0742, 0772	SAMSUNG	0148	MGA	0135	TAPE DECK	
SALORA	0612, 0762	SHARP	0068	MISSION	0215	AIWA	0094, 0214, 0224
SAMSUNG	0212, 0312, 0922, 0962	SONY	0028	MITSUBISHI	0135, 0445	AKAI	0184
SANKY	0472, 0512	TECHNICS	0048	MTC	1255	CARVER	0094
SANSUI	0292, 0542, 0832	THOMSON	0328	NAD	0035, 0615, 0685, 0695	DENON	0304
SANYO	0242, 0612, 0842, 0902, 0922	TOSHIBA	0088, 0248	NAKAMICHI	0125, 0435, 0515	FISHER	0144
SBR	0002, 0282	VICTOR	0168, 0348	NEC	0255, 0905, 0965	GARRARD	0194, 0204
SCHEIDER	0852	YAMAHA	0008, 0048	NIKKO	0545, 1005	JVC	0274, 0284, 0294
SCOTT	0342, 0712, 0762, 0872, 0882, 0892	ZENITH	0248	ONKYO	0155, 0455, 0495, 0805, 1155	KENWOOD	0124, 0134, 0154, 0234, 0244, 0264
SEARS	0302, 0592, 0602, 0612, 0682, 0692, 0842, 0902, 0912, 0932			OPTIMUS	0225, 0245, 0555, 0595, 0845, 0855, 0865, 0895, 0935	MAGNAVOX	0094
SHARP	0402, 0472	LD PLAYER		PANASONIC	0055, 0825, 1095, 1125	MARANTZ	0094, 0344
SHINTOM	0852	AIWA	0157	PENNY	0905	MITSUBISHI	0184
SHOGUN	0922	DENON	0147	PHILIPS	0165, 0215	OPTIMUS	0034, 0064, 0204, 0334
SINGER	0852	DISCO VISION	0017	PIONEER	0305, 0935, 1045	ONKYO	0364, 0374
SONY	0032, 0332, 0352, 0362, 0672, 0792, 0932	FUNAI	0157	PROTON	0215, 1185	PHILIPS	0094
STS	0602	HITACHI (E)	0017	QUASAR	0055	PIONEER	0034, 0044, 0064
SUNPAK	0352	KENWOOD	0087, 0107	RCA	0205, 0915, 1115	REVOX	0354
SYLVANIA	0002, 0492, 0502, 0762, 0932, 0992	MAGNAVOX	0027	REALISTIC	0205, 0225, 0235, 0325, 0555, 0845	SANSUI	0094, 0344
SYMPHONIC	0992	MARANTZ	0027	REVOK	1175	SHARP	0264
TANDY	0992	MITSUBISHI	0137	ROTEL	0215	SHERWOOD	0334
TASHIKO	0712, 0992	NAD	0137	SABA TELECOMMANDER (E)	0505	SONY	0054, 0084, 0324
TEAC	0992	PANASONIC	0077, 0177	SAE	0215	TEAC	0194, 0254
TECHNICS	0932	PHILIPS	0027	SAMSUNG	1285	TECHNICS	0074, 0314
TEKNIKA	0322, 0912, 0932, 0992	PIONEER	0017, 0037, 0137	SANSUI	0215, 0625, 0975, 1025, 1105	VICTOR	0294
TELEFUNKEN	0252	RCA	0167	SANYO	0145, 0555, 0635, 0765	WARDS	0034
TMK	0212, 0732, 0772, 0922	REALISTIC	0157	SCOTT	0325, 1105	YAMAHA	0004, 0014
TOSHIBA	0062, 0302, 0342, 0622, 0682, 0712, 0762	SHARP	0127	SEARS	0345		
TOTEVISION	0912, 0922	SONY	0047, 0057, 0117	SHARP	0235, 0665, 0895, 1065, 1075		
		VICTOR	0097	SHERWOOD	0115, 0235, 0395, 0475		
		YAMAHA	0007	SIEMENS GARRARD	1245		
				SIGNATURE	0175		
				SONTEC	1165		



YAMAHA ELECTRONICS CORPORATION, USA 6660 ORANGETHORPE AVE., BUENA PARK, CALIF. 90620, U.S.A.
YAMAHA CANADA MUSIC LTD. 135 MILNER AVE., SCARBOROUGH, ONTARIO M1S 3R1, CANADA
YAMAHA ELECTRONIK EUROPA G.m.b.H. SIEMENSSTR. 22-34, 25462 RELLINGEN BEI HAMBURG, F.R. OF GERMANY
YAMAHA ELECTRONIQUE FRANCE S.A. RUE AMBROISE CROIZAT BP70 CROISSY-BEAUBOURG 77312 MARNE-LA-VALLEE CEDEX02, FRANCE
YAMAHA ELECTRONICS (UK) LTD. YAMAHA HOUSE, 200 RICKMANSWORTH ROAD WATFORD, HERTS WD1 7JS, ENGLAND
YAMAHA SCANDINAVIA A.B. J A WETTERGRENS GATA 1, BOX 30053, 400 43 VÄSTRA FRÖLUNDA, SWEDEN
YAMAHA MUSIC AUSTRALIA PTY, LTD. 17-33 MARKET ST., SOUTH MELBOURNE, 3205 VIC., AUSTRALIA

YAMAHA CORPORATION
Printed in Malaysia ID V471950

Quick Reference Card

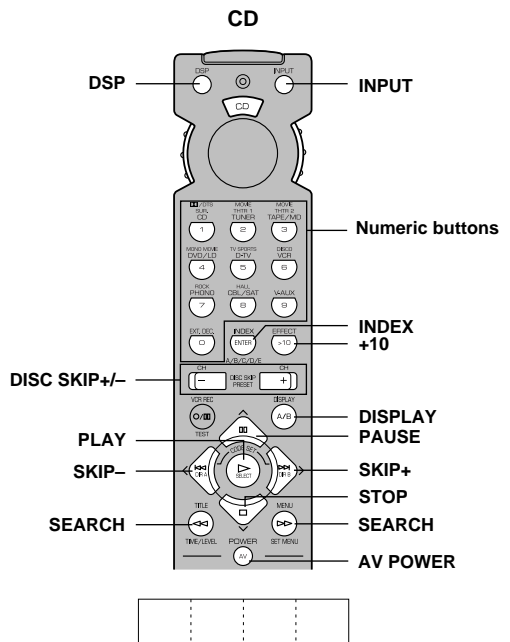
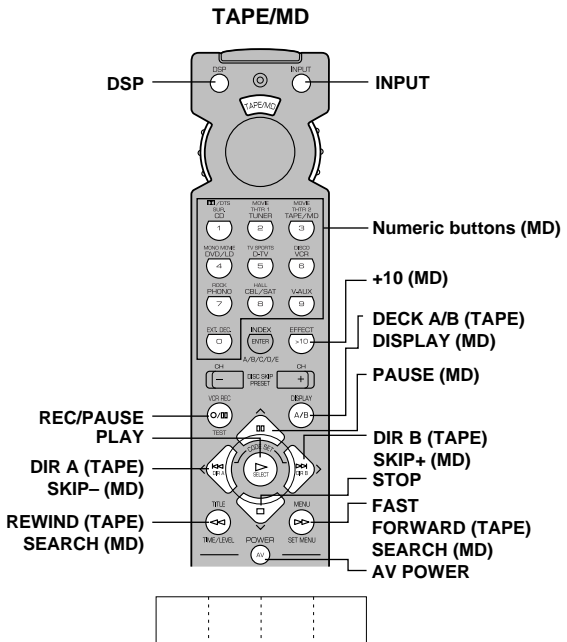
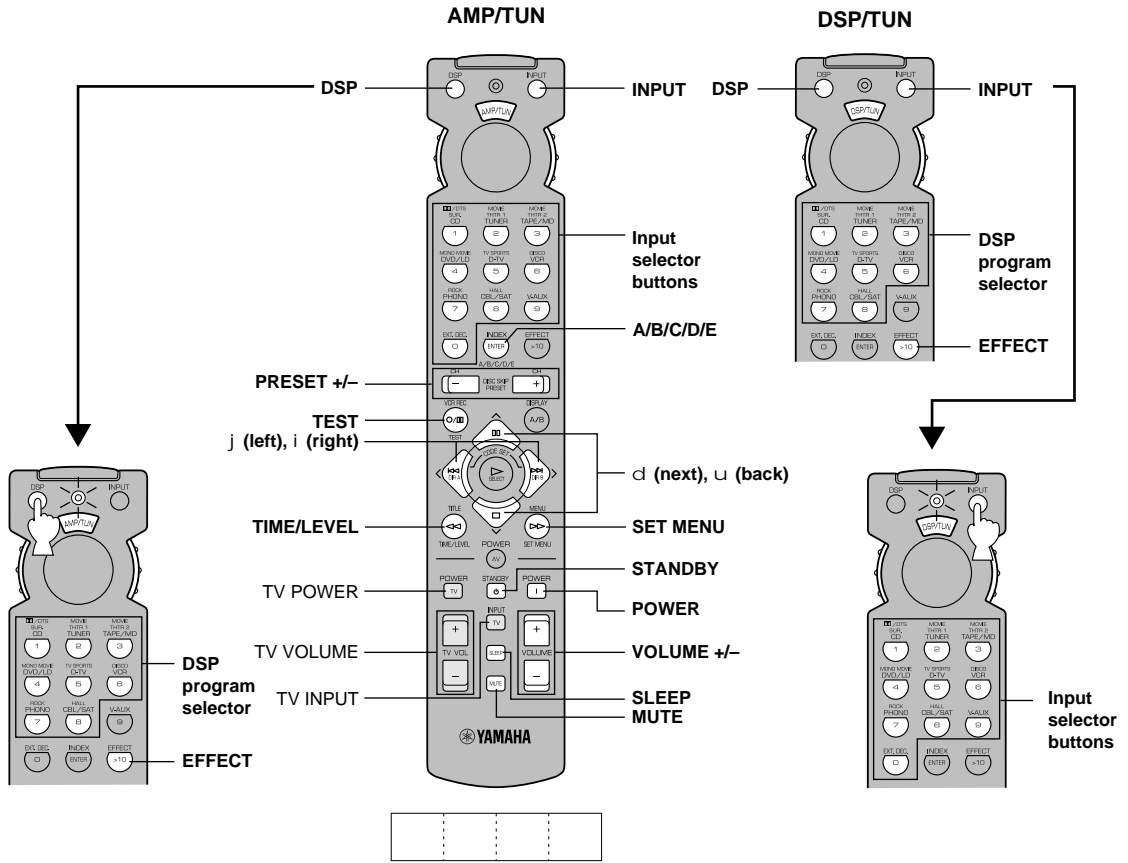

Quick Reference Card

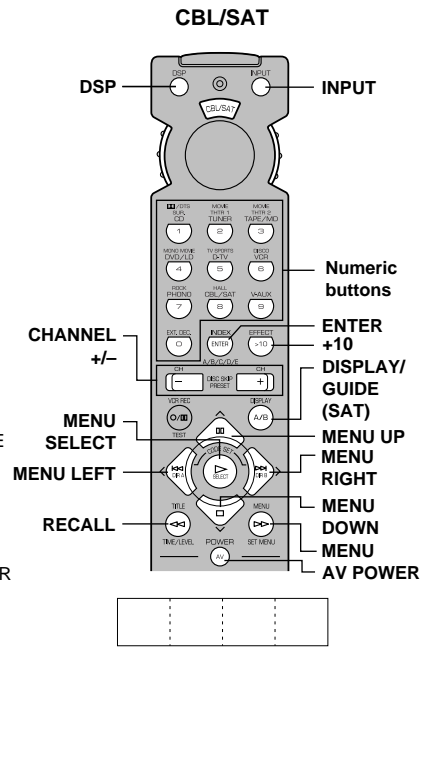
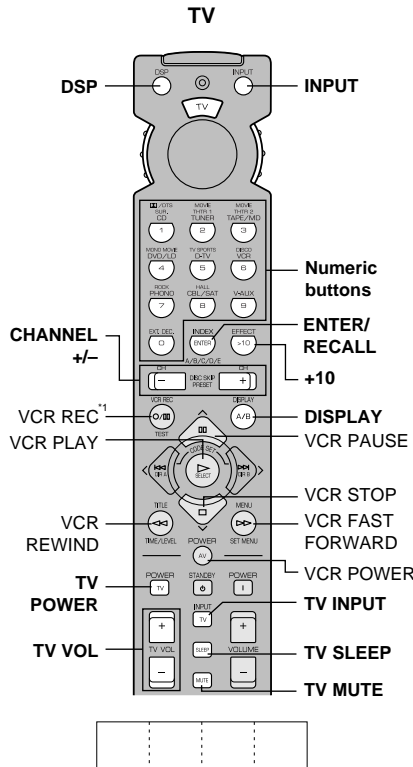
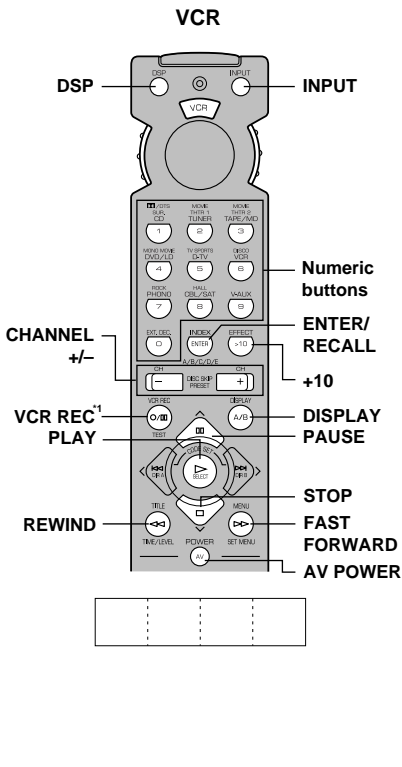
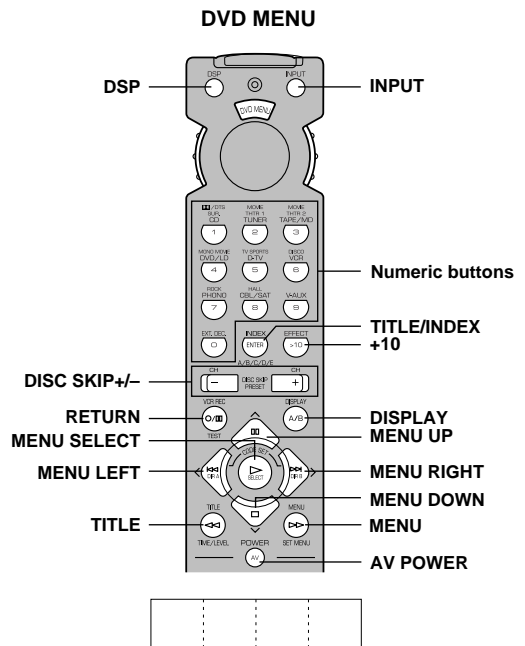
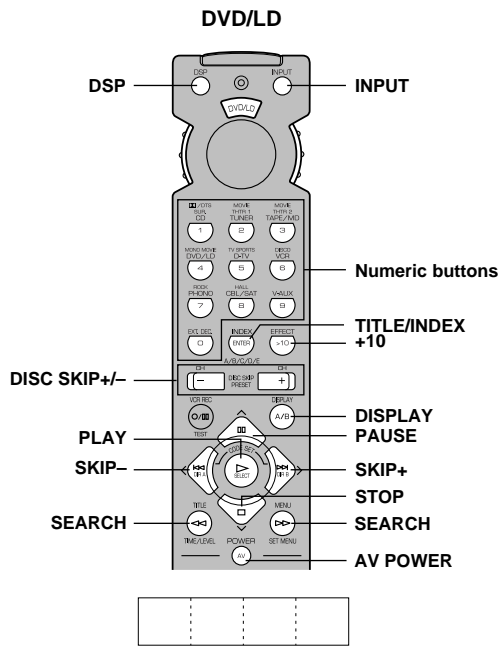

*1 Press this button twice to start recording.
 Appuyer deux fois sur cette touche pour commencer l'enregistrement.
 Drücken Sie diese Taste zweimal, um die Aufnahme zu starten.
 Tryck två gånger på den här knappen för att börja spela in.

Premere due volte questo tasto per iniziare la registrazione.
 Presione dos veces este botón para empezar a grabar.
 Druk tweemaal op deze toets om met opnemen te beginnen.
 按此按钮两次即可开始录像。

Connection Guide (when listening to a digital 5.1-channel source)

