



# *RX-N600*

---

*AV Receiver*

OWNER'S MANUAL

# IMPORTANT SAFETY INSTRUCTIONS

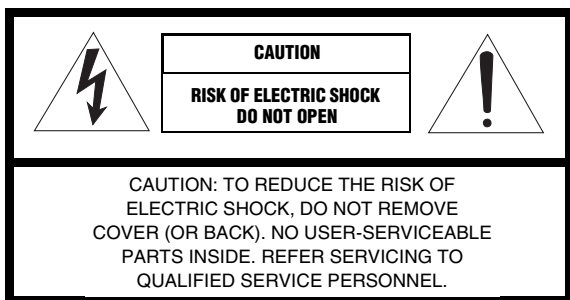

## • Explanation of Graphical Symbols



The lightning flash with arrowhead symbol, within an equilateral triangle, is intended to alert you to the presence of uninsulated “dangerous voltage” within the product’s enclosure that may be of sufficient magnitude to constitute a risk of electric shock to persons.



The exclamation point within an equilateral triangle is intended to alert you to the presence of important operating and maintenance (servicing) instructions in the literature accompanying the appliance.

- 1** Read Instructions – All the safety and operating instructions should be read before the product is operated.
- 2** Retain Instructions – The safety and operating instructions should be retained for future reference.
- 3** Heed Warnings – All warnings on the product and in the operating instructions should be adhered to.
- 4** Follow Instructions – All operating and use instructions should be followed.
- 5** Cleaning – Unplug this product from the wall outlet before cleaning. Do not use liquid cleaners or aerosol cleaners.
- 6** Attachments – Do not use attachments not recommended by the product manufacturer as they may cause hazards.
- 7** Water and Moisture – Do not use this product near water – for example, near a bath tub, wash bowl, kitchen sink, or laundry tub; in a wet basement; or near a swimming pool; and the like.
- 8** Accessories – Do not place this product on an unstable cart, stand, tripod, bracket, or table. The product may fall, causing serious injury to a child or adult, and serious damage to the product. Use only with a cart, stand, tripod, bracket, or table recommended by the manufacturer, or sold with the product. Any mounting of the product should follow the manufacturer’s instructions, and should use a mounting accessory recommended by the manufacturer.
- 9** A product and cart combination should be moved with care. Quick stops, excessive force, and uneven surfaces may cause the product and cart combination to overturn.



- 10** Ventilation – Slots and openings in the cabinet are provided for ventilation and to ensure reliable operation of the product and to protect it from overheating, and these openings must not be blocked or covered. The openings should never be blocked by placing the product on a bed, sofa, rug, or other similar surface. This product should not be placed in a built-in installation such as a bookcase or rack unless proper ventilation is provided or the manufacturer’s instructions have been adhered to.
- 11** Power Sources – This product should be operated only from the type of power source indicated on the marking label. If you are not sure of the type of power supply to your home, consult your product dealer or local power company. For products intended to operate from battery power, or other sources, refer to the operating instructions.
- 12** Grounding or Polarization – This product may be equipped with a polarized alternating current line plug (a plug having one blade wider than the other). This plug will fit into the power outlet only one way. This is a safety feature. If you are unable to insert the plug fully into the outlet, try reversing the plug. If the plug should still fail to fit, contact your electrician to replace your obsolete outlet. Do not defeat the safety purpose of the polarized plug.
- 13** Power-Cord Protection – Power-supply cords should be routed so that they are not likely to be walked on or pinched by items placed upon or against them, paying particular attention to cords at plugs, convenience receptacles, and the point where they exit from the product.
- 14** Lightning – For added protection for this product during a lightning storm, or when it is left unattended and unused for long periods of time, unplug it from the wall outlet and disconnect the antenna or cable system. This will prevent damage to the product due to lightning and power-line surges.
- 15** Power Lines – An outside antenna system should not be located in the vicinity of overhead power lines or other electric light or power circuits, or where it can fall into such power lines or circuits. When installing an outside antenna system, extreme care should be taken to keep from touching such power lines or circuits as contact with them might be fatal.
- 16** Overloading – Do not overload wall outlets, extension cords, or integral convenience receptacles as this can result in a risk of fire or electric shock.
- 17** Object and Liquid Entry – Never push objects of any kind into this product through openings as they may touch dangerous voltage points or short-out parts that could result in a fire or electric shock. Never spill liquid of any kind on the product.
- 18** Servicing – Do not attempt to service this product yourself as opening or removing covers may expose you to dangerous voltage or other hazards. Refer all servicing to qualified service personnel.
- 19** Damage Requiring Service – Unplug this product from the wall outlet and refer servicing to qualified service personnel under the following conditions:
  - a)** When the power-supply cord or plug is damaged,
  - b)** If liquid has been spilled, or objects have fallen into the product,
  - c)** If the product has been exposed to rain or water,

- d) If the product does not operate normally by following the operating instructions. Adjust only those controls that are covered by the operating instructions as an improper adjustment of other controls may result in damage and will often require extensive work by a qualified technician to restore the product to its normal operation,
  - e) If the product has been dropped or damaged in any way, and
  - f) When the product exhibits a distinct change in performance - this indicates a need for service.
- 20 Replacement Parts** – When replacement parts are required, be sure the service technician has used replacement parts specified by the manufacturer or have the same characteristics as the original part. Unauthorized substitutions may result in fire, electric shock, or other hazards.
- 21 Safety Check** – Upon completion of any service or repairs to this product, ask the service technician to perform safety checks to determine that the product is in proper operating condition.
- 22 Wall or Ceiling Mounting** – This unit should be mounted to a wall or ceiling only as recommended by the manufacturer.
- 23 Heat** – The product should be situated away from heat sources such as radiators, heat registers, stoves, or other products (including amplifiers) that produce heat.

- 24 Outdoor Antenna Grounding** – If an outside antenna or cable system is connected to the product, be sure the antenna or cable system is grounded so as to provide some protection against voltage surges and built-up static charges. Article 810 of the National Electrical Code, ANSI/NFPA 70, provides information with regard to proper grounding of the mast and supporting structure, grounding of the lead-in wire to an antenna discharge unit, size of grounding conductors, location of antenna discharge unit, connection to grounding electrodes, and requirements for the grounding electrode.

EXAMPLE OF ANTENNA GROUNDING



NEC – NATIONAL ELECTRICAL CODE

**Note to CATV system installer:**

This reminder is provided to call the CATV system installer’s attention to Article 820-40 of the NEC that provides guidelines for proper grounding and, in particular, specifies that the cable ground shall be connected to the grounding system of the building, as close to the point of cable entry as practical.

**FCC INFORMATION (for US customers)**

**1 IMPORTANT NOTICE: DO NOT MODIFY THIS UNIT!**

This product, when installed as indicated in the instructions contained in this manual, meets FCC requirements. Modifications not expressly approved by Yamaha may void your authority, granted by the FCC, to use the product.

- 2 IMPORTANT:** When connecting this product to accessories and/or another product use only high quality shielded cables. Cable/s supplied with this product **MUST** be used. Follow all installation instructions. Failure to follow instructions could void your FCC authorization to use this product in the USA.

- 3 NOTE:** This product has been tested and found to comply with the requirements listed in FCC Regulations, Part 15 for Class “B” digital devices. Compliance with these requirements provides a reasonable level of assurance that your use of this product in a residential environment will not result in harmful interference with other electronic devices.

This equipment generates/uses radio frequencies and, if not installed and used according to the instructions found in the users manual, may cause interference harmful to the operation of other electronic devices.

Compliance with FCC regulations does not guarantee that interference will not occur in all installations. If this product is found to be the source of interference, which can be determined by turning this unit “OFF” and “ON”, please try to eliminate the problem by using one of the following measures:

Relocate either this product or the device that is being affected by the interference.

Utilize power outlets that are on different branch (circuit breaker or fuse) circuits or install AC line filter/s.

In the case of radio or TV interference, relocate/reorient the antenna. If the antenna lead-in is 300 ohm ribbon lead, change the lead-in to coaxial type cable.

If these corrective measures do not produce satisfactory results, please contact the local retailer authorized to distribute this type of product. If you can not locate the appropriate retailer, please contact Yamaha Electronics Corp., U.S.A. 6660 Orangethorpe Ave, Buena Park, CA 90620.

The above statements apply **ONLY** to those products distributed by Yamaha Corporation of America or its subsidiaries.

# CAUTION: READ THIS BEFORE OPERATING YOUR UNIT.

- 1 To assure the finest performance, please read this manual carefully. Keep it in a safe place for future reference.
- 2 Install this sound system in a well ventilated, cool, dry, clean place – away from direct sunlight, heat sources, vibration, dust, moisture, and/or cold. Allow ventilation space of at least 30 cm on the top, 20 cm on the left and right, and 20 cm on the back of this unit.
- 3 Locate this unit away from other electrical appliances, motors, or transformers to avoid humming sounds.
- 4 Do not expose this unit to sudden temperature changes from cold to hot, and do not locate this unit in an environment with high humidity (i.e. a room with a humidifier) to prevent condensation inside this unit, which may cause an electrical shock, fire, damage to this unit, and/or personal injury.
- 5 Avoid installing this unit where a foreign object may fall onto this unit and/or this unit may be exposed to liquid dripping or splashing. On the top of this unit, do not place:
  - other components, as they may cause damage and/or discoloration on the surface of this unit.
  - burning objects (i.e. candles), as they may cause fire, damage to this unit, and/or personal injury.
  - containers with liquid in them, as they may fall and liquid may cause electrical shock to the user and/or damage to this unit.
- 6 Do not cover this unit with a newspaper, tablecloth, curtain, etc. in order not to obstruct heat radiation. If the temperature inside this unit rises, it may cause fire, damage to this unit, and/or personal injury.
- 7 Do not plug in this unit to a wall outlet until all connections are complete.
- 8 Do not operate this unit upside-down. It may overheat, possibly causing damage.
- 9 Do not use force on switches, knobs and/or cords.
- 10 When disconnecting the power cable from the wall outlet, grasp the plug; do not pull the cord.
- 11 Do not clean this unit with chemical solvents; this might damage the finish. Use a clean, dry cloth.
- 12 Only voltage specified on this unit must be used. Using this unit with a higher voltage than specified is dangerous and may cause fire, damage to this unit, and/or personal injury. YAMAHA will not be held responsible for any damage resulting from use of this unit with a voltage other than specified.
- 13 To prevent damage by lightning, keep the power cable and outdoor antennas disconnected from a wall outlet or this unit during a lightning storm.
- 14 Do not attempt to modify or fix this unit. Contact qualified YAMAHA service personnel when any service is needed. The cabinet should never be opened for any reasons.
- 15 When not planning to use this unit for long periods of time (i.e. vacation), disconnect the AC power plug from the wall outlet.
- 16 Install this unit near the AC wall outlet where the power cable plug can be reached easily.
- 17 Be sure to read the “TROUBLESHOOTING” section on common operating errors before concluding that this unit is faulty.
- 18 Before moving this unit, press MASTER ON/OFF to release it outward to the OFF position to turn off this unit, and then disconnect the power cable from the AC wall outlet.
- 19 **VOLTAGE SELECTOR** (General model only)  
The VOLTAGE SELECTOR on the rear panel of this unit must be set for your local main voltage BEFORE plugging into the AC wall outlet.  
Voltages are 110/120/220/230–240 V AC, 50/60 Hz.

## WARNING

TO REDUCE THE RISK OF FIRE OR ELECTRIC SHOCK, DO NOT EXPOSE THIS UNIT TO RAIN OR MOISTURE.

This unit is not disconnected from the AC power source as long as it is connected to the wall outlet, even if this unit itself is turned off. In this state, this unit is designed to consume a very small quantity of power.

## FOR CANADIAN CUSTOMERS

To prevent electric shock, match wide blade of plug to wide slot and fully insert.  
This Class B digital apparatus complies with Canadian ICES-003.

## POUR LES CONSOMMATEURS CANADIENS

Pour éviter les chocs électriques, introduire la lame la plus large de la fiche dans la borne correspondante de la prise et pousser jusqu'au fond.  
Cet appareil numérique de la classe B est conforme à la norme NMB-003 du Canada.

## IMPORTANT

Please record the serial number of this unit in the space below.

MODEL:

Serial No.:

The serial number is located on the rear panel of this unit. Retain this Owner's Manual in a safe place for future reference.

## COMPLIANCE INFORMATION STATEMENT (DECLARATION OF CONFORMITY PROCEDURE)

Responsible Party: Yamaha Electronics Corporation, U.S.A.  
Address: 6660 Orangethorpe Avenue  
Buena Park, CA 90620  
Telephone: 714-522-9105  
Fax: 714-670-0108  
Type of Equipment: AV Receiver  
Model Name: RX-N600

- This device complies with Part 15 of the FCC Rules.
  - Operation is subject to the following conditions:
    - This device may not cause harmful interference.
    - This device must accept any interference received including interference that may cause undesired operation.
- See the “TROUBLESHOOTING” section at the end of this manual if interference to radio reception is suspected.

# CONTENTS

## INTRODUCTION

<b>FEATURES</b> .....	<b>2</b>
<b>GETTING STARTED</b> .....	<b>3</b>
Supplied accessories .....	3
Installing batteries in the remote control .....	3
<b>CONTROLS AND FUNCTIONS</b> .....	<b>4</b>
Front panel.....	4
Remote control.....	6
Front panel display .....	9
Rear panel .....	11

## PREPARATION

<b>CONNECTIONS</b> .....	<b>12</b>
Placing speakers.....	12
Connecting speakers .....	13
Information on jacks and cable plugs .....	16
Audio and video signal flow.....	17
Connecting a TV.....	18
Connecting a DVD player, a DVD recorder, a VCR or an STB.....	19
Connecting a CD player, an MD player or a tape deck.....	21
Connecting a YAMAHA iPod universal dock .....	22
Connecting the network .....	23
Connecting a multi-format player, an external decoder or a sound processor.....	24
Connecting a game console, a video camera or a portable audio player.....	24
Connecting the FM and AM antennas .....	25
Connecting the power cable.....	26
Setting the speaker impedance.....	27
Turning on and off the power .....	28
<b>BASIC SETUP</b> .....	<b>29</b>

## BASIC OPERATION

<b>PLAYBACK</b> .....	<b>32</b>
<b>USING AUDIO FEATURES</b> .....	<b>34</b>
Using SILENT CINEMA .....	34
Muting the audio output.....	34
Selecting the night listening mode.....	34
Selecting the input mode .....	35
Using the sleep timer .....	35
Adjusting the speaker level.....	36
Selecting the Compressed Music Enhancer mode... ..	37
Selecting the MULTI CH INPUT component.....	38
Enjoying multi-channel sources in 2-channel stereo	39
Enjoying unprocessed input sources.....	39
Enjoying pure hi-fi stereo sound.....	39
<b>USING VIDEO FEATURES</b> .....	<b>40</b>
Displaying the input source information .....	40
Selecting the OSD mode.....	41
Playing video sources in the background .....	41
<b>ENJOYING SURROUND SOUND</b> .....	<b>42</b>
Enjoying multi-channel sources in 6.1-channel surround.....	42
Enjoying 2-channel sources in surround.....	43
Using Virtual CINEMA DSP .....	44
<b>RECORDING</b> .....	<b>45</b>

<b>FM/AM TUNING</b> .....	<b>46</b>
Automatic tuning .....	46
Manual tuning.....	47
Automatic preset tuning.....	48
Manual preset tuning .....	49
Selecting preset stations.....	50
Exchanging preset stations .....	51
<b>XM® SATELLITE RADIO TUNING</b> .....	<b>53</b>
Connecting XM Passport System .....	54
XM Satellite Radio controls and functions.....	55
Activating XM Satellite Radio .....	56
Basic XM Satellite Radio operations.....	57
Selecting the XM Satellite Radio search mode .....	58
Setting the XM Satellite Radio preset channels .....	62
Displaying the XM Satellite Radio information.....	63

## SOUND FIELD PROGRAMS

<b>SOUND FIELD PROGRAMS</b> .....	<b>65</b>
Selecting sound field programs .....	65
Sound field program descriptions.....	66
Changing sound field parameter settings.....	68

## ADVANCED OPERATION

<b>SET MENU</b> .....	<b>74</b>
Using SET MENU.....	76
1 SOUND MENU.....	77
2 INPUT MENU.....	82
3 NET/USB MENU.....	84
4 OPTION MENU .....	86
<b>ADVANCED SETUP</b> .....	<b>90</b>
<b>REMOTE CONTROL FEATURES</b> .....	<b>93</b>
Controlling this unit, a TV, or other components....	93
Setting the remote control code .....	95
Setting library codes .....	96
Resetting all remote control codes.....	97
<b>USING MULTI-ZONE CONFIGURATION</b> .....	<b>98</b>
Connecting Zone 2.....	98
Controlling Zone 2.....	99
<b>USING iPod®</b> .....	<b>101</b>
Controlling iPod .....	101
<b>USING NETWORK/USB FEATURES</b> .....	<b>103</b>
Navigating the network and USB menus .....	103
Using a PC server or YAMAHA MCX-2000.....	105
Using the Internet radio .....	106
Using a USB memory device or a USB portable audio player .....	107
<b>RESETTING THE SYSTEM</b> .....	<b>108</b>

## ADDITIONAL INFORMATION

<b>TROUBLESHOOTING</b> .....	<b>109</b>
<b>GLOSSARY</b> .....	<b>116</b>
Audio information .....	116
Video information.....	118
Sound field program information .....	118
<b>SPECIFICATIONS</b> .....	<b>119</b>

INTRODUCTION

PREPARATION

BASIC  
OPERATION

SOUND FIELD  
PROGRAMS

ADVANCED  
OPERATION

ADDITIONAL  
INFORMATION

# FEATURES

## Built-in 6-channel power amplifier

- ◆ Minimum RMS output power (20 Hz to 20 kHz, 0.06% THD, 8 Ω)  
Front: 95 W + 95 W  
Center: 95 W  
Surround: 95 W + 95 W  
Surround back: 95 W

## Sound field programs

- ◆ Proprietary YAMAHA technology for the creation of sound fields
- ◆ Dolby Digital/Dolby Digital EX decoder
- ◆ DTS/DTS-ES Matrix 6.1, Discrete 6.1, DTS Neo:6, DTS 96/24 decoder
- ◆ Dolby Pro Logic/Dolby Pro Logic II/Dolby Pro Logic IIx decoder
- ◆ Neural Surround decoder (U.S.A. and Canada models only)
- ◆ Virtual CINEMA DSP
- ◆ SILENT CINEMA™

## Sophisticated AM/FM tuner

- ◆ 40-station random and direct preset tuning
- ◆ Automatic preset tuning
- ◆ Preset station shifting capability (preset editing)

## XM Satellite Radio

### (U.S.A. and Canada models only)

- ◆ XM Satellite Radio tuning capability (using “XM Passport System” sold separately)
- ◆ Neural Surround decoder to play back the surround sound content of the XM Satellite Radio broadcasts in multi-channels, resulting in a full surround sound experience



Manufactured under license from Dolby Laboratories.  
“Dolby”, “Pro Logic”, and the double-D symbol are trademarks of Dolby Laboratories.



Manufactured under license from Digital Theater Systems, Inc. “DTS”, “DTS-ES”, “NEO:6”, and “DTS 96/24” are trademarks of Digital Theater Systems, Inc. Copyright 1996, 2003 Digital Theater Systems, Inc. All right reserved.

iPod®

“iPod” is a trademark of Apple Computer, Inc., registered in the U.S. and other countries.



**Fraunhofer** Institut  
Integrierte Schaltungen

MPEG Layer-3 audio coding technology licensed from Fraunhofer IIS and Thomson.

## iPod controlling capability

- ◆ DOCK terminal to connect a YAMAHA iPod universal dock (such as YDS-10 sold separately), which supports iPod (Click and Wheel), iPod nano, and iPod mini

## Network features

- ◆ LAN port to connect a PC and YAMAHA MCX-2000 or access the Internet radio via a LAN
- ◆ DHCP automatic or manual network configuration

## USB features

- ◆ USB port to connect a USB memory device or a USB portable audio player

## Other features

- ◆ 192-kHz/24-bit D/A converter
- ◆ OSD (on-screen display) menus that allow you to optimize this unit to suit your individual audiovisual system
- ◆ 6 additional input jacks for discrete multi-channel input
- ◆ S-video signal input/output capability
- ◆ Component video input/output capability (3 COMPONENT VIDEO INs and 1 MONITOR OUT)
- ◆ Digital video signal conversion (composite video ↔ S-video → component video) capability for monitor out
- ◆ Optical and coaxial digital audio signal jacks
- ◆ Sleep timer
- ◆ Cinema and music night listening modes
- ◆ Remote control with preset remote control codes, backlighting input selector buttons, and an iPod (stationed in a YAMAHA iPod universal dock connected to the DOCK terminal) controlling capability
- ◆ Zone 2 custom installation facility
- ◆ Zone switching capability between the main zone and Zone 2 using ZONE CONTROL
- ◆ Compressed Music Enhancer mode to improve the sound quality of compression artifacts (such as the MP3 format) to that of a high-quality stereo



This receiver supports network connections.

SILENT™  
CINEMA

“SILENT CINEMA” is a trademark of YAMAHA CORPORATION.



The XM name and related logos are registered trademarks of XM Satellite Radio Inc.



Neural Surround™ name and related logos are trademarks owned by Neural Audio Corporation.

This unit contains programs licensed under the GNU General Public License and GNU Lesser General Public License.

Windows XP, Windows Media Audio, Windows Media Connect are either registered trademarks or trademarks of Microsoft corporation in the United States and/or countries.

# GETTING STARTED

## Supplied accessories

Check that you received all of the following parts.

### Remote control

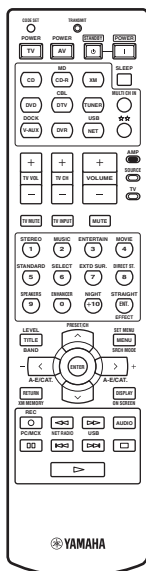

### AM loop antenna

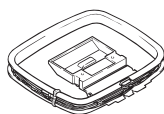

### Indoor FM antenna (U.S.A., Canada, China and General models)

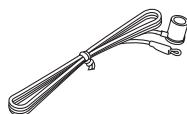

### Indoor FM antenna (Europe, Australia and Korea models)

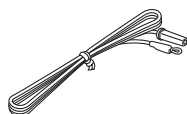

### Batteries (2) (AA, R6, UM-3)

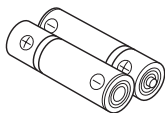

## Installing batteries in the remote control

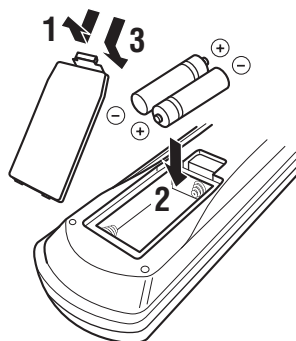

**1** Take off the battery compartment cover.

**2** Insert the two supplied batteries (AA, R6, UM-3) according to the polarity markings (+ and -) on the inside of the battery compartment.

**3** Snap the battery compartment cover back into place.

### Notes

- Change all of the batteries if you notice the following conditions:
  - the operation range of the remote control decreases.
  - the TRANSMIT indicator does not flash or its light becomes dim.
- Do not use an old battery together with a new one.
- Do not use different types of batteries (such as alkaline and manganese batteries) together. Read the packaging carefully as these different types of batteries may have the same shape and color.
- If the batteries have leaked, dispose of them immediately. Avoid touching the leaked material or letting it come into contact with clothing, etc. Clean the battery compartment thoroughly before installing new batteries.
- Do not throw away batteries with general house waste; dispose of them correctly in accordance with your local regulations.
- If the remote control is without batteries for more than 2 minutes, or if exhausted batteries remain in the remote control, the contents of the memory may be cleared. When the memory is cleared, insert new batteries and set up the remote control code that may have been cleared.

### About this manual

-  indicates a tip for your operation.
- Some operations can be performed by using either the buttons on the front panel or the ones on the remote control. In case the button names differ between the front panel and the remote control, the button name on the remote control is given in parentheses.
- This manual is printed prior to production. Design and specifications are subject to change in part as a result of improvements, etc. In case of differences between the manual and product, the product has priority.

# CONTROLS AND FUNCTIONS

## Front panel

### Note

The XM Satellite Radio controlling functions in the following buttons (SEARCH MODE, CATEGORY, PRESET/TUNING/CH  $\triangleleft$ / $\triangleright$ , MEMORY, and DISPLAY) are only applicable to the U.S.A. and Canada models and are operational only when “XM” is selected as the input source. For details, see “XM Satellite Radio controls and functions” on page 55.

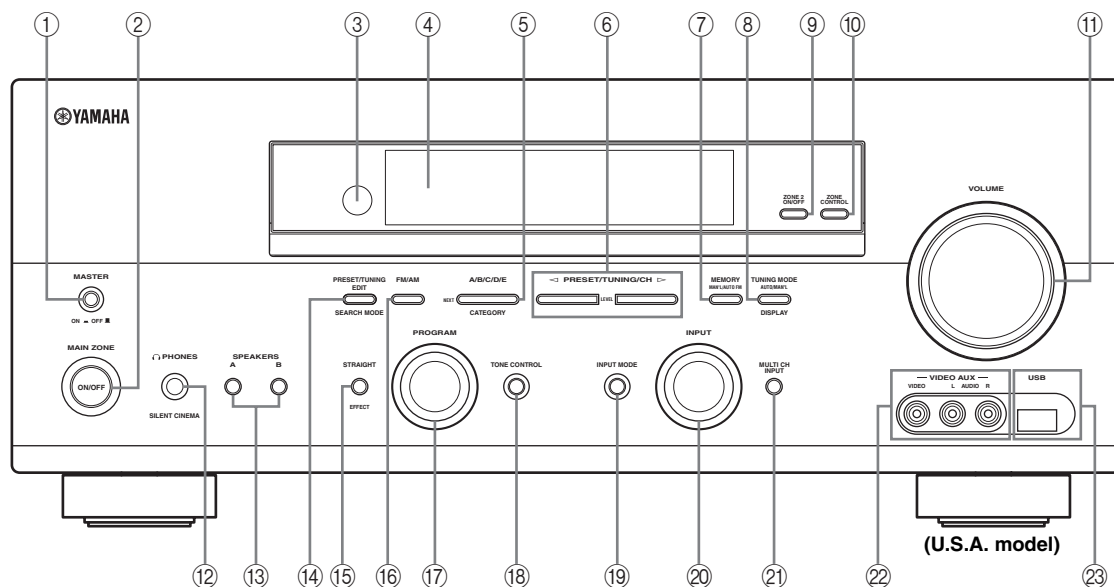

### ① MASTER ON/OFF

Turns on or off this unit (see page 28).

### ② MAIN ZONE ON/OFF

Turns on the main zone or sets it to the standby mode (see page 28).

### Notes

- In the standby mode, this unit consumes a small amount of power in order to receive infrared signals from the remote control.
- When you turn on this unit, there will be a 4 to 5-second delay before this unit can reproduce sound.
- This button is operational only when MASTER ON/OFF is pressed inward to the ON position.

### ③ Remote control sensor

Receives signals from the remote control (see page 8).

### ④ Front panel display

Shows information about the operational status of this unit (see page 9).

### ⑤ A/B/C/D/E, NEXT

- Selects one of the 5 preset station groups (A to E) when “TUNER” is selected as the input source (see page 49).
- Selects the speaker channel whose output level you want to adjust when “TUNER” is not selected as the input source (see page 36).

### ⑥ PRESET/TUNING/CH $\triangleleft$ / $\triangleright$ , LEVEL

- Selects one of the 8 preset station numbers (1 to 8) when “TUNER” is selected as the input source. The colon (:) is displayed in the front panel display (see page 50).
- Selects the tuning frequency when “TUNER” is selected as the input source. The colon (:) is not displayed in the front panel display (see page 46).
- Adjusts the level of the speaker channel selected using NEXT when “TUNER” is not selected as the input source (see page 36).

### ⑦ MEMORY (MAN'L/AUTO FM)

Stores a preset station in the memory. Hold down this button for more than 3 seconds to start automatic preset tuning (see page 48).



**⑧ TUNING MODE (AUTO/MAN'L)**

Switches between automatic tuning (the AUTO indicator is turned on) and manual tuning (the AUTO indicator is turned off) (see page 46).

**⑨ ZONE 2 ON/OFF**

Turns on Zone 2 or sets it to the standby mode (see page 99).

**Note**

This button is operational only when MASTER ON/OFF is pressed inward to the ON position.

**⑩ ZONE CONTROL**

Switches the zone you want to control between the main zone and Zone 2 (see page 99).



When Zone 2 is selected, the ZONE2 indicator flashes in the front panel display for approximately 5 seconds. While the indicator is flashing, perform the desired operation.

**⑪ VOLUME**

Controls the output level of all audio channels.



This does not affect the AUDIO OUT (REC) level.

**⑫  PHONES (SILENT CINEMA) jack**

Outputs audio signals for private listening with headphones (see page 34).



**Notes**

- When you connect headphones, no signals are output at the SUBWOOFER OUTPUT jack or the speaker terminals.
- All Dolby Digital and DTS audio signals are mixed down to the left and right headphone channels.

**⑬ SPEAKERS A/B**

Turns on or off the set of front speakers connected to the FRONT A and/or B terminals on the rear panel each time the corresponding button is pressed.

**⑭ PRESET/TUNING, EDIT**

- Switches the function of PRESET/TUNING/CH  /  between selecting preset station numbers and selecting the tuning frequency.
- Edits the assignments of preset stations (see page 51).

**⑮ STRAIGHT (EFFECT)**

Turns the sound field programs off or on. When the “STRAIGHT” mode is selected, 2-channel or multi-channel input signals are output directly from their respective speakers without effect processing (see page 39).

**⑯ FM/AM**

Switches the reception band between FM and AM when “TUNER” is selected as the input source (see page 46).

**⑰ PROGRAM selector**

Selects sound field programs or adjusts the bass/treble balance in conjunction with TONE CONTROL (see page 33).

**⑱ TONE CONTROL**

Adjusts the bass/treble balance of the front left and right speakers in conjunction with the PROGRAM selector (see page 33).

**⑲ INPUT MODE**

Selects either digital or analog input signals exclusively or sets this unit to automatically detect the type of input signals and select the corresponding input signals when one component is connected via both digital and analog connections (see page 35).

**⑳ INPUT selector**

Selects the desired input source.

**㉑ MULTI CH INPUT**

Selects the component connected to the MULTI CH INPUT jacks as the input source (see page 38).

**Note**

The input source connected to the MULTI CH INPUT jacks takes priority over the source selected with the INPUT selector on the front panel (or the input selector buttons on the remote control).

**㉒ VIDEO AUX jacks**

Input audio and video signals from a portable external source such as a game console, a video camera or a portable audio player (see page 24).



To reproduce the source signals input at these jacks, select “V-AUX” as the input source.

**Note**

The audio signals input at the DOCK terminal on the rear panel take priority over the ones input at the VIDEO AUX jacks.

**㉓ USB port**

Use to connect a USB memory device or a USB portable audio player (see page 107).

## Remote control

This section describes the function of each control on the remote control used to control this unit. To operate other components, see “REMOTE CONTROL FEATURES” on page 93.

### Notes

- The operation mode of the remote control buttons in the shaded area below depends on the component selector switch position. Set the component selector switch to AMP to control this unit. To control the TUNER functions, set the component selector switch to SOURCE and then press TUNER to select “TUNER” as the input source.
- The XM Satellite Radio controlling functions in the following buttons (XM, XM MEMORY, SRCH MODE, DISPLAY, cursor buttons  $\wedge/\vee/</>$ , numeric buttons and ENT.) are only applicable to the U.S.A. and Canada models and are operational only when “XM” is selected as the input source. For details, see “XM Satellite Radio controls and functions” on page 55.

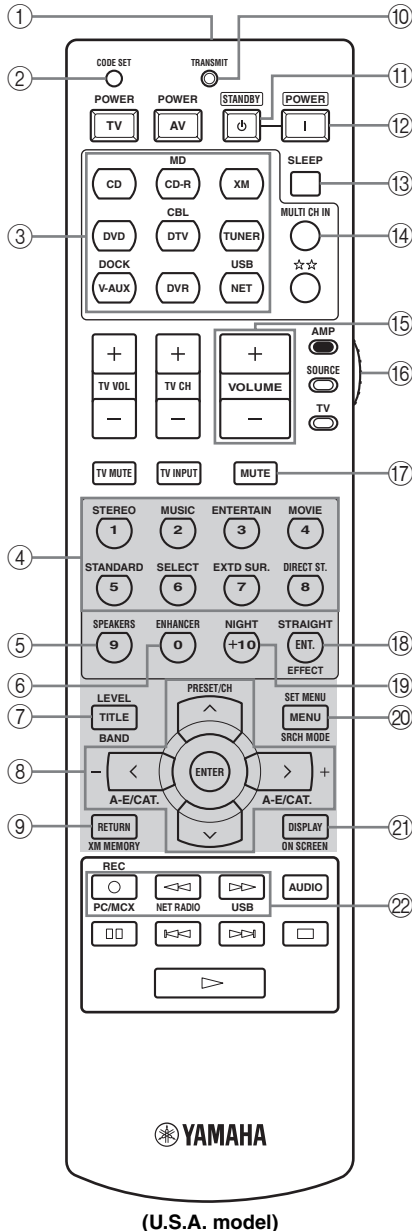

(U.S.A. model)

### ■ Controlling this unit

Set the component selector switch to AMP to control this unit.

#### ① Infrared window

Outputs infrared control signals. Aim this window at the component you want to operate (see page 8).

#### ② CODE SET

Use to set up remote control codes (see page 95).

#### ③ Input selector buttons

Select the input source you want to control.

### Note

The corresponding input selector button for the currently selected input source lights up for approximately 5 seconds after you press any buttons on the remote control, showing which source component is currently being operated.

#### ④ Sound field program selector buttons

Select sound field programs (see page 65).

- Use SELECT to play back 2-channel sources in surround (see page 43).
- Use EXTD SUR. to switch between 5.1 and 6.1-channel playback of multi-channel sources (see page 42).
- Use DIRECT ST. to play back 2-channel sources in hi-fi stereo sound (see page 39).

#### ⑤ SPEAKERS

Turns on or off the set of front speakers connected to the FRONT A and/or B terminals on the rear panel. Press this button repeatedly to toggle as follows:

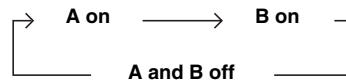

**⑥ ENHANCER**

Turns on or off the Compressed Music Enhancer mode (see page 37).

**⑦ LEVEL**

Selects the speaker channel to be adjusted and sets the output level (see page 36).

**⑧ Cursor buttons  $\wedge$ / $\vee$ / $\lt$ / $\gt$ , ENTER**

Select and adjust the sound field program parameters or the "SET MENU" parameters.

**⑨ RETURN**

Returns to the previous menu level when adjusting the "SET MENU" parameters.

**⑩ TRANSMIT indicator**

Flashes while the remote control is sending infrared signals.

**⑪ STANDBY**

Sets this unit to the standby mode (see page 28).

**Note**

This button is operational only when MASTER ON/OFF on the front panel is pressed inward to the ON position.

**⑫ POWER**

Turns on this unit (see page 28).

**Note**

This button is operational only when MASTER ON/OFF on the front panel is pressed inward to the ON position.

**⑬ SLEEP**

Sets the sleep timer (see page 35).

**⑭ MULTI CH IN**

Selects the component connected to the MULTI CH INPUT jacks as the input source when using an external decoder, etc. (see page 38).

**⑮ VOLUME +/-**

Increases or decreases the volume level.

**⑯ Component selector switch**

Selects the operation mode of the remote control buttons in the shaded area.

**AMP**

Operates this unit.

**SOURCE**

Operates the component selected with an input selector button (see page 94).

**TV**

Operates the TV assigned to either DTV/CBL or ☆☆ (see page 93).

**Notes**

- To set the remote control codes for other components, see page 95.
- When you set the remote control codes for both DTV/CBL and ☆☆ (see page 95), priority is given to the one set for DTV/CBL.

**⑰ MUTE**

Mutes the audio output. Press again to restore the audio output to the previous volume level (see page 34).

**⑱ STRAIGHT (EFFECT)**

Turns the sound field programs off or on. When the "STRAIGHT" mode is selected, 2-channel or multi-channel input signals are output directly from their respective speakers without effect processing (see page 39).

**⑲ NIGHT**

Turns on or off the night listening modes (see page 34).

**⑳ SET MENU**

Enters "SET MENU" (see page 76).

**㉑ DISPLAY**

Selects the on-screen display (OSD) mode for your video monitor (see page 41).

**㉒ Network and USB input selector buttons**

Select the sub input source of NET/USB (see page 103).

**PC/MCX**

Selects a PC server or YAMAHA MCX-2000 as the sub input source of NET/USB.

**NET RADIO**

Selects the Internet radio as the sub input source of NET/USB.

**USB**

Selects a USB memory device or a USB portable audio player as the sub input source of NET/USB.

**Notes**

- Press NET/USB to select "NET/USB" as the input source before you press any of the network and USB input selector buttons stated above to select the corresponding sub input source of NET/USB.
- When you press any of the network and USB input selector buttons, the contents previously played for the corresponding sub input source of NET/USB is automatically played.

■ **Controlling the TUNER functions**

Set the component selector switch to SOURCE and then press TUNER to select “TUNER” as the input source.

④ **Numeric buttons**

Use numbers 1 through 8 to select preset stations.

⑦ **BAND**

Switches the reception band between FM and AM.

⑧ **Cursor buttons**  $\wedge$  /  $\vee$  /  $\langle$  /  $\rangle$

Press  $\langle$  /  $\rangle$  to select a preset station group (A to E) and  $\wedge$  /  $\vee$  to select a preset station number (1 to 8) (see page 50).

■ **Using the remote control**

The remote control transmits a directional infrared ray. Be sure to aim the remote control directly at the remote control sensor on this unit during operation.

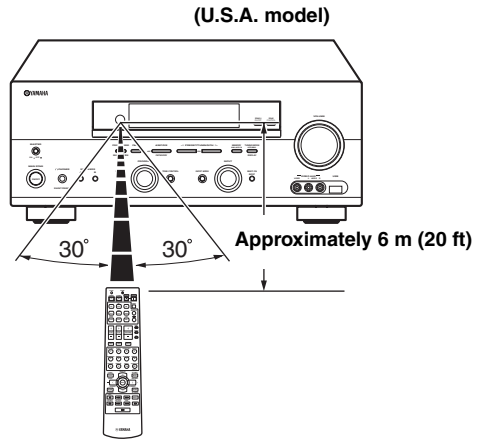

**Notes**

- Do not spill water or other liquids on the remote control.
- Do not drop the remote control.
- Do not leave or store the remote control in the following types of conditions:
  - places of high humidity, such as near a bath
  - places of high temperatures, such as near a heater or stove
  - places of extremely low temperatures
  - dusty places

## Front panel display

### Note

The XM indicator is only applicable to the U.S.A. and Canada models and the cursor on the left of the XM indicator lights up only when "XM" is selected as the input source. For details, see "Basic XM Satellite Radio operations" on page 57.

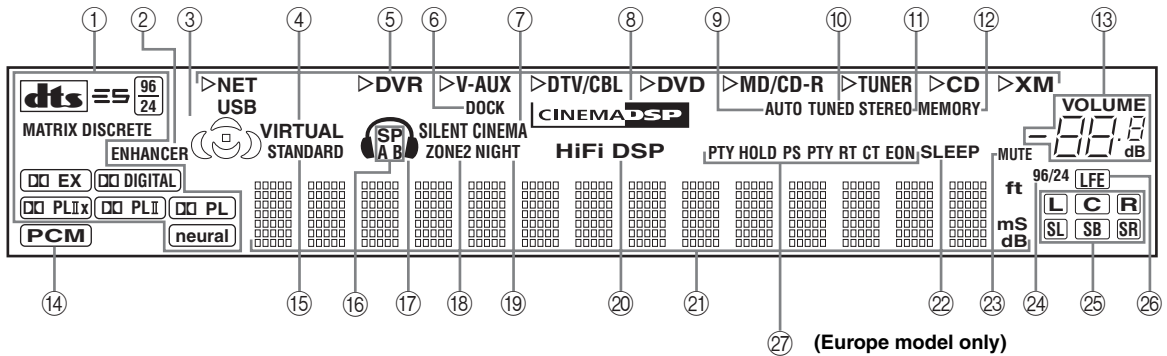

### ① Decoder indicators

The respective indicator lights up when any of the decoders of this unit functions.

### Note

The neural indicator is only applicable to the U.S.A. and Canada models and lights up only when the Neural Surround decoder is selected (see page 43).

### ② ENHANCER indicator

Lights up when the Compressed Music Enhancer mode is turned on (see page 37).

### ③ Sound field indicators

Light up to indicate the active DSP sound fields.

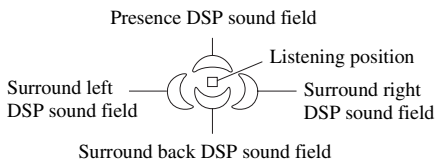

### ④ VIRTUAL indicator

Lights up when Virtual CINEMA DSP is active (see page 44).

### ⑤ Input source indicators

The corresponding cursor lights up to show the currently selected input source.

### ⑥ DOCK indicator

Lights up when you station your iPod in a YAMAHA iPod universal dock (such as YDS-10 sold separately) connected to the DOCK terminal of this unit (see page 22).

### ⑦ SILENT CINEMA indicator

Lights up when headphones are connected and a sound field program is selected (see page 34).

### ⑧ CINEMA DSP indicator

Lights up when you select a CINEMA DSP sound field program (see page 66).

### ⑨ AUTO indicator

Lights up when this unit is in the automatic tuning mode (see page 46).

### ⑩ TUNED indicator

Lights up when this unit is tuned into a station (see page 46).

### ⑪ STEREO indicator

Lights up when this unit is receiving a strong signal for an FM stereo broadcast while the AUTO indicator is lit.

### ⑫ MEMORY indicator

Flashes to show that a station can be stored (see page 48).

**⑬ VOLUME level indicator**

Indicates the current volume level.

**⑭ PCM indicator**

Lights up when this unit is reproducing PCM (Pulse Code Modulation) digital audio signals.

**⑮ STANDARD indicator**

Lights up when the “SUR. STANDARD” or “SUR. ENHANCED” program is selected.

**⑯ SP A B indicators**

Light up according to the set of front speakers selected.

**⑰ Headphones indicator**

Lights up when headphones are connected.

**⑱ ZONE2 indicator**

Lights up when Zone 2 is turned on (see page 99).

**⑲ NIGHT indicator**

Lights up when you select a night listening mode (see page 34).

**⑳ HiFi DSP indicator**

Lights up when you select a HiFi DSP sound field program (see page 67).

**㉑ Multi-information display**

Shows the name of the current sound field program and other information when adjusting or changing settings.

**㉒ SLEEP indicator**

Lights up while the sleep timer is on (see page 35).

**㉓ MUTE indicator**

Flashes while the MUTE function is on (see page 34).

**㉔ 96/24 indicator**

Lights up when a DTS 96/24 signal is input to this unit.

**㉕ Input channel indicators**

Indicate the channel components of the current digital input signal.

**㉖ LFE indicator**

Lights up when the input signal contains the LFE signal.

**㉗ Radio Data System indicators  
(Europe model only)**

The corresponding indicator lights up to show the type of the Radio Data System information.

**EON**

Lights up when the EON data service is being received.

**PTY HOLD**

Lights up while searching for the Radio Data System stations in the PTY SEEK mode.

## Rear panel

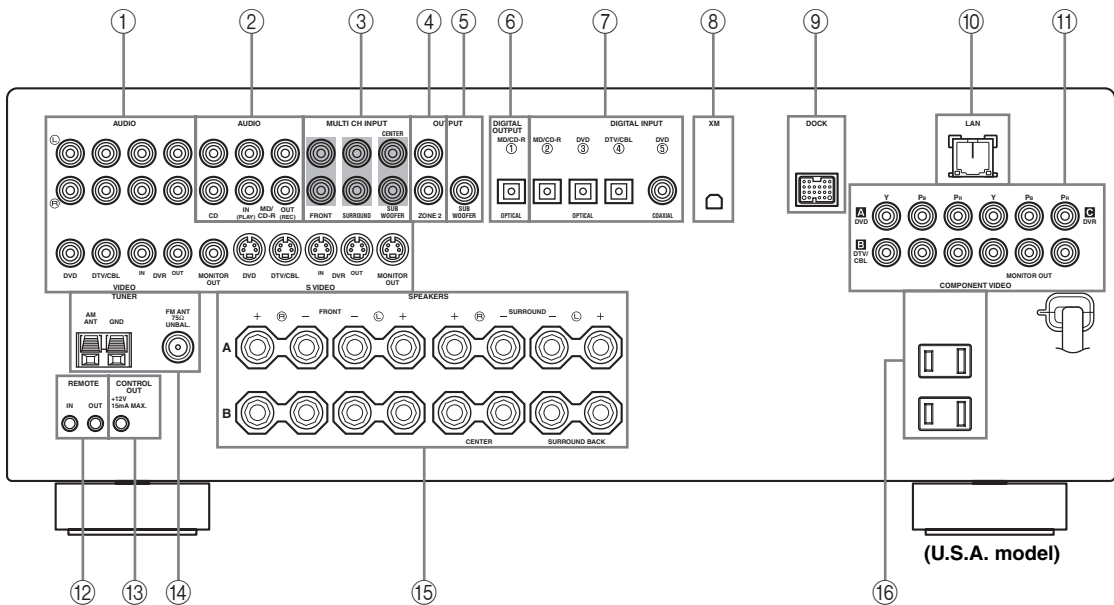

### ① Video component jacks

See pages 18 and 19 for connection information.

### ② Audio component jacks

See page 21 for connection information.

### ③ MULTI CH INPUT jacks

See page 24 for connection information.

### ④ ZONE 2 OUTPUT jacks

See page 98 for connection information.

### Note

These jacks output analog signals only.

### ⑤ SUBWOOFER OUTPUT jack

See page 13 for connection information.

### ⑥ DIGITAL OUTPUT jack

See page 21 for connection information.

### ⑦ DIGITAL INPUT jacks

See pages 19 and 21 for connection information.

### ⑧ XM jack (U.S.A. and Canada models only)

See page 54 for connection information.

### ⑨ DOCK terminal

Use to connect a YAMAHA iPod universal dock (such as YDS-10 sold separately) where your iPod can be stationed.

See page 22 for connection information.

### ⑩ LAN port

Use to connect a network cable for network connections. See page 23 for connection information.

### ⑪ COMPONENT VIDEO jacks

See pages 18 and 19 for connection information.

### ⑫ REMOTE jacks

See page 98 for details.

### ⑬ CONTROL OUT jack

This is a control expansion terminal for custom installation.

### ⑭ Antenna terminals

See page 25 for connection information.

### ⑮ Speaker terminals

See page 13 for connection information.

### ⑯ AC OUTLET(S)

Use to supply power to your other audiovisual components.

See page 26 for details.

### ■ VOLTAGE SELECTOR (General model only)

See page 26 for details.

# CONNECTIONS

## Placing speakers

The speaker layout below shows the standard ITU-R\* speaker setting. You can use it to enjoy CINEMA DSP and multi-channel audio sources.

\* ITU-R is the radio communication sector of the ITU (International Telecommunication Union).

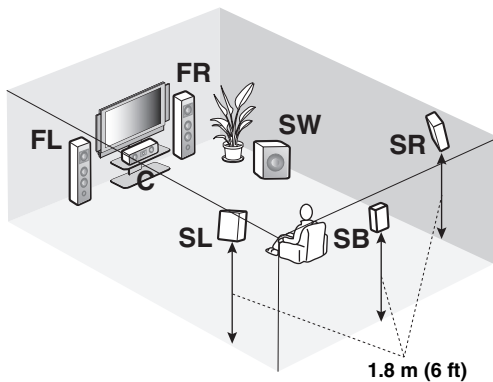
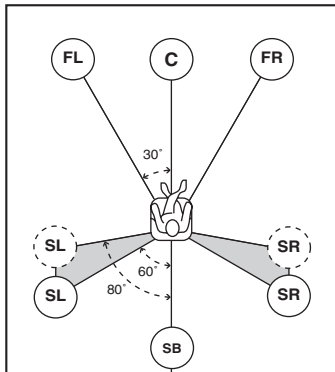

### Front left and right speakers (FL and FR)

The front speakers are used for the main source sound plus effect sounds. Place these speakers at an equal distance from the ideal listening position. The distance of each speaker from each side of the video monitor should be the same.

### Center speaker (C)

The center speaker is for the center channel sounds (dialog, vocals, etc.). If for some reason it is not practical to use a center speaker, you can do without it. Best results, however, are obtained with the full system. Place the center speaker centrally between the front speakers and as close to the monitor as possible, such as directly over or under it.

### Surround left and right speakers (SL and SR)

The surround speakers are used for effect and surround sounds. Place these speakers behind your listening position, facing slightly inwards, about 1.8 m (6 ft) above the floor.

### Surround back speaker (SB)

The surround back speaker supplements the surround speakers and provides more realistic front-to-back transitions. Place this speaker directly behind the listening position and at the same height as the surround speakers.

### Subwoofer (SW)

The use of a subwoofer with a built-in amplifier, such as the YAMAHA Active Servo Processing Subwoofer System, is effective not only for reinforcing bass frequencies from any or all channels, but also for high fidelity reproduction of the LFE (low-frequency effect) channel included in Dolby Digital and DTS sources. The position of the subwoofer is not so critical, because low bass sounds are not highly directional. But it is better to place the subwoofer near the front speakers. Turn it slightly toward the center of the room to reduce wall reflections.



## Connecting speakers

Be sure to connect the left channel (L), right channel (R), “+” (red) and “-” (black) properly. If the connections are faulty, no sound will be heard from the speakers, and if the polarity of the speaker connections is incorrect, the sound will be unnatural and lack bass.

### CAUTION

- Before connecting the speakers, make sure that this unit is turned off (see page 28).
- Do not let the bare speaker wires touch each other or do not let them touch any metal part of this unit. This could damage this unit and/or speakers.
- Use magnetically shielded speakers. If this type of speakers still creates the interference with the monitor, place the speakers away from the monitor.
- If you are to use 6 ohm speakers, be sure to set “SP IMP.” to “6ΩMIN” before using this unit (see page 27). 4 ohm speakers can be also used as the front speakers (see page 91).

### Note

A speaker cord is actually a pair of insulated cables running side by side. Cables are colored or shaped differently, perhaps with a stripe, groove or ridge. Connect the striped (grooved, etc.) cable to the “+” (red) terminals of this unit and your speaker. Connect the plain cable to the “-” (black) terminals.

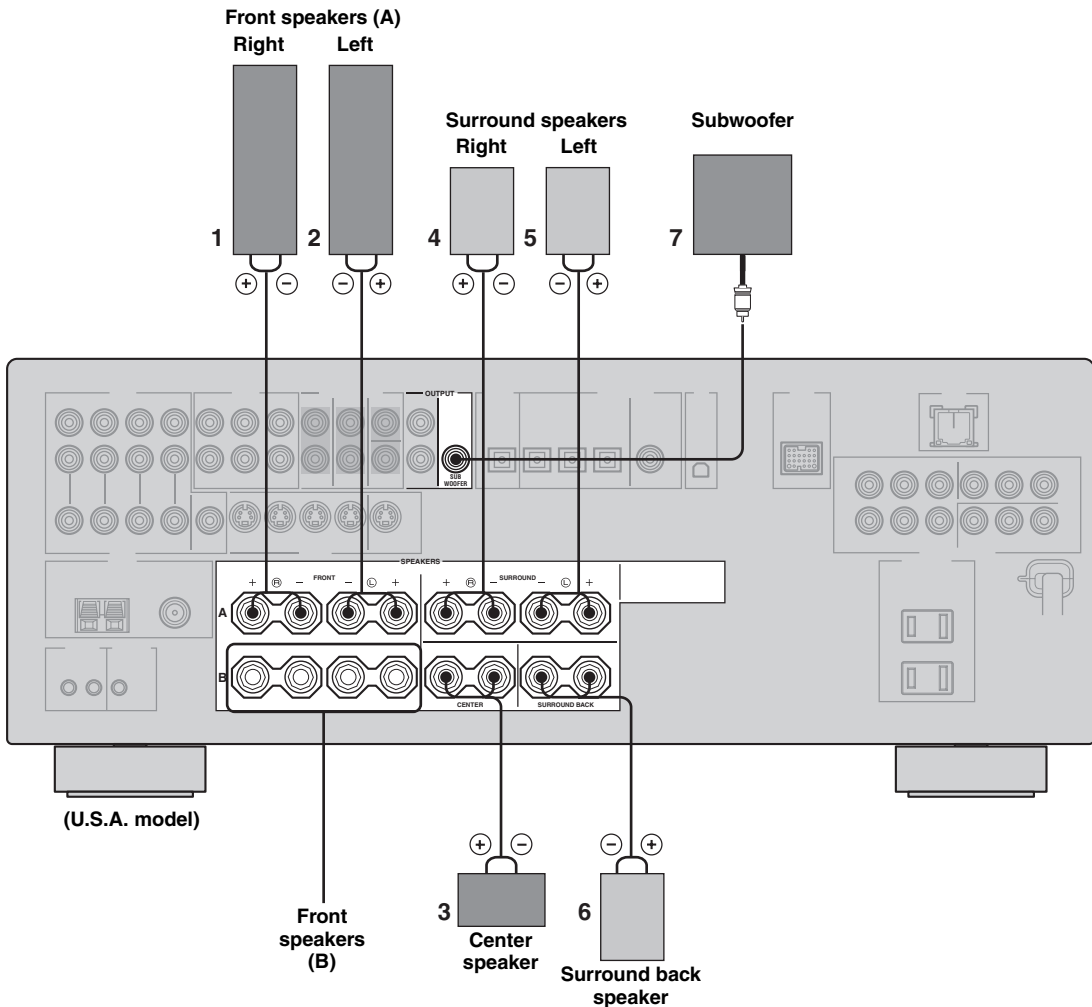

**FRONT terminals**

Connect one or two sets of front speakers (1, 2) to these terminals. If you use only one front speaker system, connect it to the FRONT A or B terminal.

**CENTER terminals**

Connect a center speaker (3) to these terminals.

**SURROUND terminals**

Connect surround speakers (4, 5) to these terminals.

**SURROUND BACK terminals**

Connect a surround back speaker (6) to these terminals.

**SUBWOOFER OUTPUT jack**

Connect a subwoofer with a built-in amplifier (7) (such as the YAMAHA Active Servo Processing Subwoofer System) to this jack.

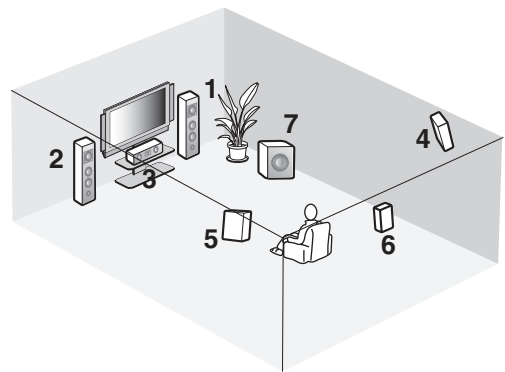

**Speaker layout**

■ Connecting the speaker cable

- 1 Remove approximately 10 mm (0.4 in) of insulation from the end of each speaker cable and then twist the exposed wires of the cable together to prevent short circuits.

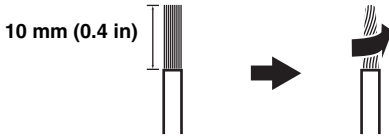

- 2 Loosen the knob.

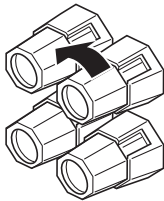

Red: positive (+)  
Black: negative (-)

- 3 Insert one bare wire into the hole on the side of each terminal.

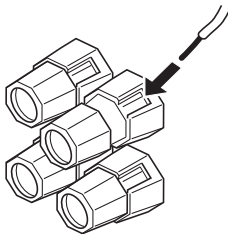

- 4 Tighten the knob to secure the wire.

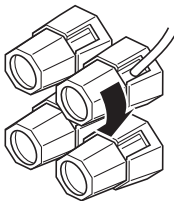

■ Connecting the banana plug (except Europe model)

The banana plug is a single-pole electrical connector widely used to terminate speaker cables.

Banana plug

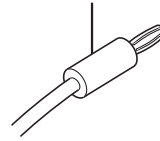

- 1 Tighten the knob.

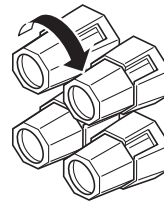

Red: positive (+)  
Black: negative (-)

- 2 Insert the banana plug connector into the end of the corresponding terminal.

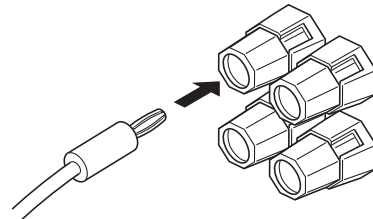

## Information on jacks and cable plugs

### Audio jacks and cable plugs

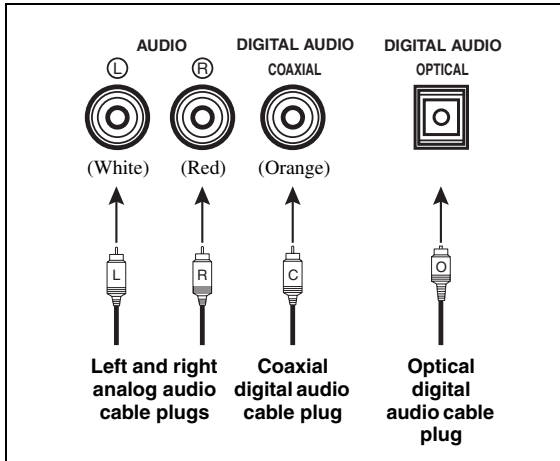

### Video jacks and cable plugs

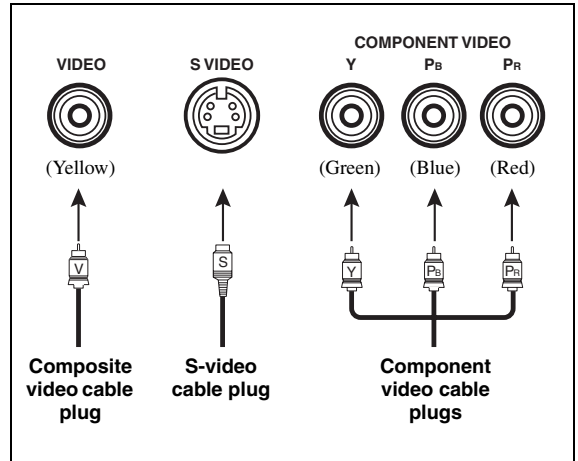

#### ■ Audio jacks

This unit has three types of audio jacks. Connection depends on the availability of audio jacks on your other components.

##### AUDIO jacks

For conventional analog audio signals transmitted via left and right analog audio cables. Connect red plugs to the right jacks and white plugs to the left jacks.

##### DIGITAL AUDIO COAXIAL jacks

For digital audio signals transmitted via coaxial digital audio cables.

##### DIGITAL AUDIO OPTICAL jacks

For digital audio signals transmitted via optical digital audio cables.

#### Notes

- You can use the digital jacks to input PCM, Dolby Digital and DTS bitstreams. When you connect components to both the COAXIAL and OPTICAL jacks, priority is given to the signals input at the COAXIAL jack. All digital input jacks are compatible with 96-kHz sampling digital signals.
- Pull out the cap from the optical jack before you connect the fiber optic cable. Do not discard the cap. When you are not using the optical jack, be sure to put the cap back in place. This cap protects the jack from dust.

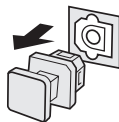

#### ■ Video jacks

This unit has three types of video jacks. Connection depends on the availability of input jacks on your video monitor.

##### VIDEO jacks

For conventional composite video signals transmitted via composite video cables.

##### S VIDEO jacks

For S-video signals, separated into the luminance (Y) and chrominance (C) video signals transmitted on separate wires of S-video cables.

##### COMPONENT VIDEO jacks

For component video signals, separated into the luminance (Y) and chrominance (P<sub>B</sub>, P<sub>R</sub>) video signals transmitted on separate wires of component video cables.



When "VIDEO CONV." is set to "ON" (see page 86), the video signals input at the VIDEO and S VIDEO jacks are converted and output at the VIDEO, S VIDEO and COMPONENT VIDEO jacks interchangeably.

## Audio and video signal flow

### ■ Audio signal flow for AUDIO OUT (REC)

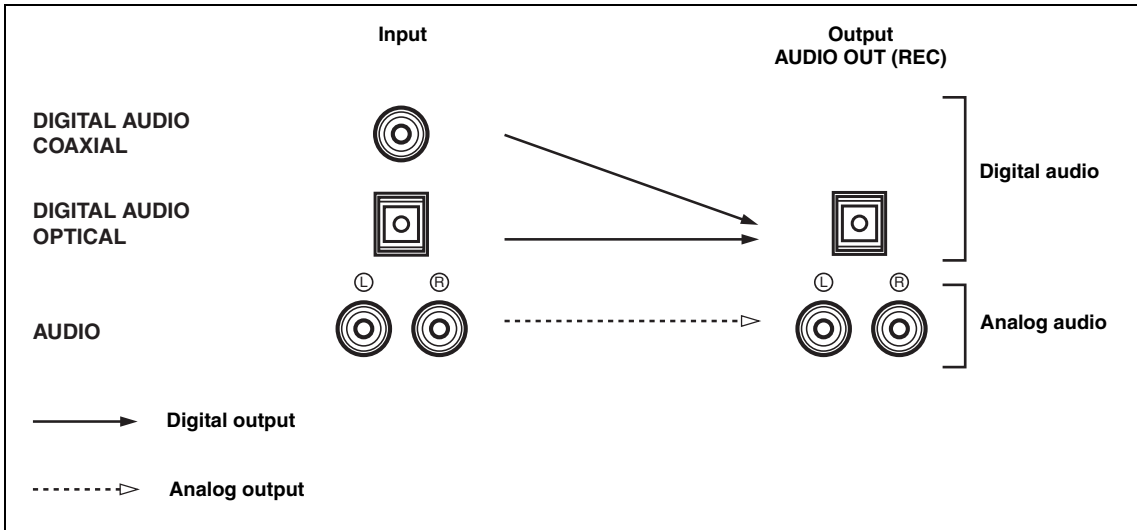

PREPARATION

#### Note

This unit handles digital and analog signals independently. Thus, audio signals input at the analog jacks are output only at the analog AUDIO OUT (REC) jacks. Likewise, audio signals input at the DIGITAL INPUT (OPTICAL or COAXIAL) jacks are output only at the DIGITAL OUTPUT jack.

### ■ Video signal flow for MONITOR OUT

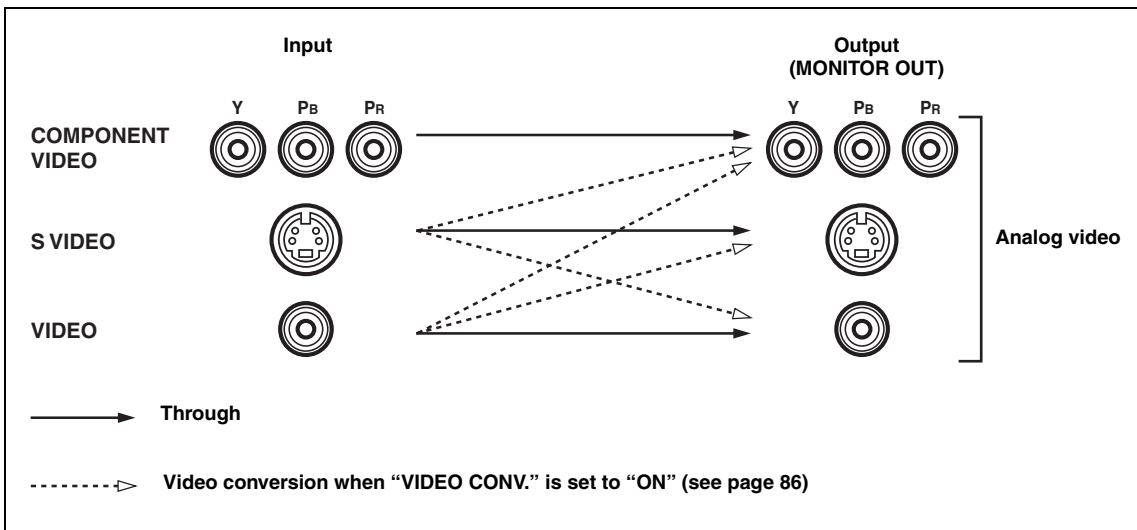

#### Note

If video signals are input at the COMPONENT VIDEO, S VIDEO and VIDEO jacks simultaneously when "VIDEO CONV." is set to "ON", the priority order of the input signals is as follows:  
 COMPONENT VIDEO > S VIDEO > VIDEO

## Connecting a TV

Connect your TV to the VIDEO MONITOR OUT jack, the S VIDEO MONITOR OUT jack or the COMPONENT VIDEO MONITOR OUT jacks of this unit.

### CAUTION

Do not connect this unit or other components to the AC power supply until all connections between components are complete.

(U.S.A. model)

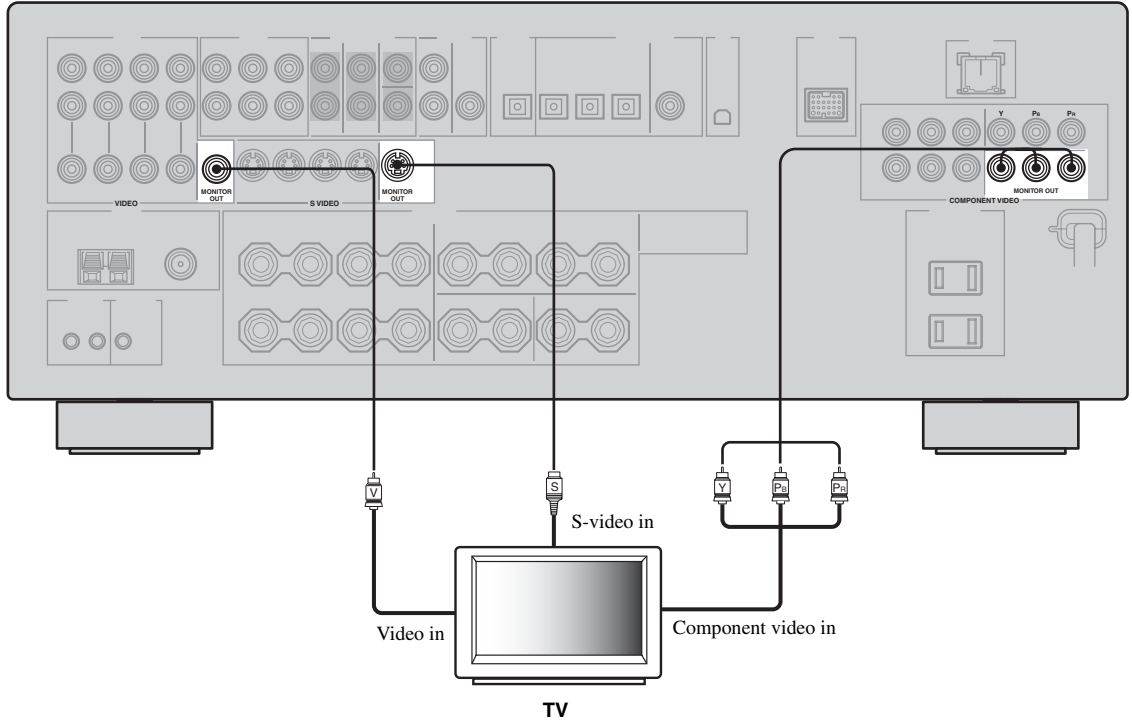

## Connecting a DVD player, a DVD recorder, a VCR or an STB

Connect your DVD player, DVD recorder, VCR or STB (set-top box) using the same type of video connections as those made for your TV (see page 18). The cable TV receiver and the satellite receiver are examples of the STB.

### CAUTION

**Do not connect this unit or other components to the AC power supply until all connections between components are complete.**

### Notes

- When “VIDEO CONV.” is set to “OFF” (see page 86), be sure to make the same type of video connections as those made for your TV (see page 18). For example, if you connected your TV to the VIDEO MONITOR OUT jack of this unit, connect your other components to the VIDEO jacks.
- When “VIDEO CONV.” is set to “ON” (see page 86), the converted video signals are output only at the MONITOR OUT jacks. When recording a source, you must make the same type of video connections between each component.
- To make a digital connection to a component other than the default component assigned to each DIGITAL INPUT or DIGITAL OUTPUT jack, select the corresponding setting for “OPTICAL OUT”, “OPTICAL IN”, or “COAXIAL IN” in “I/O ASSIGNMENT” (see page 82).
- If you connect your DVD player to both the DIGITAL INPUT (OPTICAL) and the DIGITAL INPUT (COAXIAL) jacks, priority is given to the signals input at the DIGITAL INPUT (COAXIAL) jack.

### ■ Connecting a DVD player

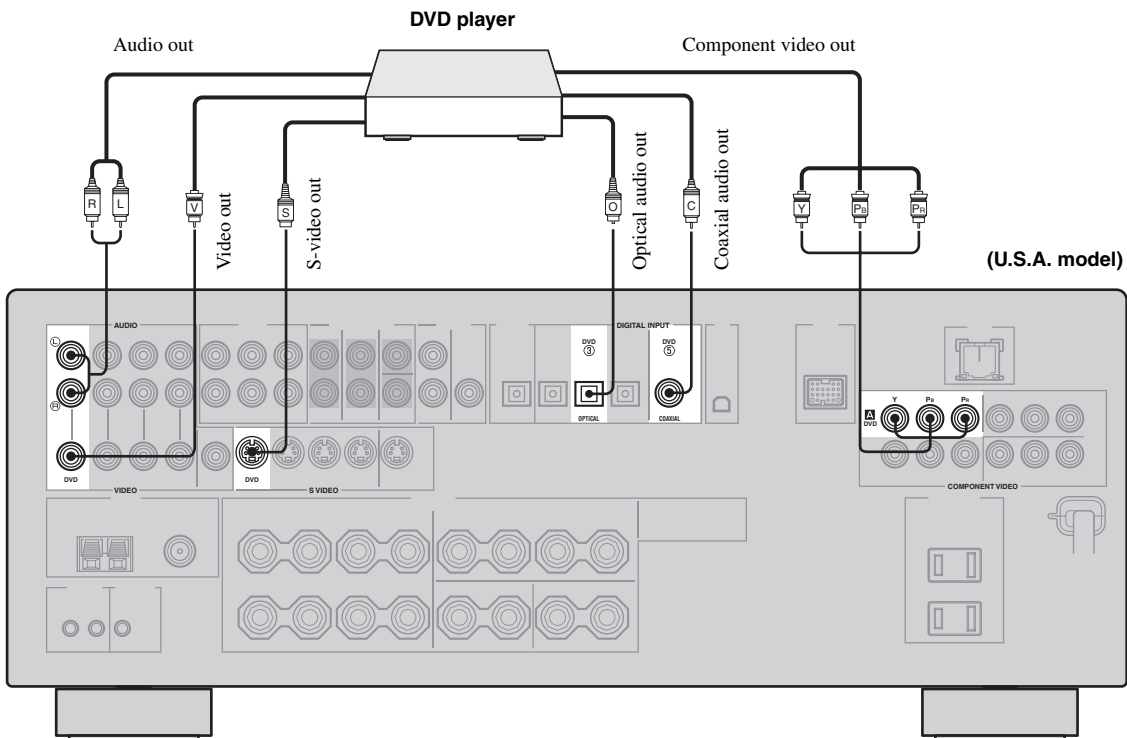

■ Connecting a DVD recorder or a VCR

(U.S.A. model)

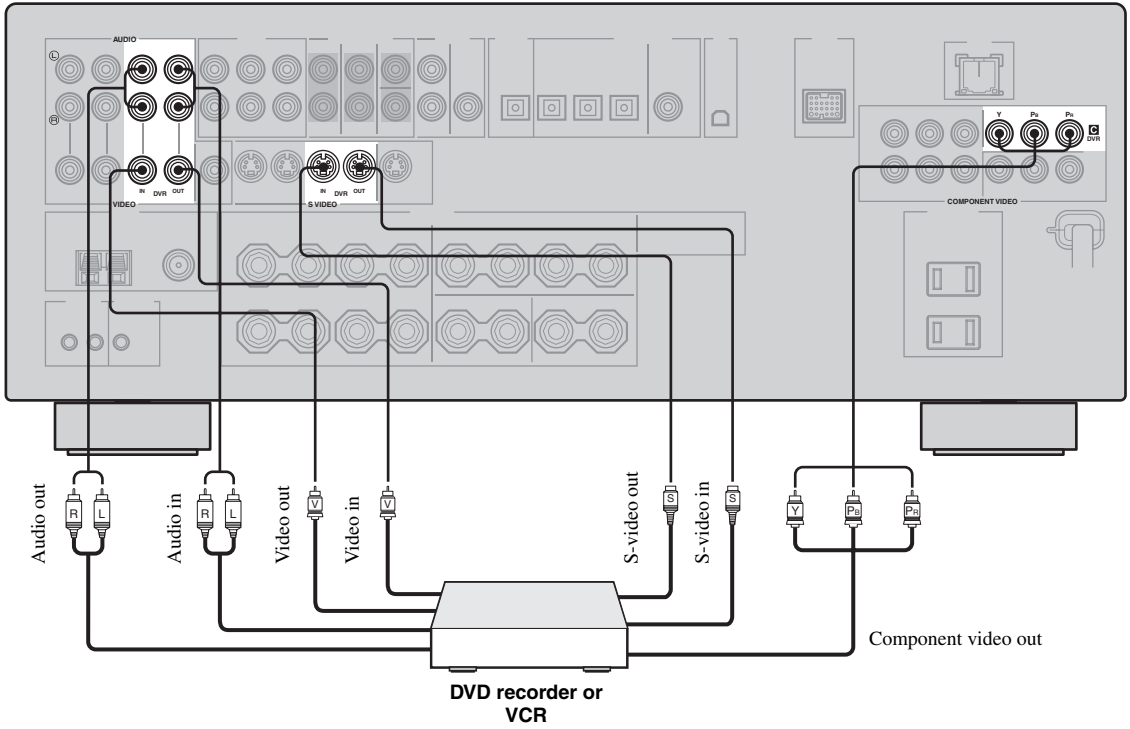

■ Connecting an STB

Cable TV receiver or satellite receiver

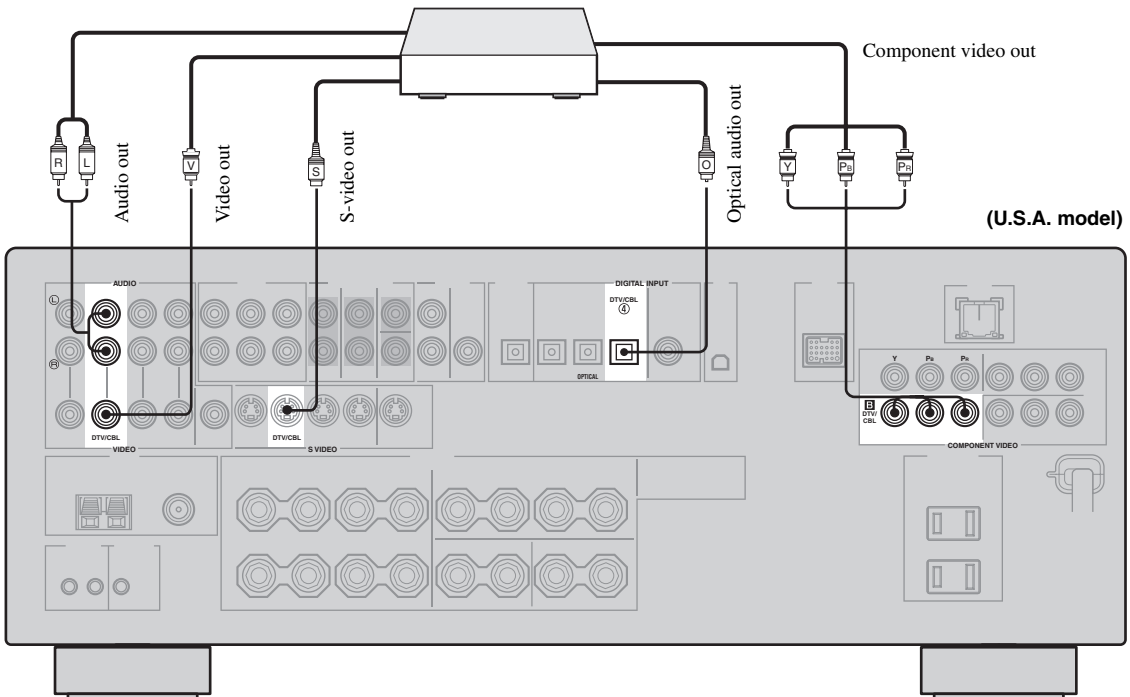

(U.S.A. model)



## Connecting a CD player, an MD player or a tape deck

Connect your CD player, MD player or tape deck via analog and/or digital connections.

### CAUTION

**Do not connect this unit or other components to the AC power supply until all connections between components are complete.**

### Note

To make a digital connection to a component other than the default component assigned to each DIGITAL INPUT or DIGITAL OUTPUT jack, select the corresponding setting for "OPTICAL OUT", "OPTICAL IN", or "COAXIAL IN" in "I/O ASSIGNMENT" (see page 82).

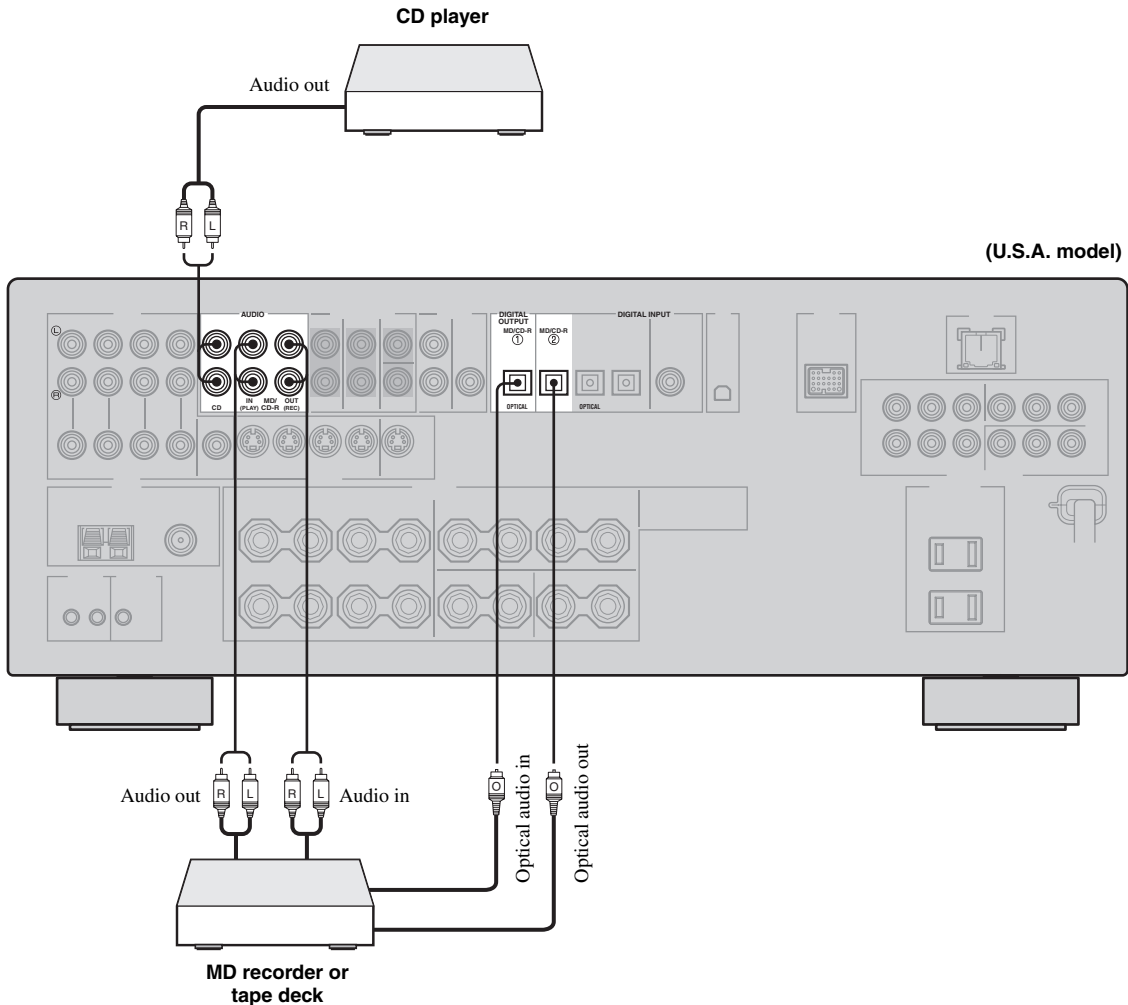

PREPARATION

## Connecting a YAMAHA iPod universal dock

This unit is equipped with the DOCK terminal on the rear panel that allows you to connect a YAMAHA iPod universal dock (such as YDS-10 sold separately) where you can station your iPod and control playback of your iPod using the supplied remote control. Connect a YAMAHA iPod universal dock (such as YDS-10 sold separately) to the DOCK terminal on the rear panel of this unit using its dedicated cable. Once the connection is complete, station your iPod in the YAMAHA iPod universal dock.

### CAUTION

**Do not connect this unit or other components to the AC power supply until all connections between components are complete.**

### Notes

- Only iPod (Click and Wheel), iPod nano, and iPod mini are supported.
- You need a YAMAHA iPod universal dock (such as YDS-10 sold separately) and its dedicated cable compatible with the DOCK terminal of this unit.
- Do not connect any iPod accessories (such as headphones, a wired remote control, or an FM transmitter) to your iPod when it is stationed in a YAMAHA iPod universal dock (such as YDS-10 sold separately).
- Once your iPod is stationed in a YAMAHA iPod universal dock (such as YDS-10 sold separately) connected to the DOCK terminal of this unit, this unit begins the signal transmission with your iPod.
- Unless your iPod is firmly stationed in a YAMAHA iPod universal dock (such as YDS-10 sold separately) connected to the DOCK terminal of this unit, audio and/or video signals may not be output properly.
- Once the connection between your iPod and this unit is complete, "iPod connected" appears in the front panel display and the DOCK indicator lights up in the front panel display. If the connection between your iPod and this unit fails, a status message appears in the front panel display. For a complete list of connection status messages, see the iPod section in "TROUBLESHOOTING" on page 113.
- Only analog audio and video signals of your iPod are input at the DOCK terminal, and the analog audio signals can be output at the analog AUDIO OUT (REC) jacks for recording.
- Your iPod battery is automatically charged when your iPod is stationed in a YAMAHA iPod universal dock (such as YDS-10 sold separately) connected to the DOCK terminal of this unit as long as this unit is turned on.
- Depending on the type of iPod, you may need to insert one of the iPod adapters supplied with a YAMAHA iPod universal dock (such as YDS-10 sold separately) into the dock slot before you station your iPod.

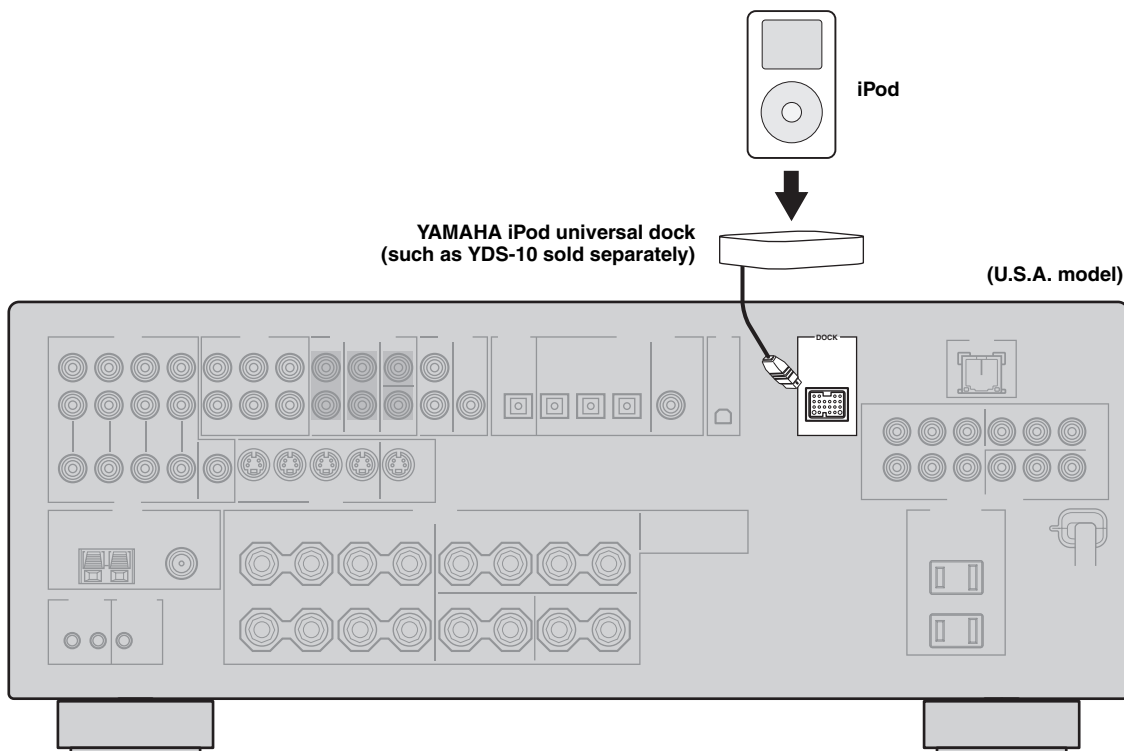

## Connecting the network

To connect this unit to your network, plug one end of a network cable (CAT-5 or higher straight cable) into the LAN port of this unit, and plug the other end into one of the LAN ports on your router that supports the DHCP (Dynamic Host Configuration Protocol) server function. The following diagram shows a connection example where this unit is connected to one of the LAN ports on a 4-port router. To enjoy music files saved on your PC and YAMAHA MCX-2000 or access the Internet radio, each device must be connected properly in the network.

### Note

If the DHCP server function on your router is disabled, you need to configure the network settings manually (see page 84).

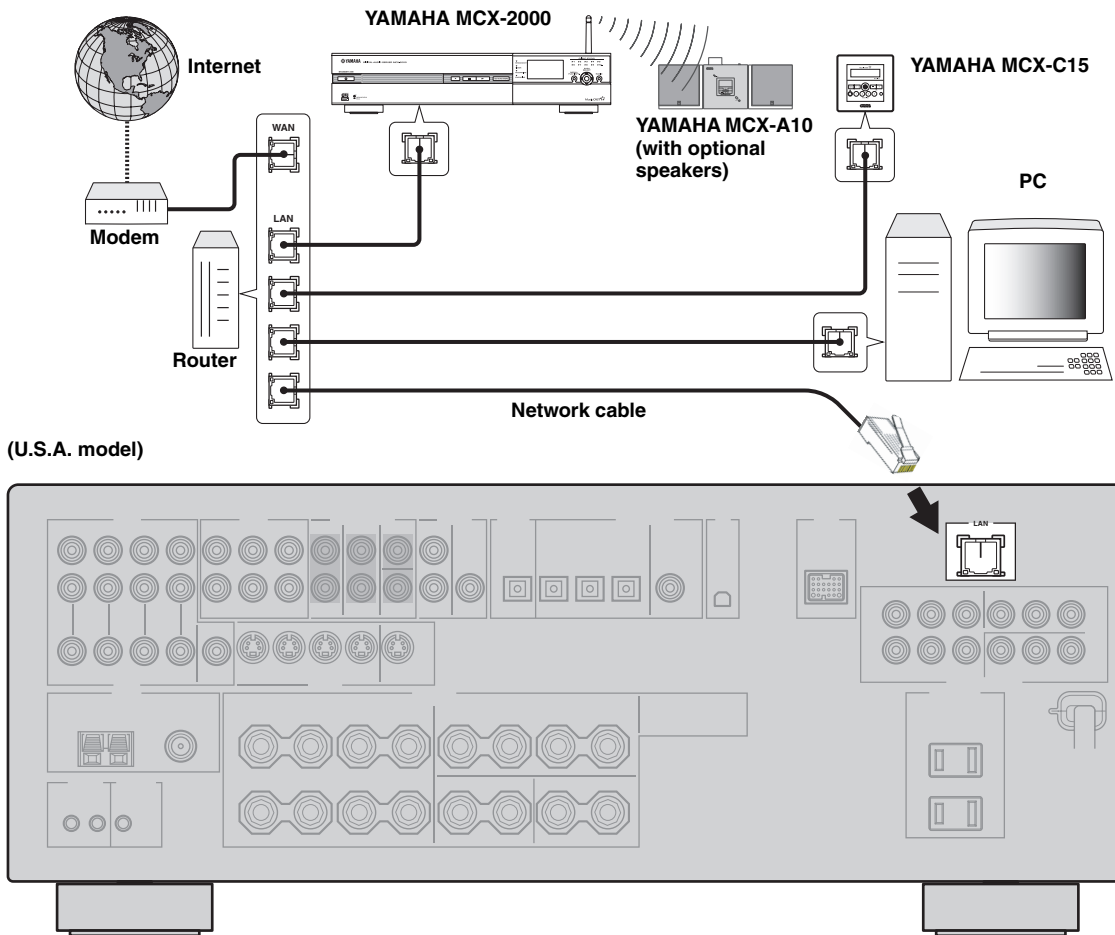

PREPARATION

## Connecting a multi-format player, an external decoder or a sound processor

This unit is equipped with 6 additional input jacks (FRONT L/R, CENTER, SURROUND L/R and SUBWOOFER) for discrete multi-channel input from a multi-format player, external decoder or sound processor. Connect the output jacks on your multi-format player, external decoder or sound processor to the MULTI CH INPUT jacks. Be sure to match the left and right output jacks to the left and right input jacks for the front and surround channels.

### CAUTION

**Do not connect this unit or other components to the AC power supply until all connections between components are complete.**

### Notes

- When you select the component connected to the MULTI CH INPUT jacks as the input source (see page 38), this unit automatically turns off the digital sound field processor, and you cannot select sound field programs.
- This unit does not redirect signals input at the MULTI CH INPUT jacks to accommodate for missing speakers. We recommend that you connect at least a 5.1-channel speaker system before using this feature.
- When headphones are used, only the signals input at the FRONT L/R jacks are output at the PHONES jack.

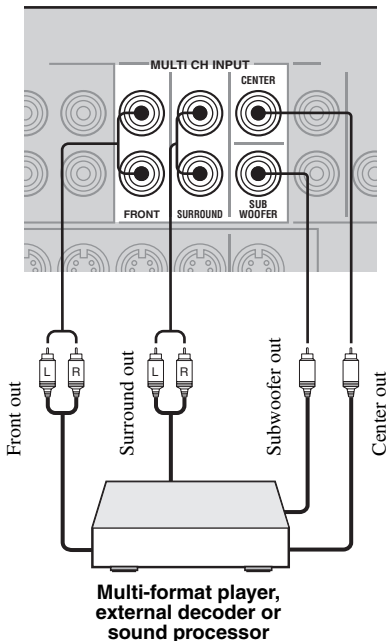

## Connecting a game console, a video camera or a portable audio player

Use the VIDEO AUX jacks on the front panel to connect a game console, a video camera or a portable audio player to this unit.

### CAUTION

**Be sure to turn off the volume of this unit and other components before making connections.**

### Note

The audio signals input at the DOCK terminal takes priority over the ones input at the VIDEO AUX jacks.

(U.S.A. model)

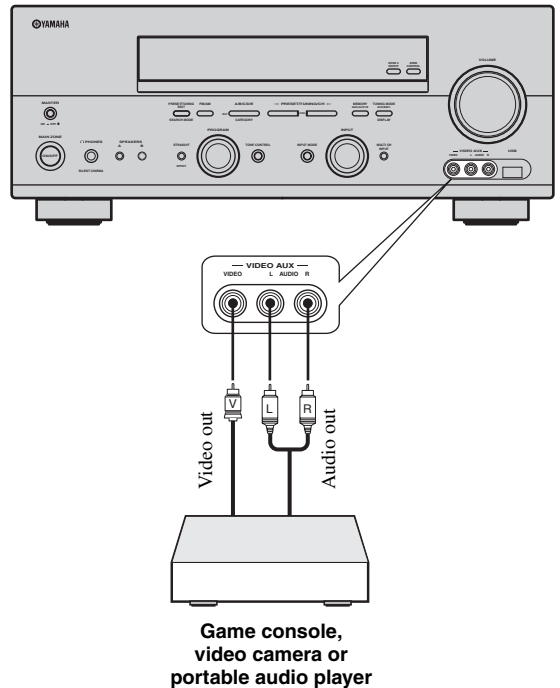

## Connecting the FM and AM antennas

Both FM and AM indoor antennas are supplied with this unit. In general, these antennas should provide sufficient signal strength. Connect each antenna correctly to the designated terminals.

### Notes

- Be sure to set the tuner frequency step (General model only) according to the frequency spacing in your area (see page 92).
- The AM loop antenna should be placed away from this unit.
- The AM loop antenna should always be connected, even if an outdoor AM antenna is connected to this unit.
- A properly installed outdoor antenna provides clearer reception than an indoor one. If you experience poor reception quality, install an outdoor antenna. Consult the nearest authorized YAMAHA dealer or service center about outdoor antennas.

### AM loop antenna (supplied)

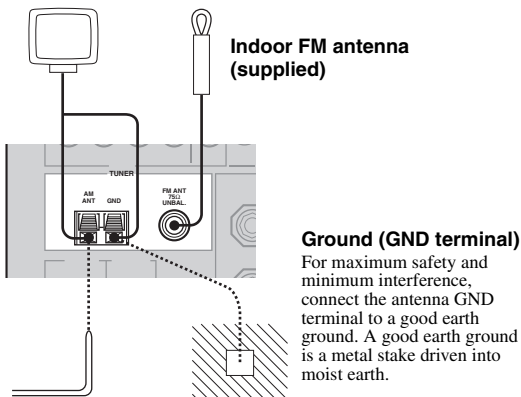

### Outdoor AM antenna

Use a 5 to 10 m (16 to 32 ft) of vinyl-covered wire extended from a window.

## ■ Connecting the AM loop antenna

### 1 Set up the AM loop antenna.

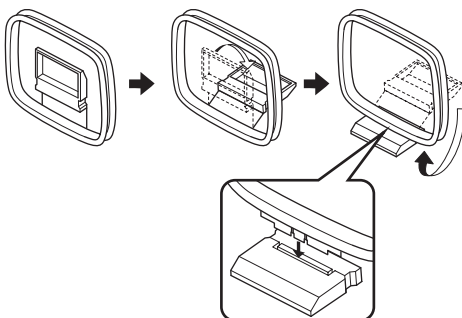

### 2 Press and hold the tab of the AM ANT terminal.



### 3 Insert one of the AM loop antenna lead wires into the AM ANT terminal.

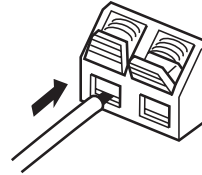

### 4 Release the tab of the AM ANT terminal back into place.



### 5 Repeat steps 2 through 4 to connect the other lead wire to the GND terminal.



Once you have properly connected the AM loop antenna to this unit, orient the AM loop antenna for the best reception when you tune into AM stations.

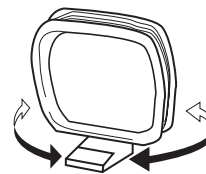

## Connecting the power cable

Once all connections are complete, plug the power cable into the AC wall outlet.

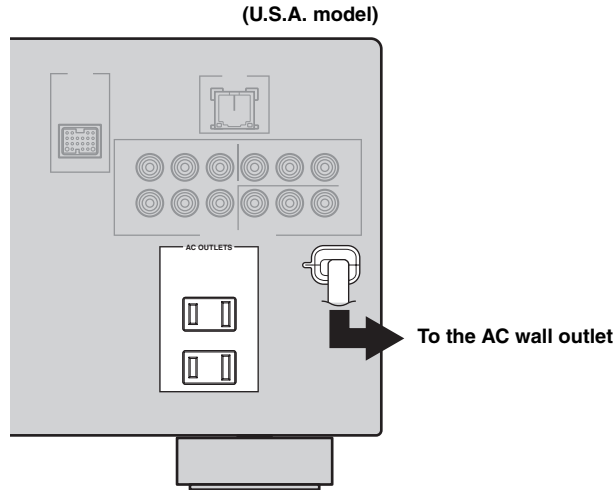

### ■ VOLTAGE SELECTOR (General model only)

#### CAUTION

The **VOLTAGE SELECTOR** on the rear panel of this unit must be set for your local voltage **BEFORE** plugging the power cable into the AC wall outlet. Improper setting of the **VOLTAGE SELECTOR** may cause damage to this unit and create a potential fire hazard.

Rotate the **VOLTAGE SELECTOR** clockwise or counterclockwise to the correct position using a straight slot screwdriver.

Voltages are 110/120/220/230–240 V AC, 50/60 Hz.

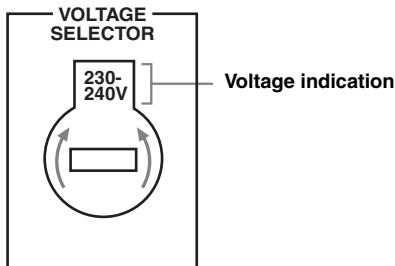

### ■ AC OUTLET(S) (SWITCHED)

Australia model.....	1 outlet
Korea model.....	None
Other models.....	2 outlets

Use these outlet(s) to supply power to any connected components. Connect the power cable of your other components to these outlet(s). Power to these outlet(s) is supplied when the main zone or Zone 2 is turned on. However, power to these outlet(s) is cut off when both the main zone and Zone 2 are turned off or when MASTER ON/OFF on the front panel is pressed and released outward to the OFF position. For information on the maximum power or the total power consumption of the components that can be connected to these outlet(s), see “SPECIFICATIONS” on page 119.

#### Memory back-up

The memory back-up circuit prevents the stored data from being lost even if this unit is in the standby mode. However, the stored data will be lost in case the power cable is disconnected from the AC wall outlet or if the power supply is cut off for more than one week.

## Setting the speaker impedance

### CAUTION

If you are to use 6 ohm speakers, set “SP IMP.” to “6ΩMIN” as follows BEFORE using this unit. 4 ohm speakers can be also used as the front speakers.

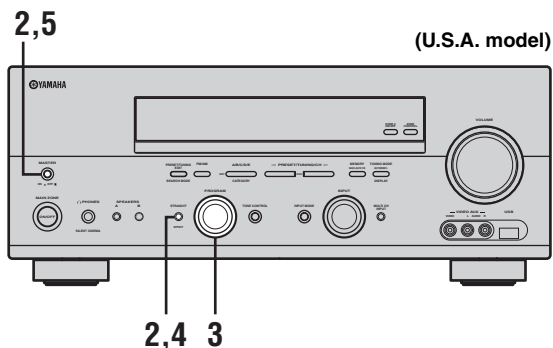

- Press **STRAIGHT (EFFECT)** on the front panel repeatedly to select “6ΩMIN”. The following display appears in the front panel display.

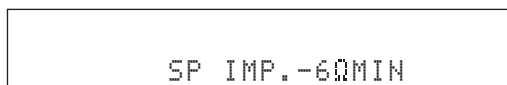

- Press **MASTER ON/OFF** on the front panel to release it outward to the OFF position to save the new setting and turn off this unit.



- Make sure this unit is turned off.**  
See page 28 for details about turning on or off this unit.

- Press and hold **STRAIGHT (EFFECT)** on the front panel and then press **MASTER ON/OFF** inward to the ON position to turn on this unit. This unit turns on, and the advanced setup menu appears in the front panel display.

While holding down



### Note

The setting you made is reflected next time you turn on this unit.

- Rotate the **PROGRAM** selector on the front panel to select “SP IMP.”. The following display appears in the front panel display.

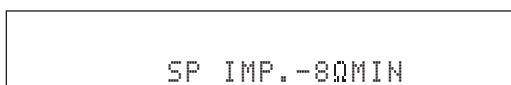
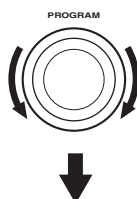

## Turning on and off the power

When all connections are complete, turn on this unit.

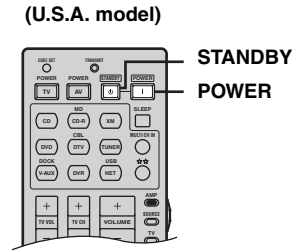
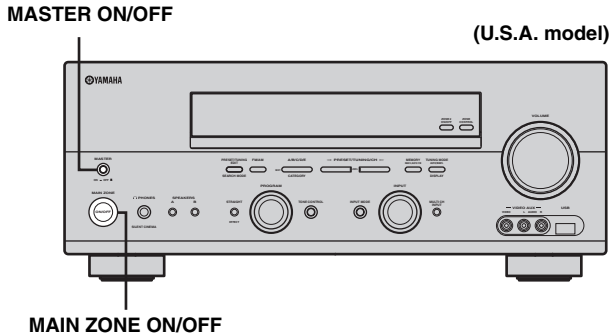

### ■ Turning on this unit

Press **MASTER ON/OFF** on the front panel inward to the **ON** position to turn on this unit.



### ■ Turning off this unit

Press **MASTER ON/OFF** on the front panel to release it outward to the **OFF** position to turn off this unit.



- Press **MAIN ZONE ON/OFF** on the front panel (or **STANDBY** on the remote control) to set the main zone to the standby mode.

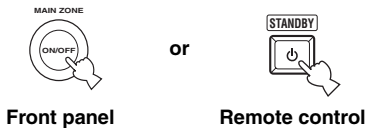

- Press **MAIN ZONE ON/OFF** on the front panel (or **POWER** on the remote control) to turn on the main zone.

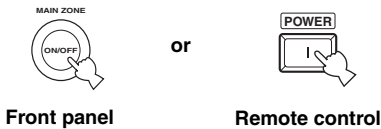

### Note

MAIN ZONE ON/OFF on the front panel as well as POWER and STANDBY on the remote control are operational only when MASTER ON/OFF is pressed inward to the ON position.



For details about turning on or off Zone 2, see page 99



# BASIC SETUP

The “BASIC SETUP” feature is a useful way to set up your system quickly and with minimal effort.

## Notes

- Make sure you disconnect your headphones from this unit.
- If you wish to configure this unit manually using more precise adjustments, use the detailed parameters in “SOUND MENU” (see page 77).
- Altering any parameters in “BASIC SETUP” resets all parameters manually adjusted in “SOUND MENU” (see page 77).
- Initial settings are indicated in bold under each parameter.
- Press RETURN on the remote control to return to the previous menu level.

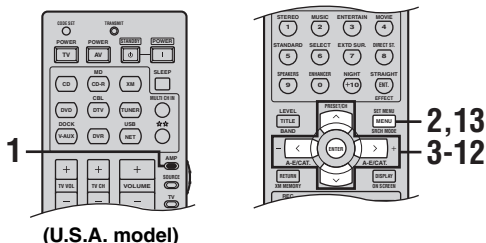

**1** Set the component selector switch to AMP.

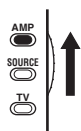

**2** Press SET MENU to enter “SET MENU”.

The top “SET MENU” display appears in the OSD.

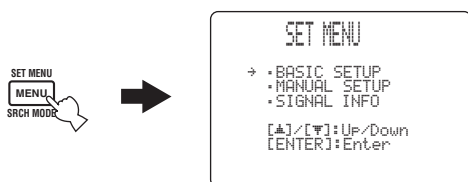

**3** Press ^/∨ to select “BASIC SETUP”.

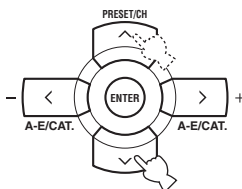

**4** Press ENTER to enter “BASIC SETUP”.

The following display appears in the OSD.

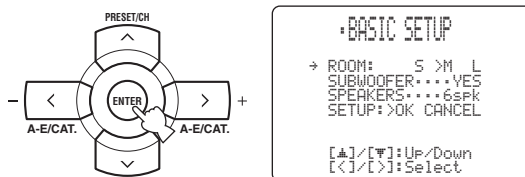

**5** Press ^/∨ to select “ROOM” and then </> to select the desired setting.

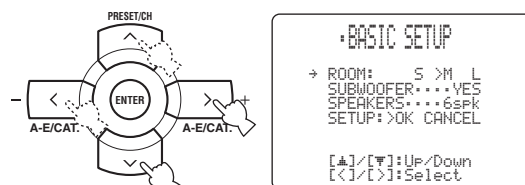

Select the size of the room where you have installed your speakers. In general, the room sizes are defined as follows:

Choices: **S, M, L**

[U.S.A. and Canada models]

S (small) 16 x 13ft, 200ft<sup>2</sup> (4.8 x 4.0m, 20m<sup>2</sup>)

M (medium) 20 x 16ft, 300ft<sup>2</sup> (6.3 x 5.0m, 30m<sup>2</sup>)

L (large) 26 x 19ft, 450ft<sup>2</sup> (7.9 x 5.8m, 45m<sup>2</sup>)

[Other models]

S (small) 3.6 x 2.8m, 10m<sup>2</sup>

M (medium) 4.8 x 4.0m, 20m<sup>2</sup>

L (large) 6.3 x 5.0m, 30m<sup>2</sup>

**6** Press  $\downarrow$  to select “SUBWOOFER” and then  $\langle / \rangle$  to select the desired setting.

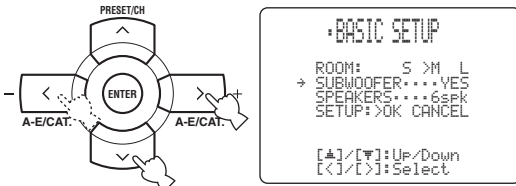

Choices: **YES**, NONE

- Select “YES” if you have a subwoofer in your system.
- Select “NONE” if you do not have a subwoofer in your system.

**7** Press  $\downarrow$  to select “SPEAKERS” and then  $\langle / \rangle$  to select the number of speakers connected to this unit.

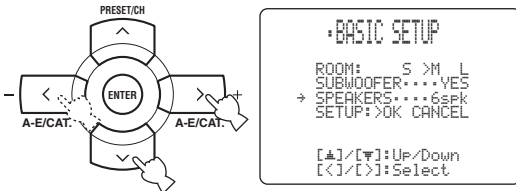

Choice	Display	Speakers
2spk	<b>L</b> <b>R</b>	Front L/R
3spk	<b>L</b> <b>C</b> <b>R</b>	Front L/R, Center
4spk	<b>L</b> <b>R</b> <b>SL</b> <b>SR</b>	Front L/R, Surround L/R
5spk	<b>L</b> <b>C</b> <b>R</b> <b>SL</b> <b>SR</b>	Front L/R, Center, Surround L/R
6spk	<b>L</b> <b>C</b> <b>R</b> <b>SL</b> <b>SB</b> <b>SR</b>	Front L/R, Center, Surround L/R, Surround back

**8** Press  $\downarrow$  to select “SETUP” and then  $\langle / \rangle$  to select the desired setting.

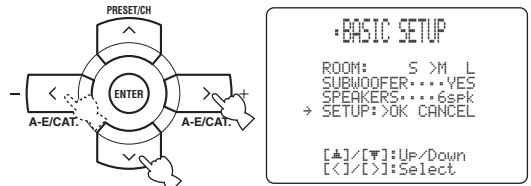

Choices: **OK**, CANCEL

- Select “OK” to apply the settings you made.
- Select “CANCEL” to cancel the setup procedure without making any changes.



You can also press SET MENU to cancel the setup procedure.

**9** Press ENTER to confirm your selection.

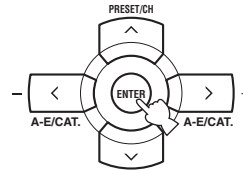

If you selected “OK” in step 8, each speaker outputs a test tone twice in turn. “CHECK:Test Tone” appears in the OSD for a few seconds and then “CHECK OK?” appears in the OSD.



Check the speaker connections (see page 13) and adjust the “SPEAKERS” settings back in step 7, if necessary.

**10 Press </> to select the desired setting.**

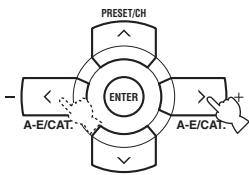

Choices: **YES, NO**

- Select “YES” to complete the setup procedure if the test tone levels from each speaker were satisfactory.
- Select “NO” to proceed to the speaker level adjustment menu in step 12 to balance the output level of each speaker.

**11 Press ENTER to confirm your selection.**

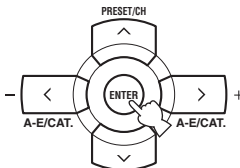

- If you selected “YES” in step 10, the setup procedure is completed and the display returns to the top “SET MENU” display.
- If you selected “NO” in step 10, the speaker level adjustment display appears in the front panel display.

**12 Press ^/∨ to select a speaker and then </> to adjust the balance.**

The selected speaker and the front left speaker (or the surround left speaker) output a test tone in turn.

- Press > to increase the value.
- Press < to decrease the value.

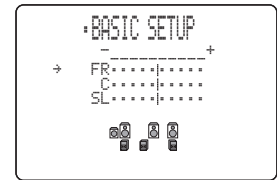
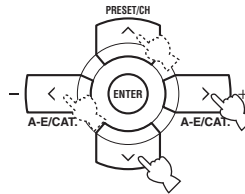

- Select “FR” to adjust the balance between the front left and right speakers.
- Select “C” to adjust the balance between the front left and center speakers.
- Select “SL” to adjust the balance between the front left and surround left speakers.
- Select “SB” to adjust the balance between the surround left and surround back speakers.
- Select “SR” to adjust the balance between the surround left and surround right speakers.
- Select “SWFR” to adjust the balance between the front left speaker and the subwoofer.

**13 Press SET MENU to exit from “BASIC SETUP”.**



# PLAYBACK

## CAUTION

Extreme caution should be exercised when you play back CDs encoded in DTS. If you play back a CD encoded in DTS on a DTS-incompatible CD player, you will only hear some unwanted noise that may damage your speakers. Check whether your CD player supports CDs encoded in DTS. Also, check the sound output level of your CD player before you play back a CD encoded in DTS.

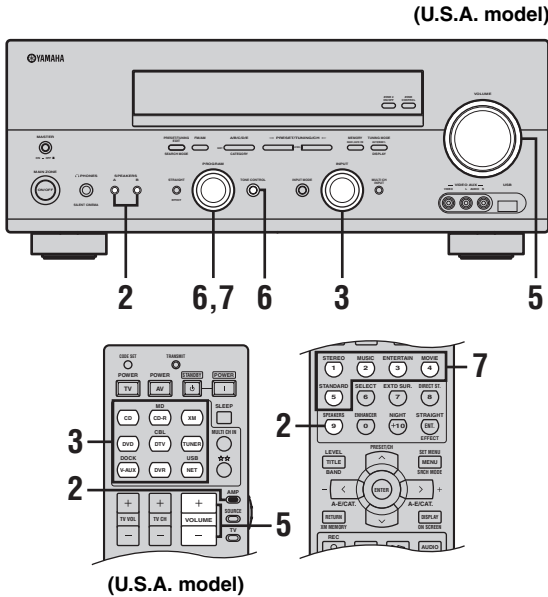

**1** Turn on the video monitor connected to this unit.

**2** Press **SPEAKERS A** or **B** on the front panel (or set the component selector switch to **AMP** and then press **SPEAKERS** on the remote control repeatedly) to turn on the set of front speakers you want to use.

Each time you press **SPEAKERS A** or **B**, the respective set of front speakers are turned on or off.

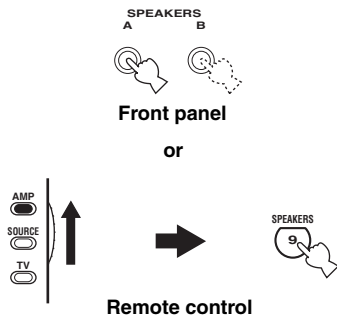

**3** Rotate the **INPUT** selector on the front panel (or press one of the input selector buttons on the remote control) to select the desired input source.

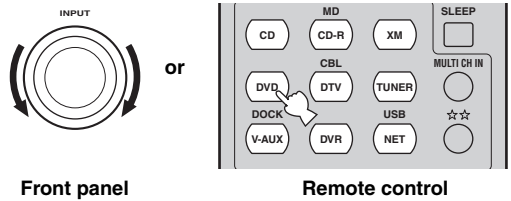

The name of the currently selected input source appears in the front panel display and in the OSD for a few seconds.

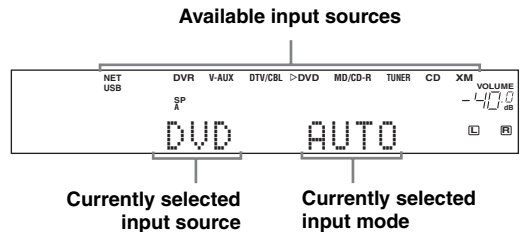

## Notes

- To enjoy multi-channel sources in surround, connect the source component via digital connection and set the input mode to "AUTO" or "DTS" (see page 35).
- See page 42 for details about surround sound.

**4** Start playback on the selected source component or select a broadcast station.

- Refer to the operating instructions for the source component.
- See page 46 for details about tuning instructions.
- See page 53 for details about XM Satellite Radio tuning instructions.

- 5 Rotate **VOLUME** on the front panel (or press **VOLUME +/-** on the remote control) to adjust the volume to the desired output level.

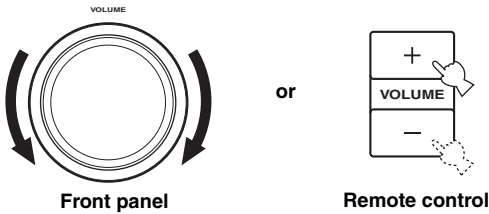

Front panel

Remote control

- 6 Press **TONE CONTROL** on the front panel repeatedly to select “**TREBLE**” or “**BASS**” and then rotate the **PROGRAM** selector to adjust the corresponding frequency response level.

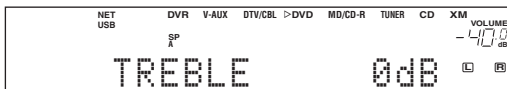
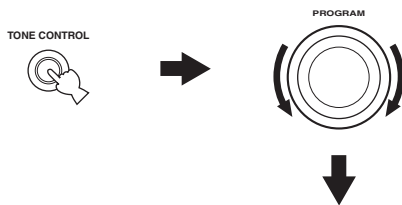

- Select “**TREBLE**” to adjust the high-frequency response.
- Select “**BASS**” to adjust the low-frequency response.

#### Notes

- Speaker and headphone adjustments are stored independently.
- When “**TONE BYPASS**” is set to “**AUTO**” (see page 81), and “**BASS**” and “**TREBLE**” are set to 0 dB, audio output automatically bypasses the tone control circuitry of this unit.
- If you increase or decrease the high-frequency or low-frequency sound to an extreme level, the tonal quality of the front speakers may not match that of the other speakers.
- **TONE CONTROL** is not effective when the “**DIRECT STEREO**” mode (see page 39) is selected or when the component connected to the **MULTI CH INPUT** jacks is selected as the input source (see page 38).

- 7 Rotate the **PROGRAM** selector on the front panel (or press one of the sound field program selector buttons on the remote control repeatedly) to select the desired sound field program.

The name of the selected sound field program appears in the front panel display and in the OSD.

See page 66 for details about sound field programs.



Front panel

or

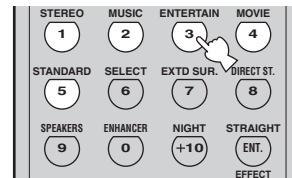

Remote control

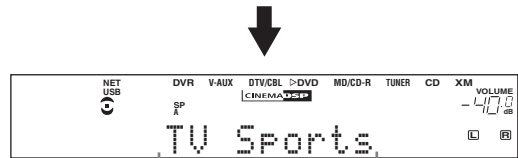

Currently selected sound field program

#### Notes

- Choose a sound field program based on your listening preference, not merely on the name of the program.
- When you select an input source, this unit automatically selects the last sound field program used with the corresponding input source.
- Sound field programs cannot be selected when the component connected to the **MULTI CH INPUT** jacks is selected as the input source (see page 38).
- Sampling frequencies higher than 48 kHz (except for DTS 96/24 signals) are sampled down to 48 kHz and then sound field programs are applied.
- To display information about the currently selected input source in the OSD, see page 40 for details.

# USING AUDIO FEATURES

## Using SILENT CINEMA

SILENT CINEMA allows you to enjoy multi-channel music or movie sound, including Dolby Digital and DTS sources, through ordinary headphones. SILENT CINEMA activates automatically whenever you connect headphones to the PHONES jack while listening to a source with a CINEMA DSP or HiFi DSP sound field program (see page 66). When activated, the SILENT CINEMA indicator lights up in the front panel display.

### Notes

- SILENT CINEMA does not activate when the component connected to the MULTI CH INPUT jacks is selected as the input source (see page 38).
- SILENT CINEMA is not effective when the “DIRECT STEREO” (see page 39), “2ch Stereo” (see page 39) or “STRAIGHT” mode (see page 39) is selected.

## Muting the audio output

Press **MUTE** on the remote control to mute the audio output. Press **MUTE** again to resume the audio output.



- You can also rotate VOLUME on the front panel or VOLUME +/- on the remote control to resume the audio output.
- You can adjust the muting level by using the “MUTING TYPE” parameter in “SOUND MENU” (see page 81).
- The MUTE indicator flashes in the front panel display when the audio output is muted and disappears from the front panel display when the audio output is resumed.

### Note

If you change the input source or the sound field program with the remote control while the audio output is being muted, this unit resumes the audio output.

## Selecting the night listening mode

The night listening modes are designed to improve listenability at lower volumes or at night. Choose either “NIGHT:CINEMA” or “NIGHT:MUSIC” depending on the type of material you are playing.

- 1 Set the component selector switch to **AMP** and then press **NIGHT** on the remote control repeatedly to select “NIGHT:CINEMA” or “NIGHT:MUSIC”.

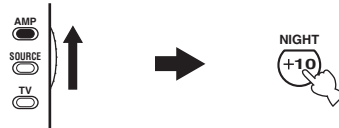

Choices: NIGHT:CINEMA, NIGHT:MUSIC, OFF

- Select “NIGHT:CINEMA” when watching films to reduce the dynamic range of film soundtracks and make dialog easier to hear at lower volumes.
- Select “NIGHT:MUSIC” when listening to music sources to preserve ease-of-listening for all sounds.
- Select “OFF” if you do not want to use this feature.



When a night listening mode is selected, the NIGHT indicator lights up in the front panel display.

- 2 Press **</>** on the remote control to adjust the effect level while “NIGHT:CINEMA” or “NIGHT:MUSIC” is displayed in the front panel display.

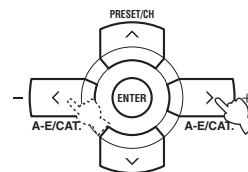

Remote control



Effect.Lvl: MID

Choices: MIN, **MID**, MAX

- Select “MIN” for minimum compression.
- Select “MID” for standard compression.
- Select “MAX” for maximum compression.



“NIGHT:CINEMA” and “NIGHT:MUSIC” adjustments are stored independently.

**Notes**

- You cannot use the night listening modes in the following cases:
  - when the “DIRECT STEREO” mode (see page 39) is selected.
  - when the component connected to the MULTI CH INPUT jacks is selected as the input source (see page 38).
  - when headphones are connected to the PHONES jack.
- The effectiveness of the night listening modes may vary depending on the input source and surround sound settings you use.

**Selecting the input mode**

This unit comes with a variety of input jacks. Do the following to select the type of input signals you want to use.



- We recommend setting “INPUT MODE” to “AUTO” in most cases.
- You can adjust the default input mode of this unit by using the “INPUT MODE” parameter in “INPUT MENU” (see page 83).

**Notes**

- To play DTS-encoded CDs when using a digital audio connection, be sure to set “INPUT MODE” to “DTS”.
- DTS decoding may not be performed correctly depending on the player even if you make a digital connection between this unit and the player.

**1 Rotate the INPUT selector on the front panel to select the desired input source.**

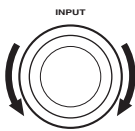

**2 Press INPUT MODE on the front panel repeatedly to select the desired input mode.**

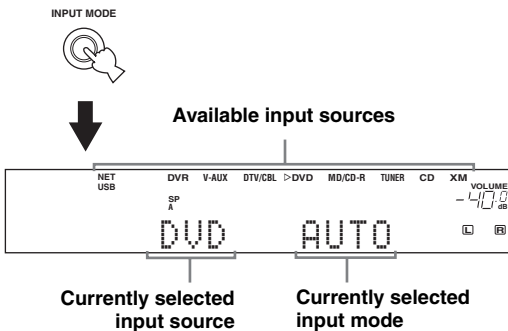

AUTO	Automatically selects input signals in the following order: (1) Digital signals (2) Analog signals
DTS	Selects only digital signals encoded in DTS. If no DTS signals are input, no sound is output.
ANALOG	Selects only analog signals. If no analog signals are input, no sound is output.

**Note**

When “INPUT MODE” is set to “AUTO”, this unit automatically switches to the appropriate decoder if a Dolby Digital or DTS signal is detected.

**Using the sleep timer**

Use this feature to automatically set this unit to the standby mode after a certain amount of time. The sleep timer is useful when you are going to sleep while this unit is playing or recording a source. The sleep timer also automatically turns off any external components connected to AC OUTLET(S) (see page 26).

**1 Press one of the input selector buttons on the remote control to select the desired input source.**

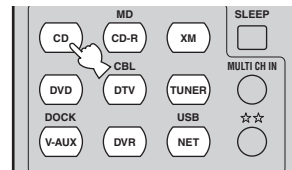

**2 Start playback on the selected source component or select a broadcast station.**

- Refer to the operating instructions for the source component.
- See page 46 for details about tuning instructions.
- See page 53 for details about XM Satellite Radio tuning instructions.

**3 Press SLEEP on the remote control repeatedly to set the amount of time.**

Each time you press SLEEP, the front panel display changes as shown below.

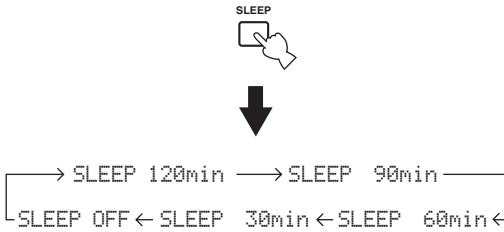

The SLEEP indicator flashes while you are switching the amount of time for the sleep timer. Once the sleep timer is set, the SLEEP indicator lights up in the front panel display, and the display returns to the selected sound field program.

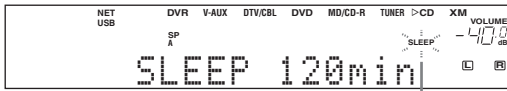

Flashes

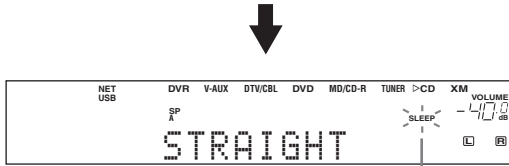

Lights up

**4 To cancel the sleep timer, press SLEEP on the remote control repeatedly until "SLEEP OFF" appears in the front panel display.**

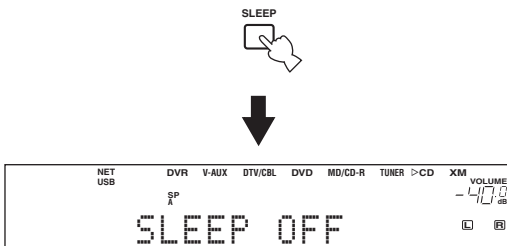

The SLEEP indicator turns off, and "SLEEP OFF" disappears from the front panel display after a few seconds.



The sleep timer setting can also be canceled by pressing MAIN ZONE ON/OFF on the front panel (or STANDBY on the remote control) to set the main zone to the standby mode.

**Adjusting the speaker level**

You can adjust the output level of each speaker while listening to a music source. This is also possible when playing sources input at the MULTI CH INPUT jacks.

**Note**

This operation will override the level adjustments made in "BASIC SETUP" (see page 29) and "SPEAKER LEVEL" (see page 79).

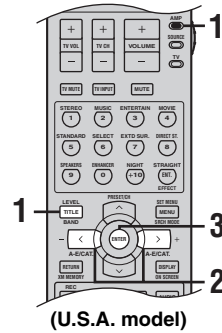

(U.S.A. model)

**1 Set the component selector switch to AMP and then press LEVEL on the remote control repeatedly to select the speaker you want to adjust.**

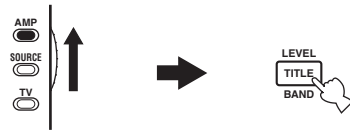

- Select "FRONT L" to adjust the front left speaker output level.
- Select "CENTER" to adjust the center speaker output level.
- Select "FRONT R" to adjust the front right speaker output level.
- Select "SUR. R" to adjust the surround right speaker output level.
- Select "SUR. B" to adjust the surround back speaker output level.
- Select "SUR. L" to adjust the surround left speaker output level.
- Select "SWFR" to adjust the subwoofer output level.



Once you press LEVEL on the remote control, you can also select the speaker by pressing ^ / v.



**2 Press </> on the remote control to adjust the speaker output level.**

- Press > to increase the value.
- Press < to decrease the value.

Control range: -10 dB to +10 dB

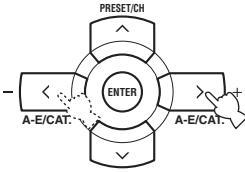

This operation can also be performed using the control buttons on the front panel. Press NEXT on the front panel repeatedly to select the speaker channel whose output level you want to adjust and then press LEVEL on the front panel to adjust the output level.

## Selecting the Compressed Music Enhancer mode

Compression artifacts (such as the MP3 format) are created by a lossy compression scheme where the audio is resampled to lower the bitrate and to remove sounds that are indistinguishable to typical human hearing. The Compressed Music Enhancer feature of this unit enhances your listening experience by regenerating the missing harmonics in a compression artifact. As a result, flattened complexity due to the loss of high-frequency fidelity as well as lack of bass due to the loss of low-frequency bass is compensated, providing the improved performance of the overall sound system.

### Notes

- The Compressed Music Enhancer mode is compatible with the PCM signals (48 kHz), the analog 2-channel input sources and the music data input at the USB port or the LAN port.
- The Compressed Music Enhancer mode is not effective with any of the sound field programs.
- When the Compressed Music Enhancer mode is turned on while an incompatible input source is being played back, “Not Available” appears in the front panel display and in the OSD.
- When the input source is changed to an incompatible input source while the Compressed Music Enhancer mode is turned on, the Compressed Music Enhancer mode is automatically turned off and the incompatible input source is played back in 2-channel or 6-channel stereo.



The ENHANCER indicator lights up in the front panel display when one of the Compressed Music Enhancer modes is selected.

**1 Set the component selector switch to AMP and then press ENHANCER on the remote control repeatedly to select the desired Compressed Music Enhancer mode.**

The following display appears in the OSD and the ENHANCER indicator lights up in the front panel display.

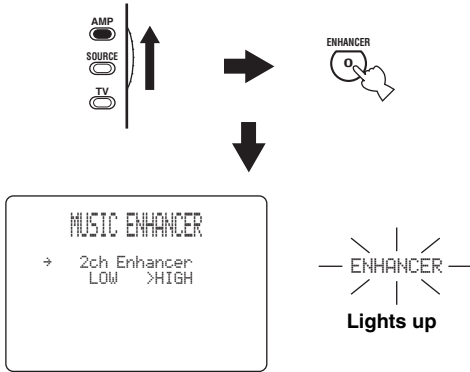

Choices: **2ch Enhancer**, 6ch Enhancer, Off (previously selected sound field program)

- Select “2ch Enhancer” to play back compression artifacts in 2-channel stereo.
- Select “6ch Enhancer” to play back compression artifacts in 6-channel stereo.
- Select Off (previously selected sound field program) to turn off the Compressed Music Enhancer mode.



You can also switch between “2ch Enhancer” and “6ch Enhancer” by pressing </> on the remote control when the arrow is located on the left of “2ch Enhancer” or “6ch Enhancer” in the OSD.

**2 Press √ once and then </> on the remote control to select the desired effect level.**

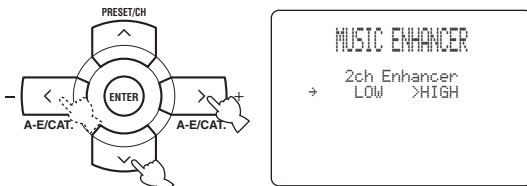

Choices: **HIGH**, LOW

- Select “HIGH” for a high effect level.
- Select “LOW” for a low effect level.

**Note**

Set the effect level to “HIGH” or “LOW” according to the characteristics of a source. The high-frequency signals of some sources may be emphasized too much. In this case, set the effect level to “LOW”.

**Selecting the MULTI CH INPUT component**

Use this feature to select the component connected to the MULTI CH INPUT jacks (see page 24) as the input source.

Press **MULTI CH INPUT** on the front panel (or **MULTI CH IN** on the remote control) so that “MULTI CH INPUT” appears in the front panel display.

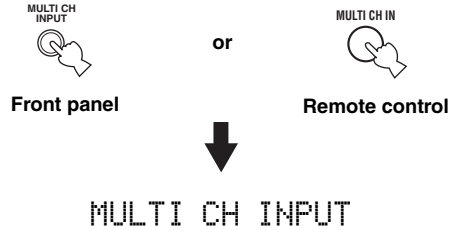

**Note**

When “MULTI CH INPUT” is shown in the front panel display, no other source can be played. To select another input source with the INPUT selector on the front panel (or one of the input selector buttons), press MULTI CH INPUT (or MULTI CH IN on the remote control) so that “MULTI CH INPUT” disappears from the front panel display.

## Enjoying multi-channel sources in 2-channel stereo

You can mix down multi-channel sources to 2 channels and enjoy playback in 2-channel stereo.

Set the component selector switch to AMP and then press STEREO on the remote control repeatedly to select “2ch Stereo”.

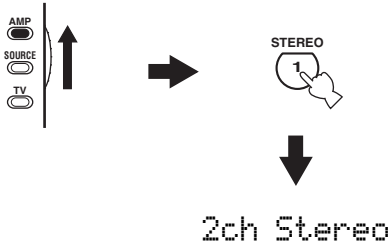

- You can use a subwoofer with this program when “LFE/BASS OUT” is set to “SWFR” or “BOTH” (see page 78).
- You can also select the “2ch Stereo” mode by rotating the PROGRAM selector on the front panel.

## Enjoying unprocessed input sources

When this unit is in the “STRAIGHT” mode, 2-channel stereo sources are output from only the front left and right speakers. Multi-channel sources are decoded straight into the appropriate channels without any additional effect processing.

**1** Set the component selector switch to AMP and then press STRAIGHT on the remote control to select “STRAIGHT”.

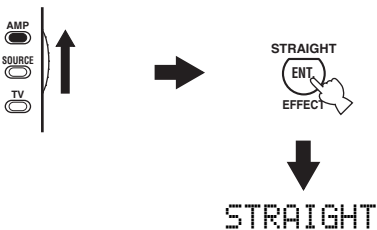

**2** To deactivate the “STRAIGHT” mode, press STRAIGHT on the remote control again so that “STRAIGHT” disappears from the front panel display.

The sound effect is turned back on.



You can also select the “STRAIGHT” mode by pressing STRAIGHT (EFFECT) on the front panel.

## Enjoying pure hi-fi stereo sound

The “DIRECT STEREO” mode allows sources to bypass the decoders and DSP processors of this unit so that you can enjoy pure hi-fi sound from 2-channel PCM and analog sources.

Set the component selector switch to AMP and then press DIRECT ST. on the remote control to select “DIRECT STEREO”.

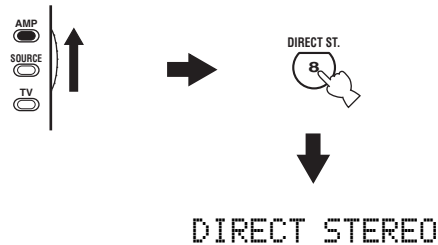

### Notes

- To avoid unexpected noise, do not play CDs encoded in DTS when the “DIRECT STEREO” mode is selected.
- When multi-channel signals (Dolby Digital and DTS) are input, this unit automatically switches to the corresponding analog input. When “DTS” is selected as the input mode (see page 35), no sound will be output.
- No sound will be output from the subwoofer.
- “TONE CONTROL” (see page 33) and “SOUND MENU” (see page 77) settings (except for speaker level settings) are not effective.
- The front panel display automatically dims.



You can also select the “DIRECT STEREO” mode by rotating the PROGRAM selector on the front panel.

# USING VIDEO FEATURES

## Displaying the input source information

You can display the format, sampling frequency, channel, bit rate and flag data of the current input signal.

- 1 **Set the component selector switch to AMP and then press SET MENU on the remote control.**

The top "SET MENU" display appears in the OSD.



- 2 **Press  $\nabla$  repeatedly to select "SIGNAL INFO" and then press ENTER.**

The following information about the input source appears in the OSD.

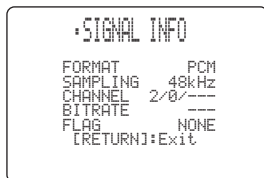
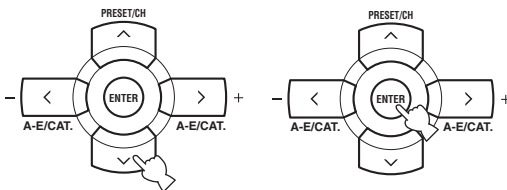

### Signal format FORMAT

Signal format display. When this unit cannot detect a digital signal, it automatically switches to analog input.

Display status: Analog, Digital, DolbyD, DTS, MP3, PCM, WMA, ---

#### Note

"---" appears when this unit cannot detect any signals.

### Sampling frequency SAMPLING

The number of samples per second taken from a continuous signal to make a discrete signal.

Display status: 8kHz, 11kHz, 12kHz, 16kHz, 22.05kHz, 24kHz, 32kHz, 44.1kHz, 48kHz, 64kHz, 88.2kHz, 96kHz, ---

#### Note

"---" appears when this unit cannot detect the sampling frequency.

### Channel CHANNEL

The number of source channels in the input signal (front/surround/LFE). For example, a multi-channel soundtrack with 3 front channels, 2 surround channels and LFE, is displayed as "3/2/0.1".

#### Note

"---" appears when there is no source channel available.

### Bit rate BITRATE

The number of bits passing a given point per second.

#### Note

"---" appears when this unit cannot detect the bit rate.

### Flag FLAG

Flag data encoded in DTS, Dolby Digital, or PCM signals that cue this unit to automatically switch decoders.

- 3 **Press SET MENU on the remote control again to exit from "SET MENU".**



## Selecting the OSD mode

You can display the operating information of this unit on a video monitor. If you display the "SET MENU" and sound field program parameter settings on a video monitor, it is much easier to see the available options and parameters than it is to read the information in the front panel display.

**1 Turn on the video monitor connected to this unit.**

**2 Set the component selector switch to AMP and then press DISPLAY on the remote control repeatedly to toggle between the OSD modes.**

The OSD mode changes in the following order.

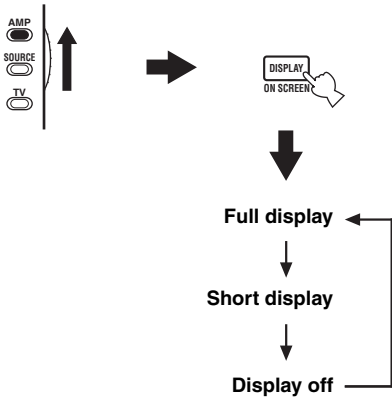

### Full display

Fully shows the sound field program parameter settings as well as the contents of the front panel display.

### Short display

Briefly shows the contents of the front panel display at the bottom of the screen each time you operate this unit.

### Display off

No information is displayed except for the "SET MENU" screen.

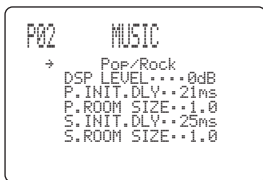

Full display

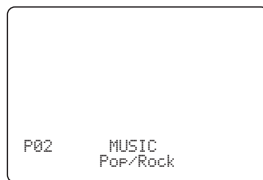

Short display



You can display a gray background in the OSD when there is not video signal being input by setting "GRAY BACK" in "OPTION MENU" to "AUTO" (see page 87).

### Notes

- The OSD signal is not output at the DVR OUT jacks and will not be recorded.
- You must set "VIDEO CONV." in "OPTION MENU" to "ON" (see page 86) to display the OSD.
- To display the OSD with the component video signals output at the COMPONENT VIDEO MONITOR OUT jacks, set the OSD mode to the full display mode.
- When "GRAY BACK" in "OPTION MENU" is set to "OFF" (see page 87), the OSD may not be displayed correctly depending on the conditions of the picture.

## Playing video sources in the background

You can combine a video image from a video source with sound from an audio source. For example, you can enjoy listening to classical music while viewing beautiful scenery from the video source on the video monitor.

**Press the input selector buttons on the remote control to select a video source and then an audio source.**

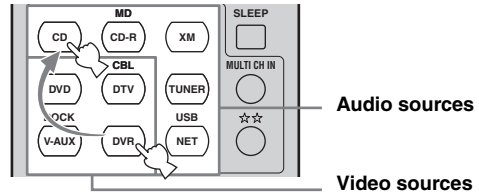

If you want to enjoy an audio source input at the MULTI CH INPUT jacks together with a video source, first select the video source and then press MULTI CH INPUT on the front panel (or MULTI CH IN on the remote control) to select the component connected to the MULTI CH INPUT jacks as the input source (see page 38).

# ENJOYING SURROUND SOUND

## Enjoying multi-channel sources in 6.1-channel surround

If you connected a surround back speaker, use this feature to enjoy 6.1-channel playback for multi-channel sources using the Dolby Pro Logic IIX, Dolby Digital EX or DTS-ES decoders.

- 1 **Set the component selector switch to AMP and then press EXTD SUR. on the remote control repeatedly to switch between 5.1 and 6.1-channel playback.**

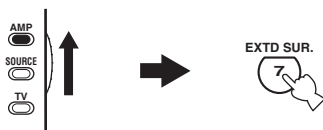

- 2 **Press </> repeatedly to select a decoder while “PLIIXMusic” (etc.) is displayed.**

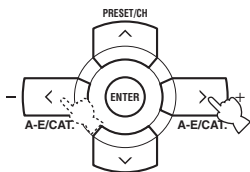

### Auto AUTO

When a signal flag that can be recognized by this unit is input, this unit selects the optimum decoder to play back the signal in 6.1 channels.

If this unit cannot recognize the flag or no flag is present in the input signal, it cannot automatically be played in 6.1 channels.

### Decoders

You can select from the following decoders depending on the format of the source you are playing.

Decoder	Functions
PLIIXMusic	Plays back Dolby Digital or DTS signals in 6.1 channels using the Pro Logic IIX music decoder.
EX/ES	Plays back Dolby Digital or DTS signals in 6.1 channels using the Dolby Digital EX or DTS-ES decoder.
EX	Plays back Dolby Digital or DTS signals in 6.1 channels using the Dolby Digital EX decoder.

### Off OFF

Decoders are not used to create 6.1 channels.

### Notes

- Some 6.1-channel compatible discs do not have a signal flag that can be automatically detected by this unit. When playing these kinds of discs in 6.1 channels, select a decoder manually from “PLIIXMusic”, “EX/ES” or “EX”.
- 6.1-channel playback is not possible even if you press EXTD SUR. in the following cases:
  - when “CENTER SP” (see page 78), “SUR. L/R SP” (see page 78) or “SUR. B SP” (see page 78) is set to “NONE”.
  - when the component connected to the MULTI CH INPUT jacks is being played.
  - when the source being played does not contain surround left and right channel signals.
  - when a Dolby Digital KARAOKE source is being played.
  - when the “2ch Stereo” (see page 39) or “DIRECT STEREO” (see page 39) mode is selected.
- When this unit is turned off, this setting will be reset to “AUTO”.
- The Pro Logic IIX decoder is not available when “SUR. B SP” is set to “NONE” (see page 78).

## Enjoying 2-channel sources in surround

Signals input from 2-channel sources can also be played back on multi-channels.

- 1 Set the component selector switch to **AMP** and then press **STANDARD** on the remote control repeatedly to switch between the “**SUR. STANDARD**” and “**SUR. ENHANCED**” programs or press **MOVIE** to select the “**MOVIE THEATER**” program.

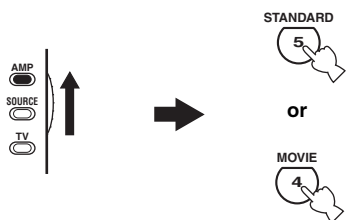

- 2 Press **SELECT** on the remote control repeatedly to select the desired decoder.



You can select from the following modes depending on the type of source you are playing and your personal preference.



You can also select a decoder by pressing **</>** on the remote control while the decoder type is displayed in the front panel display.

SUR. STANDARD	Functions
PRO LOGIC	Dolby Pro Logic processing for any sources
PLII Movie	Dolby Pro Logic II processing for movie sources
PLII Music	Dolby Pro Logic II processing for music sources
PLII Game	Dolby Pro Logic II processing for game sources
PLIIx Movie	Dolby Pro Logic Iix processing for movie sources
PLIIx Music	Dolby Pro Logic Iix processing for music sources
PLIIx Game	Dolby Pro Logic Iix processing for game sources
Neo:6 Cinema	DTS processing for movie sources
Neo:6 Music	DTS processing for music sources
Neural Sur.	Neural Surround processing for any sources (U.S.A. and Canada models only)

SUR. ENHANCED or MOVIE THEATER	Functions
PRO LOGIC	Dolby Pro Logic processing for any sources
PLII Movie	Dolby Pro Logic II processing for movie sources
PLIIx Movie	Dolby Pro Logic Iix processing for movie sources
Neo:6 Cinema	DTS processing for movie sources

### Notes

- The Pro Logic Iix decoder is not available when “SUR. B SP” is set to “NONE” (see page 78).
- The Neural Surround decoder is compatible with the PCM signals (32 kHz, 44.1 kHz and 48 kHz) and the analog 2-channel input sources.
- The Neural Surround decoder is not effective with any of the sound field programs.
- When Neural Surround-incompatible signals are being input while the Neural Surround decoder is selected, multi-channel sources are decoded straight into the appropriate channels without any additional effect processing and the Neural Surround-incompatible PCM signals are played back in 2-channel stereo.

## Using Virtual CINEMA DSP

Virtual CINEMA DSP allows you to enjoy the CINEMA DSP programs without surround speakers. It creates virtual speakers to reproduce the natural sound field. If you set “SUR. L/R SP” to “NONE” (see page 78), Virtual CINEMA DSP activates automatically whenever you select a CINEMA DSP sound field program (see page 66).

### Note

Virtual CINEMA DSP will not activate even when “SUR. L/R SP” is set to “NONE” (see page 78) in the following cases:

- when the component connected to the MULTI CH INPUT jacks is selected as the input source (see page 38).
- when headphones are connected to the PHONES jack.
- when the “DIRECT STEREO” (see page 39), “2ch Stereo” (see page 39) or “STRAIGHT” mode (see page 39) is selected.



# RECORDING

Recording adjustments and other operations are performed from the recording components. Refer to the operating instructions for those components.

## CAUTION

The DTS signal is a digital bitstream. Attempting to digitally record the DTS bitstream will result in noise being recorded. Therefore, if you want to use this unit to record sources encoded in DTS, the following considerations and adjustments need to be made. To play DTS-encoded DVDs and CDs (when using a digital audio connection) on your DTS-compatible player, follow its operating instructions to make a setting so that the analog signal will be output from the player.

## Notes

- When this unit is set to the standby mode, you cannot record between other components connected to this unit.
- The settings of TONE CONTROL (see page 33), VOLUME, the speaker level (see page 79) and the sound field programs (see page 66) do not affect the recorded material.
- The source connected to the MULTI CH INPUT jacks of this unit cannot be recorded.
- S-video and composite video signals pass independently through the video circuits of this unit. Therefore, when recording or dubbing video signals input from a video source component that provides only an S-video or a composite video signal, you can record only an S-video or a composite video signal on your VCR.
- Digital signals input at the DIGITAL INPUT jacks are not output at the analog AUDIO OUT (REC) jacks for recording. Likewise, analog signals input at the AUDIO IN jacks are not output at the DIGITAL OUTPUT jack. Therefore, if your source component is connected to provide only digital or analog signals, you can only record digital or analog signals.
- A given input source is not output on the same OUT (REC) channel.
- Check the copyright laws in your country to record from CDs, radio, etc. Recording of copyrighted material may infringe copyright laws.
- The XM Satellite Radio (U.S.A. and Canada models only) signals cannot be output at the AUDIO OUT (REC) jacks.
- The analog audio signals input at the DOCK terminal can be output at the analog AUDIO OUT (REC) jacks for recording.



Do a test recording before you start an actual recording.

If you play back a video source that uses scrambled or encoded signals to prevent it from being dubbed, the picture itself may be disturbed due to those signals.

(U.S.A. model)

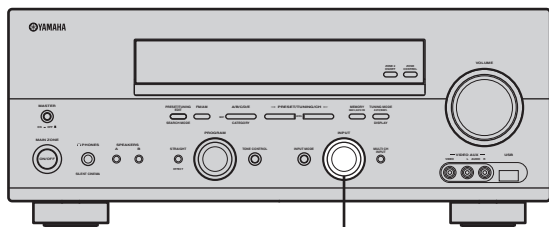

2

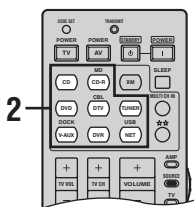

(U.S.A. model)

1 Turn on all the connected components.

2 Rotate the INPUT selector on the front panel (or press one of the input selector buttons on the remote control) to select the source component you want to record from.

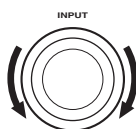

Front panel

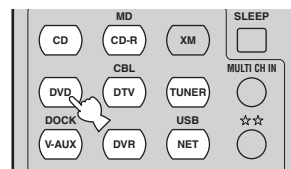

Remote control

3 Start playback on the selected source component or select a broadcast station.

4 Start recording on the recording component.

# FM/AM TUNING

There are 2 tuning methods: automatic and manual. Automatic tuning is effective when station signals are strong and there is no interference. If the signal from the station you want to select is weak, tune into it manually. You can also use the automatic and manual preset tuning features to store up to 40 stations (A1 to E8: 8 preset station numbers in each of the 5 preset station groups). Furthermore, you can recall any preset stations and exchange the assignment of two preset stations with each other.

## Note

Orient the connected FM and AM antennas for the best reception.

## Automatic tuning

Automatic tuning is effective when station signals are strong and there is no interference.

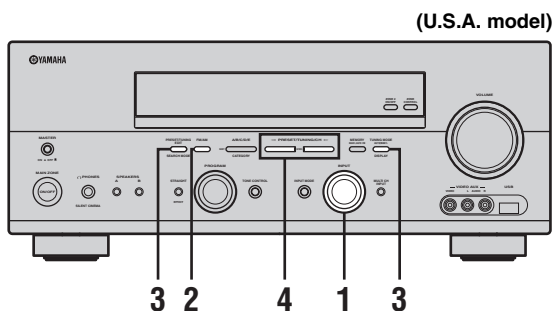

- 1 Rotate the INPUT selector to select "TUNER" as the input source.

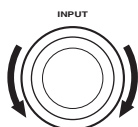

Front panel

- 2 Press FM/AM to select the reception band. "FM" or "AM" appears in the front panel display.



- 3 Press TUNING MODE (AUTO/MAN'L) so that the AUTO indicator lights up in the front panel display.

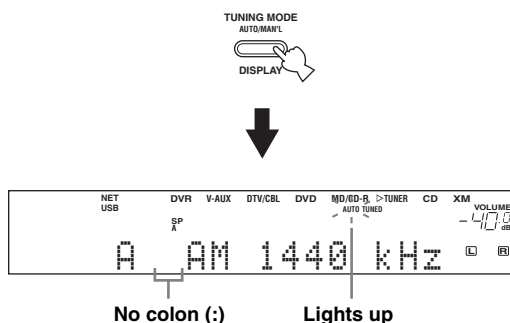

If a colon (:) appears in the front panel display, tuning is not possible. Press PRESET/TUNING to turn the colon (:) off.



- 4 Press PRESET/TUNING/CH </> once to begin automatic tuning.

When this unit is tuned into a station, the TUNED indicator lights up and the frequency of the received station is shown in the front panel display.

- Press > to tune into a higher frequency.
- Press < to tune into a lower frequency.

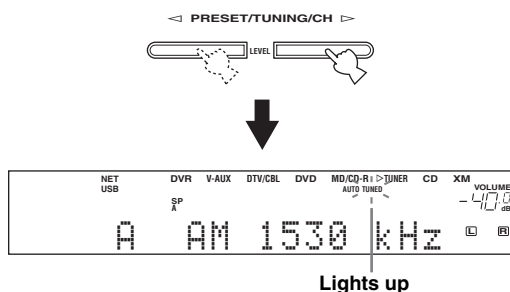

## Manual tuning

If the signal received from the station you want to select is weak, tune into it manually.

### Note

Manually tuning into an FM station automatically switches the tuner to monaural reception to increase the signal quality.

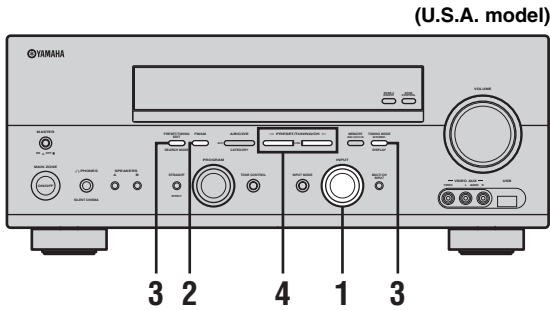

- 1 Rotate the INPUT selector to select "TUNER" as the input source.



- 2 Press FM/AM to select the reception band. "FM" or "AM" appears in the front panel display.



- 3 Press TUNING MODE (AUTO/MAN'L) so that the AUTO indicator disappears from the front panel display.

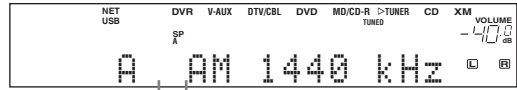

No colon (:)

If a colon (:) appears in the front panel display, tuning is not possible. Press PRESET/TUNING to turn the colon (:) off.



- 4 Press PRESET/TUNING/CH </> to tune into the desired station manually. Hold down the button to continue searching.



## Automatic preset tuning

You can use the automatic preset tuning feature to store FM stations with strong signals up to 40 (A1 to E8: 8 preset station numbers in each of the 5 preset station groups) of those stations in order. You can then recall any preset station easily by selecting the preset station number.

(U.S.A. model)

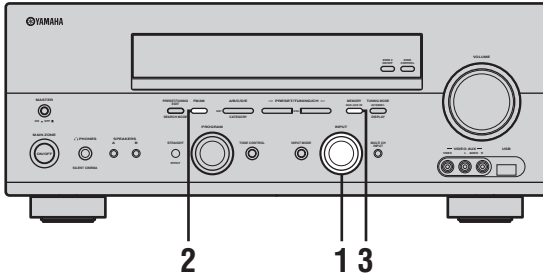

- 1 Rotate the INPUT selector to select “TUNER” as the input source.

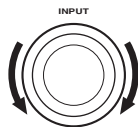

Front panel

- 2 Press FM/AM to select “FM” as the reception band.

“FM” appears in the front panel display.



- 3 Press and hold MEMORY (MAN'L/AUTO FM) for more than 3 seconds.

The preset station number as well as the MEMORY and AUTO indicators flashes. After approximately 5 seconds, automatic presetting starts from the current frequency and proceeds toward the higher frequencies.

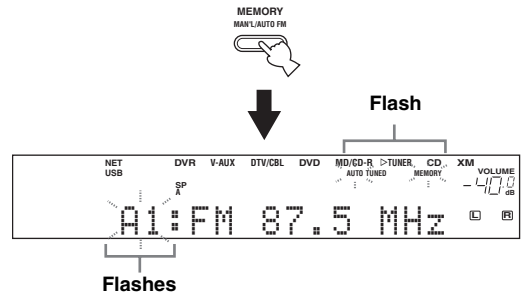

When automatic preset tuning is completed, the front panel display shows the frequency of the last preset station.



You can specify the preset number from which this unit stores FM stations and/or begins tuning toward lower frequencies. For details, see “Automatic preset tuning options” on page 49.

### Notes

- Any stored station data existing under a preset station number is cleared when you store a new station under the same preset station number.
- If the number of received stations does not reach 40 (E8), automatic preset tuning automatically stops after searching for all the available stations.
- Only FM stations with sufficient signal strength are stored automatically by automatic preset tuning. If the station you want to store is weak in signal strength, tune into it manually and store it as described in “Manual preset tuning” on page 49.

### Automatic preset tuning options

You can specify the preset number from which this unit stores FM stations and/or begins tuning toward lower frequencies.

**Note**

First carry out steps 1 through 3 in “Automatic preset tuning” on page 48.

- Press **A/B/C/D/E** and then **PRESET/TUNING/CH** ◀/▶ to select the preset station number under which the first station will be stored. Automatic preset tuning stops when stations have all been stored up to E8.



- Press **PRESET/TUNING** so that the colon (:) disappears from the front panel display and then press **PRESET/TUNING/CH** ◀ to begin tuning toward lower frequencies.

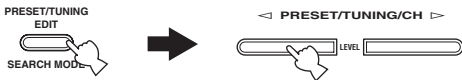

## Manual preset tuning

You can also store up to 40 stations (A1 to E8: 8 preset station numbers in each of the 5 preset station groups) manually.

(U.S.A. model)

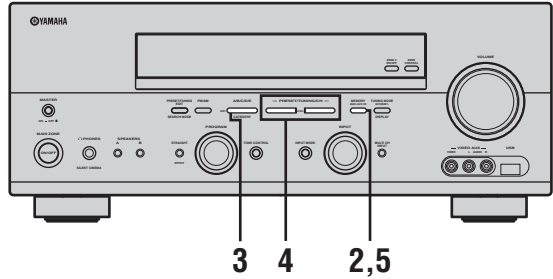

- 1 **Tune into a station automatically or manually.**  
See pages 46 and 47 for tuning instructions.

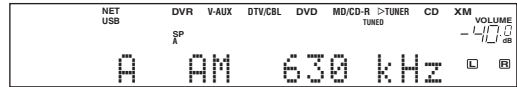

When this unit is tuned into a station, the front panel display shows the frequency of the station received.

- 2 **Press MEMORY (MAN'L/AUTO FM).**

The MEMORY indicator flashes in the front panel display for approximately 5 seconds.



- 3 **Press A/B/C/D/E repeatedly to select a preset station group (A to E) while the MEMORY indicator is flashing.**

The selected preset station group letter appears. Check that the colon (:) appears in the front panel display.

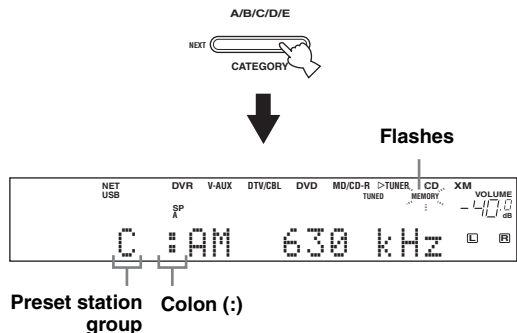

**4 Press PRESET/TUNING/CH </> to select a preset station number (1 to 8) while the MEMORY indicator is flashing.**

- Press > to select a higher preset station number.
- Press < to select a lower preset station number.

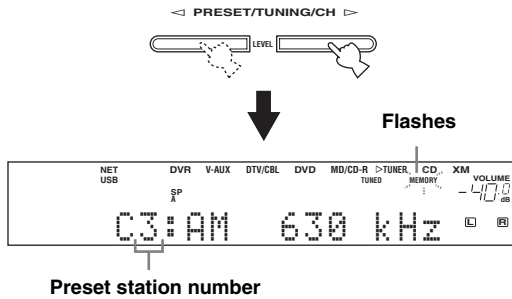

**5 Press MEMORY (MAN'L/AUTO FM) while the MEMORY indicator is flashing.**

The station band and frequency appear in the front panel display with the preset station group and number you have selected. The MEMORY indicator disappears from the front panel display.

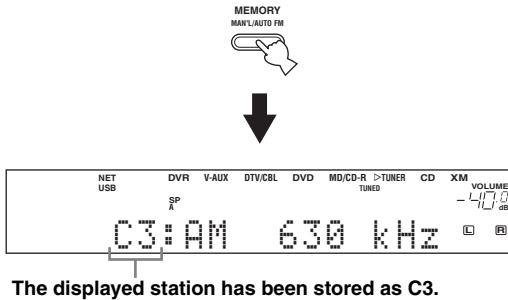

**6 Repeat steps 1 through 5 to store other stations.**

**Notes**

- Any stored station data existing under a preset station number is cleared when you store a new station under the same preset station number.
- The reception mode (stereo or monaural) is stored along with the station frequency.

**Selecting preset stations**

You can tune into any desired station simply by selecting the preset station group and number under which it was stored.

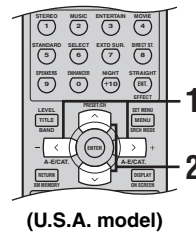
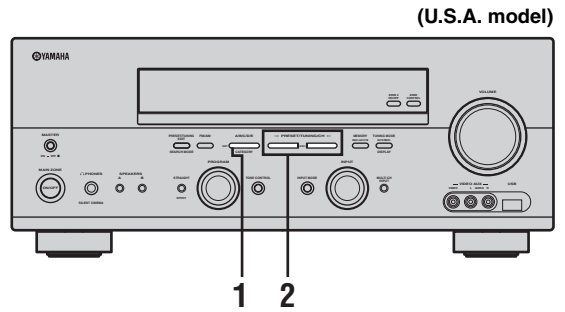

When performing this operation with the remote control, set the component selector switch to SOURCE and then press TUNER to select "TUNER" as the input source.

**1 Press A/B/C/D/E on the front panel (or A-E/CAT. </> on the remote control) to select the desired preset station group (A to E).**

The preset station group letter appears in the front panel display and changes each time you press the button.

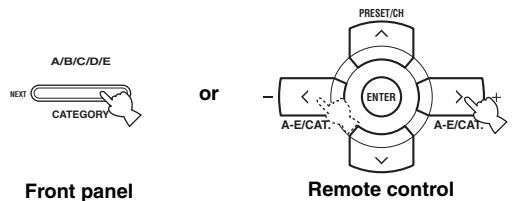

- 2** Press PRESET/TUNING/CH ◀/▶ on the front panel (or PRESET/CH ^/∨ on the remote control) to select the desired preset station number (1 to 8).

The preset station group and number appear in the front panel display along with the station band and frequency.

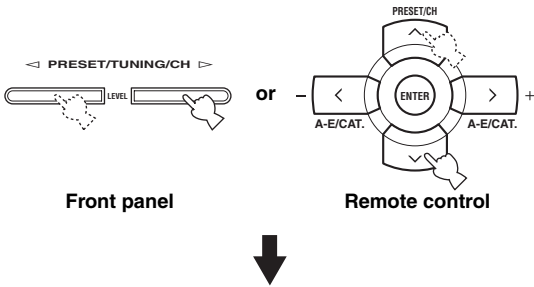

## Exchanging preset stations

You can exchange the assignments of two preset stations with each other. The example below describes the procedure to exchange preset station “E1” with “A5”.

(U.S.A. model)

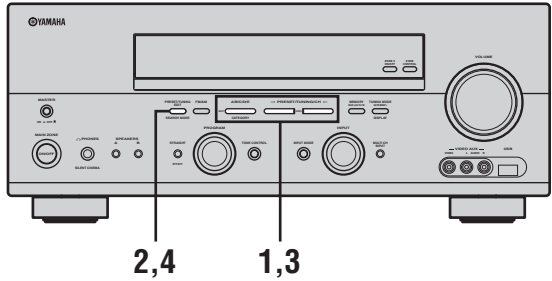

- 1** Select preset station “E1” using A/B/C/D/E and PRESET/TUNING/CH ◀/▶.

See “Selecting preset stations” on page 50.

- 2** Press and hold EDIT for more than 3 seconds.

“E1” and the MEMORY indicator flash in the front panel display.

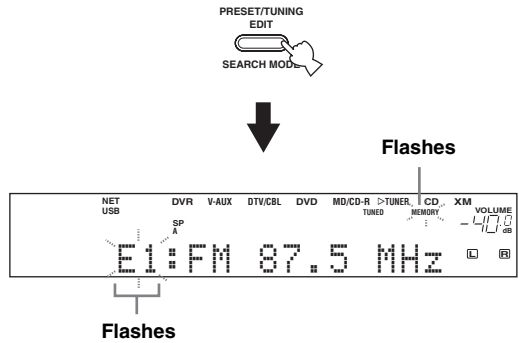

**3 Select preset station “A5” using A/B/C/D/E and PRESET/TUNING/CH </>.**

“A5” and the MEMORY indicator flash in the front panel display.  
See “Selecting preset stations” on page 50.

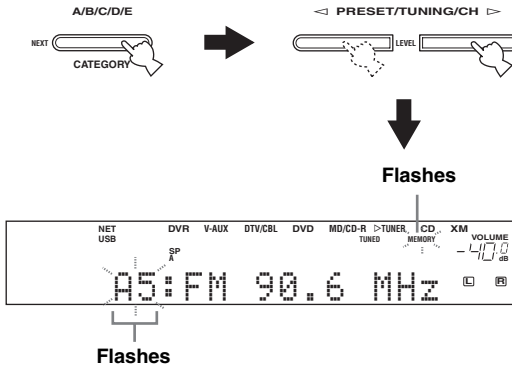

**4 Press EDIT again.**

“EDIT E1–A5” appears in the front panel display and the assignments of the two preset stations are exchanged.

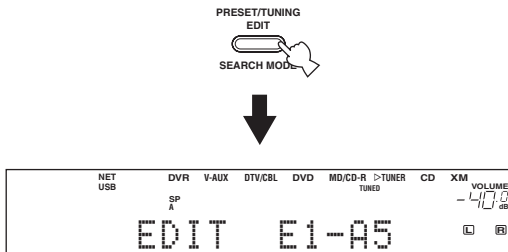



# XM® SATELLITE RADIO TUNING

XM Satellite Radio is the satellite radio service with millions of listeners across the United States and Canada, broadcasting live daily. The XM Satellite Radio channel lineup includes over 160 digital channels of choice from coast to coast: 67 commercial-free music channels, featuring hip hop to opera, classical to country, bluegrass to blues; 33 channels of premier sports, talk, comedy, children's and entertainment programming; and more than 20 channels of the traffic and weather information for major metropolitan areas nationwide.

Because XM Satellite Radio is a subscription service, you will need to set up an account and activate service with XM using your XM Satellite Radio ID number. To check your ID number, follow "Activating XM Satellite Radio" on page 56. For further information on XM Satellite Radio services, visit the XM Satellite Radio website at "<http://www.xmradio.com/>" (for residents in the United States) or "<http://www.xmradio.ca/>" (for residents in Canada).

This unit is equipped with the Neural Surround decoder (U.S.A. and Canada models only) that plays back the surround sound content of the XM Satellite Radio broadcasts in multi-channels, resulting in a full surround sound experience.

## Notes

- The XM Satellite Radio service is only available in the 48 contiguous United States (not available in Alaska and Hawaii) and Canada.
- XM Passport System and monthly subscription are sold separately. For details, visit the XM Satellite Radio website at "<http://www.xmradio.com/>" (for residents in the United States) or "<http://www.xmradio.ca/>" (for residents in Canada).
- For information on obtaining XM Passport System, visit the XM Satellite Radio website at "<http://www.xmradio.com/>" (for residents in the United States) or "<http://www.xmradio.ca/>" (for residents in Canada), or consult your local retailer that sells XM Ready products.
- To ensure the optimal reception of the XM Satellite Radio signals, XM Passport System must be placed at or near a southerly facing window with no obstacles in the path to the sky. You can mount it indoors or outdoors.

## ■ Information from XM Satellite Radio Inc.

XM monthly service subscription sold separately. XM Passport and XM Passport Home Dock required to receive XM service (sold separately). Installation costs and other fees and taxes, including a one-time activation fee may apply. Subscription fee is consumer only. All fees and programming subject to change. Channels with frequent explicit language are indicated with an "XL". Channel blocking is available for XM radio receivers by calling "1-800-XM-RADIO (1-800-967-2346)" (for residents in the United States) or "1-877-GET-XMSR (1-877-438-9677)" (for residents in Canada). Subscriptions subject to Customer Agreement available at "<http://www.xmradio.com/>" (for residents in the United States) or "<http://www.xmradio.ca/>" (for residents in Canada). XM service only available in the 48 continuous United States and Canada. "XM Ready" is a trademark of XM Satellite Radio Inc. © 2006 XM Satellite Radio Inc. All rights reserved.

## Connecting XM Passport System

Connect XM Passport and XM Passport Home Dock (sold separately) to the XM jack on the rear panel of this unit. For details, see the operating instructions provided with XM Passport System.

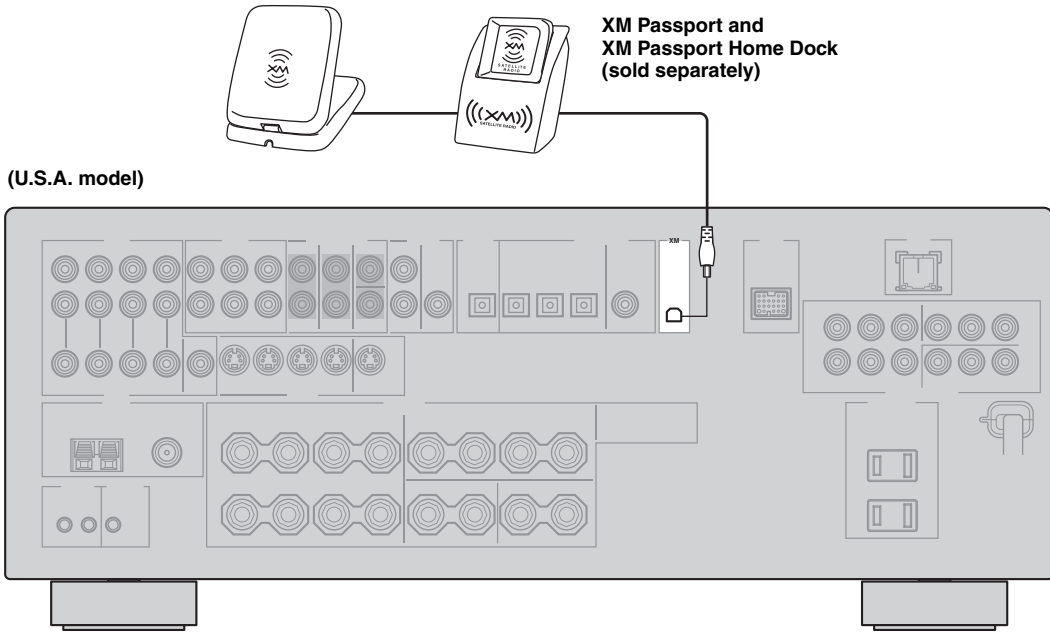

# XM Satellite Radio controls and functions

## Note

The following controls are available only when “XM” is selected as the input source. Rotate the INPUT selector on the front panel (or set the component selector switch to SOURCE and then press XM on the remote control) to select “XM” as the input source.

### ■ Front panel functions

(U.S.A. model)

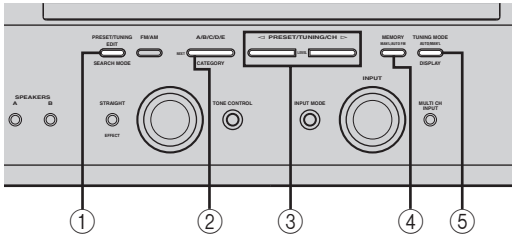

#### ① SEARCH MODE

Changes the search mode between the All Channel Search, Category Search, and Preset Search modes (see page 58).

#### ② CATEGORY

##### (All Channel Search mode)

Changes the channel category while staying in the All Channel Search mode.

##### (Category Search mode)

Changes the channel category.

##### (Preset Search mode)

Changes the preset channel group (A to E).

#### ③ PRESET/TUNING/CH </>

##### (All Channel Search mode)

Searches for a channel within all channels. Press and hold for quick search.

##### (Category Search mode)

Searches for a channel within the selected category. Press and hold for quick search.

##### (Preset Search mode)

Changes the preset channel number (1 to 8).

#### ④ MEMORY (MAN'L/AUTO FM)

Stores a preset channel in the memory (see page 62).

#### ⑤ DISPLAY

Displays the XM Satellite Radio information such as channel number, channel name, category, artist name, or song title displayed in the front panel display or in the OSD (see page 63).

### ■ Remote control functions

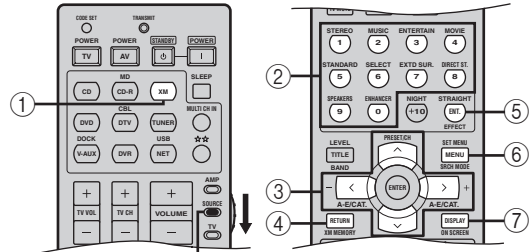

Set to SOURCE.

(U.S.A. model)

#### ① XM

Selects “XM” as the input source.

#### ② Numeric buttons

##### (All Channel Search or Category Search mode)

Use 1 to 9 and 0 to enter a channel number directly.

##### (Preset Search mode)

Use 1 to 8 to enter a preset channel number directly.

#### ③ Cursor buttons ^ / v / < / >

##### (All Channel Search mode)

Press A-E/CAT. < / > to change the channel category.

Press PRESET/CH ^ / v to search for a channel within all channels. Press and hold for quick search.

##### (Category Search mode)

Press A-E/CAT. < / > to change the channel category.

Press PRESET/CH ^ / v to search for a channel within the selected category. Press and hold for quick search.

##### (Preset Search mode)

Press A-E/CAT. < / > to change the preset channel group (A to E).

Press PRESET/CH ^ / v to change the preset channel number (1 to 8).

#### ④ XM MEMORY

Stores a preset channel in the memory (see page 62).

#### ⑤ ENT.

Confirms an entered channel number in the Direct Number Access mode (see page 61).

#### ⑥ SRCH MODE

Changes the search mode between the All Channel Search, Category Search, and Preset Search modes (see page 58).

#### ⑦ DISPLAY

Displays the XM Satellite Radio information such as channel number, channel name, category, artist name, or song title displayed in the front panel display or in the OSD (see page 63).

## Activating XM Satellite Radio

To sign up for an account with the XM Satellite Radio service, an XM Satellite Radio ID number is required. Follow the procedure below to check your ID number, and then visit the website or call toll-free with a major credit card handy for signing up.

### For residents in the United States

URL: <http://activate.xmradio.com/>  
 Toll-free: 1-800-XM-RADIO (1-800-967-2346)

### For residents in Canada

URL: <https://activate.xmradio.ca/on-line-activation/activation.jsp>  
 Toll-free: 1-877-GET-XMSR (1-877-438-9677)

(U.S.A. model)

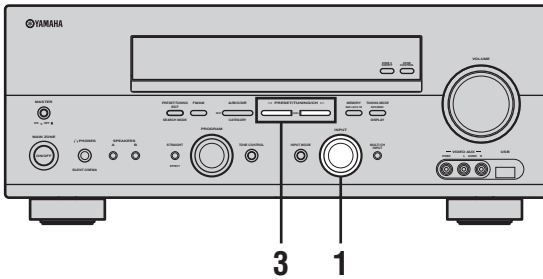

- 1 Rotate the INPUT selector on the front panel (or set the component selector switch to SOURCE) and then press XM on the remote control) to select “XM” as the input source. The cursor on the left of the XM indicator lights up in the front panel display.

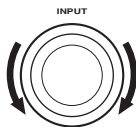

Front panel

or

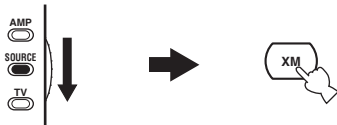

Remote control

Lights up



- 2 Check the XM Satellite Radio reception level and adjust the orientation of XM Passport System for a better percentage of the reception level.



You can display the XM Satellite Radio reception level by using the “XM ANTENNA” parameter in “OPTION MENU” (see page 89).

### Notes

- If “CHECK ANTENNA” appears in the front panel display, XM Passport System may not be connected to the XM jack on the rear panel of this unit properly. See “Connecting XM Passport System” on page 54 and check the connection.
- The “XM ANTENNA” parameter in “OPTION MENU” (see page 89) cannot be adjusted by using the remote control. Instead, you need to adjust the orientation of XM Passport System connected to the XM jack of this unit for a better percentage of the reception level.

- 3 Press PRESET/TUNING/CH </> on the front panel (or PRESET/CH ^ / v on the remote control) to select channel “0”.

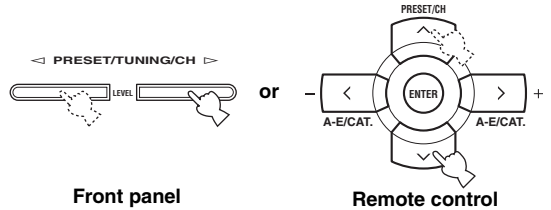

Front panel

Remote control

### Note

You cannot select channel “0” if the All Channel Search mode (see page 58) is not selected.

- 4 Check the XM Satellite Radio ID number displayed in the front panel display and write it down.

ID: \_\_\_\_\_

# Basic XM Satellite Radio operations

(U.S.A. model)

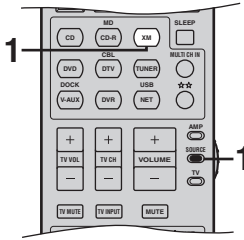
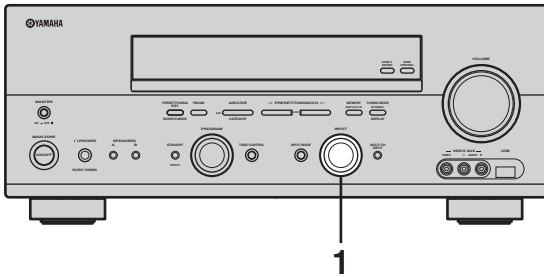

(U.S.A. model)

**1 Rotate the INPUT selector on the front panel (or set the component selector switch to SOURCE and then press XM on the remote control) to select “XM” as the input source.**

The cursor on the left of the XM indicator lights up in the front panel display and the XM Satellite Radio information (such as channel number, channel name, category, artist name, or song title) for the currently selected channel appears in the front panel display.

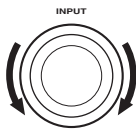

Front panel

or

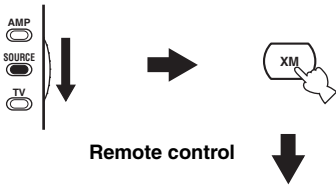

Remote control

Lights up



When you select “XM” as the input source, this unit automatically recalls the previously selected channel.

**Note**

The XM Satellite Radio signals cannot be output at the AUDIO OUT (REC) jacks.

**2 Search for a channel by using one of the XM Satellite Radio search modes.**

See “Selecting the XM Satellite Radio search mode” on page 58 for details.



- You can use the Neural Surround decoder to enjoy the surround sound content of the XM Satellite Radio broadcasts in multi-channels (see page 43).
- You can set the XM Satellite Radio preset channels (see page 62).
- You can display the XM Satellite Radio information in the front panel display or in the OSD (see page 63).

BASIC OPERATION

## Selecting the XM Satellite Radio search mode

You can search for the desired channel using one of the three search modes (All Channel Search, Category Search, and Preset Search modes). You can also enter the channel number directly to select the desired channel by using the Direct Number Access mode (see page 61).

### All Channel Search mode

(U.S.A. model)

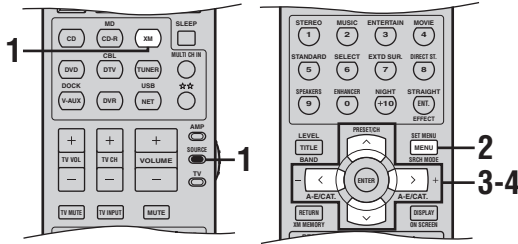
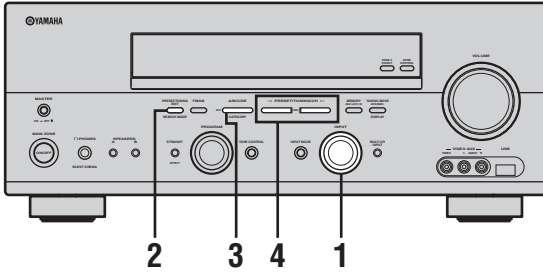

(U.S.A. model)

- 1 Rotate the INPUT selector on the front panel (or set the component selector switch to SOURCE and then press XM on the remote control) to select "XM" as the input source.

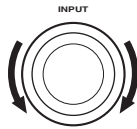

Front panel

or

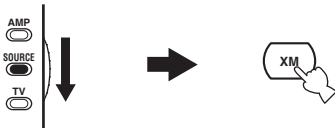

Remote control

- 2 Press SEARCH MODE on the front panel (or SRCH MODE on the remote control) repeatedly to select "ALL CH SEARCH".



Front panel

or



Remote control



- 3 Press CATEGORY on the front panel (or A-E/CAT. </> on the remote control) repeatedly to change the channel category.

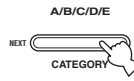

Front panel

or

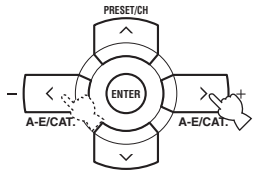

Remote control

- 4 Press PRESET/TUNING/CH </> on the front panel (or PRESET/CH ^ / v on the remote control) repeatedly to search for a channel within all channels.



Front panel

or

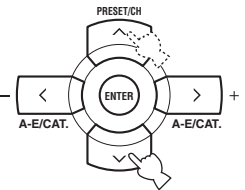

Remote control



You can search for a channel quickly by pressing and holding PRESET/TUNING/CH </> on the front panel (or PRESET/CH ^ / v on the remote control).

## Category Search mode

(U.S.A. model)

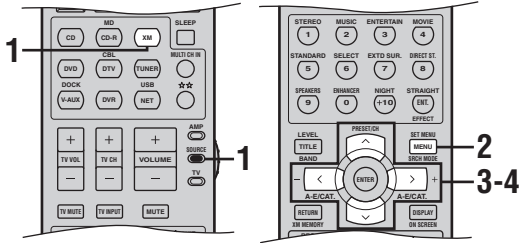
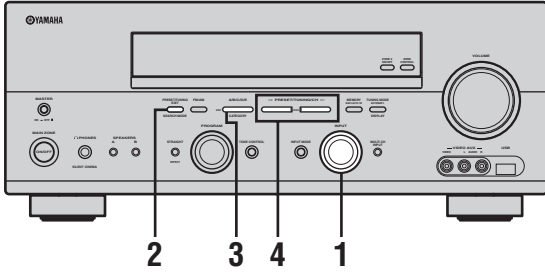

(U.S.A. model)

- 1 Rotate the INPUT selector on the front panel (or set the component selector switch to SOURCE and then press XM on the remote control) to select "XM" as the input source.

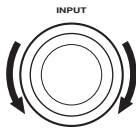

Front panel

or

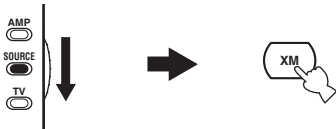

Remote control

- 2 Press SEARCH MODE on the front panel (or SRCH MODE on the remote control) repeatedly to select "CAT SEARCH".



Front panel

or



Remote control



- 3 Press CATEGORY on the front panel (or A-E/CAT. </> on the remote control) repeatedly to change the channel category.

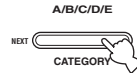

Front panel

or

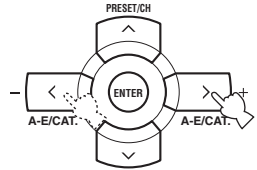

Remote control

- 4 Press PRESET/TUNING/CH </> on the front panel (or PRESET/CH ^ / v on the remote control) repeatedly to search for a channel within the selected channel category.



Front panel

or

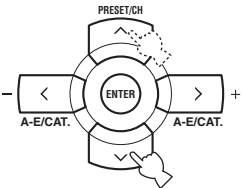

Remote control



You can search for a channel quickly by pressing and holding PRESET/TUNING/CH </> on the front panel (or PRESET/CH ^ / v on the remote control).

## ■ Preset Search mode

Prior to selecting a preset channel in the Preset Search mode, you must preset XM Satellite Radio channels. For details, see “Setting the XM Satellite Radio preset channels” on page 62.



All preset channels (A1 to E8) recalls “001 Preview” by the initial factory setting.

(U.S.A. model)

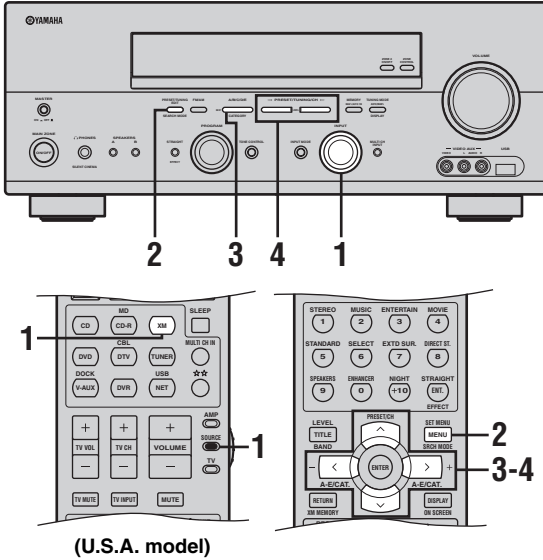

- 1 Rotate the INPUT selector on the front panel (or set the component selector switch to SOURCE and then press XM on the remote control) to select “XM” as the input source.

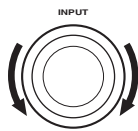

Front panel

or



Remote control

- 2 Press SEARCH MODE on the front panel (or SRCH MODE on the remote control) repeatedly to select “PRESET SEARCH”.



Front panel



Remote control

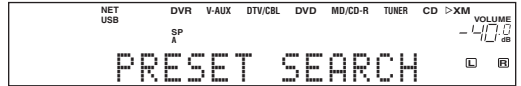

- 3 Press CATEGORY on the front panel (or A-E/CAT. </> on the remote control) repeatedly to change the preset channel group (A to E).

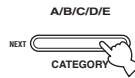

Front panel

or

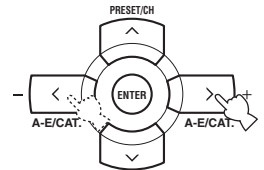

Remote control

- 4 Press PRESET/TUNING/CH </> on the front panel (or PRESET/CH ^ / v on the remote control) repeatedly to change the preset channel number (1 to 8).



Front panel

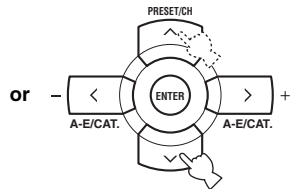

Remote control



You can also select the preset channel number directly by pressing the numeric buttons (1 to 8) on the remote control.



■ Direct Number Access mode

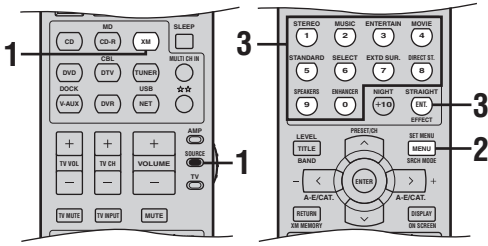

(U.S.A. model)

**1** Set the component selector switch to **SOURCE** and then press **XM** on the remote control to select “XM” as the input source.

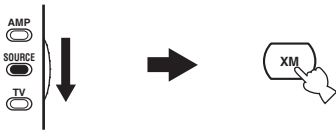

**2** Press **SRCH MODE** on the remote control repeatedly to select “ALL CH SEARCH” or “CAT SEARCH”.



or



**3** Press the numeric buttons on the remote control to enter the desired three-digit channel number.

For example, to enter the number 123, press the numeric buttons as shown below.



The display changes as follows.

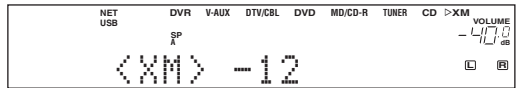
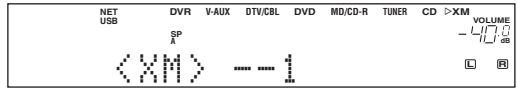

Press the numeric buttons and **ENT.** on the remote control to enter the desired one-digit or two-digit channel number.

For example, to enter the number 12, press the numeric buttons as shown below.



- Instead of pressing ENT. to tune into the channel immediately, you can wait a few seconds until this unit confirms the entered channel number.
- If no button is pressed within a few seconds after you enter a one-digit or two-digit number, this unit automatically confirms the entered channel number.
- Pressing a button other than the numeric buttons or ENT. cancels the Direct Number Access mode procedure.

## Setting the XM Satellite Radio preset channels

You can use this feature to store up to 40 XM Satellite Radio channels (A1 to E8: 8 preset channel numbers in each of the 5 preset channel groups). You can then recall any preset channel easily by selecting the preset channel group and number as described in “Preset Search mode” on page 60.

(U.S.A. model)

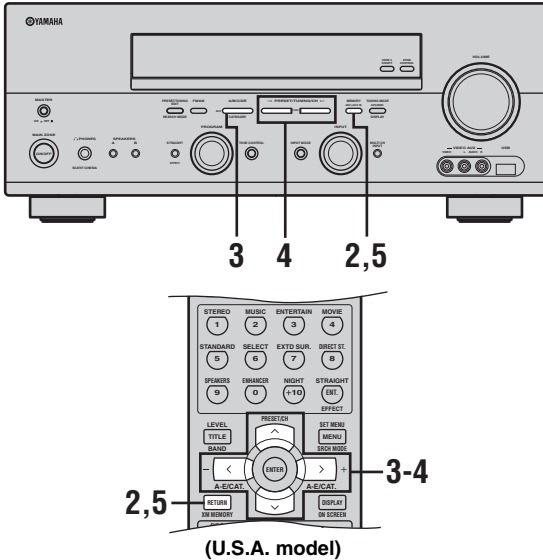

### 1 Search for a channel you want to set as a preset channel by using one of the XM Satellite Radio search modes.

See “Selecting the XM Satellite Radio search mode” on page 58 for details.

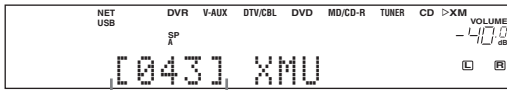

Currently selected channel number

### 2 Press MEMORY on the front panel (or XM MEMORY on the remote control).

The MEMORY indicator flashes in the front panel display for approximately 5 seconds.

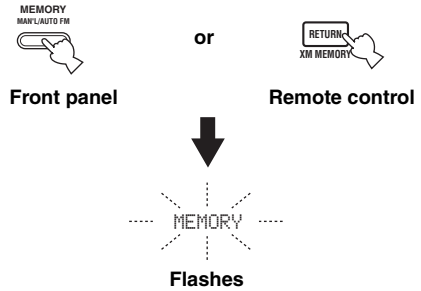

#### Note

You must proceed to and carry out steps 3 through 5 while the MEMORY indicator is flashing in the front panel display.

### 3 Press CATEGORY on the front panel (or A-E/CAT. </> on the remote control) repeatedly to select a preset channel group (A to E) while the MEMORY indicator is flashing.

The preset channel group letter appears in the front panel display.

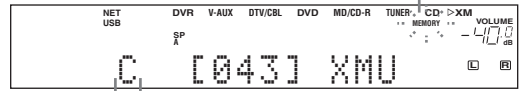
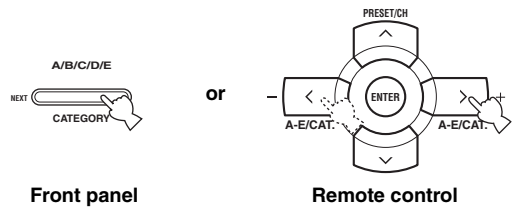

Currently selected preset channel group

- 4 Press PRESET/TUNING/CH ◀/▶ on the front panel (or PRESET/CH ^/▼ on the remote control) repeatedly to select a preset channel number (1 to 8) while the MEMORY indicator is flashing.**

The preset channel number appears in the front panel display.

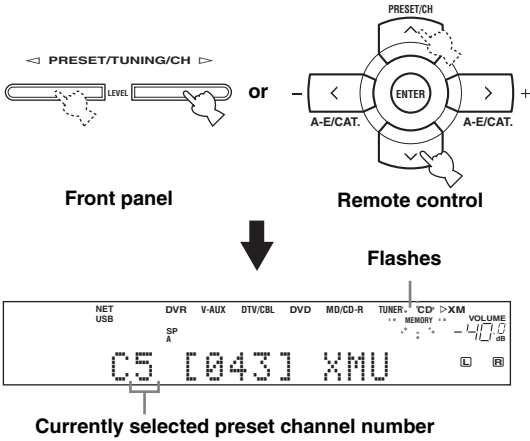

- 5 Press MEMORY on the front panel (or XM MEMORY on the remote control) to set the selected XM Satellite Radio channel as a preset channel while the MEMORY indicator is flashing.**

A colon (:) appears next to the preset channel number for confirmation, and the MEMORY indicator turns off in the front panel display.

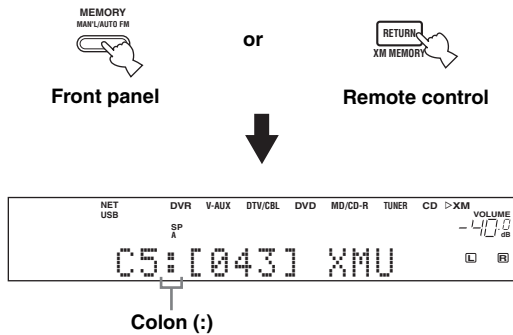

**Note**

Once you set a new preset channel, the one previously stored in the same preset channel group and number is cleared.

## Displaying the XM Satellite Radio information

You can display the XM Satellite Radio information (such as channel number, channel name, category, artist name, or song title) for the currently selected channel in the front panel display or in the OSD.

(U.S.A. model)

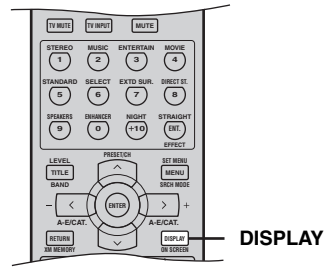
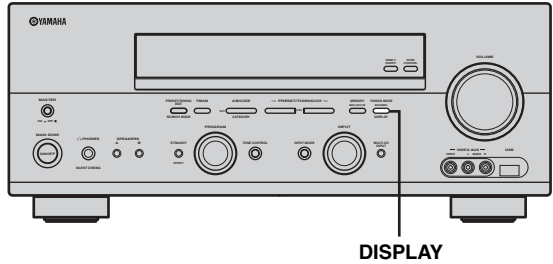

(U.S.A. model)

**Note**

If a status message or an error message appears in the front panel display or in the OSD, see the “XM Satellite Radio (U.S.A. and Canada models only)” section in “TROUBLESHOOTING” on page 112 for appropriate remedies.

### ■ Displaying the XM Satellite Radio information in the front panel display

Press DISPLAY on the front panel or on the remote control repeatedly to toggle between the following XM Satellite Radio information display modes.

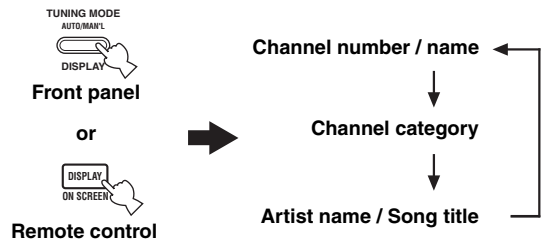

When the channel number / name is displayed:

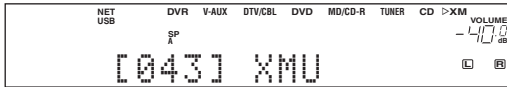

When the channel category is displayed:



When the artist name / song title is displayed:

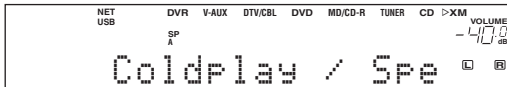

- The front panel display can indicate up to 14 alphanumeric characters at once. You can set whether to display the XM Satellite Radio information in the front panel display in a continuous manner or by 14 alphanumeric characters at once by using the "FL SCROLL" parameter in "OPTION MENU" (see page 87).
- If the XM Satellite Radio information contains a character that cannot be recognized by this unit, the character will be displayed with a space.

**Note**

If you press DISPLAY while the XM Satellite Radio information display is scrolling from right to left in the front panel display, the XM Satellite Radio information display mode toggles as described above.

■ **Displaying the XM Satellite Radio information in the OSD**

Press DISPLAY on the front panel or on the remote control.

The following screen is displayed in the OSD.

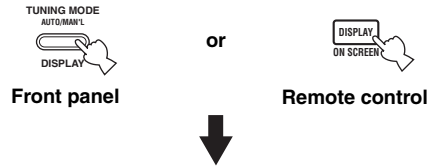

- To turn off the OSD, press and hold DISPLAY on the front panel (or on the remote control).
- You can select the amount of time while the XM Satellite Radio information is displayed in the OSD by using the "ON SCREEN" parameter in "OPTION MENU" (see page 87).
- To hold the XM Satellite Radio information screen, press ENTER on the remote control while it is being displayed in the OSD.
- The XM Satellite Radio information screen on hold is released if you press ENTER on the remote control again or if you change the XM Satellite Radio channel.
- This unit can save up to two XM Satellite Radio information screens for future reference. To view the previous two XM Satellite Radio information screens, press TITLE on the remote control repeatedly while the current XM Satellite Radio information screen is being on hold.

# SOUND FIELD PROGRAMS

What really creates the rich, full tones of a live instrument are the multiple reflections from the walls of the room. In addition to making the sound live, these reflections enable us to tell where the player is situated as well as the size and shape of the room in which we are sitting.

## ■ Elements of a sound field

There are two distinct types of sound reflections that combine to make up the sound field in addition to the direct sound coming straight to our ears from the player's instrument.

### Early reflections

Reflected sounds reach our ears extremely rapidly (50 ms to 100 ms after the direct sound), after reflecting from one surface only (for example, from a wall or the ceiling). Early reflections actually add clarity to the direct sound.

### Reverberations

These are caused by reflections from more than one surface (for example, from the walls, and the ceiling) so numerous that they merge together to form a continuous sonic afterglow. They are non-directional and lessen the clarity of the direct sound.

Direct sound, early reflections and subsequent reverberations taken together help us to determine the subjective size and shape of the room, and it is this information that the digital sound field processor reproduces in order to create sound fields.

If you could create the appropriate early reflections and subsequent reverberations in your listening room, you would be able to create your own listening environment. The acoustics in your room could be changed to those of a concert hall, a dance floor, or a room with virtually any size at all. This ability to create sound fields at will is exactly what YAMAHA has done with the digital sound field processor.

## Selecting sound field programs

### Notes

- Choose a sound field program based on your listening preference, not merely on the name of the program.
- When you select an input source, this unit automatically selects the last sound field program used with the corresponding input source.
- Sound field programs cannot be selected when the component connected to the MULTI CH INPUT jacks is selected as the input source (see page 38).
- Sampling frequencies higher than 48 kHz (except for DTS 96/24 signals) are sampled down to 48 kHz and then sound field programs are applied.

## ■ Front panel operations

(U.S.A. model)

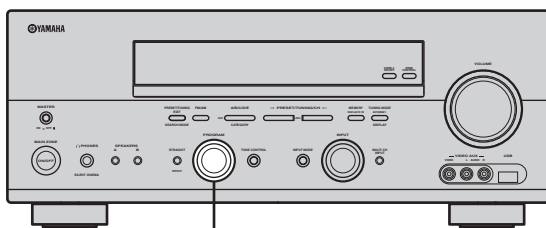

PROGRAM selector

Rotate the PROGRAM selector on the front panel.

The name of the selected sound field program appears in the front panel display and in the OSD.

## ■ Remote control operations

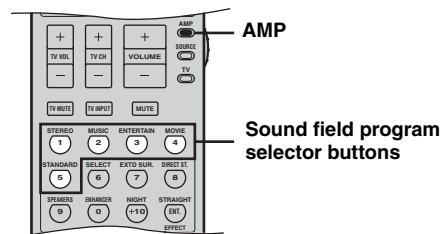

(U.S.A. model)

Set the component selector switch to AMP and then press one of the sound field program selector buttons on the remote control repeatedly.

The name of the selected sound field program appears in the front panel display and in the OSD.

## Sound field program descriptions

This unit is equipped with a variety of precise digital decoders that allow you to enjoy multi-channel playback from almost any stereo or multi-channel sound source. This unit is also equipped with a YAMAHA digital sound field processing (DSP) chip containing several sound field programs which you can use to enhance your playback experience.



The YAMAHA CINEMA DSP modes are compatible with all Dolby Digital, DTS, and Dolby Surround sources. Set "INPUT MODE" to "AUTO" (see page 35) to enable this unit to automatically switch to the appropriate digital decoder according to the input signal.

### Notes

- The DSP sound field programs of this unit are recreations of real-world acoustic environments made from precise measurements taken in the actual concert hall, music venue, movie theater, etc. Thus, you may notice variations in the strength of the reflections coming from the front, back, left and right.
- Choose a sound field program based on your listening preference, not merely on the name of the program itself.

### ■ For movie/video sources

You can select from the following sound fields when playing movie or video sources. The sound fields marked "MULTI" can be used with multi-channel sources, like DVD, digital TV, etc. Those marked "2-CH" can be used with 2-channel stereo sources like TV programs, video tapes, etc.



Rotate the PROGRAM selector on the front panel (or set the component selector switch to AMP and then press one of the sound field program selector buttons on the remote control) to select the desired sound field program (see page 65).

Remote control button	Sound field program	Features	Sources
1	STEREO 2ch Stereo	Downmixes multi-channel sources to 2 channels or plays back 2-channel sources as they are.	
2	MUSIC Pop/Rock	CINEMA DSP processing. This program creates an enthusiastic atmosphere where you can feel as if you are in an actual jazz or rock concert.	
3	ENTERTAINMENT TV Sports	CINEMA DSP processing. This program reproduces the sound environment of a large concert hall using the surround sound field to enhance your experience of watching various TV programs such as news, variety shows, music programs or sports programs.	<b>MULTI 2-CH</b>
	ENTERTAINMENT Mono Movie	CINEMA DSP processing. This program reproduces monaural video sources (such as old movies) at the optimum reverberation level to create sound depth using only the presence sound field.	
	ENTERTAINMENT Game	CINEMA DSP processing. This program adds a deep and spatial feeling to video game sounds.	

Remote control button	Sound field program	Features	Sources
4	MOVIE THEATER Spectacle	CINEMA DSP processing. This program reproduces the extremely wide sound field of a 70-mm movie theater in detail, making both the video and the sound field incredibly real. This is ideal for any kind of video source encoded in Dolby Surround, Dolby Digital or DTS, especially large-scale movie productions.	<b>MULTI 2-CH</b>
	MOVIE THEATER Sci-Fi	CINEMA DSP processing. This program reproduces dialog and sound effects in the latest sound form for science fiction films, thus creating a broad and expansive cinematic space amid silence. You can enjoy science fiction films encoded in Dolby Surround, Dolby Digital or DTS in a virtual-space sound field employing the most advanced techniques.	
	MOVIE THEATER Adventure	CINEMA DSP processing. This program reproduces the sound design of the newest 70-mm and multi-channel soundtrack films similar to the sound field of the newest movie theaters, so the reverberations of the sound field itself are restrained as much as possible.	
	MOVIE THEATER General	CINEMA DSP processing. This program reproduces sounds from 70-mm and multi-channel soundtrack films characterized by soft and extensive sound field.	
5	SUR. STANDARD	Standard processing for the selected decoder.	
	SUR. ENHANCED	Enhanced processing for the selected decoder.	

### ■ For music sources

You can select from the following sound fields when playing music sources, like CD, FM/AM broadcasting, tapes, etc.



Rotate the PROGRAM selector on the front panel (or set the component selector switch to AMP and then press one of the sound field program selector buttons on the remote control) to select the desired sound field program (see page 65).

Remote control button	Sound field program	Features	Sources
1	STEREO 2ch Stereo	Plays back 2-channel sources.	<b>2-CH</b>
	STEREO 6ch Stereo	Plays back 2-channel sources from all speakers in 6.1 channels, providing a larger sound field ideal for background music at parties, etc.	
2	MUSIC Hall in Vienna	HiFi DSP processing. This program reproduces a classic shoe-box type concert hall with approximately 1700 seats. Pillars and ornate carvings create extremely complex reflections which produce a very full, rich sound.	<b>MULTI 2-CH</b>
	MUSIC The Btm Line	HiFi DSP processing. This program reproduces the stage front in "The Bottom Line", a famous New York jazz club where 300 people can be seated.	
	MUSIC The Roxy Thtr	HiFi DSP processing. This program reproduces the dynamic rock music environment of "The Roxy Theatre", one of the hottest rock clubs in L.A. The listener's imaginary seat is at the center-left of the hall.	
3	ENTERTAINMENT Disco	HiFi DSP processing. This program reproduces the acoustic environment of a lively disco in the heart of a big city to create a highly concentrated and energetic sound.	
5	SUR. STANDARD	Standard processing for the selected decoder.	
	SUR. ENHANCED	Enhanced processing for the selected decoder.	

## Changing sound field parameter settings

You can enjoy good quality sound with the initial factory settings. Although you do not have to change the initial factory settings, you can change some of the parameters to better suit the input source or your listening room.

### Notes

- Use the “PARAM. INT” feature in “OPTION MENU” to initialize the parameters of each sound field program within a sound field program group (see page 88).
- When you set a sound field parameter to a value other than the initial factory settings, an asterisk mark (\*) appears by the sound field parameter name in the OSD.
- You cannot change the sound field parameter values when “MEMORY GUARD” in “OPTION MENU” is set to “ON” (see page 87). If you want to change the sound field parameter values, set “MEMORY GUARD” to “OFF”.



- For details about the function and control range of each sound field parameter, see page 69.
- Repeat steps 3 and 4 as necessary to change other sound field program parameter settings.
- The available sound field parameters for some of the sound field programs may be displayed on more than one page in the OSD. In this case, press ^ / v to scroll through pages.
- If you press and hold < / > to change the sound field parameter value, the initial factory settings are shown momentarily in the front panel display.

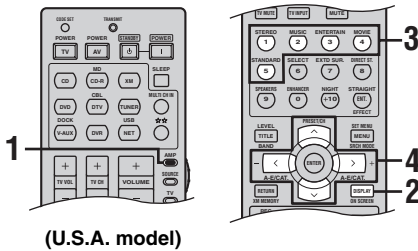

**1** Set the component selector switch to AMP.



**2** Turn on the video monitor and then press **DISPLAY** on the remote control.

The following display is shown in the OSD.

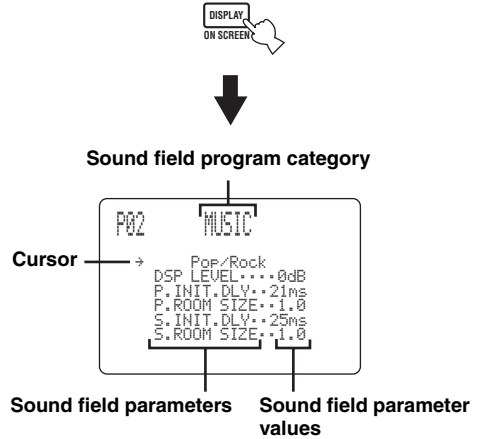

**3** Press one of the sound field program selector buttons repeatedly to select the desired sound field program you want to adjust.

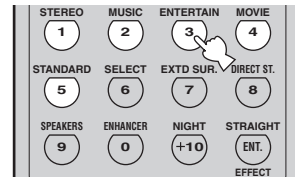

**4** Press ^ / v to select the desired sound field parameter and then < / > to change the selected sound field parameter value.

- Press > to increase the value.
- Press < to decrease the value.

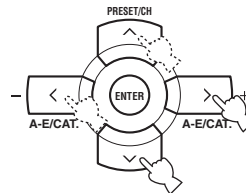



### ■ Sound field parameter descriptions

You can adjust the values of certain digital sound field parameters so that the sound fields are recreated accurately in your listening room. Not all of the following parameters are found in every program.



To change sound field parameter settings to suit your listening environment, see page 68 for details.

Sound field parameter	Features
DSP LEVEL	<p>DSP level. Adjusts the level of all the DSP effect sounds within a narrow range. Depending on the acoustics of your listening room, you may want to increase or decrease the DSP effect level relative to the level of the direct sound.</p> <hr/> <p>Control range: -6 dB to +3 dB</p>
INIT.DLY P. INIT.DLY S. INIT.DLY SB INI.DLY	<p>Initial delay. Presence, surround, and surround back initial delays. Changes the apparent distance from the source sound by adjusting the delay between the direct sound and the first reflection heard by the listener. The smaller the value, the closer the sound source seems to the listener. The larger the value, the farther it seems. For a small room, set to a small value. For a large room, set to a large value.</p> <hr/> <p>Control range: 1 to 99 ms (INIT.DLY and P.INIT.DLY)                      1 to 49 ms (S.INIT.DLY and SB INI.DLY)</p>

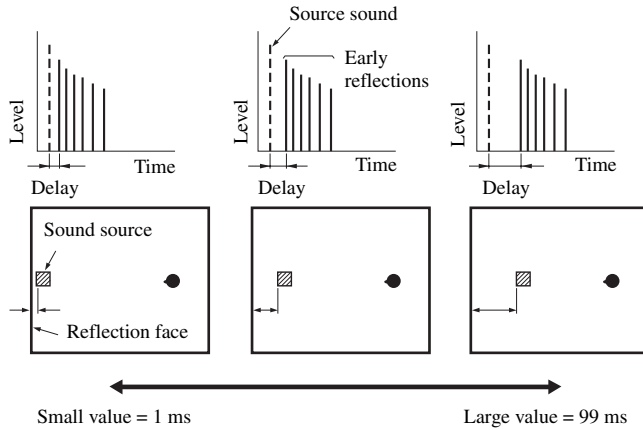

Sound field parameter	Features
ROOM SIZE P. ROOM SIZE S. ROOM SIZE SB ROOM SIZE	Room size. Presence, surround, and surround back room sizes. Adjusts the apparent size of the surround sound field. The larger the value, the larger the surround sound field becomes. As the sound is repeatedly reflected around a room, the larger the hall is, the longer the time between the original reflected sound and the subsequent reflections. By controlling the time between the reflected sounds, you can change the apparent size of the virtual venue. Changing this parameter from one to two doubles the apparent length of the room.
Control range: 0.1 to 2.0	

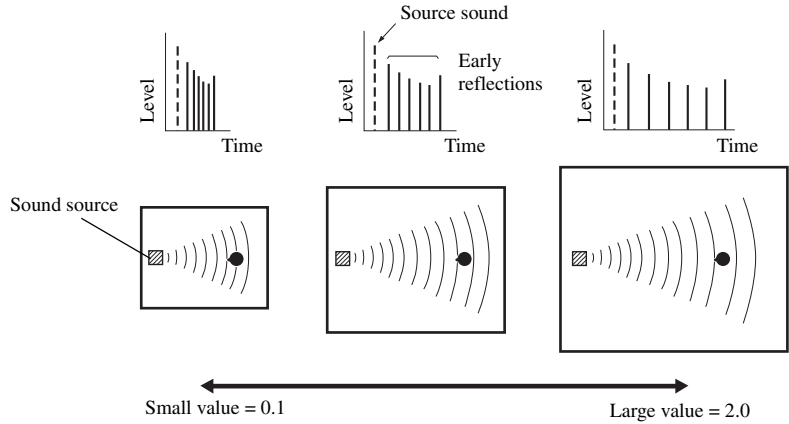

LIVENESS S. LIVENESS SB LIVENESS	Liveness. Surround and surround back liveness. Adjusts the reflectivity of the virtual walls in the hall by changing the rate at which the early reflections decay. The early reflections of a sound source decay much faster in a room with acoustically absorbent wall surfaces than in one which has highly reflective surfaces. A room with acoustically absorbent surfaces is referred to as "dead", while a room with highly reflective surfaces is referred to as "live". This parameter lets you adjust the early reflection decay rate and thus the "liveness" of the room.
Control range: 0 to 10	

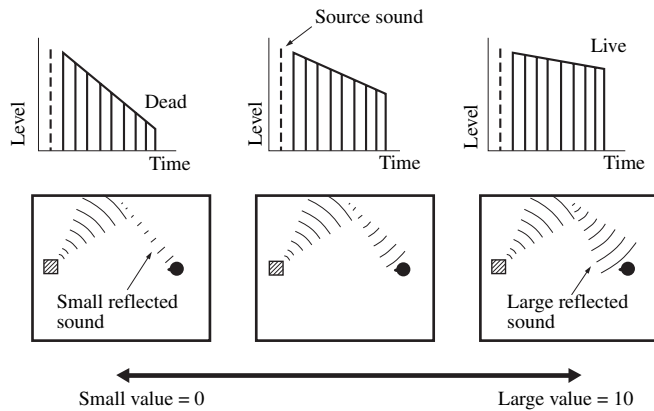

Sound field parameter	Features
-----------------------	----------

**REV.TIME**

Reverberation time. Adjusts the amount of time taken for the dense, subsequent reverberation sound to decay by 60 dB at 1 kHz. This changes the apparent size of the acoustic environment over an extremely wide range. Set a longer reverberation time for “dead” sources and listening room environments, and a shorter time for “live” sources and listening room environments.

Control range: 1.0 to 5.0 s

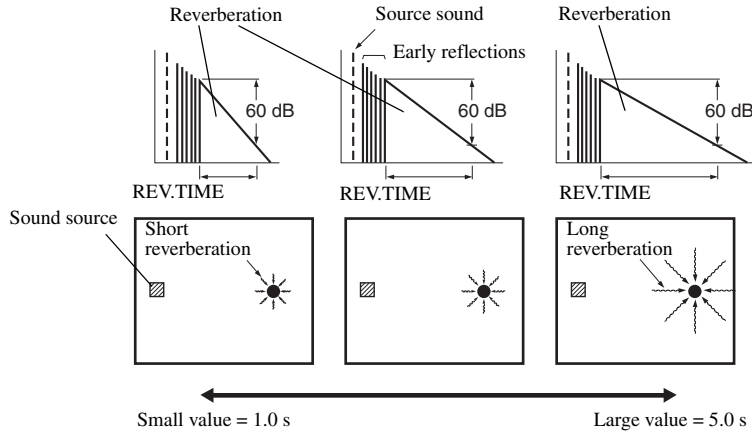



**REV.DELAY**

Reverberation delay. Adjusts the time difference between the beginning of the direct sound and the beginning of the reverberation sound. The larger the value, the later the reverberation sound begins. A later reverberation sound makes you feel as if you are in a larger acoustic environment.

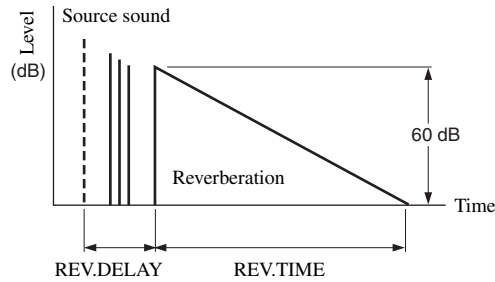
Control range: 0 to 250 ms

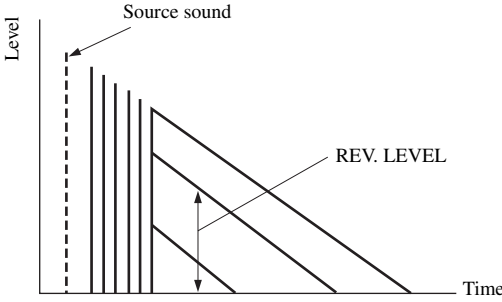

Sound field parameter	Features
REV. LEVEL	<p>Reverberation level. Adjusts the volume of the reverberation sound. The larger the value, the stronger the reverberation becomes.</p> <hr/> <p>Control range: 0 to 100%</p> <hr/>
	
2ch Stereo DIRECT	<p>2-channel stereo direct. Bypasses the decoders and DSP processors of this unit for pure hi-fi stereo sound when playing 2-channel analog sources.</p> <hr/> <p>Choices: <b>AUTO</b>, OFF</p> <hr/>
<p></p> <ul style="list-style-type: none"> <li>• The “AUTO” setting bypasses the decoders and DSP processors only when “BASS” and “TREBLE” are set to 0 dB (see page 33).</li> <li>• When multi-channel signals (Dolby Digital and DTS) are input, they are downmixed to 2 channels and output from the front left and right speakers.</li> <li>• The low-frequency signals input from the front left and right speakers are redirected to the subwoofer in the following cases: <ul style="list-style-type: none"> <li>– “LFE/BASS OUT” is set to “BOTH” (see page 78).</li> <li>– “FRONT SP” is set to “SMALL” (see page 77) and “LFE/BASS OUT” is set to “SWFR” (see page 78).</li> </ul> </li> </ul>	
6ch Stereo CT LEVEL SL LEVEL SR LEVEL SB LEVEL	<p>6-channel stereo center, surround left, surround right and surround back levels. Adjusts the volume level of each channel in the 6-channel stereo mode.</p> <hr/> <p>Control range: 0 to 100%</p> <hr/>

Sound field parameter	Features
PRO LOGIC IIx Music PRO LOGIC II Music PANORAMA	Pro Logic IIx Music and Pro Logic II Music panorama. Sends stereo signals to the surround speakers as well as the front speakers for a wraparound effect.  Choices: <b>OFF</b> , ON
PRO LOGIC IIx Music PRO LOGIC II Music DIMENSION	Pro Logic IIx Music and Pro Logic II Music dimension. Adjusts the sound field either towards the front or towards the rear.  Control range: -3 (towards the rear) to +3 (towards the front)  Initial setting: STD (standard)
PRO LOGIC IIx Music PRO LOGIC II Music CENTER WIDTH	Pro Logic IIx Music and Pro Logic II Music center width. Moves the center channel output completely towards the center speaker or towards the front left and right speakers. A larger value moves the center channel output towards the front left and right speakers.  Control range: 0 (center channel sound is output only from the center speaker) to 7 (center channel sound is output only from the front left and right speakers)  Initial setting: 3
DTS Neo:6 Music C. IMAGE	DTS Neo:6 Music center image. Adjusts the front left and right channel output relative to the center channel to make the center channel more or less dominant as necessary.  Control range: 0.0 to 1.0  Initial setting: 0.3

 The “PRO LOGIC IIx Music”, “PRO LOGIC II Music”, and “DTS Neo:6 Music” parameters can be set only when “SUR. STANDARD” is selected. Set the component selector switch to AMP and then press STANDARD on the remote control repeatedly to select “SUR. STANDARD” (see page 43).

# SET MENU

You can use the following parameters in “SET MENU” to adjust a variety of system settings and customize the way this unit operates. Change the initial settings (indicated in bold under each parameter) to reflect the needs of your listening environment.

## ■ **Basic setup** BASIC SETUP

Use this feature to set up your system quickly and with minimal effort (see page 29).

## ■ **Manual setup** MANUAL SETUP

Use this feature to manually adjust speaker and system parameters.

### **Sound menu 1** SOUND MENU

Use this menu to manually adjust any speaker settings, alter the quality and tone of the sound output by the system or compensate for video signal processing delays when using LCD monitors or projectors.

Parameter	Features	Page
A)SPEAKER SET	Selects the size of each speaker, the speakers for low-frequency signal output, and the crossover frequency.	77
B)SPEAKER LEVEL	Adjusts the output level of each speaker.	79
C)SP DISTANCE	Adjusts the delay time of each speaker.	80
D)CENTER GEQ	Adjusts the tonal quality of the center speaker.	80
E)LFE LEVEL	Adjusts the output level of the LFE channel for Dolby Digital or DTS signals.	80
F)DYNAMIC RANGE	Adjusts the dynamic range of Dolby Digital or DTS signals.	81
G)AUDIO SET	Adjusts the muting level, audio delay and tone bypass settings.	81

### **Input menu 2** INPUT MENU

Use this menu to manually reassign the input/output jacks, select the input mode or rename the input source.

Parameter	Features	Page
A)I/O ASSIGNMENT	Assigns the input/output jacks of this unit according to the component to be used.	82
B)INPUT MODE	Selects the initial input mode of the source.	83
C)INPUT RENAME	Changes the name of the input source.	83
D)VOLUME TRIM	Adjusts the output volume of each jack.	84

**Network and USB menu** 3 NET/USB MENU

Use this menu to manually adjust the network and USB system parameters.

Parameter	Features	Page
A)NETWORK	Configures the network settings automatically or manually.	84
B)PLAY STYLE	Adjusts the playback style.	85
C)INFORMATION	Displays the network system information.	86

**Option menu** 4 OPTION MENU

Use this menu to manually adjust the optional system parameters.

Parameter	Features	Page
A)DISPLAY SET	Adjusts the brightness of the display and converts video signals. Sets the OSD display time as well as the front panel display scrolling mode.	86
B)MEMORY GUARD	Locks sound field program parameters and other "SET MENU" settings.	87
C)PARAM. INI	Initializes the parameters of a group of sound field programs.	88
D)MULTI ZONE SET	Specifies the location of the speakers connected to the SPEAKERS B terminals.	88
E)XM RADIO SET	Displays the current reception level of XM Passport System.	89

**Note**

The "XM RADIO SET" parameter is only applicable to the U.S.A. and Canada models.

**■ Signal information** SIGNAL INFO

Use this feature to check audio signal information (see page 40).

## Using SET MENU

Use the remote control to access and adjust each parameter.

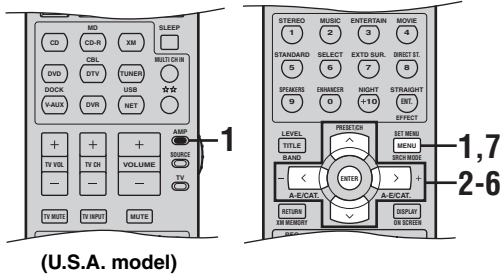

- You can change the “SET MENU” parameters while this unit is reproducing sound.
- If you press one of the sound field program selector buttons during the “SET MENU” operation, the “SET MENU” operation is canceled.
- Repeat the following procedure to select and adjust each parameter setting.
- Press RETURN to return to the previous menu level.

### Note

You cannot change some “SET MENU” parameters when “NIGHT:CINEMA” or “NIGHT:MUSIC” is selected as the night listening mode (see page 34).

## 1 Set the component selector switch to AMP and then press SET MENU to enter “SET MENU”.

The top “SET MENU” display appears in the OSD.

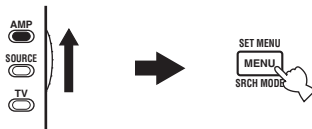

## 2 Press ^ / v to select “MANUAL SETUP”.

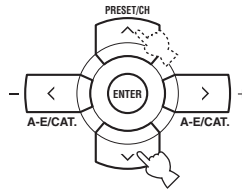

## 3 Press ENTER to enter “MANUAL SETUP”.

The “MANUAL SETUP” display appears in the OSD.

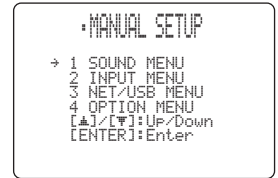
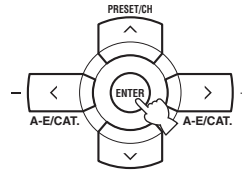

## 4 Press ^ / v repeatedly and then press ENTER to select and enter the desired menu.

The following displays are examples where “SOUND MENU” is selected.

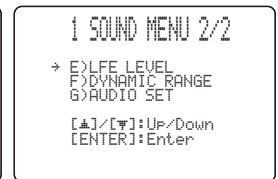
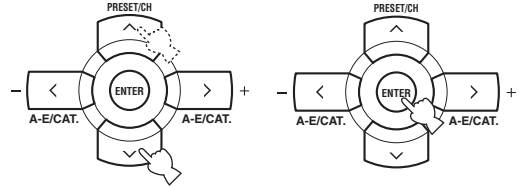



**5 Press ^/∨ repeatedly and then press ENTER to select and enter the desired submenu.**

The following display is an example where "SPEAKER LEVEL" is selected.

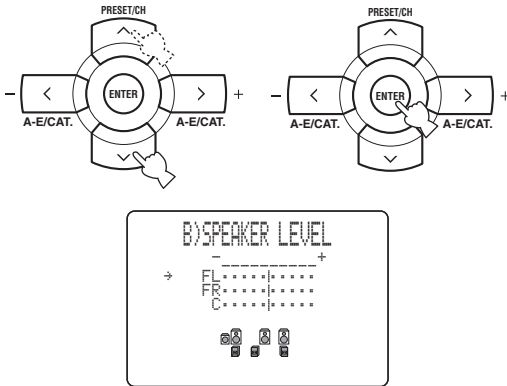

**6 Press ^/∨ to select the desired parameter and then </> to change the parameter settings.**

- Press > to increase the value.
- Press < to decrease the value.

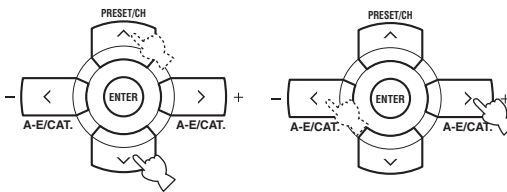

**7 Press SET MENU to exit from "SET MENU".**



**Memory back-up**

The memory back-up circuit prevents the stored data from being lost even if this unit is in the standby mode. However, the stored data will be lost in case the power cable is disconnected from the AC wall outlet or if the power supply is cut off for more than one week.

**1 SOUND MENU**

Use this menu to manually adjust any speaker settings or compensate for video signal processing delays when using LCD monitors or projectors.

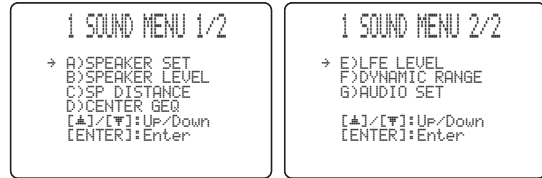

**Speaker settings A) SPEAKER SET**

Use this feature to manually adjust any speaker settings.



If you are not satisfied with the bass sounds from your speakers, you can change these settings according to your preference.

**Front speakers FRONT SP**

Choices: SMALL, LARGE

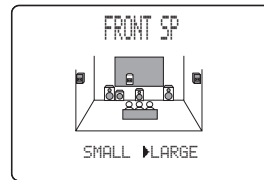

- Select "SMALL" (small) if you have small front speakers that do not reproduce low-frequency signals effectively. The low-frequency signals of the front left and right channels are directed to the speakers selected in "LFE/BASS OUT" (see page 78).
- Select "LARGE" (large) if you have large front speakers that reproduce low-frequency signals effectively. All the front left and right channel signals are directed to the front left and right speakers.

**Note**

If "LFE/BASS OUT" is set to "FRNT" (see page 78), the LFE signals found in Dolby Digital or DTS sources, the low-frequency signals of the front left and right channels, and the low-frequency signals of other speakers set to "SML" (or "SMALL") are all directed to the front left and right speakers regardless of the "FRONT SP" setting.

**Center speaker** CENTER SP

Choices: NONE, **SML**, LRG

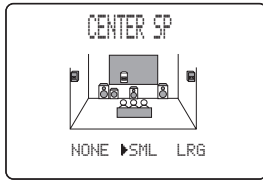

- Select “NONE” (none) if you did not connect a center speaker. The center channel signals are directed to the front left and right speakers.
- Select “SML” (small) if you have a small center speaker that does not reproduce low-frequency signals effectively. The low-frequency signals of the center channel are directed to the speakers selected in “LFE/BASS OUT”.
- Select “LRG” (large) if you have a large center speaker that reproduces low-frequency signals effectively. All the center channel signals are directed to the center speaker.

**Surround left/right speakers** SUR. L/R SP

Choices: NONE, **SML**, LRG

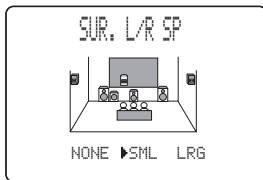

- Select “NONE” (none) if you did not connect surround speakers. This unit is set to the Virtual CINEMA DSP mode (see page 44) and “SUR. B SP” is automatically set to “NONE”.
- Select “SML” (small) if you have small surround left and right speakers that do not reproduce low-frequency signals effectively. The low-frequency signals of the surround left and right channels are directed to the speakers selected in “LFE/BASS OUT”.
- Select “LRG” (large) if you have large surround left and right speakers that reproduce low-frequency signals effectively. All the surround channel signals are directed to the surround left and right speakers.

**Surround back speakers** SUR. B SP

Choices: NONE, **SML**, LRG

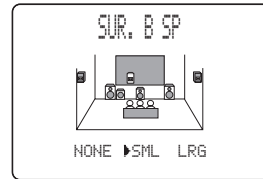

- Select “NONE” (none) if you did not connect a surround back speaker. The surround back channel signals are directed to the surround left and right speakers.
- Select “SML” (small) if you have a small surround back speaker that does not reproduce low-frequency signals effectively. The low-frequency signals of the surround back channel are directed to the speakers selected in “LFE/BASS OUT”.
- Select “LRG” (large) if you have a large surround back speaker that reproduces low-frequency signals effectively. All the surround back channel signals are directed to the surround back speaker.

**Bass out** LFE/BASS OUT

Use this feature to select the speakers that output the LFE (low-frequency effect) and the low-frequency signals.

Choices: SWFR, FRNT, **BOTH**

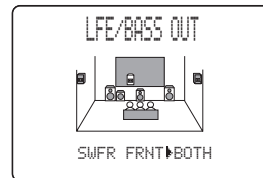

- Select “SWFR” (subwoofer) if you connected a subwoofer. The LFE signals as well as the low-frequency signals of other speakers set to “SML” (or “SMALL”) are directed to the subwoofer.
- Select “FRNT” (front) if you did not connect a subwoofer. The LFE signals, the low-frequency signals of the front left and right channels, and the low-frequency signals of other speakers set to “SML” (or “SMALL”) are all directed to the front left and right speakers regardless of the “FRONT SP” setting (see page 77).
- Select “BOTH” (both) if you connected a subwoofer. The low-frequency signals of any source are output from the subwoofer. The LFE signals as well as the low-frequency signals of other speakers set to “SML” (or “SMALL”) are directed to the subwoofer. The low-frequency signals of the front left and right channels are directed to the front left and right speakers and the subwoofer regardless of the “FRONT SP” setting (see page 77).

**Crossover** CROSSOVER

Use this feature to select a crossover frequency of all the speakers set to “SML” (or “SMALL”) or to “NONE” in “SPEAKER SET” (see pages 77 and 78). All frequencies below the selected frequency will be sent to the subwoofer or to the speakers set to “LRG” (or “LARGE”) in “SPEAKER SET” (see pages 77 and 78).

Choices: 40Hz, 60Hz, **80Hz**, 90Hz, 100Hz, 110Hz, 120Hz, 160Hz, 200Hz

**Subwoofer phase** SUBWOOFER PHASE

Use this feature to switch the phase of your subwoofer if bass sounds are lacking or unclear.

Choices: **NORMAL**, REVERSE

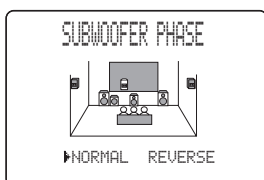

- Select “NORMAL” if you do not want to reverse the phase of your subwoofer.
- Select “REVERSE” to reverse the phase of your subwoofer.

**Speaker level** B)SPEAKER LEVEL

Use this feature to manually balance the speaker levels between the front left or surround left speakers and each speaker selected in “SPEAKER SET” (see page 77).

Control range: -10.0 to +10.0 dB

Control step: 1.0 dB

Initial setting: 0 dB

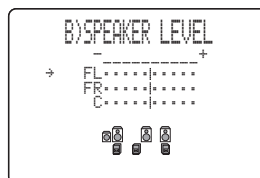

- Select “FL” to adjust the balance of the front left speaker.
- Select “FR” to adjust the balance of the front right speaker.
- Select “C” to adjust the balance of the center speaker.
- Select “SL” to adjust the balance of the surround left speaker.
- Select “SR” to adjust the balance of the surround right speaker.
- Select “SB” to adjust the balance of the surround back speaker.
- Select “SWFR” to adjust the balance of the subwoofer.

**Note**

“C”, “SL”, “SR”, “SB” and “SWFR” cannot be adjusted if “CENTER SP” (see page 78), “SUR. L/R SP” (see page 78), “SUR. B SP” (see page 78) and “LFE/BASS OUT” (see page 78) are set to “NONE” respectively.

■ **Speaker distance** C)SP DISTANCE

Use this feature to manually adjust the distance of each speaker and the delay applied to the respective channel. Ideally, each speaker should be the same distance from the main listening position. However, this is not possible in most home situations. Thus, a certain amount of delay must be applied to the sound from each speaker so that all sounds will arrive at the listening position at the same time.

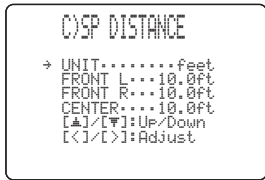

**Unit** UNIT

Choices: meters (m), **feet** (ft)

Initial setting:

[U.S.A. and Canada models]: feet (ft)

[Other models]: meters (m)

- Select “meters” to adjust speaker distances in meters.
- Select “feet” to adjust speaker distances in feet.

**Speaker distances**

Control range: 0.30 to 24.00 m (1.0 to 80.0 ft)

Control step: 0.10 m (0.5 ft)

- Select “FRONT L” to adjust the distance of the front left speaker.  
Initial setting: 3.00 m (10.0 ft)
- Select “FRONT R” to adjust the distance of the front right speaker.  
Initial setting: 3.00 m (10.0 ft)
- Select “CENTER” to adjust the distance of the center speaker.  
Initial setting: 3.00 m (10.0 ft)
- Select “SUR. L” to adjust the distance of the surround left speaker.  
Initial setting: 3.00 m (10.0 ft)
- Select “SUR. R” to adjust the distance of the surround right speaker.  
Initial setting: 3.00 m (10.0 ft)
- Select “SUR. B” to adjust the distance of the surround back speaker.  
Initial setting: 2.10 m (7.0 ft)
- Select “SWFR” to adjust the distance of the subwoofer.  
Initial setting: 3.00 m (10.0 ft)

**Note**

“CENTER”, “SUR.L”, “SUR.R”, “SUR.B” and “SWFR” cannot be adjusted if “CENTER SP” (see page 78), “SUR. L/R SP” (see page 78), “SUR. B SP” (see page 78) and “LFE/BASS OUT” (see page 78) are set to “NONE” respectively.

■ **Center graphic equalizer** D)CENTER GEQ

Use this feature to adjust the built-in 5-frequency band (100Hz, 300Hz, 1kHz, 3kHz and 10kHz) graphic equalizer for the center channel so that the tonal quality of the center speaker matches that of the front speakers. You can make adjustments while listening to the currently selected source component or a test tone.

Control range: -6 to +6 dB

Control step: 0.5 dB

Initial setting: 0 dB

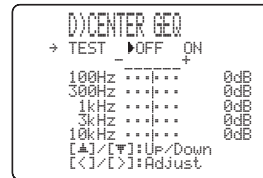

**Test tone** TEST

Choices: **OFF**, ON

- Select “OFF” to stop test tones and output the currently selected source component.
- Select “ON” to output test tones from the front left and center speakers, and adjust the tonal quality of the center speaker.



Press ^ / v to select a frequency band and < / > to adjust the selected frequency band.

■ **Low-frequency effect level** E)LFE LEVEL

Use this feature to adjust the output level of the LFE (low-frequency effect) channel according to the capacity of your subwoofer or headphones. The LFE channel carries low-frequency special effects which are only added to certain scenes. This setting is effective only when this unit decodes Dolby Digital or DTS signals.

Control range: -20 to 0 dB

Control step: 1 dB



**Speaker** SPEAKER

Adjusts the speaker LFE level.

**Headphone** HEADPHONE

Adjusts the headphone LFE level.

**Note**

Depending on the settings of “LFE/BASS OUT” (see page 78), some signals may not be output at the SUBWOOFER OUTPUT jack.

## ■ Dynamic range F)DYNAMIC RANGE

Use this feature to select the amount of dynamic range compression to be applied to your speakers or headphones. This setting is effective only when this unit is decoding Dolby Digital and DTS signals.

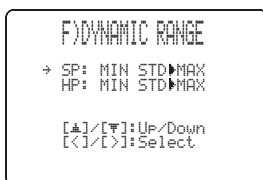

### Speaker SP

Adjusts the speaker compression.

### Headphone HF

Adjusts the headphone compression.

Choices: MIN, STD, **MAX**

- Select “MIN” (minimum) if you regularly listen at low volume levels.
- Select “STD” (standard) for general use.
- Select “MAX” (maximum) to preserve the greatest amount of dynamic range.

## ■ Audio settings G)AUDIO SET

Use this feature to adjust the overall audio settings of this unit.



### Muting type MUTING TYPE

Use this feature to adjust how much the mute function reduces the output volume (see page 34).

Choices: **FULL**, -20dB

- Select “FULL” to completely mute all the audio output.
- Select “-20dB” to reduce the current volume by 20 dB.

### Audio delay AUDIO DELAY

Use this feature to delay the sound output and synchronize it with the video image. This may be necessary when using certain LCD monitors or projectors.

Control range: **0** to 160 ms

Control step: 1 ms

### Tone bypass TONE BYPASS

Use this feature to select whether audio output bypasses tone control circuitry when “TREBLE” and “BASS” are set to 0 dB (see page 33).

Choices: **AUTO**, OFF

- Select “AUTO” if you want signals to bypass tone control circuitry to provide the purest signal possible.
- Select “OFF” if you do not want signals to bypass tone control circuitry.

## 2 INPUT MENU

Use this menu to reassign the input/output jacks, select the input mode or rename the input source.

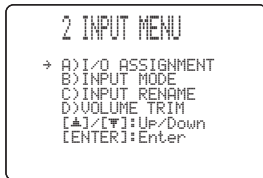

### ■ Input/output assignment

#### A) I/O ASSIGNMENT

Use this feature to assign the input/output jacks according to the component to be used if the initial settings of this unit do not correspond to your needs. Change the following parameters to reassign the respective jacks and effectively connect more components.

Once the input/output jacks are reassigned, you can select the corresponding component by using the INPUT selector on the front panel (or the input selector buttons on the remote control).

#### For COMPONENT VIDEO jacks A, B and C

COMPNT-V INPUT [A]

COMPNT-V INPUT [B]

COMPNT-V INPUT [C]

Choices: [A] **DVD**, DTV/CBL, V-AUX, DVR  
 [B] DVD, **DTV/CBL**, V-AUX, DVR  
 [C] DVD, DTV/CBL, V-AUX, **DVR**

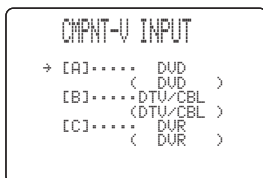

#### For OPTICAL OUTPUT jack 1 OPTICAL OUT (1)

Choices: CD, **MD/CD-R**, DVD, DTV/CBL, V-AUX, DVR

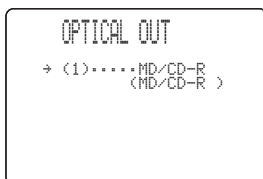

#### For OPTICAL INPUT jacks 2, 3 and 4

OPTICAL IN (2)

OPTICAL IN (3)

OPTICAL IN (4)

Choices: (2) CD, **MD/CD-R**, DVD, DTV/CBL, V-AUX, DVR  
 (3) CD, MD/CD-R, **DVD**, DTV/CBL, V-AUX, DVR  
 (4) CD, MD/CD-R, DVD, **DTV/CBL**, V-AUX, DVR

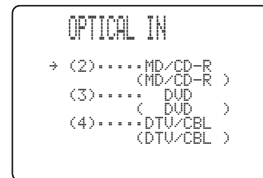

#### For COAXIAL INPUT jack 5 COAXIAL IN (5)

Choices: (5) CD, MD/CD-R, **DVD**, DTV/CBL, V-AUX, DVR

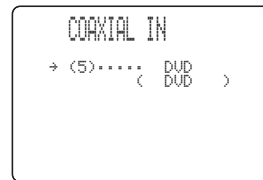

### Notes

- You cannot select a specific item more than once for the same type of jack.
- When you connect a component to both the DIGITAL INPUT (COAXIAL) and DIGITAL INPUT (OPTICAL) jacks, priority is given to the signals input at the DIGITAL INPUT (COAXIAL) jack.

**Input mode B) INPUT MODE**

Use this feature to set this unit to reset “INPUT MODE” back to “AUTO” (see page 35) regardless of the previous setting or to recall the last input mode (“AUTO”, “DTS”, or “ANALOG”) used for that source whenever you turn on this unit.

Choices: **AUTO**, **LAST**



- Select “AUTO” to reset “INPUT MODE” back to “AUTO” (see page 35) regardless of the previous setting whenever you turn on this unit. This unit automatically selects input signals in the following order:
  - (1) Digital signals
  - (2) Analog signals
- Select “LAST” to set this unit to automatically recall the last input mode (“AUTO”, “DTS”, or “ANALOG”) used for that source whenever you turn on this unit.

**Input rename C) INPUT RENAME**

Use this feature to change the name of the input source that appears in the OSD and in the front panel display.

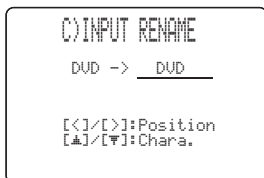

- 1 Press one of the input selector buttons on the remote control to select the input source you want to change the name of.**

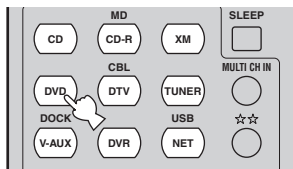

- 2 Press </> on the remote control to place the “\_” (underscore) under the space or the character you want to edit.**

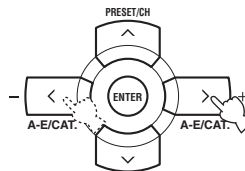

- 3 Press ^/∨ to select the character you want to use and then press </> to move to the next space.**

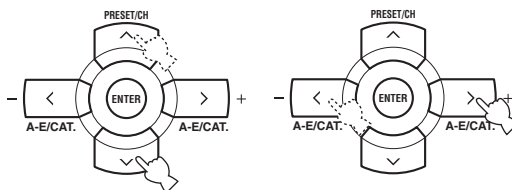

**Notes**

- You can use up to 8 characters for each input.
- Press ∨ to change the character in the following order, or press ^ to go in the reverse order:  
A to Z, a space, 0 to 9, a space, a to z, a space, symbols (#, \*, +, -, etc.)

- 4 Repeat steps 1 through 3 to rename each input source.**

- 5 Press ENTER on the remote control to exit from “INPUT RENAME”.**

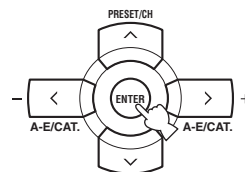

### ■ Volume trim D)VOLUME TRIM

Use this feature to adjust the level of the signal input at each jack. This is useful if you want to balance the level of each input source to avoid sudden changes in volume when switching between input sources.

Choices: CD, MD/CD-R, TUNER, DVD, DTV/CBL, V-AUX, DOCK, DVR, PC/MCX, USB, NET RADIO, MULTI CH IN

Control range: -6.0 to +6.0 dB

Control step: 1.0 dB

Initial setting: 0.0 dB

```
D)VOLUME TRIM
          DVD
DVD -> 0.0dB
[<]/[>]:Adjust
[RETURN]:Exit
```

## 3 NET/USB MENU

Use this menu to adjust the network and USB system parameters.

```
3 NET/USB MENU
-> A)NETWORK
  B)PLAY STYLE
  C)INFORMATION
[▲]/[▼]:Up/Down
[ENTER]:Enter
```

### ■ Network settings A)NETWORK

Use this feature to view the network parameters (IP address, etc.) or to change them manually.

```
A)NETWORK
-> DHCP      ON
IP          192.168.000.002
SUBNET     255.255.255.000
GATEWAY    192.168.000.001
DNS (P)    192.168.000.001
DNS (S)    000.000.000.000
SET        >CANCEL
[▲]/[▼]:Up/Down
[ENTER]:Enter
```

#### Note

The above display is an example.

#### DHCP DHCP

When this parameter is set to “ON”, network parameters for “IP”, “SUBNET”, “GATEWAY”, “DNS (P)” and “DNS (S)” obtained from a DHCP enabled router are displayed. If DHCP server function is not available, set this parameter to “OFF” to configure the network parameters manually.

Choices: **ON**, OFF

#### IP address IP

Use this parameter to specify an IP address assigned to this unit. This value must not duplicate the one used for other devices in the target network.

#### Subnet mask SUBNET

Use this parameter to specify the subnet mask value assigned to this unit.



For most of the cases, the subnet mask value can be set as “255.255.255.0”.

#### Default gateway GATEWAY

Use this parameter to specify the IP address of the default gateway.



**Primary DNS server** DNS (P)

**Secondary DNS server** DNS (S)

Use this parameter to specify the IP address of the primary and secondary DNS (Domain Name System) servers.

#### Note

If you have only one DNS address, enter the DNS address in “DNS (P)”. If you have two or more DNS addresses, enter one of them in “DNS (P)” and another in “DNS (S)”.

**1 Press  $\wedge$ / $\vee$  on the remote control repeatedly and then press ENTER to select and enter the desired network parameter.**

#### Note

When “DHCP” is set to “ON”, you cannot select and adjust any other network settings. To specify the other parameters, you need to first set “DHCP” to “OFF”.

**2 To specify the parameter, press  $\wedge$ / $\vee$  repeatedly to change the number and press  $\langle$ / $\rangle$  to select the digit to change.**

**3 Press ENTER to confirm the parameter.**

**4 Repeat steps 1 through 3 to configure each network parameter.**

**5 Select “SET” and then press ENTER to finish configuration.**

#### Note

In case you have changed your network configuration, you may need to reconfigure the network settings again.



You can reset the network settings of this unit to the initial factory settings by using “N-RESET” in the advanced setup menu (see page 91).

## ■ Playback styles B)PLAY STYLE

Use this feature to adjust the playback style according to your preference. You can shuffle songs in a random order or repeat one specific song or a sequence of songs.



### Repeat REPEAT

Use this feature to set this unit to repeat one song or a sequence of songs.

Choices: **OFF**, SINGLE, ALL

- Select “OFF” to deactivate this feature.
- Select “SINGLE” to set this unit to repeat one song.
- Select “ALL” to set this unit to repeat a sequence of songs.

#### Notes

- When “REPEAT” is set to a setting other than “OFF”, the highlighted letter “R” appears in the top right corner of the playback status screen while one song or a sequence of songs are being repeated.
- If “REPEAT” is set to “SINGLE”, the setting will be reset to “OFF” when both the main zone and Zone 2 are turned off.

### Shuffle SHUFFLE

Use this feature to set this unit to play songs or albums in a random order.

Choices: **OFF**, ON

- Select “OFF” to deactivate this feature.
- Select “ON” to set this unit to play songs or albums in a random order.

#### Note

When “SHUFFLE” is set to “ON”, the highlighted letter “S” appears in the top right corner of the playback status screen while songs or albums are being shuffled.

■ **Network information** C)INFORMATION

Use this feature to display the network system information.

```
C)INFORMATION
MAC ADDRESS
XX:XX:XX:XX:XX:XX
STATUS
10BASE-T
FULL-DUPLEX
[ENTER]:Return
```

**Note**

The above display is an example.

■ **MAC (Media Access Control) address**

MAC ADDRESS

This information displays the MAC address that is assigned to this unit.

■ **Status** STATUS

This information displays the current link status of the network.

Display status: 10BASE-T, 100BASE-TX,  
FULL-DUPLEX, HALF-DUPLEX,  
NO LINK

**Note**

“NO LINK” appears when network connection is not made.

**4 OPTION MENU**

Use this menu to adjust the optional system parameters.

```
4 OPTION MENU 1/2
→ A)DISPLAY SET
B)MEMORY GUARD
C)PARAM. INI
D)MULTI ZONE SET
[▲]/[▼]:Up/Down
[ENTER]:Enter
```

```
4 OPTION MENU 2/2
→ E)XM RADIO SET

[▲]/[▼]:Up/Down
[ENTER]:Enter
```

■ **Display settings** A)DISPLAY SET

```
A)DISPLAY SET
→ DIMMER.....0
VIDEO CONV.....0
OSD SHIFT.....0
GRAY BACK...AUTO
[▲]/[▼]:Up/Down
[<]/[>]:Select
```

```
A)DISPLAY SET
→ ON SCREEN...10s
FL SCROLL...CONT

[▲]/[▼]:Up/Down
[<]/[>]:Select
```

■ **Dimmer** DIMMER

Use this feature to adjust the brightness of the front panel display.

Control range: -4 to 0

Control step: 1

- Press < to make the front panel display dimmer.
- Press > to make the front panel display brighter.

■ **Video conversion** VIDEO CONV.

Use this feature to set whether to convert the video signals input at the VIDEO and S VIDEO jacks.

Choices: ON, OFF

- Select “ON” to convert composite and S-video signals interchangeably and up-convert composite and S-video signals to component video signals.
- Select “OFF” not to convert any signals.

**Notes**

- The converted video signals are only output at the MONITOR OUT jacks. When recording a video source, you must make the same type of video connections between each component.
- When composite video or S-video signals from a VCR are converted to component video signals, the picture quality may suffer depending on your VCR.
- You must set “VIDEO CONV.” to “ON” to display the OSD.
- Unconventional signals input at the composite video or S-video jacks cannot be converted or may be output abnormally. In such cases, set “VIDEO CONV.” to “OFF”.

**OSD shift** OSD SHIFT

Use this feature to adjust the vertical position of the OSD.

Control range: -5 (upward) to +5 (downward)

Control step: 1

Initial setting: 0

- Press < to raise the position of the OSD.
- Press > to lower the position of the OSD.

**Gray back** GRAY BACK

Use this feature to display a gray background in the OSD when there is no video signal being input.

Choices: **AUTO**, OFF

- Select "AUTO" to display a gray background in the OSD when there is no video signal being input.
- Select "OFF" not to display any background in the OSD.

**Notes**

- Depending on the video signals being input or the system setting of your video monitor (NTSC or PAL), the OSD may be displayed abnormally. In such cases, set "GRAY BACK" to "OFF".
- Even when "GRAY BACK" is set to "OFF", the OSD may not be displayed correctly depending on the conditions of the picture.

**On-screen display time** ON SCREEN

Use this feature to set the amount of time to display the XM Satellite Radio information, iPod menu or NET/USB menu in the OSD after you perform a certain operation.

Choices: ON, **10s**, 30s

- Select "ON" to display the OSD unceasingly during an operation.
- Select "10s" to turn off the OSD 10 seconds after you perform a certain operation.
- Select "30s" to turn off the OSD 30 seconds after you perform a certain operation.

**Front panel display scroll** FL SCROLL

Use this feature to set whether to display the information (such as song title or channel name) in the front panel display in a continuous manner or by the first 14 alphanumeric characters after scrolling all characters once when "XM", "DOCK" or "NET/USB" is selected as the input source.

Choices: **CONT**, ONCE

- Select "CONT" to display the operation status in the front panel display in a continuous manner.
- Select "ONCE" to display the operation status in the front panel display by the first 14 alphanumeric characters after scrolling all characters once.

**Memory guard** B)MEMORY GUARD

Use this feature to prevent accidental changes to DSP program parameter values and other system settings.

Choices: **OFF**, ON



- Select "OFF" to turn off the "MEMORY GUARD" feature.
- Select "ON" to protect:
  - DSP program parameters
  - all "SET MENU" items
  - all speaker levels

**Note**

When "MEMORY GUARD" is set to "ON", you cannot select and adjust any other "SET MENU" items.

## ■ Parameter initialization C)PARAM. INI

Use this feature to initialize the parameters of each sound field program within a sound field program group. When you initialize a sound field program group, all of the parameter values within that group revert to their initial factory settings.

Press the corresponding sound field program selector buttons on the remote control to select the sound field program that you want to initialize.

An asterisk (\*) appears to the left of the sound field program names that have been changed from their initial factory settings.

Choices: STEREO, MUSIC, ENTERTAINMENT, MOVIE THEATER, STANDARD

```

C)PARAM. INI
  STEREO
 *MUSIC
 ENTERTAINMENT
 MOVIE THEATER
 *STANDARD
 Press DSP key
  
```

### Notes

- You cannot automatically revert to the previous parameter settings once you initialize a sound field program group.
- You cannot separately initialize individual sound field programs.
- You cannot initialize any sound field program groups when "MEMORY GUARD" is set to "ON" (see page 87).

## ■ Zone set D)MULTI ZONE SET

Use this feature to specify the location of speakers connected to the SPEAKERS B terminals of this unit.

```

D)MULTI ZONE SET
→ SP B.....FRONT

[<]/[>]:Select
[ENTER]:Return
  
```

### Speaker B setting SP B

Use this feature to select the location of the front speakers connected to the SPEAKERS B terminals.

Choices: **FRONT**, ZONE B

- Select "FRONT" to turn on or off SPEAKERS A and B when the speakers connected to the SPEAKERS B terminals are set in the main zone.
- Select "ZONE B" if the speakers connected to the SPEAKERS B terminals are set in another zone. If SPEAKERS A is turned off and SPEAKERS B is turned on, all the speakers including the subwoofer in the main zone are muted and this unit outputs sound at the SPEAKERS B terminals only.

### Notes

- If you connect headphones to the PHONES jack of this unit, the sound is output from both headphones and the SPEAKERS B terminals when "SP B" is set to "ZONE B".
- If a DSP program is selected when "SP B" is set to "ZONE B", this unit automatically enters the Virtual CINEMA DSP mode (see page 44).

## ■ XM Radio setting E>XM RADIO SET (U.S.A. and Canada models only)

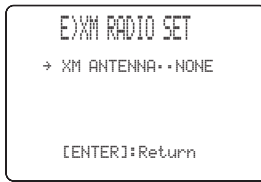

### Radio antenna XM ANTENNA

Use this feature to check the current reception level of XM Passport System connected to the XM jack of this unit (see page 54). For the best reception, orient XM Passport System so that a value of 60% or more is displayed here.  
 Display status: NONE, 0 to 100%

#### Notes

- “NONE” is displayed if XM Passport System is not connected to this unit. In this case, check the antenna connections (see page 54).
- The “XM ANTENNA” parameter cannot be adjusted by using the remote control. Instead, you need to adjust the orientation of XM Passport System connected to the XM jack of this unit for a better percentage of the reception level.

# ADVANCED SETUP

This unit has additional menus that are displayed in the front panel display. The advanced setup menu offers additional operations to adjust and customize the way this unit operates. Change the initial settings (indicated in bold under each parameter) to reflect the needs of your listening environment.

## Notes

- The settings you make are reflected next time you press MASTER ON/OFF inward to the ON position to turn on this unit (see page 28).
- Only MASTER ON/OFF, STRAIGHT (EFFECT) and the PROGRAM selector are effective while you are using the advanced setup menu.
- All the other operations cannot be made while you are using the advanced setup menu.
- The advanced setup menu is only available in the front panel display.

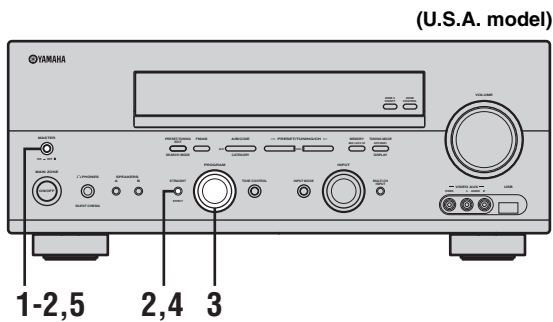

- 1 Press MASTER ON/OFF on the front panel to release it outward to the OFF position to turn off this unit.**



- 2 Press and hold STRAIGHT (EFFECT) on the front panel, and then press MASTER ON/OFF inward to the ON position to turn on this unit.** This unit turns on, and the advanced setup menu appears in the front panel display.

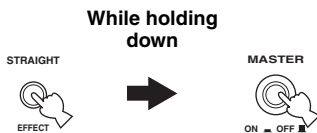

- 3 Rotate the PROGRAM selector on the front panel to select the parameter you want to adjust.**

The name of the selected parameter appears in the front panel display. See page 91 for a complete list of available parameters.

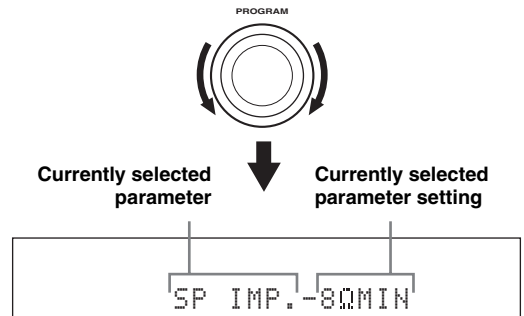

- 4 Press STRAIGHT (EFFECT) on the front panel repeatedly to change the selected parameter setting.**



- 5 Press MASTER ON/OFF on the front panel to release it outward to the OFF position to save the new setting and turn off this unit.**



The settings you made are reflected next time you turn on this unit.

**Speaker impedance** SP IMP.

Use this feature to set the speaker impedance of this unit so that it matches that of your speakers.

Choices: **8ΩMIN**, **6ΩMIN**

- Select “8ΩMIN” to set the speaker impedance to 8 Ω .
- Select “6ΩMIN” to set the speaker impedance to 6 Ω .

SP IMP.	Speaker	Impedance level
8ΩMIN	Front	If you use one set (A or B), the impedance of each speaker must be 8 Ω or higher. <hr/> If you use two sets (A and B), the impedance of each speaker must be 16 Ω or higher.*
	Center	
	Surround	The impedance of each speaker must be 8 Ω or higher.
	Surround back	
6ΩMIN	Front	If you use one set (A or B), the impedance of each speaker must be 4 Ω or higher. <hr/> If you use two sets (A and B), the impedance of each speaker must be 8 Ω or higher.
	Center	
	Surround	The impedance of each speaker must be 6 Ω or higher.
	Surround back	

\* The Canada model cannot use two separate speaker systems (A and B) simultaneously when “SP IMP.” is set to “8ΩMIN”.

**Factory presets** PRESET

Use this feature to reset all the parameters of this unit to the initial factory settings (see page 108).

Choices: **CANCEL**, **RESET**

- Select “CANCEL” not to reset any parameters of this unit.
- Select “RESET” to reset the parameters of this unit.

**Notes**

- This setting completely resets all the parameters of this unit including the “SET MENU” parameters. However, the advanced setup menu parameters will not be initialized.
- The initial factory settings are activated next time you turn on this unit.

**Network reset** N-RESET

Use this feature to reset the network settings of this unit (see page 84) to the initial factory settings.

Choices: **CANCEL**, **RESET**

- Select “CANCEL” not to reset any network settings of this unit.
- Select “RESET” to reset the network settings of this unit.

**Notes**

- The initial factory settings are activated next time you turn on this unit.
- When the network settings are reset, “DHCP” in “NET/USB MENU” is automatically set to “ON” (see page 84) and the registered client ID of this unit on your YAMAHA MCX-2000 is cleared (see page 105).

**Remote control AMP ID** REMOTE AMP

Use this feature to set the AMP ID of this unit for remote control recognition (see page 96).

Choices: **ID1**, **ID2**

- Select “ID1” when the remote control AMP ID library code is set to “00001”.
- Select “ID2” when the remote control AMP ID library code is set to “00002”.

**Note**

You need to set the corresponding remote control AMP library code for the remote control (see page 96).

### ■ Remote control TUNER ID REMOTE TUN

Use this feature to set the TUNER ID of this unit for remote control recognition (see page 96).

Choices: **ID1**, ID2

- Select “ID1” when the remote control TUNER ID library code is set to “81916”.
- Select “ID2” when the remote control TUNER ID library code is set to “81917”.

#### Note

You need to set the corresponding remote control TUNER library code for the remote control (see page 96).

### ■ Remote control XM ID REMOTE XM (U.S.A. and Canada models only)

Use this feature to set the XM ID of this unit for remote control recognition (see page 97).

Choices: **ID1**, ID2

- Select “ID1” when the remote control XM ID library code is set to “81918”.
- Select “ID2” when the remote control XM ID library code is set to “81919”.

#### Note

You need to set the corresponding remote control XM library code for the remote control (see page 97).

### ■ Tuner frequency step TU (General model only)

Use this feature to set the tuner frequency step according to the frequency spacing in your area.

Choices: **AM10/FM100**, AM9/FM50

- Select “AM10/FM100” for North, Central and South America.
- Select “AM9/FM50” for all other areas.



# REMOTE CONTROL FEATURES

In addition to controlling this unit, the remote control can also operate other audiovisual components made by YAMAHA and other manufacturers. To control your TV or other components, you must set the appropriate remote control code for each input source (see page 95).

## Controlling this unit, a TV, or other components

### ■ Controlling this unit

Set the component selector switch to AMP to control this unit.

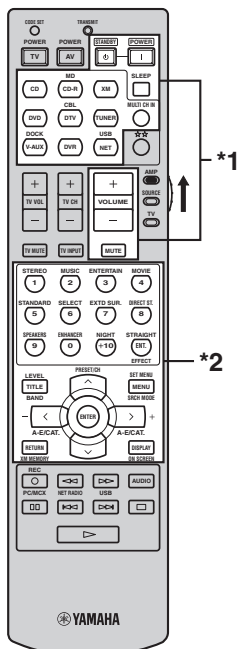

(U.S.A. model)

### ■ Controlling a TV

Set the component selector switch to TV to control your TV. To control your TV, you must set the appropriate remote control code for DTV/CBL or ☆☆ (see page 95). When you set the remote control codes for both DTV/CBL and ☆☆, priority is given to the one set for DTV/CBL.

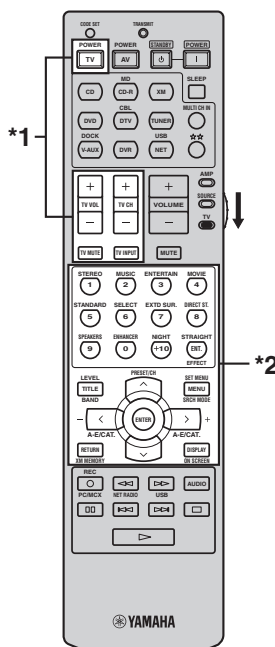

(U.S.A. model)

### Notes

\*1 These buttons always control this unit regardless of the component selector switch position.

\*2 These buttons control this unit only when the component selector switch is set to AMP.

### Notes

\*1 These buttons always control your TV regardless of the component selector switch position.

Remote control	Digital TV/Cable TV
TV POWER	Turns on or off the power.
TV VOL +/-	Increases or decreases the volume level.
TV CH +/-	Changes the channel number.
TV MUTE	Mutes the audio output.
TV INPUT	Changes the input source.

\*2 These buttons control your TV only when the component selector switch is set to TV. For details, see the "Digital TV/Cable TV" column on page 94.

**Controlling other components**

Set the component selector switch to SOURCE to control other components selected with the input selector buttons or ☆☆. You must set the appropriate remote control code for each input source (see page 95). The following table shows the function of each control button used to control other components assigned to each input selector button and ☆☆. Be advised that some buttons may not correctly operate the selected component.

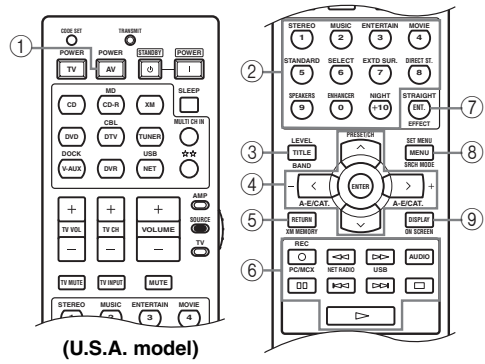

Remote control	DVD player/ recorder	VCR	Digital TV/ Cable TV	LD/CD player	MD/CD recorder	Tuner	iPod®	PC/MCX-2000/ Internet radio/ USB
① AV POWER	Power *1	Power *1	Power *2	Power *1	Power *1			
② 1-9, 0, +10	Numeric buttons	Numeric buttons	Numeric buttons	Numeric buttons	Numeric buttons	Preset stations (1-8)		
③ TITLE	Title					Band		Bookmark *5
④ PRESET/CH ^	Up	VCR channel up	Up			Preset up (1-8)	Up	Up
PRESET/CH v	Down	VCR channel down	Down			Preset down (1-8)	Down	Down
A-E/CAT. <	Left		Left			Preset down (A-E)	Previous menu	Previous menu
A-E/CAT. >	Right		Right			Preset up (A-E)	Subsequent menu	Subsequent menu
ENTER	Enter		Enter				Subsequent menu	Subsequent menu
⑤ RETURN	Return		Return					
⑥ REC	Disc skip (player) Rec (recorder) *3	Rec *3	Rec *2*3	Disc skip (CD player)	Rec *3			Select PC/MCX
▷	Play	Play	Play *2	Play	Play		Play	Play
◁	Search backward	Search backward	Search backward *2	Search backward	Search backward		Search backward *4	Select NET RADIO
▷	Search forward	Search forward	Search forward *2	Search forward	Search forward		Search forward *4	Select USB
AUDIO	Audio	Audio	Audio *2	Sound (LD player)				
⏸	Pause	Pause	Pause *2	Pause	Pause		Pause	
◁	Skip backward	Skip backward	Skip backward *2	Skip backward	Skip backward		Skip backward	Skip backward *6
▷	Skip forward	Skip forward	Skip forward *2	Skip forward	Skip forward		Skip forward	Skip forward *6
⏹	Stop	Stop	Stop *2	Stop	Stop		Stop	Stop
⑦ ENT.	Title/Index	Enter	Enter	Chapter/Time (LD player) Index (CD player)	Index			
⑧ MENU	Menu		Menu				Previous menu	Previous menu
⑨ DISPLAY	Display	Display	Display	Display	Display		Display	Display

**Notes**

- \*1 This button is operational only when the original remote control supplied with the component has a POWER button.
- \*2 These buttons control your VCR or DVD recorder only when you set the appropriate remote control code for DVR (see page 95).
- \*3 When you use this button to record a source, press it twice repeatedly to prevent a malfunction.
- \*4 Press and hold to search backward or forward.
- \*5 Press and hold to store your favorite Internet radio stations with bookmarks (see page 106).
- \*6 These buttons are not operational when the Internet radio is selected as the sub input source of NET/USB.

## Setting the remote control code

You can control your TV and other components by setting the appropriate remote control code for each input source. For a complete list of available remote control codes, refer to “LIST OF REMOTE CONTROL CODES” at the end of this manual.

The following table shows the default component in the “Library (component category)” column and the remote control code for each input source.

### Remote Control Code Default Settings

Input source	Library (component category)	Manufacturer	Default code
CD	CD	YAMAHA	61907
MD/CD-R	MD	YAMAHA	70888
XM	TUNER	YAMAHA	81918
DVD	DVD	YAMAHA	40539
DTV/CBL	-	-	-
TUNER	TUNER	YAMAHA	81916
V-AUX/DOCK	OTHER AUDIO ACCESSORIES (iPod)	YAMAHA	81981
DVR	DVR	YAMAHA	51544
NET/USB	OTHER AUDIO ACCESSORIES (NET/USB)	YAMAHA	81982
☆☆	-	-	-

#### Note

You may not be able to operate your YAMAHA component even if a YAMAHA remote control code is initially set as listed above. In this case, try setting other YAMAHA remote control codes.

- 1 Press one of the input selector buttons or ☆☆ to select the component you want to set up.

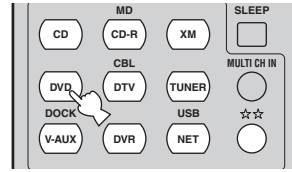

- 2 Press CODE SET using a ballpoint pen or a similar object.

The TRANSMIT indicator on the remote control flashes twice.



- 3 Press the numeric buttons (0 to 9) to enter the five-digit remote control code for the component to be used.

The TRANSMIT indicator on the remote control flashes twice, and the remote control code for the selected component is set.

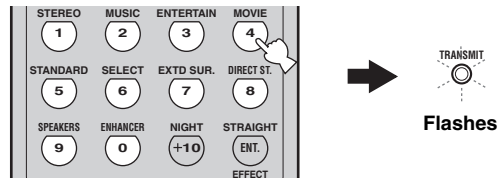

To clear the remote control code previously set for the selected component, enter the code number “9980”.

#### Notes

- If the manufacturer of your component has more than one code, try each of them until you find the correct one.
- If you do not press any buttons within 30 seconds in step 3, the setup process is canceled. If this happens, repeat the setup procedure.

## Setting library codes

You can operate multiple YAMAHA receivers or amplifiers in the same room with the supplied remote control simultaneously. Set the appropriate library code to select and operate the desired component with the supplied remote control.

### Setting remote control AMP ID library codes

Select one of the following codes to set the remote control AMP ID library code for the component you want to use.

#### 1 Press CODE SET using a ballpoint pen or a similar object.

The TRANSMIT indicator on the remote control flashes twice.



### Setting remote control TUNER ID library codes

Select one of the following codes to set the remote control TUNER ID library code for the component you want to use.

#### 1 Press TUNER to select "TUNER" as the input source.



#### 2 Press CODE SET using a ballpoint pen or a similar object.

The TRANSMIT indicator on the remote control flashes twice.



#### 2 Press the numeric buttons to enter the code number "00001" or "00002".

The TRANSMIT indicator on the remote control flashes twice, and the AMP ID library code is changed.

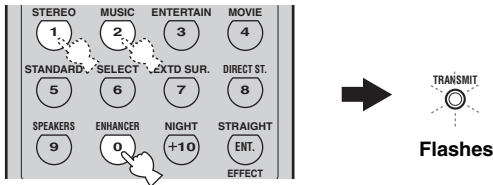

#### 3 Press the numeric buttons to enter the code number "81916" or "81917".

The TRANSMIT indicator on the remote control flashes twice, and the TUNER ID library code is changed.

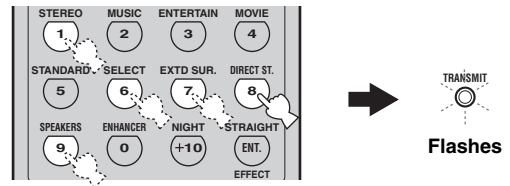

AMP ID library code *1	Function	Remote control AMP ID *2
00001 (initial setting)	To operate this unit using the default code.	ID1 (initial setting)
00002	To operate this unit using an alternative code.	ID2

TUNER ID library code *1	Function	Remote control TUNER ID *2
81916 (initial setting)	To operate this unit using the default code.	ID1 (initial setting)
81917	To operate this unit using an alternative code.	ID2

\*1 The remote control setting

\*2 The setting of this unit (see page 91)

#### Notes

- You need to set the corresponding remote control AMP ID of this unit in the advanced setup (see page 91).
- When using multiple YAMAHA receivers/amplifiers, you may be able to operate the other components simultaneously with the default code setting. In this case, set one of the alternative codes to operate this unit separately.

\*1 The remote control setting

\*2 The setting of this unit (see page 92)

#### Notes

- You need to set the corresponding remote control TUNER ID of this unit in the advanced setup (see page 92).
- When using multiple YAMAHA receivers/amplifiers, you may be able to operate the other components simultaneously with the default code setting. In this case, set one of the alternative codes to operate this unit separately.

**■ Setting remote control XM ID library codes (U.S.A. and Canada models only)**

Select one of the following codes to set the remote control XM ID library code for the component you want to use.

**1 Press XM to select “XM” as the input source.**



**2 Press CODE SET using a ballpoint pen or a similar object.**

The TRANSMIT indicator on the remote control flashes twice.



**3 Press the numeric buttons to enter the code number “81918” or “81919”.**

The TRANSMIT indicator on the remote control flashes twice, and the XM ID library code is changed.

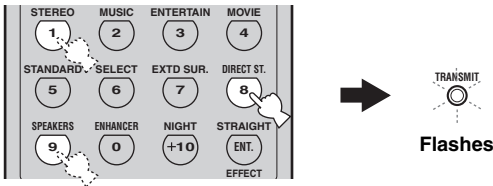

XM ID library code *1	Function	Remote control XM ID *2
81918 (initial setting)	To operate this unit using the default code.	ID1 (initial setting)
81919	To operate this unit using an alternative code.	ID2

\*1 The remote control setting

\*2 The setting of this unit (see page 92)

**Notes**

- You need to set the corresponding remote control XM ID of this unit in the advanced setup (see page 92).
- When using multiple YAMAHA receivers/amplifiers, you may be able to operate the other components simultaneously with the default code setting. In this case, set one of the alternative codes to operate this unit separately.

**Resetting all remote control codes**

Use this feature to clear all the remote control codes previously set and reset all of them to the initial factory settings.

**1 Press CODE SET using a ballpoint pen or a similar object.**

The TRANSMIT indicator on the remote control flashes twice.



**2 Press the numeric buttons to enter the code number “9981”.**

The TRANSMIT indicator on the remote control flashes twice, and all the remote control codes previously set are cleared and reset to the initial factory settings.

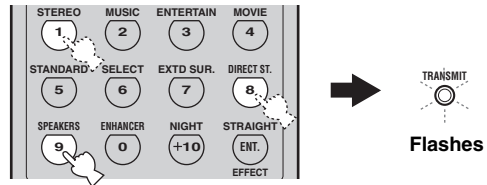

If you do not press any buttons within 30 seconds after step 2, the clearing process is canceled. In this case, repeat the clearing procedure.

# USING MULTI-ZONE CONFIGURATION

This unit allows you to configure a multi-zone audio system. The Zone 2 feature allows you to set this unit to reproduce separate input sources in the main zone and the second zone (Zone 2). You can control this unit from the second zone using the supplied remote control.

Only analog signals are sent to the second zone. Any source you want to listen to in the second zone must be connected to the analog AUDIO IN jacks of this unit.

## Connecting Zone 2

You need the following additional equipment to use the multi-zone functions of this unit:

- An infrared signal receiver in the second zone.
- An infrared signal emitter in the main zone. This emitter transmits the infrared signals from the remote control via the infrared signal receiver in the second zone to a CD player or a DVD player, etc. in the main zone.
- An amplifier and speakers in the second zone.



- Since there are many possible ways to connect and use this unit in a multi-zone configuration, we recommend that you consult with your nearest authorized YAMAHA dealer or service center about the Zone 2 connections that best meet your requirements.
- Some YAMAHA models are able to connect directly to the REMOTE jacks of this unit. If you own these products, you may not need to use an infrared signal emitter. Up to 6 YAMAHA components can be connected as shown below.

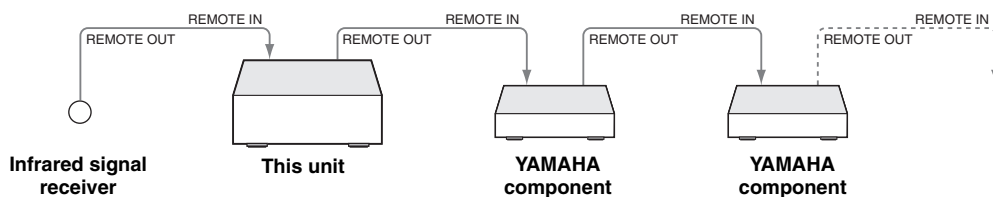

## Multi-zone configuration and Zone 2 connections

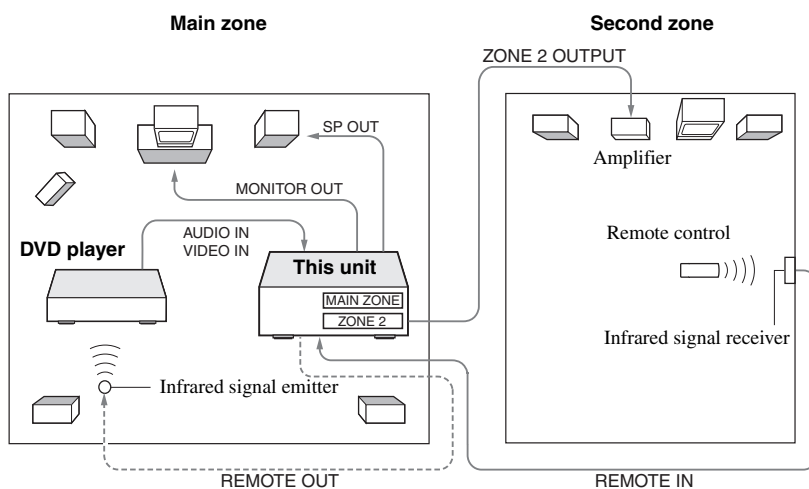

### Notes

- When you do not use the main zone, press MAIN ZONE ON/OFF on the front panel to turn off the main zone.
- To avoid unexpected noise, DO NOT USE the Zone 2 feature with CDs encoded in DTS.

## Controlling Zone 2

You can select and control Zone 2 by using the control buttons on the front panel or on the remote control. The available operations are listed as follows:

- Selecting the input source of Zone 2
- Tuning into FM or AM when “TUNER” is selected as the input source of Zone 2 (see page 46)
- Tuning into XM Satellite Radio when “XM” is selected as the input source of Zone 2 (see page 53) (U.S.A. and Canada models only)
- Enjoying music stored on your iPod stationed in a YAMAHA iPod universal dock (such as YDS-10 sold separately) connected to the DOCK terminal of this unit when “V-AUX” is selected as the input source (see page 101)



The volume level and tonal quality of Zone 2 cannot be adjusted. Adjust the volume control on the amplifier in Zone 2.

### Notes

- You must complete each step while the ZONE2 indicator is flashing in the front panel display. Otherwise, the Zone 2 mode is automatically canceled and this unit returns to the normal operation mode. In this case, repeat the Zone 2 selection procedure.
- The Zone 2 control function is operational only when MASTER ON/OFF on the front panel is pressed inward to the ON position.

### ■ Controlling Zone 2 with the front panel

#### 1 Press ZONE 2 ON/OFF to turn on Zone 2.



ZONE 2 ON/OFF is operational only when MASTER ON/OFF on the front panel is pressed inward to the ON position.

#### 2 Press ZONE CONTROL to control Zone 2.

The ZONE2 indicator flashes in the front panel display for approximately 5 seconds.



#### 3 Rotate the INPUT selector to select the desired input source while the ZONE2 indicator is flashing in the front panel display.

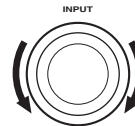

#### 4 Press ZONE 2 ON/OFF to set Zone 2 to the standby mode.



## ■ Setting the remote control to the Zone 2 mode

### Note

The remote control is originally set to the main mode to control the main zone. To control Zone 2 with the remote control, you must first set the remote control to the Zone 2 mode.

### 1 Press CODE SET using a ballpoint pen or a similar object.

The TRANSMIT indicator on the remote control flashes twice.



### 1 Press and hold POWER or STANDBY and then press ☆☆ to set the remote control to the Zone 2 mode.

- Press POWER when the main zone is turned on.
  - Press STANDBY when the main zone is turned off.
- The TRANSMIT indicator on the remote control lights up while the remote control is set to the Zone 2 mode.

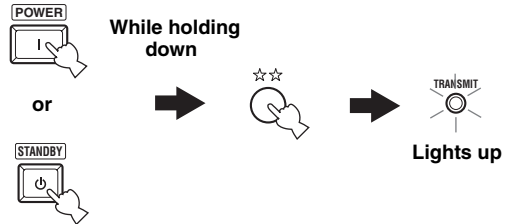

### 2 Press the numeric buttons to enter the code number "9992".

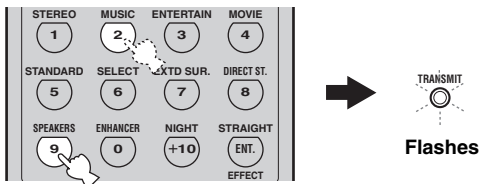

### 2 Press POWER to turn on Zone 2.



### 3 Press one of the input selector buttons to select the desired input source of Zone 2.

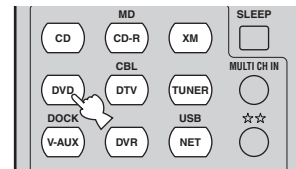

## ■ Controlling Zone 2 with the remote control

### Notes

- The remote control is originally set to the main mode to control the main zone, and the TRANSMIT indicator on the remote control is turned off when the remote control is set to the main mode.
- When the remote control is set to the Zone 2 mode, POWER, STANDBY, MUTE, and the input selector buttons are set to control Zone 2. However, the rest of the remote control buttons remain in the main mode.
- The remote control automatically exits from the Zone 2 mode in the following cases:
  - when you do not make any operations within 10 seconds after the remote control is set to the Zone 2 mode.
  - when you press a remote control button other than POWER, STANDBY, MUTE, and the input selector buttons.



To mute the audio output of Zone 2, press MUTE on the remote control. Press MUTE again to resume the audio output of Zone 2.



### 4 Press STANDBY to set Zone 2 to the standby mode.





# USING iPod®

Once you have stationed your iPod in a YAMAHA iPod universal dock (such as YDS-10 sold separately) connected to the DOCK terminal of this unit (see page 22), you can enjoy playback of your iPod using the supplied remote control. You can also use the Compressed Music Enhancer mode of this unit to improve the sound quality of the compression artifacts (such as the MP3 format) stored on your iPod (see page 37).

## Notes

- Only iPod (Click and Wheel), iPod nano, and iPod mini are supported.
- Some features may not be compatible depending on the model or the software version of your iPod.



- For a complete list of the remote control functions used to control your iPod, see the “iPod” column in “Controlling other components” on page 94.
- For a complete list of status messages that appear in the front panel display and in the OSD, see the “iPod” section in “TROUBLESHOOTING” on page 113.

## Controlling iPod

You can control your iPod when “V-AUX” is selected as the input source. The operations of your iPod can be done with the aid of the OSD of this unit (menu browse mode) or without it (simple remote mode).

### ■ Controlling iPod in the simple remote mode

You can perform the basic operations of your iPod (play, stop, skip, etc.) using the supplied remote control without the aid of the OSD of this unit.



- You can view the photos or video clips stored on your iPod.
- Operations can be also done with the controls on your iPod.

### ■ Controlling iPod in the menu browse mode

You can perform the advanced operations of your iPod using the supplied remote control with the aid of the OSD of this unit. The name of the song being played appears in the front panel display according to the “FL SCROLL” parameter in “OPTION MENU” (see page 87). You can also browse the songs stored on your iPod in the OSD. Further, you can change or adjust settings for your iPod to suit your personal preferences.

## Notes

- Operations cannot be done with the controls on your iPod.
- The YAMAHA logo appears in the display window of your iPod.
- There are some characters that cannot be displayed in the front panel display or in the OSD of this unit. Those characters are replaced with underscores “\_”.
- The “Setup” parameters can be changed or adjusted only in the OSD. Press ENTER on the remote control to toggle between the “Setup” parameter settings.
- You cannot browse the photos or video clips stored on your iPod in the OSD. Instead, you must use the controls on your iPod to select the desired photos or video clips.

**1 Press DISPLAY on the remote control.**

The following display appears in the OSD.



**2 Press ^/∨/|</> on the remote control to navigate the iPod menu and then press ENTER to begin playback of the selected song.**

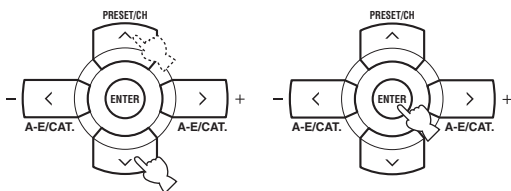

Choices: Playlists (playlists), Artists (artists),  
 Albums (albums), Songs (songs),  
 Genres (genres), Composers (composers)

- Playlists > Songs
- Artists > Albums > Songs
- Albums > Songs
- Songs
- Genres > Artists > Albums > Songs
- Composers > Albums > Songs
- Setup > Shuffle, Repeat

**Shuffle Shuffle**

Use this feature to set this unit to play songs or albums in a random order.

Choices: Off, Songs, Albums

- Select “Off” to deactivate this feature.
- Select “Songs” to set this unit to play songs in a random order.
- Select “Albums” to set this unit to play albums in a random order.

**Note**

When “Shuffle” is set to a setting other than “Off”, the highlighted letter “S” appears in the top right corner while songs or albums are being shuffled.

**Repeat Repeat**

Use this feature to set this unit to repeat one song or a sequence of songs.

Choices: Off, One, All

- Select “Off” to deactivate this feature.
- Select “One” to set this unit to repeat one song.
- Select “All” to set this unit to repeat a sequence of songs.

**Note**

When “Repeat” is set to a setting other than “Off”, the highlighted letter “R” appears in the top right corner while one song or a sequence of songs are being repeated.

# USING NETWORK/USB FEATURES

This unit is equipped with network and USB features that allow you to enjoy WAV (PCM format only), MP3 and WMA files saved on your PC, YAMAHA MCX-2000, USB memory device and USB portable audio player or access the Internet radio.

## Notes

- YAMAHA MCX-2000 may not be for sale in some locations.
- For further details about networking, refer to the operation manuals supplied with your network devices. Also refer to technical reference books, if needed.
- Some WAV, MP3 and WMA files may not be playable or may be noisy when played.



- For a complete list of the remote control functions used to control the network and USB features, see the “PC/MCX-2000/Internet radio/USB” column in “Controlling other components” on page 94.
- For a complete list of status messages that appear in the front panel display and in the OSD, see the “Network and USB” section in “TROUBLESHOOTING” on page 114.

## Navigating the network and USB menus

The following diagram shows the construction of the network and USB menu.

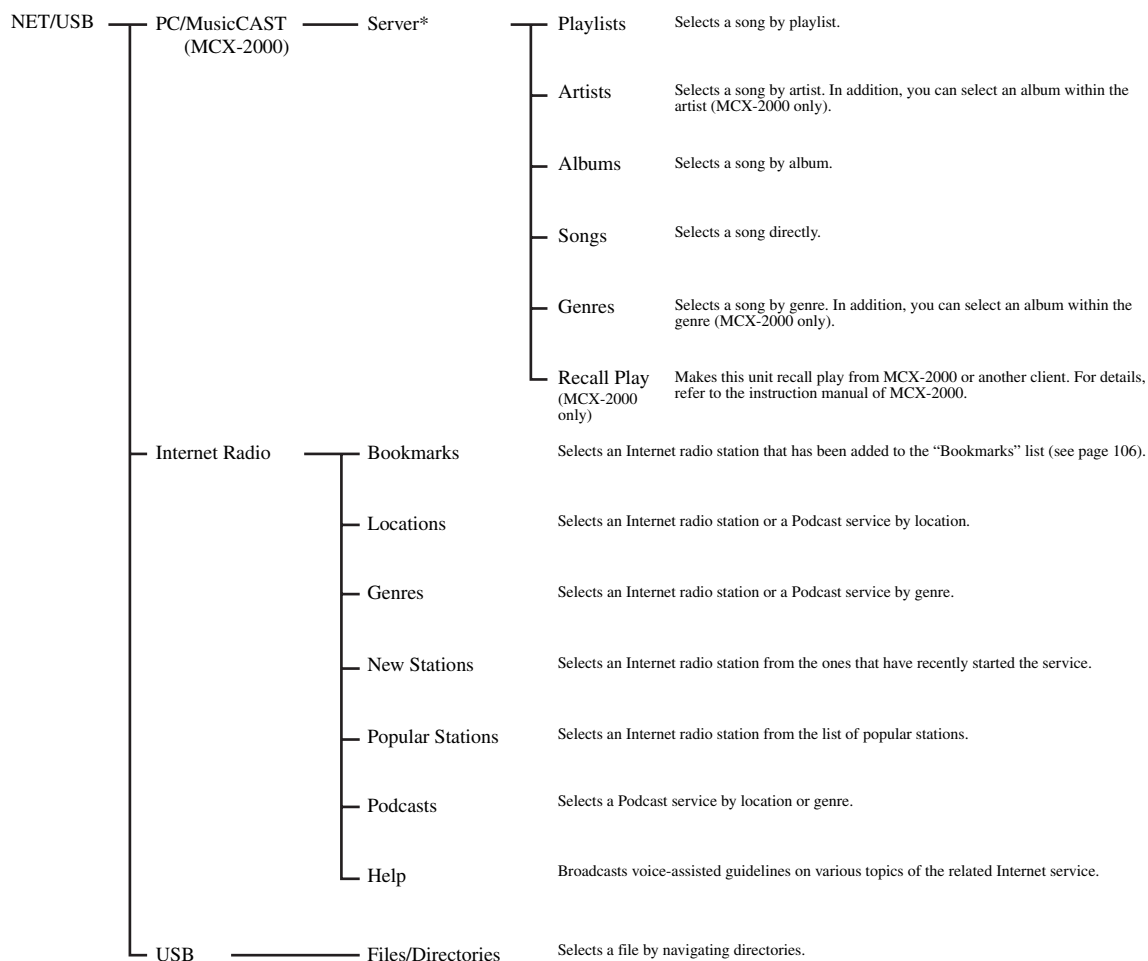

## Note

\* Only the available PC servers and MCX-2000 are displayed.

The following procedure shows the basic steps to navigate the network and USB menus. See pages 105 and 106 for details about each sub input source.

**Note**

“Please wait” may appear whenever it takes time for communication. This is not a system malfunction. Wait for a while.

**1 Set the component selector switch to SOURCE and then press NET/USB on the remote control to select “NET/USB” as the input source.**

The cursor on the left of the NET/USB indicator lights up in the front panel display, and the contents previously played for the corresponding sub input source of NET/USB is automatically played.

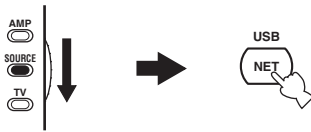

Lights up



**2 Press MENU on the remote control to display the top NET/USB menu.**

The following display appears in the OSD. If any other display appears in the OSD, press MENU on the remote control repeatedly until the top NET/USB menu appears.

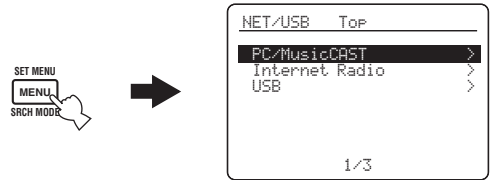

**3 Press ^ / v to select the desired sub input source and then press > or ENTER.**

You can also select the desired sub input source by pressing the corresponding button on the remote control (see page 7).

**4 Press ^ / v / < / > on the remote control to select the desired song or Internet radio station.**

- Press ^ / v to select the desired menu.
- Press > to enter the selected menu.
- Press < to return to the previous menu level.

- “>” in the right corner of each menu line indicates that there is a submenu available in the next menu level.
- You can press ENTER or MENU to enter the selected menu or to return to the previous menu level.

**5 Press ENTER to play the selected song or to listen to the selected station.**

## Using a PC server or YAMAHA MCX-2000

Use this feature to enjoy music files saved on your PC or YAMAHA MCX-2000. MCX-2000 is a music server that enhances the concept of YAMAHA exclusive MusicCAST, a digital music delivery method over a personal network.

### 1 Install Windows Media Connect 2.0 on your PC, or register this unit on your YAMAHA MCX-2000.

- Refer to “Installing Windows Media Connect 2.0 on your PC” and “Registering this unit on the YAMAHA MCX-2000” on page 106.
- This procedure is needed only the first time.

### 2 Turn on your PC or MCX-2000.

The PC server or MCX-2000 is added to the server list on the submenu of PC/MusicCAST.

### 3 Select a desired PC server or MCX-2000 to begin playback.

#### Notes

- YAMAHA MCX-2000 may not be for sale in some locations.
- You can connect this unit to up to 4 PC servers and 1 MCX-2000, and each server must be connected to the same subnet as this unit.
- Some WAV, MP3 and WMA files on your PC may not be playable or may be noisy when played.
- (MCX-2000 only) Files marked with an asterisk (\*) have not been converted to MP3 format. You cannot play back such files immediately unless you set the “Receive PCM Stream” setting of this unit to “ON” on MCX-2000. For details, refer to the instruction manual of MCX-2000.



- While a song is being played, the time elapsed is displayed at the bottom of the OSD.
- You can use / to skip backward/forward and / to start/stop playback independently from the menu in the OSD.
- You can set the settings for repeat and shuffle mode by using the “PLAY STYLE” parameters in “NET/USB MENU” (see page 85).
- You can set whether to display the operation status in the front panel display in a continuous manner or by the first 14 characters after scrolling all characters once by using “FL SCROLL” in “OPTION MENU” (see page 87).

## ■ Installing Windows Media Connect 2.0 on your PC

With Windows Media Connect 2.0, you can play back the audio files on your PC. For details refer to the documents of Windows Media Connect 2.0.

### 1 Install Windows Media Connect 2.0 on your PC.

You can download the installer of Windows Media Connect 2.0 from the Microsoft website.

### 2 Turn on your PC and then share a folder on the PC.

The Shared folder is added to the server list on the submenu of PC/MusicCAST.

#### Notes

- Some security software installed on your PC (anti-virus software, firewall software, etc.) may block the access of this unit to your PC. In such cases, configure the security software appropriately.
- If you are using a PC with Windows XP Professional, and the PC is logging on to a domain, you may not be able to connect the PC server. In such cases, log on to the local machine instead of the domain.

## ■ Registering this unit on the YAMAHA MCX-2000

You must register this unit on your YAMAHA MCX-2000 so that this unit can be recognized by your YAMAHA MCX-2000. For details, refer to the operation manual supplied with your YAMAHA MCX-2000.

### 1 Turn off this unit.

### 2 Set your YAMAHA MCX-2000 to the “Auto Config” mode.

### 3 Turn on this unit.

- MCX-2000 is added to the server list on the submenu of PC/MCX.
- The client ID of this unit appears in the OSD of your YAMAHA MCX-2000 (shown as CL-XXXXX), and this completes the automatic configuration procedure.

#### Notes

- The latter part of the client ID of this unit is same as the last 5 digits of the MAC address of this unit. For details about MAC address, see page 86.
- To clear the registered client ID of this unit, use the “Manual Config” mode of your YAMAHA MCX-2000 (refer to the instruction manual of MCX-2000) and then set “N-RESET” in the advanced setup menu of this unit to “RESET” (see page 91).
- The client control functions of MCX-2000 over this unit other than “View Play Info”, “Receive PCM Stream” and “Edit Client title” are not available. Avoid using these functions as it will stop the playback on this unit.

## Using the Internet radio

Use this feature to listen to Internet radio stations. This unit uses the vTuner Internet radio station database service particularly customized for this unit, providing over 2000 radio station database. Further, you can store your favorite stations with bookmarks.

#### Notes

- This service may be discontinued without notice.
- Some Internet radio stations may not be played even if they are selected in the NET RADIO menu.
- To listen to the Internet radio, connect this unit to your network (see page 23).
- A narrowband Internet connection (i.e. 56K modem, ISDN) will not provide satisfactory results, and a broadband connection is strongly recommended (i.e. a cable modem, an xDSL modem, etc.). For detailed information, consult with your ISP.



- You can use to start/stop playback independently from the menu in the OSD.
- “Podcast” is a type of the Internet radio service, and there are a number of Podcast services available on the Internet. The Podcast is not a continuous service. That is, this unit stops playback when an episode of the Podcast ends.
- Some security devices (such as firewall) may block the access of this unit to Internet radio stations. In such cases, configure the security settings appropriately.

## ■ Storing your favorite Internet radio stations with bookmarks

Use this feature to select your favorite Internet radio stations quickly.

**Press and hold TITLE on the remote control while the selected Internet radio station service is being broadcast.**

The stored Internet radio station is added to the “Bookmarks” list (see page 103).



To remove the stored station from the list, select the item in the first level of “Bookmarks” list and then press and hold TITLE on the remote control.

## Using a USB memory device or a USB portable audio player

Use this feature to enjoy WAV (PCM format only), MP3 and WMA files saved on your USB memory device or USB portable audio player connected to the USB port on the front panel of this unit.

### Notes

- This unit supports USB mass storage class devices using FAT 16 or FAT 32.
- Only the first partition is displayed in the OSD. You cannot select files in other partitions.
- Up to 8 levels of directory hierarchy and 500 music files per directory are recognized.
- Some devices may not work properly even if they meet the requirements.
- Some WAV, MP3 and WMA files may not be playable or may be noisy when played.
- When you connect your USB memory device or USB portable audio player, there may be an about 10 seconds delay.



- While a song is being played, the time elapsed is displayed at the bottom of the OSD.
- You can use / to skip backward/forward and / to start/stop playback independently from the menu in the OSD.
- You can set the settings for repeat and shuffle mode by using the "PLAY STYLE" parameters in "NET/USB MENU" (see page 85).
- You can set whether to display the operation status in the front panel display in a continuous manner or by the first 14 characters after scrolling all characters once by using "FL SCROLL" in "OPTION MENU" (see page 87).

# RESETTING THE SYSTEM

Use this feature to reset all the parameters of this unit to the initial factory settings.

## Notes

- This procedure completely resets all the parameters of this unit including the “SET MENU” parameters. However, the advanced setup menu parameters will not be initialized.
- The initial factory settings are activated next time you turn on this unit.



To cancel the initialization procedure at any time without making any changes, press MASTER ON/OFF on the front panel to release it outward to the OFF position.

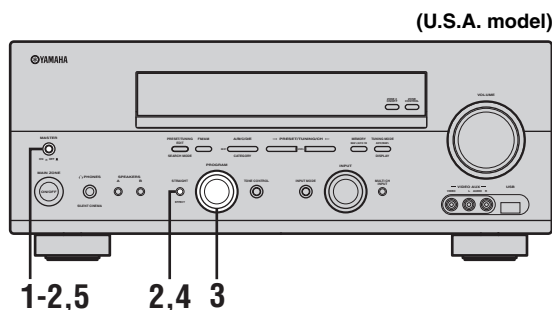

- 1 Press MASTER ON/OFF on the front panel to release it outward to the OFF position to turn off this unit.**



- 2 Press and hold STRAIGHT (EFFECT) on the front panel and then press MASTER ON/OFF inward to the ON position to turn on this unit.** This unit turns on, and the advanced setup menu appears in the front panel display.

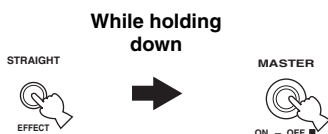

- 3 Rotate the PROGRAM selector on the front panel to select “PRESET”.**



- 4 Press STRAIGHT (EFFECT) on the front panel repeatedly to select “RESET”.**



Select “CANCEL” to cancel the initialization procedure without making any changes.

- 5 Press MASTER ON/OFF on the front panel to release it outward to the OFF position to confirm your selection and turn off this unit.**





# TROUBLESHOOTING

Refer to the table below when this unit does not function properly. If the problem you are experiencing is not listed below or if the instruction below does not help, turn off this unit, disconnect the power cable, and contact the nearest authorized YAMAHA dealer or service center.

## ■ General

Problem	Cause	Remedy	See page
<b>This unit fails to turn on or enters the standby mode soon after the power is turned on.</b>	The power cable is not connected or the plug is not completely inserted.	Connect the power cable firmly.	—
	The speaker impedance setting is incorrect.	Set the speaker impedance to match your speakers.	27
	The protection circuitry has been activated.	Make sure that all speaker wire connections on this unit and on all speakers are secure and that the wire for each connection does not touch anything other than its respective connection.	13
	This unit has been exposed to a strong external electric shock (such as lightning or strong static electricity).	Set this unit to the standby mode, disconnect the power cable, plug it back in after 30 seconds and then use it normally.	—
<b>No sound</b>	Incorrect input or output cable connections.	Connect the cables properly. If the problem persists, the cables may be defective.	18-24
	“INPUT MODE” is set to “DTS” or “ANALOG”.	Set “INPUT MODE” to “AUTO”.	35
	No appropriate input source has been selected.	Select an appropriate input source with the INPUT selector on the front panel (or the input selector buttons on the remote control) and MULTI CH INPUT on the front panel (or MULTI CH IN on the remote control).	32, 38
	Speaker connections are not secure.	Secure the connections.	13
	The front speakers to be used have not been selected properly.	Select the set of front speakers with SPEAKERS A or B on the front panel or SPEAKERS on the remote control.	32
	The volume is turned down.	Turn up the volume.	—
	The sound is muted.	Press MUTE or VOLUME +/- on the remote control to resume audio output and then adjust the volume.	34
	“INPUT MODE” is set to “ANALOG” while playing a source encoded in DTS.	Set “INPUT MODE” to “AUTO” or “DTS”.	35
	Signals this unit cannot reproduce are being input from a source component, such as a CD-ROM.	Play a source whose signals can be reproduced by this unit.	—
<b>No picture</b>	The output and input for the picture are connected to different types of video jacks.	Set “VIDEO CONV.” to “ON”.	86

Problem	Cause	Remedy	See page
<b>The sound suddenly goes off.</b>	The protection circuitry has been activated because of a short circuit, etc.	Check that the speaker impedance setting is correct.	27, 91
		Check that the speaker wires are not touching each other and then turn this unit back on.	—
	The sleep timer has turned off this unit.	Turn on this unit, and play the source again.	—
	The sound is muted.	Press MUTE or VOLUME +/- on the remote control to resume audio output.	34
<b>Sound is heard from the speaker on one side only.</b>	Incorrect cable connections.	Connect the cables properly. If the problem persists, the cables may be defective.	13
	Incorrect settings in "SPEAKER LEVEL".	Adjust the "SPEAKER LEVEL" settings.	79
<b>Only the center speaker outputs substantial sound.</b>	When playing a monaural source with a CINEMA DSP program, the source signal is directed to the center channel, and the front and surround speakers output effect sounds.		
<b>No sound is heard from the center speaker.</b>	"CENTER SP" in "SET MENU" is set to "NONE".	Set "CENTER SP" to "SML" or "LRG".	78
	One of the HiFi DSP programs (except for "6ch Stereo") has been selected.	Try another sound field program.	65
<b>No sound is heard from the surround speakers.</b>	"SUR. L/R SP" in "SET MENU" is set to "NONE".	Set "SUR. L/R SP" to "SML" or "LRG".	78
	This unit is in the "STRAIGHT" mode and a monaural source is being played back.	Press STRAIGHT (EFFECT) on the front panel so that "STRAIGHT" disappears from the front panel display.	39
<b>No sound is heard from the surround back speaker.</b>	"SUR. L/R SP" in "SET MENU" is set to "NONE" and "SUR. B SP" is automatically set to "NONE".	Set "SUR. L/R SP" and "SUR. B SP" to "SML" or "LRG".	78
	"SUR. B SP" in "SET MENU" is set to "NONE".	Set "SUR. B SP" to "SML" or "LRG".	78
<b>No sound is heard from the subwoofer.</b>	"LFE/BASS OUT" in "SET MENU" is set to "FRNT" when a Dolby Digital or DTS signal is being played.	Set "LFE/BASS OUT" to "SWFR" or "BOTH".	78
	"LFE/BASS OUT" in "SET MENU" is set to "SWFR" or "FRNT" when a 2-channel source is being played.	Set "LFE/BASS OUT" to "BOTH".	78
	The source does not contain low-frequency signals.		

Problem	Cause	Remedy	See page
<b>Dolby Digital or DTS sources cannot be played. (Dolby Digital or DTS indicator in the front panel display does not light up.)</b>	The connected component is not set to output Dolby Digital or DTS digital signals.	Make an appropriate setting following the operating instructions for your component.	—
	“INPUT MODE” is set to “ANALOG”.	Set “INPUT MODE” to “AUTO” or “DTS”.	35
<b>A humming sound is heard.</b>	Incorrect cable connections.	Connect the audio cables firmly. If the problem persists, the cables may be defective.	—
<b>The volume level cannot be increased, or the sound is distorted.</b>	The component connected to the AUDIO OUT (REC) jacks of this unit is turned off.	Turn on the power of the component.	—
<b>The sound effect cannot be recorded.</b>	It is not possible to record the sound effect with a recording component.		
<b>A source cannot be recorded by a digital recording component connected to the DIGITAL OUTPUT jack.</b>	The source component is not connected to the DIGITAL INPUT jacks of this unit.	Connect the source component to the DIGITAL INPUT jacks.	19, 21
	Some components cannot record the Dolby Digital or DTS sources.		
<b>A source cannot be recorded by an analog component connected to the AUDIO OUT (REC) jacks.</b>	The source component is not connected to the analog AUDIO IN jacks of this unit.	Connect the source component to the analog AUDIO IN jacks.	21
<b>The sound field parameters and some other settings of this unit cannot be changed.</b>	“MEMORY GUARD” in “SET MENU” is set to “ON”.	Set “MEMORY GUARD” to “OFF”.	87
<b>This unit does not operate properly.</b>	The internal microcomputer has been frozen by an external electric shock (such as lightning or excessive static electricity) or by a power supply with low voltage.	Disconnect the power cable from the AC wall outlet and then plug it in again after about 30 seconds.	—
<b>“CHECK SP WIRES” appears in the front panel display.</b>	Speaker cables are short-circuited.	Make sure all speaker cables are connected correctly.	13
<b>There is noise interference from digital or radio frequency equipment.</b>	This unit is too close to the digital or high-frequency equipment.	Move this unit further away from such equipment.	—
<b>The picture is disturbed.</b>	The video source uses scrambled or encoded signals to prevent dubbing.		
<b>This unit suddenly enters the standby mode.</b>	The internal temperature becomes too high and the overheat protection circuitry has been activated.	Wait about 1 hour for this unit to cool down and then turn it back on.	—

## ■ Tuner

	Problem	Cause	Remedy	See page
FM	FM stereo reception is noisy.	The characteristics of FM stereo broadcasts may cause this problem when the transmitter is too far away or the antenna input is poor.	Check the antenna connections.	25
			Try using a high-quality directional FM antenna.	—
			Use the manual tuning method.	47
	There is distortion, and clear reception cannot be obtained even with a good FM antenna.	There is multi-path interference.	Adjust the antenna position to eliminate multi-path interference.	—
	The desired station cannot be tuned into with the automatic tuning method.	The signal is too weak.	Use a high-quality directional FM antenna.	—
Use the manual tuning method.			47	
Previously preset stations can no longer be tuned into.	This unit has been disconnected for a long period.	Set preset stations.	48, 49	
AM	The desired station cannot be tuned into with the automatic tuning method.	The signal is weak or the antenna connections are loose.	Tighten the AM loop antenna connections and orient it for the best reception.	—
			Use the manual tuning method.	47
	There are continuous crackling and hissing noises.	Noises result from lightning, fluorescent lamps, motors, thermostats and other electrical equipment.	Use an outdoor antenna and a ground wire. This will help somewhat, but it is difficult to eliminate all noise.	—
	There are buzzing and whining noises.	A TV set is being used nearby.	Move this unit away from the TV set.	—

## ■ XM Satellite Radio (U.S.A. and Canada models only)

If an operation takes longer than usual or an error occurs, one of the following messages may appear in the front panel display. In this case, read the cause and follow the corresponding remedies.

Status message	Cause	Remedy	See page
CHECK ANTENNA	XM Passport and XM Passport Home Dock are not connected to the XM jack of this unit or does not work properly.	Check XM Passport and XM Passport Home Dock connections and orient them for the best reception level.	54
UPDATING	The XM user encryption code is being updated.	Wait until the encryption code is updated.	—
NO SIGNAL	The signal is too weak.	Adjust the orientation of the XM Passport System for the best reception level.	54
LOADING	It takes longer than four seconds for audio or text data to be decoded.	Wait until the decoding process has finished.	—
OFF AIR	The XM Satellite Radio channel you selected is not currently broadcasting any signals.	Check the channel number again or select another XM Satellite Radio channel.	—
<XM> - - -	The Channel Station ID (SID) is no longer available.		
- - - / - - -	No artist name or song title is available.		
<CAT> - - -	No channels are available for the selected category.	Select another channel category by pressing CATEGORY on the front panel (or A-E/CAT. </> on the remote control) repeatedly.	59

## ■ Remote control

Problem	Cause	Remedy	See page	
<b>The remote control does not work nor function properly.</b>	Wrong distance or angle.	The remote control functions within a maximum range of 6 m (20 ft) and no more than 30 degrees off-axis from the front panel.	8	
	Direct sunlight or lighting (from an inverter type of fluorescent lamp, etc.) is striking the remote control sensor of this unit.	Reposition this unit.	—	
	The batteries are weak.	Replace all batteries.	3	
	The remote control code is not correctly set.	Set the remote control code correctly using “LIST OF REMOTE CONTROL CODES” at the end of this manual.		95
		Try setting another code for the same manufacturer using “LIST OF REMOTE CONTROL CODES” at the end of this manual.		95
	The library code of the remote control and the remote control ID of this unit do not match.	Match the remote control ID of this unit with the corresponding remote control library code.		91, 96
Even if the remote control code is correctly set, there are some models that do not respond to the remote control.				

## ■ iPod

### Note

In case of a transmission error without a status message appearing in the front panel and in the OSD, check the connection to your iPod (see page 22).

Status message	Cause	Remedy	See page
Loading...	This unit is in the middle of recognizing the connection with your iPod.		
	This unit is in the middle of acquiring song lists from your iPod.		
Connect error	There is a problem with the signal path from your iPod to this unit.	Turn off this unit and reconnect the YAMAHA iPod universal dock to the DOCK terminal of this unit.	22
		Try resetting your iPod.	—
Unknown type	The iPod being used is not supported by this unit.	Only iPod (Click and Wheel), iPod nano, and iPod mini are supported.	—
iPod connected	Your iPod is properly stationed in a YAMAHA iPod universal dock (such as YDS-10 sold separately) connected to the DOCK terminal of this unit, and the connection between your iPod and this unit is complete.		
Disconnected	Your iPod was removed from a YAMAHA iPod universal dock (such as YDS-10 sold separately) connected to the DOCK terminal of this unit.	Station your iPod back in a YAMAHA iPod universal dock (such as YDS-10 sold separately) connected to the DOCK terminal of this unit.	22
Unable to play	This unit cannot play back the songs currently stored on your iPod.	Check that the songs currently stored on your iPod are playable.	—
		Store some other playable music files on your iPod.	—

## ■ Network and USB

Problem	Cause	Remedy	See page
<b>The PC server/MCX-2000/Internet radio does not function properly.</b>	The IP address is not set properly.	Set the DHCP server function of the router to ON. Alternately, perform manual configuration according to the current operating environment.	84
	The network cable is not connected.	Connect it properly.	23
<b>The music in the PC server cannot be played back.</b>	The PC does not have Windows Media Connect 2.0 installed in it.	Install Windows Media Connect 2.0 in the PC.	—
	The music is recorded in a format that cannot be played on this unit. This unit cannot play music formats other than WMA, MP3 and WAV (PCM format). Also note that it cannot play certain music files even if these are recorded in the WMA, MP3 or WAV format.	Play music recorded in a format that this unit is compatible with.	—
	The music is copyright-protected.	This unit cannot play copyright-protected music.	—
<b>Windows Media Connect 2.0 cannot be connected.</b>	The Windows XP PC is logging on to a domain.	Log on to the local machine instead of the domain.	—
<b>The MusicCAST server cannot be connected.</b>	You are attempting to connect to MCX-1000. The MusicCAST server that can be connected by this unit is MCX-2000.	Use MCX-2000 or the PC server.	—
	Auto Configuration is not executed.	Execute "Auto Configure".	105
<b>The Internet radio cannot be played.</b>	The firewall of the network device is activated. The Internet radio can be played only when it passes through the port designated by each radio station. The port number is variable depending on radio station.	Check the firewall setting of the network device.	—
	Connection to the Internet is disconnected.	Check the configuration of the network device, and then contact the network connection provider.	—
<b>The music files and directories in the USB device cannot be viewed.</b>	The music files and directories are placed in locations other than the FAT area.	Place music files and directories in the FAT area.	—
	You are attempting to browse directory hierarchies of over 8 levels or a directory with more than 500 files.	Modify the data structure on your USB device.	—
<b>The USB device cannot be recognized.</b>	The connected USB device is other than a USB mass storage class USB memory device or USB portable audio player.	This unit can recognize only a USB mass storage class USB memory device or USB portable audio player. Also note that it cannot recognize certain USB devices even when they are devices as described above.	107
		Some devices may become easier to recognize when they are inserted before turning this unit on.	28
<b>"Disconnected" is displayed even when a USB device is present.</b>	This unit recognized the USB device as an illegal device.	Turn this unit off then on again.	28

Status message	Cause	Remedy	See page
Please wait	This unit is in the middle of recognizing the connection with your network.	This is not a system malfunction. Wait for a while.	—
	This unit is in the middle of recognizing the connection with your USB memory device or USB portable audio player.	This is not a system malfunction. Wait for a while.	—
Please wait (Starting Server)	This unit is in the middle of waking up MCX-2000 that has been set to the standby mode.	Wait for approximately 20 seconds.	—
Connect error	There is a problem with the signal path from your network to this unit.	Check the connection between this unit and the LAN port on your router or hub.	23
		Make sure your router is properly connected and turned on. Also, make sure your modem is properly connected and turned on when you are attempting to listen to Internet radio.	23
Disconnected	Your USB memory device or USB portable audio player has been disconnected from the USB port of this unit.	Check the connection between this unit and your USB memory device or USB portable audio player.	—
	The PC server or MCX-2000 server previously connected to this unit no longer exists.	Connect this unit to the available PC server or MCX-2000.	105
	There is a problem with the signal path from your USB memory device or USB portable audio player to this unit.	Turn off this unit and reconnect your USB memory device or USB portable audio player to the USB port of this unit.	28
Try resetting your USB memory device or USB portable audio player.		—	
Access error	This unit cannot access your USB memory device or USB portable audio player.	Try another USB memory device or USB portable audio player.	—
		Turn off this unit and reconnect your USB memory device or USB portable audio player to the USB port of this unit.	28
		Try resetting your USB memory device or USB portable audio player.	—
Unable to play	This unit cannot play back the songs currently stored on your PC.	Make sure Windows Media Connect 2.0 is installed on your PC.	—
		Check that the songs currently stored on your PC are playable (MP3, WMA, and WAV).	—
		Store some other playable music files (MP3, WMA, and WAV) on your PC.	—
	The network may be overloaded with heavy traffic, and playback is interrupted.	Try preparing a network exclusively for use with this unit to separate it from general network traffic.	—
List updated	The list of the contents stored on your PC server or MCX-2000 has been updated.		
Bookmark ON	The desired Internet radio station has been added to the "Bookmarks" list.		
Bookmark OFF	The stored Internet radio station has been removed from the "Bookmarks" list.		

## Audio information

### ■ Dolby Digital

Dolby Digital is a digital surround sound system that gives you completely independent multi-channel audio. With 3 front channels (front L/R and center), and 2 surround stereo channels, Dolby Digital provides 5 full-range audio channels. With an additional channel especially for bass effects, called LFE (Low Frequency Effect), the system has a total of 5.1-channels (LFE is counted as 0.1 channel). By using 2-channel stereo for the surround speakers, more accurate moving sound effects and surround sound environment are possible than with Dolby Surround. The wide dynamic range from maximum to minimum volume reproduced by the 5 full-range channels and the precise sound orientation generated using digital sound processing provide listeners with unprecedented excitement and realism. With this unit, any sound environment from monaural up to a 5.1-channel configuration can be freely selected for your enjoyment.

### ■ Dolby Digital EX

Dolby Digital EX creates 6 full-bandwidth output channels from 5.1-channel sources. This is done using a matrix decoder that derives 3 surround channels from the 2 in the original recording. For the best results, Dolby Digital EX should be used with movie sound tracks recorded with Dolby Digital Surround EX. With this additional channel, you can experience more dynamic and realistic moving sound especially with scenes with “fly-over” and “fly-around” effects.

### ■ Dolby Pro Logic II

Dolby Pro Logic II is an improved technique used to decode vast numbers of existing Dolby Surround sources. This new technology enables a discrete 5-channel playback with 2 front left and right channels, 1 center channel, and 2 surround left and right channels instead of only 1 surround channel for conventional Pro Logic technology. There are three modes available: “Music mode” for music sources, “Movie mode” for movie sources and “Game mode” for game sources.

### ■ Dolby Pro Logic IIx

Dolby Pro Logic IIx is a new technology enabling discrete multi-channel playback from 2-channel or multi-channel sources. There are three modes available: “Music mode” for music sources, “Movie mode” for movie sources (for 2-channel sources only) and “Game mode” for game sources.

### ■ Dolby Surround

Dolby Surround uses a 4-channel analog recording system to reproduce realistic and dynamic sound effects: 2 front left and right channels (stereo), a center channel for dialog (monaural), and a surround channel for special sound effects (monaural). The surround channel reproduces sound within a narrow frequency range. Dolby Surround is widely used with nearly all video tapes and laser discs, and in many TV and cable broadcasts as well. The Dolby Pro Logic decoder built into this unit employs a digital signal processing system that automatically stabilizes the volume on each channel to enhance moving sound effects and directionality.

### ■ DTS 96/24

DTS 96/24 offers an unprecedented level of audio quality for multi-channel sound on DVD video, and is fully backward-compatible with all DTS decoders. “96” refers to a 96 kHz sampling rate compared to the typical 48 kHz sampling rate. “24” refers to 24-bit word length. DTS 96/24 offers sound quality transparent to the original 96/24 master, and 96/24 5.1-channel sound with full-quality full-motion video for music programs and motion picture soundtracks on DVD video.

### ■ DTS (Digital Theater Systems) Digital Surround

DTS digital surround was developed to replace the analog soundtracks of movies with a 6.1-channel digital sound track, and is now rapidly gaining popularity in movie theaters around the world. Digital Theater Systems Inc. has developed a home theater system so that you can enjoy the depth of sound and natural spatial representation of DTS digital surround in your home. This system produces practically distortion-free 6.1-channel sound (technically, front left and right, center, surround left and right, and LFE 0.1 (subwoofer) channels for a total of 5.1 channels). This unit incorporates a DTS-ES decoder that enables 6.1-channel reproduction by adding the surround back channel to the existing 5.1-channel format.

### ■ ITU-R

ITU-R is the radio communication sector of the ITU (International Telecommunication Union). ITU-R recommends a standard speaker placement which is used in many critical listening rooms, especially for mastering purposes.



### ■ LFE 0.1 channel

This channel reproduces low-frequency signals. The frequency range of this channel is from 20 Hz to 120 Hz. This channel is counted as 0.1 because it only enforces a low-frequency range compared to the full-range reproduced by the other 5/6 channels in Dolby Digital or DTS 5.1/6.1-channel systems.

### ■ MP3

One of the audio compression methods used by MPEG. It employs the irreversible compression method, which achieves a high compression rate by thinning out the data of hardly audible part to the human ears. It is said to be capable of compressing the data quantity by about 1/11 (128 kbps) while maintaining a similar audio quality to music CD.

### ■ Neo:6

Neo:6 decodes the conventional 2-channel sources for 6-channel playback by the specific decoder. It enables playback with the full-range channels with higher separation just like digital discrete signal playback. There are two modes available: "Music mode" for music sources and "Cinema mode" for movie sources.

### ■ Neural Surround

Neural Surround™ represents the latest advancement in surround technology and has been adopted by XM Satellite Radio for digital radio broadcast of surround recordings and live events in surround sound. Neural Surround™ employs psychoacoustic frequency domain processing which allows delivery of a more detailed sound stage with superior channel separation and localization of audio elements. System playback is scalable from 5.1 to 7.1 multi-channel surround playback.

### ■ PCM (Linear PCM)

Linear PCM is a signal format under which an analog audio signal is digitized, recorded and transmitted without using any compression. This is used as a method of recording CDs and DVD audio. The PCM system uses a technique for sampling the size of the analog signal per very small unit of time. Standing for "Pulse Code Modulation", the analog signal is encoded as pulses and then modulated for recording.

### ■ Sampling frequency and number of quantized bits

When digitizing an analog audio signal, the number of times the signal is sampled per second is called the sampling frequency, while the degree of fineness when converting the sound level into a numeric value is called the number of quantized bits. The range of rates that can be played back is determined based on the sampling rate, while the dynamic range representing the sound level difference is determined by the number of quantized bits. In principle, the higher the sampling frequency, the wider the range of frequencies that can be played back, and the higher the number of quantized bits, the more finely the sound level can be reproduced.

### ■ WAV

Windows standard audio file format, which defines the method of recording the digital data obtained by converting audio signals. It does not specify the compression (coding) method so a desired compression method can be used with it. By default, it is compatible with the PCM method (no compression) and some compression methods including the ADPCM method.

### ■ WMA

An audio compression method developed by Microsoft Corporation. It employs the irreversible compression method, which achieves a high compression rate by thinning out the data of hardly audible part to the human ears. It is said to be capable of compressing the data quantity by about 1/22 (64 kbps) while maintaining a similar audio quality to music CD.

## ***Video information***

### ■ **Component video signal**

With the component video signal system, the video signal is separated into the Y signal for the luminance and the P<sub>B</sub> and P<sub>R</sub> signals for the chrominance. Color can be reproduced more faithfully with this system because each of these signals is independent. The component signal is also called the “color difference signal” because the luminance signal is subtracted from the color signal. A monitor with component input jacks is required in order to output component signals.

### ■ **Composite video signal**

With the composite video signal system, the video signal is composed of three basic elements of a video picture: color, brightness and synchronization data. A composite video jack on a video component transmits these three elements combined.

### ■ **S-video signal**

With the S-video signal system, the video signal normally transmitted using a pin cable is separated and transmitted as the Y signal for the luminance and the C signal for the chrominance through the S-video cable. Using the S VIDEO jack eliminates video signal transmission loss and allows recording and playback of even more beautiful images.

## ***Sound field program information***

### ■ **CINEMA DSP**

Since the Dolby Surround and DTS systems were originally designed for use in movie theaters, their effect is best felt in a theater having many speakers designed for acoustic effects. Since home conditions, such as room size, wall material, number of speakers, and so on, can differ so widely, it is inevitable that there are differences in the sound heard. Based on a wealth of actually measured data, YAMAHA CINEMA DSP uses YAMAHA original sound field technology to combine Dolby Pro Logic, Dolby Digital and DTS systems to provide the audiovisual experience of movie theater in the listening room of your own home.

### ■ **SILENT CINEMA**

YAMAHA has developed a natural, realistic sound effect DSP algorithm for headphones. Parameters for headphones have been set for each sound field so that accurate representations of all the sound field programs can be enjoyed on headphones.

### ■ **Virtual CINEMA DSP**

YAMAHA has developed a Virtual CINEMA DSP algorithm that allows you to enjoy DSP sound field surround effects even without any surround speakers by using virtual surround speakers. It is even possible to enjoy Virtual CINEMA DSP using a minimal two-speaker system that does not include a center speaker.

# SPECIFICATIONS

## AUDIO SECTION

- Minimum RMS Output Power for Front, Center, Surround, Surround back  
20 Hz to 20 kHz, 0.06% THD, 8 Ω ..... 95 W
- Maximum Useful Output Power (JEITA)  
[China, Korea and General models]  
1 kHz, 10% THD, 8 Ω ..... 135 W
- Dynamic Power (IHF)  
8/6/4/2 Ω ..... 130/165/195/240 W
- Maximum Output Power [Europe model]  
1 kHz, 0.7% THD, 4 Ω ..... 145 W
- IEC Output Power [Europe model]  
1 kHz, 0.06% THD, 8 Ω ..... 105 W
- Damping Factor  
20 Hz to 20 kHz, 8 Ω ..... 120 or more
- Maximum Input Voltage  
CD, etc. (1 kHz, 0.5% THD) ..... 2.2 V or more
- Frequency Response  
CD, etc. .... 10 Hz to 100 kHz, -3 dB  
V-AUX ..... 10 Hz to 20 kHz, -3 dB
- Total Harmonic Distortion  
CD, etc. to Front L/R (20 Hz to 20 kHz, 50 W, 8 Ω)  
..... 0.06% or less
- Signal to Noise Ratio (IHF-A Network)  
CD, etc. (250 mV) to Front L/R ..... 100 dB or more
- Residual Noise (IHF-A Network)  
Front L/R ..... 150 μV or less
- Channel Separation (1 kHz/10 kHz)  
CD (5.1 kΩ terminated) to Front L/R ..... 60 dB/45 dB or more
- Tone Control (Front L/R)  
BASS Boost/Cut ..... ±10 dB/60 Hz  
TREBLE Boost/Cut ..... ±10 dB/20 kHz
- Phones Output ..... 150 mV/100 Ω
- Input Sensitivity/Input Impedance  
CD, etc. .... 200 mV/47 kΩ  
MULTI CH INPUT ..... 200 mV/47 kΩ
- Rated Output Voltage/Output Impedance  
OUT (REC)..... 200 mV/1.2 kΩ  
SUBWOOFER ..... 4 V/1.2 kΩ  
ZONE 2 OUT ..... 200 mV/1.2 kΩ
- Volume Control..... Mute/-80 dB to +16 dB/1 dB step

## VIDEO SECTION

- Video Format (Gray Back)  
[U.S.A., Canada, Korea and General models] ..... NTSC  
[Other models] ..... PAL
- Video Format (Video Conversion) ..... NTSC/PAL
- Rated Input Voltage  
Composite ..... 1 Vp-p/75 Ω  
S-video (Y) ..... 1 Vp-p/75 Ω  
S-video (C) ..... 0.286 Vp-p/75 Ω  
Component (Y) ..... 1 Vp-p/75 Ω  
Component (P<sub>s</sub>, P<sub>s</sub>) ..... 0.7 Vp-p/75 Ω
- Signal to Noise Ratio ..... 50 dB or more
- Frequency Response (MONITOR OUT)  
Component ..... 5 Hz to 60 MHz, -3 dB

## FM SECTION

- Tuning Range  
[U.S.A. and Canada models] ..... 87.5 to 107.9 MHz  
[General model] ..... 87.5/87.50 to 108.0/108.00 MHz  
[Other models] ..... 87.50 to 108.00 MHz
- Usable Sensitivity (IHF) ..... 1.0 μV (11.2 dBf)
- Signal to Noise Ratio (IHF)  
Mono/Stereo ..... 76 dB/70 dB

- Harmonic Distortion (1 kHz)  
Mono/Stereo ..... 0.2%/0.3%
- Stereo Separation (1 kHz) ..... 42 dB
- Frequency Response ..... 20 Hz to 15 kHz, +0.5, -2 dB

## AM SECTION

- Tuning Range  
[U.S.A. and Canada models] ..... 530 to 1710 kHz  
[General model] ..... 530/531 to 1710/1611 kHz  
[Other models] ..... 531 to 1611 kHz
- Usable Sensitivity ..... 300 μV/m

## GENERAL

- Power Supply  
[U.S.A. and Canada models] ..... AC 120 V, 60 Hz  
[Australia model] ..... AC 240 V, 50 Hz  
[China model] ..... AC 220 V, 50 Hz  
[Korea model] ..... AC 220 V, 60 Hz  
[Europe model] ..... AC 230 V, 50 Hz  
[General model] ..... AC 110/120/220/230-240 V, 50/60 Hz
- Power Consumption  
[U.S.A. and Canada models] ..... 350 W/440 VA  
[Other models] ..... 360 W
- Standby Power Consumption ..... 0.1 W or less
- AC Outlets  
[Australia model] ..... 1 (100 W maximum)  
[U.S.A., Canada and China models] ... 2 (Total 100 W maximum)  
[Europe and General models] ..... 2 (Total 50 W maximum)
- Dimensions (W x H x D) ..... 435 x 171 x 393 mm  
(17.1 x 6.7 x 15.5 in)
- Weight ..... 11.7 kg (25.8 lbs)

## We Want You Listening For A Lifetime



YAMAHA and the Electronic Industries

Association's Consumer Electronics Group want you to get the most out of your equipment by playing it at a safe level. One that lets the sound come through loud and clear without annoying blaring or distortion – and, most importantly, without affecting your sensitive hearing. Since hearing damage from loud sounds is often undetectable until it is too late, YAMAHA and the Electronic Industries Association's Consumer Electronics Group recommend you to avoid prolonged exposure from excessive volume levels.

## GPL/LGPL

This product includes software code subject to the GNU General Public License (GPL) or the GNU Lesser General Public License (LGPL). The copy, distribution, or change of this software code is licensed under the terms of the GPL or the LGPL. The source code is available at the following website:  
<http://www.global.yamaha.com/download/>

The source code is also available on a physical media (such as a CD-ROM) at actual cost.

Contact: AV products division, YAMAHA CORPORATION,  
10-1 Nakazawa-cho, Hamamatsu 430-8650, Japan

In principle, the source code is offered for 3 years from the day of purchase.

## ■ GNU GENERAL PUBLIC LICENSE

### Version 2, June 1991

Copyright (C) 1989, 1991 Free Software Foundation, Inc. 59 Temple Place, Suite 330, Boston, MA 02111-1307 USA Everyone is permitted to copy and distribute verbatim copies of this license document, but changing it is not allowed.

#### Preamble

The licenses for most software are designed to take away your freedom to share and change it. By contrast, the GNU General Public License is intended to guarantee your freedom to share and change free software—to make sure the software is free for all its users. This General Public License applies to most of the Free Software Foundation's software and to any other program whose authors commit to using it. (Some other Free Software Foundation software is covered by the GNU Library General Public License instead.) You can apply it to your programs, too.

When we speak of free software, we are referring to freedom, not price. Our General Public Licenses are designed to make sure that you have the freedom to distribute copies of free software (and charge for this service if you wish), that you receive source code or can get it if you want it, that you can change the software or use pieces of it in new free programs; and that you know you can do these things.

To protect your rights, we need to make restrictions that forbid anyone to deny you these rights or to ask you to surrender the rights. These restrictions translate to certain responsibilities for you if you distribute copies of the software, or if you modify it.

For example, if you distribute copies of such a program, whether gratis or for a fee, you must give the recipients all the rights that you have. You must make sure that they, too, receive or can get the source code. And you must show them these terms so they know their rights.

We protect your rights with two steps: (1) copyright the software, and (2) offer you this license which gives you legal permission to copy, distribute and/or modify the software.

Also, for each author's protection and ours, we want to make certain that everyone understands that there is no warranty for this free software. If the software is modified by someone else and passed on, we want its recipients to know that what they have is not the original, so that any problems introduced by others will not reflect on the original authors' reputations.

Finally, any free program is threatened constantly by software patents. We wish to avoid the danger that redistributors of a free program will individually obtain patent licenses, in effect making the program proprietary. To prevent this, we have made it clear that any patent must be licensed for everyone's free use or not licensed at all.

The precise terms and conditions for copying, distribution and modification follow.

#### TERMS AND CONDITIONS FOR COPYING, DISTRIBUTION AND MODIFICATION

0. This License applies to any program or other work which contains a notice placed by the copyright holder saying it may be distributed under the terms of this General Public License. The "Program", below, refers to any such program or work, and a "work based on the Program" means either the Program or any derivative work under copyright law: that is to say, a work containing the Program or a portion of it, either verbatim or with modifications and/or translated into another language. (Hereinafter, translation is included without limitation in the term "modification".) Each licensee is addressed as "you".

Activities other than copying, distribution and modification are not covered by this License; they are outside its scope. The act of running the Program is not restricted, and the output from the Program is covered only if its contents constitute a work based on the Program (independent of having been made by running the Program). Whether that is true depends on what the Program does.

1. You may copy and distribute verbatim copies of the Program's source code as you receive it, in any medium, provided that you conspicuously and appropriately publish on each copy an appropriate copyright notice and disclaimer of warranty; keep intact all the notices that refer to this License and to the absence of any warranty; and give any other recipients of the Program a copy of this License along with the Program.

You may charge a fee for the physical act of transferring a copy, and you may at your option offer warranty protection in exchange for a fee.

2. You may modify your copy or copies of the Program or any portion of it, thus forming a work based on the Program, and copy and distribute such modifications or work under the terms of Section 1 above, provided that you also meet all of these conditions:
  - a) You must cause the modified files to carry prominent notices stating that you changed the files and the date of any change.
  - b) You must cause any work that you distribute or publish, that in whole or in part contains or is derived from the Program or any part thereof, to be licensed as a whole at no charge to all third parties under the terms of this License.
  - c) If the modified program normally reads commands interactively when run, you must cause it, when started running for such interactive use in the most ordinary way, to print or display an announcement including an appropriate copyright notice and a notice that there is no warranty (or else, saying that you provide a warranty) and that users may redistribute the program under these conditions, and telling the user how to view a copy of this License. (Exception: if the Program itself is interactive but does not normally print such an announcement, your work based on the Program is not required to print an announcement.)

These requirements apply to the modified work as a whole. If identifiable sections of that work are not derived from the Program, and can be reasonably considered independent and separate works in themselves, then this License, and its terms, do not apply to those sections when you distribute them as separate works. But when you distribute the same sections as part of a whole which is a work based on the Program, the distribution of the whole must be on the terms of this License, whose permissions for other licenses extend to the entire whole, and thus to each and every part regardless of who wrote it.

Thus, it is not the intent of this section to claim rights or contest your rights to work written entirely by you; rather, the intent is to exercise the right to control the distribution of derivative or collective works based on the Program.

In addition, mere aggregation of another work not based on the Program with the Program (or with a work based on the Program) on a volume of a storage or distribution medium does not bring the other work under the scope of this License.

3. You may copy and distribute the Program (or a work based on it, under Section 2) in object code or executable form under the terms of Sections 1 and 2 above provided that you also do one of the following:
  - a) Accompany it with the complete corresponding machine-readable source code, which must be distributed under the terms of Sections 1 and 2 above on a medium customarily used for software interchange; or,
  - b) Accompany it with a written offer, valid for at least three years, to give any third party, for a charge no more than your cost of physically performing source distribution, a complete machine-readable copy of the corresponding source code, to be distributed under the terms of Sections 1 and 2 above on a medium customarily used for software interchange; or,
  - c) Accompany it with the information you received as to the offer to distribute corresponding source code. (This alternative is allowed only for noncommercial distribution and only if you received the program in object code or executable form with such an offer, in accord with Subsection b above.)

The source code for a work means the preferred form of the work for making modifications to it. For an executable work, complete source code means all the source code for all modules it contains, plus any associated interface definition files, plus the scripts used to control compilation and installation of the executable. However, as a special exception, the source code distributed need not include anything that is normally distributed (in either source or binary form) with the major components (compiler, kernel, and so on) of the operating system on which the executable runs, unless that component itself accompanies the executable.

If distribution of executable or object code is made by offering access to copy from a designated place, then offering equivalent access to copy the source code from the same place counts as distribution of the source code, even though third parties are not compelled to copy the source along with the object code.

4. You may not copy, modify, sublicense, or distribute the Program except as expressly provided under this License. Any attempt otherwise to copy, modify, sublicense or distribute the Program is void, and will automatically terminate your rights under this License. However, parties who have received copies, or rights, from you under this License will not have their licenses terminated so long as such parties remain in full compliance.
5. You are not required to accept this License, since you have not signed it. However, nothing else grants you permission to modify or distribute the Program or its derivative works. These actions are prohibited by law if you do not accept this License. Therefore, by modifying or distributing the Program (or any work based on the Program), you indicate your acceptance of this License to do so, and all its terms and conditions for copying, distributing or modifying the Program or works based on it.
6. Each time you redistribute the Program (or any work based on the Program), the recipient automatically receives a license from the original licensor to copy, distribute or modify the Program subject to these terms and conditions. You may not impose any further restrictions on the recipients' exercise of the rights granted herein. You are not responsible for enforcing compliance by third parties to this License.
7. If, as a consequence of a court judgment or allegation of patent infringement or for any other reason (not limited to patent issues), conditions are imposed on you (whether by court order, agreement or otherwise) that contradict the conditions of this License, they do not excuse you from the conditions of this License. If you cannot distribute so as to satisfy simultaneously your obligations under this License and any other pertinent obligations, then as a consequence you may not distribute the Program at all. For example, if a patent license would not permit royalty-free redistribution of the Program by all those who receive copies directly or indirectly through you, then the only way you could satisfy both it and this License would be to refrain entirely from distribution of the Program.

If any portion of this section is held invalid or unenforceable under any particular circumstance, the balance of the section is intended to apply and the section as a whole is intended to apply in other circumstances.

It is not the purpose of this section to induce you to infringe any patents or other property right claims or to contest validity of any such claims; this section has the sole purpose of protecting the integrity of the free software distribution system, which is implemented by public license practices. Many people have made generous contributions to the wide range of software distributed through that system in reliance on consistent application of that system; it is up to the author/donor to decide if he or she is willing to distribute software through any other system and a licensee cannot impose that choice.

This section is intended to make thoroughly clear what is believed to be a consequence of the rest of this License.

- If the distribution and/or use of the Program is restricted in certain countries either by patents or by copyrighted interfaces, the original copyright holder who places the Program under this License may add an explicit geographical distribution limitation excluding those countries, so that distribution is permitted only in or among countries not thus excluded. In such case, this License incorporates the limitation as if written in the body of this License.
  - The Free Software Foundation may publish revised and/or new versions of the General Public License from time to time. Such new versions will be similar in spirit to the present version, but may differ in detail to address new problems or concerns.
- Each version is given a distinguishing version number. If the Program specifies a version number of this License which applies to it and "any later version", you have the option of following the terms and conditions either of that version or of any later version published by the Free Software Foundation. If the Program does not specify a version number of this License, you may choose any version ever published by the Free Software Foundation.
- If you wish to incorporate parts of the Program into other free programs whose distribution conditions are different, write to the author to ask for permission. For software which is copyrighted by the Free Software Foundation, write to the Free Software Foundation; we sometimes make exceptions for this. Our decision will be guided by the two goals of preserving the free status of all derivatives of our free software and of promoting the sharing and reuse of software generally.

## NO WARRANTY

- BECAUSE THE PROGRAM IS LICENSED FREE OF CHARGE, THERE IS NO WARRANTY FOR THE PROGRAM, TO THE EXTENT PERMITTED BY APPLICABLE LAW. EXCEPT WHEN OTHERWISE STATED IN WRITING THE COPYRIGHT HOLDERS AND/OR OTHER PARTIES PROVIDE THE PROGRAM "AS IS" WITHOUT WARRANTY OF ANY KIND, EITHER EXPRESSED OR IMPLIED, INCLUDING, BUT NOT LIMITED TO, THE IMPLIED WARRANTIES OF MERCHANTABILITY AND FITNESS FOR A PARTICULAR PURPOSE. THE ENTIRE RISK AS TO THE QUALITY AND PERFORMANCE OF THE PROGRAM IS WITH YOU. SHOULD THE PROGRAM PROVE DEFECTIVE, YOU ASSUME THE COST OF ALL NECESSARY SERVICING, REPAIR OR CORRECTION.
- IN NO EVENT UNLESS REQUIRED BY APPLICABLE LAW OR AGREED TO IN WRITING WILL ANY COPYRIGHT HOLDER, OR ANY OTHER PARTY WHO MAY MODIFY AND/OR REDISTRIBUTE THE PROGRAM AS PERMITTED ABOVE, BE LIABLE TO YOU FOR DAMAGES, INCLUDING ANY GENERAL, SPECIAL, INCIDENTAL OR CONSEQUENTIAL DAMAGES ARISING OUT OF THE USE OR INABILITY TO USE THE PROGRAM (INCLUDING BUT NOT LIMITED TO LOSS OF DATA OR DATA BEING RENDERED INACCURATE OR LOSSES SUSTAINED BY YOU OR THIRD PARTIES OR A FAILURE OF THE PROGRAM TO OPERATE WITH ANY OTHER PROGRAMS), EVEN IF SUCH HOLDER OR OTHER PARTY HAS BEEN ADVISED OF THE POSSIBILITY OF SUCH DAMAGES.

## END OF TERMS AND CONDITIONS

### How to Apply These Terms to Your New Programs

If you develop a new program, and you want it to be of the greatest possible use to the public, the best way to achieve this is to make it free software which everyone can redistribute and change under these terms.

To do so, attach the following notices to the program. It is safest to attach them to the start of each source file to most effectively convey the exclusion of warranty; and each file should have at least the "copyright" line and a pointer to where the full notice is found.

<one line to give the program's name and a brief idea of what it does.>

Copyright (C) <year> <name of author>

This program is free software; you can redistribute it and/or modify it under the terms of the GNU General Public License as published by the Free Software Foundation; either version 2 of the License, or (at your option) any later version.

This program is distributed in the hope that it will be useful, but WITHOUT ANY WARRANTY; without even the implied warranty of MERCHANTABILITY or FITNESS FOR A PARTICULAR PURPOSE. See the GNU General Public License for more details.

You should have received a copy of the GNU General Public License along with this program; if not, write to the Free Software Foundation, Inc., 59 Temple Place, Suite 330, Boston, MA 02111-1307 USA.

Also add information on how to contact you by electronic and paper mail.

If the program is interactive, make it output a short notice like this when it starts in an interactive mode:

Gnomovision version 69, Copyright (C) year name of author Gnomovision comes with ABSOLUTELY NO WARRANTY; for details type 'show w'. This is free software, and you are welcome to redistribute it under certain conditions; type 'show c' for details.

The hypothetical commands 'show w' and 'show c' should show the appropriate parts of the General Public License. Of course, the commands you use may be called something other than 'show w' and 'show c'; they could even be mouse-clicks or menu items—whatever suits your program.

You should also get your employer (if you work as a programmer) or your school, if any, to sign a "copyright disclaimer" for the program, if necessary. Here is a sample; alter the names:

Yoyodyne, Inc., hereby disclaims all copyright interest in the program 'Gnomovision' (which makes passes at compilers) written by James Hacker.

<signature of Ty Coon>, 1 April 1989

Ty Coon, President of Vice

This General Public License does not permit incorporating your program into proprietary programs. If your program is a subroutine library, you may consider it more useful to permit linking proprietary applications with the library. If this is what you want to do, use the GNU Library General Public License instead of this License.

## GNU LESSER GENERAL PUBLIC LICENSE

### Version 2.1, February 1999

Copyright (C) 1991, 1999 Free Software Foundation, Inc.  
59 Temple Place, Suite 330, Boston, MA 02111-1307 USA

Everyone is permitted to copy and distribute verbatim copies of this license document, but changing it is not allowed.

[This is the first released version of the Lesser GPL. It also counts as the successor of the GNU Library Public License, version 2, hence the version number 2.1.]

### Preamble

The licenses for most software are designed to take away your freedom to share and change it. By contrast, the GNU General Public Licenses are intended to guarantee your freedom to share and change free software—to make sure the software is free for all its users.

This license, the Lesser General Public License, applies to some specially designated software packages—typically libraries—of the Free Software Foundation and other authors who decide to use it. You can use it too, but we suggest you first think carefully about whether this license or the ordinary General Public License is the better strategy to use in any particular case, based on the explanations below.

When we speak of free software, we are referring to freedom of use, not price. Our General Public Licenses are designed to make sure that you have the freedom to distribute copies of free software (and charge for this service if you wish); that you receive source code or can get it if you want it; that you can change the software and use pieces of it in new free programs; and that you are informed that you can do these things.

To protect your rights, we need to make restrictions that forbid distributors to deny you these rights or to ask you to surrender these rights. These restrictions translate to certain responsibilities for you if you distribute copies of the library or if you modify it.

For example, if you distribute copies of the library, whether gratis or for a fee, you must give the recipients all the rights that we gave you. You must make sure that they, too, receive or can get the source code. If you link other code with the library, you must provide complete object files to the recipients, so that they can relink them with the library after making changes to the library and recompiling it. And you must show them these terms so they know their rights.

We protect your rights with a two-step method: (1) we copyright the library, and (2) we offer you this license, which gives you legal permission to copy, distribute and/or modify the library.

To protect each distributor, we want to make it very clear that there is no warranty for the free library. Also, if the library is modified by someone else and passed on, the recipients should know that what they have is not the original version, so that the original author's reputation will not be affected by problems that might be introduced by others.

Finally, software patents pose a constant threat to the existence of any free program. We wish to make sure that a company cannot effectively restrict the users of a free program by obtaining a restrictive license from a patent holder. Therefore, we insist that any patent license obtained for a version of the library must be consistent with the full freedom of use specified in this license.

Most GNU software, including some libraries, is covered by the ordinary GNU General Public License. This license, the GNU Lesser General Public License, applies to certain designated libraries, and is quite different from the ordinary General Public License. We use this license for certain libraries in order to permit linking those libraries into non-free programs.

When a program is linked with a library, whether statically or using a shared library, the combination of the two is legally speaking a combined work, a derivative of the original library. The ordinary General Public License therefore permits such linking only if the entire combination fits its criteria of freedom. The Lesser General Public License permits more lax criteria for linking other code with the library.

We call this license the "Lesser" General Public License because it does Less to protect the user's freedom than the ordinary General Public License. It also provides other free software developers Less of an advantage over competing non-free programs. These disadvantages are the reason we use the ordinary General Public License for many libraries. However, the Lesser license provides advantages in certain special circumstances.

For example, on rare occasions, there may be a special need to encourage the widest possible use of a certain library, so that it becomes a de-facto standard. To achieve this, non-free programs must be allowed to use the library. A more frequent case is that a free library does the same job as widely used non-free libraries. In this case, there is little to gain by limiting the free library to free software only, so we use the Lesser General Public License.

In other cases, permission to use a particular library in non-free programs enables a greater number of people to use a large body of free software. For example, permission to use the GNU C Library in non-free programs enables many more people to use the whole GNU operating system, as well as its variant, the GNU/Linux operating system.

Although the Lesser General Public License is Less protective of the users' freedom, it does ensure that the user of a program that is linked with the Library has the freedom and the wherewithal to run that program using a modified version of the Library.

The precise terms and conditions for copying, distribution and modification follow. Pay close attention to the difference between a "work based on the library" and a "work that uses the library". The former contains code derived from the library, whereas the latter must be combined with the library in order to run.

## TERMS AND CONDITIONS FOR COPYING, DISTRIBUTION AND MODIFICATION

0. This License Agreement applies to any software library or other program which contains a notice placed by the copyright holder or other authorized party saying it may be distributed under the terms of this Lesser General Public License (also called "this License"). Each licensee is addressed as "you".

A "library" means a collection of software functions and/or data prepared so as to be conveniently linked with application programs (which use some of those functions and data) to form executables.

The "Library", below, refers to any such software library or work which has been distributed under these terms. A "work based on the Library" means either the Library or any derivative work under copyright law: that is to say, a work containing the Library or a portion of it, either verbatim or with modifications and/or translated straightforwardly into another language. (Hereinafter, translation is included without limitation in the term "modification".)

"Source code" for a work means the preferred form of the work for making modifications to it. For a library, complete source code means all the source code for all modules it contains, plus any associated interface definition files, plus the scripts used to control compilation and installation of the library.

Activities other than copying, distribution and modification are not covered by this License; they are outside its scope. The act of running a program using the Library is not restricted, and output from such a program is covered only if its contents constitute a work based on the Library (independent of the use of the Library in a tool for writing it). Whether that is true depends on what the Library does and what the program that uses the Library does.

1. You may copy and distribute verbatim copies of the Library's complete source code as you receive it, in any medium, provided that you conspicuously and appropriately publish on each copy an appropriate copyright notice and disclaimer of warranty; keep intact all the notices that refer to this License and to the absence of any warranty; and distribute a copy of this License along with the Library.

You may charge a fee for the physical act of transferring a copy, and you may at your option offer warranty protection in exchange for a fee.

2. You may modify your copy or copies of the Library or any portion of it, thus forming a work based on the Library, and copy and distribute such modifications or work under the terms of Section 1 above, provided that you also meet all of these conditions:
  - a) The modified work must itself be a software library.
  - b) You must cause the files modified to carry prominent notices stating that you changed the files and the date of any change.
  - c) You must cause the whole of the work to be licensed at no charge to all third parties under the terms of this License.
  - d) If a facility in the modified Library refers to a function or a table of data to be supplied by an application program that uses the facility, other than as an argument passed when the facility is invoked, then you must make a good faith effort to ensure that, in the event an application does not supply such function or table, the facility still operates, and performs whatever part of its purpose remains meaningful.

(For example, a function in a library to compute square roots has a purpose that is entirely well-defined independent of the application. Therefore, Subsection 2d requires that any application-supplied function or table used by this function must be optional: if the application does not supply it, the square root function must still compute square roots.)

These requirements apply to the modified work as a whole. If identifiable sections of that work are not derived from the Library, and can be reasonably considered independent and separate works in themselves, then this License, and its terms, do not apply to those sections when you distribute them as separate works. But when you distribute the same sections as part of a whole which is a work based on the Library, the distribution of the whole must be on the terms of this License, whose permissions for other licensees extend to the entire whole, and thus to each and every part regardless of who wrote it.

Thus, it is not the intent of this section to claim rights or contest your rights to work written entirely by you; rather, the intent is to exercise the right to control the distribution of derivative or collective works based on the Library.

In addition, mere aggregation of another work not based on the Library with the Library (or with a work based on the Library) on a volume of a storage or distribution medium does not bring the other work under the scope of this License.

3. You may opt to apply the terms of the ordinary GNU General Public License instead of this License to a given copy of the Library. To do this, you must alter all the notices that refer to this License, so that they refer to the ordinary GNU General Public License, version 2, instead of to this License. (If a newer version than version 2 of the ordinary GNU General Public License has appeared, then you can specify that version instead if you wish.) Do not make any other change in these notices.

Once this change is made in a given copy, it is irreversible for that copy, so the ordinary GNU General Public License applies to all subsequent copies and derivative works made from that copy.

This option is useful when you wish to copy part of the code of the Library into a program that is not a library.

4. You may copy and distribute the Library (or a portion or derivative of it, under Section 2) in object code or executable form under the terms of Sections 1 and 2 above provided that you accompany it with the complete corresponding machine-readable source code, which must be distributed under the terms of Sections 1 and 2 above on a medium customarily used for software interchange.

If distribution of object code is made by offering access to copy from a designated place, then offering equivalent access to copy the source code from the same place satisfies the requirement to distribute the source code, even though third parties are not compelled to copy the source along with the object code.

5. A program that contains no derivative of any portion of the Library, but is designed to work with the Library by being compiled or linked with it, is called a "work that uses the Library". Such a work, in isolation, is not a derivative work of the Library, and therefore falls outside the scope of this License.

However, linking a "work that uses the Library" with the Library creates an executable that is a derivative of the Library (because it contains portions of the Library), rather than a "work that uses the library". The executable is therefore covered by this License. Section 6 states terms for distribution of such executables.

When a "work that uses the Library" uses material from a header file that is part of the Library, the object code for the work may be a derivative work of the Library even though the source code is not. Whether this is true is especially significant if the work can be linked without the Library, or if the work is itself a library. The threshold for this to be true is not precisely defined by law.

If such an object file uses only numerical parameters, data structure layouts and accessors, and small macros and small inline functions (ten lines or less in length), then the use of the object file is unrestricted, regardless of whether it is legally a derivative work. (Executables containing this object code plus portions of the Library will still fall under Section 6.)

Otherwise, if the work is a derivative of the Library, you may distribute the object code for the work under the terms of Section 6. Any executables containing that work also fall under Section 6, whether or not they are linked directly with the Library itself.

6. As an exception to the Sections above, you may also combine or link a "work that uses the Library" with the Library to produce a work containing portions of the Library, and distribute that work under terms of your choice, provided that the terms permit modification of the work for the customer's own use and reverse engineering for debugging such modifications.

You must give prominent notice with each copy of the work that the Library is used in it and that the Library and its use are covered by this License. You must supply a copy of this License. If the work during execution displays copyright notices, you must include the copyright notice for the Library among them, as well as a reference directing the user to the copy of this License. Also, you must do one of these things:

- a) Accompany the work with the complete corresponding machine-readable source code for the Library including whatever changes were used in the work (which must be distributed under Sections 1 and 2 above); and, if the work is an executable linked with the Library, with the complete machine-readable "work that uses the Library", as object code and/or source code, so that the user can modify the Library and then relink to produce a modified executable containing the modified Library. (It is understood that the user who changes the contents of definitions files in the Library will not necessarily be able to recompile the application to use the modified definitions.)
- b) Use a suitable shared library mechanism for linking with the Library. A suitable mechanism is one that (1) uses at run time a copy of the library already present on the user's computer system, rather than copying library functions into the executable, and (2) will operate properly with a modified version of the library, if the user installs one, as long as the modified version is interface-compatible with the version that the work was made with.
- c) Accompany the work with a written offer, valid for at least three years, to give the same user the materials specified in Subsection 6a, above, for a charge no more than the cost of performing this distribution.
- d) If distribution of the work is made by offering access to copy from a designated place, offer equivalent access to copy the above specified materials from the same place.
- e) Verify that the user has already received a copy of these materials or that you have already sent this user a copy.

For an executable, the required form of the "work that uses the Library" must include any data and utility programs needed for reproducing the executable from it. However, as a special exception, the materials to be distributed need not include anything that is normally distributed (in either source or binary form) with the major components (compiler, kernel, and so on) of the operating system on which the executable runs, unless that component itself accompanies the executable.

It may happen that this requirement contradicts the license restrictions of other proprietary libraries that do not normally accompany the operating system. Such a contradiction means you cannot use both them and the Library together in an executable that you distribute.

7. You may place library facilities that are a work based on the Library side-by-side in a single library together with other library facilities not covered by this License, and distribute such a combined library, provided that the separate distribution of the work based on the Library and of the other library facilities is otherwise permitted, and provided that you do these two things:
  - a) Accompany the combined library with a copy of the same work based on the Library, uncombined with any other library facilities. This must be distributed under the terms of the Sections above.
  - b) Give prominent notice with the combined library of the fact that part of it is a work based on the Library, and explaining where to find the accompanying uncombined form of the same work.
8. You may not copy, modify, sublicense, link with, or distribute the Library except as expressly provided under this License. Any attempt otherwise to copy, modify, sublicense, link with, or distribute the Library is void, and will automatically terminate your rights under this License. However, parties who have received copies, or rights, from you under this License will not have their licenses terminated so long as such parties remain in full compliance.
9. You are not required to accept this License, since you have not signed it. However, nothing else grants you permission to modify or distribute the Library or its derivative works. These actions are prohibited by law if you do not accept this License. Therefore, by modifying or distributing the Library (or any work based on the Library), you indicate your acceptance of this License to do so, and all its terms and conditions for copying, distributing or modifying the Library or works based on it.
10. Each time you redistribute the Library (or any work based on the Library), the recipient automatically receives a license from the original licensor to copy, distribute, link with or modify the Library subject to these terms and conditions. You may not impose any further restrictions on the recipients' exercise of the rights granted herein. You are not responsible for enforcing compliance by third parties with this License.
11. If, as a consequence of a court judgment or allegation of patent infringement or for any other reason (not limited to patent issues), conditions are imposed on you (whether by court order, agreement or otherwise) that contradict the conditions of this License, they do not excuse you from the conditions of this License. If you cannot distribute so as to satisfy simultaneously your obligations under this License and any other pertinent obligations, then as a consequence you may not distribute the Library at all. For example, if a patent license would not permit royalty-free redistribution of the Library by all those who receive copies directly or indirectly through you, then the only way you could satisfy both it and this License would be to refrain entirely from distribution of the Library.

If any portion of this section is held invalid or unenforceable under any particular circumstance, the balance of the section is intended to apply, and the section as a whole is intended to apply in other circumstances.

It is not the purpose of this section to induce you to infringe any patents or other property right claims or to contest validity of any such claims; this section has the sole purpose of protecting the integrity of the free software distribution system which is implemented by public license practices. Many people have made generous contributions to the wide range of software distributed through that system in reliance on consistent application of that system; it is up to the author/donor to decide if he or she is willing to distribute software through any other system and a licensee cannot impose that choice.

This section is intended to make thoroughly clear what is believed to be a consequence of the rest of this License.

12. If the distribution and/or use of the Library is restricted in certain countries either by patents or by copyrighted interfaces, the original copyright holder who places the Library under this License may add an explicit geographical distribution limitation excluding those countries, so that distribution is permitted only in or among countries not thus excluded. In such case, this License incorporates the limitation as if written in the body of this License.
13. The Free Software Foundation may publish revised and/or new versions of the Lesser General Public License from time to time. Such new versions will be similar in spirit to the present version, but may differ in detail to address new problems or concerns.

Each version is given a distinguishing version number. If the Library specifies a version number of this License which applies to it and "any later version", you have the option of following the terms and conditions either of that version or of any later version published by the Free Software Foundation. If the Library does not specify a license version number, you may choose any version ever published by the Free Software Foundation.

14. If you wish to incorporate parts of the Library into other free programs whose distribution conditions are incompatible with these, write to the author to ask for permission. For software which is copyrighted by the Free Software Foundation, write to the Free Software Foundation; we sometimes make exceptions for this. Our decision will be guided by the two goals of preserving the free status of all derivatives of our free software and of promoting the sharing and reuse of software generally.

## NO WARRANTY

15. BECAUSE THE LIBRARY IS LICENSED FREE OF CHARGE, THERE IS NO WARRANTY FOR THE LIBRARY, TO THE EXTENT PERMITTED BY APPLICABLE LAW. EXCEPT WHEN OTHERWISE STATED IN WRITING THE COPYRIGHT HOLDERS AND/OR OTHER PARTIES PROVIDE THE LIBRARY "AS IS" WITHOUT WARRANTY OF ANY KIND, EITHER EXPRESSED OR IMPLIED, INCLUDING, BUT NOT LIMITED TO, THE IMPLIED WARRANTIES OF MERCHANTABILITY AND FITNESS FOR A PARTICULAR PURPOSE. THE ENTIRE RISK AS TO THE QUALITY AND PERFORMANCE OF THE LIBRARY IS WITH YOU. SHOULD THE LIBRARY PROVE DEFECTIVE, YOU ASSUME THE COST OF ALL NECESSARY SERVICING, REPAIR OR CORRECTION.
16. IN NO EVENT UNLESS REQUIRED BY APPLICABLE LAW OR AGREED TO IN WRITING WILL ANY COPYRIGHT HOLDER, OR ANY OTHER PARTY WHO MAY MODIFY AND/OR REDISTRIBUTE THE LIBRARY AS PERMITTED ABOVE, BE LIABLE TO YOU FOR DAMAGES, INCLUDING ANY GENERAL, SPECIAL, INCIDENTAL OR CONSEQUENTIAL DAMAGES ARISING OUT OF THE USE OR INABILITY TO USE THE LIBRARY (INCLUDING BUT NOT LIMITED TO LOSS OF DATA OR DATA BEING RENDERED INACCURATE OR LOSSES SUSTAINED BY YOU OR THIRD PARTIES OR A FAILURE OF THE LIBRARY TO OPERATE WITH ANY OTHER SOFTWARE), EVEN IF SUCH HOLDER OR OTHER PARTY HAS BEEN ADVISED OF THE POSSIBILITY OF SUCH DAMAGES.

## END OF TERMS AND CONDITIONS

### How to Apply These Terms to Your New Libraries

If you develop a new library, and you want it to be of the greatest possible use to the public, we recommend making it free software that everyone can redistribute and change. You can do so by permitting redistribution under these terms (or, alternatively, under the terms of the ordinary General Public License).

To apply these terms, attach the following notices to the library. It is safest to attach them to the start of each source file to most effectively convey the exclusion of warranty; and each file should have at least the "copyright" line and a pointer to where the full notice is found.

<one line to give the library's name and a brief idea of what it does.>

Copyright (C) <year> <name of author>

This library is free software; you can redistribute it and/or modify it under the terms of the GNU Lesser General Public License as published by the Free Software Foundation; either version 2.1 of the License, or (at your option) any later version.

This library is distributed in the hope that it will be useful, but WITHOUT ANY WARRANTY; without even the implied warranty of MERCHANTABILITY or FITNESS FOR A PARTICULAR PURPOSE. See the GNU Lesser General Public License for more details.

You should have received a copy of the GNU Lesser General Public License along with this library; if not, write to the Free Software Foundation, Inc., 59 Temple Place, Suite 330, Boston, MA 02111-1307 USA

Also add information on how to contact you by electronic and paper mail.

You should also get your employer (if you work as a programmer) or your school, if any, to sign a "copyright disclaimer" for the library, if necessary. Here is a sample; alter the names:

Yooyodyne, Inc., hereby disclaims all copyright interest in the library 'Frob' (a library for tweaking knobs) written by James Random Hacker.

<signature of Ty Coon>, 1 April 1990

Ty Coon, President of Vice

That's all there is to it!

# LIST OF REMOTE CONTROL CODES

## CABLE TV RECEIVER

ABC	10003, 10008, 10014, 10017, 10033
AMERICAST	10899
BELL & HOWELL	10014
BELL SOUTH	10899
CLEARMASTER	10883
CLEARMAX	10883
COOLMAX	10883
DIGEO	11187
DIGI	10637
DIRECTOR	10476
DUMONT	10637
GENERAL INSTRUMENT	10003, 10276, 10476, 10810
GOLDSTAR	10144
HAMLIN	10009, 10273
I3 MICRO	11602
JERROLD	10003, 10012, 10014, 10276, 10476, 10810
MACOM	10033
MEMOREX	10000
MOTOROLA	10014, 10276, 10476, 10810, 11187, 11254, 11376
MULTITECH	10883
MYRIO	11602
PACE	10008, 10237, 11877
PANASONIC	10000, 10107
PANTHER	10637
PARAGON	10000
PHILIPS	10317, 11305
PIONEER	10144, 10533, 10877, 11877
PULSAR	10000
QUASAR	10000
RADIOSHACK	10883
RCA	11256
REGAL	10273, 10279
RUNCO	10000
SAMSUNG	10144
SCIENTIFIC ATLANTA	10008, 10017, 10477, 10877, 11877
SEJIN	11602
SONY	11006
STARCOM	10003
SUPERCABLE	10276
SUPERMAX	10883
THOMSON	11256
TOCOM	10012
TORX	10003
TOSHIBA	10000
TRISTAR	10883
V2	10883
VIEWMASTER	10883
VISION	10883
VORTEX VIEW	10883
ZENITH	10000, 10525, 10899

## CABLE/PVR COMBINATION

AMERICAST	10899
DIGEO	11187
GENERAL INSTRUMENT	10476, 10810
JERROLD	10476, 10810

MOTOROLA	10476, 10810, 11187, 11376
PACE	10237, 11877
PIONEER	10877, 11877
RCA	11256
SCIENTIFIC ATLANTA	10877, 11877
SONY	11006
SUPERCABLE	10276
THOMSON	11256
ZENITH	10899

## DBS/PVR COMBINATION

DIRECTV	10099, 10392, 10639, 11076, 11142, 11377, 11392, 11442, 11443, 11444, 11640
DISH NETWORK SYSTEM	10775, 11505
DISHPRO	10775, 11505
ECHOSTAR	10775, 11170, 11505
EXPRESSVU	10775
HUGHES NETWORK SYSTEMS	11142, 11442, 11443, 11444
JVC	11170
MOTOROLA	10869
PHILIPS	11142, 11442
PROSCAN	10392
RCA	11392
SAMSUNG	11442
SONY	10639, 11640
STAR CHOICE	10869

## SATELLITE RECEIVER

ALPHASTAR	10772
CHAPARRAL	10053, 10216
CROSSDIGITAL	11109
DIRECTV	10099, 10247, 10392, 10566, 10639, 10724, 10749, 10819, 11076, 11108, 11109, 11142, 11377, 11392, 11414, 11442, 11443, 11444, 11609, 11639, 11640, 11749, 11856
DISH NETWORK SYSTEM	10775, 11005, 11170, 11505, 11775
DISHPRO	10775, 11005, 11505, 11775
ECHOSTAR	10269, 10280, 10775, 11005, 11170, 11505, 11775
EXPRESSVU	10775, 11775
GE	10392, 10566
GENERAL INSTRUMENT	10869
GOI	10775, 11775
GOODMANS	11246
HISENSE	11535
HITACHI	10819, 11250
HOMEABLE	10238
HTS	10775, 11775

HUGHES	10749, 11442, 11749
HUGHES NETWORK SYSTEMS	10749, 11142, 11442, 11443, 11444, 11749
ILO	11535
IQ	10210
IQ PRISM	10210
JERROLD	10869
JVC	10775, 11170, 11775
LEGEND	10269
LG	11226, 11414
MAGNAVOX	10722, 10724
MEMOREX	10269, 10724
MITSUBISHI	10749
MOTOROLA	10856, 10869
NEC	11270
NEXT LEVEL	10869
PANASONIC	10247, 10701
PAYSAT	10724
PHILIPS	10099, 10722, 10724, 10749, 10819, 11076, 11142, 11442, 11749
PIONEER	11442
PROSCAN	10392, 10566
PROTON	11535
RADIOSHACK	10869
RCA	10143, 10392, 10566, 10855, 11392
REALISTIC	10052
SAMSUNG	11108, 11109, 11142, 11276, 11377, 11442, 11609
SANYO	11219
SONY	10639, 11639, 11640
STAR CHOICE	10869
STS	10210
TIVO	11142, 11442, 11443, 11444
TOSHIBA	10082, 10749, 10790, 10819, 11285, 11749
ULTIMATETV	11392, 11640
UNIDEN	10052, 10074, 10238, 10722, 10724
US DIGITAL	11535
USDTV	11535
VOOM	10869
ZENITH	11856

## HDTV DECORDER

ACCURIAN	11653
EPSON	11563, 11650
LG	11415
MACRO IMAGE TECHNOLOGY	11383
MOTOROLA	11363
MYHD	11383
PANASONIC	11120
PIONEER	11010
PRINCETON	10113, 10295
SAMSUNG	11190, 11490
SASEM	11641
SENSORY SCIENCE	11126
SHARP	11010
SYLVANIA	11563
TELEMANN	11604
VIEWSONIC	11329
VIZIO	11126

## OTHER VIDEO ACCESSORIES

ABS	11272
ACCURIAN	11653
ALIENWARE	11272
CYBERPOWER	11272
D-LINK	11554
ECS	11553
EPSON	11563, 11650
GATEWAY	11272
HEWLETT PACKARD	11267, 11272
HOWARD COMPUTERS	11272
HP	11272
HUSH	11272
IBUYPOWER	11272
INTERVIDEO	11393
KEYSPAN	11344
KWORLD	11403
LEADTEK	11614
LG	11415
LINKSYS	11272, 11365
MACRO IMAGE TECHNOLOGY	11383
MEDIA CENTER PC	11272
MICROSOFT	11272
MIND	11272
MOTOROLA	11363
MYHD	11383
NIVEUS MEDIA	11272
NORTHGATE	11272
PANASONIC	11120
PINNACLE SYSTEMS	11268
PIONEER	11010
PRINCETON	10113, 10295
RICAVISION	11272
ROKU	11486
SAMSUNG	11190, 11490
SASEM	11641
SENSORY SCIENCE	11126
SHARP	11010
SMC	11456
SONY	11272, 11324, 11364
STACK 9	11272
STREAMZAP	11309
SYLVANIA	11563
SYSTEMAX	11272
TAGAR SYSTEMS	11272
TELEMANN	11604
TOSHIBA	11272
TOUCH	11272
VIEWSONIC	11272, 11329
VIZIO	11126
VOODOO	11272
ZT GROUP	11272

## TV

ADMIRAL	20093, 20463
ADVENT	20761, 20783, 20815, 20817, 20842, 21933
AIKO	20092
AIWA	20701
AKAI	20030, 20060, 20672, 20702, 20812, 21903
ALBATRON	20700, 20843
AMERICA ACTION	20180



AMPRO	20751	GE	20047, 20051, 20178, 20451, 21147, 21347, 21447, 21917, 21919, 21922	MTC	20030, 20060	SEARS	20047, 20054, 20154, 20156, 20171, 20178, 21904, 21926
ANAM	20180			MULTITECH	20180		20093, 20153, 20491, 20688, 20689, 20818, 20851, 21917
AOC	20030			NAD	20156, 20178, 20866	SHARP	
APEX DIGITAL		GIBRALTER	20017, 20030	NEC	20030, 20497, 20882, 21704		
	20156, 20748, 20765, 20767, 20879, 21943	GO VIDEO	20886	NETTV	21755		
AUDIOVOX	20092, 20180, 20451, 20623, 20802, 20875, 21937, 21951, 21952	GOLDSTAR	20030, 20178, 21926	NIKKO	20030, 20092, 20178		
		GOODMANS	20360	NORCENT	20748, 20824	SHENG CHIA	20093
AVENTURA	20171	GRUNDIG	20683	NTC	20092	SOLE	20813
AXION	21937	GRUNPY	20180	ONWA	20180	SONY	20000, 20011, 20080, 20111, 20810, 20834, 20867, 21100, 21904, 21925
BELL & HOWELL		HAIER	21034	OPTIMUS	20154, 20166, 20250, 20650		
	20154	HALLMARK	20178	OPTOMA	20887	SOUNDESIGN	
BENQ	21032	HARLEY DAVIDSON	21904	OPTONICA	20093		
BOXLIGHT	20893	HARMAN/KARDON	20054	ORION	20236, 20463, 21463, 21929	SOVA	21952
BRADFORD	20180	HARVARD	20180	PANASONIC	20051, 20226, 20250, 20650, 20863, 21410, 21919, 21941, 21946, 21947	SQUAREVIEW	
BROKSONIC	20180, 20236, 20463, 21929, 21935, 21938	HAVERMY	20093		20250, 20650, 20863, 21410, 21919, 21941, 21946, 21947		20171
		HELIOS	20865	PENNEY	20030, 20047, 20051, 20060, 20156, 20178, 21347, 21919, 21926	SSS	20180
CANDLE	20030	HELLO KITTY	20451			STARLITE	20180
CARNIVALE	20030	HISENSE	20748	PHILCO	20030, 20054	STUDIO EXPERIENCE	
CARVER	20054	HITACHI	20038, 20145, 20151, 20413, 21145, 21904, 21960	PHILIPS	20054, 20690, 21154, 21454		20843
CELEBRITY	20000			PILOT	20030	SUPERSCAN	20093, 20864
CELERA	20765	HYUNDAI	20849	PIONEER	20038, 20166, 20679, 20866	SUPREME	20000
CHANGHONG		INFINITY	20054		20765, 20865	SVA	20587, 20748, 20865, 20870, 20871, 20872
	20765	INTEQ	20017	POLAROID	20092	SYLVANIA	20030, 20054, 20171, 21931, 21944
CITIZEN	20030, 20060, 20092, 21928	JBL	20054	PORTLAND	20092		
CLARION	20180	JCB	20000	PRIMA	20761, 20783, 20815, 20817, 21933	SYMPHONIC	20171, 20180, 21904
COMMERCIAL SOLUTIONS	20047, 21447	JENSEN	20761, 20815, 20817, 21933	PRINCETON	20700, 20717	TANDY	20093
CONTEC	20180	JVC	20053, 20069, 20160, 20169, 20731, 21253	PRISM	20051	TATUNG	21756
CRAIG	20180	KEC	20180	PROSCAN	20047, 20466, 21347, 21447, 21922	TECHNICS	20051, 20250
CROSLEY	20054	KENWOOD	20030, 20859	PROTON	20178, 20466	TECHVIEW	20847
CROWN	20180	KLH	20765, 20767, 21962	PULSAR	20017	TECHWOOD	20051
CURTIS MATHES		KTV	20030, 20180	QUASAR	20051, 20250, 20650, 21919	TEKNIKA	20054, 20060, 20092, 20150, 20180
	20030, 20047, 20054, 20060, 20093, 20145, 20154, 20166, 20451, 20466, 20702, 21147, 21347, 21919	LG	20178, 20442, 20700, 20856, 21178, 21265	RADIOSHACK	20030, 20047, 20154, 20178, 20180, 21904	TELEFUNKEN	20702
CXC	20180	LLOYD'S	21904	RCA	20038, 20047, 20090, 20679, 21047, 21147, 21247, 21347, 21447, 21547, 21917, 21919, 21922, 21948, 21953, 21958	THOMAS	21904
DAEWOO	20092, 20451, 20623, 20661, 20672, 21661, 21928	LOEWE	20136		20030, 20060, 20178, 20587, 20702, 20766, 20812, 20814, 21060, 21903, 21959	TMK	20178
DELL	21080, 21178, 21454	LXI	20047, 20054, 20154, 20156, 20178	REALISTIC	20030, 20154, 20178, 20180	TNCI	20017
DENON	20145, 20511	MAGNASONIC	21928	RUNCO	20017, 20030, 20497, 20603	TOSHIBA	20060, 20154, 20156, 20650, 20832, 20845, 21156, 21256, 21265, 21356, 21656, 21704, 21918, 21935, 21936, 21945
DUMONT	20017	MAGNAVOX	20030, 20054, 20706, 20802, 21254, 21454, 21904, 21931, 21944	SAMPO	20030, 21755	TVS	20463
DURABRAND	20171, 20178, 20180, 20463, 21034	MARANTZ	20030, 20054, 20704, 20854, 20855, 21154, 21454	SAMSUNG	20030, 20060, 20178, 20587, 20702, 20766, 20812, 20814, 21060, 21903, 21959	VECTOR RESEARCH	20030
DWIN	20093, 20720, 20774	MATSUSHITA	20250, 20650		20030, 21755	VICTOR	20053
ELECTROBAND	20000	MAXENT	21755		20030, 20060, 20178, 20587, 20702, 20766, 20812, 20814, 21060, 21903, 21959	VIDIKRON	20054
ELECTROGRAPH	21755	MEGAPOWER	20700		20030, 20154, 20178, 20180	VIDTECH	20178
EMERSON	20038, 20154, 20171, 20178, 20180, 20236, 20451, 20463, 20623, 21928, 21929, 21944	MEGATRON	20145, 20178		20017, 20030, 20497, 20603	VIEWSONIC	20857, 20864, 20885, 21755
		MEMOREX	20150, 20154, 20178, 20463, 21926	SANSUI	20463, 21904, 21929, 21935	VIZIO	20864, 20885, 21756
ENVISION	20030, 20813	MGA	20030, 20150, 20155, 20178	SANYO	20088, 20154, 20484, 20799, 20893	WARDS	20030, 20054, 20080, 20111, 20178, 20866, 21156
EPSON	20833, 20840	MIDLAND	20017, 20047, 20051	SCOTCH	20178	WAYCON	20156
ESA	20171, 20812	MITSUBISHI	20014, 20093, 20150, 20155, 20178, 20331, 20358, 20836, 20868, 21250, 21917	SCOTT	20178, 20180, 20236	WESTINGHOUSE	20451, 20889
FISHER	20154					WHITE WESTINGHOUSE	20463, 20623
FUJITSU	20683, 20809, 20853					YAMAHA	20030, 20650, 20769, 20833, 20839, 21405, 21406, 21407
FUNAI	20171, 20180, 21904					ZENITH	20017, 20092, 20178, 20463, 21145, 21904, 21929
FUTURETECH	20180						
GATEWAY	21755, 21756	MONIVISION	20700, 20843				
		MOTOROLA	20093				

---

**PVR**

ABS 31972  
ALIENWARE 31972  
CYBERPOWER31972  
DELL 31972  
DIRECTV 30739  
GATEWAY 31972  
HEWLETT PACKARD  
31972  
HOWARD COMPUTERS  
31972  
HP 31972  
HUGHES NETWORK SYSTEMS  
30739  
HUMAX 30739  
HUSH 31972  
IBUYPOWER 31972  
LG 32010  
LINKSYS 31972  
MEDIA CENTER PC  
31972  
MICROSOFT 31972  
MIND 31972  
NIVEUS MEDIA  
31972  
NORTHGATE 31972  
PANASONIC 30616, 31807,  
31808, 31809  
PHILIPS 30618, 30739  
RCA 30880  
REPLAYTV 30614, 30616  
SONIC BLUE 30614, 30616  
SONY 30636, 31972  
STACK 9  
31972  
SYSTEMAX 31972  
TAGAR SYSTEMS  
31972  
TIVO 30618, 30636,  
30739  
TOSHIBA 31008, 31972  
TOUCH 31972  
VIEWSONIC 31972  
VOODOO 31972  
ZT GROUP 31972

---

**VCR**

ABS 31972  
ADMIRAL 30048, 30209,  
30479  
AIKO 30278  
AIWA 30037  
AKAI 30041  
ALIENWARE 31972  
AMERICA ACTION  
30278  
AMERICAN HIGH  
30035  
ASHA 30240  
AUDIOVOX 30037, 30278  
BEAUMARK 30240  
BELL & HOWELL  
30104  
BROKSONIC 30002, 30121,  
30184, 30209,  
30479  
CALIX 30037  
CANON 30035  
CARVER 30081  
CCE 30072, 30278  
CITIZEN 30037, 30278  
COLT 30072  
CRAIG 30037, 30047,  
30072, 30240  
CURTIS MATHES  
30035, 30041,  
30060, 30162  
CYBERNEX 30240  
CYBERPOWER  
31972  
DAEWOO 30045, 30278  
DELL 31972  
DENON 30042  
DIRECTV 30739

DURABRAND 30038, 30039  
ELECTROHOME  
30037, 30043  
ELECTROPHONIC  
30037  
EMEREX 30032  
EMERSON 30002, 30037,  
30043, 30121,  
30184, 30209,  
30278, 30479,  
30593, 31593  
FISHER 30047, 30104  
FUJI 30033, 30035  
FUNAI 30593, 31593  
GATEWAY 31972  
GE 30035, 30060,  
30240  
GO VIDEO 30240, 30432  
GOLDSTAR 30037, 30038  
HARMAN/KARDON  
30038, 30081  
HARWOOD 30072  
HEWLETT PACKARD  
31972  
HI-Q 30047  
HITACHI 30041, 30042  
HOWARD COMPUTERS  
31972  
HP 31972  
HUGHES NETWORK SYSTEMS  
30042, 30739  
HUMAX 30739, 31988  
HUSH 31972  
IBUYPOWER 31972  
JENSEN 30041  
JVC 30041, 30067,  
31162  
KEC 30037, 30278  
KENWOOD 30038, 30041,  
30067  
KLH 30072  
KODAK 30035, 30037  
LG 31037, 32010  
LINKSYS 31972  
LOGIK 30072  
LXI 30037  
MAGNASONIC  
30593  
MAGNAVOX 30035, 30039,  
30081, 30149,  
30563, 30593  
MAGNIN 30240  
MARANTZ 30035, 30081  
MARTA 30037  
MATSUSHITA 30035, 30162,  
31162  
MEDIA CENTER PC  
31972  
MEI 30035  
MEMOREX 30035, 30037,  
30039, 30047,  
30048, 30104,  
30162, 30209,  
30240, 30479,  
31037, 31162,  
31262  
MGA 30043, 30240  
MGN TECHNOLOGY  
30240  
MICROSOFT 31972  
MIND 31972  
MINOLTA 30042  
MITSUBISHI 30043, 30067  
MOTOROLA 30035, 30048  
MTC 30240  
MULTITECH 30072  
NEC 30038, 30041,  
30067, 30104  
NIKKO 30037  
NIVEUS MEDIA  
31972  
NOBLEX 30240  
NORTHGATE 31972  
OLYMPUS 30035

OPTIMUS 30037, 30048,  
30104, 30162,  
30432, 30593,  
31048, 31062,  
31162, 31262  
ORION 30002, 30184,  
30209, 30479  
PANASONIC 30035, 30162,  
30616, 31062,  
31162, 31244,  
31262, 31562,  
31807, 31808,  
31809  
PENNEY 30035, 30037,  
30038, 30042,  
30240  
PENTAX 30042  
PHILCO 30035  
PHILIPS 30035, 30081,  
30618, 30739,  
31081, 31181  
PILOT 30037  
PIONEER 30067  
POLK AUDIO 30081  
PROFITRONIC  
30240  
PROSCAN 30060  
PROTEC 30072  
PULSAR 30039  
QUASAR 30035, 30162,  
31162  
RADIOSHACK  
31037  
RADIX 30037  
RANDEx 30037  
RCA 30042, 30060,  
30149, 30240,  
30880  
REALISTIC 30035, 30037,  
30047, 30048,  
30104  
REPLAYTV 30614, 30616  
RICAVISION 31972  
RUNCO 30039  
SAMSUNG 30045, 30240,  
30739  
SANKY 30039, 30048  
SANSUI 30041, 30067,  
30209, 30479  
SANYO 30047, 30104,  
30240  
SCOTT 30043, 30045,  
30121, 30184  
SEARS 30035, 30037,  
30042, 30047,  
30104  
SHARP 30048, 30848  
SHINTOM 30072  
SHOGUN 30240  
SINGER 30072  
SONIC BLUE 30614, 30616  
SONY 30032, 30033,  
30035, 30636,  
31032, 31972  
STACK 9 31972  
STS 30042  
SYLVANIA 30035, 30043,  
30081, 30593,  
31593  
SYMPHONIC 30593, 31593  
SYSTEMAX 31972  
TAGAR SYSTEMS  
31972  
TATUNG 30041  
TEAC 30041  
TECHNICS 30035, 30162  
TEKNIKA 30035, 30037  
TIVO 30618, 30636,  
30739, 31503  
TMK 30240  
TOSHIBA 30043, 30045,  
30209, 31008,  
31972, 31988  
TOTEVISION 30037, 30240  
TOUCH 31972

UNITECH 30240  
VECTOR 30045  
VECTOR RESEARCH  
30038  
VIDEO CONCEPTS  
30045  
VIDEOMAGIC 30037  
VIDEOSONIC 30240  
VIEWSONIC 31972  
VOODOO 31972  
WARDS 30035, 30042,  
30047, 30048,  
30060, 30072,  
30081, 30149,  
30240  
WHITE WESTINGHOUSE  
30072, 30209  
XR-1000 30035, 30072  
YAMAHA 30038  
ZENITH 30033, 30039,  
30209, 30479,  
31139  
ZT GROUP 31972

---

**DVD PLAYER**

ADCOM 41094  
ADVENT 41016  
AIWA 40641  
AKAI 40899, 41089  
ALCO 40790  
ALLEGRO 40869  
AMPHION MEDIA WORKS  
40872  
AMW 40872  
APEX DIGITAL  
40672, 40717,  
40755, 40794,  
40796, 40797,  
40830, 41004,  
41020, 41061,  
41100  
ASPIRE DIGITAL  
41407  
AUDIOVOX 40790, 41041,  
41071, 41072,  
41121, 41122  
AXION 41071, 41072  
B & K 40655, 40662  
BEL CANTO DESIGN  
41571  
BLAUPUNKT 40717  
BLUE PARADE40571  
BROKSONIC 40695, 40868  
CALIFORNIA AUDIO LABS  
40490  
CINEVISION 40833, 40869,  
40876  
CITIZEN 41277  
COBY 40778, 40852,  
41107, 41177,  
41351  
CURTIS MATHES  
41087  
CYBERHOME 40816, 40874,  
41023, 41024,  
41117  
DAEWOO 40705, 40833,  
40869, 41169,  
41172, 41234,  
41242  
DAYTEK 40872  
DENON 40490  
DESAY 41407  
DISNEY 40675, 41270  
DUAL 41068, 41085  
DURABRAND  
41127  
DVD2000 40521  
EMERSON 40591, 40675,  
40821, 41268  
ENTERPRISE 40591  
FUNAI 40675, 41268  
GATEWAY 41073, 41077

GE 40522, 40717, 40815  
 GO VIDEO 40715, 40741, 40744, 40783, 40833, 40869, 41044, 41075, 41099  
 GO VISION 41071, 41072  
 GOLDSTAR 40741  
 GPX 40699, 40769  
 GRADIENTE 40490  
 GREENHILL 40717  
 GRUNDIG 40539  
 HARMAN/KARDON 40582, 40702  
 HITACHI 40573, 40664, 41247  
 HITEKER 40672  
 INITIAL 40717  
 INTEGRA 40571, 40627  
 JATON 41078  
 JBL 40702  
 JENSEN 41016  
 JSI 41423  
 JVC 40558, 40623, 40867  
 JWIN 41049, 41051  
 KAWASAKI 40790  
 KENWOOD 40490, 40534, 40682, 40737  
 KLH 40717, 40790, 41020, 41149, 41261  
 KONKA 40711  
 KOSS 40651, 41423  
 LANDEL 40826  
 LASONIC 40798, 41173  
 LECSON 41533  
 LENOX 41127  
 LG 40591, 40741, 40801, 40869  
 LOEWE 40511  
 MAGNAVOX 40503, 40539, 40675, 40821  
 MALATA 40782, 41159  
 MARANTZ 40539  
 MCINTOSH 41273, 41533  
 MEMOREX 40695, 41270  
 MICROSOFT 40522  
 MINTEK 40717, 40839  
 MITSUBISHI 40521, 41521  
 MOMITSU 41082  
 MYRYAD 40894  
 NAD 40591, 40692, 40741  
 NAKAMICHI 41222  
 NEC 40785  
 NESA 40717  
 NEXT BASE 40826  
 NORCENT 40872, 41003, 41107, 41265  
 ONKYO 40503, 40627, 40792, 41627  
 ORITRON 40651  
 PANASONIC 40490, 40503, 40632, 40703, 41762  
 PHILIPS 40503, 40539, 40675, 40854, 41260, 41267, 41354  
 PIANODISC 41024  
 PIONEER 40525, 40571, 40632, 41571  
 POLAROID 41020, 41061  
 POLK AUDIO 40539  
 PRIMA 41016  
 PRINCETON 40674  
 PROCEED 40672  
 PROSCAN 40522  
 PROVISION 40778  
 QWESTAR 40651

RCA 40522, 40571, 40717, 40790, 40822, 41022, 41132, 41193  
 RIO 40869  
 RJTECH 41360  
 ROTEL 40623, 41178  
 ROWA 40823  
 SAMPO 40698, 40752  
 SAMSUNG 40490, 40573, 40744, 40820, 40899, 41044, 41075  
 SANSUI 40695  
 SANYO 40695, 40873  
 SHARP 40630, 40675, 40752, 41256  
 SHARPER IMAGE 41117  
 SHERWOOD 40633, 41043, 41077  
 SHINSONIC 40533, 40839  
 SIGMA DESIGNS 40674  
 SONIC BLUE 40869, 41099  
 SONY 40533, 40864, 41017, 41033, 41533  
 SOVA 41122  
 SUNGALE 41074  
 SUPERSCAN 40821  
 SVA 40860, 41105  
 SYLVANIA 40675, 40821, 41268  
 SYMPHONIC 40675, 41268  
 TAG MCLAREN 40894  
 TEAC 40790, 40809  
 TECHNICS 40490, 40703  
 TECHNOSONIC 40730  
 TECHWOOD 40692  
 THETA DIGITAL 40571  
 TOSHIBA 40503, 40695, 41154  
 TREDEX 40799, 40800, 40803, 40804  
 URBAN CONCEPTS 40503  
 US LOGIC 40839  
 VENTURER 40790  
 VIZIO 41064, 41226  
 XBOX 40522  
 YAMAHA 40490, 40539, 40545, 41543  
 YAMAKAWA 40872  
 ZENITH 40503, 40591, 40741, 40869  
 ZOECE 41265

### LD PLAYER

AIWA 40203  
 CARVER 40064, 40194, 40323  
 DENON 40059, 40172  
 DISCO VISION 40023  
 FUNAI 40203  
 HARMAN/KARDON 40194  
 HITACHI 40023  
 MAGNAVOX 40194, 40217  
 MARANTZ 40064, 40194  
 MITSUBISHI 40059  
 NAD 40059  
 OPTIMUS 40059  
 PANASONIC 40204  
 PHILIPS 40064, 40194

PIONEER 40023, 40059  
 POLK AUDIO 40194  
 QUASAR 40204  
 REALISTIC 40203  
 SAMSUNG 40323  
 SEGA 40023  
 SONY 40193, 40201  
 TECHNICS 40204  
 THETA DIGITAL 40194  
 YAMAHA 40217

### DVD RECORDER

APEX DIGITAL 51056  
 ASPIRE DIGITAL 51168  
 COBY 51086  
 CYBERHOME 51129  
 FUNAI 50675, 51334  
 GATEWAY 51073, 51158  
 GO VIDEO 50741, 51158, 51304, 51730  
 ILO 51348  
 JVC 51164, 51275  
 LG 50741  
 LITEON 51158, 51416, 51440  
 MAGNAVOX 50646  
 PANASONIC 50490, 51010, 51011  
 PHILIPS 50646  
 PIONEER 50631, 51475, 51476  
 POLAROID 51086  
 RCA 50522  
 SAMSUNG 50490  
 SENSORY SCIENCE] 51158  
 SHARP 50675, 51550, 51556, 50630  
 SONY 51033, 51069, 51070, 51431  
 SYLVANIA 50675  
 TOSHIBA 51510  
 VICTOR 51275  
 YAMAHA 51544  
 ZENITH 50741

### CD PLAYER

AIWA 60157  
 ARCAM 60157  
 BURMESTER 60420  
 CALIFORNIA AUDIO LABS 60029, 60303  
 CARVER 60157, 60179  
 DENON 60003, 60034  
 DKK 60000  
 DMX ELECTRONICS 60157  
 FISHER 60179  
 GARRARD 60393, 60420  
 GENEXXA 60032  
 HARMAN/KARDON 60157  
 HITACHI 60032  
 INTEGRA 60101  
 JVC 60072  
 KENWOOD 60028, 60190, 60626  
 KLH 61318, 61372, 61711  
 KRELL 60157  
 LINN 60157  
 MAGNAVOX 60038, 60157  
 MARANTZ 60029, 60038, 60157, 60180, 60435, 60626

MCINTOSH 60256, 60290, 60660  
 MCS 60029  
 MIRO 60000  
 MISSION 60157  
 MTC 60420  
 NSM 60157  
 ONKYO 60101, 61327  
 OPTIMUS 60000, 60032, 60087, 60179, 60420, 60468  
 PANASONIC 60029, 60303, 60388, 60752  
 PARASOUND 60420  
 PHILIPS 60157, 60274, 60626  
 PIONEER 60032, 60468, 61062  
 POLK AUDIO 60157  
 PROCEED 60420  
 PROTON 60157  
 QED 60157  
 QUAD 60157  
 QUASAR 60029  
 RCA 60032, 60053, 60179, 60420, 60468, 61062  
 REALISTIC 60179, 60180, 60420  
 ROTEL 60157, 60420  
 SAE 60157  
 SANSUI 60157  
 SANYO 60087, 60179  
 SHARP 60180  
 SHERWOOD 60180  
 SONIC FRONTIERS 60157  
 SONY 60000, 60490  
 SUGDEN 60157  
 TAG MCLAREN 60157  
 TASCAM 60420  
 TEAC 60180, 60378, 60393, 60420  
 TECHNICS 60029, 60303  
 VICTOR 60072  
 WARDS 60053, 60157  
 YAMAHA 60036, 60490, 61907

### CD RECORDER

HARMAN/KARDON 71202  
 JVC 71294  
 KENWOOD 70626  
 KLH 71373  
 LG 71208  
 MARANTZ 70626  
 PHILIPS 70626  
 PIONEER 71062, 71087  
 RCA 70053, 70420  
 SONY 70000, 70100, 71364  
 TDK 71208  
 TEAC 70420  
 YAMAHA 70888, 71292

### MD RECORDER

DENON 70873  
 KENWOOD 70681, 70826  
 ONKYO 70868  
 OPTIMUS 71063  
 PIONEER 71063  
 SHARP 70861  
 SHERWOOD 71067  
 SONY 70490  
 YAMAHA 70490, 70888, 71909

---

**TAPE DECK**

AIWA 70029, 70197  
CARVER 70029  
DENON 70076  
HARMAN/KARDON 70029, 70182  
JVC 70244, 70273  
KENWOOD 70070  
MAGNAVOX 70029  
MARANTZ 70029  
ONKYO 70135, 70282  
OPTIMUS 70027, 70220  
PANASONIC 70229  
PHILIPS 70029  
PIONEER 70027, 70099, 70220  
POLK AUDIO 70029  
RCA 70027, 70220  
SANSUI 70029  
SONY 70170, 70243, 70291  
TECHNICS 70229  
VICTOR 70273  
WARDS 70027  
YAMAHA 70094, 70097, 70524

---

**TUNER**

ADC 80531  
ADCOM 80616, 81616, 81617  
AIWA 80121, 80158, 80189, 81405  
AMC 81077  
AMPLIFIER TECHNOLOGIES 81584  
ANAM 81074, 81609  
ARCAM 81189  
ATLANTIC TECHNOLOGY 81487

**AUDIOTRONIC**

81189  
AUDIOVOX 81627  
B & K 80701, 80820, 80840  
BEL CANTO DESIGN 81584  
BK 80702  
BOSE 81933  
BOSTON ACOUSTICS 81918  
BRIX 81602  
CAPETRONIC 80531  
CARVER 80008, 80121, 80189, 80360, 81189  
CLASSE 81916  
DELPHI 81414  
DENON 80121, 81360  
EMERSON 80424  
FISHER 80219, 80360  
FOSGATE 81487  
GARRARD 80424  
GATEWAY 81567  
HARMAN/KARDON 80110, 80189, 80891, 81304  
INTEGRA 80135, 81320  
JBL 80110  
JVC 80074, 81058, 81811

KENWOOD 80027, 80077, 81313, 81569, 81570  
KLH 81428  
KOSS 80424  
LEXICON 81076  
LINN 80189  
MAGNAVOX 80189, 80531, 81189, 81269  
MARANTZ 80039, 80189, 80200, 81189, 81269  
MCS 80039, 80346  
MICROMEGA 81189

MITSUBISHI 81393  
MYRYAD 81189, 81918  
NAD 80320  
NAKAMICHI 80347, 81313, 81555, 81919  
NIRO 81908  
ONKYO 80135, 81320  
OPTIMUS 80177, 80219, 80531, 80670, 81023, 81074  
OUTLAW 81487  
OUTLAW AUDIO 81487  
PANASONIC 80039, 80309, 81308, 81518  
PHILIPS 80189, 81189, 81269  
PIONEER 80014, 80150, 80531, 80630, 81023

POLK AUDIO 80189, 81414  
QUASAR 80039  
RCA 80054, 80346, 80360, 80531, 81023, 81074, 81154, 81609  
REALISTIC 80163  
SAMSUNG 81304  
SANSUI 80189, 80346, 81189  
SANYO 80219  
SCOTT 80163, 80322  
SHERWOOD 81077, 81423, 81567, 81918  
SIRIUS 81602, 81627, 81811  
SONY 80158, 81058, 81406, 81759  
SOUNDESIGN 80670  
STEREOPHONICS 81023  
SUNFIRE 81313  
TEAC 80163, 81074  
TECHNICS 80039, 80309, 81308, 81518

THORENS 81189  
TOSHIBA 80135  
VICTOR 80074  
WARDS 80014, 80054, 80158, 80189  
XM 81406, 81414  
YAMAHA 80176, 81176, 81276, 81331, 81375, 81908  
(TUNER ID1) 81916  
(TUNER ID2) 81917  
(XM ID1) 81918  
(XM ID2) 81919

---

**OTHER AUDIO ACCESSORIES**

YAMAHA (iPod) 81981  
YAMAHA (NET/USB) 81982



© 2006 YAMAHA CORPORATION All rights reserved.

YAMAHA ELECTRONICS CORPORATION, USA 6660 ORANGETHORPE AVE., BUENA PARK, CALIF. 90620, U.S.A.  
YAMAHA CANADA MUSIC LTD. 135 MILNER AVE., SCARBOROUGH, ONTARIO M1S 3R1, CANADA  
YAMAHA ELECTRONIK EUROPA G.m.b.H. SIEMENSSTR. 22-34, 25462 RELLINGEN BEI HAMBURG, GERMANY  
YAMAHA ELECTRONIQUE FRANCE S.A. RUE AMBROISE CROIZAT BP70 CROISSY-BEAUBOURG 77312 MARNE-LA-VALLEE CEDEX02, FRANCE  
YAMAHA ELECTRONICS (UK) LTD. YAMAHA HOUSE, 200 RICKMANSWORTH ROAD WATFORD, HERTS WD18 7GQ, ENGLAND  
YAMAHA SCANDINAVIA A.B. J A WETTERGRENS GATA 1, BOX 30053, 400 43 VÄSTRA FRÖLUNDA, SWEDEN  
YAMAHA MUSIC AUSTRALIA PTY, LTD. 17-33 MARKET ST., SOUTH MELBOURNE, 3205 VIC., AUSTRALIA

YAMAHA CORPORATION  
Printed in Malaysia ◀ WG73890-1