

MOOSE MOOSE

OWNER'S MANUAL

MUSIC PRODUCTION SYNTHESIZER

MOOSE
MOOSE

SPECIAL MESSAGE SECTION

This product utilizes batteries or an external power supply (adapter). DO NOT connect this product to any power supply or adapter other than one described in the manual, on the name plate, or specifically recommended by Yamaha.

WARNING: Do not place this product in a position where anyone could walk on, trip over, or roll anything over power or connecting cords of any kind. The use of an extension cord is not recommended! If you must use an extension cord, the minimum wire size for a 25' cord (or less) is 18 AWG. NOTE: The smaller the AWG number, the larger the current handling capacity. For longer extension cords, consult a local electrician.

This product should be used only with the components supplied or; a cart, rack, or stand that is recommended by Yamaha. If a cart, etc., is used, please observe all safety markings and instructions that accompany the accessory product.

SPECIFICATIONS SUBJECT TO CHANGE:

The information contained in this manual is believed to be correct at the time of printing. However, Yamaha reserves the right to change or modify any of the specifications without notice or obligation to update existing units.

This product, either alone or in combination with an amplifier and headphones or speaker/s, may be capable of producing sound levels that could cause permanent hearing loss. DO NOT operate for long periods of time at a high volume level or at a level that is uncomfortable. If you experience any hearing loss or ringing in the ears, you should consult an audiologist.

IMPORTANT: The louder the sound, the shorter the time period before damage occurs.

Some Yamaha products may have benches and / or accessory mounting fixtures that are either supplied with the product or as optional accessories. Some of these items are designed to be dealer assembled or installed. Please make sure that benches are stable and any optional fixtures (where applicable) are well secured BEFORE using. Benches supplied by Yamaha are designed for seating only. No other uses are recommended.

NOTICE:

Service charges incurred due to a lack of knowledge relating to how a function or effect works (when the unit is operating as designed) are not covered by the manufacturer's warranty, and are therefore the owners responsibility. Please study this manual carefully and consult your dealer before requesting service.

ENVIRONMENTAL ISSUES:

Yamaha strives to produce products that are both user safe and environmentally friendly. We sincerely believe that our products and the production methods used to produce them, meet these goals. In keeping with both the letter and the spirit of the law, we want you to be aware of the following:

Battery Notice:

This product MAY contain a small non-rechargeable battery which (if applicable) is soldered in place. The average life span of this type of battery is approximately five years. When replacement becomes necessary, contact a qualified service representative to perform the replacement.

This product may also use "household" type batteries. Some of these may be rechargeable. Make sure that the battery being charged is a rechargeable type and that the charger is intended for the battery being charged.

When installing batteries, do not mix batteries with new, or with batteries of a different type. Batteries MUST be installed correctly. Mismatches or incorrect installation may result in overheating and battery case rupture.

Warning:

Do not attempt to disassemble, or incinerate any battery. Keep all batteries away from children. Dispose of used batteries promptly and as regulated by the laws in your area. Note: Check with any retailer of household type batteries in your area for battery disposal information.

Disposal Notice:

Should this product become damaged beyond repair, or for some reason its useful life is considered to be at an end, please observe all local, state, and federal regulations that relate to the disposal of products that contain lead, batteries, plastics, etc. If your dealer is unable to assist you, please contact Yamaha directly.

NAME PLATE LOCATION:

The name plate is located on the rear (MO8) or bottom (MO6) of the product. The model number, serial number, power requirements, etc., are located on this plate. You should record the model number, serial number, and the date of purchase in the spaces provided below and retain this manual as a permanent record of your purchase.

MO8

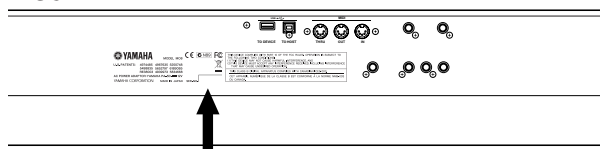

MO6

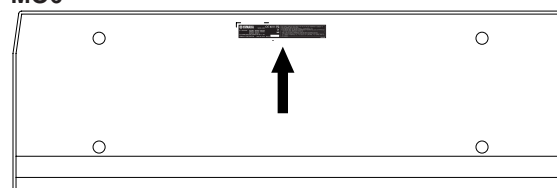

Model _____

Serial No. _____

Purchase Date _____

PLEASE KEEP THIS MANUAL

FCC INFORMATION (U.S.A.)

1. IMPORTANT NOTICE: DO NOT MODIFY THIS UNIT!

This product, when installed as indicated in the instructions contained in this manual, meets FCC requirements. Modifications not expressly approved by Yamaha may void your authority, granted by the FCC, to use the product.

2. IMPORTANT:

When connecting this product to accessories and/or another product use only high quality shielded cables. Cable/s supplied with this product MUST be used. Follow all installation instructions. Failure to follow instructions could void your FCC authorization to use this product in the USA.

3. NOTE:

This product has been tested and found to comply with the requirements listed in FCC Regulations, Part 15 for Class "B" digital devices. Compliance with these requirements provides a reasonable level of assurance that your use of this product in a residential environment will not result in harmful interference with other electronic devices. This equipment generates/uses radio frequencies and, if not installed and used according to the instructions found in the users manual, may cause interference harmful to the operation of other electronic devices. Compliance with FCC regulations does

not guarantee that interference will not occur in all installations. If this product is found to be the source of interference, which can be determined by turning the unit "OFF" and "ON", please try to eliminate the problem by using one of the following measures:

Relocate either this product or the device that is being affected by the interference.

Utilize power outlets that are on different branch (circuit breaker or fuse) circuits or install AC line filter/s.

In the case of radio or TV interference, relocate/reorient the antenna. If the antenna lead-in is 300 ohm ribbon lead, change the lead-in to co-axial type cable.

If these corrective measures do not produce satisfactory results, please contact the local retailer authorized to distribute this type of product. If you can not locate the appropriate retailer, please contact Yamaha Corporation of America, Electronic Service Division, 6600 Orangethorpe Ave, Buena Park, CA90620

The above statements apply ONLY to those products distributed by Yamaha Corporation of America or its subsidiaries.

* This applies only to products distributed by YAMAHA CORPORATION OF AMERICA.

(class B)

COMPLIANCE INFORMATION STATEMENT (DECLARATION OF CONFORMITY PROCEDURE)

Responsible Party : Yamaha Corporation of America
Address : 6600 Orangethorpe Ave., Buena Park, Calif. 90620
Telephone : 714-522-9011
Type of Equipment : MUSIC PRODUCTION SYNTHESIZER
Model Name : MO6, MO8

This device complies with Part 15 of the FCC Rules.

Operation is subject to the following conditions:

- 1) this device may not cause harmful interference, and
- 2) this device must accept any interference received including interference that may cause undesired operation.

See user manual instructions if interference to radio reception is suspected.

* This applies only to products distributed by
YAMAHA CORPORATION OF AMERICA.

(FCC DoC)

OBSERVERA!

Apparaten kopplas inte ur växelströmskällan (nätet) så länge som den är ansluten till vägguttaget, även om själva apparaten har stängts av.

ADVARSEL: Netspændingen til dette apparat er IKKE afbrudt, så længe netledningen sidder i en stikkontakt, som er tændt — også selvom der er slukket på apparatets afbryder.

VAROITUS: Laitteen toisiopiiriin kytketty käyttökytkin ei irroita koko laitetta verkosta.

(standby)

PRECAUTIONS

PLEASE READ CAREFULLY BEFORE PROCEEDING

* Please keep this manual in a safe place for future reference.



WARNING

Always follow the basic precautions listed below to avoid the possibility of serious injury or even death from electrical shock, short-circuiting, damages, fire or other hazards. These precautions include, but are not limited to, the following:

Power supply/AC power adaptor

- Only use the voltage specified as correct for the instrument. The required voltage is printed on the name plate of the instrument.
- Use the specified adaptor (PA-5D or an equivalent recommended by Yamaha) only. Using the wrong adaptor can result in damage to the instrument or overheating.
- Check the electric plug periodically and remove any dirt or dust which may have accumulated on it.
- Do not place the AC adaptor cord near heat sources such as heaters or radiators, and do not excessively bend or otherwise damage the cord, place heavy objects on it, or place it in a position where anyone could walk on, trip over, or roll anything over it.

Do not open

- Do not open the instrument or attempt to disassemble the internal parts or modify them in any way. The instrument contains no user-serviceable parts. If it should appear to be malfunctioning, discontinue use immediately and have it inspected by qualified Yamaha service personnel.

Water warning

- Do not expose the instrument to rain, use it near water or in damp or wet conditions, or place containers on it containing liquids which might spill into any openings.
- Never insert or remove an electric plug with wet hands.

Fire warning

- Do not put burning items, such as candles, on the unit. A burning item may fall over and cause a fire.

If you notice any abnormality

- If the AC adaptor cord or plug becomes frayed or damaged, or if there is a sudden loss of sound during use of the instrument, or if any unusual smells or smoke should appear to be caused by it, immediately turn off the power switch, disconnect the adaptor plug from the outlet, and have the instrument inspected by qualified Yamaha service personnel.



CAUTION

Always follow the basic precautions listed below to avoid the possibility of physical injury to you or others, or damage to the instrument or other property. These precautions include, but are not limited to, the following:

Power supply/AC power adaptor

- When removing the electric plug from the instrument or an outlet, always hold the plug itself and not the cord.
- Unplug the AC power adaptor when not using the instrument, or during electrical storms.
- Do not connect the instrument to an electrical outlet using a multiple-connector. Doing so can result in lower sound quality, or possibly cause overheating in the outlet.

Location

- Do not expose the instrument to excessive dust or vibrations, or extreme cold or heat (such as in direct sunlight, near a heater, or in a car during the day) to prevent the possibility of panel disfiguration or damage to the internal components.
- Do not use the instrument in the vicinity of a TV, radio, stereo equipment, mobile phone, or other electric devices. Otherwise, the instrument, TV, or radio may generate noise.
- Do not place the instrument in an unstable position where it might accidentally fall over.
- Before moving the instrument, remove all connected adaptor and other cables.
- When setting up the instrument, make sure that the AC outlet you are using is easily accessible. If some trouble or malfunction occurs, immediately turn off the power switch and disconnect the plug from the outlet.

Connections

- Before connecting the instrument to other electronic components, turn off the power for all components. Before turning the power on or off for all components, set all volume levels to minimum. Also, be sure to set the volumes of all components at their minimum levels and gradually raise the volume controls while playing the instrument to set the desired listening level.

Maintenance

- When cleaning the instrument, use a soft, dry cloth. Do not use paint thinners, solvents, cleaning fluids, or chemical-impregnated wiping cloths.

Handling caution

- Do not insert a finger or hand in any gaps on the instrument.
- Never insert or drop paper, metallic, or other objects into the gaps on the panel or keyboard. If this happens, turn off the power immediately and unplug the power cord from the AC outlet. Then have the instrument inspected by qualified Yamaha service personnel.
- Do not place vinyl, plastic or rubber objects on the instrument, since this might discolor the panel or keyboard.
- Do not rest your weight on, or place heavy objects on the instrument, and do not use excessive force on the buttons, switches or connectors.
- Do not operate the instrument for a long period of time at a high or uncomfortable volume level, since this can cause permanent hearing loss. If you experience any hearing loss or ringing in the ears, consult a physician.

Saving data

Saving and backing up your data

- DRAM data (see page 150) is lost when you turn off the power to the instrument. Save the data to a USB storage device.
- Never attempt to turn off the power while data is being written to Flash ROM (while an “Executing...” or “Please keep power on” message is shown). Turning the power off in this state results in loss of all user data and may cause the system to freeze (due to corruption of data in the Flash ROM). This means that this synthesizer may not be able to start up properly, even when turning the power on next time.

Backing up the USB storage device

- To protect against data loss through media damage, we recommend that you save your important data onto two USB storage devices.

Yamaha cannot be held responsible for damage caused by improper use or modifications to the instrument, or data that is lost or destroyed.

Always turn the power off when the instrument is not in use.

Even when the power switch is in the “STANDBY” position, electricity is still flowing to the instrument at the minimum level. When you are not using the instrument for a long time, make sure you unplug the AC power adaptor from the wall AC outlet.

Introduction

Congratulations and thank you for your purchase of the Yamaha MO Music Production Synthesizer!

You now own a fantastic-sounding, highly versatile keyboard—one that combines comprehensive synthesizer sound-crafting controls and powerful performance/recording features in a total music production instrument.

Virtually all of our synthesizer technology and music making know-how went into the design of this instrument. The new MO not only gives you the latest and greatest sounds and rhythms (as well as the ability to create your own), it gives you powerful, easy-to-use tools for playing, combining and controlling these dynamic sounds/rhythms—in real time, as you perform!

Take time to look through this manual carefully. It's packed with important information on how to get the most from this amazing instrument.

Dive in now and enjoy!

Accessories

The following items have been included with your MO. Check to see that you have everything listed here.

- Power adaptor (PA-5D)*
- Owner's Manual (this document)
- Data List

* May not be included in your area. Please check with your Yamaha dealer.

The illustrations and LCD screens as shown in this owner's manual are for instructional purposes only, and may appear somewhat different from those on your instrument.

This product incorporates and bundles computer programs and contents in which Yamaha owns copyrights or with respect to which it has license to use others' copyrights. Such copyrighted materials include, without limitation, all computer software, style files, MIDI files, WAVE data, musical scores and sound recordings. Any unauthorized use of such programs and contents outside of personal use is not permitted under relevant laws. Any violation of copyright has legal consequences. **DON'T MAKE, DISTRIBUTE OR USE ILLEGAL COPIES.**

This device is capable of using various types/formats of music data, and it optimizes the data in advance to the proper format for use with the device. As a result, the data may not be played back precisely as the creators or composers originally intended.

Copying of the commercially available musical data including but not limited to MIDI data and/or audio data is strictly prohibited except for your personal use.

- Windows is the registered trademarks of Microsoft® Corporation.
- Apple and Macintosh are trademarks of Apple Computer, Inc., registered in the U.S. and other countries.
- The company names and product names in this Owner's Manual are the trademarks or registered trademarks of their respective companies.

Main Features

- Wide range of **dynamic and authentic voices**. Use the **Category Search** function to quickly call up the sounds you want, based on their instrument type. **Page 42**
- **Performance mode** lets you use four different voices together—in layers or in a keyboard split. **Page 44**
- Extensive **effect processing**, with Reverb (20 types), Chorus (49 types), three separate Insertion blocks **each of which has two blocks** (total 116 types), Master Effect (8 types), and a digital equalizer (3-band Part EQ and 5-band Master EQ). **Page 140**
- Comprehensive **real-time control with four knobs and four sliders**—letting you adjust filter, levels, effects, EG, and more, while you play. **Page 51**
- **Pattern mode** functions let you craft different rhythmic sections and riffs as individual elements—which you can easily and intuitively combine in real time to create full rhythm tracks. **Page 73**
- In addition to being able to create User voices in the Voice mode, you can create special **Mixing voices** for Songs and Patterns. These voices can be edited and stored in the Song/Pattern mode, making it exceptionally easy and convenient to create voices for use with Songs and Patterns. **Page 78**
- The versatile **Arpeggio** feature automatically plays a variety of sequenced phrases in response to the keys you play. This function is especially powerful with drum voices—letting you easily call up various rhythm patterns at the touch of a key, and providing instant inspiration for song creation and performance. When used with normal voices, the Arpeggio phrase changes harmonically and melodically with the chords you play, giving you intuitive control over the patterns as you compose or perform. Arpeggios can be triggered not only according to the keys you play, but also by how strongly you play them—for even greater performance power. **Page 48**
- Once you've collected all the MIDI data and patterns you need for your song, use **Pattern Chain** to arrange the pieces in real time. This hands-on approach makes it easier than ever to come up with great ideas and amazing songs. **Page 84**
- **Song Scene** is another powerful tool that lets you take “snapshots” of the sequencer track settings (such as pan, volume, track mute and so on). Then, during playback or recording, simply switch among the Scenes for instant, dynamic changes. **Page 89**
- **Master mode**—for using the MO as a master keyboard controller (with independent Zones), and for easily reconfiguring the instrument between Voice/Performance play and Song/Pattern play in live applications. **Page 122**
- Exceptionally **easy-to-understand interface** with two-tiered operation buttons: [F1] – [F6] and [SF1] – [SF5] **Page 33**
- **Remote Control**—for operating your favorite sequencing software from the panel controls. Mute tracks, control transport (Play, Stop, Record, etc.), mix both MIDI and audio tracks (up to 16) with this instrument's knobs and sliders, pan the tracks, control EQ, and tweak effect sends—all without ever touching the mouse. **Page 113**
- The digital output jacks (DIGITAL) ensure completely noise-free, distortion-free sound output (44.1kHz, 24 bit). **Page 103**
- The instrument features **two USB connectors**—USB TO HOST for connecting to computer, and USB TO DEVICE for connecting to storage devices, such as a hard disk drive or flash disk. **Page 31**
- Compatibility with Yamaha's powerful **Voice Editor and Multi Part Editor software**—featuring comprehensive, intuitive editing of all parameters from your computer. **Page 112**

How to use this manual

Application Index Page 9

This special index is organized not by single words, but by functions and applications—allowing you to quickly and easily find how to perform a particular operation or explore a topic of interest.

The Controls & Connectors Page 14

Use this section to find out about all of the buttons, controls and connectors of this instrument.

Setting Up and Playing Page 20

Before going on to any other part of the manual, we strongly suggest you read this section first. It shows you how to get started playing and using your new instrument.

Basic Operation..... Page 27

This section introduces you to the basic operating conventions of this instrument, such as editing values and changing settings.

Quick Guide Page 40

In this tutorial section, you will take a guided tour through the various functions of this instrument, and get some hands-on experience in playing and using it.

Basic Structure Page 128

This section provides a detailed overview of all of the main functions and features of this instrument, and shows how they fit together.

Reference Page 151

The MO encyclopedia. This section explains all parameters, settings, functions, features, modes and operations in full detail.

Appendix Page 219

This section contains detailed information on the instrument, including the Specifications and an Alert Message List.

Troubleshooting..... Page 227

If this instrument does not function as expected or you have some problem with the sound or operation, refer to this section before calling your Yamaha dealer or service center. Most common problems and their solutions are covered here in a very simple and easy-to-understand way.

Data List (separate booklet)

This contains various important lists such as the Voice List, Preset Pattern Phrase List, Effect List, MIDI Data Format, and MIDI Implementation Chart.

Throughout this manual, arrows are used in the instructions, indicating in shorthand the process of calling up certain displays and functions. The example instructions below indicate to 1) press the [VOICE] button, 2) select a Normal Voice, 3) press the [EDIT] button, 4) select an Element, 5) press the [F1] OSC button, and 6) press the [SF2] OUTPUT button.

[VOICE] → Normal Voice selection → [EDIT] → Element selection → [F1] OSC → [SF2] OUTPUT

NOTE When a confirmation message (page 37) or Control Function window (page 51) is shown in the display, press the [EXIT] button to exit from that condition, then execute the instructions as in the above example. Likewise, press the [DAW REMOTE] button to exit from the Remote Control mode, then execute the instructions as in the above example when the MO is in the Remote Control mode.

Application Index

Listening to the MO

- **Listening to the Demo Song/Pattern** Page 73
- **Listening to Song Chain playback** Page 95
- **Listening to Pattern Chain playback** Page 84
- **Listening to Arpeggio playback** Page 48

Playing the keyboard

- **Selecting a Voice and playing the keyboard** Pages 40 (Voice mode), 76 (Song/Pattern mode)
- **Selecting a Performance and playing the keyboard** Page 44
- **Using the instrument as a Master Keyboard** Page 122
- **Sounding the metronome** [SONG] or [PATTERN] → [UTILITY] → [F3] SEQ → [SF1] CLICK → Mode = all Page 206
- **Splitting the keyboard—Setting upper and lower ranges for the Voices** Pages 47 (Performance mode), 125 (Master mode)
- **Layering two Voices (or Parts) together** Pages 46 (Performance mode), 125 (Master mode)

Selecting programs and making settings on the MO

- **Selecting a Voice** Pages 40 (Voice mode), 76 (Song/Pattern mode)
- Using the Category Search function Page 42
- **Selecting a Performance** Page 44
- **Selecting a Song** Page 74
- **Selecting a Pattern** Page 75
- Selecting a Section Page 75
- Selecting a Phrase and assigning it to a Pattern track Page 78
- **Selecting a Mixing template for a Song/Pattern** Page 77
- **Selecting a Master** Page 122
- **Selecting an Arpeggio type** Pages 48 (Voice/Performance mode), 80 (Song/Pattern mode)
- **Selecting a Filter type** Page 170
- **Selecting an Effect type**
 - **Selecting a Reverb type/Chorus type/Insertion type**
 - [VOICE] → Voice selection → [F3] EFFECT Page 151
 - [PERFORM] → Performance selection → [F3] EFFECT → [SF1] CONNECT Page 171
 - [SONG] or [PATTERN] → Song/Pattern selection → [MIXING] → [F3] EFFECT → [SF1] CONNECT Page 189
 - **Selecting a Master Effect type**
 - [VOICE] → [UTILITY] → [F3] VOICE → [SF2] MEF Page 206
 - [PERFORM] → Performance selection → [EDIT] → [COMMON] → [F2] OUT/MEF → [SF3] MEF Page 172
 - [SONG] or [PATTERN] → Song/Pattern selection → [MIXING] → [EDIT] → [COMMON] → [F2] MEQ/MEF → [SF2] MEF Page 190
 - **Selecting a Master EQ type**
 - [VOICE] → [UTILITY] → [F3] VOICE → [SF1] MEQ Page 206
 - [PERFORM] → Performance selection → [EDIT] → [COMMON] → [F2] OUT/MEF → [SF2] MEQ Page 172
 - [SONG] or [PATTERN] → Song/Pattern selection → [MIXING] → [EDIT] → [COMMON] → [F2] OUT/MEF → [SF1] MEQ Page 190

Using controllers

- **Understanding the organization and structure of the controllers** Pages 50, 69
- **Assigning functions to the controllers for each Voice (Controller Set)** Page 70
- **Assigning Control Change numbers to each controller** Page 72
- **Setting the Pitch Bend Range**
 - [VOICE] → Voice selection → [EDIT] → [COMMON] → [F1] GENERAL → [SF5] OTHER → PB Upper/PB Lower Page 154
 - [SONG] or [PATTERN] → Song/Pattern selection → [MIXING] → [EDIT] → Part selection → [F1] VOICE → [SF5] OTHER → PB Upper/PB Lower Page 191
- **Checking the currently assigned parameters for knob control** Pages 56 (Voice mode), 65 (Performance mode), 96 (Song/Pattern mode)
- **Checking the currently assigned parameters for Control sliders control** Page 52
- **Starting/stopping a Song or Pattern by pressing a Footswitch** [UTILITY] → [F4] CTL ASN → [SF3] FT SW Page 209
- **Changing a Voice or a Performance by pressing a Footswitch** [UTILITY] → [F4] CTL ASN → [SF3] FT SW Page 209
- **Turning Arpeggio playback on or off by pressing a Footswitch** [UTILITY] → [F4] CTL ASN → [SF3] FT SW Page 209
- **Keeping the effect of a controller (Modulation Wheel, etc.) the same, even when changing Voices**
 - [UTILITY] → [F1] GENERAL → [SF4] OTHER → CtrlReset = hold Page 206

Sounding only the specified Part or Voice

- Turning each element on or off in the Voice Edit modePage 55
- Determining whether each Element is used or not in the Voice Edit mode
[VOICE] → [EDIT] → Element selection → [F1] OSC → [SF1] WAVE → ElementSw = on/offPage 158
- Determining whether each Part is used or not in the Performance mode
[PERFORM] → Performance selection → [EDIT] → Part selection → [F1] VOICE → [SF1] VOICE → PartSw = on/offPage 174
- Turning each track (Part) of a Song/Pattern on or offPage 75
- Turning off or muting playback of a Song/Pattern Part, by setting the receive channel to off
[SONG] or [PATTERN] → Song/Pattern selection → [MIXING] → [EDIT] → part selection → [F1] VOICE → [SF2] MODE → ReceiveChPage 191

Adjusting the volume or output level

- Overall
 - Adjusting the Master Volume output [MASTER VOLUME]Page 16
 - Adjusting the entire volume of the instrument's internal tone generator block.... [UTILITY] → [F1] GENERAL → [SF1] TG → VolumePage 205
 - Adjusting the output gain of each Output connector [UTILITY] → [F2] OUTPUTPage 206
- In the Voice mode
 - Adjusting the volume balance of the Elements of a Normal Voice with the Control sliders
[VOICE] → Normal Voice selection → [EDIT] → Element selection → [F4] AMP → [SF1] LVL/PAN → LevelPage 56
 - Adjusting the entire volume for the selected Voice (common to all Elements/keys)
[VOICE] → Voice selection → [EDIT] → [COMMON] → [F2] OUTPUT → VolumePage 154
- In the Performance mode
 - Adjusting the volume balance of the Parts of an edited Performance with the Control sliders
[PERFORM] → Performance selection → [EDIT] → Part selection → [F2] OUTPUT → [SF1] VOL/PAN → VolumePage 65
 - Adjusting the entire volume for the selected Performance (common to all Parts)
[PERFORM] → Performance selection → [EDIT] → [COMMON] → [F2] OUT/MEQ → [SF1] OUT → VolumePage 172
- In the Song mode/Pattern mode
 - Adjusting the volume balance of the Parts of an edited Song with the Control sliders
[SONG] or [PATTERN] → Song/Pattern selection → [MIXING] → Part Selection → [F1] VOL/PAN → VOLUMEPage 97

Creating Data

- Creating a Voice
 - Creating a Normal Voice in the Voice Edit modePage 53
 - Creating a Drum Voice in the Voice Edit modePage 57
 - Creating a Mixing Voice especially for a Song or PatternPage 78
- Creating a PerformancePage 63
- Creating a Song
 - Recording your keyboard performance to a Song track (Realtime Recording)Page 88
 - Recording over (replacing) existing material in a Song track—Punch-in Recording
[SONG] → [REC] → [F1] SETUP → Type = punchPage 88
 - Recording additional material to an existing Song track (without erasing previous material)—Overdub Recording
[SONG] → [REC] → [F1] SETUP → Type = overdubPage 80
 - Sounding the metronome during recording [SONG] → [UTILITY] → [F3] SEQ → [SF1] CLICK → Mode = recPage 206
 - Recording a Song by using a PerformancePage 89
 - Using the Step Recording function [SONG] → [REC] → [F1] SETUP → Type = stepPage 80
 - Editing MIDI events for each track of an already-recorded Song [SONG] → [EDIT] → Track selectionPage 90
 - Inserting Tempo change information in the middle of the Song [SONG] → [EDIT] → [F4] TR SELPage 88
 - Inserting Voice change information
[SONG] → [EDIT] → Track selection → Inserting a Bank Select MSB/LSB and Program ChangePage 182
 - Editing Song Mixing settings, such as the volume of each Part [SONG] → [MIXING]Page 93
 - Using convenient “Jobs,” such as Copy, Clear, Quantize [SONG] → [JOB] → Job selectionPage 91
- Creating a Pattern
 - Assigning a Preset Phrase to each track of a Pattern (Patch function)Page 78
 - Recording your keyboard performance to a Pattern track to create a PhrasePage 82
 - Recording a newly found Arpeggio rhythm pattern to a Pattern trackPage 80
 - Sounding the metronome during recording [PATTERN] → [UTILITY] → [F3] SEQ → [SF1] CLICK → Mode = recPage 206
 - Using the Step Recording function [PATTERN] → [REC] → [F1] SETUP → Type = stepPage 83
 - Editing MIDI events for each track of an already-recorded Pattern [PATTERN] → [EDIT] → Track selectionPage 90
 - Editing Pattern Mixing settings, such as the volume of each Part [PATTERN] → [MIXING]Page 93
 - Using convenient “Jobs,” such as Copy, Clear, Quantize [PATTERN] → [JOB] → Job selectionPage 91
 - Programming a sequence of a Section to create a Pattern Chain [PATTERN] → [F6] CHAINPage 85
 - Converting a Pattern Chain to Song data [PATTERN] → Pattern selection → [F6] CHAIN → [EDIT] → [F3] SONGPage 86
- Creating a MasterPage 122
- Creating an ArpeggioPage 97

Storing/Saving the created data

- Storing an edited Voice to internal memory (Flash ROM) and saving all the Voices in internal memory to a USB storage device Page 60
- Storing an edited Performance to internal memory (Flash ROM) and saving all the Performances in internal memory to a USB storage device Page 66
- Saving the Song/Pattern data
 - Storing Song Mixing/Pattern Mixing settings to internal memory (DRAM)Pages 77, 94
 - Storing the entire Song/Pattern data to a USB storage device..... Page 98
- Storing Mixing settings to internal memory (Flash ROM) as a template Page 94
- Storing an edited Master to internal memory (Flash ROM) and saving all the Masters on internal memory to a USB storage device Page 123
- Saving all Arpeggios in internal memory (Flash ROM) to a USB storage device Page 214

Naming your created data Page 38

Recovering lost data

- Comparing the Voice, Performance, Song, or Pattern before editing with the just-edited one (Compare function) Page 36
- Recalling an edited, but not-stored Voice, Performance, Song or Pattern (when another Voice has been selected)
 - Recall function Page 37
- Song/Pattern
 - Canceling the changes made in the recent session such as Recording and Job to restore the data to its previous status
 - [SONG] or [PATTERN] → [JOB] → [F1] UNDO Page 93

Initializing

- Resetting the User Memory to the Initial Factory Settings Page 26
- Formatting a USB storage device Page 213
- Initializing the edited Voice [VOICE] → [JOB] → [F1] INIT Page 168
- Initializing the edited Performance [PERFORM] → [JOB] → [F1] INIT Page 177
- Initializing the edited Master [MASTER] → [JOB] → [F1] INIT Page 218
- Initializing the edited Song Mixing settings [SONG] → [MIXING] → [JOB] → [F1] INIT Page 192
- Initializing the edited Pattern Mixing settings [PATTERN] → [MIXING] → [JOB] → [F1] INIT Page 202

Pitch related settings (Tune, Note Shift, etc.)

- Overall
 - Changing the octave setting of the keyboard [UTILITY] → [F1] GENERAL → [SF2] KBD → Octave Page 29
 - Shifting the note up or down on the keyboard [UTILITY] → [F1] GENERAL → [SF2] KBD → Transpose Page 29
 - Shifting the note up or down in the tone generator block [UTILITY] → [F1] GENERAL → [SF1] TG → NoteShift Page 205
 - Adjusting the tuning to other instruments [UTILITY] → [F1] GENERAL → [SF1] TG → Tune Page 205
- In the Voice mode
 - Setting the tuning system for the voice
 - [VOICE] → Voice selection → [EDIT] → [COMMON] → [F1] GENERAL → [SF2] PLY MODE → M.TuningNo. Page 169
 - Adjusting the pitch for each Element of the edited Voice in semitones
 - [VOICE] → Voice selection → [EDIT] → Element selection → [F2] PITCH → [SF1] TUNE → Coarse Page 159
 - Finely adjusting the pitch for each Element of the edited Voice
 - [VOICE] → Voice selection → [EDIT] → Element selection → [F2] PITCH → [SF1] TUNE → Fine Page 159
 - Setting the all notes (keys) to the same pitch
 - [VOICE] → Voice selection → [EDIT] → Element selection → [F2] PITCH → [SF4] KEY FLW → PitchSens = 0 Page 159
- In the Performance mode
 - Shifting the note up or down for each Part of the edited Performance
 - [PERFORM] → Performance selection → [EDIT] → Part selection → [F4] TONE → [SF1] TUNE → NoteShift Page 176
 - Finely adjusting the pitch for each Part of the edited Performance
 - [PERFORM] → Performance selection → [EDIT] → Part selection → [F4] TONE → [SF1] TUNE → Detune Page 176
- In the Song mode/Pattern mode
 - Shifting the note up or down for each Part of the current Song/Pattern
 - [SONG] or [PATTERN] → Song/Pattern selection → [MIXING] → [EDIT] → Part selection → [F4] TONE → [SF1] TUNE → NoteShift Page 191
 - Finely adjusting the pitch for each Part of the current Song/Pattern
 - [SONG] or [PATTERN] → Song/Pattern selection → [MIXING] → [EDIT] → Part selection → [F4] TONE → [SF1] TUNE → Detune Page 191
- In the Master mode
 - Shifting the keyboard octave up or down for each zone of the edited Master
 - [MASTER] → Master selection → [F2] MEMORY → ZoneSwitch = on → [EDIT] → Zone selection → [F2] NOTE → Octave Page 216
 - Finely adjusting the keyboard pitch for each zone of the edited Master
 - [MASTER] → Master selection → [F2] MEMORY → ZoneSwitch = on → [EDIT] → Zone selection → [F2] NOTE → Transpose Page 216

Connecting to a computer/external MIDI instrument

- **Determining which connector (MIDI, USB TO HOST) is used for MIDI input/output**
 [UTILITY] → [F5] MIDI → [SF4] OTHER → MIDI IN/OUTPage 210
- **Using the sounds of the MO for Song playback from a MIDI sequencer**Page 110
- **Setting whether or not Bulk Dump data can be received**
 [UTILITY] → [F5] MIDI → [SF2] SWITCH → RcvBulk = on/protectPage 209
- **Sounding only the external MIDI tone generator and turning the internal tone generator off**
 [UTILITY] → [F5] MIDI → [SF2] SWITCH → LocalCtrl = offPage 209
- **Synchronizing with an external MIDI instrument/computer**
 - Using the MO as a MIDI master**
 [UTILITY] → [F5] MIDI → [SF3] SYNC → MIDI Sync = internal, ClockOut = on, Seqctrl = outPage 210
 - Using the MO as a MIDI slave**
 [UTILITY] → [F5] MIDI → [SF3] SYNC → MIDI Sync = MIDI, ClockOut = off, Seqctrl = inPage 210
 - Using the MO as a MTC slave**
 [UTILITY] → [F5] MIDI → [SF3] SYNC → MIDI Sync = MTC, ClockOut = off, Seqctrl = inPage 210
- **Disabling synchronization with the external MIDI instrument/computer**
 - Maintaining normal playback on an external MIDI sequencer, even when starting/stopping Song/Pattern playback on the MO**
 [UTILITY] → [F5] MIDI → [SF3] SYNC → MIDI Sync = internal, Seqctrl = offPage 210
 - Maintaining normal Song/Pattern playback on the MO, even when starting/stopping playback on an external MIDI sequencer**
 [UTILITY] → [F5] MIDI → [SF3] SYNC → Seqctrl = offPage 210
- **Synchronizing the LFO wave speed of the Voice with an external MIDI instrument/computer**
 - [UTILITY] → [F5] MIDI → [SF3] SYNC → MIDI Sync = MIDIPage 210
 - [VOICE] → Normal Voice selection → [EDIT] → [COMMON] → [F5] LFO → [SF1] WAVE → TempoSync = onPage 156
- **Setting which MIDI events will be transmitted or recognized via the MIDI and USB TO HOST connectors**
 [SONG] or [PATTERN] → [UTILITY] → [F3] SEQ → [SF2] FILTERPage 207
- **Setting the MIDI transmit channel**
 - Setting the MIDI transmit channel of the keyboard in the Voice mode/Performance mode**
 [UTILITY] → [F5] MIDI → [SF1] CH → KBDTransChPage 209
 - Setting the MIDI transmit channel and port for each track of a Song/Pattern**
 [SONG] or [PATTERN] → Song/Pattern selection → [F3] TRACK → [SF1] CHANNELPage 178
 - Setting the MIDI transmit channel of Arpeggio playback**
 [UTILITY] → [F3] VOICE → [SF3] ARP CH → TransmitChPage 206
- **Setting the MIDI receive channel**
 - Setting the MIDI receive channel of the keyboard in the Voice mode/Performance mode**
 [UTILITY] → [F5] MIDI → [SF1] CH → BasicRcvChPage 209
 - Setting the MIDI receive channel for each part of a Song/Pattern**
 [SONG] or [PATTERN] → Song/Pattern selection → [MIXING] → [EDIT] → Part selection → [F1] VOICE → [SF2] MODE → ReceiveChPage 191
- **Setting parameters for Program Change transmission/recognition**
 - Enabling or disabling the sending of Bank Select and Program Change messages, when selecting a Voice or Performance**
 [UTILITY] → [F5] MIDI → [SF2] SWITCH → BankSel, PgmChangePage 209
 - Enabling or disabling selection of MO Voices/Performances from an external MIDI device**
 [UTILITY] → [F5] MIDI → [SF2] SWITCH → BankSel, PgmChangePage 209
 - [SONG] or [PATTERN] → Song/Pattern selection → [MIXING] → [EDIT] → Part selection → [F5] RCV SW → BankSel, PgmChangePage 192
 - Setting related parameters so that the MIDI messages produced by the Song/Pattern playback will not be transmitted via MIDI**
 [SONG] or [PATTERN] → [UTILITY] → [F3] SEQ → [SF2] FILTERPage 207
- **Setting whether each track playback sounds the internal tone generator or an external tone generator**
 [SONG] or [PATTERN] → Song/Pattern selection → [F3] TRACK → [SF2] OUT SWPage 179

Other tips

- **Loading the specified file on the USB storage device automatically when the power is turned on**Page 102
- **Setting the Mode set automatically when the power is turned on**
 [UTILITY] → [F1] GENERAL → [SF4] OTHER → PowerOnModePage 206

Table of Contents

Introduction	6	Connecting the MO to external devices	103
Accessories.....	6	Connections	103
Main Features.....	7	Using as a Multi-timbral Tone Generator for your DAW/sequencer	110
How to use this manual	8	Using the MO with computer software	112
Application Index	9	Creating Your Original Program Set (Master mode)	122
The Controls & Connectors	14	Basic Structure	128
Front Panel	14	Internal Structure (System Overview)	128
Rear Panel.....	18	Internal Memory and File Management.....	148
Setting up and Playing	20	Reference	151
Power supply.....	20	Voice mode.....	151
Playing the keyboard	22	Performance mode.....	171
Modes	24	Song mode	178
Basic instructions	25	Pattern mode	196
Resetting the User Memory to the Initial Factory Settings	26	Mixing Voice mode.....	203
Basic Operation	27	Utility mode.....	205
Modes	27	File mode	211
About data storage to USB storage devices	30	Master mode.....	215
Functions and Sub-Functions	33	Appendix	219
Selecting a Program.....	33	Information Displays	219
Moving the Cursor and Setting Parameters	35	Display Messages	221
About the editing functions	36	About MIDI.....	223
Confirmation Message	37	Troubleshooting.....	227
Information Display	37	Specifications	231
Note (Key) settings.....	37	Index.....	232
Naming.....	38		
Quick Guide	40		
Playing the MO	40		
Voice Play mode	40		
Performance Play mode.....	44		
Using the Arpeggio feature.....	48		
Using the Controllers on the MO.....	50		
Editing a Program	53		
Editing a Voice	53		
Editing a Performance.....	63		
Using the Controllers—Advanced Course	69		
Controllers supported by the MO.....	69		
Creating a Song on the MO	73		
Playing the Demo Songs/Patterns.....	73		
Creating a Pattern	76		
Creating a Song	87		

The Controls & Connectors

Front Panel

MO8

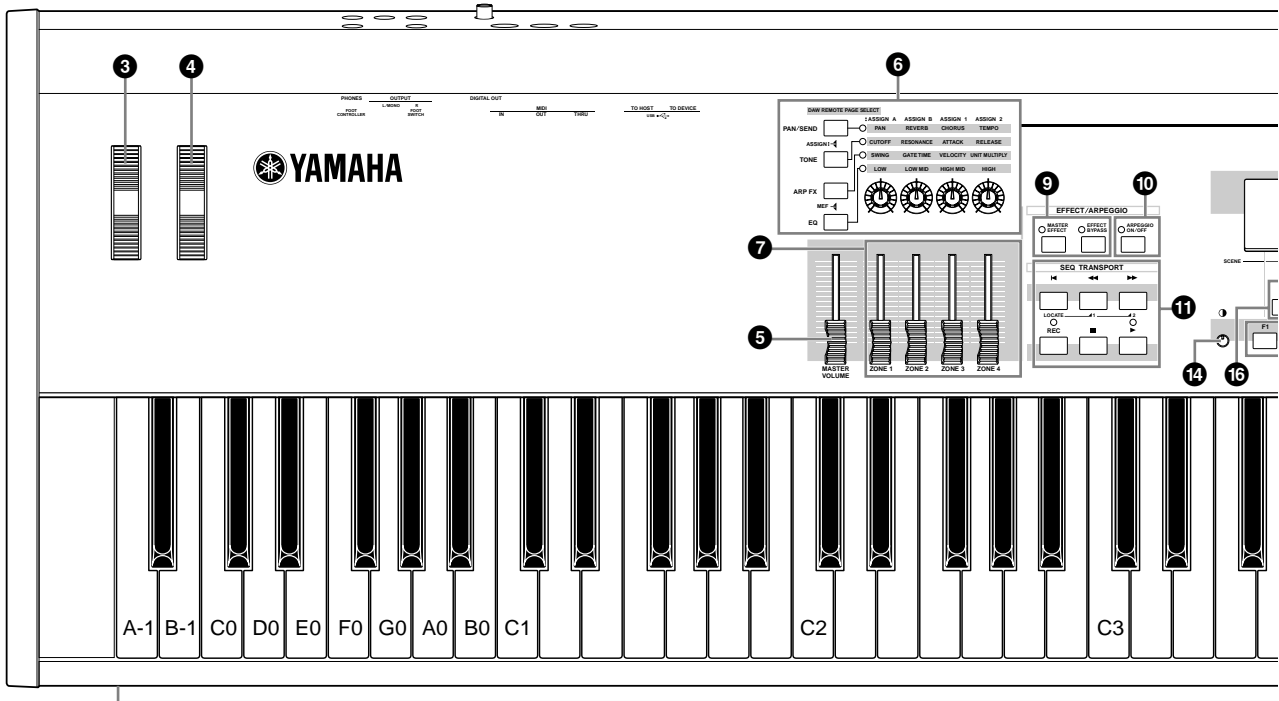

NOTE When [UTILITY] → [F1] GENERAL → [SF2] KBD → Octave is set to "0," each key corresponds to the note name shown in the illustrations. Refer to this illustration when setting a note name of a parameter like Note Limit.

MO6

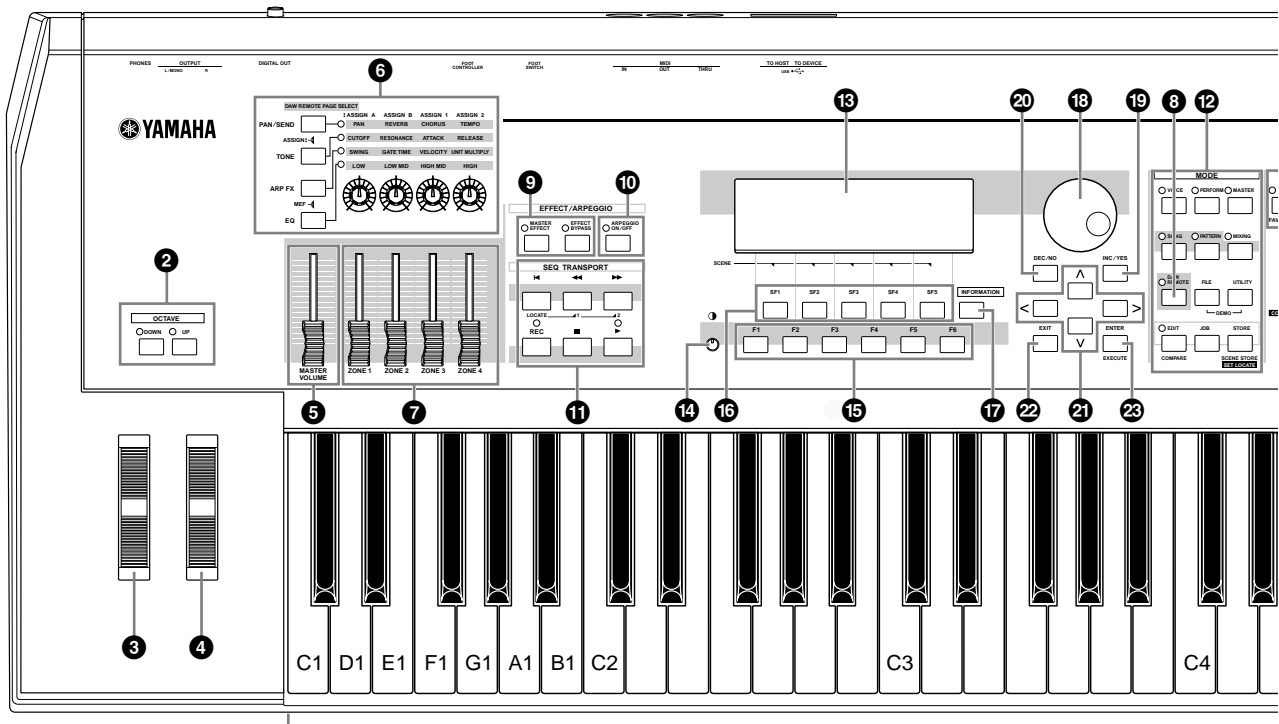

NOTE When both of the [OCTAVE] buttons are turned off, each key corresponds to the note name shown in the illustrations. Refer to this illustration when setting parameters having note name values, such as Note Limit.

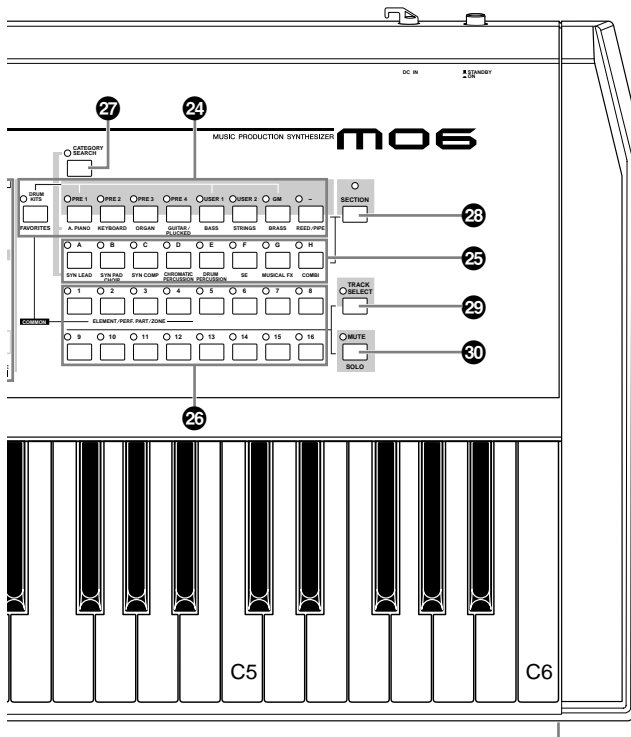
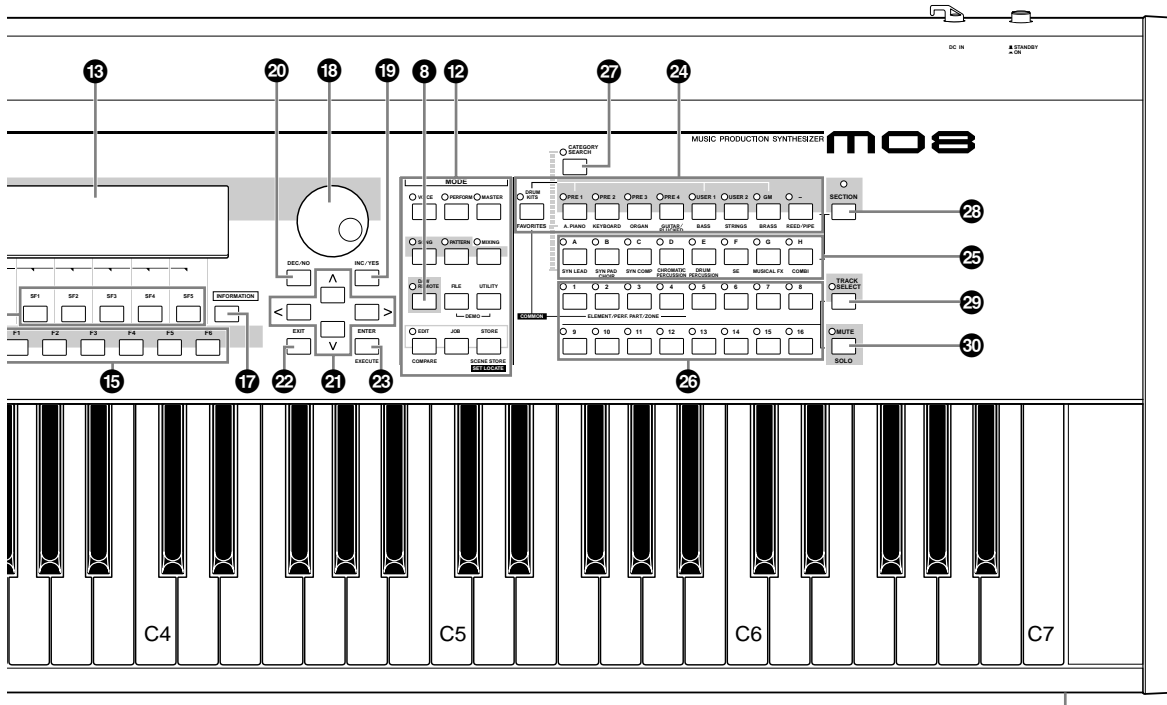

1 Keyboard

The MO6 features a 61-key keyboard, while the MO8 has 88 keys.

All are equipped with an initial touch feature. With initial touch, the instrument senses how strongly or softly you play the keys, and uses that playing strength to affect the sound in various ways, depending on the selected voice.

2 OCTAVE [UP] and [DOWN] buttons Page 29

Use these buttons to change the note range of the keyboard. To restore the normal octave setting, press both buttons simultaneously.

NOTE Because of its extended keyboard, the MO8 does not have OCTAVE buttons.

3 Pitch bend wheel Page 50

Controls the pitch bend effect. You can also assign other functions to this controller.

4 Modulation wheel Page 50

Controls the modulation effect. You can also assign other functions to this controller.

5 [MASTER VOLUME] slider

Adjusts the volume of the overall sound, as output from the rear-panel OUTPUT L/MONO and R jacks as well as the PHONES jack.

6 Four Knob Control Function buttons and four Knobs Page 51

These four highly versatile knobs let you adjust various aspects or parameters of the current Voice. Use the Knob Control Function buttons to change the parameter set for the knobs. The corresponding LED lights to indicate which group of parameters are active.

7 Control slider Page 52

These sliders control the volume of four elements which make up a Normal Voice in the Voice mode, the volume of four parts in the Performance mode, the volume of four parts including the current part in the Song mode/Pattern mode, and the volume of four zones in the Master mode.

NOTE If all of the Control sliders are set to the minimum, you may not hear any sound from the instrument, even when playing the keyboard or a Song/Pattern. If this is the case, raise all the sliders to a suitable level.

NOTE The [MASTER VOLUME] slider adjusts the output level from this instrument. On the other hand, the Control sliders adjust the MIDI volume value for the corresponding element or part.

8 DAW REMOTE button Page 113

The Remote mode lets you control sequencer software on your computer from the panel controls of the instrument. Turn the [DAW REMOTE] button on to enter the Remote mode.

9 [MASTER EFFECT] button and [EFFECT BYPASS] button Page 140

The extensive effect section of the instrument provides Insertion effects (three sets, with two effect units per set), System effects (Reverb and Chorus), and Master effects. The effects can be applied to the keyboard-played voices and to Song/Pattern playback. These buttons enable you to turn the corresponding Effect blocks (as printed on the panel) on or off with a single touch.

NOTE From the following display, you can select the specific effect(s) to be bypassed when using the [EFFECT BYPASS] button. [UTILITY] → [F1] GENERAL → [SF3] EF BYPS display

10 [ARPEGGIO ON/OFF] button Page 48

Press this button to enable or disable playback of the Arpeggio for each Voice, Performance, Song, or Pattern. If the Arpeggio Switch of the selected part is set to off in the Performance/Song/Pattern mode, however, pressing this button has no effect.

11 SEQ TRANSPORT buttons

These buttons control recording and playback of the Song/Pattern sequence data.

[⏪] (Top) button

Instantly returns to the beginning of the current Song or Pattern (i.e., the first beat of the first measure).

[⏮] (Reverse) button

Press briefly to move back one measure at a time, or hold to continuously rewind.

[⏭] (Forward) button

Press briefly to move forward one measure at a time, or hold to continuously fast-forward.

[REC] (Record) button

Press this to enable recording (Song or Pattern phrase). (The indicator lights.)

[■] (Stop) button

Press to stop recording or playback.

[▶] (Play) button

Press to start playback from the current point in the Song or Pattern. During recording and playback, the indicator flashes at the current tempo.

12 MODE buttons Page 24

These buttons select the operating modes (e.g., Voice mode).

13 LCD Display

The large backlit LCD displays the parameters and values related to the currently selected operation or mode.

14 LCD Contrast Control Page 21

Use this control to set the LCD display for optimum legibility.

15 [F1] – [F6] (Function) buttons Page 33

These buttons located directly below the LCD display call up the corresponding functions indicated in the display. In the display hierarchy, these functions [F] rank just below the modes.

16 [SF1] – [SF5] (Sub Function) buttons Page 33

These buttons located directly below the LCD display call up the corresponding sub functions indicated in the display. In the display hierarchy, these sub functions [SF] rank just below the functions [F].

These buttons can be also used to store/recall the Arpeggio type in each Play mode and Song/Pattern Record mode. They can be also used to store/recall the Song Scene (page 89) in the Song Play and Song Record modes.

17 [INFORMATION] button **Page 37**

For calling up a special “help” feature that shows information about the currently selected mode. You can go back to the previous display by pressing this button again or pressing any other button.

Depending on the selected display, this button may be used to call up a window for inputting characters, for inputting numbers, for selecting note lengths, or for selecting keys or note names (page 35).

18 Data dial **Page 35**

For editing the currently selected parameter. To increase the value, turn the dial right (clockwise); to decrease the value, turn the dial left (counter-clockwise). If a parameter with a wide value range is selected, you can change the value in broader strokes by quickly turning the dial.

19 [INC/YES] button **Page 35**

For increasing the value of the currently selected parameter. Also use it to actually execute a Job or a Store operation.

20 [DEC/NO] button **Page 35**

For decreasing the value of the currently selected parameter. Also use it to cancel a Job or a Store operation.

NOTE You can also use the [INC/YES] and [DEC/NO] buttons to quickly move through parameter values in 10-unit jumps, especially those with large ranges. Simply hold down one of the buttons (of the direction you want to jump), and simultaneously press the other. For example, to jump in the positive direction, hold down the [INC/YES] button and press [DEC/NO].

21 Cursor buttons **Page 35**

The cursor buttons move the “cursor” around the LCD display screen, highlighting and selecting the various parameters.

22 [EXIT] button **Page 28**

The menus and displays of this synthesizer are organized according to a hierarchical structure. Press this button to exit from the current display and return to the previous level in the hierarchy.

23 [ENTER] button

Use this button to execute a Job or a Store operation. Also use this button to actually enter a number when selecting a Memory or Bank for Voice or Performance. In the File mode, use this button to go to the next lowest level in the selected directory.

24 Bank buttons **Page 40**

Each button selects a Voice or Performance Bank. When the [CATEGORY SEARCH] button is turned on, these buttons can be used to select the desired category (printed below each button). When the [SECTION] button is turned on in the Pattern mode, these buttons are used to select the desired section.

25 Group [A] – [H] buttons **Page 41**

Each button selects a Voice or Performance Group. When the [CATEGORY SEARCH] button is turned on, these buttons can be used to select the desired category (printed below each button). When the [SECTION] button is turned on in the Pattern mode, these buttons are used to select the desired section.

26 Number [1] – [16] buttons

Use of these buttons differs depending on the on/off status of the [TRACK SELECT] and [MUTE] buttons.

	Functions of the Number [1] – [16] buttons		
	When [TRACK SELECT] is on	When [MUTE] is on	When both [TRACK SELECT] [MUTE] are off
Voice Play mode	Keyboard transmit channel setting	—	Voice selection, according to Groups A – H
Voice Edit mode	Element selection (1 – 4) and Element Mute setting (9 – 12)		—
Performance Play mode	Keyboard transmit channel setting	Performance part Mute setting (1 – 4)	Performance or Voice selection (if cursor is located at Voice name), according to Groups A – H
Performance Edit mode	Performance part selection (1 – 4)		
Master Play mode	Keyboard transmit channel setting (when memorizing the Voice mode or Performance mode to the current Master) or Song/Pattern track selection (when memorizing the Song mode or Pattern mode to the current Master)	—	Master selection, according to Groups A – H
Master Edit mode	Zone selection (1 – 4)	—	—
Song/Pattern Play mode	Song/Pattern track selection	Song/Pattern track Mute setting	Song/Pattern selection, according to Groups A – H
Song/Pattern Mixing mode	Song/Pattern part selection	Song/Pattern part Mute setting	
Mixing Voice Edit mode	Element selection (1 – 4) and Element Mute setting (9 – 12)		—

27 [CATEGORY SEARCH] button **Page 42**

When this button is turned on, the Bank buttons and the Group buttons can be used to select the Voice/Performance category.

28 [SECTION] button **Page 73**

When this button is turned on in the Pattern mode, the Group [A] – [H] buttons can be used to select Pattern Sections A – H and the [PRE1] – [–] buttons of the Bank buttons can be used to select Pattern Sections I – P.

29 [TRACK SELECT] button **Page 76**

Turning this button on in the Song/Pattern mode enables the Number [1] – [16] buttons for selecting corresponding Song/Pattern tracks. The on/off status of this button affects the Number [1] – [16] buttons in different ways, depending on the selected mode. (See 26 “Number [1] – [16] buttons” above.)

30 [MUTE] button **Page 74**

Turning this button on in the Song/Pattern mode enables the Number [1] – [16] buttons for muting corresponding Song/Pattern tracks. Press one of the Number [1] – [16] buttons while holding this button to solo the corresponding track of the current selected Song/Pattern. The on/off status of this button affects the Number [1] – [16] buttons in different ways, depending on the selected mode. (See 26 “Number [1] – [16] buttons” above.)

Rear Panel

MO8

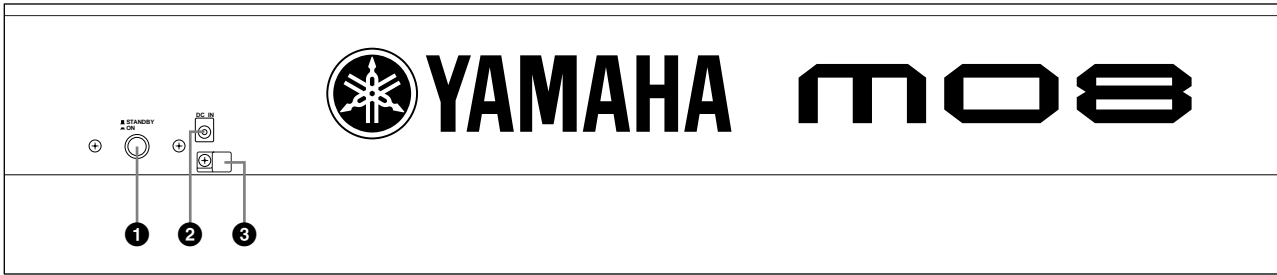

MO6



1 STANDBY/ON switch

Page 20

Press to turn power ON or OFF.

2 DC IN terminal

Page 20

Connect the AC adaptor to this terminal.

! WARNING

Do not attempt to use an AC adaptor other than the Yamaha PA-5D or an equivalent recommended by Yamaha. The use of an incompatible adaptor may cause irreparable damage to the MO, and may even pose a serious shock hazard!
ALWAYS UNPLUG THE AC ADAPTOR FROM THE AC POWER OUTLET WHEN THE MO IS NOT IN USE.

3 Cable clip

Wrap the DC output cable of the adaptor around the cable clip (as shown below) to prevent accidental unplugging of the cable during operation.

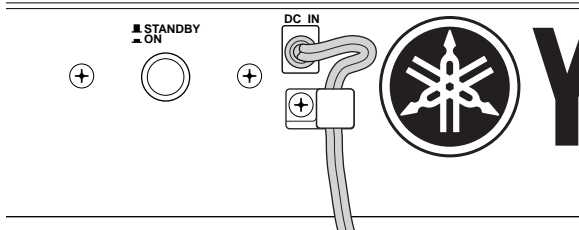

4 USB connectors

This instrument is equipped with two types of USB connectors on the rear panel—USB TO HOST and USB TO DEVICE. The USB TO HOST connector is used to connect this instrument to the computer via the USB cable. The USB connection between the instrument and the computer can only be used for transfer of MIDI data. No audio data can be transferred via USB. The USB TO DEVICE connector is used to connect this instrument to a USB storage device (hard disk drive, CD-ROM drive, MO drive, flash disk, etc.) via the USB cable. This lets you save the data created on this instrument to the external USB storage device and load the data from the external USB storage device to the instrument. Save/Load operations can be performed in the File mode.

NOTE For details about USB, see page 31.

USB

USB is an abbreviation for Universal Serial Bus. It is a serial interface for connecting a computer with peripheral devices, and enables much faster data transfer compared to conventional serial port connections.

5 MIDI IN/OUT/THRU connectors

Page 104

MIDI IN is for receiving control or performance data from another MIDI device, such as an external sequencer. MIDI THRU is simply for redirecting any received MIDI data (via MIDI IN) to connected devices, allowing convenient chaining of additional MIDI instruments. MIDI OUT is for transmitting all control, performance and playback data from the MO to another MIDI device, such as an external sequencer.

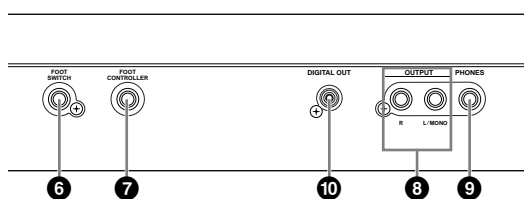
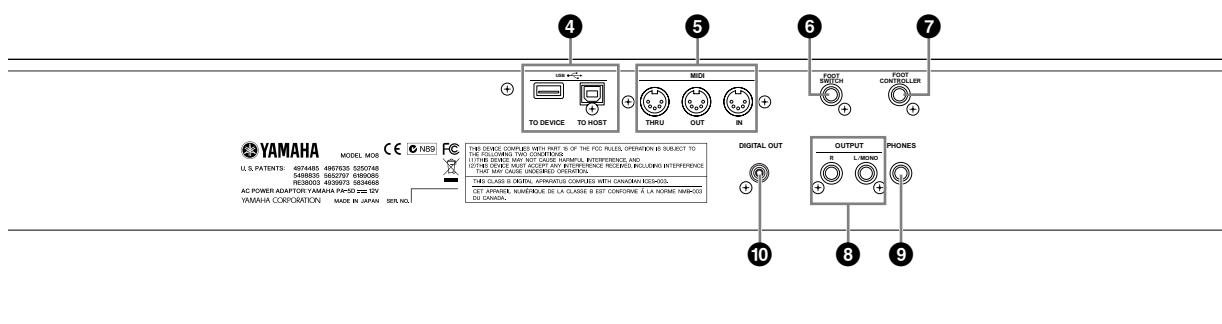

6 FOOT SWITCH jack **Page 69**

For connection of optional FC4 or FC5 Footswitch.

7 FOOT CONTROLLER jack **Page 69**

For connection of an optional foot controller (FC7, etc.). The FOOT CONTROLLER jack lets you continuously control one of various different assignable functions—such as volume, tone, pitch, or other aspects of the sound.

8 OUTPUT L/MONO and R jacks **Page 20**

Line level audio signals are output via these phone jacks. For monophonic output, use just the L/MONO jack.

9 PHONES jack **Page 20**

For connection to a pair of stereo headphones.

10 DIGITAL OUT connector **Page 103**

Use this connector to input or output digital signals over coaxial (RCA-pin) cable. The format is S/PDIF, normally used for CD and DAT players. The digital signal output is 44.1kHz/24-bit.

Setting up and Playing

Power supply

Power supply connections

Before you connect the power adapter, make sure that the MO [STANDBY/ON] switch is set to STANDBY (Off).

- 1 Connect the plug of the power adapter PA-5D to the DC IN terminal on the rear panel of the MO.
- 2 Plug in the AC cable to an appropriate AC outlet.

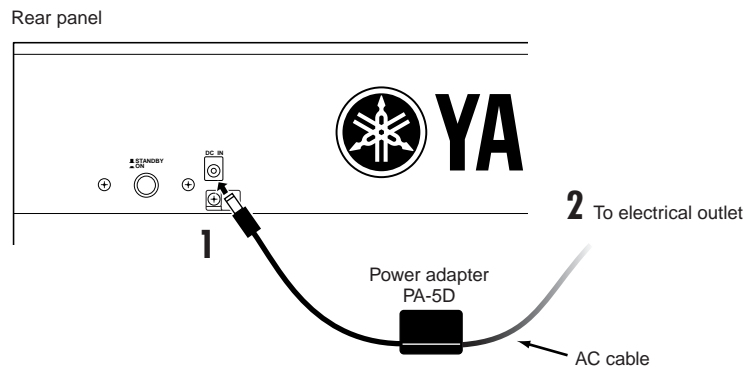

NOTE Follow this procedure in reverse order to disconnect the power adapter.

WARNING

- Be sure to use the included adapter. Using an AC adapter other than the PA-5D may cause damage to the MO, and may even pose a serious electrical shock hazard.
- Connect the adapter to an AC outlet of the specified voltage.

CAUTION

Even when the [STANDBY/ON] switch is in the STANDBY position, a small amount of electricity is still flowing to the unit. When you do not plan to use the MO for an extended period of time, be sure to unplug the AC power adapter from the AC outlet.

Connecting the speakers or pair of headphones

Since the MO has no built-in speakers, you will need to monitor the sound of the instrument by using external equipment. Connect a set of headphones, powered speakers, or other playback equipment as required.

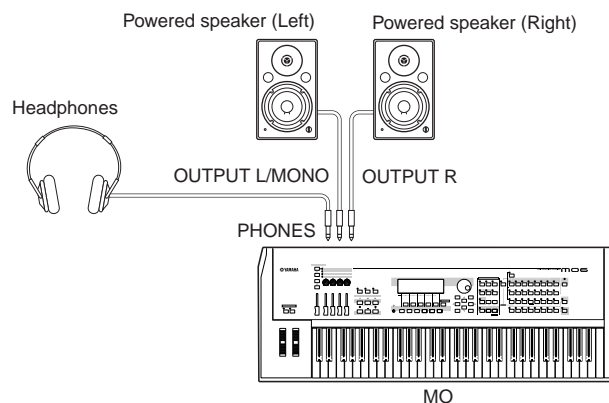

Turning the power on

Make sure the volume settings of the MO and external devices are turned down to the minimum.

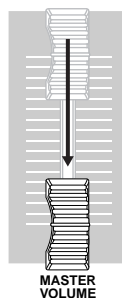

Turn the power on by pressing the [STANDBY/ON] switch on the MO rear panel, then turn the power on the amplifiers.

Connecting MIDI devices or a Mixer

Make sure that all volume settings are turned down all the way to the minimum. Then turn on the every device in your setup in the order of MIDI masters (controllers), MIDI slaves (receivers), then audio equipment (mixers, amplifiers, speakers, etc.).

When powering down the setup, first turn down the volume of each audio device, then switch off each device in the reverse order (first audio devices, then MIDI).

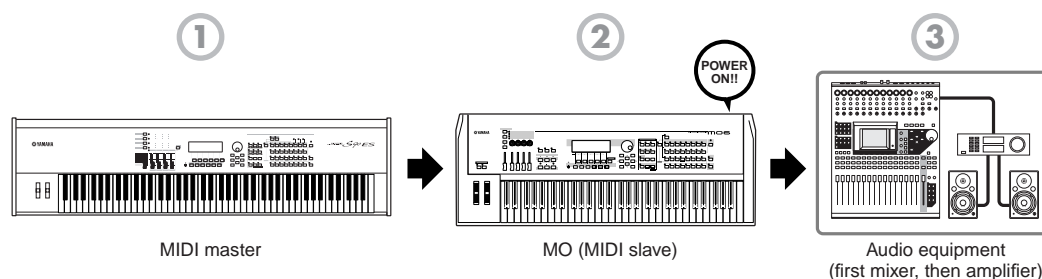

Adjusting the sound and the display contrast

Adjust the volume levels of the MO and the connected amplifier/speaker system. If the display is not easily visible, use the Contrast control to adjust for optimum visibility.

Adjust the volume with the MASTER VOLUME slider.

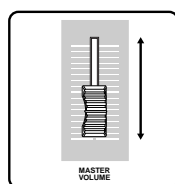

Adjust the display contrast with the Contrast control.

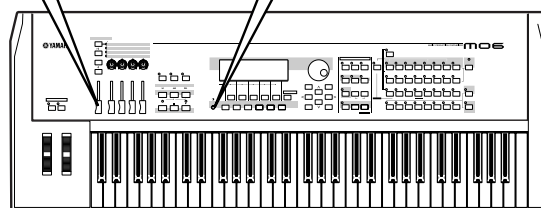
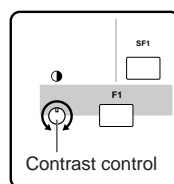

Now that you've set up the MO properly, you're ready to begin playing it.

NOTE When you are ready to turn off the MO, make sure to switch off the power of the external device (or lower its volume) before switching off the MO.

Playing the keyboard

Playing the sounds

Try playing some of the realistic and dynamic MO sounds from the keyboard now.

When you turn the power on following the directions in “Power supply connections” (page 20), the display below appears.

NOTE In the default settings, the Master mode is selected. For details about the modes, refer to the section “Modes” on page 24.

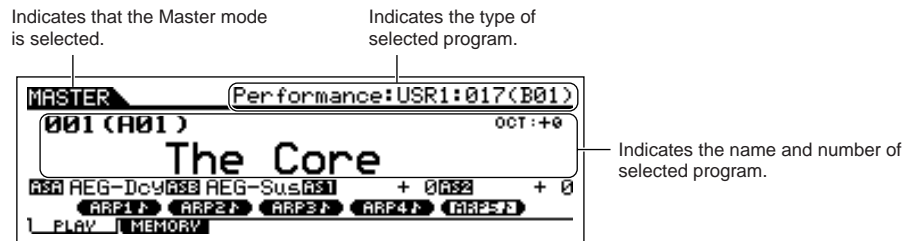

In this condition you can play the keyboard and hear the sounds of the selected program. When the instrument is turned on, the “The Core” program is automatically called up.

Notice the indication “Performance:USR1:017 (B01)” at the top right of the display. This indicates that Performance 017 in User bank 1 is currently selected. A “Performance” is one of the types of programs of the MO. As described below, the instrument also features other types: Voices, Songs, and Patterns.

NOTE For details about Banks, see page 40.

Selecting and playing the sounds

The MO provides three different types of programs for playing the sounds: Voices, Performances, Songs, and Patterns. The basic difference among these programs is in their use—for playing the keyboard, or for creating music with multiple parts.

For playing the keyboard		For creating music of multiple parts	
<p>Voice</p> <p>This program contains a basic instrument sound, such as a piano, guitar, bass guitar, drum kit, etc.</p>	<p>Performance</p> <p>This program allows you to combine several Voices together—either in a richly textured layer, or separately (as in different sections of the keyboard) for playing several different parts simultaneously.</p>	<p>Song</p> <p>This is a program consisting of recorded keyboard performance data, and/or patterns created in the Pattern mode.</p>	<p>Pattern</p> <p>This is a program that consists of individually created phrases or patterns of short duration (generally two or four measures), used for certain parts in a song—such as the intro, main melody or chorus.</p>

You can choose from 128 different Voices, Performances, Songs, and Patterns in the Master mode. To change the desired Master number, use the [INC/ YES] button, [DEC/NO] button, or the Data dial.

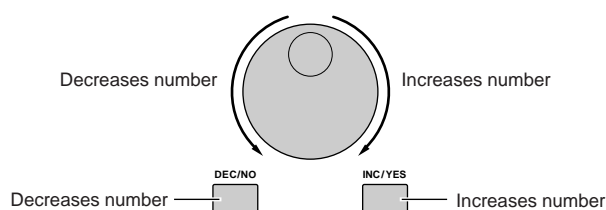

Change the Master number, and then try playing the various Voices or Performance types. When a Voice is assigned to the selected Master number, “Voice” will appear at the top of the display. When a Performance is assigned, “Performance” will appear in the display.

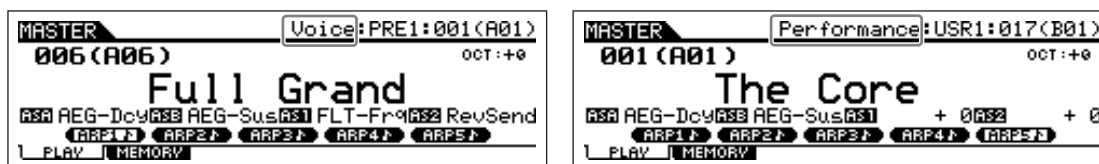

NOTE You can also choose some Songs and Patterns in the Master mode. For details about Songs and Patterns, see page 73.

As you play the various Voices and Performances, notice the differences between them—especially how some Performances sound exceptionally rich and more complex than Voices. Note also how many Performances use automatic rhythms and Arpeggios—along with keyboard split sounds—to let you sound like an entire band all by yourself!

Here, we’ve introduced the operations in the Master mode that is called up first when turning the power on. The MO has other modes of operation as well. In the next section, we’ll explain about the modes of the MO and how they are used.

Modes

There are several operation modes in the MO, and they can be selected by using the 12 mode buttons.

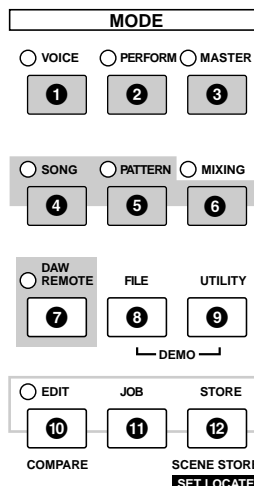

1 Playing the keyboard using a Voice

Voice mode [VOICE] button

The MO has a wealth of high-quality, dynamic sounds—also referred to as “Voices.” You can play these Voices—one Voice at a time—from the keyboard in the Voice mode. The MO also lets you create your own original Voices.

2 Playing the keyboard using multiple Voices

Performance mode [PERFORM] button

In the Performance mode, you can play several Voices together in a layer, or play different Voices from separate ranges of the keyboard. You can also trigger automatic rhythms and Arpeggios, over which you can play melody, chord or bass lines of your own. Each of these combinations of Voices is called a “Performance.” This mode lets you create richly textured, layered sounds or play two or more different parts simultaneously—for example, piano and bass guitar—and is particularly useful when performing solo.

3 Creating original program sets

Master mode [MASTER] button

The Master mode can be used in two ways:

- Storing your favorite settings that you often use in the Voice, Performance, Song, or Pattern mode, and instantly recall the mode and custom settings together in a single button press.
- Dividing the keyboard into four separate sections—just as if you were playing four different MIDI keyboards.

4 Creating original songs

Song mode [SONG] button

The Song mode lets you create your own original songs by recording your performance using Voices created in the Voice mode or by combining preset rhythmic Patterns.

5 Creating rhythm patterns

Pattern mode [PATTERN] button

In this mode, you can separately create the various “building blocks” of a song—rhythms and patterns for the intro, verse, main melody, chorus, etc.

6 Creating mixing settings

Song Mixing or Pattern Mixing mode [MIXING] button

Here, you can make various mixing settings, adjusting the level balance among the parts of the Song or Pattern, as well as each pan position and the effects applied to the Song/Pattern.

7 Controlling your computer DAW from the MO

Remote Control mode [DAW REMOTE] button

The Remote Control mode lets you control your computer’s sequencer software or DAW (digital audio workstation) by using the buttons or controllers on the MO.

8 Backing up data

File mode [FILE] button

The File mode lets you save your MO data to a USB storage device, and allows you to load data from the USB device to the MO.

9 Setting the system parameters

Utility mode [UTILITY] button

The Utility mode lets you set parameters that apply to the entire system of the MO. These parameter settings are applied to all Voices, Performances, Songs and Patterns.

10 Setting the parameters for each mode

Edit mode [EDIT] button

The Edit mode lets you set parameters that apply to each Voice, Performance, Song or Pattern.

11 Tools for organizing your data

JOB mode [JOB] button

This mode provides various operations and functions (called “jobs”) that help in organizing and controlling your important data, including initializing the settings and copying data.

12 Storing programs to the MO

Store mode [STORE] button

In this mode, you can store your edited programs to the internal memory of the MO. Keep in mind, however, that certain data, such as Songs and Patterns, are deleted when the power is turned off. For this reason, you should also store this important data to a USB memory device in the File mode.

Basic instructions

Voices—the basic building blocks of the MO

Voices—created in the Voice mode—are the basic sonic building blocks for the other modes of the MO. The Performance, Song, and Pattern programs are made up of different Voices, used together for specific performance or song recording. The MO features an exceptionally wide variety of preset Voices for playing in virtually any musical style. Try searching through the Voices to find your favorites.

Once you've explored them and feel comfortable with them, try branching out creatively and use the editing features to make your own original Voices.

Selecting a preset Voice



Page 40

Creating a new Voice



Page 53

Combine several Voices to create a Performance

To play several different Voices together simultaneously, select a Performance. The MO features 256 specially programmed Performances for playing in a variety of music styles.

Selecting a preset Performance



Page 44

Creating a new Performance



Page 63

Create a Song by recording your performance or combining some rhythm patterns

You can create your own Songs by using the built-in sequencer functions of the MO. The MO provides two different ways for creating Songs: 1) recording a Song conventionally from beginning to end, and 2) creating separate short sections (or "Patterns"), each several measures in length, and combining/repeating them to construct an entire Song.

Creating a Song



Page 87

Creating a Pattern



Page 76

Master mode—Create a master keyboard setup or instantly call up your desired programs

The Master mode lets you register your favorite Voices, Performances, Songs, and Patterns together into easy-to-select Master programs. No matter what mode is used—Voice, Performance, Song, or Pattern—you can have it instantly and automatically selected when you call up the appropriate Master.

The Master mode can also be used to divide the keyboard into four sections—each with its own Voice—just as if you were playing four different MIDI keyboards.

Making Master mode settings



Page 122

Convenient remote control of your computer software

The panel of the MO also serves as a convenient control surface for your computer music system. Use the buttons and sliders to control the audio mixer and sequencer transport functions in your MIDI/audio software. This highly intuitive approach gives you hands-on control over your virtual studio—a level of control that a computer keyboard and mouse can't match. These features are available for any computer sequence software and Multi Part Editor software (page 112) compatible with the Remote Control function.

Remote-controlling the software



Page 113

Global settings and data backup

While the Voice, Performance, Song, and Pattern modes provide controls for using and editing the programs of the MO, the Utility mode is the place where you make overall settings for the instrument—for example, adjusting the transpose and fine tuning controls, or switching between MIDI and USB operation. You can also archive your important MO data to a USB storage device for safe-keeping.

Making global system settings



Page 205

Backing up important data



Page 211

This concludes our short guide to the basic operations and functions of the MO. Enjoy the dynamic, authentic sounds of the instrument as you continue to play it and create music on it. Make sure to check out the references above and go on to explore some of the other exciting and powerful features of the MO.

Resetting the User Memory to the Initial Factory Settings

The original factory setting of this synthesizer's User Memory can be restored as follows.

⚠ WARNING

When the factory settings are restored, all the Voice, Performance, Song, Pattern, and system setting in the Utility mode you created will be erased. Be sure to save all important data to USB storage device before executing this procedure (pages 60, 66 and 98).

1 Press the [UTILITY] button to enter the Utility mode.

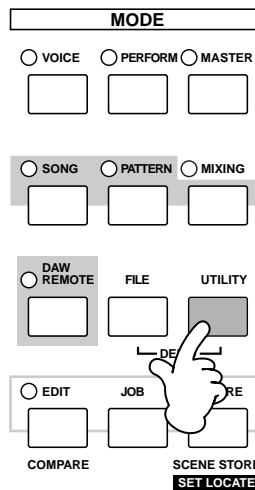

2 Press the [JOB] button to enter the Utility Job mode.

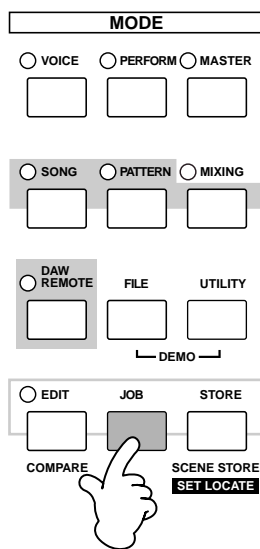

NOTE When the checkbox of "PowerOn Auto" is on (checked) and you execute the Factory Set Job, Factory Set will be executed automatically when the power is turned on. In general, this box should be off (unchecked). If PowerOn Auto is checked here and you want to execute the Factory Set Job, first uncheck the box, then execute the Job.

3 Press the [ENTER] button. (The display prompts you for confirmation.)

To cancel the Job, press the [DEC/NO] button.

4 Press the [INC/YES] button to execute the Job.

After the Job has been completed, a "Completed" message appears and operation returns to the original display.

⚠ CAUTION

For Factory Set operations that take longer to process, you will see the message "Executing..." or "Please Keep Power On!" during processing. Do not switch the power off while this message is on the display. Turning the power off in this state results in loss of all user data and may cause the system to freeze. This means that this synthesizer may not be able to start up properly, even when turning the power on next time.

Basic Operation

In this section, we'll take a look at the fundamental operating conventions of the MO. Here, you'll learn the basics—how to select modes, call up the various functions, change settings, and edit parameter values. Before reading further, familiarize yourself with the basic terms used with the MO in the chart below.

Term	Description	Page
Voice	Musical instrument voices	40
Performance	A program in which multiple Voices are combined in a layer	44
Song	Music data consisting of MIDI events	73
Pattern	Rhythm pattern data consisting of MIDI events used for looped playback	73
Master	A program which lets you register the settings in each mode—Voice, Performance, Song, and Pattern	122
File	A collection of settings for storing and managing your created data	211

Modes

Mode Structure

This synthesizer is organized into various modes, each covering a different set of operations and functions. Keep in mind that there are two basic types of modes, depending on the status of the tone generator block. The first type includes the Voice and Performance modes, and the internal tone generator is used in single timbre operation—meaning that only one Voice, or one channel of MIDI data is used.

The second type includes the Song and Pattern modes, and the internal tone generator is used in multi-timbral operation—meaning that several Voices, or multiple MIDI channels are used. In addition to the above, there are three special modes. The Master mode lets you memorize your desired settings in each mode (Voice/Performance/Song/Pattern) and recall them instantly anytime you need them with a single button. The File mode lets you manage your created data, while the Utility mode provides controls related to the overall operation of the instrument.

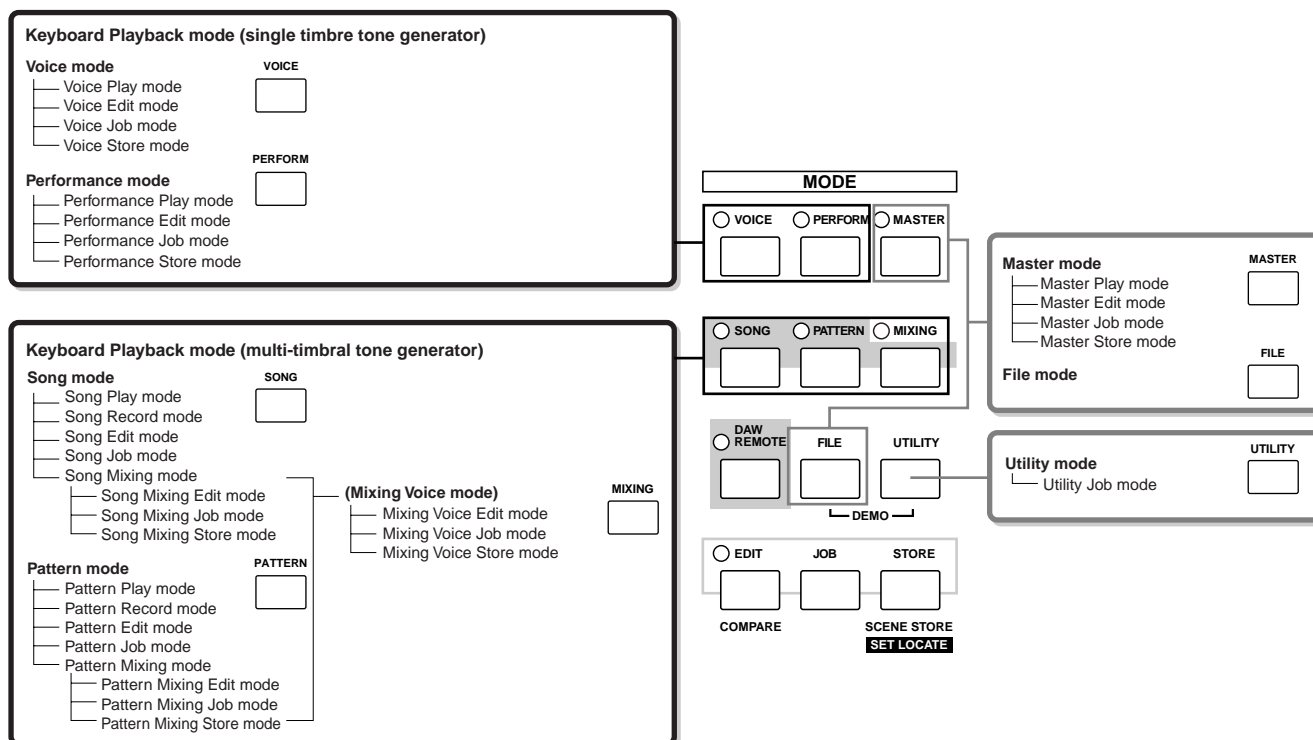

Mode table

The functions of each mode and how to enter each mode are as follows:

Mode	Function	How to enter the mode	
Voice mode	Voice Play mode	Playing a Voice	[VOICE]
	Voice Edit mode	Editing/Creating a Voice	[VOICE] → [EDIT]
	Voice Job mode	Initializing a Voice, etc.	[VOICE] → [JOB]
	Voice Store mode	Storing a Voice to internal memory	[VOICE] → [STORE]
Performance mode	Performance Play mode	Playing a Performance	[PERFORM]
	Performance Edit mode	Editing/Creating a Performance	[PERFORM] → [EDIT]
	Performance Job mode	Initializing a Performance, etc.	[PERFORM] → [JOB]
	Performance Store mode	Storing a Performance to internal memory	[PERFORM] → [STORE]
Song mode	Song Play mode	Playing a Song	[SONG]
	Song Record mode	Recording a Song	[SONG] → [REC]
	Song Edit mode	Editing a Song MIDI events	[SONG] → [EDIT]
	Song Job mode	Converting and transforming Song data	[SONG] → [JOB]
	Song Mixing mode	Setting tone generator parameters	[SONG] → [MIXING]
	Song Mixing Edit mode	Setting tone generator parameters in detail	[SONG] → [MIXING] → [EDIT]
	Song Mixing Job mode	Initializing a Song Mixing, etc.	[SONG] → [MIXING] → [JOB]
	Song Mixing Store mode	Storing a Song Mixing internal memory	[SONG] → [MIXING] → [STORE]
Pattern mode	Pattern Play mode	Playing a Pattern	[PATTERN]
	Pattern Record mode	Recording a Pattern	[PATTERN] → [REC]
	Pattern Edit mode	Editing a Pattern MIDI events	[PATTERN] → [EDIT]
	Pattern Job mode	Converting and transforming Pattern data	[PATTERN] → [JOB]
	Pattern Mixing mode	Setting tone generator parameters	[PATTERN] → [MIXING]
	Pattern Mixing Edit mode	Setting tone generator parameters in detail	[PATTERN] → [MIXING] → [EDIT]
	Pattern Mixing Job mode	Initializing a Pattern Mixing, etc.	[PATTERN] → [MIXING] → [JOB]
	Pattern Mixing Store mode	Storing a Pattern Mixing internal memory	[PATTERN] → [MIXING] → [STORE]
(Mixing Voice mode)	Mixing Voice Edit mode	Editing/Creating a Voice dedicated for Song/Pattern	[SONG] or [PATTERN] → [MIXING] → [F5] VCE ED
	Mixing Voice Job mode	Initializing a Mixing Voice, etc.	[SONG] or [PATTERN] → [MIXING] → [F5] VCE ED → [JOB]
	Mixing Voice Store mode	Storing a Mixing Voice to internal memory	[SONG] or [PATTERN] → [MIXING] → [F5] VCE ED → [STORE]
Utility mode	Utility mode	Setting System related parameters	[UTILITY]
	Utility Job mode	Resetting the User Memory to the Initial Factory Settings	[UTILITY] → [JOB]
Master mode	Master Play mode	Playing a Master	[MASTER]
	Master Edit mode	Editing/Creating a Master	[MASTER] → [EDIT]
	Master Job mode	Initializing a Master, etc.	[MASTER] → [JOB]
	Master Store mode	Storing a Master to internal memory	[MASTER] → [STORE]
File mode	File mode	Managing Files and Folders (Directories)	[FILE]

How to leave the current display

For most operations or displays (except for the File mode, Song/Pattern Record mode, and Remote Control mode), pressing the [EXIT] button will let you leave the current display and return you to the previous one. You can return back to any of the modes—Voice Play, Performance Play, Song Play, Pattern Play, and Master Play—by pressing the [EXIT] button several times in the respective mode.

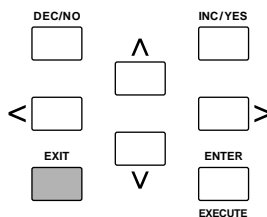

Keyboard octave setting (MO6)

Sometimes when playing a voice, you may wish to play in a lower or higher pitch range. For example, you may want to shift the pitch down lower to get extra bass notes, or shift up to get higher notes for leads and solos. The Octave Up/Down controls let you do this quickly and easily. Each time you press the [OCTAVE UP] button on the panel, the overall pitch of the voice goes up by one octave. Likewise, each press of the [OCTAVE DOWN] button takes the pitch down by one octave. The range is from -3 to +3, with 0 being standard pitch. When this is set to Octave Up, the lamp of the [OCTAVE UP] button lights, and when it is set to Octave Down, the [OCTAVE DOWN] button's lamp lights. The current octave setting is shown at the top right of the display. You can instantly restore standard pitch (0) by simultaneously pressing both the [OCTAVE UP] button and the [OCTAVE DOWN] button (both lamps turn off).

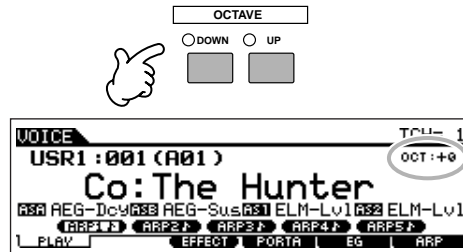

NOTE The Octave setting made here is automatically reflected in the identical Octave parameter in the Utility mode ([UTILITY] → [F1] GENERAL → [SF2] KBD → Octave). This setting is available in all modes.

Transpose setting of the keyboard

You can set the amount in semitones by which the range of the keyboard is shifted up or down as well as the octave setting.

1 Press the [UTILITY] button to enter the Utility mode.

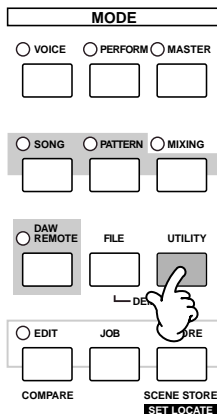

2 Press the [F1] GENERAL button, then the [SF2] KBD button.

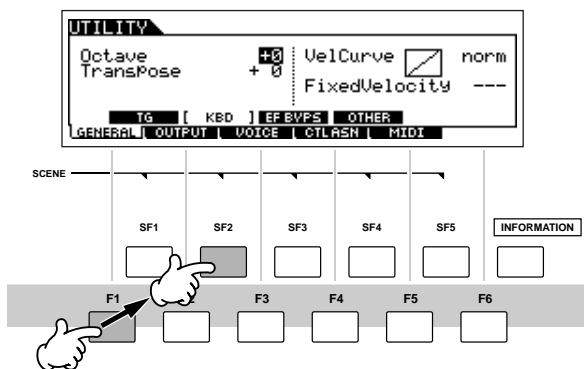

3 Move the cursor to "Transpose" by using the Cursor button.

4 Change the Transpose value by using the [INC/YES], [DEC/NO] buttons and data dial.

5 Press the [STORE] button to store the Transpose setting to internal Flash ROM.

CAUTION

Make sure to execute step 5. The settings made in step 4 will be lost if you turn the power off without executing step 5.

CAUTION

Never attempt to turn off the power while data is being written to Flash ROM (while a "Please keep power on" message is shown). Turning the power off in this state may not only cause the system to freeze (due to data corruption in the Flash ROM) and prevent normal startup the next time the power is turned on, it may also result in loss of all user data.

NOTE The transpose setting is available in all modes.

About data storage to USB storage devices

As you make music with this instrument, you'll create a wide variety of data—such as custom Voice data (including Voices, Performances, etc.), and MIDI sequence data (Songs, Patterns, Arpeggios). Naturally, you'll want to store this data for safekeeping and future use, and for this reason the instrument is equipped with a USB TO DEVICE connector—letting you save your data to a convenient USB storage device. To recall the data, use the Load function. (Save and Load operations are done in the File mode; see page 211.) Keep in mind that certain types of data are lost when you turn off the power and should be properly saved.

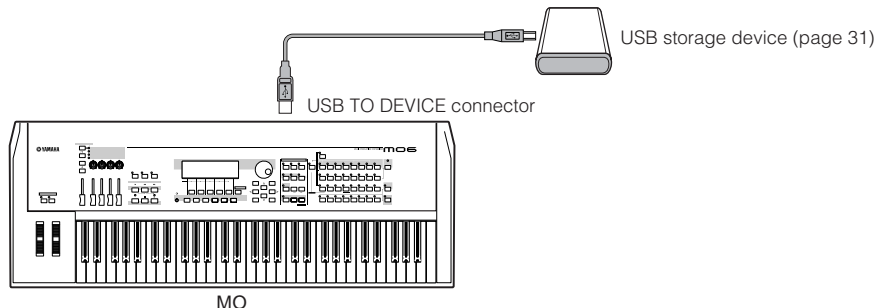

Data lost and data retained when power is turned off

The chart below lists the data types you can create on the instrument and the internal memory locations to which they are stored, permanently or temporarily.

CAUTION

Make sure to save any data remaining in DRAM to a USB storage device before turning off the power, other wise the data will be lost.

Data types	Page	Mode in which data is created	Internal memory types to which data is stored
Voice	53	Voice mode	Flash ROM
Mixing Voice	78	Mixing Voice mode	DRAM → Lost when power is turned off.
Performance	63	Performance mode	Flash ROM
Song*	87	Song mode	DRAM → Lost when power is turned off.
Song Chain	95	Song Chain mode	DRAM → Lost when power is turned off.
Pattern*	76	Pattern mode	DRAM → Lost when power is turned off.
Pattern Chain	84	Pattern Chain mode	DRAM → Lost when power is turned off.
Phrase (Pattern)	79	Pattern mode	DRAM → Lost when power is turned off.
Arpeggio	97	Song mode, Pattern mode	Flash ROM
Master	122	Master mode	Flash ROM
Mixing Template**	77	Song Mixing mode, Pattern Mixing mode	Flash ROM
System settings	205	Utility mode	Flash ROM

* Includes the Mixing settings (pages 137, 138)

** Song Mixing/Pattern Mixing can be stored as Song/Pattern data and as a Mixing Template (which are not associated with a specific Song/Pattern).

NOTE For details about the data types you can create on this instrument, the internal memory locations to which they are stored, and file types when saving the created data to the USB storage device, refer to "Memory Structure" on page 149.

Using USB storage devices

When using USB storage devices, make sure to connect them to the USB TO DEVICE connector, and follow the important precautions below.

Compatible USB devices

Connect only a USB storage device (such as hard disk, CDROM, flash disk and other drives) to the USB TO DEVICE connector. Other devices such as a computer keyboard or mouse cannot be used.

Both bus-powered (powered by the host device) or self-powered (battery or external power supply) types can be used.

The MO does not necessarily support all commercially available USB storage devices. Yamaha cannot guarantee operation of USB storage devices that you purchase. Before purchasing USB storage devices, please consult your Yamaha dealer, or an authorized Yamaha distributor (see list at end of the Owner's Manual) for advice, or see the following website:

<http://www.yamahasyth.com/>

NOTE Although CD-R/W drives can be used to load data to the instrument, they cannot be used for saving data. However, you can transfer data to a computer and save data to a CD using the CD-R/W drive on the computer.

Formatting USB storage media

When a USB storage device is connected or media is inserted, a "USB device unformatted." message may appear in the LCD display, indicating that the device or media must be formatted for use. Execute the Format operation in the File mode (page 211).

Precautions when using the USB TO DEVICE connector

CAUTION

Never turn the USB device's power on/off and never plug/unplug the USB cable when the connected USB storage device is the self powered type. Doing so may result in the operation of the synthesizer "freezing" or hanging up.

While the instrument is accessing data (such as in the Save, Load and Delete operations in the File mode), do NOT unplug the USB cable, do NOT remove the media from the device, and do NOT turn the power off to either device. Doing so may corrupt the data on either or both devices.

To protect your data (write-protect):

To prevent important data from being inadvertently erased, apply the write-protect provided with each storage device or media.

If you are saving data to the USB storage device, make sure to disable or remove write-protect.

USB connector types

There are two different types of USB connectors, and the rear panel of the instrument features both. Take care not to confuse the two.

USB TO HOST connector

This type is used to connect the instrument to a computer, and allows you to transfer MIDI data between the devices. The USB connection between the instrument and the computer can only be used for transfer of MIDI data. Unlike MIDI, USB can handle multiple ports via a single cable.

USB cables may have different connectors on each end: the A type and the B type. Connect the A type to your computer and the B type to the USB TO HOST connector.

USB TO DEVICE connector

This type is used to connect the instrument to a USB storage device, and allows you to save data you've created to the connected device, as well as load data from the connected device. This lets you save the data created on this instrument to the external USB storage device and load the data from the external USB storage device to the instrument. Save and Load operations are executed in the File mode (page 211).

USB cables may have different connectors on each end: the A type and the B type. Connect the A type to the USB TO DEVICE connector and the B type to the USB storage device.

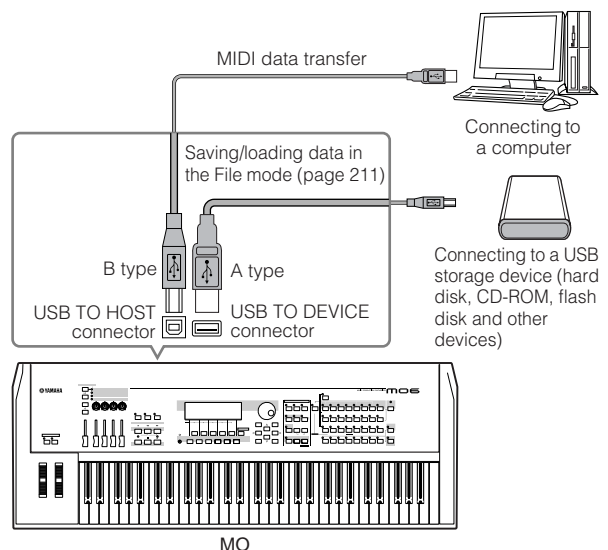

NOTE The computer cannot access the USB storage device connected to the USB TO DEVICE connector on the MO, even if connecting as shown above. Only from the File mode on the instrument itself can you access the data on the USB storage device connected to the USB TO DEVICE connector.

NOTE Though the MO supports only up to the USB 1.1 standard, USB 2.0 storage devices can be connected and used with the instrument. However, note that the transfer speed complies to USB 1.1.

TIP Backing up your data to a computer

■ Backing up MO data to a computer

Once you've saved data to a USB storage device, you can copy the data to the hard disk of your computer, then archive and organize the files as desired. Simply reconnect the device as shown below.

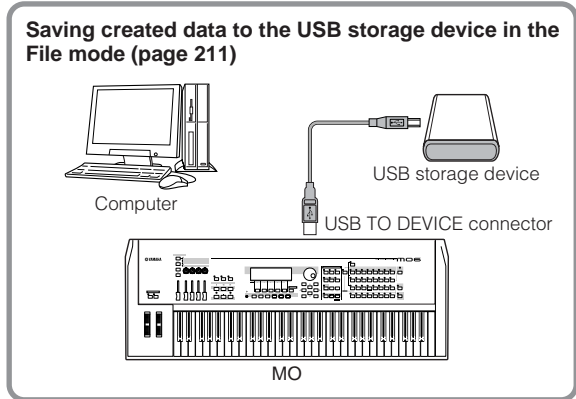

↓ Disconnect the USB storage device from the synthesizer and connect it to the computer

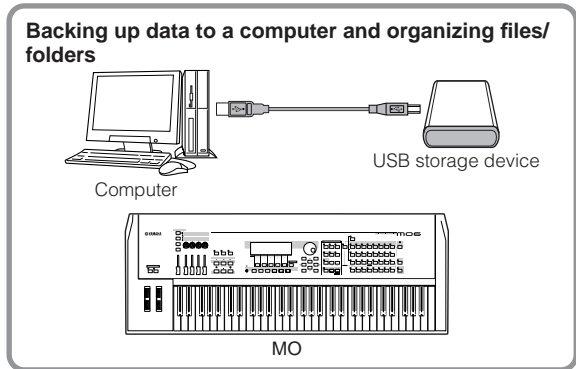

■ Loading data from a computer to the MO

Data and files contained on the hard disk of a computer can be loaded to the MO by copying them first to the storage media, then transferring them to the instrument. In this way, you can use data created on the computer or another instrument with the MO. For example, you can load Standard MIDI files to the instrument as Song/Pattern data, or import files created on the MOTIF ES.

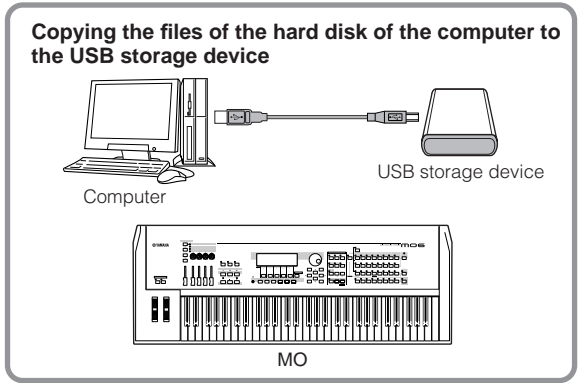

↓ Disconnect the USB storage device from the computer and connect it to the synthesizer

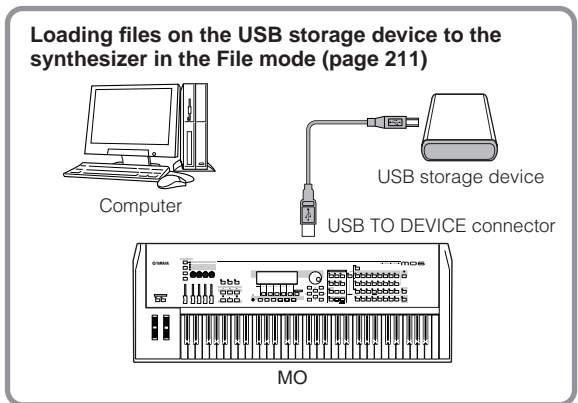

Functions and Sub-Functions

Each mode described above contains various displays, with various functions and parameters. To navigate your way through these displays and select a desired function, use the [F1] – [F6] buttons and the [SF1] – [SF5] buttons. When you select a mode, the available displays or menus appear directly above the buttons at the bottom of the display (as shown below).

Using the Function buttons [F1] – [F6]

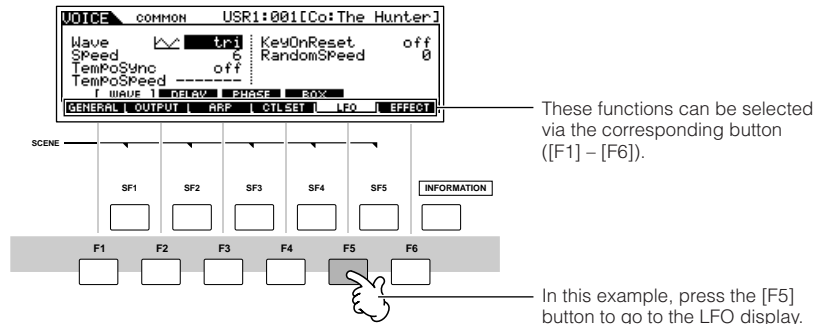

Depending on the currently selected mode, up to six functions are available and can be called up with the [F1] – [F6] buttons. Keep in mind that the available functions differ depending on the selected mode.

Using the Sub-Function buttons [SF1] – [SF5]

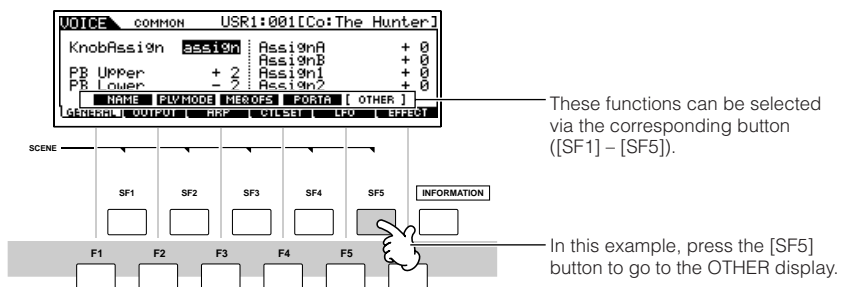

Depending on the currently selected mode, up to five functions (sub-functions) are available and can be called up with the [SF1] – [SF5] buttons. Keep in mind that the available functions differ depending on the selected mode. (Some displays may not have any sub-functions for these buttons.)

Selecting a Program

In order to play the MO you'll need to call up one of its programs, i.e., a Voice, Performance, Song, Pattern, or Master. These programs can be selected in each Play mode via the same procedure.

■ Using the [INC/YES], [DEC/NO] buttons and the data dial

The [INC/YES] and [DEC/NO] buttons let you step up or down through the program numbers in any of the Play modes (Voice, Performance, Song, Pattern, and Master).

Rotating the data dial to the right (clockwise) increases the program number, while rotating it to the left (counter-clockwise) decreases it. This control works in the same way as the [INC/YES] and [DEC/NO] buttons, but lets you scroll through the programs more quickly.

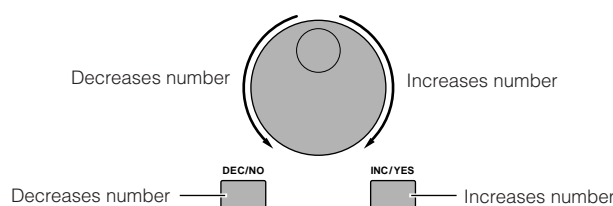

Using the Group buttons and Number buttons

As shown below, you can select a program number by pressing any of the Group [A] – [H] buttons and pressing any of the Number [1] – [16] buttons.

The explanations here apply when these button indicators are off.

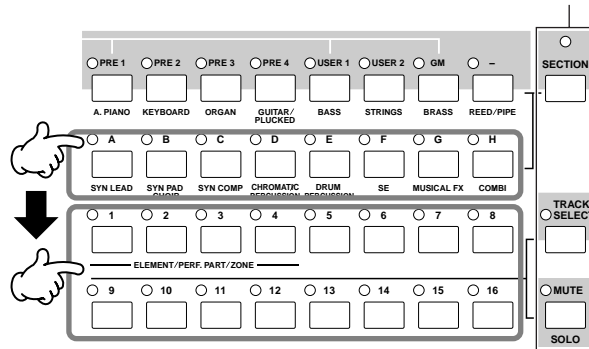

NOTE The convenient Category Search function (page 42) lets you easily locate and select the Voices you want by type.

The Voice program numbers and the corresponding Group/Numbers are listed below.

Program Number	Group	Number	Program Number	Group	Number	Program Number	Group	Number	Program Number	Group	Number
001	A	1	033	C	1	065	E	1	097	G	1
002	A	2	034	C	2	066	E	2	098	G	2
003	A	3	035	C	3	067	E	3	099	G	3
004	A	4	036	C	4	068	E	4	100	G	4
005	A	5	037	C	5	069	E	5	101	G	5
006	A	6	038	C	6	070	E	6	102	G	6
007	A	7	039	C	7	071	E	7	103	G	7
008	A	8	040	C	8	072	E	8	104	G	8
009	A	9	041	C	9	073	E	9	105	G	9
010	A	10	042	C	10	074	E	10	106	G	10
011	A	11	043	C	11	075	E	11	107	G	11
012	A	12	044	C	12	076	E	12	108	G	12
013	A	13	045	C	13	077	E	13	109	G	13
014	A	14	046	C	14	078	E	14	110	G	14
015	A	15	047	C	15	079	E	15	111	G	15
016	A	16	048	C	16	080	E	16	112	G	16
017	B	1	049	D	1	081	F	1	113	H	1
018	B	2	050	D	2	082	F	2	114	H	2
019	B	3	051	D	3	083	F	3	115	H	3
020	B	4	052	D	4	084	F	4	116	H	4
021	B	5	053	D	5	085	F	5	117	H	5
022	B	6	054	D	6	086	F	6	118	H	6
023	B	7	055	D	7	087	F	7	119	H	7
024	B	8	056	D	8	088	F	8	120	H	8
025	B	9	057	D	9	089	F	9	121	H	9
026	B	10	058	D	10	090	F	10	122	H	10
027	B	11	059	D	11	091	F	11	123	H	11
028	B	12	060	D	12	092	F	12	124	H	12
029	B	13	061	D	13	093	F	13	125	H	13
030	B	14	062	D	14	094	F	14	126	H	14
031	B	15	063	D	15	095	F	15	127	H	15
032	B	16	064	D	16	096	F	16	128	H	16

NOTE When selecting a Voice and Pattern, it is necessary to press one of the Bank buttons before pressing the Group and Number buttons.

NOTE The amount of numbers differ depending on the program. For example, while the selected number range of the Normal Voice, Performance, and Master is 001 – 128, the selected number range of the Song and Pattern is 001 – 064.

Moving the Cursor and Setting Parameters

Moving the cursor

Use these four buttons to navigate the display, moving the cursor around the various selectable items and parameters in the screen. When selected, the relevant item is highlighted (the cursor appears as a dark block with inverse characters). You can change the value of the item (parameter) at which the cursor is located by using the data dial, [INC/YES] and [DEC/NO] buttons.

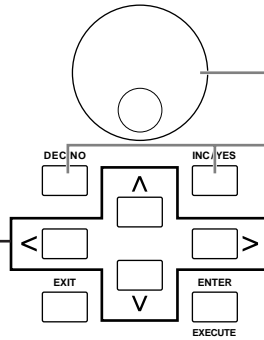

Changing (editing) parameter values

Rotating the data dial to the right (clockwise) increases the value, while rotating it to the left (counter-clockwise) decreases it.

For parameters with large value ranges, you can increase the value by 10 by simultaneously holding down the [INC/YES] button and pressing the [DEC/NO] button. To decrease by 10, do the opposite; simultaneously hold down the [DEC/NO] button and press the [INC/YES] button.

Inputting a number directly

For parameters having large value ranges (such as the Song measure), you can also enter the value directly, using the buttons below the LCD display as a numeric keypad. When the cursor is located on such a parameter, the [NUM] icon appears at the lower right corner of the LCD display indicating that you can call up the number input window by pressing the [INFORMATION] button. From this window, you can input a number directly by pressing the [F1] – [F6] buttons and the [SF1] – [SF5] buttons (or Number [1] – [10] buttons). First, press the [F6] button so that the cursor appears at the Input Number within the bracket. Move the cursor to the desired digit by using the Cursor buttons [>] and [<], then input the number of the selected digit. After completing the number input, press the [ENTER] button to actually enter the number. Press the [EXIT] button to go back to the original display.

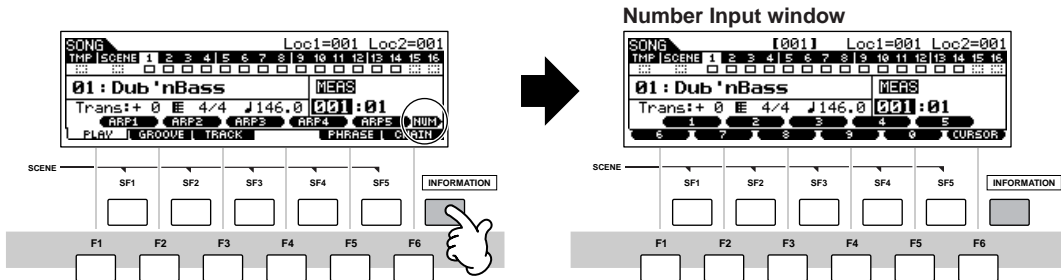

NOTE You can also input a number directly by pressing the Number [1] – [10] buttons. In this case, the [10] button is used to input "0."

Selecting a note type

When the cursor is located on the parameter to which the note type is set, the note icon appears at the lower right corner indicating that you can call up the Note Type selection window by pressing the [INFORMATION] button. You can specify the note type by pressing the [F1] – [F6] buttons and the [SF1] – [SF5] buttons. After selecting one of the note types, press the [ENTER] button to actually enter the selection. Press the [EXIT] button to go back to the original display.

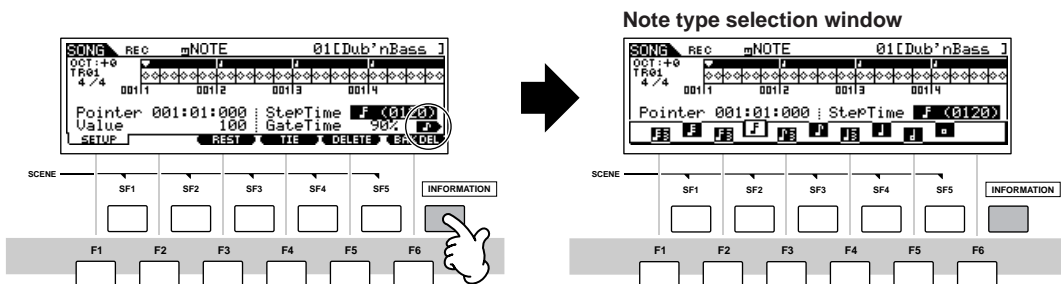

About the editing functions

There are three types of method for creating data—Editing parameters (Voice, Performance, etc.) and Recording MIDI data (Song, Pattern, etc.).

In this section, we'll explain the basic operations for editing the Voice, Performance, Song Mixing, Pattern Mixing, Mixing Voice settings.

NOTE For details on recording MIDI data, see page 73.

NOTE The Song Edit function (for editing the Song MIDI sequence data) and the Pattern Edit function (for editing the Pattern MIDI sequence data) are not explained here. See page 90.

Basic Operation

Edit Indicator

You can adjust or set various parameters by using the data dial, [INC/YES] button, [DEC/NO] button, Knobs, and Control sliders in the Voice mode (Play/Edit mode), Performance mode (Play/Edit mode), Song Mixing mode, Pattern Mixing mode, and Mixing Voice mode. When changing the value of the parameter in these modes, the [E] (Edit Indicator) will appear on the top left corner of the LCD display. This indicates that the current program has been modified but not yet stored. If you wish to store your sound obtained by edit operation, be sure to store the current program to internal User memory in the Store mode before selecting another program.

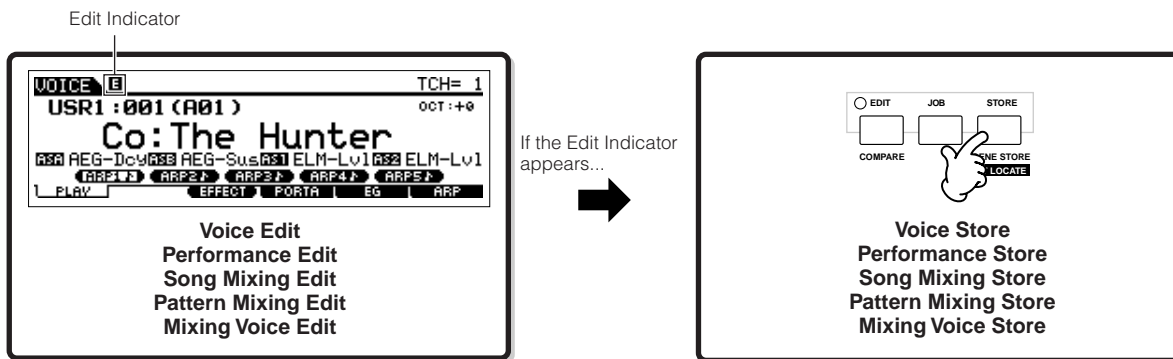

Compare Function

This convenient function lets you switch between the edited sound and its original, unedited condition—allowing you to listen to the difference between the two and better hear how your edits affect the sound.

For example, when editing a Voice in the Voice Edit mode, the "E" Edit indicator is shown. Pressing the [COMPARE] button in this condition reverts to the original unedited sound (the button lamp flashes and the "C" Compare indicator is shown). Press the [COMPARE] button again to return to the edited sound.

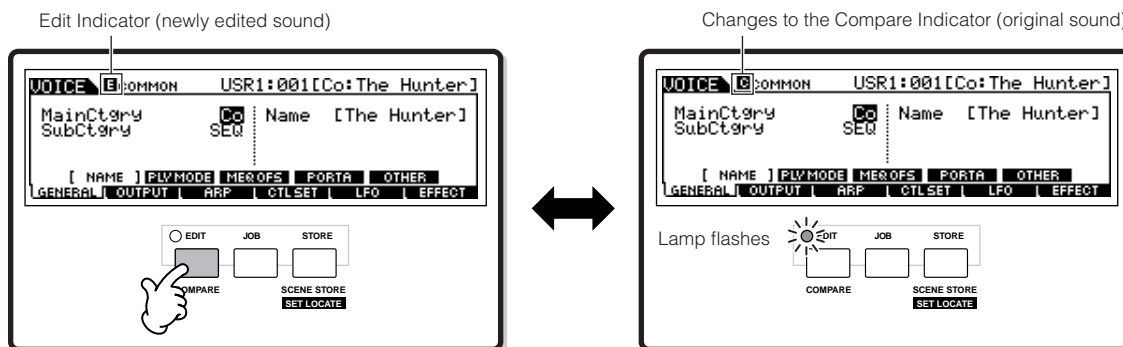

Edit Recall Function

If you are editing a program and select a different program without storing your edited one, all the edits you've made will be erased. However, the edited program is maintained in a backup memory location called the Recall buffer (page 150). To restore the lost data with your latest edits intact, use the Edit Recall function in the Job mode.

Job mode	How to call up the Edit Recall display
Voice	[VOICE] → [JOB] → [F2] RECALL
Performance	[PERFORM] → [JOB] → [F2] RECALL
Song Mixing	[SONG] → [MIXING] → [JOB] → [F2] RECALL
Pattern Mixing	[PATTERN] → [MIXING] → [JOB] → [F2] RECALL
Mixing Voice	[SONG] or [PATTERN] → [MIXING] → [F5] VCE ED → [JOB] → [F2] RECALL

Confirmation Message

When you execute certain operations, such as those in the Job, Store, and File modes, this synthesizer shows a confirmation message. This lets you actually execute the operation or cancel it if desired.



If a confirmation message (like the one illustrated above) appears, press the [INC/YES] button to execute the operation or press the [DEC/NO] button to cancel it.

Information Display

This convenient function lets you call up relevant details about the selected mode—simply by pressing the [INFORMATION] button. For example, when the Voice mode is active, you can quickly check information about which voice bank is selected, what Play mode (poly or mono) is being used, which effects are applied, and so on.

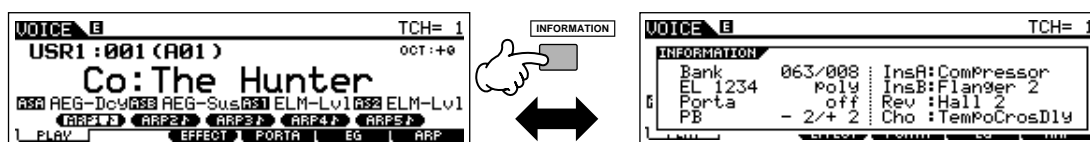

For details, see page 219.

Note (Key) settings

Several parameters let you set a key range for a function—for example, in setting up a keyboard split—by specifying certain note values. You can use the [INC/YES] and [DEC/NO] buttons or data dial to set these parameters, or you can directly enter the values from the keyboard by pressing the appropriate keys (as shown below).

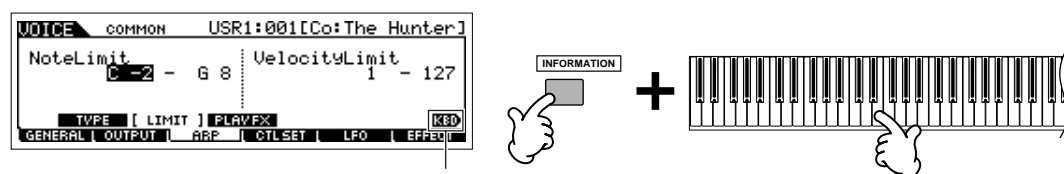

When Note Limit is selected, the [KBD] mark appears, indicating that you can use the keyboard to set the value. Simultaneously hold down the [INFORMATION] button and press the appropriate key.

NOTE For details on the note names assigned to the keys, see page 14.

Naming

You can freely name your created data such as Voices and files saved to the USB storage device. The chart below lists the types of data that can be named along with the operations for calling up the respective naming displays.

Data types that can be named	How to call up the naming display	Page
Voice	[VOICE] → [EDIT] → [F1] GENERAL → [SF1] NAME	153
Performance	[PERFORM] → [EDIT] → [F1] GENERAL → [SF1] NAME	172
Song	[SONG] → [JOB] → [F6] SONG → 04: Song Name	189
Pattern	[PATTERN] → [JOB] → [F6] PATTERN → 05: Pattern Name	202
Mixing Template	[SONG] or [PATTERN] → [MIXING] → [STORE]	192
Mixing Voice	[SONG] or [PATTERN] → [MIXING] → [F5] VCEED → [F1] GENERAL → [SF1] NAME	203
Phrase	[PATTERN] → [JOB] → [F4] PHRASE → 09: Phrase Name	200
Master	[MASTER] → [EDIT] → [F1] NAME	216
Arpeggio	[SONG] → [JOB] → [F5] TRACK → 07: Put Track To Arp	188
	[PATTERN] → [JOB] → [F5] TRACK → 06: Put Track To Arp	201
Volume Label of the USB storage device	[FILE] → [F1] CONFIG → [SF2] FORMAT	211
File/Folder saved to the USB storage device	[FILE] → [F2] SAVE or [F4] RENAME	211

First, call up the name input display according to the above table, then, move the cursor by using the Cursor buttons to the desired location and input a character. See below for details.

NOTE Since the name of the program is part of the data, make sure that you properly save the program after naming it.

Basic naming operation

As shown below, you can set the name by repeating the two operations—moving the cursor to the desired location by using the Cursor buttons and selecting a character by using the data dial, [INC/YES] button, and [DEC/NO] button.

Moving the cursor to the desired location on the name

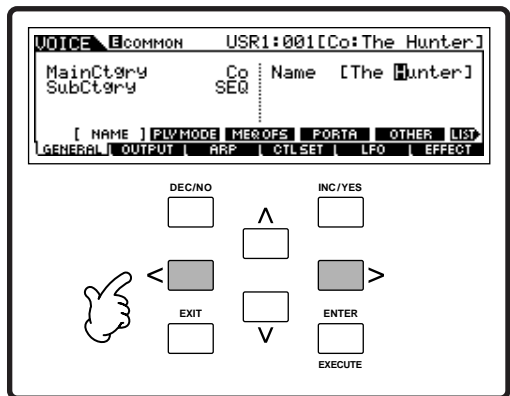

Selecting a character at the cursor location

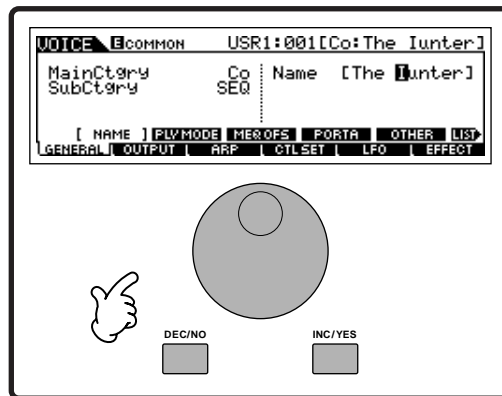

■ Using the character list

If you find it difficult to select the desired characters with the above method, you may want to use the following method—selecting the characters from a list.

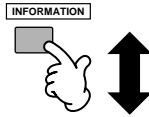
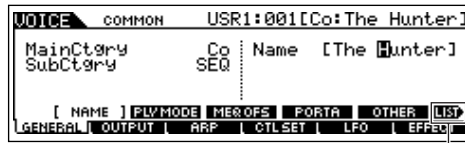

When the cursor is located at the Name, this [LIST] icon appears and you can call up the Character List display by holding the [INFORMATION] button. Release the [INFORMATION] button to return back to the original display.

Perform the operations below while holding the [INFORMATION] button.

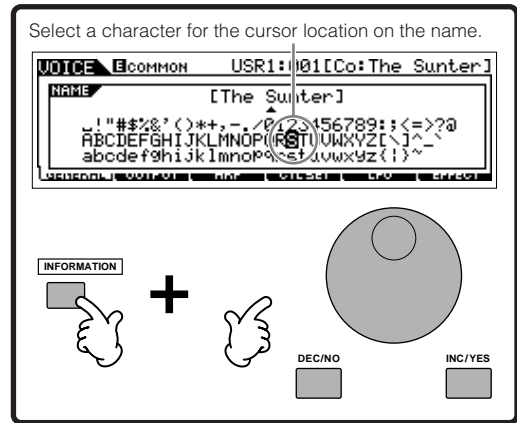
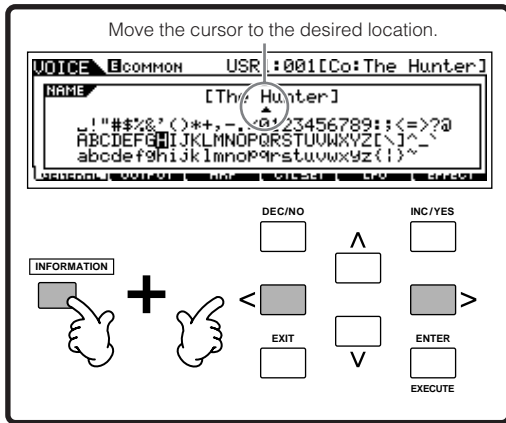

Quick Guide

Playing the MO

Voice Play mode

The Voice Play mode is where you select and play the instrument sounds (voices) of this synthesizer.

Selecting a Normal Voice

Internally, there are two Voice Types: Normal Voices and Drum Voices. Normal Voices are mainly pitched musical instrument type sounds that can be played over the range of the keyboard. Drum Voices are mainly percussion/drum sounds that are assigned to individual notes on the keyboard. In this section, we'll show you how to select a Normal Voice. You can select the desired Voice from various Voice Banks (Preset 1 – 4, User 1 – 2, GM preset) as shown.

Voice Bank

User Bank

Contains the voices you've created in the Voice Edit mode.

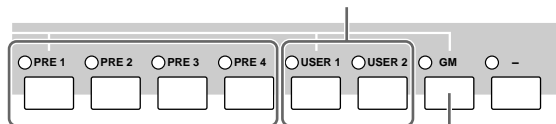

Preset Bank

Contains the Voices built into this instrument.

GM Preset Bank

Contains the voices allocated according to the GM standard. For details, see page 132.

1 Press the [VOICE] button to enter the Voice Play mode.

In this condition, playing the keyboard sounds the Voice indicated in the display. The parameters shown in the Voice Play mode are briefly explained below.

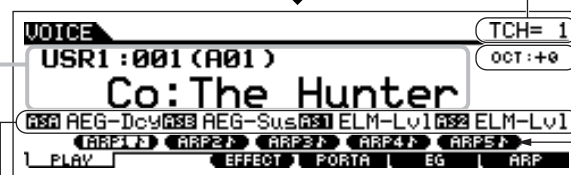
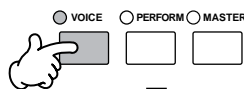

Indicates the Keyboard MIDI transmit channel. See page 43 for details.

Indicates the Keyboard Octave setting. See page 29 for details.

ARP1 – ARP5
Use the [SF1] – [SF5] buttons to call up the Arpeggio type assigned to each button (page 48).

Indicates the functions assigned to the respective Knobs. See page 56.

Indicates the currently selected voice.

Bank and Voice Program number

USR1 : 001 (A01)

Bank
(selected via the buttons)

Number
(selected via the Number [1] – [16] buttons)

Group
(selected via the Group [A] – [H] buttons)

Voice Program number
(corresponding to Groups A to H and Numbers 01 to 16)

Category and Voice name

Co : The Hunter

Category

Voice name

NOTE Keep in mind that the example displays shown in this manual are for instruction purposes only, and the contents (for example, the Voice name here) may differ slightly from those on your instrument.

2 Select a Normal Voice Bank.

Select one of the Banks from Preset 1 – 4, User 1 – 2, and GM.

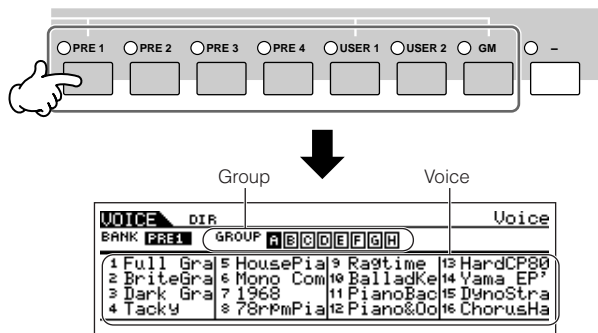

About the User Banks

The User Banks contain various factory default Voices.

User Bank 1 (USR1): This Bank contain original Voices for the User Bank. The same Voices are not included in the Preset Banks.

User Bank 2 (USR2): This Bank contains recommended Voices copied from the Preset Banks.

If a Voice in a User Bank (User Voice) is overwritten or replaced, that User Voice will be lost. When you save an edited Voice, be careful not to overwrite any important User Voices.

3 Select a Normal Voice Group.

Voices in each Bank are divided into Groups [A] – [H].

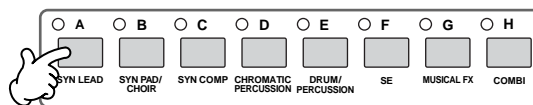

4 Select a Normal Voice Number.

Press one of the Number [1] – [16] buttons.

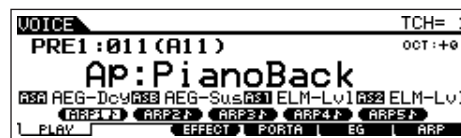
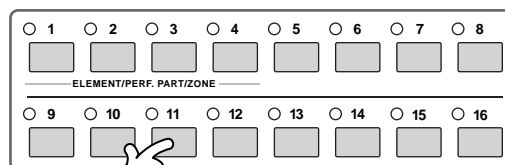

5 Play the keyboard.



Selecting a Drum Voice

1 Press the [VOICE] button to enter the Voice Play mode.

2 Select a Drum Voice Bank.

While holding the [DRUM KITS] button, press one of the following buttons: [PRE 1] (Preset Drum), [USER 1] (User Drum), or [GM] (GM Drum).

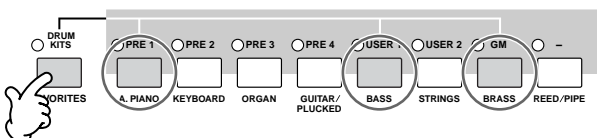

3 Select a Drum Voice Group.

This operation is basically the same as in selecting a Normal Voice. The numbers of Groups that you can select depends on the Bank you've selected in step 2.

4 Select a Drum Voice Number.

This is the same as in selecting a Normal Voice.

5 Play the keyboard and check which instrument is assigned to each key.

NOTE For details about the instrument assignments for each key, refer to the separate Data List.

Using the [INC/YES], [DEC/NO] buttons and data dial

In steps 3 and 4 above, you can select a Voice Number by using the [INC/YES], [DEC/NO] buttons and data dial.

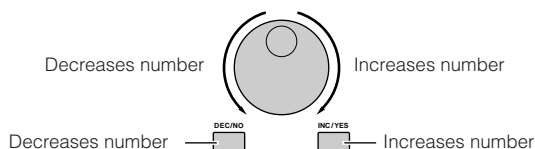

Using the Category Search function

You'll probably have a lot of fun and inspiration going through the Voices one-by-one, listening to each in order—but it will take you a long time to get through all of them, since the MO has so many. This is where the Category Search function comes in handy. It's a powerful and easy-to-use way to quickly find the Voices you want. Let's try out the feature below, searching for a Voice in the Pipe Organ category.

Quick Guide
Playing the MO

1 Turn the Category Search function on by pressing the [CATEGORY SEARCH] button.

NOTE Press the [CATEGORY SEARCH] button again to turn this function off.

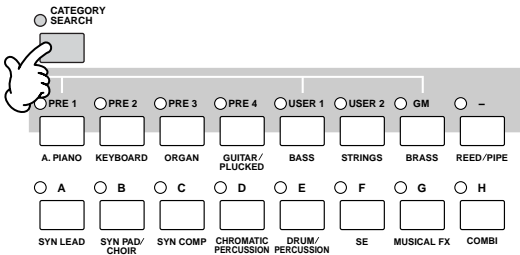

2 Select the Organ Category.

Press the [PRE 3] ORGAN button of the Bank buttons and Group buttons. The Voices in the Organ Category are displayed in a list.

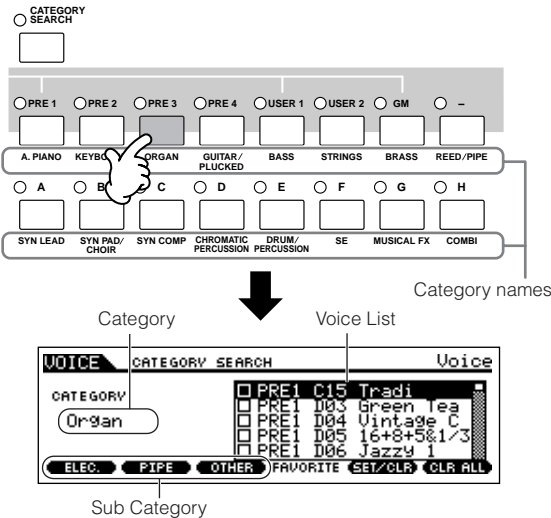

3 Select the 'Pipe Organ' Sub Category.

The Sub Category names are shown at the bottom of the Category Search display. All Categories are divided into two or three Sub Categories for further ease in selection. Here, press the [F2] PIPE button.

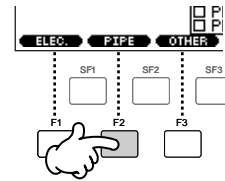

NOTE An alternate way of selecting categories is to use the Cursor buttons to select and highlight the Category name in the display, then use the [INC/YES] and [DEC/NO] buttons or the data dial to select the Category.

NOTE Some Voices such as User Voices may not be registered to any Category. You can search for these Voices by setting the Category to "-----."

4 Select the desired Voice from the 'Pipe Organ' Voice list.

Step through the available Voices by using the data dial. You can also use the [INC/YES] and [DEC/NO] buttons, or use the Cursor [Λ][∇] buttons.

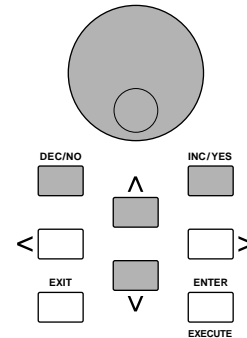

5 Press the [ENTER] button to actually select the Voice.

NOTE You can also use the [CATEGORY SEARCH] button and [EXIT] button to select the Voice.

Favorite Category

The MO also lets you collect and store your favorite Voices to create your personal “Favorite” Category. By putting your most often-used Voices in the Favorite Category, you can select your favorite Voices quickly and easily.

1 Select the Voice using the Category Search function.

2 Register the Voice selected in step 1 to the Favorite Category by pressing the [F5] SET/CLR button, checkmarking the box next to the Voice name.

You can un-checkmark the selection by pressing the [F5] button again.

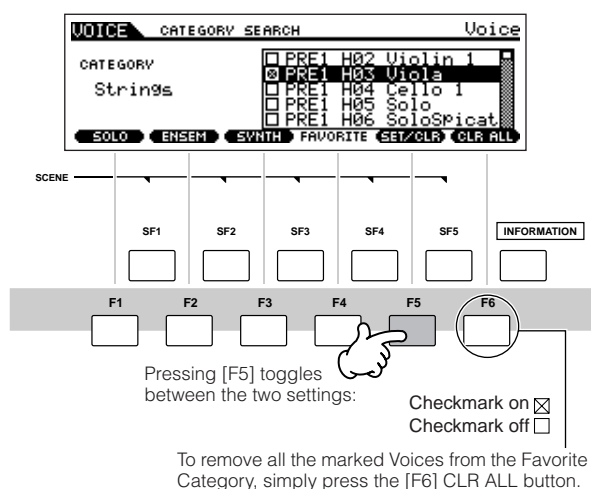

3 Press the [FAVORITES] button to see the Voices you’ve set to the Favorite Category in step 2.

You also can use the [F5] SET/CLR and [F6] CLR ALL buttons in this display to register/remove the voices to/from the Favorite Category.



4 Press the [FAVORITES] button again to return to the Category Search display.

5 Pressing the [CATEGORY SEARCH] button or [EXIT] button will automatically store the Favorite Category settings to internal memory.

CAUTION

The settings made in steps 2 – 3 will be lost if you turn the power off without executing step 5.

CAUTION

Never attempt to turn off the power while an “Executing...” or “Please keep power on” message is shown. Turning the power off in this state may cause the system to freeze and prevent normal startup the next time the power is turned on, as well as resulting in the loss of all user data.

Keyboard MIDI transmit channel setting

This function is especially convenient when recording to an external sequencer or controlling another instrument via MIDI. It lets you easily change the transmit channel with just a couple of button presses. Press the [TRACK SELECT] button (the lamp lights), then press the appropriate Number button ([1] – [16]). The transmit channel setting is shown at the top right of the display.

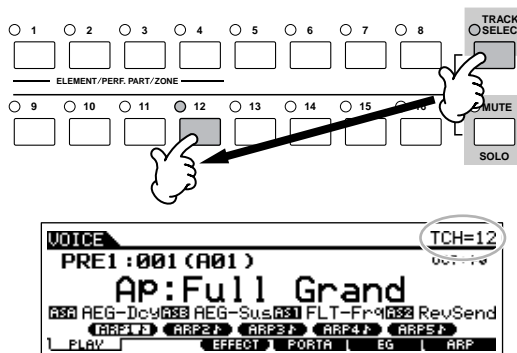

NOTE You can also set the MIDI keyboard transmit channel from the Utility mode ([UTILITY] → [F5] MIDI → [SF1] CH → KBDTransCh). This parameter is available for the Voice mode/Performance mode but not for the Song mode/Pattern mode.

Performance Play mode

Each Performance can contain up to four different Parts. This lets you play, for example, Flute, Violin, and Timpani Voices in a layer across the keyboard, or split the keyboard according to the bass and melody parts, then play the two different instruments and sound like a duo—even though you're playing by yourself.

Selecting a Performance

256 Performances (2 banks) are provided in internal User memory. In the Performance Play mode, you can select and play individual User Performances.

1 Press the [PERFORM] button to enter the Performance Play mode.

In this condition, playing the keyboard sounds the Performance indicated in the display. The parameters shown in the Performance Play mode are briefly explained below.

Quick Guide
Playing the MO

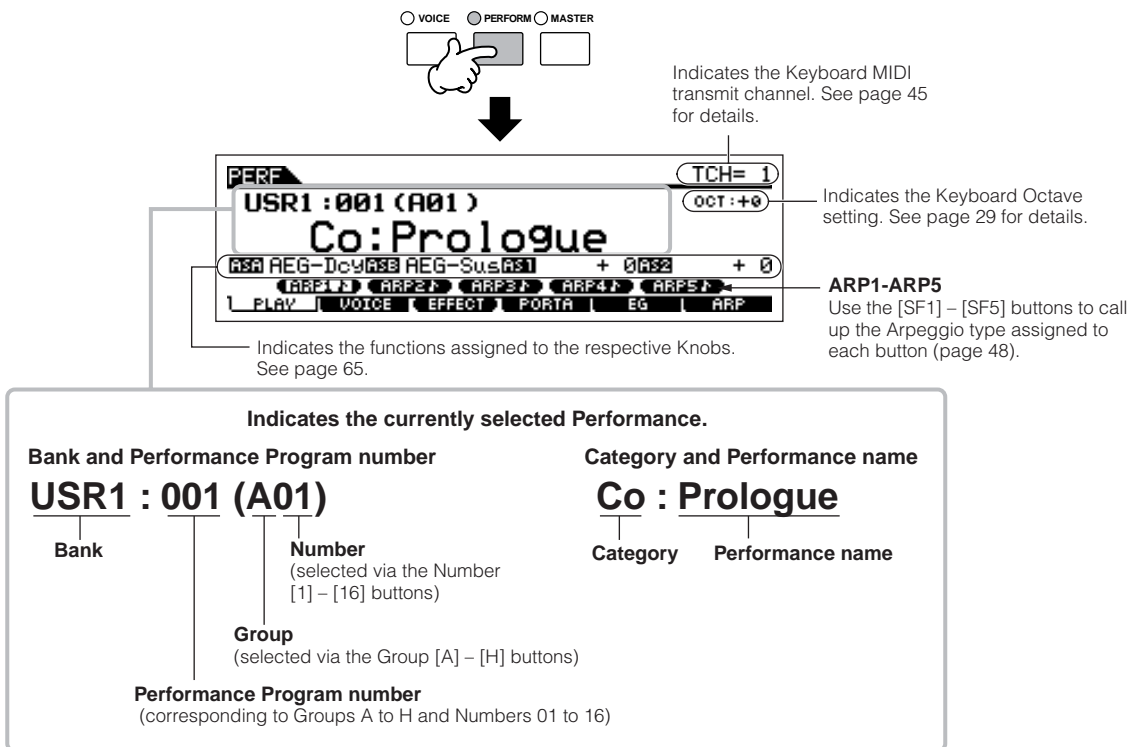

NOTE Keep in mind that the example displays shown in this manual are for instruction purposes only, and the contents (for example, the Performance name here) may differ slightly from those on your instrument.

2 Select a Performance Bank.

Select one of the Banks from User 1 and 2.

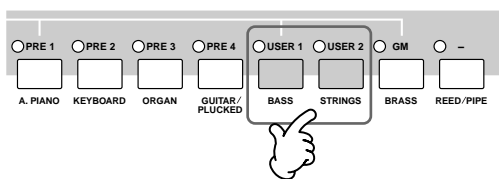

3 Select a Performance Group.

Performances are divided into Groups [A] – [H]. Select a Group to display a list of the Performances.

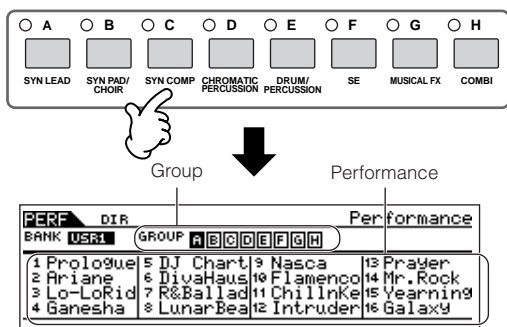

4 Select a Performance Number.

Press one of the Number [1] – [16] buttons.

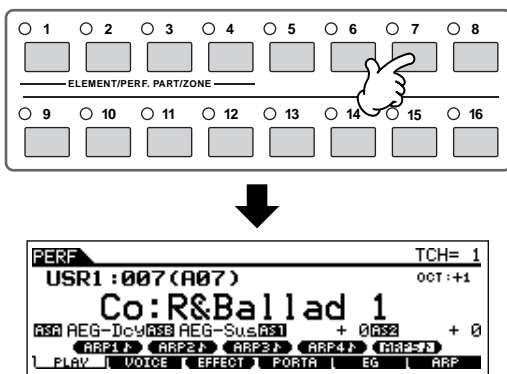

5 Play the keyboard.



Performance Part mute/solo

Each performance can contain a maximum of four Parts, each of which can be turned on or off independently. Muting and soloing of Parts is done in the same way as that of tracks in a Song/Pattern. See page 75.

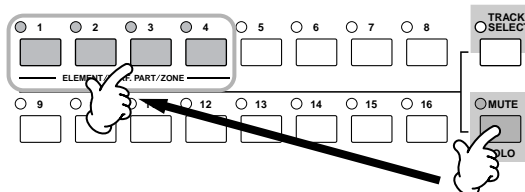

Using the Category Search function

As in the Voice Play mode, you can use the Category Search and Favorite Category functions in the Performance Play mode. For details on how to use the function, see page 42.

Keyboard MIDI transmit channel setting

As in the Voice Play mode, you can change the MIDI transmit channel for the keyboard. Press the [TRACK SELECT] button (the lamp lights), then press the appropriate Number button ([1] – [16]). The transmit channel setting is shown at the top right of the display.

NOTE You can also set the MIDI keyboard transmit channel from the Utility mode ([UTILITY] → [F5] MIDI → [SF1] CH → KBDTransCh). This parameter is available for the Voice mode/Performance mode but not for the Song mode/Pattern mode.

Creating a Performance by combining Voices

Performances can be made up of a maximum of four Parts, each of which can be assigned a different Voice. In this section, we'll create a Performance by combining two Voices.

Preparing to create a Performance (Initializing the Performance)

1 Select the desired Performance in the Performance Play mode.

2 Press the [JOB] button, and then the [F1] button.

The Initialize display is shown. Check the "ALL" check box to initialize all data of the Performance. For details about the Initialize function, refer to page 168.

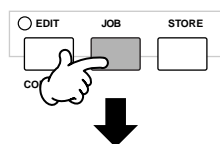

3 Press the [ENTER] button. (The display prompts you for confirmation.)

Press the [INC/YES] button to initialize the Performance.

NOTE Keep in mind that when you execute the Store operation by pressing the [STORE] button here, the Performance at the destination will be replaced with the Initialized Performance above.

NOTE For details about the Store operation, refer to page 66.

4 Press the [PERFORM] button.

The current Performance name will change to "Init Perf" in the display.

NOTE When you initialize a Performance, the Voice at Preset Bank 1, Voice number 1 is assigned to Part 1 as the default.

Playing several Voices together (Layer)

5 Press the [F2] VOICE button.

This calls up a list indicating which Voice is assigned to each Part of the current Performance.

Since the current Performance has been initialized, the only Voice in the Performance is "PRE1: Full Grand," set to Part 1.

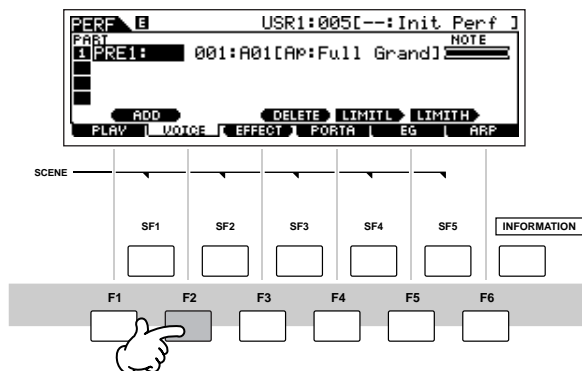

6 Assign the desired Voice to Part 2.

6-1 Move the cursor to the Voice Bank or Voice Number of Part 2.

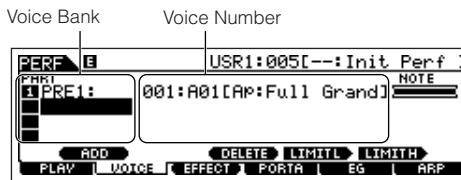

6-2 Press the [SF1] ADD INT button. This enables assignment of the selected internal Voice to Part 2.

6-3 Select the Voice you've assigned to Part 2 as you did in steps 2 – 4 in the section "Selecting a Normal Voice" or "Selecting a Drum Voice" (page 40 or 41).

You can select the desired Bank and Number directly by using the [DEC/NO], [INC/YES] buttons and data dial. You can also use the Category Search function (page 42). Here, we'll assign a flute Voice (PRE2: SweetFlute) to Part 2.

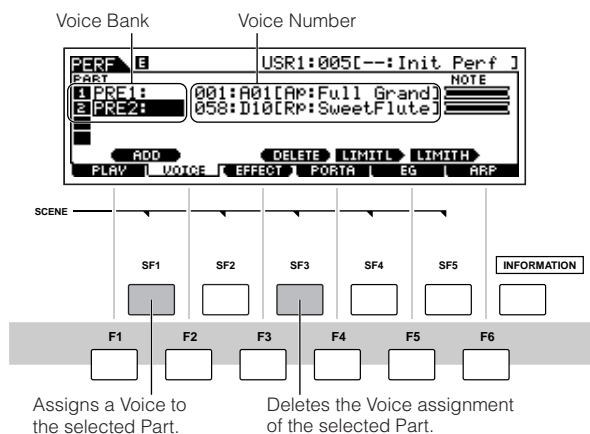

7 Play the keyboard.

The Part 1 (piano Voice) and Part 2 (flute Voice) can be played in unison.

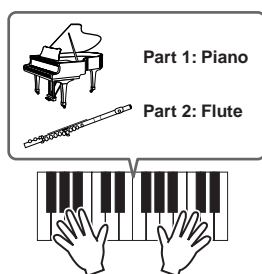

Next, we'll divide the keyboard into two sections—one for each Voice.

Dividing the keyboard into separate sections—Split

8 Assign the Voice of Part 1 to the lower key range.

8-1 Move the cursor to Part 1.

8-2 Press a note on the keyboard while holding down the [SF5] LIMIT H button to set the highest note for Part 1.

Note that the dark bar (at "NOTE") for Part 1 changes as the note range is changed.

9 Assign the Voice of Part 2 to the higher key range.

9-1 Move the cursor to Part 2.

9-2 Press a note on the keyboard while holding the [SF5] LIMIT L button down to set the lowest note of Part 2.

Note that the dark bar (at "NOTE") for Part 2 changes as the note range is changed.

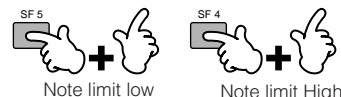
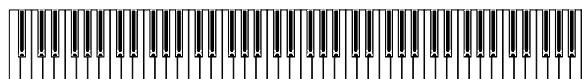

10 Play the keyboard.

Use your left hand to play piano sounds and your right hand to play flute sounds.

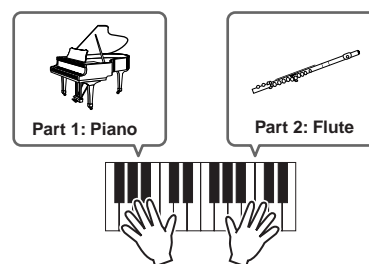

Adjusting the Part levels and storing the Performance

11 Adjust the Volume settings of Parts 1 and 2 by using the Control sliders.

For details, see page 52.

12 Store the settings as a User Performance in the Performance Store mode.

For details about the Store operation, see page 66.

NOTE If you are editing a program and you select a different program without storing your edited one, all the edits you've made will be erased.

In the section above, you learned how to assign two Voices to two different Parts. Use same procedure to assign Voices to Parts 3 and 4, and create a full orchestral sound or the sound of a 3- or 4-piece band—just by using a single MO. You can also use the preset Performances as starting points in building your own custom Voice combinations.

Using the Arpeggio feature

The versatile Arpeggio feature allows you to automatically play various rhythms and phrases by simply pressing a key or playing a chord. The MO contains a remarkably wide variety of Arpeggios—a total of 1,787—from conventional, popular phrases to the latest cutting-edge rhythm patterns. In addition, you can assign your favorite Arpeggios to the [SF1] – [SF5] buttons and switch between Arpeggio phrases instantly. This powerful function is an unending source of inspiration and will help you create various riffs, phrases and songs quickly and easily.

Since the preset Voices and Performances already have their own Arpeggio types pre-assigned, all you need to do is select the desired Voice and turn on the Arpeggio function.

NOTE For details about Arpeggio, see page 145.

NOTE The Arpeggio feature is also available in the Song and Pattern modes. For details, see page 79.

NOTE Different Arpeggio types cannot be played back for each Part in the Performance, Song, or Pattern mode.

1 Press the [ARPEGGIO ON/OFF] button to turn Arpeggio on.

Selecting some programs (Voices, Performances, Songs, Patterns) automatically turns this lamp on.

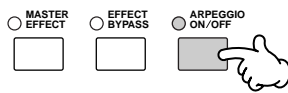

2 Play a note or notes on the keyboard to trigger the Arpeggio playback.

The particular rhythm pattern or phrase that plays depends on the actual notes or chords you play, as well as on the selected Arpeggio type. For details, see page 145 in the Basic Structure section.



Changing the Arpeggio type during your keyboard performance

A different Arpeggio type is assigned to each of the [SF1] ARP1 – [SF5] ARP5 buttons for each preset Voice. When a musical note icon appears to the right of each Arpeggio number in the display (see below), the corresponding button is assigned an Arpeggio type. The selected Arpeggio type is highlighted.

Try out various Arpeggio types by pressing the [SF1] – [SF5] buttons.

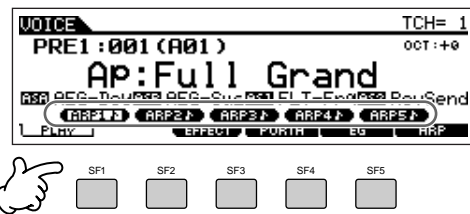

You can confirm the currently selected Arpeggio type in the [F6] ARP display.

Arpeggio type currently selected.

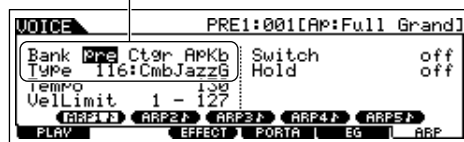

Bank	Selects "pre" (Preset) or "usr" (User).
Ctr	For details, refer to page 145.
Type	For details, refer to the separate Data List booklet.

Register your favorite Arpeggio types to the [SF1] – [SF5] buttons

You can change the default settings and assign any Arpeggio types you like to the [SF1] – [SF5] buttons.

- 1** Select the desired **Voice, Performance, Song, or Pattern**, and then press the [ARPEGGIO] button to turn Arpeggio on.
- 2** Select the desired Arpeggio type in the [VOICE] → [F6] (or [F5]) ARP display.
- 3** While holding the [STORE] button, press one of the [SF1] – [SF5] buttons.
The currently selected Arpeggio type is assigned to the pressed button. If you execute this operation with the [ARPEGGIO] lamp off, no Arpeggio type will be assigned to the pressed button.
- 4** Repeat steps 2 – 3 as necessary.
- 5** Store the changes as a **User Voice, Performance, Song, or Pattern** (pages 60, 66, 99).

TIP Transmitting Arpeggio playback as MIDI data

If you want to use the Arpeggios to trigger other MIDI tone generators or record the MIDI data of Arpeggios to a sequencer for further editing, you can have the Arpeggio playback data transmitted as MIDI data.

This is done by setting the following switch parameters to “on”:

● Voice Arpeggio

Voice mode → [UTILITY] → [F3] VOICE → [SF3] ARP CH → OutputSwitch

● Performance Arpeggio

Performance mode → Performance selection → [EDIT] → [COMMON] → [F3] ARP → [SF4] OUT CH → OutputSwitch

● Song/Pattern Arpeggio

Song mode/Pattern mode → Song/Pattern selection → [MIXING] → [EDIT] → [COMMON] → [F3] ARP → [SF4] OUT CH → OutputSwitch

Controlling Arpeggio playback by using the Knobs.

These four Knobs let you adjust the tempo and volume of Arpeggio playback. If you like the results and want to save them, you can store the changes as a User Voice, Performance, Song, or Pattern.

- 1** Press the [ARP FX] button to turn the lamp on.

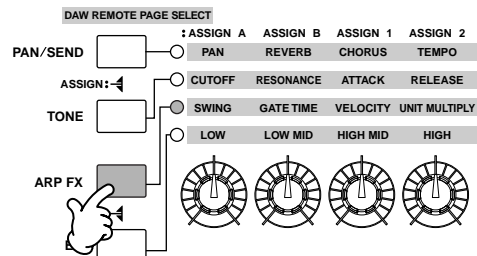

- 2** Tweak the knobs while the Arpeggio is playing.
For details on the functions controlled by the Knobs, see page 51.
- 3** If you're satisfied with the results, store the changes as a **User Voice, Performance, Song, or Pattern** (pages 60, 66, 99).

Using the Controllers on the MO

This section shows you how to change the sounds by using the controllers on the MO. When using the external controllers, see page 69.

Pitch Bend Wheel

Use the Pitch Bend wheel to bend notes up (roll the wheel away from you) or down (roll the wheel toward you) while playing the keyboard. The Pitch Bend wheel is self-centering and will automatically return to normal pitch when released. Try out the Pitch Bend wheel while pressing a note on the keyboard.

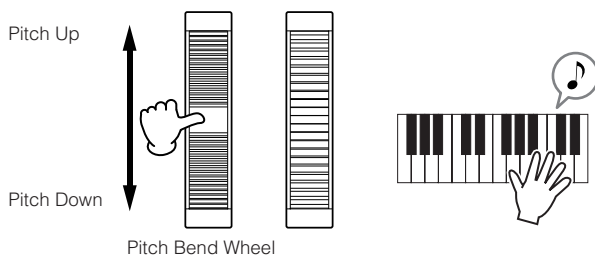

When playing a Performance, the Pitch Bend Range depends on the setting of the Voice assigned to each Part (made in the Voice mode).

- NOTE**
- The Pitch Bend Range setting for each Voice can be changed in the "OTHER" display ([VOICE] → [EDIT] → [COMMON] → [F1] GENERAL → [SF5] OTHER) and stored as a User Voice in the Voice Store mode.
 - The Pitch Bend Range setting also allows you to set the wheel to bend notes up or down in the opposite direction (i.e., the pitch goes down when you move the wheel up).

NOTE Functions other than Pitch Bend can be assigned to the Pitch Bend Wheel in the "CTL SET" display ([VOICE] → [EDIT] → [COMMON] → [F4] CTL SET). These assignment settings can be stored as a User Voice in the Voice Store mode. Even if a different function is assigned to this wheel, the Pitch Bend function is available and Pitch Bend messages are still generated when the wheel is used.

Modulation Wheel

Even though the Modulation wheel is conventionally used to apply vibrato to the sound, many of the preset Voices have other functions and effects assigned to the wheel. The more you move this wheel up, the greater the effect that is applied to the sound. Try out the Modulation wheel with various preset voices while playing the keyboard.

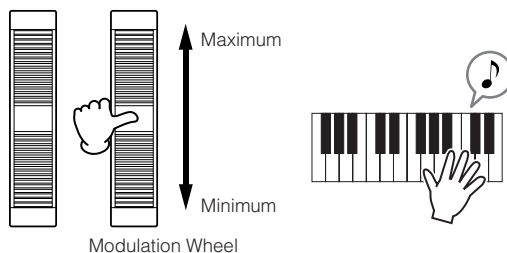

When playing a Performance, the effect of the Modulation Wheel depends on the setting of the Voice assigned to each Part (made in the Voice mode).

NOTE To avoid accidentally applying effects to the current Voice, make sure the Modulation Wheel is set to minimum before you start playing.

NOTE Various functions can be assigned to the Modulation Wheel in the "CTL SET" display ([VOICE] → [EDIT] → [COMMON] → [F4] CTL SET). These assignment settings can be stored as a User Voice in the Voice Store mode.

Knob

Changing the sounds

You can change the brightness and tone characteristics of the current Voice, Performance, Song or Pattern in realtime by turning the knobs while you play. Rotating it to the right (clockwise) increases the program number, while rotating it to the left (counter-clockwise) decreases it. You can select the function set assigned to the knobs among the following seven sets by pressing the appropriate Control function button.

Function sets assigned to the Knobs

Operation	Button of which the lamp is turned on	Functions controlled by each Knob			
		KN1 (Knob 1)	KN2 (Knob 2)	KN3 (Knob 3)	KN4 (Knob 4)
When pressing the [PAN/SEND] button	[PAN/SEND] button	Pan (stereo position) of the Voice/Performance	Reverb Send Level	Chorus Send Level	Tempo of the Song/Pattern/Arpeggio playback
When pressing the [TONE] button	[TONE] button	Filter Cutoff Frequency (degree of brightness)	Resonance (the level of the signal in the area of the cutoff frequency)	Attack Time of the sound	Release Time of the sound (decay time after the key is released)*
When pressing the [ARP FX] button	[ARP FX] button	Swing degree of the Arpeggio playback	Gate time (length) of the Arpeggio playback	Velocity of the Arpeggio playback	Arpeggio playback time
When pressing the [EQ] button	[EQ] button	Low band of the Master EQ in the Voice/Performance mode, part EQ in the Song/Pattern mode	Low-mid band of the Master EQ in the Voice/Performance mode, Mid band of the Part EQ in the Song/Pattern mode	High-mid band of the Master EQ in the Voice/Performance mode. (Not available in the Song/Pattern mode.)	High band of the Master EQ in the Voice/Performance mode, part EQ in the Song/Pattern mode
When pressing the [PAN/SEND] button and the [TONE] button simultaneously	[PAN/SEND] button [TONE] button	Function assigned from the [UTILITY] → [F4] CTLASN → [SF2] ASSIGN display (page 208) in the Utility mode		Function assigned for each Voice from the [VOICE] → [EDIT] → [COMMON] → [F4] CTLSET display (page 155)	
When pressing the [TONE] button and the [ARP FX] button simultaneously**	All the buttons are off	Function assigned for each Master from the [MASTER] → [EDIT] → Zone selection → [F5] KN/CS display (page 217)			
When pressing the [ARP FX] button and the [EQ] button simultaneously	[ARP FX] button [EQ] button	Function assigned to the Master Effect parameters from the [UTILITY] → [F4] CTLASN → [SF5] MEF display.			

* For Drum Voices, this affects the release time for all played notes, whether held or released.

** Available only when setting the Zone Switch to on in the Master Mode (page 215)

When pressing any of the Control function buttons, the lamp(s) of the buttons will light according to the above table, and the status of the Knobs and Control sliders (currently assigned functions and set values) is shown on the LCD display. The appearance of the knob and slider in the display indicates the actual control status of the knob and slider.

When a knob graphic in the display is black or a slider graphic is shown with a shadow, the corresponding Knob or Control slider on the panel affects the sound as indicated.

A white knob graphic or a slider graphic without a shadow indicates that the current Knob or Control slider position differs from the actual parameter value. In this case, moving the knob or slider does not affect the sound until the knob or slider position reaches the parameter's current value (after which the knob graphic turns black or the slider graphic has a shadow).

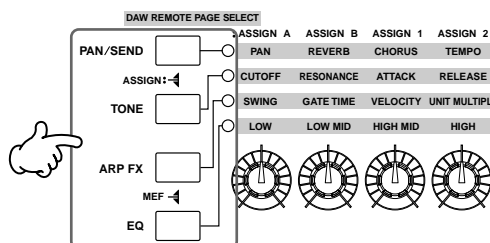

Adjusting these knobs/sliders affects the sound immediately.

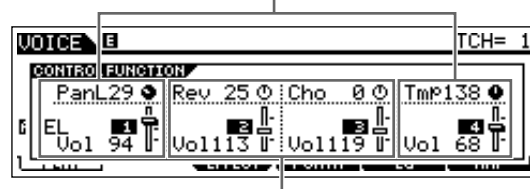

Adjusting these knobs/sliders will not affect the sound until the current value is reached.

Control slider

Changing the volume

You can adjust the volume of the Voice/Performance you play on the keyboard, or the volume of the specified part (track) of the Song/Pattern by using the Control sliders. In the Master mode, various functions as well as the volume can be assigned to the Control sliders when the Zone Switch is set to on (page 215).

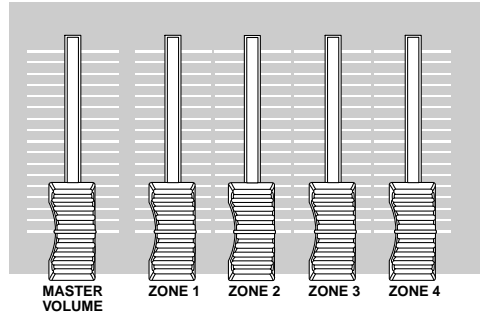

Function sets assigned to the Control slider

Mode		Functions controlled by each slider			
		Control slider 1	Control slider 2	Control slider 3	Control slider 4
Voice mode	When a Normal Voice is selected	Element 1 Volume	Element 2 Volume	Element 3 Volume	Element 4 Volume
	When a Drum Voice is selected	Volume of the entire Voice sound (moving any slider produces same volume)			
Performance mode		Controls Volume of the assigned Parts (see "Precautions" note below).			
Song mode/ Pattern mode	When tracks (Parts) 1 – 4 are selected	Track 1 (Part 1) Volume	Track 2 (Part 2) Volume	Track 3 (Part 3) Volume	Track 4 (Part 4) Volume
	When tracks (Parts) 5 – 8 are selected	Track 5 (Part 5) Volume	Track 6 (Part 6) Volume	Track 7 (Part 7) Volume	Track 8 (Part 8) Volume
	When tracks (Parts) 9 – 12 are selected	Track 9 (Part 9) Volume	Track 10 (Part 10) Volume	Track 11 (Part 11) Volume	Track 12 (Part 12) Volume
	When tracks (Parts) 13 – 16 are selected	Track 13 (Part 13) Volume	Track 14 (Part 14) Volume	Track 15 (Part 15) Volume	Track 16 (Part 16) Volume
Master mode	When the Zone Switch is set to on (page 215)	Function assigned for each Master from the [MASTER] → [EDIT] → Zone selection → [F5] KN/CS display (page 217)			

* An Element is the fundamental tone generating unit of a Voice. For details, see page 53.

NOTE The [MASTER VOLUME] slider adjusts the overall output level of the instrument, while the Control sliders adjust the MIDI Volume setting of the corresponding Element or Part.

NOTE Precautions—Using sliders in the Performance mode

In the Performance mode, the Control sliders are assigned according to the specific Parts that are assigned in each Performance. Keep in mind that the slider number may not correspond to the same numbered Part.

For example, when using a Performance (as shown at right) in which two Parts (Part 1 and Part 4) are combined, the sliders are assigned as follows:

- Slider 1 controls the volume of Part 1.
- Slider 2 controls the volume of Part 4.
- Sliders 3 and 4 are not used.



Edit Indicator

Moving the sliders directly changes the parameters of the Voice, Performance, Song, or Pattern. When any of the parameters are changed, the [E] (Edit) Indicator appears in the top left of the display. This indicates that the current Voice, Performance, Song, or Pattern has been modified but not yet stored. For details about the Edit indicator, see page 36.

Editing a Program

Editing a Voice

Each Voice can consist of up to four Elements. An Element is made up of a basic waveform—the basic sound of a musical instrument—plus the various synthesizer processing parameters used to enhance, alter or define the sound, such as pitch, filter, and amplitude controls.

For example, a piano Voice can be actually made up of several different piano waveforms: one for high notes, one for low notes, and waveforms for when the keyboard is played softly. Combining different elements in a set for playing at same time, or programming them to switch depending on how strongly the keyboard is played helps to create a much more powerful and realistic piano sound.

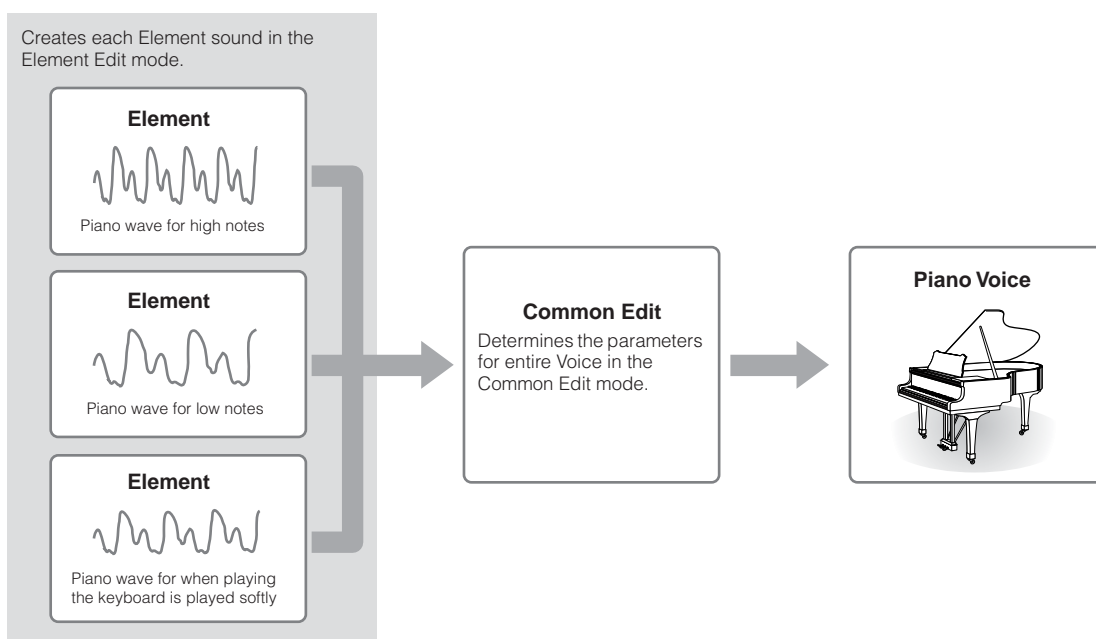

NOTE A Drum Voice is made up of different “Keys”—or separate percussion/drum sounds that are assigned to individual notes on the keyboard.

Normal Voice Edit

1 Press the [VOICE] button to enter the Voice mode, then select a Normal Voice to be edited (page 40).

2 Press the [EDIT] button to enter the Voice Edit mode.

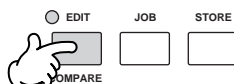

3 Call up the Common Edit display or Element Edit display.

If you wish to edit the sounds that make up a Voice and the basic parameters that determine the sound—such as Oscillator, Pitch, Filter, Amplitude, and EG (Envelope Generator)—call up the Element Edit display.

If you wish to edit more global parameters related to the overall Voice and how it's processed—such as Arpeggio, Controller, and Effects—call up the Common Edit display.

While in the Voice Edit mode, you can switch between the Common Edit display and the Element Edit display as shown below.

Calling up the Common Edit display
Press the [COMMON] button to call up the Common Edit display.
In the Edit mode, the [DRUM KITS] button functions as the [COMMON] button.

Indicates a Common Edit display.

```

        VOICE COMMON PRE1:001[AP:Full Grand]
        MainCtgrY A.PIANO AP Name [Full Grand]
        SubCtgrY
        [ NAME ] [ ELEM MODE ] [ MERGE OF ] [ PORTA ] [ OTHER ] [ LIST ]
        [ GENERAL ] [ OUTPUT ] [ ARP ] [ CTL SET ] [ LFO ] [ EFFECT ]
    
```

Calling up the Element Edit display
Press the desired element number from the ELEMENT [1] – [4] buttons to call up the Element Edit display.

Indicates the display for editing Element 1.

```

        VOICE EL1 PRE1:001[AP:Full Grand]
        Element on WaveNo. 0003
        MainCtgrY
        SubCtgrY [AP:GrndStS ]
        [ WAVE ] [ OUTPUT ] [ LIMIT ]
        [ OSC ] [ PITCH ] [ FILTER ] [ AMP ] [ LFO ] [ EG ]
    
```

To turn each Element on or off (to hear how each affects the overall sound), use buttons [9] – [12]. You can also isolate or solo an Element by holding down the [MUTE] button and pressing the desired number button ([9] – [12]). To cancel the solo, press the [MUTE] button again.

4 Select the menu you wish to edit by pressing the [F1] – [F5] buttons and [SF1] – [SF5] buttons, then edit the parameters in each display.

The following briefly describes the main Voice parameters.

● Basic parameters for creating a sound Page 132

Element selection → [F1] – [F6]

If you wish to edit the basic sound-generating and soundshaping parameters for the Voice—such as Oscillator, Pitch, Filter, Amplitude, and EG (Envelope Generator)—use the Common Edit display.

● Effect related parameters Page 140

[COMMON] → [F6] EFFECT

The Effects use DSP (Digital Signal Processing) to alter and enhance the sound of a Voice. Effects are applied in the final stages of editing, letting you change the sound of the created Voice as desired. The Common Edit display lets you edit the Effect related parameters.

● Controller related parameters Page 70

[COMMON] → [F4] CTL SET (Controller Set)

For each Voice, you can assign various functions to built-in controllers such as Pitch Bend Wheel, Modulation Wheel, Knobs (ASSIGN1 and 2), and optionally connected controllers such as Footswitch and Foot Controller. These settings can be edited in the Common Edit display.

● Arpeggio related parameters Pages 145, 154

[COMMON] → [F3] ARP (Arpeggio)

For each Voice, you can set the Arpeggio related parameters such as Arpeggio type and playback tempo. These can be edited in the Common Edit display.

5 Repeat steps 3 – 4 as desired.

6 Name the edited Normal Voice.

Enter a name for the Voice from the NAME display ([COMMON] → [F1] GENERAL → [SF1] NAME). For detailed instructions on naming a Voice, refer to page 38.

Enter the desired Voice name

```

        VOICE COMMON PRE1:001[AP:Full Grand]
        MainCtgrY AP Name [Full Grand]
        SubCtgrY A.PIANO
        [ NAME ] [ ELEM MODE ] [ MERGE OF ] [ PORTA ] [ OTHER ] [ LIST ]
        [ GENERAL ] [ OUTPUT ] [ ARP ] [ CTL SET ] [ LFO ] [ EFFECT ]
    
```

7 Store the settings as a User Voice.

The edited Voice can be stored in the Voice Store mode. For details, see page 60.

TIP The Compare Function

You can compare the sound of the original (unedited) Voice with the edited Voice. For details, see page 36.

TIP To solo an Element for editing

This feature is useful for isolating the sound of single Element, for ease in editing.

- 1 In the Normal Voice Edit mode, simultaneously hold down the [MUTE] button and press one of the Number buttons [9] to [12] to solo the corresponding Element.**

Once you've selected an Element for soloing, the [MUTE] button's lamp flashes, indicating the Solo function is active and only the selected Element can be edited.

In this example, only Element 3 is turned on and can be edited.

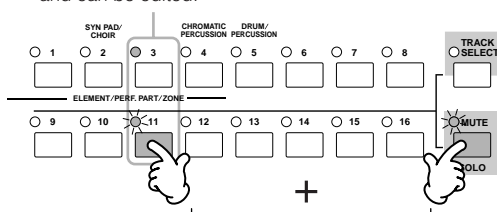

- 2 To solo another Element, simply press the appropriate number button ([9] – [12]).**
- 3 To exit from the Solo function, press the [MUTE] button again.**

TIP Edit Recall

If you are editing a Voice and select a different Voice without storing the one you were editing, all the edits you've made will be erased. If this happens, you can use Edit Recall to restore the Voice with your latest edits intact.

- 1 Press the [JOB] button in the Voice mode to enter the Voice Job mode.**
- 2 Press the [F2] RECALL button to call up the Recall display.**
- 3 Press the [ENTER] button. (The display prompts you for confirmation.)**
If you wish to cancel the operation, press the [DEC/NO] button.
- 4 Press the [INC/YES] button to execute Edit Recall to restore the Voice.**

TIP Editing a Voice by using the Knobs

The four knobs at the top left of the instrument are not only for tweaking the sound while you perform—you can also use them to edit a Voice, either in the Voice Play mode or the Voice Edit mode.

● When the [PAN/SEND] indicator is turned on:

PAN	Determines the stereo pan position of the Voice.	[VOICE] → Voice selection → [EDIT] → [COMMON] → [F2] OUTPUT → Pan	Page 154
REVERB	Determines the amount of Reverb effect that is applied to the Voice.	[VOICE] → Voice selection → [EDIT] → [COMMON] → [F2] OUTPUT → RevSend	Page 154
CHORUS	Determines the amount of Chorus effect that is applied to the Voice.	[VOICE] → Voice selection → [EDIT] → [COMMON] → [F2] OUTPUT → ChoSend	Page 154
TEMPO	Determines the tempo of the Arpeggio assigned to the currently selected Voice.	[VOICE] → Voice selection → [F6] ARP → Tempo	Page 154

● When the [TONE] indicator is turned on:

CUTOFF	Raises or lowers the Filter cutoff frequency to adjust the tone brilliance.	[VOICE] → Voice selection → [F5] EG → CUTOF	Page 152
RESONANCE	Boosts or attenuates the level at the area around the Filter cutoff frequency.	[VOICE] → Voice selection → [F5] EG → RESO	Page 152
ATTACK	Determines the attack time of the sound. For example, you can adjust a strings Voice so that the sound gradually swells in volume by setting a slow attack time – simply turn this knob to the right.	[VOICE] → Voice selection → [F5] EG → ATK (AEG)	Page 152
RELEASE	Determines the release time of the sound. Turning the knob to the right sets a long release time and (depending on the selected Voice) lets the sound sustain after the key is released. To produce a sharp release, in which the sound abruptly cuts off, set a short release time.	[VOICE] → Voice selection → [F5] EG → REL (AEG)	Page 152

NOTE The settings above are applied as offsets to the AEG and FEG settings in the Voice Edit mode.

● When the [ARP FX] indicator is turned on:

SWING	Adjusts the swing feel of the Arpeggio playback.	[VOICE] → Voice selection → [EDIT] → [COMMON] → [F3] ARP → [SF3] PLAY FX → Swing	Page 155
GATE TIME	Adjusts the Gate Time (length) of the Arpeggio notes.	[VOICE] → Voice selection → [EDIT] → [COMMON] → [F3] ARP → [SF3] PLAY FX → GateTimeRate	Page 155
VELOCITY	Adjusts the velocity of the Arpeggio notes.	[VOICE] → Voice selection → [EDIT] → [COMMON] → [F3] ARP → [SF3] PLAY FX → VelocityRate	Page 155
UNITMULTIPLY	Adjusts the Arpeggio playback time based on tempo.	[VOICE] → Voice selection → [EDIT] → [COMMON] → [F3] ARP → [SF3] PLAY FX → UnitMultiply	Page 155

● When the [EQ] indicator is turned on:

LO	Determines the amount of boost or attenuation applied to the low frequency band of the Master EQ.	[VOICE] → Voice selection → [EDIT] → [COMMON] → [F1] GENERAL → [SF3] MEQ OFS → LOW	Page 153
LO MID	Determines the amount of boost or attenuation applied to the low-midrange frequency band of the Master EQ.	[VOICE] → Voice selection → [EDIT] → [COMMON] → [F1] GENERAL → [SF3] MEQ OFS → LOW MID	Page 153
HI MID	Determines the amount of boost or attenuation applied to the high-midrange frequency band of the Master EQ.	[VOICE] → Voice selection → [EDIT] → [COMMON] → [F1] GENERAL → [SF3] MEQ OFS → HIGH MID	Page 153
HI	Determines the amount of boost or attenuation applied to the high frequency band of the Master EQ.	[VOICE] → Voice selection → [EDIT] → [COMMON] → [F1] GENERAL → [SF3] MEQ OFS → HIGH	Page 153

NOTE The settings above are applied as offsets to the EQ settings in the [VOICE] → [UTILITY] → [F3] VOICE → [SF1] MEQ display.

● When both the [PAN/SEND] and [TONE] indicators are turned on (by pressing them simultaneously):

ASSIGN A	Adjusts parameters assigned to these knobs in the [UTILITY] → [F4] CTL ASN → [SF2] ASSIGN display.	Page 71
ASSIGN B		
ASSIGN 1	Adjusts parameters assigned to these knobs in the [VOICE] → Voice selection → [EDIT] → [COMMON] → [F4] CTL SET display.	Page 70
ASSIGN 2		

NOTE In addition to above functions, Master Effect related parameters (set in the [UTILITY] → [F3] VOICE → [SF2] MEF display) can be assigned to these four knobs by pressing the [ARP FX] and [EQ] buttons simultaneously. The particular parameters assigned to the four knobs can be set in the [UTILITY] → [F4] CTL ASN → [SF5] MEF display.

TIP Editing a Voice by using the Control sliders

[VOICE] → Voice selection → [EDIT] → Element selection → [F4] AMP → [SF1] LVL/PAN → Level

In the Voice mode, the four Control sliders let you independently adjust the levels of the Elements of a Normal Voice or the Drum Voice keys. When a Normal Voice is selected, you can adjust the level balance among the four Elements.

NOTE Inadvertent use of the sliders may result in no sound. If this occurs, move the sliders upward.

Drum Voice Edit

1 Press the [VOICE] button to enter the Voice mode, then select a Drum Voice to be edited.

2 Press the [EDIT] button to enter the Voice Edit mode.

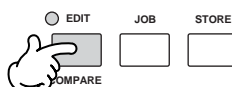

3 Call up the Common Edit display or Key Edit display.

If you want to edit the sounds that make up a Drum Voice and the basic parameters that determine the sound, such as Oscillator, Pitch, Filter, Amplitude, and EG (Envelope Generator), call up the Key Edit display. To edit more global parameters related to the overall Drum Voice and how it's processed, such as Arpeggio, Controller, and Effects, call up the Common Edit display.

While in the Voice Edit mode, you can switch between the Common Edit display and the Key Edit display as shown below.

Calling up the Common Edit display

Press the [COMMON] button to call up the Common Edit display. In the Edit mode, the [DRUM KITS] button functions as the [COMMON] button.

Indicates a Common Edit display.

Calling up the Key Edit display

Press the Number [1] button to call up the Key Edit display, then select the key to which the desired instrument is assigned.

Indicates the display for editing the key C0.

Key Edit (1 – 73)

4 Select the desired menu for editing by pressing the [F1] – [F6] and [SF1] – [SF5] buttons, then edit the parameters.

The main parameters available are basically the same as in the Normal Voice Edit (page 53). What is called Key Edit in the Drum Voice corresponds to Element Edit in the Normal Voice. Please keep in mind that the LFO parameters are not available in the Drum Voice.

5 Repeat 3 – 4 as desired.

6 Name the edited Drum Voice.

Enter a name for the Voice from the NAME display ([COMMON] → [F1] GENERAL → [SF1] NAME). For detailed instructions on naming a Voice, refer to page 38 in the Basic Operation section.

Enter the desired Voice name.

7 Store the edited Voice to internal User memory.

The edited Voice can be stored in the Voice Store mode. See page 60 for details.

TIP Assigning drum/percussion instruments to individual keys

[VOICE] → Drum Voice selection → [EDIT] → Key selection → [F1] OSC → [SF1] WAVE

In the Drum Voice Edit mode, you can create your own original drum kits by assigning specific instrument sounds to individual keys—in any desired order—and edit detailed parameters for each key's sound.

1 Call up the Key Edit display in the Voice Edit mode.

Refer to step 3 on page 54.

2 Call up the [F1] OSC → [SF1] WAVE display.

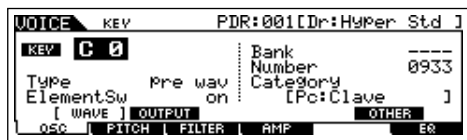

3 Press the key to which you want to assign a sound.

The drum instrument currently assigned to the pressed key will sound.

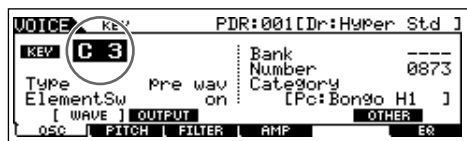
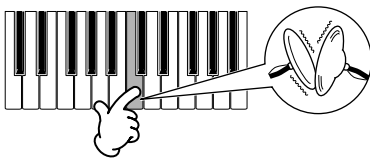

4 Select the desired Waveform to be assigned.

Move the cursor to "Number" and change the value by using the data dial, [INC/YES] button, and [DEC/NO] button. Then, press the same key set in step 3 again to confirm the selected instrument sound.

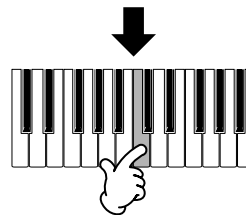
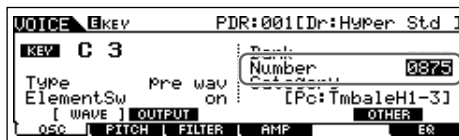

5 Create your original drum kit by repeating steps 3 – 4.

6 Store the created drum kit as a Drum Voice in User memory.

The edited Voice can be stored in the Voice Store mode. See page 60 for details.

TIP Setting the drum key for independent open and closed hi-hat sounds

[VOICE] → Drum Voice selection → [EDIT] → Key selection → [F1] OSC → [SF5] OTHER → AltnateGroup

In a real drum kit, some drum sounds cannot physically be played simultaneously, such as open and closed hi-hats. You can prevent drum instruments from playing back simultaneously by assigning them to the same Alternate Group. The preset Drum Voices have many such Alternate Group assignments to ensure the most authentic, natural sound. When creating a Voice from scratch, you can use this feature—either to ensure authentic sound, or to create special effects, where playing one sound cancels out a previous one.

1 Call up the Key Edit display in the Voice Edit mode.

Refer to step 3 on page 54.

2 Call up the [F1] OSC → [SF5] OTHER display.



3 Press the key which corresponds to “Hi-Hat Open” and set the Alternate Group to “1.”

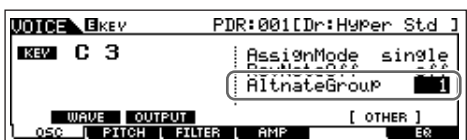
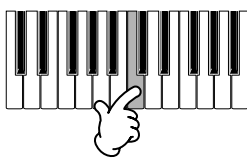

4 Press the key which corresponds to “Hi-Hat Close” and set it to the same Alternate Group (1) as in step 3.

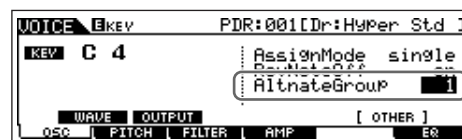
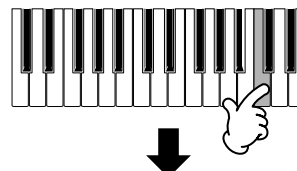

5 Confirm whether the Alternate Group has been set properly.

Immediately after pressing the “Hi-Hat Open” key, press the “Hi-Hat Close” key. Pressing the second key should cut off the sound of the first.

Since the settings above are included in the Drum Voice data, store them as a Drum Voice in the Voice Store mode.

TIP Determining how the Drum Voice responds when the key is released

[VOICE] → Drum Voice selection → [EDIT] → Key selection → [F1] OSC → [SF5] OTHER → RcvNoteOff

You can determine whether or not the selected Drum key responds to MIDI Note Off messages. Setting the Receive Note Off parameter to “off” can be useful for cymbal sounds and other sustaining sounds. This lets you have the selected sounds sustain to the length of their natural decay—even if you release the note, or when a Note Off message is received. If this parameter is set to “on,” the sound will stop immediately when the note is released or a Note Off message is received.

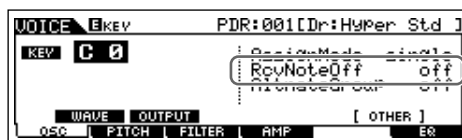

Storing/Saving the created Voice

Two steps are necessary in order to store (save) your Voice—storing the edited Voice to internal memory and saving the stored voices to a USB storage device.

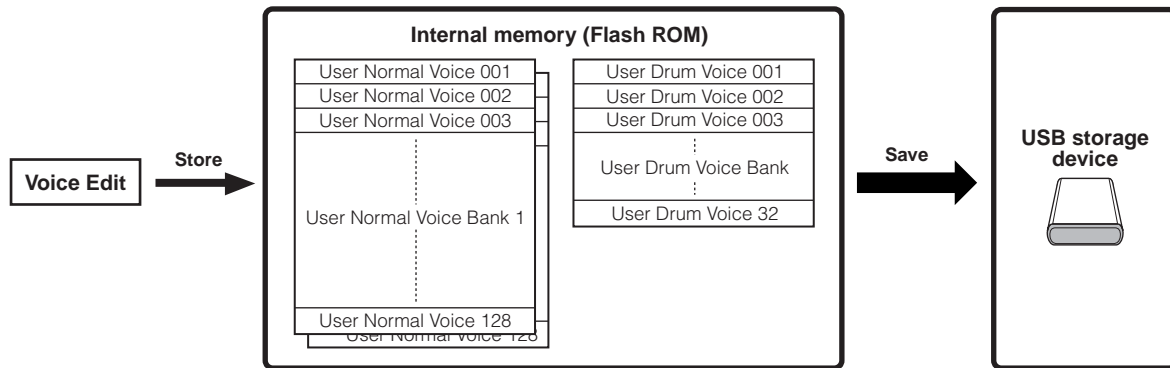

Keep in mind that edited Voice data is stored to internal User memory (Flash ROM) and is stored even when turning the power off. As such it is not necessary to save the data to a USB storage device; however, you may want to save it to another media for backup or organizational purposes, using the Save operation.

Storing the edited Voice as a User Voice to internal memory

[VOICE] → [STORE]

- 1 After editing the Voice, press the [STORE] button to enter the Voice Store mode.

Make sure to execute the Store operation before selecting another Voice.

- 2 Select the destination Voice memory.

Select a User Bank ("USR1" or "USR2" when storing a Normal Voice, "UDR" when storing a Drum Voice) and the desired Voice number by using the data dial, [INC/YES] and [DEC/NO] button.

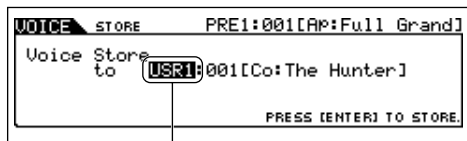

Select a User Bank.

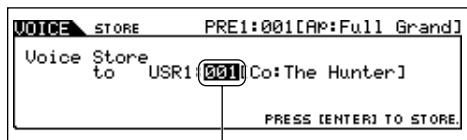

Select a Voice number.

- 3 Press the [ENTER] button.

The display prompts you for confirmation. Press the [DEC/NO] button to cancel the Store operation.

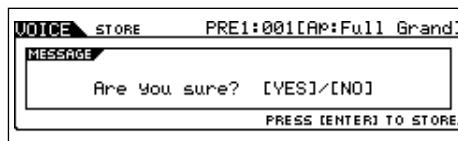
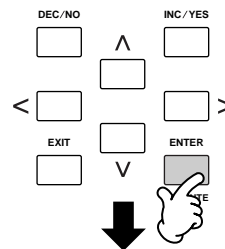

CAUTION

When you execute the Store operation, the settings for the destination memory will be overwritten. Important data should always be backed up to a separate USB storage device.

4 To execute the Store operation, press the [INC/YES] button.

After the Voice has been stored, a “Completed” message appears and operation returns to the Voice Play display.

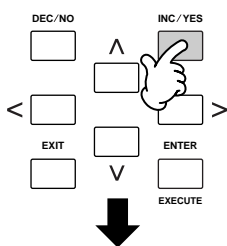

CAUTION

Never attempt to turn off the power while an “Executing...” or “Please keep power on” message is shown. Turning the power off in this state may cause the system to freeze and prevent normal startup the next time the power is turned on, as well as resulting in the loss of all user data.

CAUTION

If you select another Voice without storing, the currently edited Voice will be lost. Make sure to store the edited Voice before selecting another Voice.

Saving the edited Voices to a USB storage device

[FILE] → [F2] SAVE

Connect the USB device and follow the instructions below.

NOTE When a USB storage device is connected or media is inserted, an error message “USB device unformatted.” may appear in the LCD display, indicating that the device must be formatted for use in the File mode (page 211).

1 Press the [FILE] button to enter the File mode. Then press the [F1] CONFIG button and [SF1] CURRENT button.

If the device is divided into several partitions, select the specific partition for use. If the device has several media (e.g., discs) inserted, select a specific Slot number.

2 Press the [F2] SAVE button to call up the Save display.

3 Set the Type parameter to “All Voice.”

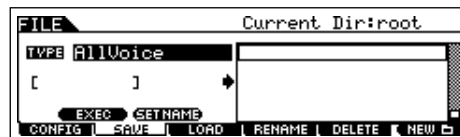

The following three file types are available for saving Voice data. Here, select “All Voice.”

All	When this is selected, execute the Save operation to save all the created data including the User Voices as a single file (extension: M7A).
All Voice	When this is selected, execute the Save operation to save all User Voices as a single file (extension: W7V).
Voice Editor	When this is selected, execute the Save operation to save all User Voices as a single file (extension: W7E) which can be exported to the Voice Editor software.

4 Input a file name.

Move the cursor to the file name field, then input the desired file name. For detailed instructions on naming a Voice, refer to page 38.

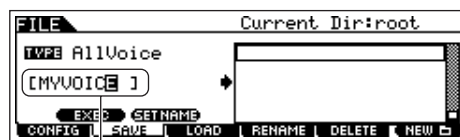

File name

5 If you have created a destination folder, select the folder.

For information on how to select a folder, see page 213. For information on how to create/delete a folder and change the folder name, see page 211.

6 Press the [SF1] EXEC button to actually save the file.

If you are about to overwrite an existing file, the display prompts you for confirmation. Press the [INC/YES] button to execute the Save operation to overwrite the existing file, or press the [DEC/NO] button to cancel it.

CAUTION

While the data is being saved/loaded, make sure to follow these precautions:

- Do not remove or eject the media from the USB storage device.
- Do not unplug or disconnect the USB storage device.
- Do not turn off the power of the instrument or the relevant devices.

Loading Voice data from a USB storage device

[FILE] → [F3] LOAD

In the previous section, we saved Voice data as an “All Voice” file to a USB storage device. Here, we’ll recall that Voice data and load it to the instrument with the Load operation.

1 Press the [FILE] button to enter the File mode. Then press the [F1] CONFIG button and [SF1] CURRENT button.

If the device is divided into several partitions, select the specific partition for use. If the device has several media (e.g., discs) inserted, select a specific Slot number.

2 Press the [F3] LOAD button to call up the Load display.

3 Select the file type to be loaded.

The file saved in operation explained on the previous page has all the User Voices.

If you wish to load all the User Voices, set Type to “AllVoice.”

If you wish to load only a specific Voice, set Type to “Voice.”

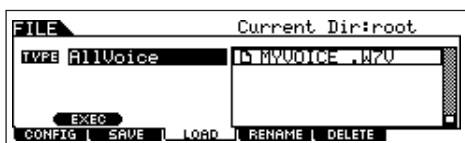

4 Select the file ([F]) to be loaded.

Move the cursor to the file (extension: W7V) saved in the operation explained on the previous page. If you set the Type parameter to “AllVoice” in step 3, go to step 5. If the desired file was saved in specific folder, enter the folder and select the file. For information on how to select a folder, see page 213. If you set the Type parameter to “Voice” in step 3, execute the operations in the following box, then go to step 5.

When Type is set to “Voice”:

When Type is set to “Voice,” you can specify and load a specific Voice from a file (with the extension W7V or M7A).

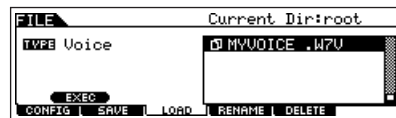

Move the cursor to the file (extension:W7V) saved in the operation explained on the previous page.

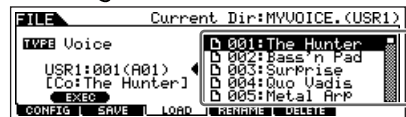
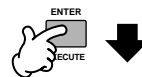

Select a source Voice Bank from the selected file with the following operation.

To select a User Normal Voice Bank, press one of the [USER1] and [USER2] buttons. To select a User Drum Voice Bank, simultaneously hold the [DRUM KITS] button and press the [USER1] button.

After selecting a source Voice Bank, all the Voices contained in the selected Bank are listed in the display. Move the cursor to the desired Voice to be loaded.

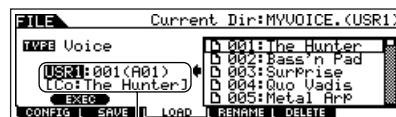

Select a destination Voice Number.

Select a Voice by moving the cursor to the location of “USR1” in the above display and using the data dial.

CAUTION

Loading data to this instrument automatically erases and replaces any existing data in the User memory.

5 Press the [SF1] EXEC button to actually load the file.

After the data has been loaded, a “Completed” message appears and operation returns to the original display.

CAUTION

While the data is being saved/loaded, make sure to follow these precautions:

- Do not remove or eject the media from the USB storage device.
- Do not unplug or disconnect the USB storage device.
- Do not turn off the power of the instrument or the relevant devices.

Editing a Performance

The Performance Edit mode ([PERFORM] → [EDIT]) lets you create your own original Performances—containing up to four different Parts (Voices)—by editing the various parameters. After assigning different Voices to separate ranges of the keyboard, edit the detailed parameters in the Performance Edit mode.

- 1 Press the [PERFORM] button to enter the Performance mode, then select a Performance to be edited (page 44).
- 2 Press the [EDIT] button to enter the Performance Edit mode.
- 3 Call up the Common Edit display or Part Edit display.

Use Part Edit to edit the parameters for each Part.
Use Common Edit to edit the parameters for all of the Parts.

While in the Voice Edit mode, you can switch between the Common Edit display and the Part Edit display as shown below.

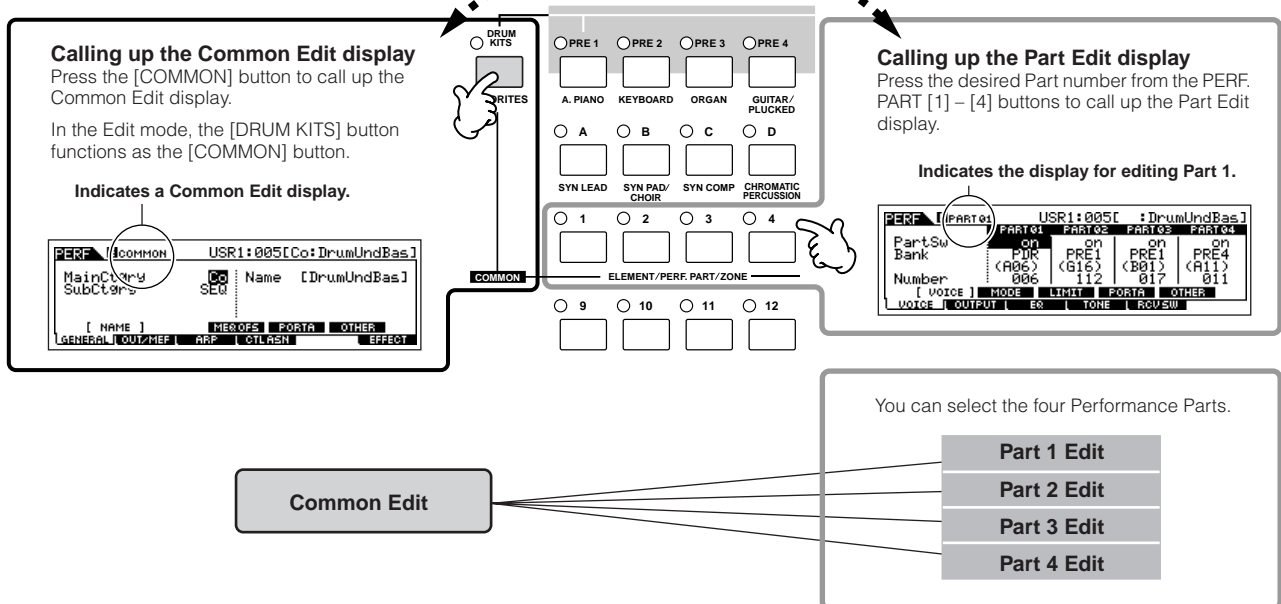

4

Select the menu you wish to edit by pressing the [F1] – [F6] buttons and [SF1] – [SF5] buttons, then edit the parameters in each display.

The following briefly describes the main Performance parameters.

● **Parameters for the Voice assigned to each Part** Page 174

Part selection → [F1] VOICE

The Voice assigned to each part and its note range can be set also in the Performance Play mode (page 171). In addition to the parameters available in the Performance Play mode, the Performance Edit mode also lets you set Portamento (pitch glide) and Arpeggio Switch (which determines whether the Arpeggio plays a specific Part or not).

● **Basic parameters for creating the sound** Page 176

Part selection → [F4] TONE

Edit the parameters for each Part's Voice such as Pitch, Filter, and Amplitude. The parameters offset the same parameters in the Voice Element Edit mode.

● **Effect related parameters** Pages 143, 172

[COMMON] → [F6] EFFECT

[COMMON] → [F2] OUT/MEF → [SF3] MEF (Master Effect)

The Effects use DSP (Digital Signal Processing) to alter and enhance the sound of a Performance. The Common Edit display lets you edit the Effect-related parameters.

● **Master EQ related parameters** Page 172

[COMMON] → [F2] OUT/MEF → [SF3] MEQ (Master Equalizer)

These parameters let you use the five-band Master EQ to process the overall sound of the Performance. Master EQ also features separate EQ shape parameters for the Low and High bands, as well as the Frequency, Gain and Q controls for each band.

● **Controller related parameters** Page 70

[COMMON] → [F4] CTL ASN (Controller Assign)

For each Performance, you can assign the Control Change Number to built-in controllers such as Knob 3 and 4 (ASSIGN1 and 2) and optionally connected controllers, such as Footswitch and Foot Controller.

NOTE Functions assigned to Controllers depend on the settings of each Part's Voice edited in the Voice Edit mode.

● **Arpeggio related parameters** Pages 145, 173

[COMMON] → [F3] ARP (Arpeggio)

For each Performance, you can set the Arpeggio related parameters, such as Arpeggio type and playback tempo. These settings can be edited in the Common Edit display.

5

Repeat steps 3 – 4 as desired.

6

Name the edited Performance.

Enter a name for the Voice from the NAME display ([COMMON] → [F1] GENERAL → [SF1] NAME). For detailed instructions on naming a Voice, refer to page 38.

Enter the desired Performance name.



7

Store the settings as a User Performance.

The edited Performance can be stored in the Performance Store mode. For details, see page 66.

TIP The Compare Function

You can compare the sound of the original (unedited) Performance with the edited Performance. For details, see page 36.

TIP Edit Recall

If you are editing a Voice and select a different Performance without storing the one you were editing, all the edits you've made will be erased. If this happens, you can use Edit Recall to restore the Performance with your latest edits intact.

- 1 Press the [JOB] button in the Performance mode to enter the Performance Job mode.
- 2 Press the [F2] RECALL button to call up the Recall display.
- 3 Press the [ENTER] button. (The display prompts you for confirmation.)
If you wish to cancel the operation, press the [DEC/NO] button.
- 4 Press the [INC/YES] button to execute Edit Recall to restore the Performance.

TIP Editing a Performance by using the Knobs

The four knobs at the top left of the instrument are not only for tweaking the sound while you perform—you can also use them to edit a Performance, either in the Performance Play mode or the Performance Edit mode.

● When the [PAN/SEND] indicator is turned on:

PAN	Determines the stereo pan position of the Performance.	[PERFORM] → Performance selection → [EDIT] → [COMMON] → [F2] OUT/MEF → [SF1] OUT → Pan	Page 172
REVERB	Determines the amount of Reverb effect that is applied to the Performance.	[PERFORM] → Performance selection → [EDIT] → [COMMON] → [F2] OUT/MEF → [SF1] OUT → RevSend	Page 172
CHORUS	Determines the amount of Chorus effect that is applied to the Performance.	[PERFORM] → Performance selection → [EDIT] → [COMMON] → [F2] OUT/MEF → [SF1] OUT → ChoSend	Page 172
TEMPO	Determines the tempo of the Arpeggio assigned to the currently selected Performance.	[PERFORM] → Performance selection → [F6] ARP → Tempo	Page 171

● When the [TONE] indicator is turned on:

CUTOFF	Raises or lowers the Filter cutoff frequency to adjust the tone brilliance.	[PERFORM] → Performance selection → [F5] EG → CUTOF	Page 171
RESONANCE	Boosts or attenuates the level at the area around the Filter cutoff frequency.	[PERFORM] → Performance selection → [F5] EG → RESO	Page 171
ATTACK	Determines the attack time of the sound. For example, you can adjust a strings Voice so that the sound gradually swells in volume by setting a slow attack time – simply turn this knob to the right.	[PERFORM] → Performance selection → [F5] EG → ATK (AEG)	Page 171
RELEASE	Determines the release time of the sound. Turning the knob to the right sets a long release time and (depending on the Voice assigned to the selected Performance) lets the sound sustain after the key is released. To produce a sharp release, in which the sound abruptly cuts off, set a short release time.	[PERFORM] → Performance selection → [F5] EG → REL (AEG)	Page 171

NOTE The settings above are applied as offsets to the AEG and FEG settings in the Performance Edit mode.

● When the [ARP FX] indicator is turned on:

SWING	Adjusts the swing feel of the Arpeggio playback.	[PERFORM] → Performance selection → [EDIT] → [COMMON] → [F3] ARP → [SF3] PLAY FX → Swing	Page 173
GATE TIME	Adjusts the Gate Time (length) of the Arpeggio notes.	[PERFORM] → Performance selection → [EDIT] → [COMMON] → [F3] ARP → [SF3] PLAY FX → GateTimeRate	Page 173
VELOCITY	Adjusts the velocity of the Arpeggio notes.	[PERFORM] → Performance selection → [EDIT] → [COMMON] → [F3] ARP → [SF3] PLAY FX → VelocityRate	Page 173
UNITMULTIPLY	Adjusts the Arpeggio playback time based on tempo.	[PERFORM] → Performance selection → [EDIT] → [COMMON] → [F3] ARP → [SF3] PLAY FX → UnitMultiply	Page 173

● When the [EQ] indicator is turned on:

LO	Determines the amount of boost or attenuation applied to the low frequency band of the Master EQ.	[PERFORM] → Performance selection → [EDIT] → [COMMON] → [F1] GENERAL → [SF3] MEQ OFS → LOW	Page 172
LO MID	Determines the amount of boost or attenuation applied to the low-midrange frequency band of the Master EQ.	[PERFORM] → Performance selection → [EDIT] → [COMMON] → [F1] GENERAL → [SF3] MEQ OFS → LOW MID	Page 173
HI MID	Determines the amount of boost or attenuation applied to the high-midrange frequency band of the Master EQ.	[PERFORM] → Performance selection → [EDIT] → [COMMON] → [F1] GENERAL → [SF3] MEQ OFS → HIGH MID	Page 173
HI	Determines the amount of boost or attenuation applied to the high frequency band of the Master EQ.	[PERFORM] → Performance selection → [EDIT] → [COMMON] → [F1] GENERAL → [SF3] MEQ OFS → HIGH	Page 173

NOTE The settings above are applied as offsets to the EQ settings in the [PERFORM] → Performance selection → [EDIT] → [COMMON] → [F2] OUT/MEF → [SF2] MEQ (Master EQ) display.

● When both the [PAN/SEND] and [TONE] indicators are turned on (by pressing them simultaneously):

ASSIGN A	Adjusts parameters assigned to these knobs in the [UTILITY] → [F4] CTL ASN → [SF2] ASSIGN display.	Page 71
ASSIGN B		
ASSIGN 1	Depends on the settings of the Voice assigned to the selected Performance.	Page 70
ASSIGN 2		

NOTE In addition to above functions, Master Effect related parameters (set in the [PERFORM] → Performance selection → [COMMON] → [F2] OUT/MEF → [SF3] MEF display) can be assigned to these four knobs by pressing the [ARP FX] and [EQ] buttons simultaneously. The particular parameters are assigned to the four knobs can be set in the [UTILITY] → [F4] CTL ASN → [SF5] MEF display.

TIP Editing a Performance by using the Control sliders

[PERFORM] → Performance selection → [EDIT] → Part selection → [F2] OUTPUT → [SF1] VOL/PAN → Volume

In the Performance mode, the four Control sliders let you independently adjust the levels of the Parts (Voices), letting you control the overall balance of the Parts.

NOTE Inadvertent use of the sliders may result in no sound. If this occurs, move the sliders upward.

Storing/Saving the created Performance

Two steps are necessary in order to store (save) your Performance—storing the edited Performance to internal memory and saving the stored Performances to a USB storage device.

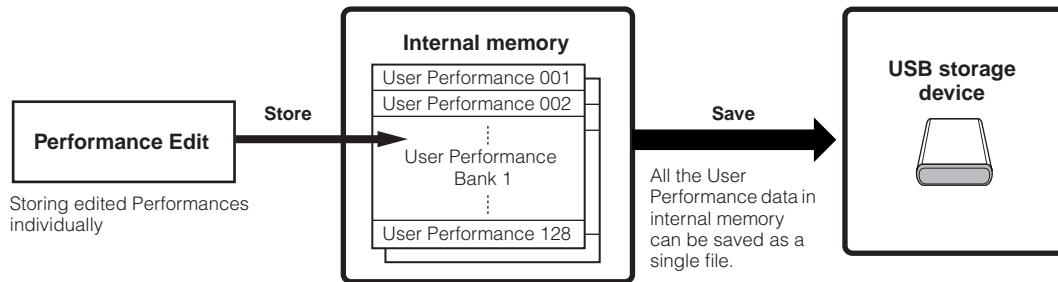

When you turn off the power to the instrument, User Performances saved in the Performance Store mode are not erased. As such it is not necessary to save the data to USB storage device; however, you may want to save it for backup or organizational purposes, using the Save operation.

Storing the edited Performance as a User Performance to internal memory

[PERFORM] → [STORE]

1 After editing the Performance, press the [STORE] button to enter the Performance Store mode.

2 Select the destination Performance memory.

Select a Performance number by using the data dial, [INC/YES] and [DEC/NO] button.



CAUTION

When you execute the Store operation, the settings for the destination memory will be overwritten. Important data should always be backed up to a separate USB storage device.

3 Press the [ENTER] button.

The display prompts you for confirmation. Press the [DEC/NO] button to cancel the Store operation.

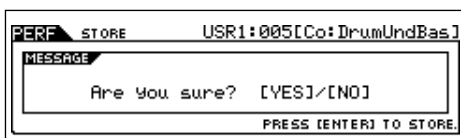
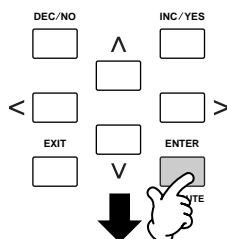

4 To execute the Store operation, press the [INC/YES] button.

After the Performance has been stored, a “Completed” message appears and operation returns to the Performance Play display.

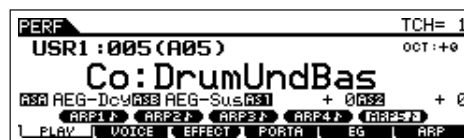
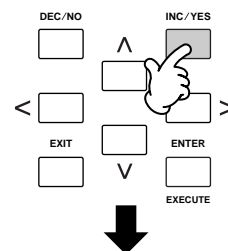

CAUTION

Never attempt to turn off the power while an “Executing...” or “Please keep power on” message is shown. Turning the power off in this state may cause the system to freeze and prevent normal startup the next time the power is turned on, as well as resulting in the loss of all user data.

CAUTION

If you select another Performance without storing, the currently edited Performance will be lost. Make sure to store the edited Performance before selecting another Performance.

Saving the edited Performances to a USB storage device

[FILE] → [F2] SAVE

The basic operations are the same as in the Voice mode (page 61).

However, keep in mind that you must set the Type parameter to “All.” When Type is set to “All,” executing the Save operation saves all the created data, including the Performances as well as the Voices assigned to them, as a single file (extension: M7A).

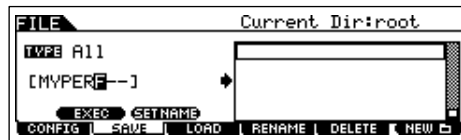

Loading Performance data from the USB storage device

[FILE] → [F3] LOAD

These instructions describe how to recall the data saved as an “All” file type (extension: M7A) from the USB storage device, by using the Load operation.

- 1 Press the [FILE] button to enter the File mode. Then press the [F1] CONFIG button and [SF1] CURRENT button.

If the device is divided into several partitions, select the specific partition for use. If the device has several media (e.g., discs) inserted, select a specific Slot number.

- 2 Press the [F3] LOAD button to call up the Load display.

- 3 Select the file type to be loaded.

The “All” file contains all the Performances.

If you wish to load all the Performances, set Type to “All.” In this case, all data that can be created on this instrument will be loaded. If you wish to load only a specific Performance, set Type to “Performance.”

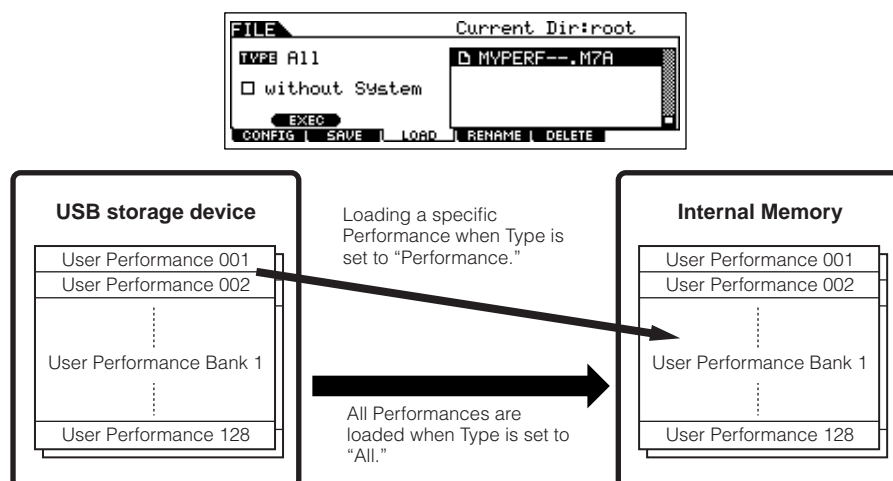

CAUTION

When Type (file type) is set to “All” and the Load operation is executed, all data that can be created on the instrument will be loaded. This means that any existing data in User memory will automatically be overwritten and lost. Make sure to save any important data to a USB storage device before performing the Load operations, especially when Type is set to “All.”

NOTE When Type (file type) is set to “Performance” and the Load operation is executed, the sound of the Performances may not be reproduced properly if the User Voices assigned to the Performances saved in the file have been changed by editing.

4 Select the file () to be loaded.

Move the cursor to the file (extension: M7A) saved in the operation explained in the previous instructions. If the desired file was saved in specific folder, enter the folder and select the file. For information on how to select a folder, see page 213. If you have set the Type parameter to “All” in step 3, go on to step 5. If you have set the Type parameter to “Performance” in step 3, execute the operations in the following box, then go on to step 5.

When Type is set to “Performance”:

When Type is set to “Performance,” you can specify and load a specific Performance from a file (with the extension M7A).

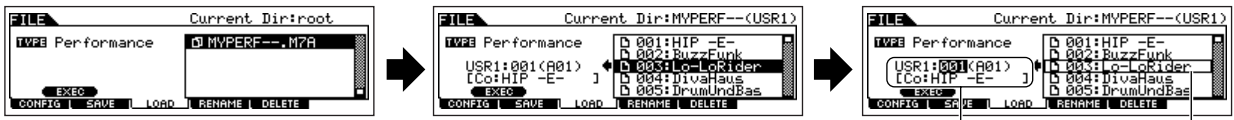

Move the cursor to the file (extension: S7A) saved in the operation explained on the previous page.



All the Performances contained in the selected file are listed on the display. Move the cursor to the desired Performance.

Select the destination Performance number.

Select the desired Performance to be loaded.

CAUTION

Loading data to this instrument automatically erases and replaces any existing data in the User memory.

5 Press the [SF1] EXEC button to actually load the file.

After the data has been loaded, a “Completed” message appears and operation returns to the original display.

CAUTION

While the data is being saved/loaded, make sure to follow these precautions:

- Do not remove or eject the media from the USB storage device.
- Do not unplug or disconnect the USB storage device.
- Do not turn off the power of the instrument or the relevant devices.

Using the Controllers—Advanced Course

Controllers supported by the MO

You can control tone, volume, pitch and other parameters by using the controllers on the front panel, as well as by using external controllers connected to several controller jacks on the rear panel.

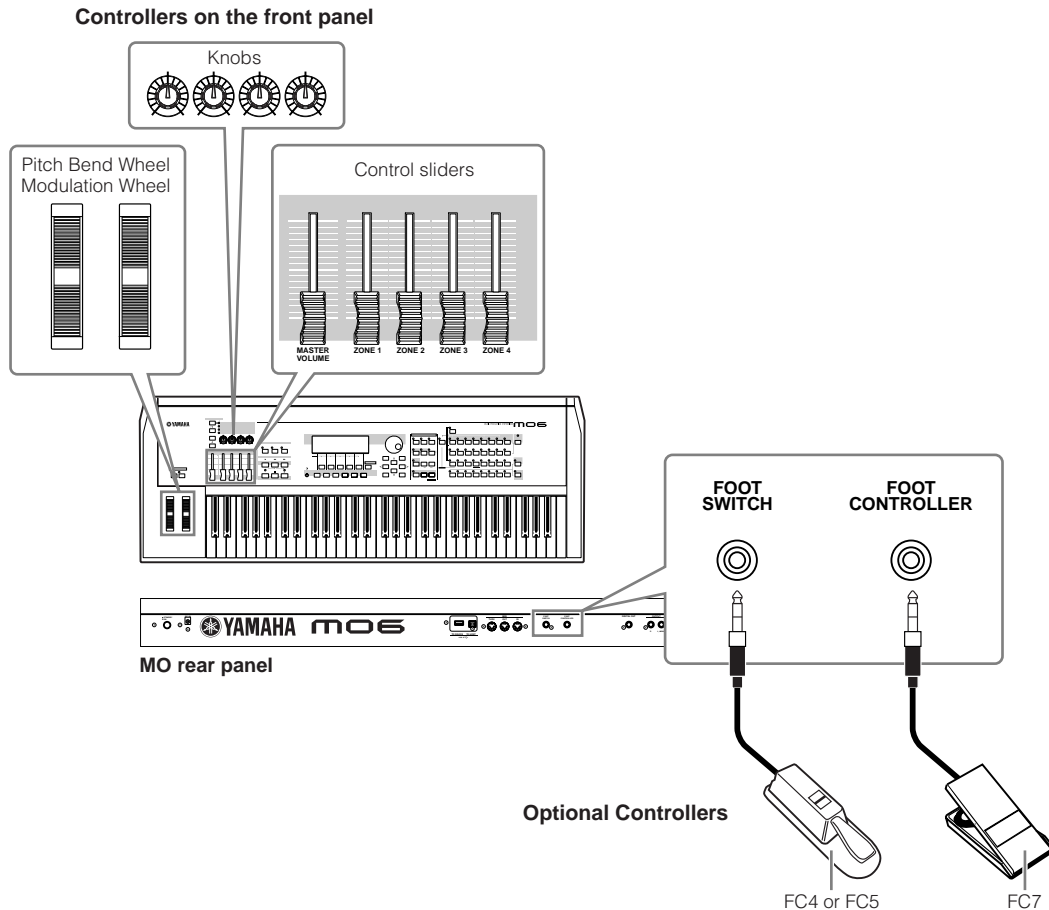

Controllers on the MO

■ **Pitch Bend wheel/Modulation wheel**

These control pitch and vibrato. For details, see page 50.

■ **Knobs and Control sliders**

These control various parameters. For details, see page 51.

Controllers (optional) that can be connected to the rear panel of the MO

■ **Footswitch**

An optional Yamaha FC4 or FC5 Foot Switch connected to the rear panel FOOT SWITCH jack can be assigned to a range of parameters. It is suited for switch-type (on/off) controls, such as sustain, Portamento Switch, increment/decrement of a Voice or Performance Number, starting/stopping the Sequencer, and holding the Arpeggio on or off.

■ **Foot Controller**

An optional Foot Controller (such as the FC7), connected to the FOOT CONTROLLER jack on the rear panel, can be assigned to control a variety of parameters on the instrument. By using a foot controller for parameter control in this way, both your hands are left free to play the keyboard (or to operate other controllers)—an exceptional convenience when playing live.

Quick Guide
Using the Controllers—Advanced Course

Controlling a Voice with Controller Set

[VOICE] → Voice selection → [EDIT] → [COMMON] → [F4] CTL SET (page 155)

Each of the Preset Voices of MO is programmed with appropriate Modulation Wheel and Knob assignments, for adjusting the sound and effects in ways that best match the selected Voice.

For example, you can use the Modulation Wheel to apply a chorus effect to a piano Voice, or use one of the Knobs to control the decay time parameter of a bass guitar Voice. The settings for all the controllers are referred to as a “Controller Set.” These Controller Set settings can be stored with the User Voice.



Switch the display for each Controller Set by using the [SF1] – [SF3] buttons

1 Element Switch

Select whether the controller will affect each individual Element.

Keep in mind that some destinations affect only the entire Voice (all Elements). In this case, the Element Switch parameter will be indicated by “<---->” and cannot be changed. This applies only to Normal Voices.

2 Source (controller)

Determines the desired controller. For details about the abbreviations for each controller, see page 155. The number in brackets indicates the Control Change number generated when moving the controller.

3 Destination (function)

Determines the function assigned to the Source (controller). For the details about the abbreviations and the parameter types, refer to the Control List in the separate Data List booklet.

4 Depth

Determines the amount by which the parameter selected in Destination can be controlled. For negative values, the controller operation is reversed.

TIP Assigning multiple functions to a controller

You can have a single controller affect different aspects of the sound at the same time. For example, set the Source parameter of Control Set 1 to MW (Modulation wheel) and the Destination parameter to ELFO-PM (Element LFO Pitch Modulation Depth). Then set the Source parameter of Control Set 2 also to MW, but set the Destination parameter to ELM PAN (Element Pan). In this example, when you move the Modulation Wheel upward, the amount of Pitch Modulation increases accordingly, and the Element is simultaneously panned from left to right.

NOTE The Controller Set edited in the Voice Edit mode is available when the corresponding Voice is selected in the Performance, Song, and Pattern.

NOTE The functions assigned to the Controller by the Controller Set function are applied only to the internal tone generator block. For connected external MIDI instruments, use of the controllers generates separate MIDI Control Change numbers, as shown in the Source parameter.

NOTE Even if a different function is assigned to this wheel, the Pitch Bend function is available and Pitch Bend messages are still generated when the wheel is used.

Controlling the overall system with ASSIGN A and B



[UTILITY] → [F4] CTL ASN → [SF2] ASSIGN (page 208)

The ASSIGN A and B (Knob 1 and 2) settings let you control the functions that affect all Voices, Performances, Song, and Pattern.

You can store the ASSIGN A and B settings as the system settings by pressing the [STORE] button.

NOTE ASSIGN A and B are common to all Voices/Performances/Songs/Patterns. Changing the setting of ASSIGN A and B may result in changes to the data of stored User Voices/Performances/ Songs/Patterns.

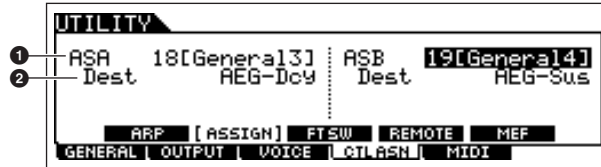

1 ASSIGN A, ASSIGN B

Determines the Control Change numbers generated when controlling the ASSIGN A and B (Control sliders 1 and 2). Normally, there is no need to change these parameters. The conventional parameter assignments (as defined in the MIDI standard) used for the control numbers are indicated in parentheses.

2 Destination (function)

Determines the functions assigned to ASSIGN A and B. For the details about the abbreviations and the parameter types, refer to the Control List in the separate Data List booklet.

Changing Control Change numbers

The functions assigned to the controllers by the Controller Set and ASSIGN A/B functions are applied only to the internal tone generator block.

For connected external MIDI instruments, use of the controllers generates MIDI Control Change messages, as assigned in the chart below.

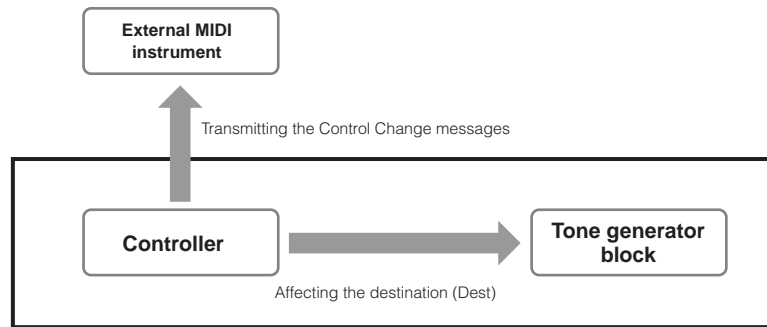

Controller	Generated MIDI message	Display for setting the Control Change number
Aftertouch*	Channel Aftertouch (DnH)	-
Pitch Bend wheel	Pitch Bend (EnH)	-
Modulation wheel	Control Change (BnH, 01H)	-
ASSIGN A, B	Control Change (BnH)	[UTILITY] → [F4] CTL ASN → [SF2] ASSIGN
Footswitch	Control Change (BnH)	[UTILITY] → [F4] CTL ASN → [SF3] FT SW
Ribbon Controller*	Control Change (BnH)	[VOICE] → [UTILITY] → [F3] VOICE → [SF4] CTL ASN
ASSIGN 1, 2		[PERFORM] → Performance selection → [EDIT] → [COMMON] → [F4] CTL ASN
Foot Controller 1, 2*		[SONG]/[PATTERN] → Song/Pattern selection → [MIXING] → [EDIT] → [COMMON] → [F4] CTL ASN
Breath Controller*		

* The MO does not have the following MIDI controllers: Aftertouch, Ribbon Controller, Foot Controller 2 jack, or Breath Controller jack. However, keep in mind that if the same MIDI Control Change messages as set here are received from an external device, the internal tone generator also responds to those messages as if the unsupported/unavailable MIDI controller was used on the MO.

Conventional controllers, such as Modulation wheel, will affect connected MIDI instruments in their conventional way. For example, when the pan function is assigned to the Modulation wheel under Controller Set, using the Modulation wheel will apply the pan function to the internal tone generator, but will transmit the Modulation messages to an external MIDI instrument.

Keep in mind also that if the same MIDI Control Change messages as set here are received from an external device, the internal tone generator also responds to those messages as if the controller on the MO itself was used.

TIP Using the Controllers for two different functions

You can also set up a controller such that it sends one kind of Control message to the internal tone generator of the MO, yet another kind of message to the MIDI Out. For example, in a Controller Set you could assign Resonance to ASSIGN 1 (Knob 3). Then, in the Utility mode, you could assign Control Change number 1 (modulation) to the same Knob. Now, when you move Knob 3, resonance will be applied to the sound of the internal tone generator block, while modulation messages will be transmitted to the external MIDI instrument.

Creating a Song on the MO

In this section, we'll explain how to create a Song by using the built-in sequencer of the MO (Song mode and Pattern mode). There are two ways (or modes) that you can use the music production features of the MO to create your own music: Song mode and Pattern mode.

In the Song mode, you can create a Song in order from beginning to end.

Song mode

Measure 1 120



In the Pattern mode, you can create separate Sections, each several measures in length, as an Intro, melody A, main theme, etc.—then, combine the separate Sections to create an entire Song.

Pattern mode



First, listen to the Song and Pattern Demos that have been specially programmed in the MO, to give you an idea how the Patterns are built and how they can be used.

Next, we'll give you a specific example in creating a Song—entering a rhythm pattern to each Section in the Pattern mode, then recording a melody in the Song mode. Once you see how it's done, you can use the same method to create your own music with Patterns and Songs.

Playing the Demo Songs/Patterns

The Song and Pattern Demos have been specially programmed so you can hear just how amazing the sounds are, and find out just how powerful the instrument really is—for music creation, performance and production.

CAUTION

When the Demo Song/Pattern data is loaded, the memory area for playback will be overwritten and the [EFFECT BYPASS] button will be turned off. Also, the following settings will be changed in order to play back the Demo Song/Pattern properly.

- [UTILITY] → [F1] GENERAL → [SF1] TG → Volume, NoteShift, Tune
- [UTILITY] → [F1] GENERAL → [SF4] OTHER → CtrlRest

Important data should always be backed up to a USB storage device.

- 1 Simultaneously press the [FILE] button and [UTILITY] button.

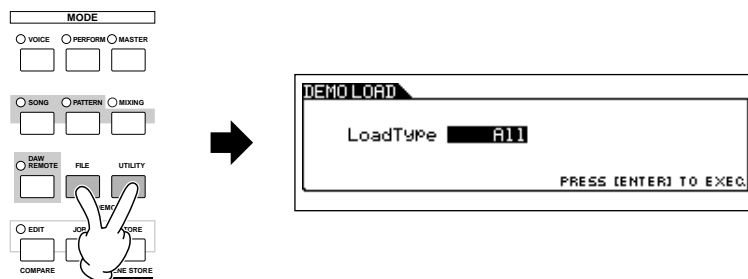

Quick Guide
Creating a Song on the MO

2 Set the LoadType to "All."

Any of following three types can be set. However, for this example, select "All."

All Loads both the Demo Song and Pattern data.

Song Loads only the Demo Song data.

Pattern Loads only the Demo Pattern data.

3 Press the [ENTER] button to load the Demo data.

After the data is loaded, the Song Play display is automatically called up.

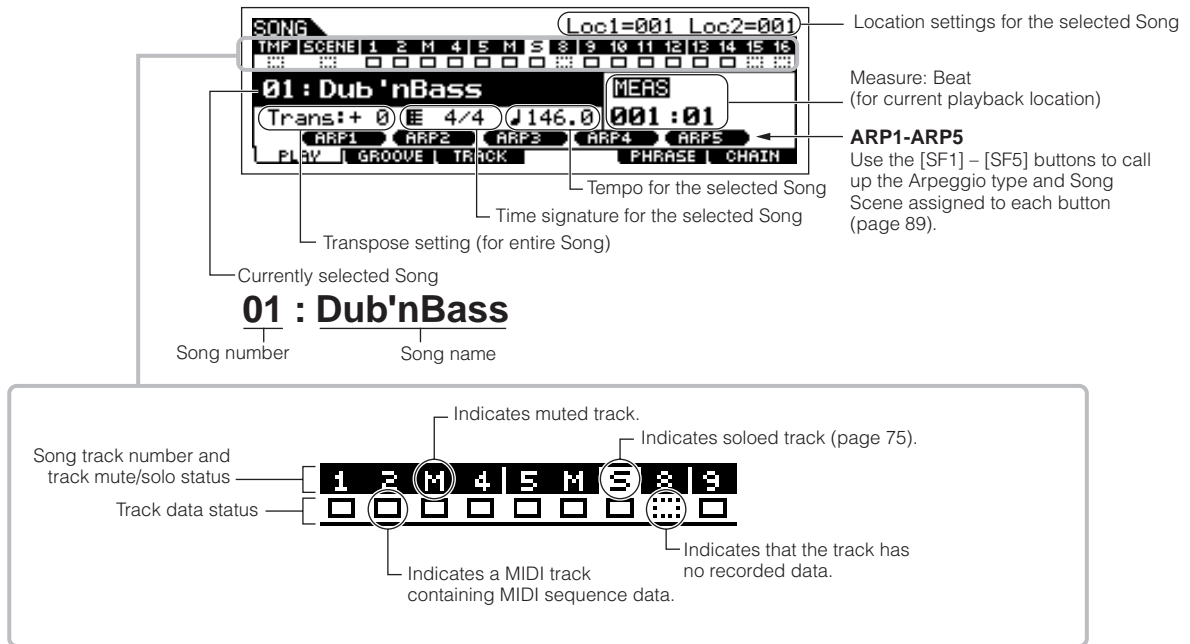

NOTE The explanations here also apply to the Pattern mode.

4 Press the [▶] (Play) button to start Song playback.

When playback of the selected Song is finished, the Song automatically stops.

You can stop the Song anytime during playback by pressing the [■] (Stop) button. This pauses the Song at the current position. To resume playback of the Song from that point, press the [▶] (Play) button again. To instantly return to the beginning of the Song, press the [◀] (Top) button.

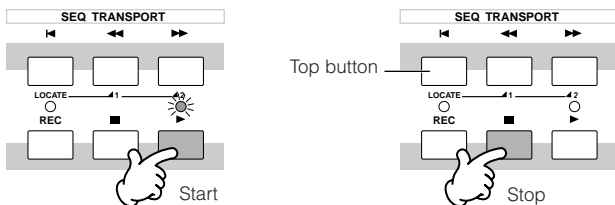

5 Select and play another Demo Song.

Move the cursor to "Song Number: Name" (with the cursor buttons) then select another Song by using the Data Dial, or the [INC/YES] and [DEC/NO] buttons.

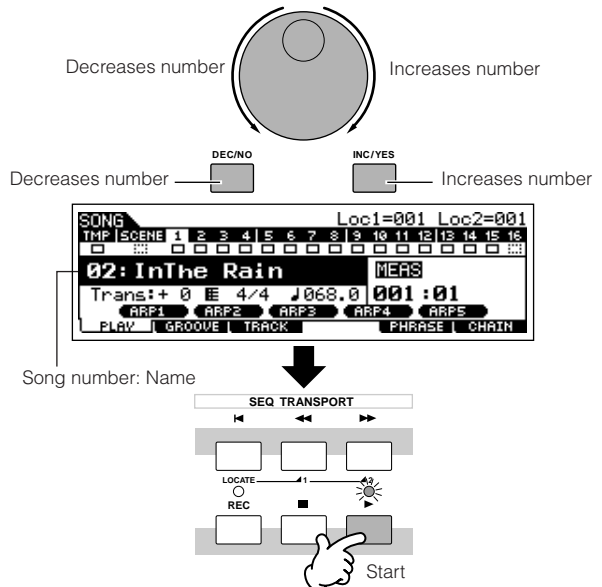

Next, let's play a Demo Pattern.

6 Press the [PATTERN] button to enter the Pattern mode.

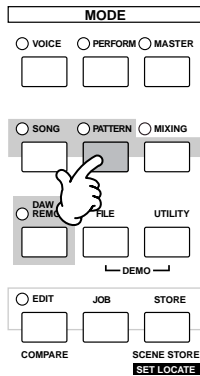

7 Press the [▶] (Play) button to start Pattern playback.

There is another way to start Pattern playback—by pressing the notes on the keyboard. Move the cursor to the keyboard icon and press the [INC/YES] button so that the mark appears. In this status, press any key to start the Pattern playback.

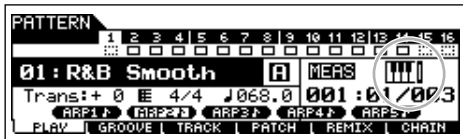

8 Try out various rhythm variations by changing the Section.

Make sure that the [SECTION] lamp is on (press the button if necessary), then press any of the buttons shown below to select and play the various Sections contained in a Pattern. Pressing the [A] – [H] buttons calls up Sections A – H and pressing the [PRE1] – [–] buttons calls up Sections I – P.

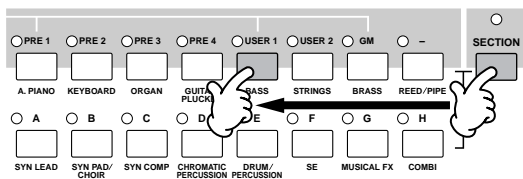

NOTE Some Sections of the Demo Pattern may have no data. Because of this, selecting some Sections may result in no sound.

9 Press the [■] (Stop) button to stop Pattern playback.

Unlike Song playback, Pattern playback continues in a loop until the [■] (Stop) button is pressed. You can stop the Pattern anytime during playback by pressing the [■] (Stop) button. This pauses the Pattern at the current position. To resume playback of the Pattern from that point, press the [▶] (Play) button again. To instantly return to the beginning of the Pattern, press the [◀] (Top) button.

10 Select and play another Demo Pattern.

Selecting a Pattern is done in the same way as selecting a Song. Refer to step 5 above.

Using Mute/Solo with the Song and Pattern tracks

Try this with the Demo Songs to hear how the tracks sound both in isolation and in various combinations.

To mute a track

1 Press the [MUTE] button (the lamp lights).

2 Press any of the NUMBER [1] – [16] buttons to select the track number to be muted.

The corresponding track is set to mute (its lamp goes off) and produces no sound. When pressing the same number button again, the track mute is canceled (its lamp lights).

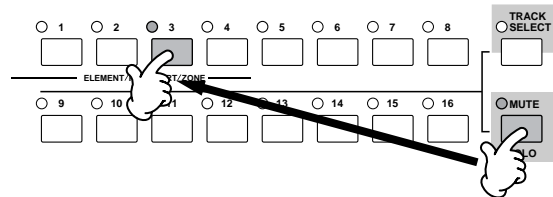

To turn Mute off, press the [MUTE] button again (the lamp goes off).

To solo a track

Simultaneously hold down the [MUTE] button and press one of the Number buttons [1] to [16] to solo the corresponding track. Once you've selected a track for soloing, the [MUTE] button's lamp flashes, indicating the Solo function is active.

While Solo is active, you can change the soloed track simply by pressing the corresponding Number button [1] to [16]. To cancel the Solo function, press the [MUTE] button again.

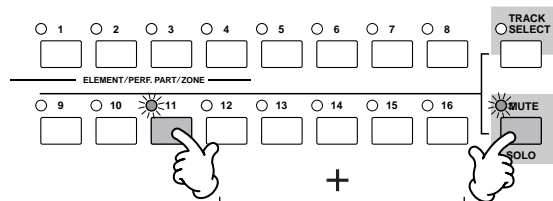

Creating a Pattern

When you create a Song, one of the most essential aspects is the rhythm. It is almost always the first thing you start with, and provides a foundation for the rest of the music. The Pattern mode gives you the tools to create rhythm patterns for the accompaniment of the Song. Here, in brief, are the basic steps in using Patterns to create a Song:

- 1) In the Pattern mode, create and chain together the phrases that will be used for the accompaniment and the Song.
- 2) Convert the Pattern data to a Song.

The following three methods can be used to create a Pattern.

- Creating a Pattern by Preset Phrases and Arpeggio
- Creating a Pattern by User Phrases
- Creating a Pattern with Realtime and Step recording

CAUTION

The created Song and Pattern data resides temporarily in DRAM (page 150). Because data contained in DRAM is lost when the power is turned off, you should always store any data residing in DRAM to a USB storage device before turning off the power.

Setting up for Creating a Pattern (Mixing Settings)

First, select the desired Pattern and assigned the Voice to each track.

1 Press the [PATTERN] button to enter the Pattern Play mode.

Select the Empty Pattern.

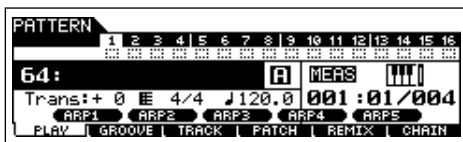

2 Press the [MIXING] button, then [F2] VOICE button to call up the display for setting a Voice.

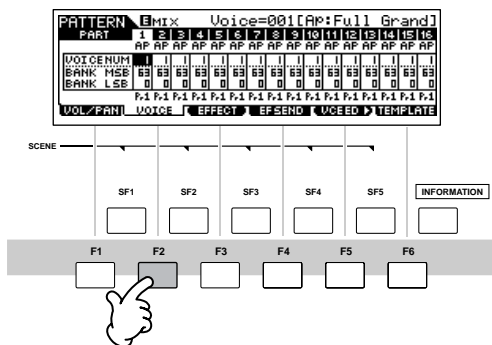
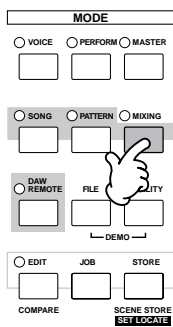

3 Select a track (Part) to which you want to assign a Voice.

Press the [TRACK SELECT] button so that its lamp lights, and select a track (Part) by pressing the one of the Number buttons [1] to [16]. You can now play the Voice of the selected track from the keyboard.

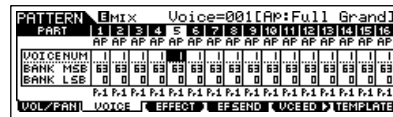
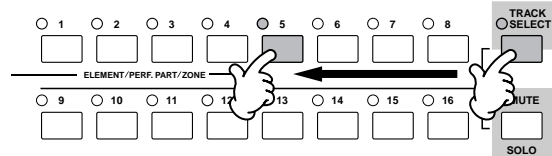

NOTE You can also select the Part by using the Cursor [\leftarrow] [\rightarrow] buttons.

4 Select the desired Voice.

Turn the [TRACK SELECT] button off, and select the Voice normally, in the same way as in Voice mode. You can also use the Category Search function.

NOTE You can also select the Voice Number or Voice Bank directly with the "VOICE NUM" or "BANK MSB/BANK LSB" parameters. Refer to the separate Data List booklet for details.

NOTE When selecting the Mixing Voice, move the cursor to the "BANK MSB/BANK LSB" and select "mv," then move the cursor to "VOICE NUM" and select the Voice Number. For details on the Mixing Voice, see page 78.

5 Repeat steps 3 and 4 above to assign the Voice to each track (Part).



6 Store the Mixing settings.

Press the [STORE] button (the display below appears). Press the [ENTER] button to store the Mixing settings with the Pattern.



CAUTION

The created Song and Pattern data resides temporarily in DRAM (page 150). Because data contained in DRAM is lost when the power is turned off, you should always store any data residing in DRAM to a USB storage device before turning off the power.

NOTE You can store the Mixing settings as a Mixing Template. For details on the Mixing Template, see below.

NOTE You can also make settings for the volume, pan, effects and equalizer, as well as the Voice. For details, see page 93.

TIP Selecting the Voices by using the Mixing Template

A total of 32 Mixing settings, each designed for a different music category or genre, have been programmed and stored as convenient Mixing Templates. Each Mixing Template includes the Voices, effects, pan and other settings suitable for the corresponding music genre. Simply dial up the template that comes closest to the type of Song or Pattern you wish to create, tweak the settings as desired, then start recording.

NOTE You can also store the Mixing settings you've created in the MO as an original Mixing Template. For details, see page 94.

- 1** Press the [PATTERN] button to enter the Pattern Play mode.
- 2** Press the [MIXING] button, then press the [F6] TEMPLATE button to call up the display for setting a Template.

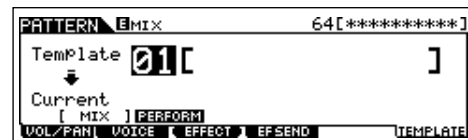

- 3** Select the desired Template by using the [INC/YES] and [DEC/NO] buttons or the data dial. As soon as a Template is selected, the relevant Mixing settings will be automatically loaded.
- 4** Play the keyboard to check the Mixing settings. Press the [TRACK SELECT] button so that its lamp lights, and select a Part by pressing the one of the Number buttons [1] to [16].

TIP Creating Mixing Voices exclusively for Songs/Patterns

If you assign User Voices to your Song or Pattern and then edit them (in the Voice Edit mode), the Voices may sound different than expected. This convenient feature lets you create dedicated Mixing Voices for your Songs and Patterns—ensuring that the Voices will play exactly as they were edited for the Song/Pattern. The Mixing Voice can be stored with the Song or Pattern.

NOTE Only Normal Voices can be created/edited as Mixing Voices.

- 1 Enter the Song mode/Pattern mode and select the Song number/Pattern number.
- 2 Press the [MIXING] button (the lamp lights), then select the Part containing the desired Voice.

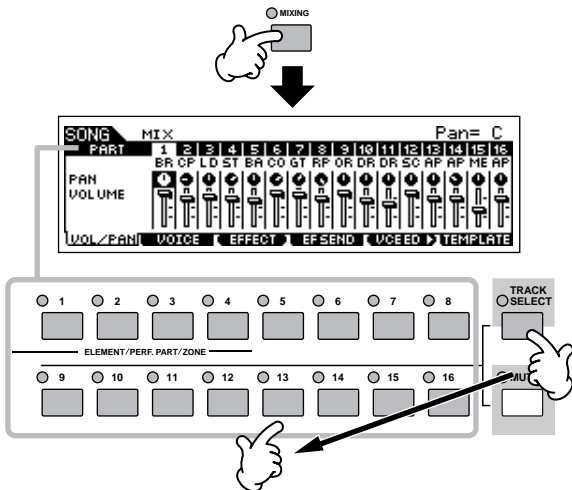

- 3 Press the [F5] VCE ED (Voice Edit) button to enter the Mixing Voice Edit mode.

NOTE The Mixing Edit mode can only be entered when selecting a Part to which a Normal Voice has been assigned.

- 4 Call up the Common Edit or Element Edit display as required.

These displays are the same as in the Voice mode. See page 203.

- 5 Store the edited Mixing Voice to internal User memory with the Song/Pattern.

5-1 Press the [STORE] button to enter the Mixing Voice Store mode.

5-2 Set the destination Voice Bank to "MIXV" and select the destination Voice number. You can store the Voice edited in the Mixing Voice Edit mode as a User Normal Voice by setting the Voice Bank to "USER1" or "USER2."



5-3 Press the [ENTER] button to execute the Store operation.

CAUTION

The created Song and Pattern data resides temporarily in DRAM (page 150). Because data contained in DRAM is lost when the power is turned off, you should always store any data residing in DRAM to a USB storage device before turning off the power.

Creating a Pattern by Preset Phrases and Arpeggio

Naturally, you can create phrases and Patterns by recording your own keyboard performance in real time. However, the MO has convenient features—preset phrases and the Arpeggio function—that let you quickly and easily select backing parts and phrases suitable for various music genres and styles.

First, we'll record a performance to Section A, using the Preset Phrases of the Drum patterns, as well as some guitar and bass guitar Arpeggio phrases.

Selecting a Drum pattern from Preset Phrases

- 1 Press the [PATTERN] button, then select the Pattern you stored in the section "Setting up for Creating a Pattern (Mixing Settings)" on page 76.

In the example here, we'll use a Pattern that consists of the following:

- Track 1: Drums
- Track 2: Bass guitar
- Track 3: Guitar
- Track 4: Piano
- Track 5: Strings

- 2 Turn the [SECTION] button on, then press the [A] button.

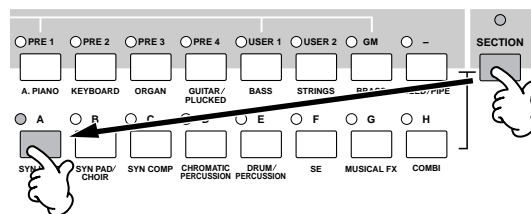

3 Set the meter (time signature), tempo, and length.

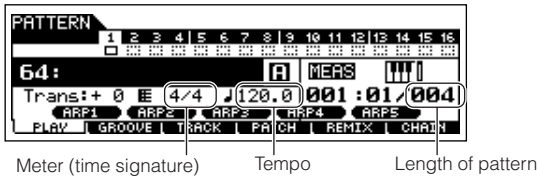

4 Press the [F4] PATCH button to call up the Patch display.

5 Select Track 1, then select one of the settings Dr 1 to Dr 4 in the category. Next, select a Phrase Number.

Press the [▶] (Play) button to hear the Drum Pattern. Try out some different drum patterns here.

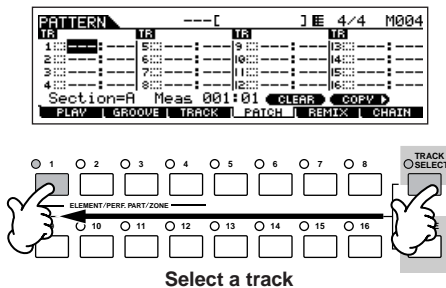

Indicates the category of the preset Phrases

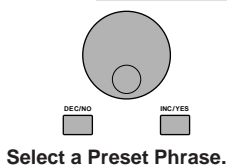
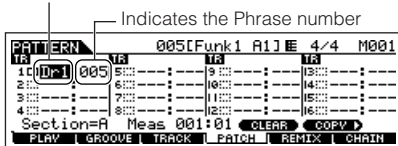

Select a Preset Phrase.

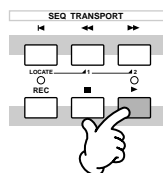

Play the Pattern to confirm the assigned Phrase.

6 Press the [■] button to stop playback.

Press the [F1] PLAY button to return the Pattern Play mode.

TIP User Phrases

In addition to the Preset Phrases, you can store MIDI data you've recorded in the Pattern mode as User Phrases. User Phrases have the added benefit of being able to use the sounds of other instruments, letting you record bass, guitar, piano and other parts as well as drums and percussion. For details, see page 81.

TIP Turning the Phrase Voice on or off

In the default settings, when assigning a Phrase to each track, the track's current Voice will be changed to the Voice stored in the Phrase (Phrase Voice). If you do not want to change the Voice and you want to use only the MIDI sequence data, set the following parameter for the track to off.

[F3]TRACK → [SF3]TR VOICE

When setting the parameters as shown in the display below, the original Voice in Track 3 will be used, even if a Phrase is assigned to the track. If you assign Phrases to other tracks (those with the "On" setting), the Voices stored in the assigned Phrase will be used.

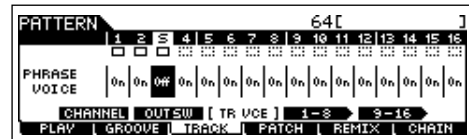

Next, let's record the bass guitar, guitar, and piano by using the Arpeggio function.

Creating a Pattern by Arpeggio

Record a bass guitar pattern.

7 Select a track to which the bass guitar will be assigned.

Press the [TRACK SELECT] button so that its lamp lights, and select a track by pressing the Number [2] button.

8 Press the [REC] button to enter the Pattern Record mode.

Set the parameters related to recording in the [F1] SETUP display. Set Type to "replace," set Loop to "off," and set Quantize to "off."



TIP Type, Loop, and Quantize

Type

The “replace” setting lets you overwrite an already recorded track with new data. The first recording is lost, and the new one takes its place. The “overdub” setting lets you record (layer) additional data to a track that already contains data. These methods are both realtime recording methods. The “step” setting (Step recording) allows you to compose your performance by “writing” it down one event at a time. For details, see page 82.

Loop

This function plays back the Pattern repeatedly in a “loop.” If Type is set to “overdub” and Loop to “on,” you can add separate notes or parts in order. For example, you could record the parts of a drum kit one by one—recording the kick on the first pass, a snare on the second, a hi hat part on the third, and so on. This technique is also convenient for adding non-note, sound-shaping data, such as that of the Knobs and Controller.

Since we will be recording with the Arpeggio in this example, set Loop to “off” here.

Quantize

Record quantize aligns the timing of notes in real time, as you record. This makes sure that all the notes will be recorded exactly on the beat, even if your playing is somewhat off the beat.

Since we will be recording with the Arpeggio in this example, set Quantize to “off” here.

9 Set the PartSw (Part Switch) parameters to off in the [F3] ARP display.

When setting the parameter to on, you can use the Arpeggio on this track.

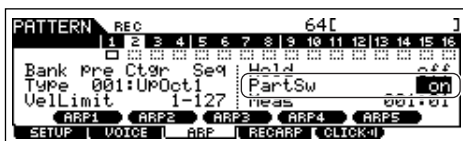

10 Set the Arpeggio Bank, Category, and Type.

Set the Bank to “pre” and Ctr (category) to “Bass.” Try out some different bass patterns here.



NOTE In addition using the preset Arpeggios, you can also create your own original Arpeggio data. See page 97.

11 Set the RecArp parameter to on in the [F4] RECARP (Record Arpeggio) display.

When this parameter is set to on, you can record the Arpeggio playback to the track as MIDI sequence data.

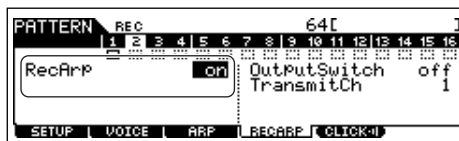

12 Press the [F5] CLICK button to turn Click on and play the metronome during the recording.

When the “sound” icon below is displayed, Click is on and the metronome will play during the recording.

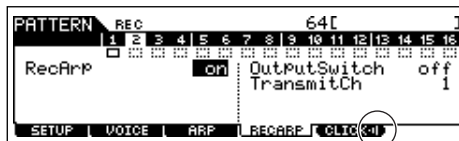

13 Press the [▶] (Play) button to start recording.

Play a note or notes on the keyboard to trigger Arpeggio playback. The root chord of the bass pattern changes depending on the key you play.

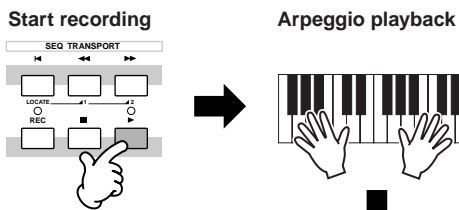

Actual recording starts after one measure. Recording stops automatically when Pattern playback reaches the end, since Loop is set to “off.”

14 Turn the [ARPEGGIO ON/OFF] indicator off, and press the [▶] (Play) button to hear your newly recorded bass guitar pattern.

Next, let’s record the guitar pattern.

15 Select the track to which the guitar will be assigned.

Press the [TRACK SELECT] button so that its lamp lights, and select a Part by pressing the Number [3] button.

16 Record the guitar part using the Arpeggio, in the same way you did with the bass guitar part above.

Follow steps 8–14 above, this time selecting the “GtPl” (Guitar & Plucked) in the Arpeggio category, and try out the various guitar phrases.

MIDI data recorded in the Pattern mode is stored as a User Phrase. You can store up to 256 User Phrases to a single Pattern.

Next, let's use the Pattern Copy function and record our User Phrases to Section B.

Copying Patterns and Creating a Pattern with User Phrases

In the following steps, you'll assign the same phrases as the drum and bass guitar parts of Section A to the drum and bass parts of Section B, and create a guitar part playing the guitar and bass in unison.

Copying a Pattern

In order to assign the drum and bass phrases of section A to section B, we'll copy the performance of Section A to section B.

- 1 Press the [PATTERN] button to enter the Pattern Play mode, then press the [JOB] button to enter the Pattern Job Mode.
- 2 Copy the Pattern in the [F6] PATTERN display.

Select "01: Copy Pattern" and press the [ENTER] button.

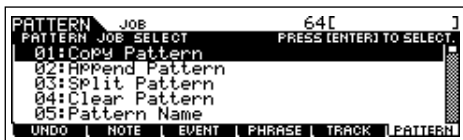

- 3 Select the Pattern Numbers and Sections for both the source and destination.
- Select the Pattern number you created earlier and Section A for the source. Select the same Pattern number and Section B for the destination.

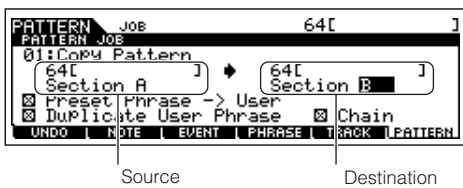

- 4 Press the [ENTER] button, then press the [INC/YES] button to execute the Copy operation.
- 5 Press the [EXIT] button several times to go back to the Pattern Play mode.
- 6 Turn the [SECTION] button on, then press the [B] button.

Section B is selected. Press the [▶] (Play) button to play back and confirm the copied Pattern.

Creating a Pattern with User Phrases

Have the guitar and bass play together by using the user phrase of the bass recorded in Section A.

- 7 Press the [F3] TRACK button, then press the [SF3] TR VCE button to call up the Phrase Voice display.
- Set the Phrase Voice parameter in Track 3 (Guitar) to off. You can use only MIDI sequence data in the User Phrase.

NOTE If you leave the Phrase Voice setting at "on," the Voice will change when using the user phrase for the guitar part in step 8.

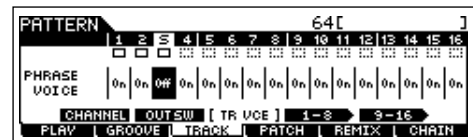

- 8 Press the [F4] PATCH button to call up the Patch display.

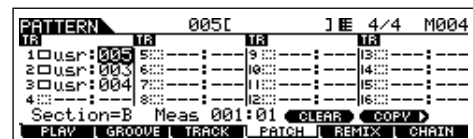

- 9 Set the Pattern so that the user phrase of the bass of Track (Part) 2 will be used for Part 3.
- Select the phrase number of Part 3 and set it to the same phrase number of the bass phrase of Part 2.

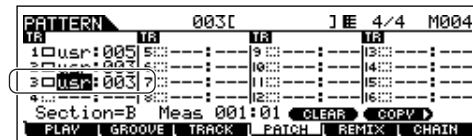

- 10 Press the [▶] (PLAY) button to play back Section B.
- Adjust the octave and velocity of the guitar phrase as desired from the [F2] NOTE screen of the Pattern Job mode.

CAUTION

The same User Phrases can be assigned to different Sections within a pattern. Keep in mind, however, that the Section data will automatically be changed if another Section sharing the same User Phrase is changed.

TIP Copying a User Phrase from another Pattern to the current Pattern

The User Phrases that can be assigned with the Patch function are limited to the ones contained in the currently selected Pattern. To copy Phrases from other Patterns for use in the current one, follow the instructions below.

- 1 In the [F4] PATCH display, press the [SF5] COPY button to call up the Copy Phrase display.
- 2 First, specify the source Pattern number and Phrase number as well as the destination (current Pattern) Phrase number and track number. Then, press the [ENTER] button to execute the Copy operation.

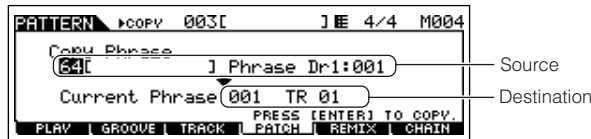

- 3 Press the [EXIT] button to return to the [F4] PATCH display, then check the assigned Phrase by pressing the [▶] (Play) button to play the Pattern.

Next, record Section C by using realtime recording or step recording.

Creating a Pattern with the Realtime and Step Recording methods

For Section C, set the drums, bass and guitar to the same as section A, and then add a piano part using Realtime recording, and enter a strings part by using Step recording. Here we'll also adjust the rhythmic feel of the phrase by using the Groove function.

Creating a Pattern with Realtime recording

- 1 Copy Section A to Section C, following the instructions in the section "Copying a Pattern" on page 81.

- 2 Select the track to which the piano part is to be assigned.

Press the [TRACK SELECT] button so that its lamp lights, and select the track for the piano part by pressing the Number [4] button.

- 3 Press the [REC] button to enter the Pattern Record mode.

Set the parameters related to recording in the [F1] SETUP display.

Set Type to "overdub" and Loop to "on." These settings let you repeat the Pattern recording in a "loop" and record additional note events without deleting already-recorded data. For the other parameters, see page 198.

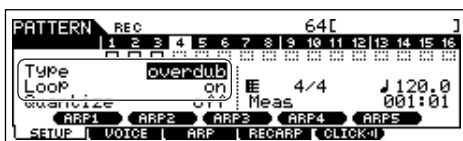

- 4 Press the [▶] (Play) button to start recording.

- 5 When the recording is finished, press the [■] (Stop) button to stop recording.

Press the [▶] (Play) button to hear your newly recorded Pattern.

Creating a Pattern with Step recording

Next, we'll add a strings part by using the Step recording method.

- 6 **Select the track to which the strings part is to be assigned.**

Press the [TRACK SELECT] button so that its lamp lights, and select the track for the strings part by pressing the Number [5] button.

- 7 **Press the [REC] button to enter the Pattern Record mode.**

- 8 **Set the Type parameter to "step" in the [F1] SETUP display.**

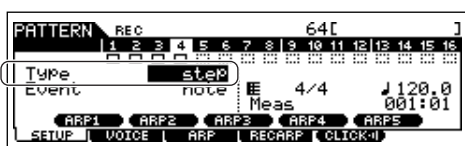

- 9 **Press the [▶] (Play) button to start the recording.**

For details about Step Recording, see page 193.

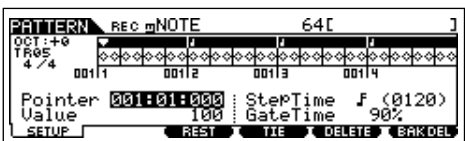

- 10 **Press the [■] (Stop) button to stop the recording.**

Press the [▶] (Play) button to hear your newly recorded Pattern.

CAUTION

The created Song and Pattern data resides temporarily in DRAM (page 150). Because data contained in DRAM is lost when the power is turned off, you should always store any data residing in DRAM to a USB storage device before turning off the power.

Using the Groove function

The Groove function makes it possible to adjust the pitch, timing, length, and velocity of notes in a specified track via a 1-measure 16th-note grid to create interesting, unique "grooves" that would not be possible with precise sequencer-like programming.

NOTE The Groove settings are applied to all measures of the current Pattern. Keep in mind that you cannot apply different Groove settings to each measure.

NOTE The Grid Groove function affects Pattern playback without actually changing the MIDI sequence data (created via the Recording, File Loading, and Patch functions). The Groove settings are handled separately from MIDI sequence data. See page 137.

- 1 **In the Pattern Play mode, select a Pattern and Section for which the Groove is to be applied.**

- 2 **Press the [F2] GROOVE button to call up the Groove setting display.**

TIP Rehearsing parts before recording

To temporarily disengage the record mode and enter the "Rehearsal" mode, simply press the [REC] button during realtime recording—the [REC] indicator will flash and playback will continue uninterrupted but no data will be recorded. This convenient Rehearsal mode lets you easily and temporarily disable recording, in order to practice a part or try out various ideas (while listening to the other tracks) without actually recording. To return to the record mode press the [REC] button again—the [REC] indicator will light continuously.

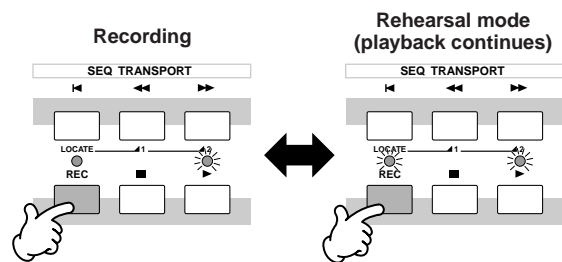

TIP Editing the recorded Pattern

The Pattern Edit mode and Pattern Job mode can be used to edit or change the data of the already recorded Pattern.

The Pattern Edit mode lets you change the recorded data and insert new data if needed. This includes note data as well as non-note data, such as program (Voice) changes and MIDI control change messages. The Pattern Job mode on the other hand provides a comprehensive variety of tools you can use to transform the recorded data—such as cleaning up the timing (Quantize), transposing, changing the velocity of notes, modifying the length of notes, and other useful operations for altering the sound. It also includes a variety of convenient operations, such as copying or erasing data. Most of these operations can be performed on either an entire track or a selected range of measures in the track.

The procedure is basically the same as in the Song mode. See page 90.

3 Select a track, then adjust the Groove settings.

Select a track.

Set each parameter.

Move the cursor... Set the value.

Play the Pattern to check the result of the Groove settings.

Move the cursor to the desired parameter and grid point and set the offset value.

NOTE OFST (Note Offset)	Raises or lowers the pitch of the note(s) on the selected grid in semitones.
CLOCK SFT (Clock Shift)	Shifts the timing of the note(s) on the selected grid forward or backward in clock increments.
GATE OFST (Gate time Offset)	Lengthens or shortens the note(s) on the selected grid in clock increments.
VELO OFST (Velocity Offset)	Increases or decreases the velocity of the note(s) on the selected grid.

NOTE You can also edit the Groove parameters in real time during playback.

CAUTION

The created Song and Pattern data resides temporarily in DRAM (page 150). Because data contained in DRAM is lost when the power is turned off, you should always store any data residing in DRAM to a USB storage device before turning off the power.

TIP Using the Groove settings to change the Pattern data

Grid Groove is a playback-only feature that processes the recorded data of a Pattern without actually changing it. In other words, the original data (created via the Recording, File Loading and Patch functions) remains intact. If you want to make the Grid Groove settings permanent and change the data, use Normalize Play Effect in the Pattern Jobs ([PATTERN] → [JOB] → [F5] TRACK → 04: Normalize Play Effect). From this display, specify the track to be changed according to the Groove settings, and press the [ENTER] button to execute.

Creating a Pattern Chain

Each Pattern consists of 16 Sections (A – P) which can be used as Pattern variations. Create the desired rhythm Pattern variations, or Sections, that you wish to use as accompaniment and backing for your new Song, according to the instructions in the previous sections. After you've created the Sections, you can string these Sections together in any order desired to assemble the backing part of the Song, over which you can record a melody line and any other parts, in the Song Record mode.

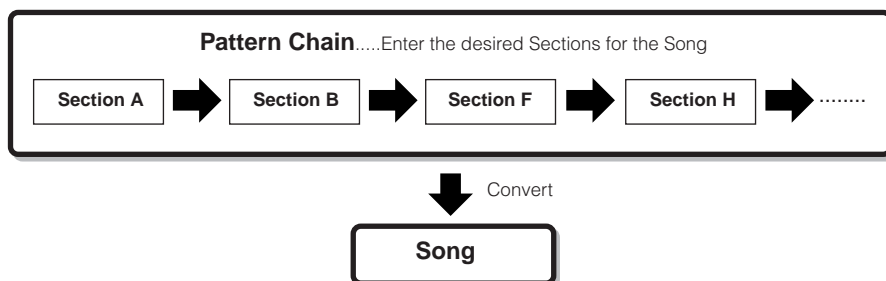

NOTE Pattern Mixing, Groove, and Phrase Voice (Track Voice) on/off cannot be set independently for each Section, but apply to all Sections.

CAUTION

The same User Phrases can be assigned to different Sections within a pattern. Keep in mind, however, that the Section data will automatically be changed if another Section sharing the same User Phrase is changed. For example, if you've assigned a certain User Phrase to both Section A and Section D, and you change that User Phrase for Section A, the same Phrase will be changed for Section D as well.

Creating a Pattern Chain by changing a Section while playing a Pattern

Switching of sections, track muting, scene/mute changes, and tempo changes can all be recorded in real time as a Pattern Chain.

- 1 In the Pattern Play mode, select a Pattern for which data has already been created.
- 2 Press the [F6] CHAIN button to call up the Pattern Chain Play display.
- 3 Press the [REC] button to enter the Pattern Chain Record mode, then set the basic parameters.

In the Pattern Chain Record Setup display, you can set the Recording track and tempo. Three Pattern Chain track types are available. The Tempo track lets you record tempo changes for the Chain, and the Scene track lets you record track on/off changes. The Pattern ("patt") track lets you record Section changes at the desired measure points in the Song.

Pattern Chain Play display

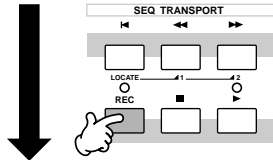

Pattern Chain Record Setup display

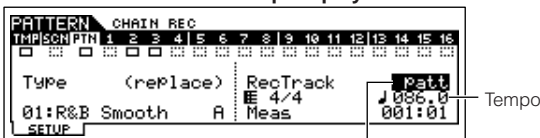

Set the recording track to "patt" and enter the Sections to the desired measures.

- 4 Press the [▶] button to start recording and play the Pattern as you like.

Change the Section at the desired points, as the Pattern plays.

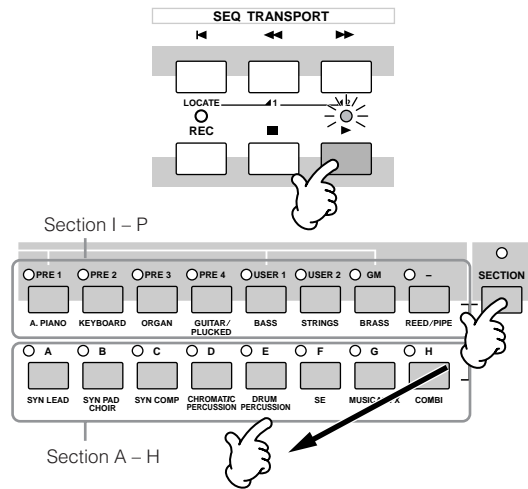

- 5 Press the [■] (Stop) button to stop recording.

Operation returns to the Pattern Chain display.

- 6 Press the [▶] (Play) button to hear the recorded Pattern Chain.

- 7 Save the created Pattern data to a USB storage device (page 98) before turning the power off.

You can also record the Tempo track and Scene track as desired. When the recording track is set to "tempo," move the cursor to tempo value (during recording in step 4 above) and use the data dial and the [INC/YES]/[DEC/NO] buttons to change the tempo while the Chain is playing. When the recording track is set to "scene," press the [MUTE] button (the lamp lights) and use the Number buttons [1] – [16] to turn each track on/off as desired during recording.

Editing a Pattern Chain

The Pattern Chain Edit mode makes it possible to edit the order of the Sections in a chain, as well as insert tempo and scene/mute event data.

- 1 In the Pattern Play mode, select a Pattern for which data has already been created.
- 2 Press the [F6] CHAIN button to call up the Pattern Chain Play display.
- 3 Press the [EDIT] button to enter the Pattern Chain Edit mode, then edit each track of the Pattern Chain.
- 4 Press the [EXIT] button to return to the Pattern Chain Play display, then press the [▶] (Play) button to hear the edited Pattern Chain.
- 5 Save the created Pattern data to a USB storage device (page 98) before turning the power off.

EDIT

Pattern Track Edit

MEAS	4/4	SECTION
001	4/4	A
002	4/4	C
003	4/4	B
004	4/4	C
005	4/4	C

Enter the desired section (A - P) or the End mark by using the [INC/YES] and [DEC/NO] buttons. [F4] button

Press the [F6] button to clear the event at the cursor location.

Scene Track Edit

MEAS	1-000	Track Mute
001	1-000	Track Mute
001	3-000	Track Mute
001	4-360	Track Mute
001	4-360	END

Press the [F5] button to insert the event to the cursor location.

Press the [F6] button to delete the event at the cursor location.

Tempo Track Edit

MEAS	1-000	81	120.0
001	1-000	81	120.0
001	1-001	81	124.0
001	1-054	81	124.0
001	1-173	81	126.0

Converting a Pattern Chain to Song data

Once you've made a Pattern Chain, you can convert the data and create a Song with it.

- 1 In the Pattern Play mode, select a Pattern for which Pattern Chain data has already been created.
- 2 Press the [F6] CHAIN button to call up the Pattern Chain Play display.
- 3 Press the [EDIT] button to enter the Pattern Chain Edit mode.
- 4 Press the [F3] SONG button to call up the "Convert to Song" display, then specify the destination Song.

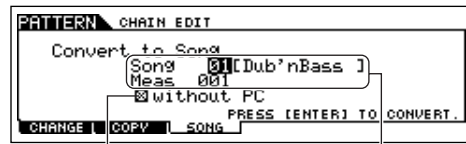

When this box is checkmarked, program change messages in the MIDI sequence data are not copied.

- 5 Press the [ENTER] button to execute the Convert operation.

The Pattern Chain data is converted to Song data and copied to the top measure of the destination Song.

CAUTION

This operation overwrites any data already existing at the destination Song.

- 6 Save the created Song data to a USB storage device (page 98) before turning the power off.

CAUTION

The created Song and Pattern data resides temporarily in DRAM (page 150). Because data contained in DRAM is lost when the power is turned off, you should always store any data residing in DRAM to a USB storage device before turning off the power.

Creating a Song

The following chart illustrates the basic procedure for creating a Song, using the various methods and functions described in this tutorial. Now, that you've assembled the backing tracks for your Song by converting the Phrases or Pattern Chain to Song data, you can now record melody parts on them.

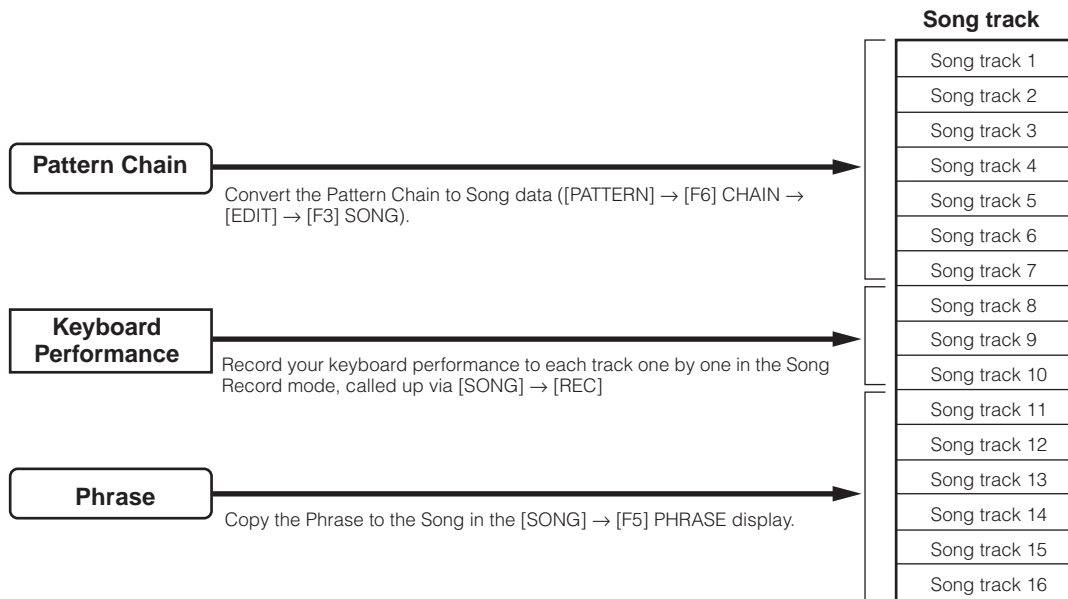

CAUTION

The created Song and Pattern data resides temporarily in DRAM (page 150). Because data contained in DRAM is lost when the power is turned off, you should always store any data residing in DRAM to a USB storage device before turning off the power.

Creating a Song with Pattern Chain

You can easily create the backing parts for your performance and/or singing by combining the Patterns you created in the Pattern mode. For details, see page 84.

Recording with the keyboard to a Song track

Arpeggio, Realtime Recording/Step Recording, Groove function

In the Song mode, you can use the Arpeggio, Realtime Recording/Step Recording, and Groove function in the same ways as you did in the Pattern mode. The procedure is basically the same as that of the Pattern mode.

Re-recording a specific part of a Song (Punch In/Out)

In the Song mode, use the Punch In/Out recording method to record over only a specific portion of the track. In the example instructions below, you'll see how to re-record measures three through five of an already recorded Song.

Quick Guide

Creating a Song on the MO

1 In the Song Play mode, select a Song to be created.

2 Press the [REC] button to enter the Song Record mode.

3 Press the [TRACK SELECT] button (the lamp lights), then select the desired track with the number buttons [1] – [16].

4 Set the parameters related to recording in the [F1] SETUP display.

Set the Type parameter to "punch" and specify the area to be re-recorded.

Set other parameters as necessary. For details, see page 179.

Punch In (Recording start measure: beat)

Playback of the recording track is turned off from this point, and your keyboard performance will be recorded to the track.

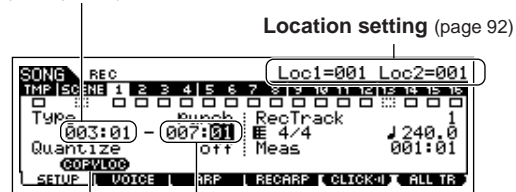

Punch Out (Recording end measure: beat)

Recording ends at this point and normal playback of the recording track starts.

Press the [SF1] COPY LOC to assign the measure numbers registered to the Locations (Loc1 and Loc2) to the Punch In and Punch Out points.

5 Press the [▶] (Play) button to start the recording.

When Song playback reaches the Punch In point, play the keyboard.

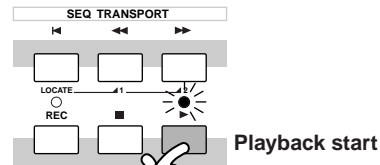

When Song playback reaches the Punch In point, play the keyboard.



6 Press the [■] (Stop) button to stop recording after the Song playback reaches the Punch Out point.

7 Press the [▶] (Play) button to hear your newly recorded Song.

8 Save the Song data to a USB storage device in the File mode (page 98) before turning the power off.

Punch In/Out recording is available only in the Song Record mode. This is not available in the Pattern Record mode.

TIP Insert a Tempo change event to the middle of the Song

You can use the following three methods to change the tempo in the middle of an already-recorded Song.

● Using the Tempo track

Start recording after setting the Type parameter to "replace," setting RecTrack to "tempo," and moving the cursor to the tempo value in step 4. During recording, change the tempo value in real time while listening to Song playback.

● Song Edit

In the Song Play mode, press the [EDIT] button to enter the Song Edit mode. Select the Tempo track (TMP) by pressing the [F4] TR SEL button once or twice, then change the existing tempo value or insert a new tempo value by using the [F5] INSERT button. For details about Song Edit, see page 90.

● Step Recording

In step 4, set the Type parameter to "step" and RecTrack to "tempo" then press the [▶] (Play) button to start Step recording. After moving the cursor to "Value," move the Song pointer by using the [▶▶] (Forward) button and change the tempo value at the desired point, then enter the value by pressing the [ENTER] button. For details about Step Recording, see page 82.

TIP Song Recording using a Performance

If you have a favorite Performance or one that would fit the Song to be recorded, you can copy certain settings of up to four Parts of the Performance to the Song Mixing settings currently being edited.

- 1 Enter the Song Mixing Job mode ([SONG] → [MIXING] → [JOB]).
- 2 Press the [F5] PF COPY button to call up the Performance Copy display.
- 3 Set the parameters as necessary in the [F5] PF COPY display, then press the [ENTER] button to execute the Copy operation.

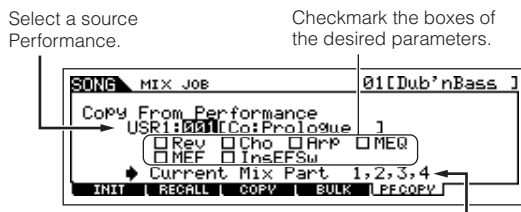

The destination Mixing Parts appear automatically. The displayed Part numbers differ depending on the source Performance. If the source Performance contains four Parts, "1, 2, 3, 4" appears here.

CAUTION

The destination Mixing Parts appear automatically. The displayed Part numbers differ depending on the source Performance. If the source Performance contains four Parts, "1, 2, 3, 4" appears here. The copy operation overwrites the Mixing settings previously existing in the destination.

- 4 Press the [SONG] button to return to the Song Play mode, then select Track 1 and play the keyboard.

Check whether the sound you hear is the same as that of the source Performance or not.
- 5 Record your keyboard performance to Track 1.
- 6 Store the Song Mixing in the [SONG] → [MIXING] → [STORE] display.

The settings copied from the Performance should be stored as Song Mixing data.
- 7 Save the Song data to a USB storage device in the File mode (page 98) before turning the power off.

NOTE The explanations here also apply to the Pattern mode.

Registering a Song Scene and Arpeggio type simultaneously to the [SF1] – [SF5] buttons

Song Scenes and Arpeggio types can both be registered to the [SF1] – [SF5] buttons (when the ARP1 – ARP5 menu items are shown at the bottom of the display). These settings are stored as Song data. Song Scene is a powerful function that allows you to store five different "snapshots" of important Song related parameters—including transpose, tempo, track mute status, and the basic sound/mixing controls (all parameter settings controllable from the Knobs with the [PAN/SEND] or [TONE] lamp turned on, and the Control sliders). You can call up both the Song Scene and Arpeggio type simultaneously by simply pressing one of the [SF1] – [SF5] buttons (when ARP1 – ARP5 are shown at the bottom in the Song mode).

● Registering a Song Scene and Arpeggio type simultaneously to the [SF1] – [SF5] buttons

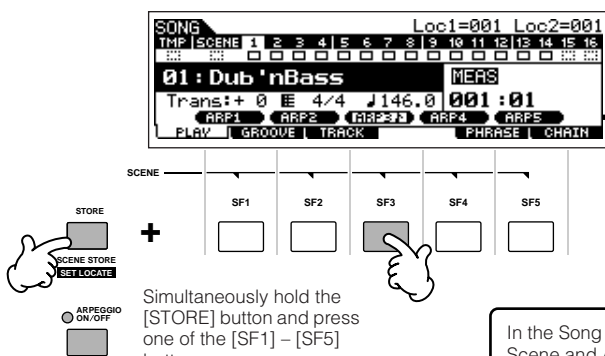

Simultaneously hold the [STORE] button and press one of the [SF1] – [SF5] buttons.

● Recalling a Song Scene and Arpeggio type simultaneously from the [SF1] – [SF5] buttons

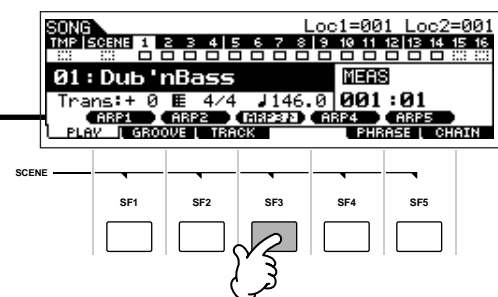

In the Song mode, you can register the Song Scene and Arpeggio type simultaneously to the [SF1] – [SF5] buttons only when the ARP1 – ARP5 menus appear at the bottom in the display.

■ Recalling a Song Scene and Arpeggio type during recording

ARP1 – ARP5 menus appear also in the [F3] ARP display in the Song Record mode as well as the [F1] PLAY display in the Song Play mode. These indicate that you can change the Song Scene and Arpeggio type simultaneously during Song recording from the [F3] ARP display.

■ Recording Song Scene changes to a Song

Each Song contains a Scene track to which you can record Scene changes. When the RecTrack is set to “scene” in step 4 described on page 88, you can record Scene changes from any display (even from those in which ARP1 – ARP5 are not shown) by pressing the [SF1] – [SF5] buttons during recording.

NOTE The explanations on Arpeggio here also apply to the Pattern mode.

NOTE As in the Voice mode and Performance mode, Arpeggio types can only be registered to the [SF1] – [SF5] buttons when the [ARPEGGIO ON/OFF] button is turned off.

NOTE For details on how to select an Arpeggio type in the Song mode/Pattern mode, see page 80.

Editing the recorded Song

The Song Edit mode and Song Job mode can be used to edit or change the data of the already recorded Song. The Song Edit mode lets you change the recorded data and insert new data if needed. This includes note data as well as non-note data, such as program (Voice) changes and MIDI control change messages. The Song Job mode on the other hand provides a comprehensive variety of tools you can use to transform the recorded data—such as cleaning up the timing (Quantize), transposing, changing the velocity of notes, modifying the length of notes, and other useful operations for altering the sound. It also includes a variety of convenient operations, such as copying or erasing data. Most of these operations can be performed on either an entire track or a selected range of measures in the track.

NOTE The explanations here also apply to the Pattern mode.

■ Editing the recorded Song data by MIDI event (in the Song Edit mode)

1 Press the [SONG] button to enter the Song Play mode, then select a Song to be edited.

2 Enter the Song Edit mode by pressing the [EDIT] button (the lamp lights), then press the [F1] CHANGE button to call up the MIDI event list display.

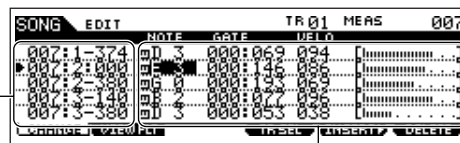
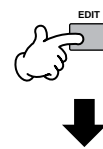

Song position

MIDI events

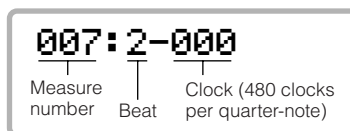

3 Select a track to be edited.

Select one of the three available track types by pressing the [F4] TR SEL (Track Select) button. Each press of the button alternates among the track types.

To select one of the Pattern tracks (1 – 16), make sure the 1 – 16 track edit display is selected (see below), then turn the [TRACK SELECT] button on and press any of the [1] – [16] buttons.

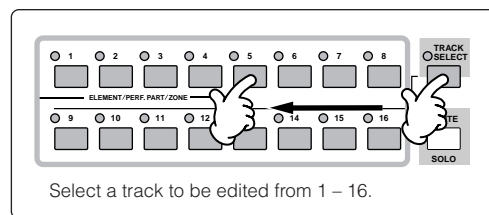

Select a track to be edited from 1 – 16.

1 – 16 track edit display



Scene track edit display

[F4] button



Tempo track edit display

[F4] button

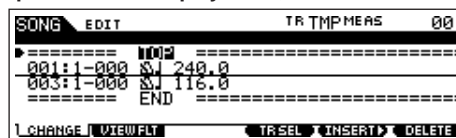

[F4] button

4 Edit the MIDI events of the Song.

● Editing/Deleting Existing Events

To edit data in the Event List, use the up/down cursor buttons to highlight the specific event you want to edit, and use the left/right cursor buttons to highlight the data type or parameter to be edited. Then, change the value as needed by using the [INC/YES] and [DEC/NO] buttons or the data dial.

The entire line of the edited event will flash on the display. Press the [ENTER] button to actually enter the edited data (the entire line of the edited event will stop flashing). To abort an edit simply highlight to a new event location without pressing the [ENTER] button.

Press the [F6] button to delete the event at the current location.

When changing the value, the entire line will flash on the display indicating this is being edited and not fixed yet.

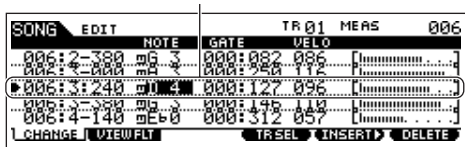

[ENTER] button

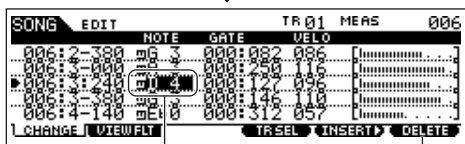

The line stops flashing and the value is actually entered.

Press the [F6] button to delete the event at the current location.

● Inserting New Events

To insert an event, use the up/down cursor buttons to highlight an event at the desired point in the track measure, beat, clock)—this is the location to which the new event will be inserted. Then, follow the steps below.

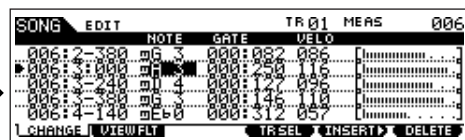

Press the [F1] button or [EXIT] button to abort and return to the main Event List display.

[F5] button

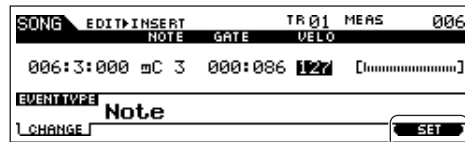

[F1] button

Press the [F6] SET button to actually insert the event shown in the display and remain in display. If you wish to insert the event type currently shown in the display several times, use [F6] SET and press the [F1] or [EXIT] button to return to the main Event List display.

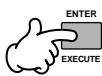

Press the [ENTER] button to actually insert the event and return to the main Event List display.

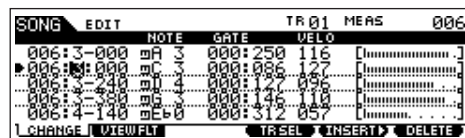

In the Event List display, you can edit various types of events such as Voice, volume, and pan as well as note events. This means that you could, for example, enter Voice changes to the middle of a track, even if the track was recorded using only one Voice.

NOTE For details about the MIDI events handled in the Event List display, see page 182.

NOTE If you find the display too cluttered, you can filter out certain event types with the View Filter. Simply press the [F2] VIEW FLT button and select the event types you want to be displayed. For details, see page 182.

5 Press the [▶] (Play) button to hear your edited data.

Since the Song can be played back from within the Song Edit mode, you can instantly hear and check the changes you've made while editing. If you want to hear just the track being edited, use the Solo function (page 75).

6 Edit other tracks as required by repeating steps 3 through 5 as desired.

7 After editing, press the [SONG] button to return to the Song Play mode.

8 Save the edited Song data to a USB storage device (page 98) before turning the power off.

■ Transforming the recorded data and other operations—Song Job mode

The Song Job mode has a wide variety of operations for changing and working with Song data. Virtually all of the Jobs share the same procedure, so we'll explain only one of them here—Quantize, which lets you clean up the timing of a previously recorded track.

In the following example, this musical passage has been written with exact quarter-note and eighth-note values.



Even though you think you may have recorded the passage accurately, your actual performance may be slightly ahead of or behind the beat (or both!). Quantize allows you to align all the notes in a track so that the timing is absolutely accurate to the specified note value.

1 Press the [SONG] button to enter the Song Play mode, then select a Song for which the Job is to be applied.

2 Press the [JOB] button to enter the Song Job mode.

As shown below, the Jobs are divided into six main groups, each of which is selected using the [F1] – [F6] buttons.

Indicates the Job List. Because all the Jobs cannot be displayed simultaneously, you will need to use the cursor buttons to scroll the display in order to find the desired Job.

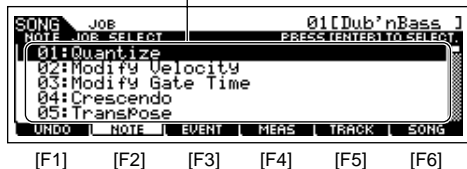

[F1] UNDO	Undo (Canceling the executed Job)/Redo (Restoring the executed Job) functions
[F2] NOTE	Note Data Job
[F3] EVENT	Event Job
[F4] MEAS	Measure Job
[F5] TRACK	Track Job
[F6] SONG	Song Job

3 Press the [F2] NOTE button, move the cursor to “01: Quantize” then press the [ENTER] button to call up the Quantize Job display.

4 Set the relevant Job parameters.

After specifying the track and range over which the Job is to be applied, set Quantize to “♪” (8th note) according to the notation example above. Set the Strength to “100%,” SwingRate to “050%,” and GateTime to “100%.” Regarding these parameters, see page 183.

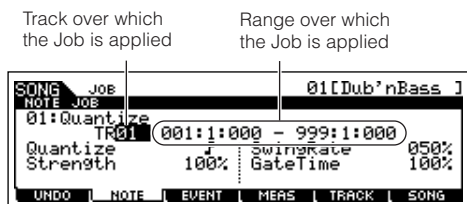

NOTE Set the Quantize value to correspond to the smallest value notes in the track you are working with. For example, if the data was recorded with both quarter notes and eighth notes, use eighth note for the quantize value.

5 Press the [ENTER] button to execute the Job.

After the Job has been completed, a “Completed” message appears and operation returns to the original display.

CAUTION

An “Executing...” message is shown when it takes a short amount of time to execute the Job. Never attempt to turn off the power while the Job is being executed. Turning the power off in this state results in loss of all user data.

6 Press the [SONG] button to return to the Song Play mode, then press the [▶] button to hear the Song over which the Job is applied.

If you are satisfied with the result of the Job, go to step 7. If not, execute the UNDO Job in the [F1] UNDO display in the Song Job mode to restore the data to its previous state, then try out the Job (from step 4) again. For details about Undo, see next page.

7 Save the Song data to a USB storage device in the File mode (page 98) before turning the power off.

In addition to Quantize, you’ll find a variety of other useful and powerful Jobs in the Song Job mode (page 183) and Pattern Job mode (page 199).

Song Location

The Song Play mode has a convenient Location function that lets you jump to user-specified parts of a Song. This lets you assign a specific measure number in the selected Song, and instantly jump to the assigned measure—either during playback or when the Song is stopped. Two Locations can be assigned.

Assigning Locations

Select the desired measure in the recorded Song for the Location. (Highlight “MEAS” and use the [INC/YES] and [DEC/NO] buttons or data dial.) Then, to assign the measure to Location 1, simultaneously hold down the [SET LOCATE] button and press the [◀◀] (Reverse) button. To assign Location 2, use the [▶▶] (Forward) button.

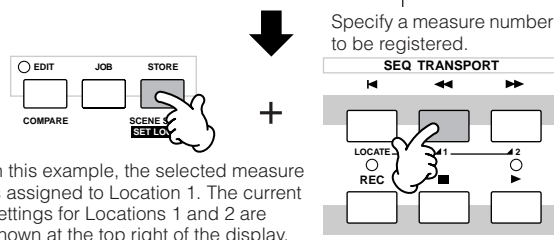
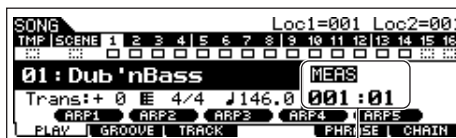

In this example, the selected measure is assigned to Location 1. The current settings for Locations 1 and 2 are shown at the top right of the display.

Jumping to an assigned Location

To instantly jump to the assigned Location 1 or 2, simultaneously hold down the [SET LOCATE] button and pressing the [◀◀] (Reverse) button (for Location 1) or the [▶▶] (Forward) button (for Location 2).

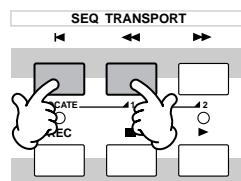

TIP Using the Undo/Redo functions

If you're not satisfied with the results of a just-executed Job, or you want to hear the difference of the sound before and after using a Job, you can use the convenient Undo and Redo functions. After changing the data with a particular Job, repeat steps 1 – 4 as desired.

1 Press the [SONG] button to return to the Song Play mode, then press the [▶] button to hear the Song as it was changed by the Job.

This lets you check the results of the Job.

2 After stopping the Song, press the [JOB] button followed by the [F1] UNDO button to call up the Undo display. Press the [ENTER] button to execute Undo.

The Song data is restored to its previous state.

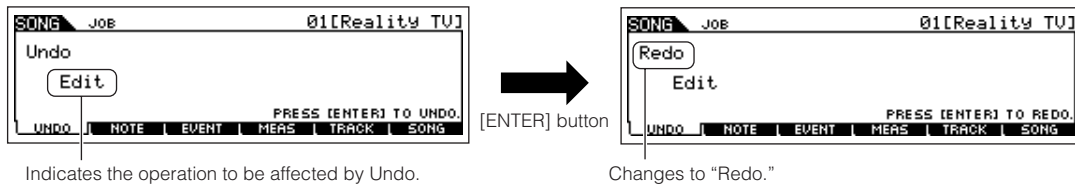

3 Press the [SONG] button to return to the Song Play mode, then press the [▶] (Play) button to play the Song.
This lets you check the sound before actually making changes to it with the Job.

4 After stopping the Song, press the [JOB] button followed by the [F1] UNDO button to call up the Undo display. Press the [ENTER] button to execute the Redo.

This lets you “redo” the Job, restoring the Song to the changes you made before using Undo in step 2 above.

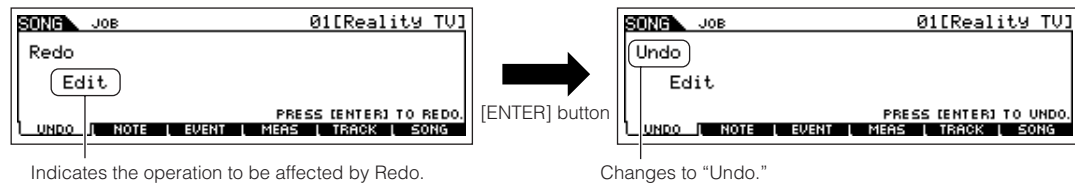

NOTE Undo/Redo is applied to the most recent operation (Job, Edit, Record, etc.).

NOTE The Undo/Redo Job is available also in the Pattern Job mode.

Quick Guide
Creating a Song on the MO

Editing Mixing parameters to complete a Song (in the Mixing mode/ Mixing Edit mode)

In this final step (other than saving your precious work, which we'll cover next), you can mix down your tracks with the Song Mixing function—adjusting the volume balance and pan setting of all the parts and tweaking the effect levels.

NOTE The explanations here also apply to the Pattern mode.

1 Press the [SONG] button to enter the Song Play mode, then select a Song for which Mixing edits have been made.

2 Enter the Song Mixing mode by pressing the [MIXING] button (the lamp lights).

Select the menu you wish to edit by pressing the [F1] – [F4] buttons, then edit the parameters in each display.

If you alter any parameters, the [E] indicator will appear in the top left of the display.

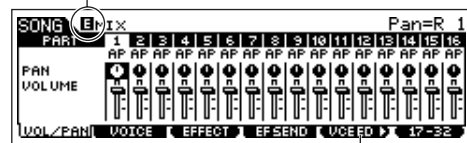

Press the [F5] VCE ED button to enter the Mixing Voice Edit mode (page 203).

You can use the Song Mixing mode for the simple mixing functions. For information on the available parameters, see page 203.

If you wish to edit more detailed Mixing parameters, enter the Song Mixing Edit mode.

3 Press the [EDIT] button to enter the Song Mixing Edit mode.

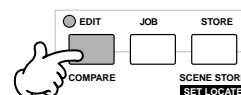

4 Call up the Common Edit display or Part Edit display.

Use Part Edit to edit the parameters for each Part. Use Common Edit to edit the parameters for all of the Parts.

While in the Song Mixing Edit mode, you can switch between the Common Edit display and the Element Edit display as shown below.

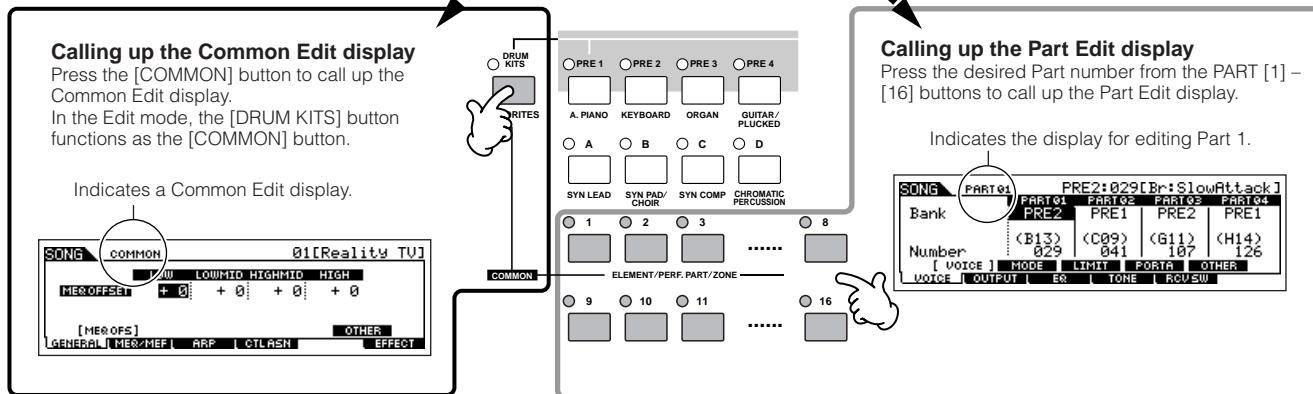

NOTE You can mute or solo a Part just as is done with tracks in the Song Play mode or Pattern Play mode.

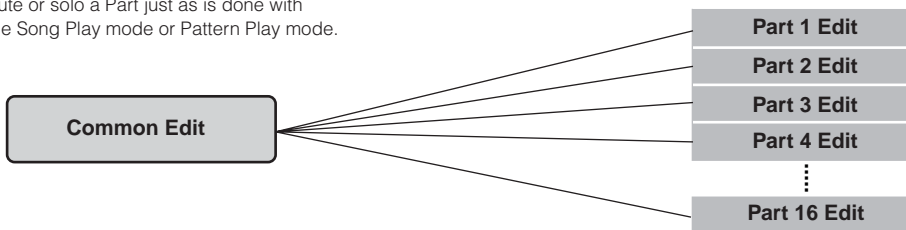

5 Select the menu you wish to edit by pressing the [F1] – [F5] buttons and [SF1] – [SF5] buttons, then edit the parameters in each display.

For details on the available parameters, see page 190.

6 Repeat steps 4 – 5 as desired.

7 Store the edited Song Mixing settings to internal User memory (DRAM) with the Song data or store it to internal memory (Flash ROM) as the Mixing Template data.

After pressing the [EXIT] button to return to the Song Mixing mode, press the [STORE] button to enter the Song Mixing Store mode, then press the [ENTER] button to execute the Store operation (page 98).

8 Before turning the power off, save the stored Song Mixing settings to a USB storage device as Song data in the File mode (page 98).

Since the Song Mixing templates are stored as System data (page 150) in the Flash ROM, the data is maintained even when the power is turned off.

TIP Storing the Mixing settings as a Template

You can store the Mixing settings created in the Song mode and Pattern mode as original Mixing Template data. If you are storing the Mixing settings as Template data, you can call up the same Mixing settings in another Song or Pattern with a simple operation. For details about how to call up a template, see page 77.

TIP Song Chain

This function allows Songs to be “chained” together for automatic sequential playback. In this section, try using the Song Chain features with the Demo Songs.

1 Press the [F6] CHAIN button to call up the Song Chain display.

From this display you can program and play your own custom Song sequences.



2 Program the desired order of the Songs.

Move the cursor to “001” by using the cursor buttons and select the desired Song by using the Data Dial, or the [INC/YES] and [DEC/NO] buttons. Likewise, assign the other Songs to locations 002, 003, 004, and so on.

In addition, the following parameters can be set in the Song Chain.

skip	Skips past (ignores) the selected chain number and continues playback from the next chain number.
stop	Stops Song Chain playback at that chain number. You can restart Song Chain playback from the next chain number by pressing the [▶] (Play) button.
end	Indicates the end mark of the Song Chain data.

3 Play the Song Chain.

Move the cursor to the top of the Song Chain display, and press the [▶] (Play) button to start Song playback.

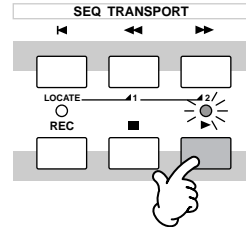

When the Song Chain programmed in step 2 reaches to the end, playback stops automatically. Press the [■] (Stop) button during playback to stop Song Chain playback.

NOTE The Song Chain can only be played back in the Song Chain display, and not from any other display.

TIP Editing a Mixing by using the Knobs (in the Song mode/Pattern mode)

The four knobs at the top left of the instrument can be used to tweak the Song/Pattern Mixing settings as they play (in the Song Play/Pattern Play mode). What's mode, you can use them to edit the Mixing settings, in the Song Mixing Edit/Pattern Mixing Edit modes.

For details on the parameters edited by the knobs, refer to the descriptions in the Performance mode (page 65).

● When the [PAN/SEND] indicator is turned on:

PAN	[SONG] or [PATTERN] → Song/Pattern selection → [MIXING] → [EDIT] → Part selection → [F2] OUTPUT → [SF1] VOL/PAN → Pan	Page 191
REVERB	[SONG] or [PATTERN] → Song/Pattern selection → [MIXING] → [EDIT] → Part selection → [F2] OUTPUT → [SF2] EF SEND → RevSend	Page 191
CHORUS	[SONG] or [PATTERN] → Song/Pattern selection → [MIXING] → [EDIT] → Part selection → [F2] OUTPUT → [SF2] EF SEND → ChoSend	Page 191
TEMPO	Tempo of the current Song/Pattern	Page 74

● When the [TONE] indicator is turned on:

CUTOFF	[SONG] or [PATTERN] → Song/Pattern selection → [MIXING] → [EDIT] → Part selection → [F4] TONE → [SF2] FILTER → Cutoff	Page 191
RESONANCE	[SONG] or [PATTERN] → Song/Pattern selection → [MIXING] → [EDIT] → Part selection → [F4] TONE → [SF2] FILTER → Resonance	Page 191
ATTACK	[SONG] or [PATTERN] → Song/Pattern selection → [MIXING] → [EDIT] → Part selection → [F4] TONE → [SF4] AEG → Attack	Page 191
RELEASE	[SONG] or [PATTERN] → Song/Pattern selection → [MIXING] → [EDIT] → Part selection → [F4] TONE → [SF4] AEG → Release	Page 191

● When the [ARP FX] indicator is turned on:

SWING	[SONG] or [PATTERN] → Song/Pattern selection → [MIXING] → [EDIT] → [COMMON] → [F3] ARP → [SF3] PLAY FX → Swing	Page 190
GATE TIME	[SONG] or [PATTERN] → Song/Pattern selection → [MIXING] → [EDIT] → [COMMON] → [F3] ARP → [SF3] PLAY FX → GateTimeRate	Page 190
VELOCITY	[SONG] or [PATTERN] → Song/Pattern selection → [MIXING] → [EDIT] → [COMMON] → [F3] ARP → [SF3] PLAY FX → VelocityRate	Page 190
UNITMULTIPLY	[SONG] or [PATTERN] → Song/Pattern selection → [MIXING] → [EDIT] → [COMMON] → [F3] ARP → [SF3] PLAY FX → UnitMultiply	Page 190

● When the [EQ] indicator is turned on:

LO	[SONG] or [PATTERN] → Song/Pattern selection → [MIXING] → [EDIT] → Part selection → [F3] EQ → Low Gain	Page 191
LO MID	[SONG] or [PATTERN] → Song/Pattern selection → [MIXING] → [EDIT] → Part selection → [F3] EQ → Mid Gain	Page 191
HI MID	—	-
HI	[SONG] or [PATTERN] → Song/Pattern selection → [MIXING] → [EDIT] → Part selection → [F3] EQ → High Gain	Page 191

● When both the [PAN/SEND] and [TONE] indicators are turned on (by pressing them simultaneously):

ASSIGN A	Adjusts parameters assigned to these knobs in the [UTILITY] → [F4] CTL ASN → [SF2] ASSIGN display.	Page 71
ASSIGN B		
ASSIGN 1	Depend on the settings of the voice assigned to the currently selected part.	Page 70
ASSIGN 2		

NOTE In addition to the above functions, Master Effect related parameters ([SONG] or [PATTERN] → Song/Pattern selection → [MIXING] → [EDIT] → [COMMON] → [F2] MEQ/MEF → [SF2] MEF) can be assigned to these four knobs, and the knobs can be used for these assignments by pressing the [ARP FX] and [EQ] buttons simultaneously to turn them on. The particular parameters assigned to the four knobs can be set in the [UTILITY] → [F4] CTL ASN → [SF5] MEF display.

TIP Editing a Mixing by using Control sliders (in the Song mode/Pattern mode)

[SONG] → Song selection → [MIXING] → [EDIT] → Part selection → [F2] OUTPUT → [SF1] VOL/PAN → Volume

In the Song/Pattern mode, the four Control sliders let you independently adjust the levels of the Parts (Voices), letting you control the overall balance of the Parts.

NOTE Inadvertent use of the sliders may result in no sound. If this occurs, move the sliders upward.

TIP Creating an Arpeggio

In addition using the preset Arpeggios, you can also create your own original Arpeggio data. Actually, there is no direct operation for recording Arpeggios. First, you have to record a Phrase to a Song or Pattern track. Then, use the appropriate Song or Pattern Job function to convert the data to Arpeggio data.

- 1 Record the MIDI sequence data to be used as the basis for base of the Arpeggio to a Song or Pattern.
- 2 Convert the MIDI sequence data (recorded to the Song or Pattern) as Arpeggio data.

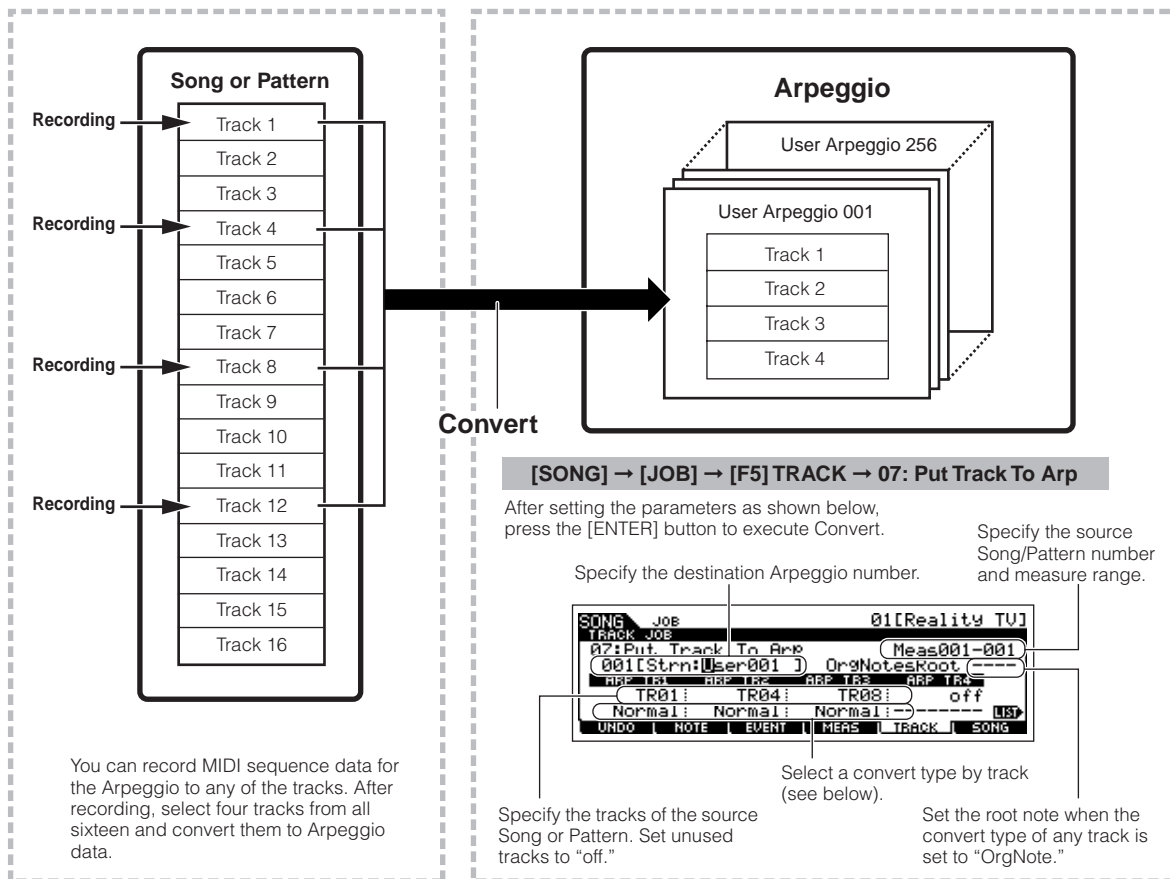

Determining how Song/Pattern data is converted to an Arpeggio—Convert Type

MIDI sequence data (of Song/Pattern tracks) can be converted to Arpeggio data in one of three ways, according to the Convert types below. These types can also be selected independently for each destination track—providing enormous flexibility and performance control.

Normal	The Arpeggio is played back using only the played note and its octave notes.
Fixed	Playing any note(s) will trigger the same MIDI sequence data.
OrgNotes (Original Notes)	Basically same as "Fixed" with the exception that the Arpeggio playback notes differ according to the played chord.

Record the MIDI sequence data to a Song or Pattern track, referring to the previous instructions in this chapter as needed.

The examples listed below are used as reference.

● **Creating a rhythm pattern (using a Drum Voice)**

Track 1	Record a basic rhythm pattern using various drum instruments.	→ Convert via "Fixed."
Track 2 – 4	Record a different rhythm pattern using a specific drum instrument to each track.	→ Convert via "Normal."

● **Creating a bass line (using a Normal Voice)**

Track 1	Record a bass line using a specific desired key (root).	→ Convert via "OrgNote" after the OrgNotesRoot is set.
Track 2 – 4		→ off

● **Creating a guitar backing part (using a Keyboard Mega Voice)**

Track 1	Record a guitar backing part using a specific desired key (root).	→ Convert via "Normal."
Track 2	Record a different rhythm using one of the "special" sounds, such as a finger mute or scratching noise.	→ Convert via "Fixed."
Track 3 – 4		→ off

NOTE Up to 16 unique note numbers can be recorded to the Arpeggio track. (This does not apply to multiple instances of the same note number.) If more than 16 different note numbers have been recorded to the MIDI sequence data, the Convert operation reduces the notes in excess of the limit. Because of this, be careful to record only up to 16 different notes when you create an Arpeggio, especially when using all four tracks.

■ **Convert type which determines how the Song/Pattern data is converted to the Arpeggio data**

The Arpeggio data created via the above instructions is stored on internal Flash ROM, meaning that it will not be lost, even if you turn the power off. When saving the Arpeggio data to a USB storage device, set the file type (TYPE) to "All" or "UsrArp" in step 3 described on page 99.

Storing/Saving the created Song/Pattern

The created Song/Pattern data resides on DRAM (page 150). Because data contained in DRAM is lost when the power is turned off, you should always save any data residing in DRAM to a USB storage device in the File mode before turning off the power. Please note that the edited Mixing settings should be stored before saving to a USB storage device.

NOTE Since the Mixing templates are stored as System data in the Flash ROM, the data is maintained even when the power is turned off.

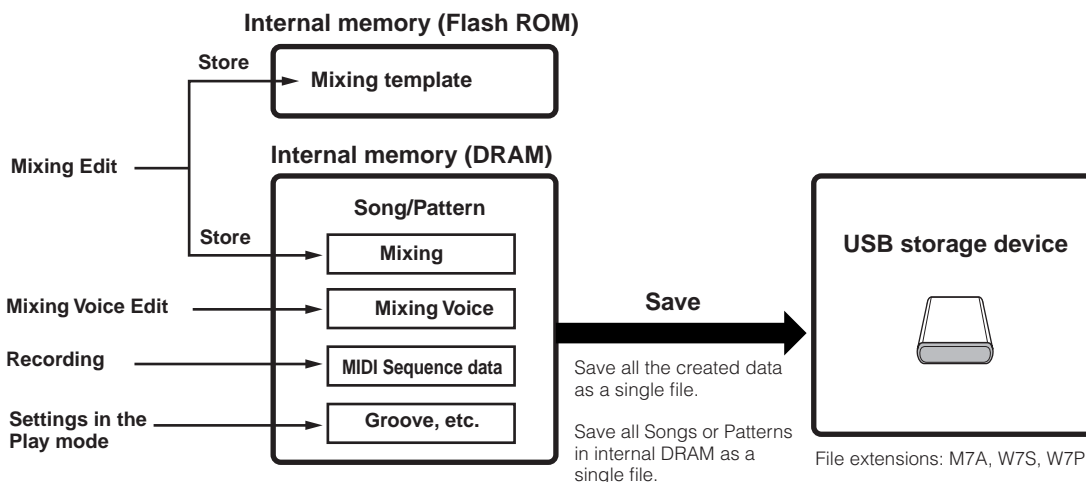

Storing the edited Song Mixing/Pattern Mixing settings to internal memory

[MIXING] → [STORE]

Storing the Mixing settings as a part of a Song

Press the [STORE] button to enter the Song Mixing Store mode/Pattern Mixing Store mode, then select “Store to Current Song” by using the data dial, [INC/YES] button, or [DEC/NO] button. Then, press the [ENTER] button to execute the Store operation. The Mixing settings are actually stored to the current Song/Pattern by executing the Store operation.

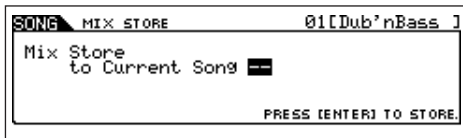

Storing the Mixing settings as a Mixing Template

Press the [STORE] button to enter the Song Mixing Store mode/Pattern Mixing Store mode, then select “Store to Template” by using the data dial, [INC/YES] button, or [DEC/NO] button. Then, press the [ENTER] button to execute the Store operation. You can load the Mixing Template stored here for other Songs and Patterns.

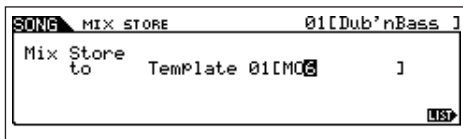

CAUTION

The currently edited Mixing program will be lost when selecting a different Song/Pattern or going to a different mode without storing it. In addition, simply playing back the Song/Pattern or receiving any MIDI messages from an external MIDI instrument may change the current Mixing program. Make sure to store the Mixing program before executing these operations.

Saving the Song/Pattern data to the USB storage device

[FILE] → [F2] SAVE

CAUTION

The recorded Song and Pattern data resides temporarily in DRAM (page 150). Because data contained in DRAM is lost when the power is turned off, you should always save any data residing in DRAM to a USB storage device before turning off the power.

After connecting the USB storage device to this synthesizer, follow the instructions below.

- 1 Press the [FILE] button to enter the File mode. Then press the [F1] CONFIG button and [SF1] CURRENT button

If the device is divided into several partitions, select the specific partition for use. If the device has several media (e.g., discs) inserted, select a specific Slot number.

- 2 Press the [F2] SAVE button to call up the Save display.

- 3 Set the TYPE parameter to “All.”

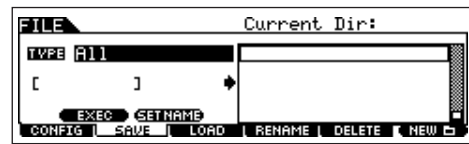

Move the cursor to the TYPE, then set the File type by using the data dial, [INC/YES] and [DEC/NO] button. You can select one of the following four file types to save the Song or Pattern data. Here, select “All” because various kinds of data have been created in order to complete a Song.

All	All data in this synthesizer's internal User Memory is treated as a single file (extension: M7A), and can be saved to a USB storage device.
All Song	All the User Song data in this synthesizer's internal User Memory (DRAM) is treated as a single file (extension: W7S), and can be saved to a USB storage device.
All Pattern	All the User Pattern data in this synthesizer's internal User Memory (DRAM) is treated as a single file (extension: W7P), and can be saved to a USB storage device.
SMF	Sequence track (1 – 16) and Tempo track data of a Song/Pattern created in the Song/Pattern mode can be saved to a USB storage device as Standard MIDI File (format 0) data.

- 4 Input a file name.

Move the cursor to the file name input location, then input a file name. For detailed instructions on naming, refer to page 38 in the Basic Operation section.

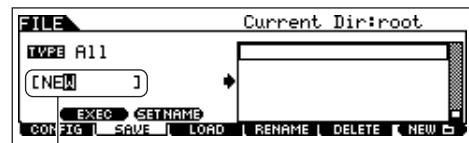

File name input location

- 5 If you have created a destination folder, select the folder.

For information on how to select a folder, see page 213. For information on how to create/delete a folder and change the folder name, see page 211.

- 6 Press the [SF1] EXEC button to actually save the file.

If you are about to overwrite an existing file, the display prompts you for confirmation. Press the [INC/YES] button to execute the Save operation to overwrite the existing file, or press the [DEC/NO] button to cancel it.

CAUTION

While the data is being saved/loaded, make sure to follow these precautions:

- Do not remove or eject the media from the USB storage device.
- Do not unplug or disconnect the USB storage device.
- Do not turn off the power of the instrument or the relevant devices.

Saving a Song or a Pattern Section as a Standard MIDI File

After connecting the USB storage device to the instrument, follow the instructions below.

- 1 Press the [FILE] button to enter the File mode. Then press the [F1] CONFIG button and [SF1] CURRENT button.**

If the device is divided into several partitions, select the specific partition for use. If the device has several media (e.g., discs) inserted, select a specific Slot number.

- 2 Press the [F2] SAVE button to call up the Save display.**

- 3 Set the TYPE parameter to "SMF."**

- 4 Input a file name.**

Move the cursor to the file name input location, then input a file name and press the [SF1] EXEC button. For detailed instructions on naming, refer to page 38 in the Basic Operation section.

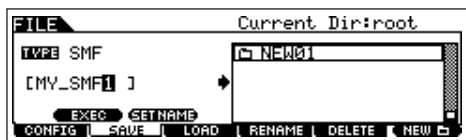

- 5 Select a Song/Pattern to be saved.**

When saving a Song as SMF:

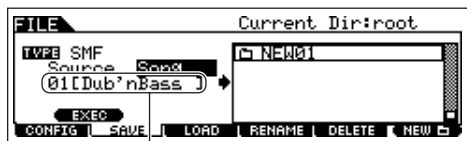

Select a Song number.

When saving a Pattern as SMF:

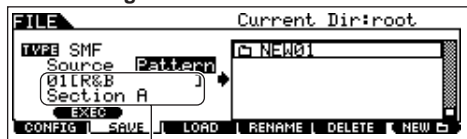

Select a Pattern number and Section.

- 6 If you have created a destination folder, select the folder.**

For information on how to select a folder, see page 213. For information on how to create/delete a folder and change the folder name, see page 211.

- 7 Press the [SF1] EXEC button to actually save the file.**

If you are about to overwrite an existing file, the display prompts you for confirmation. Press the [INC/YES] button to execute the Save operation to overwrite the existing file, or press the [DEC/NO] button to cancel it.

CAUTION

While the data is being saved/loaded, make sure to follow these precautions:

- Do not remove or eject the media from the USB storage device.
- Do not unplug or disconnect the USB storage device.
- Do not turn off the power of the instrument or the relevant devices.

NOTE When loading a SMF (Standard MIDI File), set the file type to "Song" or "Pattern."

NOTE Only the sequence track (1 – 16) and tempo track data of a Song/Pattern created in the Song/Pattern mode can be saved to a USB storage device as Standard MIDI File (format 0) data. The Mixing settings will not be saved to a Standard MIDI File. If you wish to save the entire Song/Pattern including the Mixing settings, set the file type to "All" or "AllSong." or "AllPattern."

Loading a file saved to a USB storage device

[FILE] → [F3] LOAD

These instructions describe how to recall the data saved as a file type "All (extension: M7A)" described on page 99 from the USB storage device to the instrument by using the Load operation.

CAUTION

Loading a file (extension: M7A) to this synthesizer automatically erases and replaces all existing data in the User memory. Make sure to save any important data to a USB storage device before performing any Load operations.

- 1 Press the [FILE] button to enter the File mode. Then press the [F1] CONFIG button and [SF1] CURRENT button.**

If the device is divided into several partitions, select the specific partition for use. If the device has several media (e.g., discs) inserted, select a specific Slot number.

- 2 Press the [F3] LOAD button to call up the Load display.**

3 Select a file type to be loaded.

You can load the file (extension: M7A) saved as "All" by selecting one of the following file types.

All	All data in a file that is saved to the USB storage device as an "All" type can be loaded and restored to this instrument.
Voice	A specified Voice in a file can be individually selected and loaded to this instrument.
Performance	A specified Performance in a file can be individually selected and loaded to this instrument.
Song	A specified Song in a file can be individually selected and loaded to this instrument.
Pattern	A specified Pattern in a file can be individually selected and loaded to this instrument.

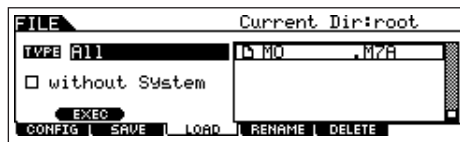

4 Select a file (M7A) to be loaded.

Move the cursor to the file (extension: M7A) which was saved as "All" on previous page.

When Type is set to "All," go to step 5.

When Type is set to something other than "All," follow the instructions below then go to step 5.

● When Type is set to "Voice" or "Performance":

You can select and load a specified Voice or Performance in the file (extension: M7A) to this instrument.

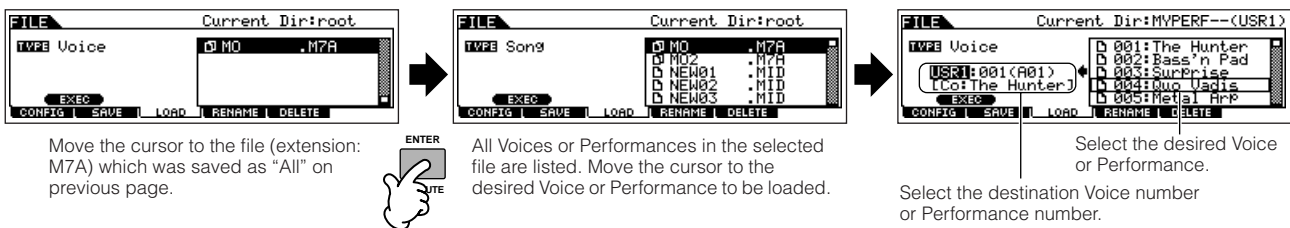

● When Type is set to "Song" or "Pattern":

You can select and load a specified Song or Pattern in the file (extension: M7A) to this instrument.

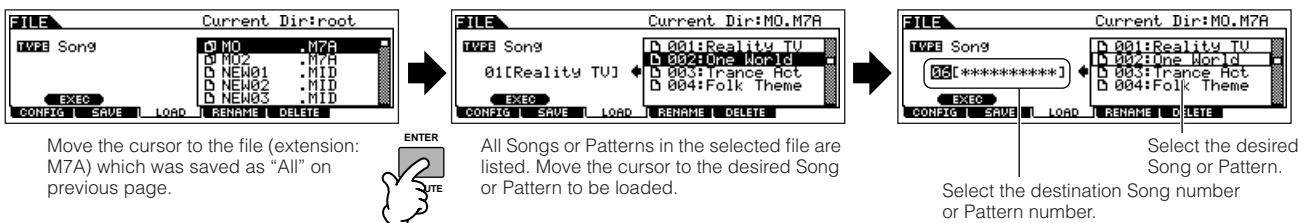

CAUTION

Loading data to this synthesizer automatically erases and replaces any existing data in the User memory. Make sure to save any important data to a USB storage device before performing any Load operations.

5 Press the [ENTER] button to execute the Load operation.

After the data has been loaded, a "Completed" message appears and operation returns to the original display.

CAUTION

While the data is being saved/loaded, make sure to follow these precautions:

- Do not remove or eject the media from the USB storage device.
- Do not unplug or disconnect the USB storage device.
- Do not turn off the power of the instrument or the relevant devices.

TIP Setting a specific file to load automatically when the power is turned on

The MO is very easy to use and you can create Voices, Performances, Patterns and Songs very quickly on it. However, there may be times that creating and editing of data may be spread out over several sessions. In such a case, you may find it convenient to have the instrument automatically load the appropriate files for you when you turn it on, so you can easily resume your editing session.

Save the data after editing. → Turn the power off → The saved files are loaded automatically when you turn the power on next time.

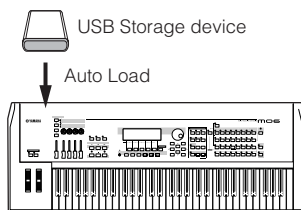
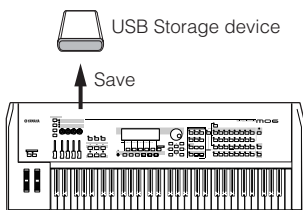

NOTE The Auto Load parameter is set to on when this synthesizer is shipped from the factory.

NOTE The file type which can be loaded automatically is "All."

1 Change the names of the files you wish to have load automatically when the power is turned on as described below, and save them together in a single folder or in the root directory.

File type	File name
All	AUTOLOAD.M7A

2 Enter the Utility mode and call up the Auto Load display ([UTILITY] → [F1] GENERAL → [SF4] OTHER).

3 Set "Auto Load" to on, and press the [SF5] GET button.

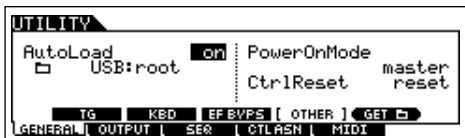

4 Select the folder saved in step 1.

If the device is inserted the multiple medias, select the Slot number. If the device is divided the multiple partitions, select the Partition number.

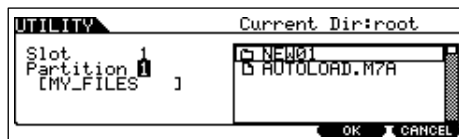

5 Press the [STORE] button to store the settings as the system setting of Utility mode.

NOTE If the Auto Load files cannot be found (for example, a USB storage device is not installed properly or a USB storage device containing no Auto Load files is installed, etc.) when turning the power on even with the Auto Load parameter set to on, the Demo Song/Pattern data in the internal ROM will be loaded automatically.

Connecting the MO to external devices

Connections

Connecting to External Audio Equipment

Since the MO has no built-in speakers, you'll need an external audio system or a set of stereo headphones to properly monitor it. Alternatively, you could use a pair of headphones.

There are several methods of connecting to external audio equipment, as described in the following illustrations.

Audio Output

■ Analog Output

For optimum, accurate reproduction of the instrument's rich sounds, effects and full stereo image, use a pair of powered speakers. Connect the powered speakers to the OUTPUT L/MONO and R jacks on the rear panel.

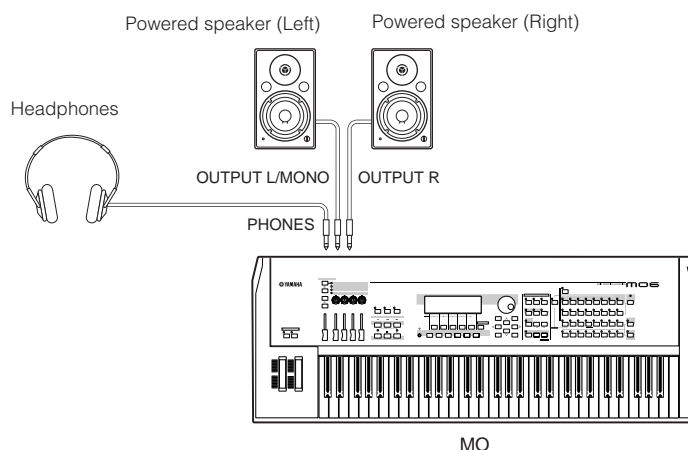

NOTE When using just one powered speaker, connect it to the OUTPUT L/MONO jack on the rear panel.

■ Digital Output

The sound output through the OUTPUT jacks by analog can also be output by digital through the DIGITAL OUTPUT jack. Using this digital output jack, you can record the keyboard performance or Song/Pattern playback of this synthesizer to external media (e.g., an MD recorder) with exceptionally high-quality sound.

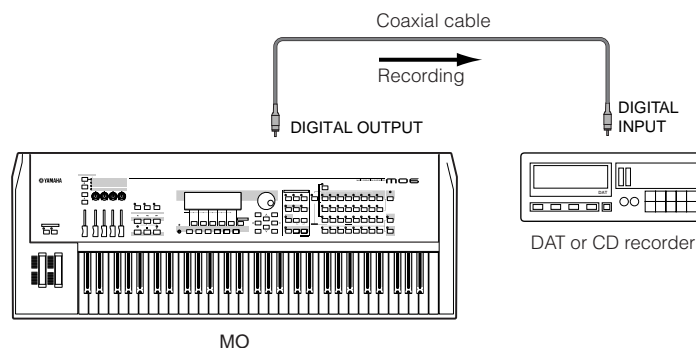

Connecting External MIDI Instruments

Using a standard MIDI cable (optional), you can connect an external MIDI device, and control it from the MO. Likewise, you can use an external MIDI device (such as a keyboard or sequencer) to control the sounds on the MO. This section introduces several different applications of MIDI.

NOTE Either of the interfaces—MIDI or USB—can be used for MIDI data transmission/reception. However, they cannot be used at the same time. Select which connector is used for MIDI data transfer in the Utility mode with the following operation. [UTILITY] → [F5] MIDI → [SF4] OTHER → MIDI IN/OUT (page 210)

Controlling from an external MIDI keyboard

Use an external keyboard to remotely select and play Voices of the MO.

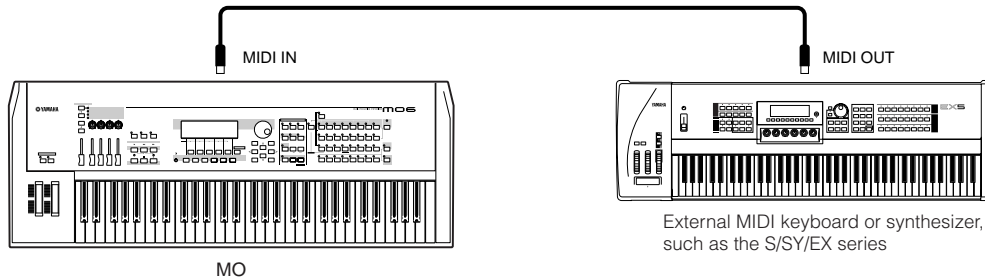

Use an external MIDI Transmit Channel and Receive Channel

Make sure match the MIDI Transmit Channel of the external MIDI instrument with the MIDI Receive Channel of the MO. For details on setting the MIDI Transmit Channel of the external MIDI instrument, refer to the Owner's Manual of the MIDI instrument. For details on setting the MIDI Receive Channel of the MO, check the following points.

- In the Voice mode/Performance mode (using the MO as a single timbre tone generator)**

Check the MIDI Basic Receive Channel with the following operation.

[UTILITY] → [F5] MIDI → [SF1] CH → BasicRcvCh

If necessary, change this parameter to the same number as the MIDI Transmit Channel of the external MIDI instrument.

- In the Song mode/Pattern mode (using the MO as a multi-timbral tone generator)**

Check the MIDI Receive Channel for each part of the Song/Pattern with the following operation.

[SONG] or [PATTERN] → [MIXING] → [EDIT] → Part selection → [F1] VOICE → [SF2] MODE → ReceiveCh

Change the settings of the desired parts to match the MIDI Transmit Channel settings on the external MIDI instrument. Please note that all the parts whose MIDI Receive Channel are same as MIDI Transmit Channel of the external MIDI instrument are sounded by your keyboard performance.

NOTE The functions of the internal tone generator differ depending on whether the Voice/Performance mode (single timbre, keyboard playback) or the Song/Pattern mode (multi-timbral, sequencer playback) is selected. For details, see page 134.

Controlling an external MIDI keyboard from this synthesizer

This connection lets you sound an external MIDI tone generator (synthesizer, tone generator module, etc.) by playing the MO or playing back the Song/Pattern of the MO. Use this connection when you wish to sound the other instrument as well as the MO.

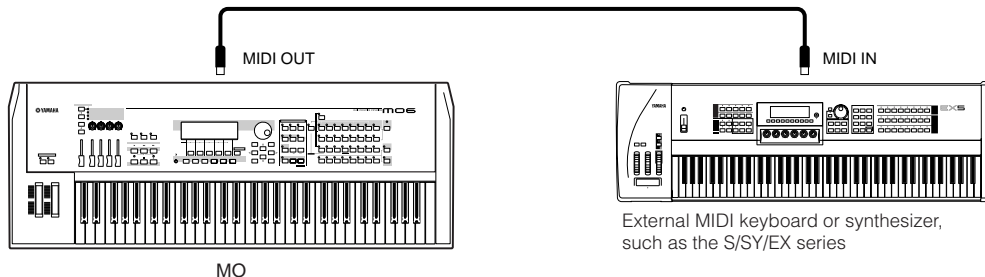

TIP Splitting the sound between the MO and an external tone generator by MIDI channel (Part 1)

Using the connection example shown above, you can play both instruments and have them separately sound different parts—for example, having your keyboard performance sound the external instrument while the Song/Pattern plays the sounds of the MO. Check the following points.

■ In the Voice mode/Performance mode

You can check the MIDI Transmit Channel at the right corner of the [F1] PLAY display in the Voice Play mode/Performance Play mode. If necessary, you can change the MIDI Transmit Channel by turning the [TRACK SELECT] button on and entering the desired value with the Number buttons.

When you wish to sound only the external tone generator, set Master Volume to “0” or set Local Control to “off” with the following operation.

[UTILITY] → [F5] MIDI → [SF2] SWITCH → LocalCtrl

For details on how to set the MIDI Receive Channel of the external MIDI instrument, refer to the Owner's Manual of that MIDI instrument.

■ In the Song mode/Pattern mode

You can check the MIDI Transmit Channel for each track of the current Song/Pattern with the following operation. Change this setting as necessary.

[SONG] or [PATTERN] → [F3] TRACK → [SF1] CHANNEL

Alternately, you can set the output destination (Internal or external MIDI tone generator) for each track from the following display.

[[SONG] or [PATTERN] → [F3] TRACK → [SF2] OUTSW

In this case, you'll need to set the external MIDI tone generator to multi-timbral operation and set the MIDI Receive Channel for each part. For details, refer to the owner's manual of the external MIDI tone generator.

Alternately, you can have your keyboard performance split and assigned to different MIDI channels by using the Zone settings in the Master mode. (See page 125.)

NOTE The functions of the internal tone generator differ depending on whether the Voice/Performance mode (single timbre, keyboard playback) or the Song/Pattern mode (multi-timbral, sequencer playback) is selected. For details, see page 134.

■ Recording and playback using an external MIDI sequencer

In this connection example, song data on the external MIDI sequencer plays the sounds of the tone generator on the MO. The external song data can also be recorded to Song/Pattern tracks on the MO.

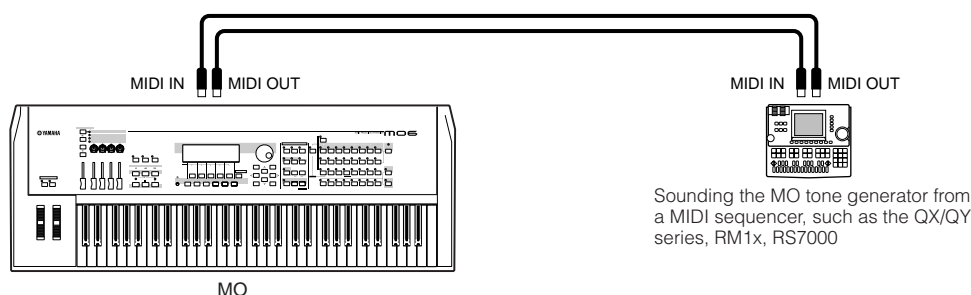

In this case, make sure that the MO is set to the Song mode or Pattern mode. If the instrument is set to the Voice mode or to a Performance mode setting in which multi-channel MIDI messages are not recognized, the external sequence data (containing multi-channel data) will not play back properly on the MO. In addition, you may have to make certain MIDI synchronization settings (see below).

Synchronizing with an external MIDI instrument (Master and Slave)

The Songs and Patterns of this instrument can be synchronized to the playback of an external MIDI sequencer. To do this, one device must be set to internal clock operation and the other (as well as all other devices to be controlled) to external clock. The device set to internal clock serves as a reference for all connected devices, and is referred to as the “master” instrument. The connected devices set to external clock are referred to as “slaves.”

When recording playback data of the external MIDI sequencer to a Song/Pattern of the MO in the above connection example, make sure to set the MIDI synchronization parameter to the use of external clock in the Utility mode with the following operation.

[UTILITY] → [F5] MIDI → [SF3] SYNC → MIDI Sync = MIDI

■ Controlling another MIDI instrument via MIDI THRU

If you have more synthesizers and tone generators than MIDI ports, you can use the MIDI THRU jack to connect and control additional devices. Here, the playback data of a MIDI sequencer is used to play the sounds of another MIDI instrument (connected to the MIDI THRU connector) as well as the MO. The MIDI THRU connector simply redirects any received MIDI data (via MIDI IN) to connected instrument.

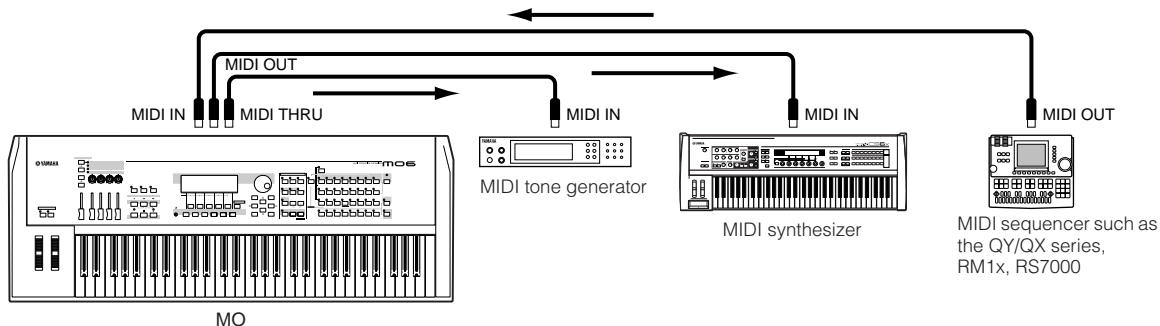

In this case, make sure that the MO is set to the Song mode or Pattern mode. If the instrument is set to the Voice mode or to a Performance mode setting in which multi-channel MIDI messages are not recognized, the external sequence data (containing multi-channel data) will not play back properly on the MO. In addition, you may have to make certain MIDI synchronization settings (see below). Likewise, make sure to set the MIDI tone generator (connected to the MIDI THRU connector) to the multi-timbral mode.

In addition, you need to set the MIDI synchronization related parameters of the MO to enable external clock from the following display.

[UTILITY] → [F5] MIDI → [SF3] SYNC → MIDI Sync = MIDI

TIP Splitting the sound between the MO and an external tone generator by MIDI channel (Part 2)

In this connection example shown above, you can split the sequence playback between the MO and another instrument connected to MIDI THRU and have them sound different parts.

For example, on the MO assign the Song/Pattern parts to MIDI Receive Channels 1 through 9 with the following operation, and set the rest of the parts (not to be sounded) to off.

[SONG] or [PATTERN] → [MIXING] → [EDIT] → Part selection → [F1] VOICE → [SF2] MODE → ReceiveCh

On the connected MIDI tone generator, assign the parts to be sounded to MIDI Receive Channels 10 through 16, and set the rest of the parts (not to be sounded) to off.

■ Connecting to an MTR (Multi Track Recorder)

Since this synthesizer can receive the MTC (MIDI Time Code) and can transmit the MMC (MIDI Machine Control), you can produce music by synchronizing to a MTC- or MMC-compatible multi-track.

You can use two types of MTR control (illustrated below) by setting the MIDI Sync to MTC in the Utility mode, with the following operation.

[UTILITY] → [F5] MIDI → [SF3] SYNC → MIDI Sync = MTC

NOTE MTC and MMC are available only in the Song mode.

● Synchronizing the MO to the MTC signal from an external MTR

After receiving the MTC signal transmitted from the MTR (when MTR playback is started), the selected Song of the MO will start, once the MTC Start Offset time elapses (set from the display [UTILITY] → [F5] MIDI → [SF3] SYNC → MTC StartOffset in the Utility mode).

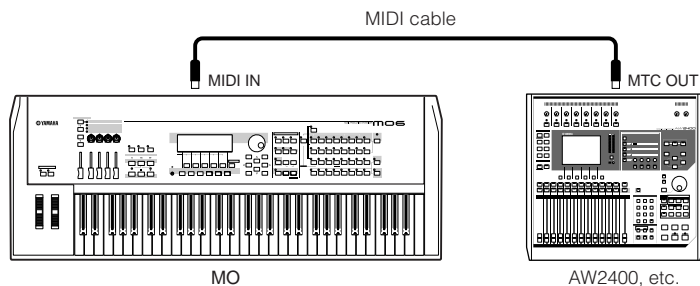

NOTE MTC (MIDI Time Code) allows simultaneous synchronization of multiple audio devices via standard MIDI cables. It includes data corresponding to hours, minutes, seconds, and frames. The MO does not transmit MTC. An instrument such as the Yamaha AW2400 is necessary as an MTC master.

● **Controlling an MTR by using MMC transmitted from the MO**

You can control the start/stop and fast forward/rewind of the MMC-compatible MTR from the SEQ TRANSPORT buttons on the front panel of the MO, outputting MMC messages via MIDI.

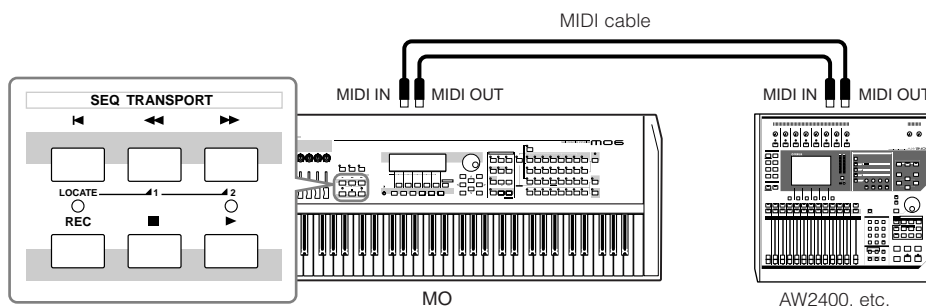

NOTE MMC (MIDI Machine Control) allows remote control of multitrack recorders, MIDI sequencers, etc. A MMC-compatible multitrack recorder, for example, will automatically respond to start, stop, fast forward, and rewind operations performed on the controlling sequencer, thus keeping playback of the sequencer and multitrack recorder aligned.

Connecting to a Computer

Connecting this instrument to a computer via MIDI opens up a whole world of musical possibilities—such as using sequencer software to record and play back compositions with the MO sounds or using the Voice Editor/Multi Part Editor software (page 112) to create and edit your own custom Voices/Mixing settings (Multis).

In order to use the instrument with a computer via a USB connection, you will need to install an appropriate USB-MIDI driver (page 110).

Using a USB TO HOST connector

MIDI messages can be transferred between the sequencer software and MO using the USB cable. However, audio data cannot be transmitted or received via USB on the MO.

When using a USB connection, make sure to set the following parameter to “USB.”

[UTILITY] → [F5] MIDI → [SF4] OTHER → MIDI IN/OUT = USB

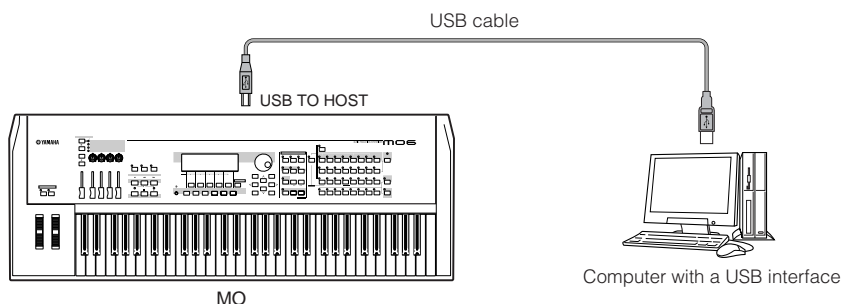

NOTE USB cables have different connectors on each end: the A type and the B type. When connecting this synthesizer to the computer, connect the A type to your computer and the B type to the USB TO HOST connector. When connecting this synthesizer to the computer, connect the A type to your computer and the B type to the USB TO HOST connector.

MIDI channels and MIDI ports

MIDI data is assigned to one of sixteen channels, and this instrument is capable of simultaneously playing sixteen separate parts via these channels. While a single MIDI cable is equipped to handle data over up to sixteen channels simultaneously, a USB connection is capable of handling far more—thanks to the use of MIDI ports. Each MIDI port can handle sixteen channels, and the USB connection allows up to eight ports, letting you use up to 128 channels (8 ports x 16 channels) on your computer.

NOTE The tone generator block in this instrument can recognize and use only one port.

NOTE When using a USB connection, make sure to match the MIDI transmit port and the MIDI receive port as well as the MIDI transmit channel and the MIDI receive channel.

TIP Thru Port Setting

MIDI ports can be used to divide playback among multiple synthesizers, as well as expand the MIDI channel capacity beyond sixteen.

In the example below, a separate synthesizer connected to the MO is played by MIDI data via port 5, as set in the ThruPort parameter with the following operation.

[UTILITY] → [F5] MIDI → [SF4] OTHER → ThruPort = 5

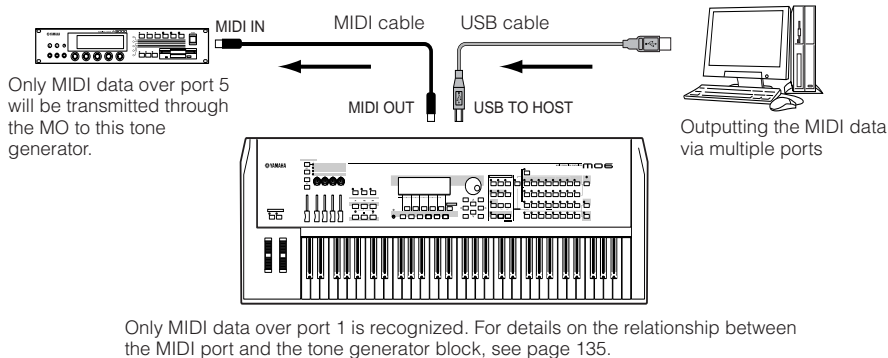

Quick Guide

Connecting the MO to external devices

Precautions when using the USB TO HOST connector

When connecting the computer to the USB TO HOST connector, make sure to observe the following points.

Failing to do so risks freezing the computer and corrupting or even losing the data. If the computer or the instrument freezes, turn the power to the instrument off or restart the computer.

CAUTION

- Before connecting the computer to the USB TO HOST connector, exit from any power-saving mode (such as suspended, sleep, standby) of the computer.
- Before turning on the power to the instrument, connect the computer to the USB TO HOST connector.
- Execute the following before turning the power to the instrument on/off or plugging/unplugging the USB cable to/from the USB TO HOST connector.
 - Quit any open applications (such as Voice Editor, Multi Part Editor, and sequencer software).
 - Make sure that data is not being transmitted from the instrument. (Data is transmitted only by playing notes on the keyboard or playing back a Song.)
- While a USB device is connected to the instrument, you should wait for six seconds or more between these operations: (1) when turning the power of the instrument off then on again, or (2) when alternately connecting/disconnecting the USB cable.

Using a MIDI cable

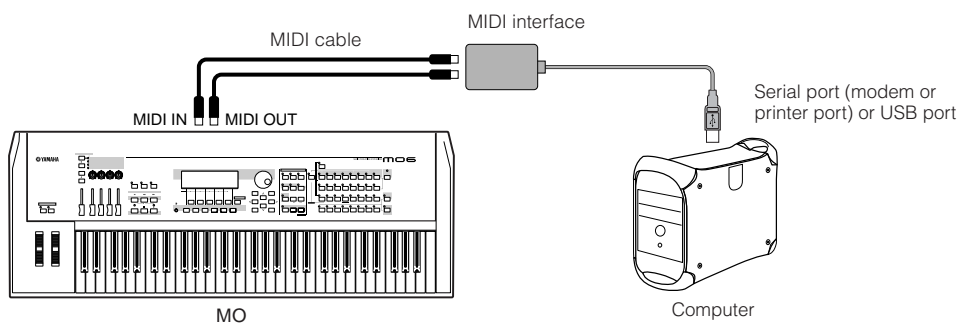

NOTE Use an appropriate MIDI interface for your computer. If you are using a computer that has a USB port, make sure to connect the computer and the MO by USB.

Local On/Off—when Connected to a Computer

When connecting this synthesizer to a computer, the keyboard performance data is generally sent to the computer, and then returned from the computer to play the tone generator block. If the Local Control in the Utility mode is set to “on,” a “double” sound may result, since the tone generator is receiving performance data from both the keyboard directly and the computer. Use the setting suggestions below as a guideline; specific instructions may differ depending on your computer and the software used.

• When MIDI “Echo” (MIDI Thru) is set to “on” the software/computer:

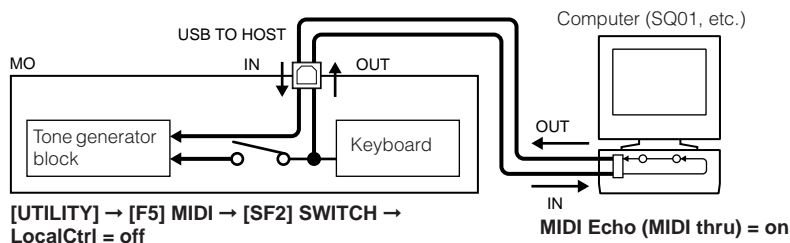

NOTE When transmitting or receiving System Exclusive data (such as with the Bulk Dump function), use the setting example below, making sure that MIDI “Echo” (MIDI through) on the computer software is set to “off.”

• When MIDI “Echo” (MIDI Thru) is set to “off” the software/computer:

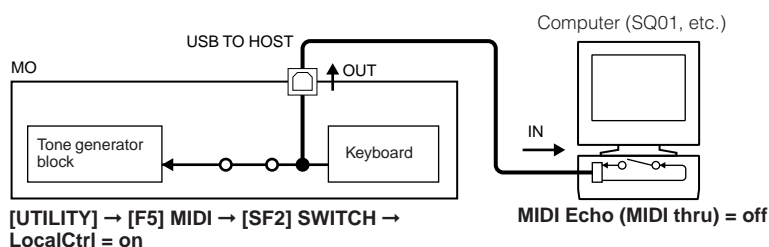

NOTE Although not indicated in the illustration above, the MO actually receives and responds to MIDI data from the computer application (sequencer), regardless of the Local Control setting on the MO.

* MIDI “Echo” is a function on sequencers that takes any data received via the MIDI IN and “echoes” it (or sends it as is) through the MIDI OUT. In some software, this function is also called “MIDI Thru.”

NOTE For details about MIDI Echo, refer to the owner’s manual of your particular software.

TIP Quick Setup

The MO is capable of handling many different music applications—such as live performance, connection to a computer for recording, etc. However, depending on the particular situation, you may have to change the MIDI synchronize setting or the Local On/Off setting above manually.

To help with this, the MO features a convenient Quick Setup function that lets you instantly change important settings for four different typical situations. For details about the Quick Setup function, see page 208.

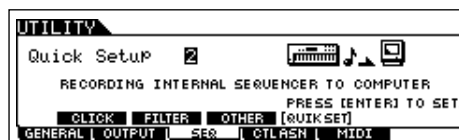
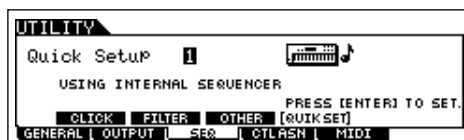

Using as a Multi-timbral Tone Generator for your DAW/sequencer

The MO can serve as a high-quality, 16-part, multi-timbral tone generator for playing back song data from your DAW (digital audio workstation) or sequencer software. By assigning each track in a MIDI song file to a different MIDI channel, you can have each track in the song independently play back a different Voice on the MO.

Setting up for using a computer

NOTE In the example explanations below, the MO is connected to computer via USB. You can also use MIDI cables to connect the instrument to a computer.

1 Download the latest USB-MIDI driver from the website at the following URL:

http://www.global.yamaha.com/download/usb_midi/

OS: Windows XP Professional/Home Edition,
Mac OS X 10.2 – 10.4.2

* This information above applies to version 2.1.5 (for Windows XP) and version 1.0.4 (for Mac OS X). Keep in mind that the software is often updated and the system requirements are subject to change. You can check the latest version information of each program and its system requirements at the website above.

2 Install the USB-MIDI driver to the computer.

For information about how to install, refer to the installation guide included in the downloaded file.

3 Connect the MO to the computer by the USB cable.

For details, see page 107.

4 Set the following parameter to “USB.”

[UTILITY] → [F5] MIDI → [SF4] OTHER → MIDI IN/OUT

5 Press the [STORE] button to store the settings as the system settings of the Utility mode.

⚠ CAUTION

Never attempt to turn off the power while an “Executing...” or “Please keep power on” message is shown. Turning the power off in this state may cause the system to freeze and prevent normal startup the next time the power is turned on, as well as resulting in the loss of all user data.

Using the sounds of the MO for song playback from a sequencer

1 Follow the instructions described in “Setting up for using a computer” (at left).

2 Start up the sequencer software on the computer, and then open a new song file in the sequencer.

Set the MIDI port and MIDI channel setting of each track in the sequencer song file as desired.

MIDI Port settings

When you are using the internal tone generator of the MO, set the MIDI port of each track of the sequencer to “1.”

MIDI channel settings

Match the MIDI transmit channels of the sequencer with the receive channels of the Song/Pattern Parts. The receive channels of the Song/Pattern can be set in the [F1] VOICE display in the Song/Pattern Mixing Edit mode.

NOTE MIDI ports 1 – 8 of USB are shown as “YAMAHA USB IN/OUT 0-1” – “YAMAHA USB IN/OUT 0-8” in Windows, and as “YAMAHA MO Port 1” – “YAMAHA MO Port 8” on the Macintosh.

3 Press the [SONG] or [PATTERN] button to enter the Song mode or Pattern mode.

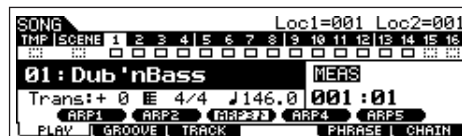
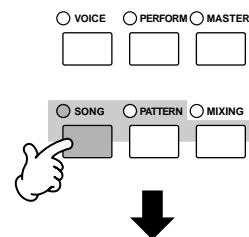

4 Select a Song or Pattern.

Set the Voices to be assigned to each Mixing setting, as well as the Receive Channels and Effects for the desired song. For details about the Mixing settings, see page 93.

5 Record your song data to the sequencer song file.

For details, refer to the owner's manual of your sequencer.

6 Play back the sequencer song file using the sounds of the MO.

When a Note On message is received, the corresponding Part is played. For example, when you play back tracks on the sequencer, the Part whose Receive Channel is same as the sequencer track's Transmit Channel is played. If two or more Parts have the same MIDI receive channel value, those Parts will play in unison.

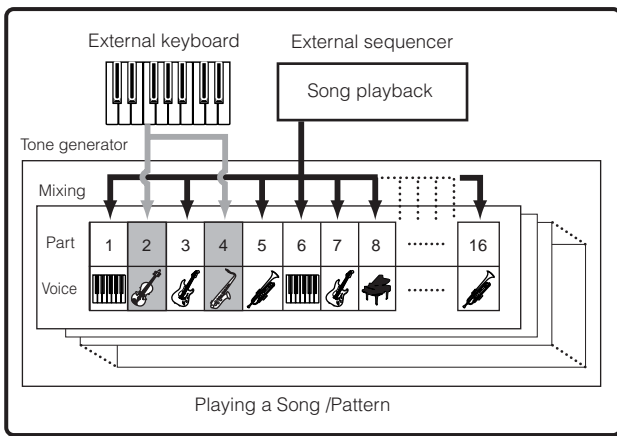

Using the MO with computer software

Editing the MO as a "virtual" synthesizer

Voice Editor and Multi Part Editor

The Voice Editor and Multi Part Editor for MO provide a highly intuitive way to create and edit the Voices and Mixing settings (Multis) completely from your computer display. These programs not only allow you to see virtually all parameters at once, they also give you direct graphic control—for example, letting you adjust the settings by clicking and dragging on a graph—enabling you to edit Voices and Mixing settings (Multis) with remarkable efficiency, speed and convenience.

The latest versions of MO6/MO8 Voice Editor and Multi Part Editor can be downloaded at our website:

<http://www.yamahasyth.com/download/>

For details on how to operate the Editor, refer to the PDF manual included with the Editor.

OS: Windows XP Professional/Home Edition, Mac OS X 10.3 or later

* This information above applies to version 2.2.0 (for Windows XP) and version 2.2.0 (for Mac OS X). Keep in mind that the software is often updated and the system requirements are subject to change. You can check the latest version information of each program and its system requirements at the website above.

NOTE You will need the Studio Manager software (Version 2) to start each Editor. Make sure to download Studio Manager together with the appropriate Editors from the website above.

Studio Connections



Studio Connections is a sophisticated software/hardware solution that lets you seamlessly integrate the MO into your computer music system.

If you are using sequencer software that is compatible with Studio Connections (such as Cubase SX 3) and the Voice Editor/Multi Part Editor, you can use the MO within your sequencer, just as if it were a plug-in software synthesizer—without the need for any complicated connections or complex setup procedures.

Furthermore, you can save all MO settings along with the project (song) file of the sequencer. Then, when you open the project again, all your MO settings for the song are instantly recalled. This eliminates the repetitive work of recreating all your hardware settings when you reopen a song file.

For details about Studio Manager, visit our web site at:

<http://www.studioconnections.org/>

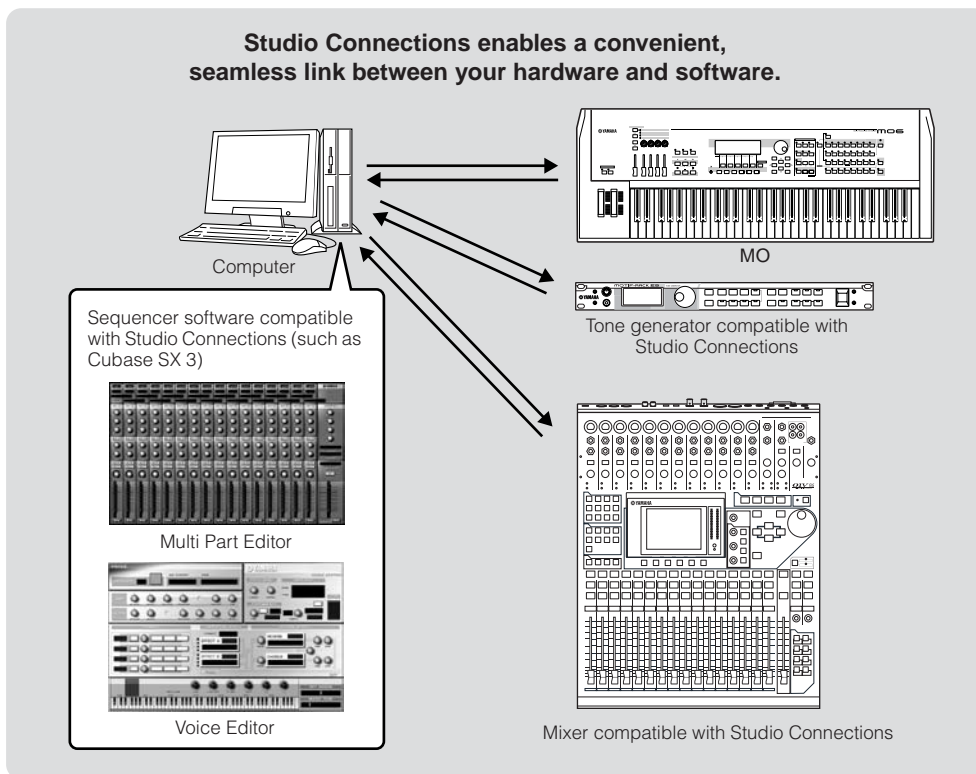

Remote-controlling the software

This powerful feature lets you control your music/audio software programs by using sliders and buttons on the panel of the MO, rather than your computer's mouse and keyboard. The MO can be used to control sequencer software and DAW software, such as Cubase SX, Logic, and SONAR. These sequencers or DAWs are already set to respond to specific hardware controllers.

Computer Software that can be controlled from the instrument

Windows	Macintosh
Cubase SX 3 SQ01 SONAR 4 MO6/MO8 Multi Part Editor S90 ES Multi Part Editor MOTIF ES Multi Part Editor MOTIF-RACK Multi Part Editor MOTIF-RACK ES Multi Part Editor	Cubase SX 3 Logic Pro 7 Digital Performer 4.52 MO6/MO8 Multi Part Editor S90 ES Multi Part Editor MOTIF ES Multi Part Editor MOTIF-RACK Multi Part Editor MOTIF-RACK ES Multi Part Editor

Setting up for Remote Control

1 Connect the MO to the computer via USB (page 107).

2 Set the following parameter to "USB."

[UTILITY] → [F5] MIDI → [SF4] OTHER → MIDI IN/OUT

NOTE If the MO is connected to the computer by MIDI cable, the Remote Control function cannot be used.

3 Call up the Remote Control Setup display by pressing the [F4] CTL ASN button, followed by the [SF4] REMOTE button.

4 Select the software to be controlled and the Port number.

From the MO, you can remote-control the sequencer and Multi Part Editor simultaneously using Mode A and Mode B.

● When controlling Cubase SX via MIDI port 4

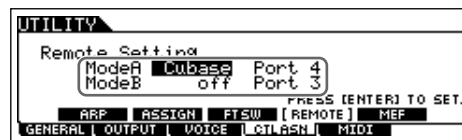

Mode A

Set the Port for remote control of the sequencer or DAW. Select your sequencer and the desired Port number. When controlling Yamaha software, select "general."

Mode B

Set the Port for remote control of the Multi Part Editor. When controlling the Multi Part Editor, select "general." In this case, the parameter is set to "off" because the Multi Part Editor is not used.

NOTE The "general" setting is for remote control of the Yamaha software. This lets you control the Multi Part Editor in Mode A, and control Yamaha sequencer software in Mode B.

NOTE For details on how to operate the Editor, refer to the PDF manual included with the software.

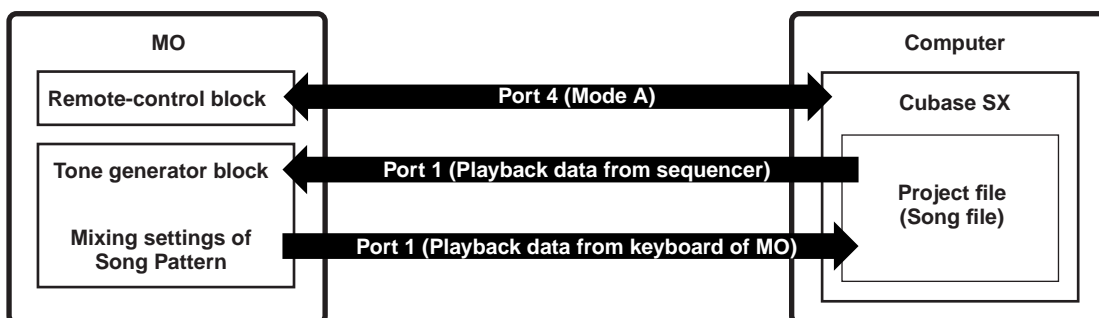

5 Press the [ENTER] button to execute the settings.

6 Press the [STORE] button to store the settings as the system settings of the Utility mode.

⚠ CAUTION

If you turn the power off without storing, the currently edited settings will be lost.

⚠ CAUTION

Never attempt to turn off the power while an “Executing...” or “Please keep power on” message is shown. Turning the power off in this state may cause the system to freeze and prevent normal startup the next time the power is turned on, as well as resulting in the loss of all user data.

7 Start the software to be remote-controlled, and make the MIDI settings and remote control settings.

Set the Port setting for remote control on the software, referring to the illustration in step 4.

Specific instructions for setting up your particular software follow. For instructions on how to start the software, refer to the documentation included with the software.

■ Cubase SX 3

- 1** Pull down the [Devices] menu and select [Device Setup] to call up the “Device Setup” window.
- 2** Click the [+] button and add “Mackie Control.”
- 3** Select “Mackie Control” from the popup list.
- 4** When setting the Port to “4,” for example, in step 4 of “Setting up for Remote Control,” set the MIDI Input to “YAMAHA USB IN 0-4” and the MIDI Output to “YAMAHA USB OUT 0-4.”

NOTE The functions of buttons on the Mackie Control are assigned to the buttons of the MO, with the exception of UserA and UserB (FootSw) which are not supported by the MO.

■ SONAR 4

- 1** Pull down the [Options] menu and select [MIDI Devices] to call up the “MIDI Devices” window.
- 2** When setting the Port to “4” for example in step 4 of “Setting up for Remote Control” add “YAMAHA USB IN 0-4” to the “Inputs” and add “YAMAHA USB OUT 0-4” to the “Outputs.”
- 3** Pull down the [Options] menu and select [Control Surfaces] to call up the Control Surface window.
- 4** Click the [+] button, select “Mackie Control,” then set the Input Port to “YAMAHA USB IN 0-4” and the Output Port to “YAMAHA USB OUT 0-4” (for example, when setting the Port to “4” in step 4 of “Setting up for Remote Control”).

■ Digital Performer 4.52

- 1** Pull down the [Setup] menu and select [Control Surface Setup] to call up the “Control Surface” window.
- 2** Click the [+] button.
- 3** Select “Mackie Control” in the Driver section.
- 4** In the box for setting “Unit” and “MIDI,” select “Mackie Control” in the “Unit” section and select the MIDI port in the “MIDI” section.

■ Logic Pro 7

When turning on the power of the MO before starting Logic:

- 1** Start Logic on the computer, then turn on the power of the MO.
- 2** Start Logic on the computer. Logic automatically recognizes the MO as Logic Control and performs the required settings.

When starting Logic before turning on the power of the MO:

- 1** Start Logic on the computer, then turn the power to the MO on.
If you have already set the software to be controlled to “Logic” in the Utility mode, you need not perform step 2 because Logic automatically recognizes the MO when this step is performed.
- 2** Set the software to be controlled to “Logic” in the Utility mode, then enter the Remote Control mode. Logic automatically recognizes the MO and performs the required settings.

Using the Remote Control functions

1 To enter the Remote Control mode, press the [DAW REMOTE] button (the lamp flashes).

The REMOTE display appears, and the panel controls are enabled for Remote operation of the computer software (their normal functions are disabled).

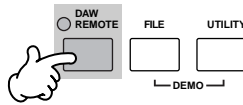

NOTE Press this button again to exit from the Remote Control mode.

2 Select the software to be remote-controlled (Mode A or Mode B).

Change the Mode by simultaneously holding down the [F6] SHIFT button and pressing the [DAW REMOTE] button.

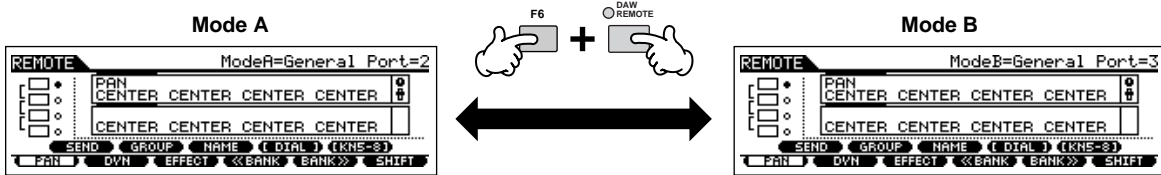

3 Use the Knobs and buttons on the MO to remotely control the software.

The following explains which sequencer functions are assigned to which panel controls in the remote control.

NOTE For details about how to operate the Editor, refer to the PDF manual included with the Editor.

Press the Control function button to change the functions assigned to the [F1] – [F6] and [SF1] – [SF5] buttons (shown at the bottom of the display). Refer to the separate Data List.

These dark bars serve as the cursor, indicating the track/part currently being edited by the Knob. Moving the slider automatically moves the cursor to the corresponding track/part.

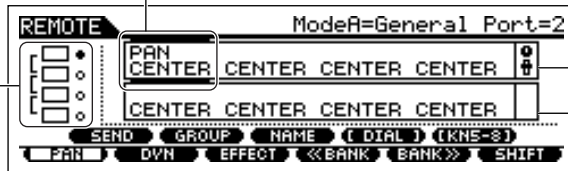
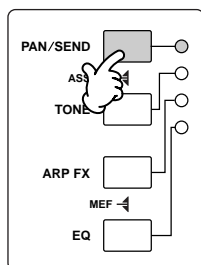

Upper row indicates the setting values for knobs/sliders 1 – 4 on the DAW controller. Bottom row indicates the setting values for knobs/sliders 5 – 8 on the DAW controller.

The functions of the buttons on each DAW controller are assigned to the [F1] – [F6] and [SF1] – [SF5] button on the MO. The functions to be assigned depend on the software selected in the Mode A or B. For details, refer to the “Remote Control Assignments” on page 117.

■ [STOP], [PLAY], [RECORD], [REVERSE], [FAST REVERSE], [SKIP] buttons

The six MODE buttons are used as transport controls, letting you start/stop playback of the DAW software on the computer.

■ [EDIT], [JOB], and [STORE] buttons

When the Mode is set to “General” or “Cubase”	Not used.
When the Mode is set to “Logic”	These buttons perform the same functions as those of the [OPTION], [CONTROL] and [ALT] buttons on the Logic Control.
When the Mode is set to “SONAR”	These buttons perform the same functions as those of the [M2], [M3] and [M4] buttons on the Mackie Control.
When the Mode is set to “D.Perf”	These buttons perform the same functions as those of the [OPTION], [CONTROL] and [COMMAND] buttons on the Mackie Control.

■ [ARPEGGIO ON/OFF] button

When the Mode is set to “General” or “Cubase”	Not used.
When the Mode is set to “Logic”	The button can be used to switch the whether the track/slot number of DAW is displayed on the LCD or not.
When the Mode is set to “SONAR”	The button can be used to switch the whether the track/slot number of DAW is displayed on the LCD or not.
When the Mode is set to “D.Perf”	The button can be used to switch the whether the send/effect number of DAW is displayed on the LCD or not.

■ Data dial, [INC/YES] and [DEC/NO] buttons

When the [DIAL] menu appears at the [SF4] button	These controls can be used to set the value for the knob of the DAW controller, for the track/part selected by the cursor. The Knobs can also be used, but these help you make fine adjustments to the value that are difficult to make with the Knobs.
When the menu does not appear at the [SF4] button	The buttons can be used to move the song position in the DAW.

NOTE You can also move the song position by using the cursor [<] [>] buttons.

■ Knobs

Assigns the functions of eight knobs on the DAW controller (01X, Mackie Control, and Logic Control) to the four Knobs on the MO. The Knobs let you control various parameters of each track (part). Pressing the [SF5] button changes which group of knobs is assigned (knobs 1 – 4 or knobs 5 – 8). The eight knobs on the DAW controller can also be used as switches. The switch function corresponding to the knob track (part) at the cursor position is also assigned automatically to the [ENTER] button, since the Knobs on the MO do not have a switch function.

■ Control sliders

Assigns the functions of eight sliders on the DAW controller (01X, Mackie Control, and Logic Control) to the four Control sliders on the MO. The sliders let you control the volume of each track (part). Pressing the [SF5] button changes which group of faders (faders 1 – 4 or faders 5 – 8 on the DAW controller) is assigned to the Control sliders on the MO.

■ Control function buttons, [F1] – [F6] buttons, [SF1] – [SF5] buttons

When the Mode is set to “General”	These buttons are assigned to perform the same functions as the panel buttons on the 01X. The corresponding names of the 01X panel buttons are also indicated at the bottom of the display of the MO.
When the Mode is set to “Logic”	These buttons are assigned to perform the same functions as the panel buttons on the Logic Control. The corresponding names of the Logic Control panel buttons are also indicated at the bottom of the display of the MO.
When the Mode is set to “Cubase,” “SONAR,” or “D.Perf”	These buttons are assigned to perform the same functions as the panel buttons on the Mackie Control. The corresponding names of the Mackie Control panel buttons are also indicated at the bottom of the display of the MO.

NOTE Among the functions assigned to the [F1] – [F6] buttons and [SF1] – [SF5] buttons, the functions indicated with brackets (such as [DIAL]) are not related to the Mackie Control, Logic Control and 01X but are unique to the MO.

■ Cursor [<] [>] buttons

By moving the cursor left/right, you can change the track or part to controlled by the data dial and [INC/YES]/[DEC/NO] buttons. Pressing the Cursor [>] button moves through the columns in succession (1, 2, 3, 4...). After 4, the cursor is hidden and wraps around to 1. Press the [SF5] KN 5 – 8 (KN 1 – 4) button to move the cursor up/down.

■ Cursor [^] [v] buttons

When the Mode is set to “General”	These buttons are assigned to the functions of the DISPLAY [▲][▼] buttons on the 01X.
When the Mode is not set to “General”	These buttons are assigned to the functions of the cursor up/down buttons on the Mackie Control and Logic Control.

■ [EXIT] button

When the Mode is set to “General”	The button is assigned to the function of the [PAGE SHIFT] button on the 01X.
When the Mode is not set to “General”	Not used.

■ Bank, Group [A] – [H], Number [1] – [16] buttons

These buttons are assigned to perform the same functions as the buttons directly over the faders on the Yamaha 01X, Mackie Control and Logic Control.

When the Mode is set to “General”	Numbers [1] – [8] and [TRACK SELECT] buttons These buttons are assigned to the functions of the nine [SEL] buttons on the Yamaha 01X.
	Numbers [9] – [16] and [MUTE] buttons These buttons are assigned to the functions of the nine [ON] buttons on the 01X.
When the Mode is not set to “General”	[PRE1] – [–] buttons These buttons are assigned to the functions of the eight [REC/RDY] buttons on the Mackie Control and Logic Control.
	Group [A] – [H] buttons These buttons are assigned to the functions of the eight [SOLO] buttons on the Mackie Control and Logic Control.
	Numbers [1] – [8] buttons These buttons are assigned to the functions of the eight [MUTE] buttons on the Mackie Control and Logic Control.
	Numbers [9] – [16] buttons These buttons are assigned to the functions of the eight [SELECT] buttons on the Mackie Control and Logic Control.

Checking the Remote Control assignments

If you're unsure as to which software function has been assigned to a particular panel control on the MO, this convenient feature lets you quickly check it from the display.

- 1 In the Remote Control mode, press the [INFORMATION] button to call up the information display, indicating the function of the last pressed button.
- 2 Press the button for which you want to check the assignment.



This display shown above appears when you press the [▶] (Play) button. In this way, you can check each button's control assignment simply by pressing it.

- 3 Press the [INFORMATION] button again to return to the Remote Control mode.

NOTE While the Information display is shown, the panel buttons cannot be used to control the computer software.

Demo display in Remote Control function

If the connection settings are not appropriate, the demo display (below) will be shown. If this happens, check the MO settings and DAW settings as described on page 113.



Remote Control Assignments

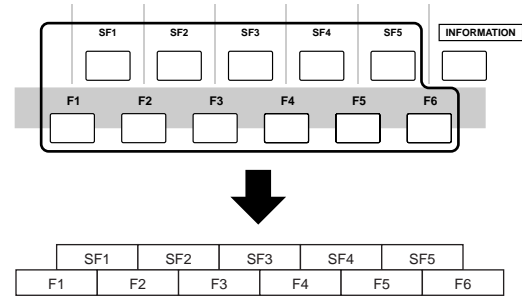

When controlling Multi Part Editor/SQ01 V2

Functions of 01X assigned to [F1] – [F6] and [SF1] – [SF5] buttons

Button	Page	Function
PAN/SEND	PAGE1	SEND, GROUP, NAME/VALUE, DIAL RESET, KN1-4/5-8
		PAN, DYNAMICS, EFFECT, BANK-L, BANK-R, SHIFT
TONE	FADER BANKS	FLIP, NAME/VALUE, DIAL RESET, KN1-4/5-8
		SOLO, REC/RDY, BANK-L, BANK-R, SHIFT
ARP FX	MIXER/LAYER	INST, AUX/BUS, NAME/VALUE, DIAL RESET, KN1-4/5-8
		AUDIO, MIDI, OTHER, BANK-L, BANK-R, SHIFT
EQ	PAGE2	EQ LOW, EQ HIGH-MID, NAME/VALUE, DIAL RESET, KN1-4/5-8
		SEL CH, EQ LOW-MID, EQ HIGH, BANK-L, BANK-R, SHIFT
PAN/SEND	TONE	F5, F6, F7, F8, KN1-4/5-8
		F1, F2, F3, F4, SHIFT
TONE	ARP FX	NAME/VALUE, DIAL RESET, KN1-4/5-8
		BANK-L, BANK-R, SHIFT
ARP FX	EQ	CURSOR-L, CURSOR-R, SCRUB, DIAL RESET, KN1-4/5-8
		CURSOR-DWN, CURSOR-UP, ZOOM, BANK-L, BANK-R, SHIFT

Button/Controller names on 01X	Functions
In all modes:	
[DISPLAY UP] [DISPLAY DOWN]	Changes the parameter to be edited.
[NAME/VALUE]	Changes the indication of the parameter name and its value.
[SHIFT]+[NAME/VALUE]	Changes the meter display mode.
[ON] (in the normal status)	Turns each channel off or on (mutes/unmutes the signal).
[SHIFT] + [ON] of the Master Channel (in the normal status)	Turns all the channels including the Master Channel off or on (mutes/unmutes the signal).
[SHIFT] + [ON] of each channel (in the normal status)	Turns all the channels with the exception of the Master Channel off or on (mutes/unmutes the signal).
[ON] (with the [SOLO] lamp turned on)	Turns the Solo function of each channel on or off (applies to the Channel Module/Software Synthesizer Module)
[SHIFT] + [ON] (with the [SOLO] lamp turned on)	Turns the Solo function of each channel on or off (applies to the Channel Module/Software Synthesizer Module)
[SOLO]	Changes the function of the [ON] button to the Solo function.
[SHIFT]+[SOLO]	Determines the Solo/Mute settings of the selected tracks in the Track View window.
[SHIFT]+[REC RDY]	Turns track recording on or off.
[AUDIO]	Starts the Audio Mixer or moves the Audio Mixer Window to the front of the computer screen. This button operation applies to the Channel Module software.
[INST]	Starts the Audio Mixer or moves the Audio Mixer Window to the front of the computer screen. This button operation applies to the Software Synthesizer Module.
[MIDI]	Starts the MIDI Editor (such as the Multi Part Editor) or moves it to the front of the computer screen.

Button/Controller names on 01X	Functions
[AUX/BUS]	Opens the AUX/BUS window or brings it to the front of the computer screen (when the Audio Mixer is active).
[OTHER]	Starts the Audio Mixer or brings it to the front of the computer screen. This operation applies to the Effect Module software. (Only PAN is available in the R settings.)
[BANK </>]	Scrolls through the track indication every eight channels.
[SHIFT]+[F1]	Brings the Track View window to the front of the computer screen. (This operation applies to the current song.)
[SHIFT]+[F2]	Starts the Mixer window (Audio Mixer/Multi Part Editor) or brings it to the front of the computer screen.
[SHIFT]+[F3]	Opens the List window or brings it to the front of the computer screen.
[SHIFT]+[F4]	Closes the current window.
[SHIFT]+[F5]	Opens the Piano Roll window or brings it to the front of the computer screen.
[SHIFT]+[F6]	—
[SHIFT]+[F7]	Starts the TWE (Wave Editor).
[SHIFT]+[F8]	Alternately hides/shows the Transport window (Transport Bar/Location Bar/Record).
[RWD]	Press briefly to move back one measure at a time, or hold to continuously rewind.
[FF]	Press briefly to move forward one measure at a time, or hold to continuously fast-forward.
[STOP]	Press to stop recording or playback. Pressing this when playback is stopped goes to the top of the song.
[PLAY]	Press to start playback from the current point.
[REC]	Press this to enter/exit from the Recording Standby. The [▶] (Play) and [REC] lamp are turned on during recording.
[SCRUB]	Determines how the Scrub function is applied when using the dial. When this is set to on, Scrub moves according to the Grid position in the Track View window. When set to off, it moves in measures.
[UP] (with the [ZOOM] lamp turned off)	Moves the cursor (indicating the current track) up.
[DOWN] (with the [ZOOM] lamp turned off)	Moves the cursor (indicating the current track) down.
[LEFT] (with the [ZOOM] lamp turned off)	Selects the next block.
[RIGHT] (with the [ZOOM] lamp turned off)	Selects the previous block.
[ZOOM]	Turns Zoom on and off.
[UP]/[DOWN]/[LEFT]/[RIGHT] (with the [ZOOM] lamp turned on)	Zooms in/out in the active Track View and Piano Roll Window.
PAN mode [PAN]	
Knobs 1 – 8 (tweaking)	Edits the Pan (on page 1).
Knobs 1 – 8 (tweaking)	Edits the Input level (on page 2).
[SHIFT] + Knobs 1 – 8 (pressing)	Resets the edited parameter to the default value (CENTER/0.00).
AUX SEND mode [SEND] (Not available when the AUX/BUS window is active.)	
Knobs 1 – 8 (tweaking)	Edits the AUX Send Level.
[SHIFT] + Knobs 1 – 8 (pressing)	Resets the edited parameter to the default value (-∞).
EFF SEND mode [EFFECT] (Not available when the AUX/BUS window is active.)	
Knobs 1 – 8 (tweaking)	Edits the Effect Send Level.
[SHIFT] + Knobs 1 – 8 (pressing)	Resets the edited parameter to the default value (-∞).

When controlling Logic Pro 7:

Functions of Logic Control assigned to [F1] – [F6] and [SF1] – [SF5] buttons

ASSIGNMENT

PAN/SEND	SEND	PLUG-IN	INSTRUMENT	DIAL RESET	KN1-4/5-8
	TRACK	PAN/SURND	EQ	BANK-L	BANK-R

FADER BANKS

FLIP	NAME/VALUE	DIAL RESET	KN1-4/5-8
CHANNEL-L	CHANNEL-R	BANK-L	BANK-R

GLOBAL VIEW

AUX	BUSSES	OUTPUTS	USER	KN1-4/5-8
MIDI TR	INPUTS	AUDIO TR	AUDIO INST	GLOBAL VIEW

UTILITIES

SAVE	UNDO	NAME/VALUE	DIAL RESET	KN1-4/5-8
CANCEL	ENTER	BANK-L	BANK-R	SHIFT

PAN/SEND

F5	F6	F7	F8	KN1-4/5-8
F1	F2	F3	F4	SHIFT

MARKER

NUDGE	DROP	CLICK	DIAL RESET	KN1-4/5-8
MARKER	CYCLE	REPLACE	SOLO	SHIFT

CURSOR

CURSOR-L	CURSOR-R	SCRUB	DIAL RESET	KN1-4/5-8
CURSOR-DWN	CURSOR-UP	ZOOM	BANK-L	BANK-R

Button/Controller names on Logic Control	Functions
In all modes:	
[NAME/VALUE]	Changes the indication of the parameter name and its value.
[SHIFT]+[NAME/VALUE]	Changes the meter display mode.
[SEL]	Selects a channel.
[MUTE]	Mutes or unmutes each channel.
[OPTION]+[MUTE]	Sets all channels to on.
[SOLO]	Sets the Solo of each channel to on or off.
[OPTION]+[SOLO]	Sets the Solo of all the channels to off.
[REC RDY]	Sets the REC RDY of each channel to on or off.
[OPTION]+[REC RDY]	Sets the REC RDY of all the channels to off.
[MIDI TR]	Makes the Global View mode active and displays the MIDI track with the Multi Channel view.
[INPUT]	Makes the Global View mode active and displays the AUDIO INPUT object with the Multi Channel view.
[AUDIO TR]	Makes the Global View mode active and displays the Audio track with the Multi Channel view.
[AUDIO INST]	Makes the Global View mode active and displays the Audio Instrument track with the Multi Channel view.
[AUX]	Makes the Global View mode active and displays the AUX object with the Multi Channel view.
[BUSSES]	Makes the Global View mode active and displays the BUS object with the Multi Channel view.
[OUTPUT]	Makes the Global View mode active and displays the AUDIO OUTPUT object with the Multi Channel view.
[GLOBAL VIEW]	Switches between the Global View mode and Track View mode.
[BANK </>]	Scrolls through the track indication every eight channels.
[CHANNEL </>]	Scrolls through the track indication channel-by-channel.
[SHIFT]+[FLIP]	Exchanges the functions between the Channel Knobs and the Faders.
[FLIP]	Assigns the function of the Channel Knob to the Fader.
[NUDGE]	Turns Nudge on or off.
[SHIFT]+[NUDGE]	Enters the Nudge Option mode.
[CYCLE]	Turns Loop on or off.
[SHIFT]+[CYCLE]	Enters the Cycle Option mode.
[F1] – [F7]	Calls up Screen Sets 1 – 7.
[F8]	Closes the window located at the front of the computer or floating window.
[UNDO]	Executes the Undo operation.
[SHIFT]+[UNDO]	Executes the Redo operation.
[SAVE]	Executes the Save operation.
[MARKER]	Turns the Marker on or off.
[SHIFT]+[MARKER]	Enters the Marker Option mode.

Button/Controller names on Logic Control	Functions
[RWD]	Press to continuously rewind. Press repeatedly to rewind more quickly. When the Marker is turned on, this operation moves the song position to the previous Marker. When Nudge is turned on, this operation moves the current object.
[FF]	Press to continuously fast-forward. Press repeatedly to fast-forward more quickly. When the Marker is turned on, this operation moves the song position to the next Marker. When Nudge is turned on, this operation moves the current object.
[STOP]	Press to stop recording or playback. Pressing this when playback is stopped goes to the top of the song.
[PLAY]	Press to start playback from the current point.
[REC]	Press this to start song recording. The [▶] (Play) and [REC] lamp are turned on during recording.
[ZOOM]	Turns Zoom on and off.
[SCRUB]	Turns Scrub on and off. When Scrub is on, the dial can be used for Scrub playback. When Scrub is off, the dial is used to move the song position.
PAN mode [PAN] (Multi Channel View) [PAN] → [PAN] (Track Parameter View of PAN/SURROUND)	
Knobs 1 – 8 (turning)	Edits the parameter.
Knobs 1 – 8 (pressing) (Parameters other than Mode selection)	Resets the edited parameter to the default value.
SEND mode [SEND] (Multi Channel View) [SEND] → [SEND] (Track Parameter View)	
Cursor [UP]/[DOWN] (Multi Channel View)	Changes the Slot number.
Cursor [LEFT] / Cursor [RIGHT] (Multi Channel View)	Changes the parameter to be edited.
Cursor [LEFT] / Cursor [RIGHT] (Track Parameter View)	Switches between SEND 1/2 and SEND 3/4.
Knobs 1 – 8 (turning/turning → pressing)	For editing parameters. When setting the Send destination, turn the knob to select it (indication flashes), then press the knob to actually enter the selected setting.
Knobs 1 – 8 (pressing) (when the edited parameter is Send Level)	Reset the parameter value to the default.
Knobs 1 – 8 (pressing) (when the edited parameter is PRE/POST or Mute)	Changes the setup.
PLUG-IN mode [PLUG-IN] (Multi Channel View) [PLUG-IN] → [PLUG-IN] (Track Parameter View)	
Cursor [UP]/[DOWN] (Multi Channel View)	Changes the Slot number.
Knobs 1 – 8 (tweaking → pressing)	Turn the knob to select the desired Plug-in for insertion (indication flashes), then press the knob to actually enter the selected setting.
Knobs 1 – 8 (pressing) (Knob to which the Plug-in is assigned)	Calls up the parameter page and opens the Editor window on Logic.
Knobs 1 – 8 (tweaking) (Parameter page)	For editing parameters.
Knobs 1 – 8 (pressing) (Parameter page)	Reset the parameter value to the default. (Some parameters cannot be reset.)
Cursor [LEFT] / Cursor [RIGHT] (Parameter page)	Changes the page.
[PLUG-IN]	Return to the PLUG-IN mode.
INSTRUMENT mode [INSTRUMENT] (Multi Channel View) [INSTRUMENT] → [INSTRUMENT] (Track Parameter View)	
Knobs 1 – 8 (tweaking → pressing)	Turn the knob to select the desired instrument for insertion (indication flashes), then press the knob to actually enter the selected setting.
Knobs 1 – 8 (pressing) (a Knob to which the Instrument is assigned)	Calls up the parameter page and opens the Editor window on Logic.
Knobs 1 – 8 (tweaking) (Parameter page)	Edits the parameter.
Knobs 1 – 8 (pressing) (Parameter page)	Resets the edited parameter value to the default. (Please note that some parameters cannot be reset.)
Cursor [LEFT] / Cursor [RIGHT] (Parameter page)	Changes the page.
[INSTRUMENT]	Return to the INSTRUMENT mode.

Press the [DRUM KIT] button to indicate the Track/Slot number in the brackets [] at the top of the LCD.

The [OPTION], [CONTROL], and [ALT] buttons on the Logic Control corresponds to the [EDIT], [JOB], and [STORE] buttons respectively.

Additional operations other than those listed above are available. For details, refer to the relevant documentation of Logic Control.

When controlling Cubase SX 3:

Functions of Mackie Control assigned to [F1] – [F6] and [SF1] – [SF5] buttons

ASSIGNMENT

PAN/SEND	PAGE UP	PLUG-INS	DYN	DIAL RESET	KN1-4/5-8	
	PAGE DWN	PAN	EQ	BANK-L	BANK-R	SHIFT

FADER BANKS

TONE	FLIP	EDIT	NAME/VALUE	DIAL RESET	KN1-4/5-8	
	CHANNEL-L	CHANNEL-R		BANK-L	BANK-R	SHIFT

ARP FX	MASTER	SAVE	REVERT	DIAL RESET	KN1-4/5-8
	SENDS	INSTRUMENTS	UNDO	REDO	SHIFT

FaderGroup

EQ	5	6	7	8	KN1-4/5-8
	1	2	3	4	SHIFT

PAN/SEND	F5	F6	F7	F8	KN1-4/5-8
TONE	F1	F2	F3	F4	SHIFT

TONE	PROJECT	MIXER	SOLO DEFA	DIAL RESET	KN1-4/5-8
ARP FX	LEFT	RIGHT	CYCLE	PUNCH	SHIFT

ARP FX	CURSOR-L	CURSOR-R	ADD	DIAL RESET	KN1-4/5-8	
EQ	CURSOR-DWN	CURSOR-UP	PREV	NEXT	EDIT	SHIFT

Button/Controller names on Mackie Control	Functions
In all modes:	
[PAGE UP] [PAGE DOWN]	Calls up the next/previous page.
[SHIFT]+[PAGE UP]	Calls up the first page.
[SHIFT]+[PAGE DOWN]	Calls up the last page.
[NAME/VALUE]	Changes the indication of the parameter name and its value.
[SEL]	Selects a channel.
[MUTE]	Mutes or unmutes each channel.
[SHIFT]+[SOLO DEFEAT]	Unmutes all channels.
[SOLO]	Sets Solo for each channel to on or off.
[SOLO DEFEAT]	Sets Solo for all channels to off.
[REC RDY]	Sets the REC RDY of each channel to on or off.
[BANK </>]	Scrolls through the track indication every eight channels.
[CHANNEL </>]	Scrolls through the track indication channel-by-channel.
[FLIP]	Switches the functions of the Channel Knobs and Faders.
[CYCLE]	Turns Loop on or off.
[F1] – [F8]	[F1] – [F8] as defined in Cubase SX.
[PROJECT]	Brings the Track View window to the front of the computer screen.
[MIXER]	Opens the Mixer window.
[SHIFT]+[EDIT]	Closes the current window.
[1] – [8]	Corresponds to 1 – 8 of the Channel View on the Mixer Window.
[UNDO]	Executes the Undo operation.
[REDO]	Executes the Redo operation.
[SAVE]	Executes the Save operation.
[ADD]	Enters a Marker at the current song position.
[RWD]	Hold to continuously rewind.
[SHIFT]+[RWD]	Moves the song position to the top of the song.
[PREV]	Moves the song position to the previous Marker.
[FF]	Hold to continuously fast-forward.
[SHIFT]+[FF]	Moves the song position to the end of the song.
[NEXT]	Moves the song position to the next Marker. (This may not work in certain conditions.)
[STOP]	Press to stop recording or playback. Pressing this when playback is stopped goes to the song location at which the song playback started at last time.
[PLAY]	Press to start playback from the current point.
[REC]	Press this to start song recording. The [▶] (Play) and [REC] lamp are turned on during recording.
PAN mode [PAN] (MULTI CHANNEL only)	
Knobs 1 – 8	For editing parameters.
EQ mode [EQ] (SELECTED CHANNEL only)	
Knobs 1 – 8	For editing parameters.

Button/Controller names on Mackie Control	Functions
SEND mode [DYN] (SELECTED CHANNEL only)	
Knobs 1 – 8	For editing parameters.
PLUG-IN mode [PLUG-IN] (SELECTED CHANNEL only)	
Knob 1	Changes the Slot Number (on page 1 only).
Knob 2	Turns the Effects on or off (on page 1 only).
Knob 3	Selects an Effect Type (on page 1 only).
Knobs 1 – 8 (turning)	Edits each of the parameters (on page 2 and later).
SEND EFFECT mode [SENDS]/MASTER EFFECT mode [MASTER] (Global mode only)	
Knob 1	Changes the Slot Number (on page 1 only).
Knob 2	Turns the Effects on or off (on page 1 only).
Knobs 1 – 8	Edits each of the parameters (on page 2 and later).
INSTRUMENT mode [INSTRUMENTS] (Global mode only)	
Knob 1	Changes the Slot Number (on page 1 only).
Knob 2	Turns the software tone generator on or off (on page 1 only).
Knobs 1 – 8	Edits each of the parameters (on page 2 and later).

Parameters to be edited differ depending on the assigned Effect and Software Tone Generator. Additional operations other than those listed above are available. For details, refer to the relevant documentation of Mackie Control.

When controlling SONAR 4:

Functions of Mackie Control assigned to [F1] – [F6] and [SF1] – [SF5] buttons

ASSIGNMENT

PAN/SEND

SENDS	PLUG-INS	DYN	DIAL RESET	KN1-4/5-8
TRACKS	PAN	EQ	BANK-L	BANK-R
				M1

FADER BANKS

TONE

FLIP	EDIT	NAME/VALUE	DIAL RESET	KN1-4/5-8
CHANNEL-L	CHANNEL-R		BANK-L	BANK-R
				M1

TRACKS/DIALOG/WINDOW

ARP FX

OK/ENTER	CANCEL	NEXT WINDOW	CLOSE WINDOW	KN1-4/5-8
NEW AUDIO	NEW MIDI	FIT TRACK	FIT PROJECT	
				M1

EQ

TRACK	AUX	MAIN	DIAL RESET	KN1-4/5-8
SAVE	UNDO	REDO	BANK-L	BANK-R
				M1

PAN/SEND

TONE

F5	F6	F7	F8	KN1-4/5-8
F1	F2	F3	F4	
				M1

TONE

ARP FX

JOG PRM	LOOP ON/OFF	HOME	DIAL RESET	KN1-4/5-8
MAKER	LOOP	SELECT	PUNCH	
				M1

ARP FX

EQ

CURSOR-L	CURSOR-R	SCRUB	DIAL RESET	KN1-4/5-8
CURSOR-DWN	CURSOR-UP	ZOOM	BANK-L	BANK-R
				M1

Button/Controller names on Mackie Control	Functions
In all modes:	
[EDIT]	Assigns a parameter to a Knob by using the [CHANNEL] and [BANK] buttons.
[CHANNEL </>] (Multi channel)	Changes a parameter to be edited via a Knob in order one by one when [EDIT] is turned on.
[BANK </>] (Multi channel)	Changes the parameters to be edited via a Knob in groups of eight when [EDIT] is turned on.
[CHANNEL </>] (Selected channel)	Changes an indicated parameter in order one by one when [EDIT] is turned on.
[BANK </>] (Selected channel)	Changes the indicated parameters in groups of eight when [EDIT] is turned on.
[NAME/VALUE]	Changes the indication of the parameter name and its value.
[SEL]	Selects a channel.
[MUTE]	Mutes or unmutes each channel.
[M4]+[MUTE]	Unmutes all channels.
[SOLO]	Sets Solo for each channel to on or off.
[M4]+[SOLO]	Sets Solo for all channels to off.
[REC RDY]	Sets the REC RDY of each channel to on or off.
[M4]+[REC RDY]	Sets the REC RDY of all channels to off.
[TRACK]	Assigns a Track to a Fader.

Button/Controller names on Mackie Control	Functions
[AUX]	Assigns an AUX BUS to a Fader.
[MAIN]	Assigns output level adjustment of the Virtual Main Bus to the Faders.
[BANK </>]	Scrolls through the track indication every eight channels.
[CHANNEL </>]	Scrolls through the track indication channel-by-channel.
[FLIP]	Assigns the functions of the Channel Knobs to the Faders.
[FLIP] → [FLIP]	Switches the functions of the Channel Knobs and the Faders.
[NEXT WINDOW]	Moves the next window to the front of the screen.
[LOOP SW]	Sets Loop to on or off.
[F1] – [F8]	[F1] – [F8] as defined in SONAR.
[CLOSE WINDOW]	Closes the current window.
[UNDO]	Executes the Undo operation.
[REDO]	Executes the Redo operation.
[SAVE]	Executes the Save operation.
[M1]+[MARKER]	Opens the window for entering the Marker to the current song position.
[MARKER]	Turns the Marker on or off.
[RWD]	Press briefly to move back one measure at a time, or hold to continuously rewind. When the Marker is turned on, this operation moves the song position to the previous Marker.
[M1]+[RWD]	Moves the song position to the top of the song. When the Marker is turned on, this operation opens the window for entering the Marker.
[FF]	Press briefly to move forward one measure at a time, or hold to continuously fast-forward. When the Marker is turned on, this operation moves the song position to the next Marker.
[M1]+[FF]	Moves the song position to the end of the song. When the Marker is turned on, this operation opens the window for entering the Marker.
[STOP]	Stops recording or playback.
[PLAY]	Press to start playback from the current point.
[REC]	Press this to start song recording. The [▶] (Play) and [REC] lamp are turned on during recording.
[ZOOM]	Turns Zoom on and off.
[SCRUB]	Turns Scrub on and off. When Scrub is on, the dial can be used for Scrub playback. When Scrub is off, the dial is used to move the song position.
[JOG PRM]	Turns Data Entry on and off. When turned on (the lamp lights), rotating the dial has the Data Entry function.
TRACK mode [TRACKS] (Track Parameter mode) [TRACKS] → [TRACKS] (Selected Channel mode)	
Knobs 1 – 8 (turning)	For editing parameters. (The LCD indication may not be updated.)
Knobs 1 – 8 (pressing)	Resets the parameter value to its default.
PAN mode [PAN] [PAN] → [PAN] (Selected Channel mode of PAN/SURROUND)	
Knobs 1 – 8 (turning)	For editing parameters.
Knobs 1 – 8 (pressing)	Resets the parameter value to its default.
SEND mode [SENDS] [SENDS] → [SENDS] (Selected Channel mode)	
Knobs 1 – 8 (turning)	For editing parameters.
Knobs 1 – 8 (pressing)	Resets the parameter value to its default.
PLUG-IN mode [PLUG-IN] [PLUG-IN] → [PLUG-IN] (Selected Channel mode)	
[M1]+[CHANNEL </>]	Changes the Plug-in number when the [EDIT] is turned on.
Knobs 1 – 8 (turning)	For editing parameters.
Knobs 1 – 8 (pressing)	Resets the parameter value to its default.
EQ Edit [EQ] [EQ] → [EQ] (Selected Channel mode) (in the Selected Channel mode) [EQ] (Band mode)	
[M1]+[CHANNEL </>]	Changes the EQ number when the [EDIT] is turned on.
Knobs 1 – 8 (Band mode)	For editing each frequency band.
Faders (Band mode)	For editing the gain of each Band.

The Song Position Bar may not synchronize with the actual playback position during Scrub playback.

Parameters to be edited may differ depending on the assigned Effect and Software Tone Generator.

Some parameters may not be available depending on the selected Effect Type.

Press the [DRUM KIT] button to indicate the Track/Slot/EQ/DYN number in the brackets [] at the top of the LCD.

The [M2] – [M4] buttons on the Mackie Control correspond respectively to the [EDIT], [JOB], and [STORE] buttons.

Additional operations other than those listed above are available. For details, refer to the relevant documentation of Mackie Control.

You can find the Help window by selecting "Mackie Control" from the Tool Menu on SONAR and pressing the [F1] button.

Please keep in mind that some functions may not be available.

When controlling Digital Performer 4.5.2:

Functions of Mackie Control assigned to [F1] – [F6] and [SF1] – [SF5] buttons

ASSIGNMENT	
PAN/SEND	SENDS PLUG-INS DYN DIAL RESET KN1-4/5-8 I/O PAN EQ BANK-L BANK-R SHIFT
FADER BANKS	
TO NE	FLIP EDIT LEVEL METERS DIAL RESET KN1-4/5-8 CHANNEL-L CHANNEL-R BANK-L BANK-R SHIFT
Track Groups/Windows	
ARP FX	SEQ EDITOR TR OVERVIEW MIXING BOARD DIAL RESET KN1-4/5-8 GROUP UNGROUP SUSPEND BANK-L BANK-R SHIFT
Dialog/Record	
EQ	OVERDUB PATCH THRU CLEAR CLIP DIAL RESET KN1-4/5-8 ENTER ESCAPE CLICK COUNTOFF SHIFT
Transport/Project	
PAN/SEND	UNDO REDO SAVE AUDIBLE MODE KN1-4/5-8
TO NE	SLAVE EXT SYNC MEMORY LINK PRE/POST ROLL BANK-L BANK-R SHIFT
TO NE	PUNCH SELECT SOLO DIAL RESET KN1-4/5-8
ARP FX	MARKER EDIT GRID CYCLE BANK-L BANK-R SHIFT
ARP FX	CURSOR-L CURSOR-R SCRUB DIAL RESET KN1-4/5-8
EQ	CURSOR-DWN CURSOR-UP ZOOM BANK-L BANK-R SHIFT

Button/Controller names on Mackie Control	Functions
In all modes:	
[I/O]	Calls up the Mode list display.
[LEVEL METERS]	Turns the Meter indication on or off.
[SEL]	Selects a channel.
[SHIFT] + [SEL]	Selects multiple channels.
[MUTE]	Mutes or unmutes each channel.
[SOLO]	Sets Solo for each channel to on or off.
[REC RDY]	Sets the REC RDY of each channel to on or off.
[BANK </>]	Scrolls through the track indication every eight channels.
[CHANNEL </>]	Scrolls through the track indication channel-by-channel.
[CONTROL]+[CYCLE]	Turns Loop on or off.
[TR OVERVIEW]	Moves the Track Overview to front.
[MIXING BOARD]	Opens the Mixer window.
[SEQ EDITOR]	Starts the Sequencer Editor window.
[SHIFT]+[SEQ EDITOR]	Starts the Soundbites window.
[UNDO]	Executes the Undo operation.
[REDO]	Executes the Redo operation.
[SAVE]	When the lamp lights, press this so that the lamp flashes. Press this again to execute the Save operation (lamp turns off).
[MARKER]	Turns the Marker on or off.
[SHIFT]+[MARKER]	Opens the Marker Option window.
[RWD]	Press to continuously rewind. Press again to rewind more quickly. When the Marker is turned on, this operation moves the song position to the previous Marker.
[FF]	Press to continuously fast-forward. Press again to fast-forward more quickly. When the Marker is turned on, this operation moves the song position to the next Marker.
[STOP]	Stops recording or playback.
[PLAY]	Press to start playback from the current point.
[REC]	Press this to start song recording. The [▶] (Play) and [REC] lamp are turned on during recording.
[ZOOM]	Switches between Scroll (lamp lights), Zoom (lamp is off), and Nudge (lamp flashes).
[SCRUB]	Turns Scrub on and off. When turned on, you can use the dial to move the song position. (A malfunction may occur.)
PAN mode [PAN] (or [I/O] → knob)	
Knobs 1 – 8 (turning)	For editing parameters.
[DYN] + Knobs 1 – 8 (pressing)	Resets the edited parameter to the default value (center).
[FLIP]	Switches the functions of the Channel Knobs and the Faders.
[PAN] in the PAN mode	Turns the Meter on or off.

Button/Controller names on Mackie Control	Functions
SndVal mode [SEND] (or [I/O] → knob)	
Knobs 1 – 8 (turning)	For editing parameters.
Cursor [UP] [DOWN]	Changes the Send number.
Knobs 1 – 8 (pressing)	Sets Mute to on or off.
[DYN] + Knobs 1 – 8 (pressing)	Resets the parameter value to the default (0 dB).
[FLIP]	Switches the functions of the Channel Knob and the Faders.
[SEND] in the SndVal mode	Turns the Meter on or off.
SndOut mode [I/O] → Knob	
Cursor [UP] [DOWN]	Changes the Send number.
Knobs 1 – 8 (turning)	Selects the bus for each Send of the track.
Knobs 1 – 8 (turning) (except when selecting a bus)	Switches between Send PRE and POST.
Input mode [I/O] → Knob	
Knobs 1 – 8 (turning)	Selects an input bus for a track.
Output mode [I/O] → Knob	
Knobs 1 – 8 (turning)	Selects an output bus for a track.
Effect mode [PLUG-IN] (or [I/O] → Knob)	
Knobs 1 – 8 (turning)	Selects a Plug-in Effect for each track.
Cursor [UP] [DOWN]	Changes the Effect Number.
Knobs 1 – 8 (pressing)	Turns the Effect Bypass on or off. When the bus is turned on, X is indicated above the Effect name.
[EQ] + Knobs 1 – 8 (pressing)	Assigns the Parametric EQ to the corresponding track.
[EDIT] + Knobs 1 – 8 (pressing) (when any track is selected)	Enters the Plug-in Effect Edit mode. (Available only when the Plug-in Effect is selected.) Please keep in mind that some parameters may not be available depending on the selected Effect Type. Press the [EDIT] button again to exit from the Edit mode.
Edit mode	
Knobs 1 – 8 (turning)	For editing parameters.
Cursor [UP] [DOWN]	Changes an Effect Number.
[LEFT]/[RIGHT]	Calls up the Effect of a different track.
[CHANNEL </>]	Changes the parameters to be edited with the Knobs in order one by one.
[BANK </>]	Changes the parameters to be edited with the Knobs in groups of eight.
[FLIP]	Switches the functions of the Channel Knobs and the Faders.

Some edited values are not shown on the MO display.

Press the [DRUM KIT] button to indicate the Send/Effect number in the brackets [] at the top of the LCD.

Some parameters may not be available depending on the Effect Type.

The [OPTION], [CONTROL], and [COMMAND] buttons on the Mackie Control correspond respectively to the [EDIT], [JOB], and [STORE] buttons.

Additional operations other than those listed above are available. For details, refer to the relevant documentation of Mackie Control.

Please keep in mind that some functions may not be available.

Creating Your Original Program Set (Master mode)

The Master mode is the highest mode in the MO hierarchy, letting you instantly switch between programs you've created in the Voice, Performance, Song and Pattern modes. Use the Master mode in one of the following ways:

■ Storing your favorite programs

This lets you register settings that you often use in the Voice, Performance, Song or Pattern mode, and instantly recall the mode and custom settings together in a single button press, without having to first select a mode. It also lets you set up a sequence of custom programs—for example, when playing different songs live—and smoothly switch from setting to setting as needed.

■ Playing as a master keyboard

This lets you divide the keyboard into four separate sections—just as if you were playing four different MIDI keyboards. You can also separately play the sounds of the MO and the sounds of connected MIDI devices—all from the MO keyboard—by assigning each zone to a different MIDI channel. Moreover, you can use the Control sliders to tweak the sound of each as desired.

Selecting a Master

The MO features 128 specially programmed Masters. Try some of these out now.

1 Press the [MASTER] button to enter the Master Play mode.

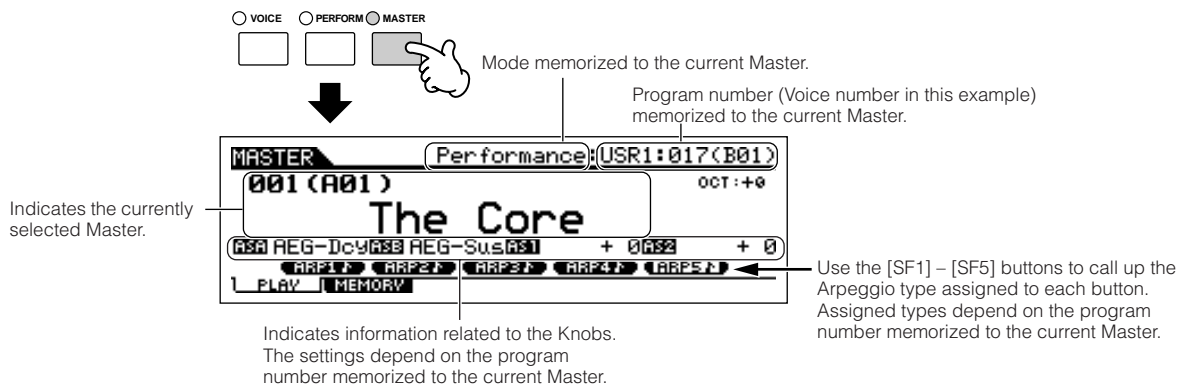

2 Select a Master.

Selecting a Master is done in basically the same way as selecting a Voice. Since there is only one bank for Masters, you need not select a Master bank.

3 Play the selected Master program.

When the Mode is set to Voice or Performance, play the keyboard.
When the Mode is set to Song or Pattern, press the [▶] button.



Storing your favorite programs

1 Select a Master to be created.

2 Press the [F2] MEMORY button to call up the Mode setting display.

3 Select the desired mode and program number to register the Master. If you want to divide the keyboard into multiple Zones in the Master, set the Zone Switch to “on.”

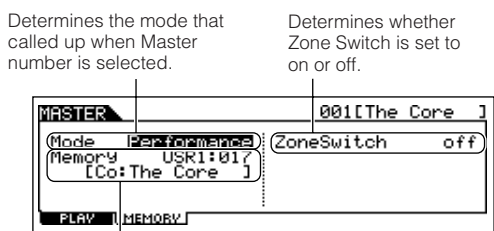

Determines the mode that called up when Master number is selected.

Determines whether Zone Switch is set to on or off.

Determines the program number that is called up when the Master is selected.

4 Name the edited Master.

Input a name in the [EDIT] → [COMMON] → [F1] NAME display.

For detailed instructions on naming a voice, refer to page 38.

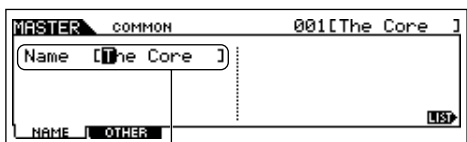

Input a Master name.

5 Store the edited Master to internal User memory.

5-1 Press the [STORE] button to enter the Master Store mode.

5-2 Select the destination Master by using the data dial or the [INC/YES] and [DEC/NO] buttons.

⚠ CAUTION

When you execute the Store operation, the settings for the destination memory will be overwritten. Important data should always be backed up to a separate USB storage device (page 211).

5-3 Press the [ENTER] button. (The display prompts you for confirmation.)

To cancel the Store operation, press the [DEC/NO] button.

5-4 Press the [INC/YES] button to execute the Store operation.

⚠ CAUTION

Never attempt to turn off the power while an “Executing...” or “Please keep power on” message is shown. Turning the power off in this state may cause the system to freeze and prevent normal startup the next time the power is turned on, as well as resulting in the loss of all user data.

⚠ CAUTION

If you select another Master without storing, the currently edited Master will be lost. Make sure to store the edited Master before selecting another Master.

Playing as a master keyboard

In the Master mode, you can divide the keyboard into (up to) four independent areas (called “Zones”). Each Zone can have different MIDI channel assignments as well as different functions for the Control sliders. This makes it possible to control several parts of the multi-timbral tone generator simultaneously by a single keyboard or to control voices of an external MIDI instrument over several different channels in addition to the internal voices of this synthesizer itself—letting you use the MO to effectively do the work of several keyboards.

You can set the parameters related to the four Zones in the Master Edit mode and store the settings as a User Master.

1 Select a Master to be created.

2 Press the [F2] MEMORY button to call up the Mode setting display.

3 After setting the Mode and Program number which you wish to memorize to the Master, set the Zone Switch to “on.”

Determines the mode that is called up when the Master number is selected.

Set the Zone Switch to “on.”

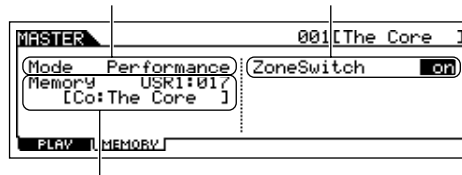

Determines the program number that is called up when the Master is selected.

4 Press the [EDIT] button to enter the Master Edit mode.

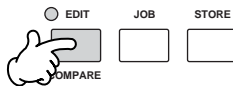

5 Call up the Common Edit display or Zone Edit display.

Use Zone Edit to edit the parameters for each Zone. Use Common Edit to edit the parameters for all of the Zones.

While in the Master Edit mode, you can switch between the Common Edit display and the Zone Edit display as shown below.

Calling up the Common Edit display
Press the [COMMON] button to call up the Common Edit display. In the Edit mode, the [DRUM KITS] button functions as the [COMMON] button.

Indicates a Common Edit display.

Calling up the Zone Edit display
Press the desired Zone number from the ZONE [1] – [4] buttons to call up the Zone Edit display.

Indicates the display for editing Zone 1.

Zone 1 Edit

Zone 2 Edit

Zone 3 Edit

Zone 4 Edit

6 Select the menu you wish to edit by pressing the [F1] – [F5] buttons and [SF1] – [SF5] buttons, then edit the parameters in each display.

See the next page for details and some setting examples.

7 Name the edited Master.

Input a name in the [EDIT] → [COMMON] → [F1] NAME display. For detailed instructions on naming a Voice, refer to page 38.

8 Store the edited Master to internal User memory.

Refer to step 5 on page 123.

Using Zones effectively with an external tone generator

The two examples below show how to use the Zones with both the internal tone generator and a connected external tone generator. These instructions correspond to the steps on the previous page.

NOTE Though all four Zones are used in the example below, you can use any number of Zones (two, three, or four). The settings are made with the MIDISwitch parameter ([MASTER] → [EDIT] → Zone selection → [F1] TRANS → MIDISwitch) and the TGSwitch parameter ([MASTER] → [EDIT] → Zone selection → [F1] TRANS → TGSwitch).

NOTE In these examples, the Zones are assigned to different areas of the keyboard. However, two or more Zones can also be assigned to the same area in a layer, from the NOTE display ([MASTER] → [EDIT] → Zone selection → [F2] NOTE).

Master settings with the Voice mode/Performance mode (Single-timbre tone generator mode)

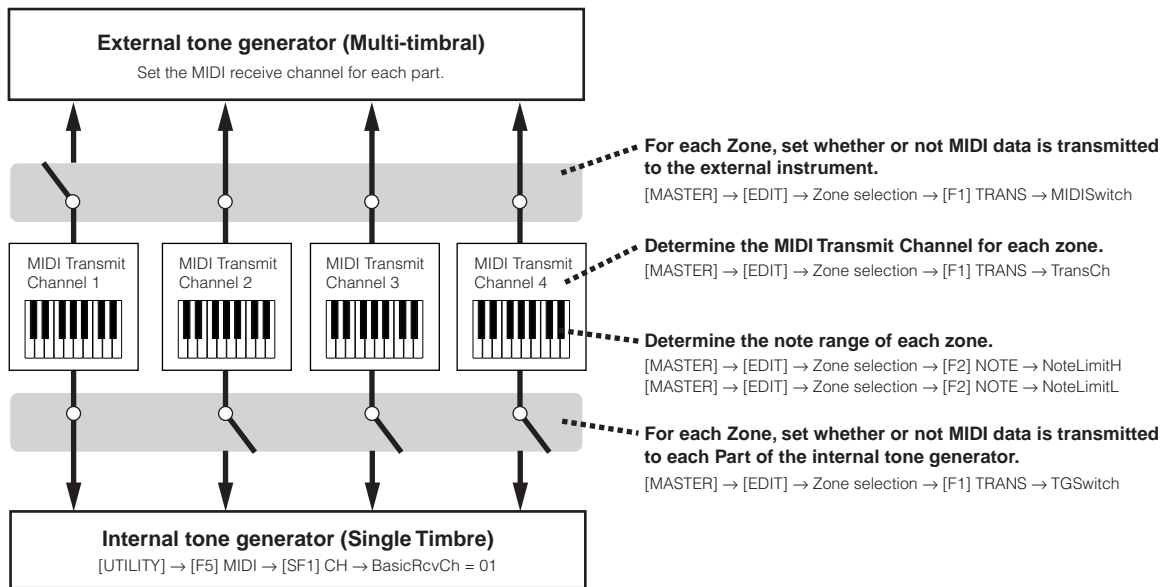

Master settings with the Song mode/Pattern mode (Multi-timbral tone generator mode)

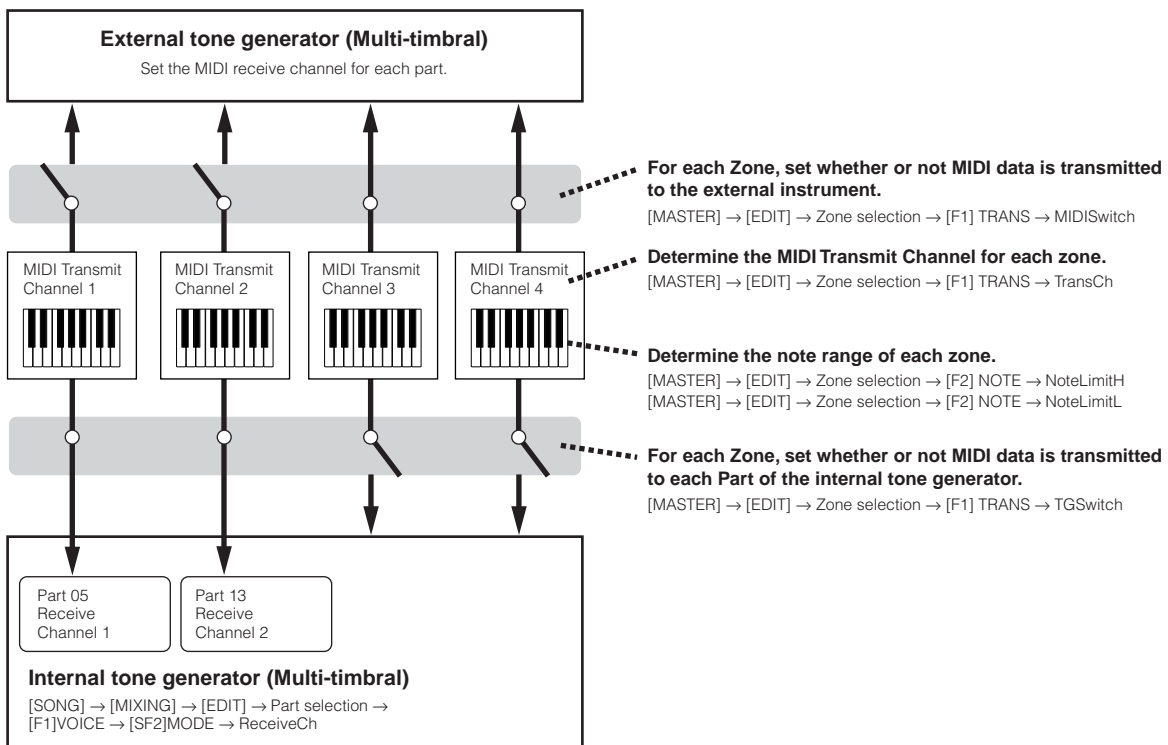

Assigning Control Change numbers to the Knobs/Sliders for each Zone

Here in the KN/CS display of the Master Edit mode, you can set how the Control Knobs and Sliders will affect each Zone. This lets you specify a separate MIDI Control Change number for each Knob and Slider.

All indicators are turned off by setting the [MASTER] → [EDIT] → [COMMON] → [F2] OTHER → Knob/Slider parameter to "zone."

DAW REMOTE PAGE SELECT	ASSIGN A	ASSIGN B	ASSIGN 1	ASSIGN 2
PAN/SEND	PAN	REVERB	CHORUS	TEMPO
ASSIGN: ↵	CUTOFF	RESONANCE	ATTACK	RELEASE
TONE	SWING	GATE TIME	VELOCITY	UNIT MULTIPLY
ARP FX	LOW	LOW MID	HIGH MID	HIGH
MEF ↵				
EQ				

MASTER	ZONE 1	ZONE 2	ZONE 3	ZONE 4
CtrlKnob	10	10	10	10
CtrlSlider	11	11	11	11

You can determine which Control Change numbers are used for the Knobs and Sliders for each zone in the [MASTER] → [EDIT] → Zone selection → [F5] KN/CS display.

In the example above, the Control Knobs for all Zones have been set to 10 (Pan), and the Sliders have been set to 11 (Expression). In this way, you can control the stereo position of each Zone with the appropriate Knob, and use the Sliders to adjust the relative volume balance among the Zones.

TIP Setting up the Master Zones to Split or Layer

This operation lets you easily determine whether the Zones of the selected Master are to be used in a Split or a Layer. The note range settings for each Zone can be determined by setting the NoteLimitH and NoteLimitL parameters from the NOTE display ([MASTER] → [EDIT] → Zone selection → [F2] NOTE).

NOTE Zones 1 and 2 are used in the explanations here.

- 1** In the Master Play mode, press the [JOB] button to enter the Master Job mode.
- 2** Press the [F1] INIT button to call up the Initialize display.
- 3** Uncheckmark the box of “All” by using the [DEC/NO] button and checkmark the box of “Zone.”
- 4** Set the Type to “Split” or “Layer.”



When Type is set to “Split”

Set the UpperCh (MIDI transmit channel of the upper range), LowerCh (MIDI transmit channel of the lower range), and Split Point (which separates the keyboard into the upper range and lower range).

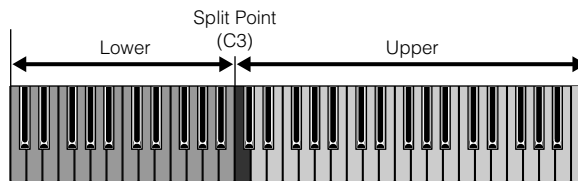

When Type is set to “Layer”

Set the UpperCh (MIDI transmit channel of Zone 1) and LowerCh (MIDI transmit channel of Zone 2).

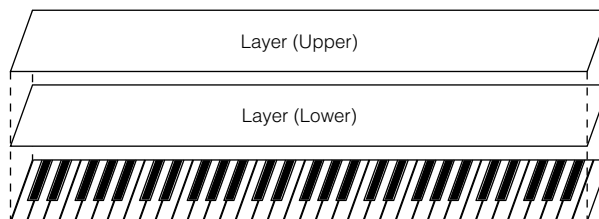

- 5** Press the [ENTER] button. (The display prompts you for confirmation.)
To cancel the Job, press the [DEC/NO] button.
- 6** Press the [INC/YES] button to execute the Job.
After the Job has been completed, a “Completed” message appears and operation returns to the original display.

Basic Structure

This section gives you an easy-to-understand overview of the MO—its wide range of sophisticated features, its MIDI control and performance functions, and its convenient file management system for original data you’ve created with the instrument.

Internal Structure (System Overview)

This synthesizer is made up of several blocks, as shown here.

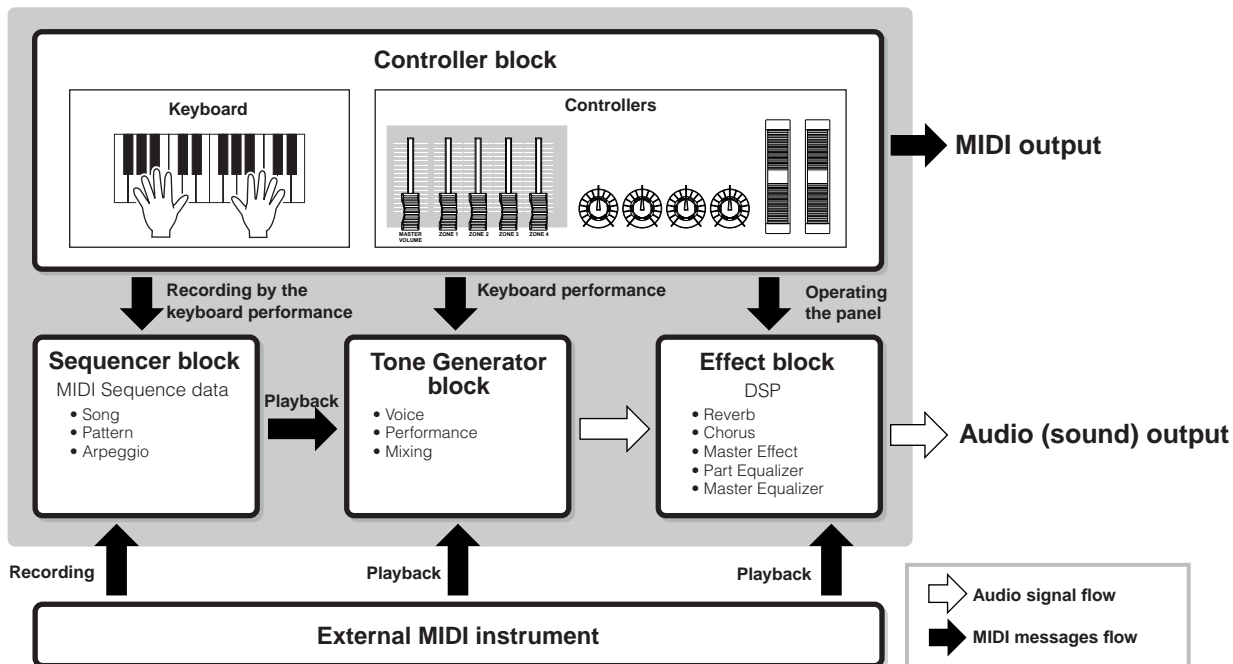

Controller block

This block consists of the keyboard, Pitch Bend and Modulation Wheels, Knobs, Control sliders, and so on. The keyboard itself doesn’t generate sounds, but instead generates/transmits note on/off, velocity and other information (MIDI messages) to the synthesizer’s tone generator block when you play notes. The controllers also generates/transmits MIDI messages. The synthesizer’s tone generator block produces the sound according to the MIDI messages transmitted from the keyboard and controllers.

Controllers supported by the MO

The controllers you can use on this synthesizer and the reference pages are as follows:

- **Controllers with which the MO is equipped**
 - Keyboard (Initial Touch).....page 16
 - Pitch Bend Wheelpage 50
 - Modulation Wheelpage 50
 - Knobpage 51
 - Control sliderpage 52
- **Controllers (sold separately) that can be connected to the rear panel of the MO**
 - Foot Controller..... page 69
 - Footswitch page 69

Tone Generator block

The Tone Generator block is what actually produces sound in response to the MIDI messages generated by playing the keyboard, using the controllers, and the playback of the sequencer (Song/Pattern/Arpeggio).

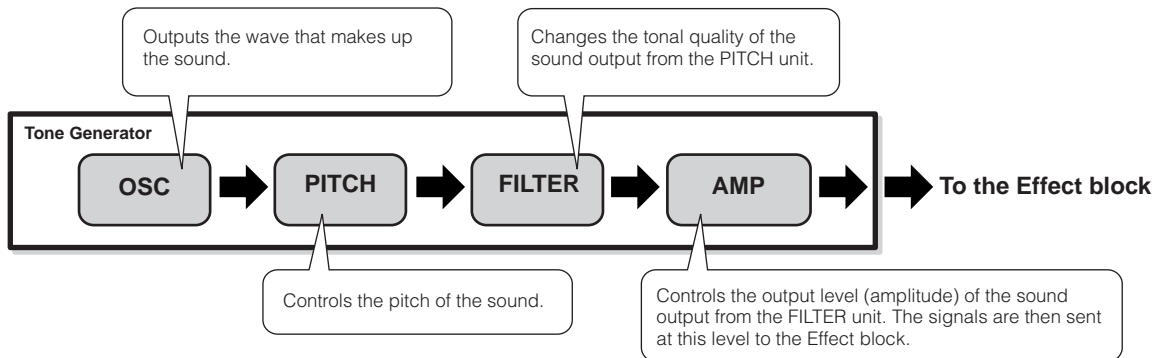

Internal AWM2 Tone Generator

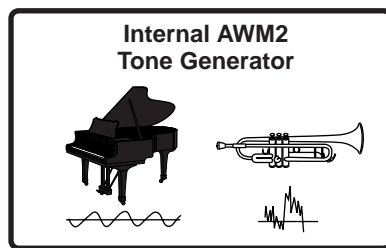

● AWM2 (Advanced Wave Memory 2)

AWM2 (Advanced Wave Memory 2) is a synthesis system based on sampled waves (sound material), and is used in many Yamaha synthesizers. For extra realism, each AWM2 Voice uses multiple samples of a real instrument's waveform. Furthermore, a wide variety of parameters—envelope generator, filter, modulation, and others—can be applied.

Voice, Performance, and Mixing

This instrument features three different types of programs, that form the basis for creating and playing sounds.

● Voice

A program that contains the sonic elements for generating a specific musical instrument sound is referred to as a "Voice." Each Voice consists of up to four Elements (Normal Voice) or up to 73 Keys (Drum Voice). Each Voice is created by editing parameters unique to each Element/Key and parameters common to all the Elements/Keys in the Voice mode (page 151) or in the Mixing Voice mode (page 203).

● Performance

A program in which multiple Voices (parts) are combined in a layer, or in other configurations is referred to as a "Performance." Each Performance can contain up to four different Parts (Voices). Each Performance can be created by editing parameters unique to each Part and parameters common to all the Parts in the Performance mode (page 171).

● Mixing

A program in which multiple Voices are assigned to Parts for multi-timbral play in the Song and Pattern modes is referred to as a "Mixing." Each Mixing can contain up to 16 Parts (page 136). Each Mixing can be created by editing parameters unique to each Part and parameters common to all the Parts in the Song Mixing mode (page 189) or in the Pattern Mixing mode (page 202).

NOTE The Mixing belongs to the Song or Pattern.

The illustration below shows the structure and interrelationship of the Voices, Performances, and Mixings.

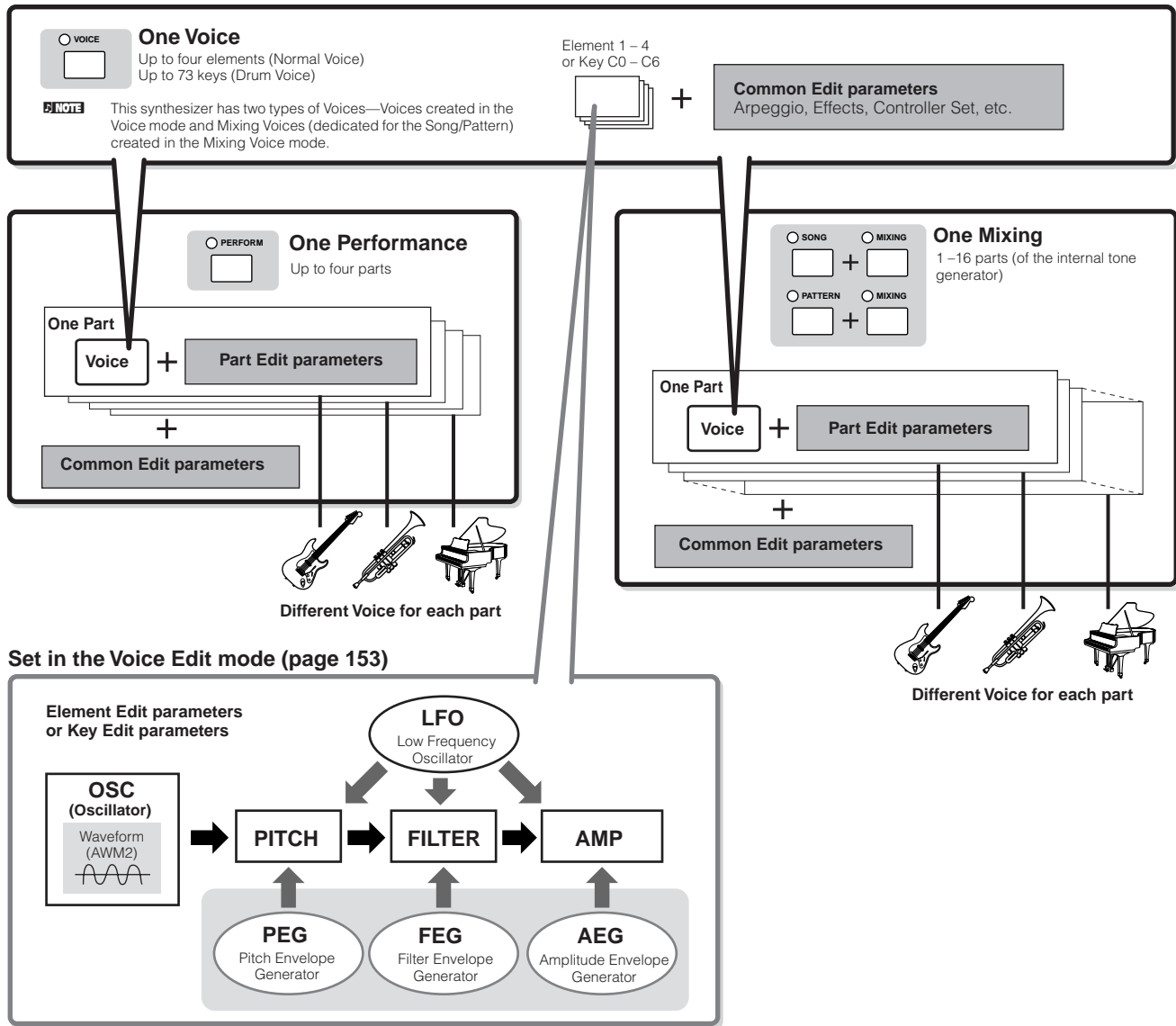

Basic Structure

NOTE The Drum Voice Key Edit parameters do not contain LFO settings.

Keyboard Mega Voices

Normal Voices use velocity switching to make the sound quality and/or level of a Voice change according to how strongly or softly you play it. This makes the Voices sound authentic and natural. However, with Keyboard Mega Voices, each velocity range (the measure of your playing strength) has a completely different sound. For example, a guitar Voice includes the sounds of various performance techniques. In conventional instruments, different Voices having those sounds would be called up via MIDI and played in combination to achieve the desired effect. Now with Keyboard Mega Voices, a convincing guitar Part can be played with just a single Voice, using specific velocity values to play the desired sounds.

NOTE The Keyboard Mega Voice names are indicated as "Mega ***" in the display.

The following illustrations may help in understanding the memory structure of the Voices, Performances, and Mixings.

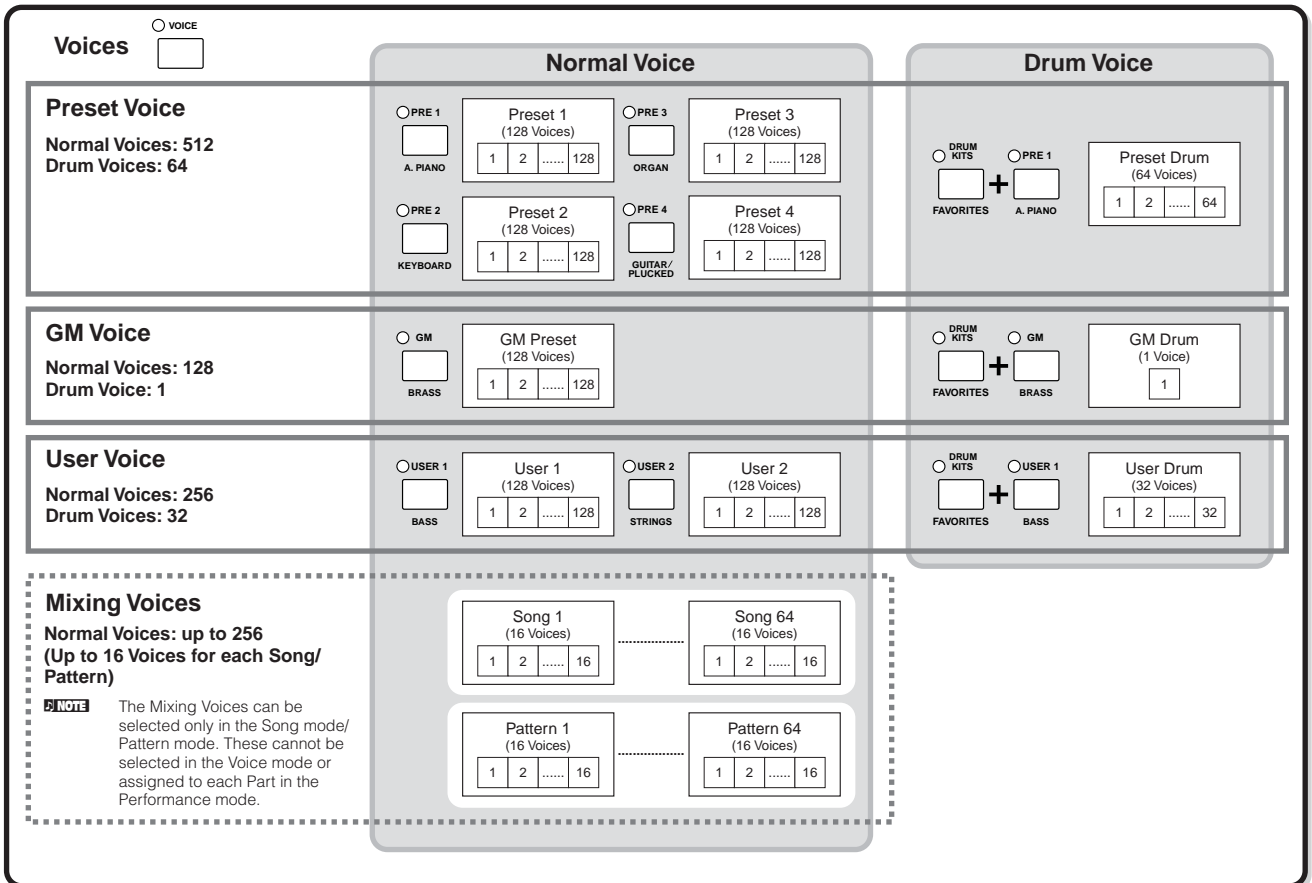

Basic Structure

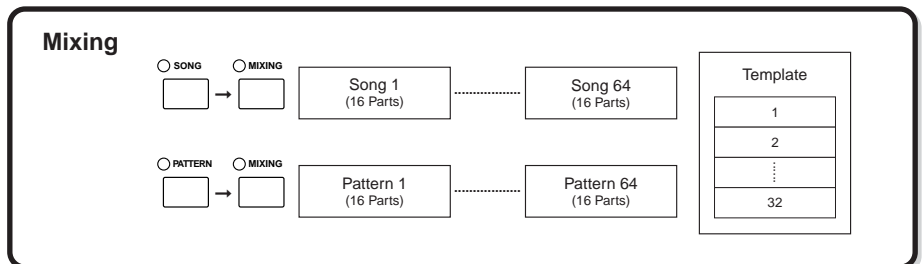
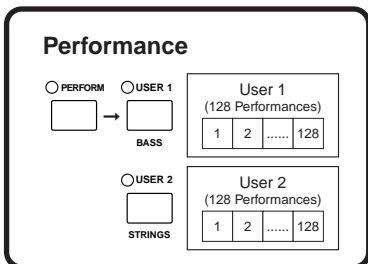

Normal Voice and Drum Voice

Internally, there are two Voice Types: Normal Voices and Drum Voices.

Normal Voices are mainly pitched musical instrument-type sounds that can be played over the range of the keyboard.

Drum Voices are mainly percussion/drum sounds that are assigned to individual notes on the keyboard. A collection of assigned percussion/drum waves or Normal Voices is known as a Drum Kit.

Normal Voice

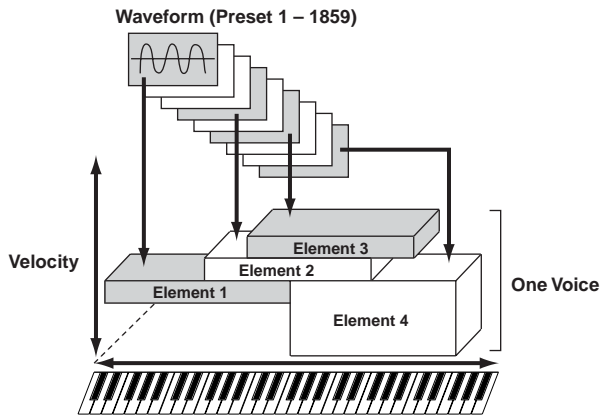

Drum Voice

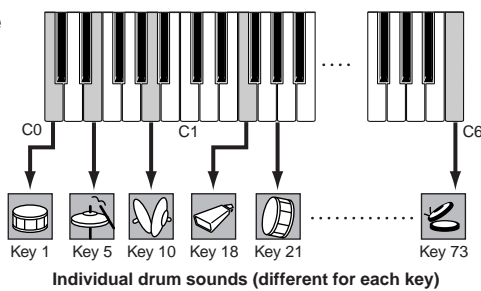

GM Voices

GM (General MIDI) is a worldwide standard for Voice organization and MIDI functions of synthesizers and tone generators. It was designed primarily to ensure that any song data created with a specific GM device would sound virtually the same on any other GM device—no matter the manufacturer or the model. The GM Voice bank on this synthesizer is designed to appropriately play back GM song data. However, keep in mind that the sound may not be exactly the same as played by the original tone generator.

Tone generator parameters that produce the Voice sound

Among various parameters that makes up one Voice, Oscillator, Pitch, Filter, Amplitude, LFO and three Envelope Generators (PEG, FEG, AEG) shown in the illustration on pages 132 - 134 are the basic parameters for creating the Voice sound. Parameters related to Oscillator, Pitch, Filter and Amplitude determine the three basic elements of the sound—Pitch (how low or high it is), Tone (or its overall sound quality), and Volume (how loud its volume level is) of the Voice. Parameters such as LFO and EG (Envelope Generator) determine the transition in these three basic elements of the sound from the moment the sound starts to the moment the sound stops.

In the sections that follow, we'll explain in detail about the sound-related parameters and provide an introduction to the basics of electronic synthesis.

Oscillator

[VOICE] → Voice selection → [EDIT] → Element selection/ Drum Key selection → [F1] OSC

This unit outputs the wave which determines the basic pitch. You can assign the wave (or basic sound material) to each Element of the Normal Voice or each Key of the Drum Voice. In the case of the Normal Voice, you can set the note range for Element (the range of notes on the keyboard over which the Element will sound) as well as the velocity response (the range of note velocities within which the Element will sound). For example, you could set one Element to sound in an upper range of the keyboard, and another Element to sound in a lower range. Thus, even within the same Voice, you can have two different sounds for different areas of the keyboard or you can make the two Element ranges overlap so that their sounds are layered over a set range. Furthermore, you can set each Element to respond to different velocity ranges so that one Element sounds for lower note velocities, whereas another Element sounds for higher note velocities.

NOTE You can assign the wave with the following operation.
[VOICE] → Voice selection → [EDIT] → Element selection/Drum Key selection → [F1] OSC → [SF1] WAVE

Pitch

[VOICE] → Voice selection → [EDIT] → Element selection/ Drum Key selection → [F2] PITCH

This unit controls the pitch of the sound (wave) output from the Oscillator. In the case of the Normal Voice, you can detune separate Elements, apply Pitch Scaling and so on. Also, by setting the PEG (Pitch Envelope Generator), you can control how the pitch changes over time.

PEG (Pitch Envelope Generator)

Using the PEG, you can control the transition in pitch from the moment the sound starts to the moment the sound stops. You can create the PEG by setting parameters as illustrated below. When you press a note on the keyboard, the pitch of the Voice will change according to these envelope settings. This is useful for creating automatic changes in pitch, which is effective for example in synth brass sounds. Furthermore, different PEG parameters can be set for each Element or each Key.

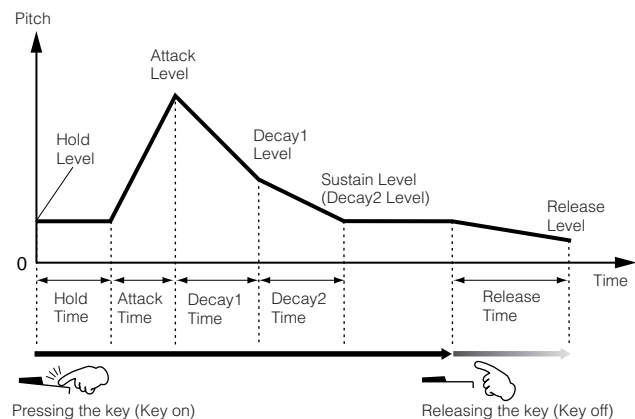

● Filter

[VOICE] → Voice selection → [EDIT] → Element selection/
Drum Key selection → [F3] FILTER

This unit modifies the tone of the sound output from Pitch by cutting the output of a specific frequency portion of the sound.

Cutoff Frequency and Resonance

Here's how filters work. In the example below (a low pass filter), a portion of the signal lower than a given frequency is allowed to pass, and signals above that frequency are cut. This frequency is referred to as the Cutoff frequency. You can produce a relatively bright or darker sound by setting the cutoff. Resonance is a parameter that boosts the level of the signal in the area of the cutoff frequency. By emphasizing the overtones in this area, this can produce a distinctive "peaky" tone, making the sound brighter and harder.

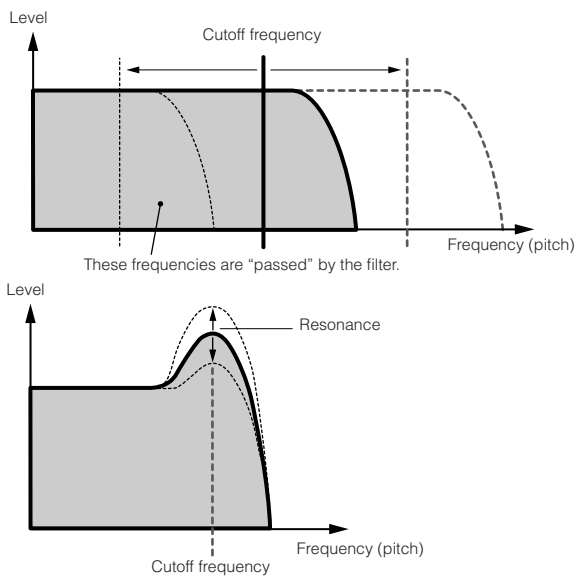

About the main Filter types

The Low Pass Filter is shown in the illustration above—however, this synthesizer features four other Filter types as shown below.

• Low Pass Filter (above)

This passes only those signals below the Cutoff frequency. You can then use the Reso (Resonance) parameter to add further character to the sound.

• High Pass Filter

This passes only those signals above the Cutoff frequency. You can then use the Reso (Resonance) parameter to add further character to the sound.

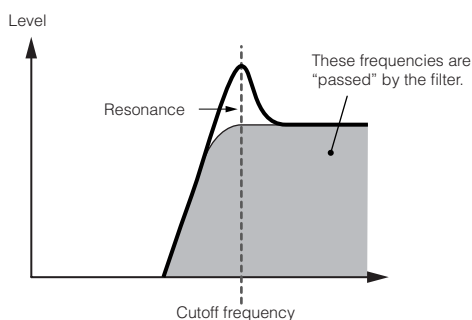

• Band Pass Filter

This passes only those a band of signals around the Cutoff frequency. The width of this band can be varied.

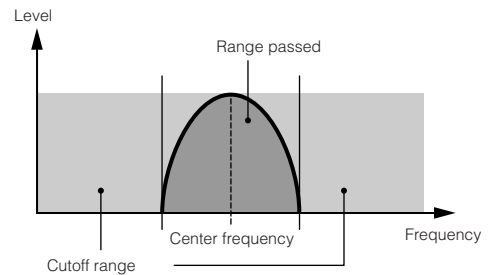

• Band Elimination Filter

This attenuates a band of signals around the Cutoff frequency, but passes everything else.

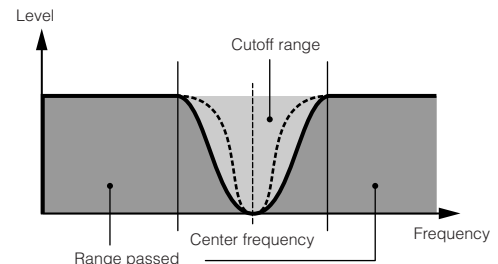

FEG (Filter Envelope Generator)

Using the FEG, you can control the transition in tone from the moment the sound starts to the moment the sound stops. You can create the FEG by setting parameters as illustrated below. When you press a note on the keyboard, the cutoff frequency will change according to these envelope settings. This is useful for creating automatic wah or filter sweep effects, for example. Furthermore, different FEG parameters can be set for each Element or each Key.

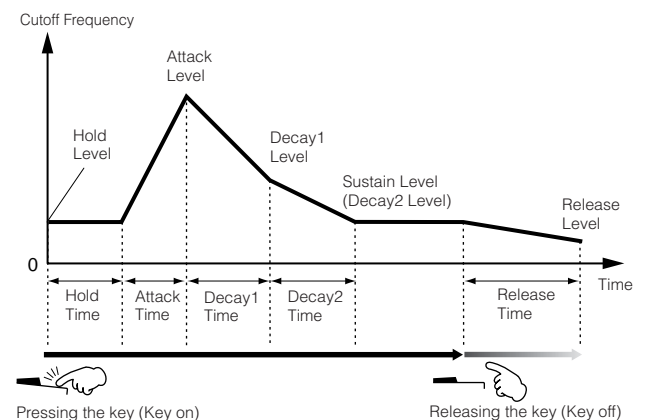

● **Amplitude**

[VOICE] → Voice selection → [EDIT] → Element selection/
Drum Key selection → [F4] AMP

This unit controls the output level (amplitude) of the sound output from the Filter block. The signals are then sent at this level to the Effect block. Also, by setting the AEG (Amplitude Envelope Generator), you can control how the volume changes over time.

● **AEG (Amplitude Envelope Generator)**

Using the AEG, you can control the transition in volume from the moment the sound starts is to the moment the sound stops. You can create the AEG by setting parameters as illustrated below. When you press a note on the keyboard, the volume will change according to these envelope settings. Furthermore, different AEG parameters can be set for each Element or each Key.

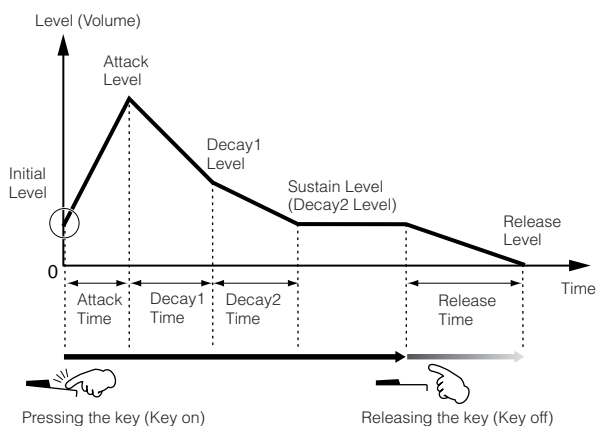

● **LFO (Low Frequency Oscillator)**

[VOICE] → Voice selection → [EDIT] → Element selection/
Drum Key selection → [F5] LFO

[VOICE] → Voice selection → [EDIT] → [COMMON] → [F5] LFO

As its name suggests, the LFO produces a wave of a low frequency. These waves can be used to vary the pitch, filter or amplitude of each Element to create effects such as vibrato, wah and tremolo. LFO can be set independently for each Element; it can also be set globally for all Elements.

Single Timbre Tone Generator (Voice/Performance mode) and Multi-timbral Tone Generator (Song/Pattern mode)

The internal tone generator block operates in two different ways (Single timbre and Multi-timbral) depending on the selected mode. The difference between the two is whether or not they can handle multiple MIDI channels at the same time.

● **Single Timbre Tone Generator (Voice/Performance mode)**

A MIDI tone generator that receives over a single MIDI channel and plays a single instrument part is referred to as a “single timbre” tone generator. This is the operating status of the internal tone generator in the Voice and Performance modes.

NOTE To set the MIDI receive channel for single timbre operation (Voice and Performance modes), use the following operation in the Utility mode. [UTILITY] → [F5] MIDI → [SF1] CH → BasicRcvCh

● **Multi-timbral Tone Generator (Song/Pattern mode)**

A MIDI tone generator that simultaneously receives over multiple MIDI channels and plays multiple instrument parts is referred to as a “multi-timbral” tone generator. This allows playback of multi-channel MIDI song data—such as on a MIDI sequencer or computer—with each internal part being assigned to and played by a different track or channel. This is the operating status of the internal tone generator in the Song and Pattern modes.

NOTE To set the MIDI receive channel for multi-timbral operation (Song and Pattern modes), use the following operation in the Utility mode. [SONG] or [PATTERN] → [MIXING] → [EDIT] → Part selection → [F1] VOICE → [SF2] MODE → ReceiveCh

NOTE When using an external MIDI sequencer or computer to play this instrument, make sure to use the Song mode or Pattern mode.

Maximum Polyphony

Maximum polyphony refers to the highest number of notes that can be sounded simultaneously from the internal tone generator of the instrument. The maximum polyphony of this synthesizer is 64. When the internal tone generator block receives a number of notes exceeding the maximum polyphony, previously played notes are cut off. Keep in mind this may be especially noticeable with Voices not having decay. Furthermore, the maximum polyphony applies to the number of voice elements used, not the number of voices. When the normal voices that include up to four elements are used, the maximum number of simultaneous notes may be less than 64.

Part structure of the Tone Generator block

The MO plays the sounds in its tone generator block in response to MIDI messages received from external controllers or sequencer. The MIDI messages are assigned to sixteen independent channels, and the instrument is capable of simultaneously playing sixteen separate Parts, via the sixteen MIDI channels. However, the sixteen-channel limit can be overcome by using separate MIDI “ports,” each supporting sixteen channels.

NOTE The USB cable supports up to eight separate MIDI ports. However, the tone generator in the MO supports only one port.

NOTE A single MIDI cable/connection cannot handle data over multiple MIDI ports.

Part structure of the tone generator block in the Voice mode

In this mode, a Voice is played using a single Part. The tone generator block in the Voice mode receives MIDI data over a single channel. For this reason, song data on an external sequencer consisting of multiple MIDI channels will not play back properly in this mode. If you are using an external MIDI sequencer or computer to play the instrument, make sure to use the Song or Pattern mode.

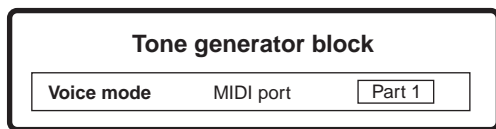

NOTE • To set the MIDI receive channel for single timbre operation (Voice and Performance modes), use the following operation in the Utility mode. [UTILITY] → MIDI display → BasicRcvCh
• In the Voice mode, the instrument recognizes only data over MIDI Port 1.

Part structure of the tone generator block in the Performance mode

This mode lets you play a Performance (in which multiple Voices or Parts are combined—in a layer, or in other configurations). While a total of seven Parts are available in this mode (as shown below), a maximum of four Parts can be used simultaneously. Although this mode lets you play several Parts at the same time, all are set to receive over the same single MIDI channel, as in the Voice mode. For this reason, song data on an external sequencer consisting of multiple MIDI channels will not play back properly in this mode. If you are using an external MIDI sequencer or computer to play the instrument, make sure to use the Song or Pattern mode.

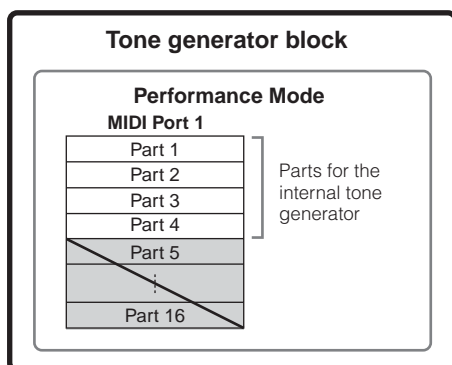

Parts 5 – 16 are not used.

NOTE • To set the MIDI receive channel for single timbre operation (Voice and Performance modes), use the following operation in the Utility mode. [UTILITY] → MIDI display → BasicRcvCh
• In the Performance mode, the instrument recognizes only data over MIDI Port 1.

Part structure of the tone generator block in the Song mode/Pattern mode

This mode lets you use multiple Parts and assign different Voices to be played back for each Part. Since different MIDI channels can be set for each Part of the tone generator block, you can use an external MIDI sequencer to play the sounds. As illustrated below, the sequence data of each track plays the corresponding Parts (those having the same MIDI channel assignment) in the tone generator block.

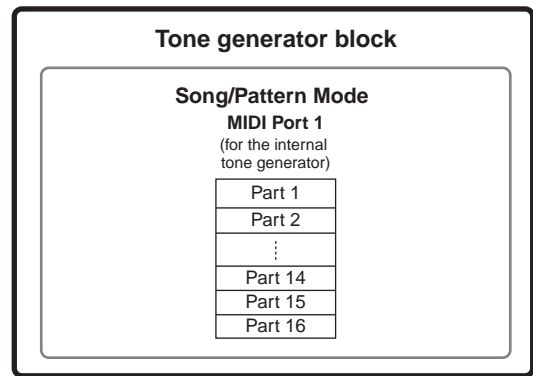

The MIDI Transmit Channel/Port of the Song/Pattern can be set with the following operation.

In the Song mode: [SONG] → Song selection → [F3] TRACK → [SF1] CHANNEL

In the Pattern mode: [PATTERN] → Pattern selection → [F3] TRACK → [SF1] CHANNEL

When sounding the internal tone generator block, assign the tracks to Transmit Port 1 and use Parts 1 – 16. Keep in mind that data over Transmit Ports 2 or 3 cannot sound the internal tone generator block.

The MIDI Receive Channel of the tone generator's part can be set with the following operation.

In the Song mode: [SONG] → Song selection → [MIXING] → [EDIT] → Part selection → [F1] VOICE → [SF2] MODE → ReceiveCh

In the Pattern mode: [PATTERN] → Pattern selection → [MIXING] → [EDIT] → Part selection → [F1] VOICE → [SF2] MODE → ReceiveCh

NOTE For details about MIDI, see page 223.

NOTE The Voice and related settings (volume, pan, etc.) are sounded by the keyboard according to the Part parameters in the Mixing settings of the current Song/Pattern and Part. Other settings such as Controllers and Effect types correspond to the Common parameters in the Mixing settings of the current Song/Pattern.

Sequencer Block

This block lets you create Songs and Patterns by recording and editing your performances as MIDI data (from the controller block), then playing it back with the tone generator block. The sequencer block can be operated in the Song mode, in the Pattern mode, and with the Arpeggio feature. When a Song or a Pattern is played back, the musical data of each sequence track is transmitted to the tone generator block according to the Transmit Channel settings.

NOTE Songs can be played back only in the Song mode. They cannot be played back in other modes.
 Patterns can be played back only in the Pattern mode. They cannot be played back in other modes.
 Arpeggios can be played back in any mode.

Songs and Patterns

Songs and Patterns are MIDI sequence data consisting of up to 16 tracks.

A Song on this synthesizer is effectively the same as a Song on a MIDI sequencer, and playback automatically stops at the end of the recorded data.

In the MO, the term “Pattern” refers to a relatively short musical or rhythmic phrase—1 to 256 measures—which is used for looped playback. Therefore, once Pattern playback starts, it continues until you press the [■] (Stop) button. This synthesizer features a variety of preset Phrase data that is used as the basic material in making up Patterns.

■ Song data structure

The following illustration shows the track structure of a Song. Songs are created by recording MIDI sequence data to individual tracks and by setting tone generator related parameters (in Song Mixing).

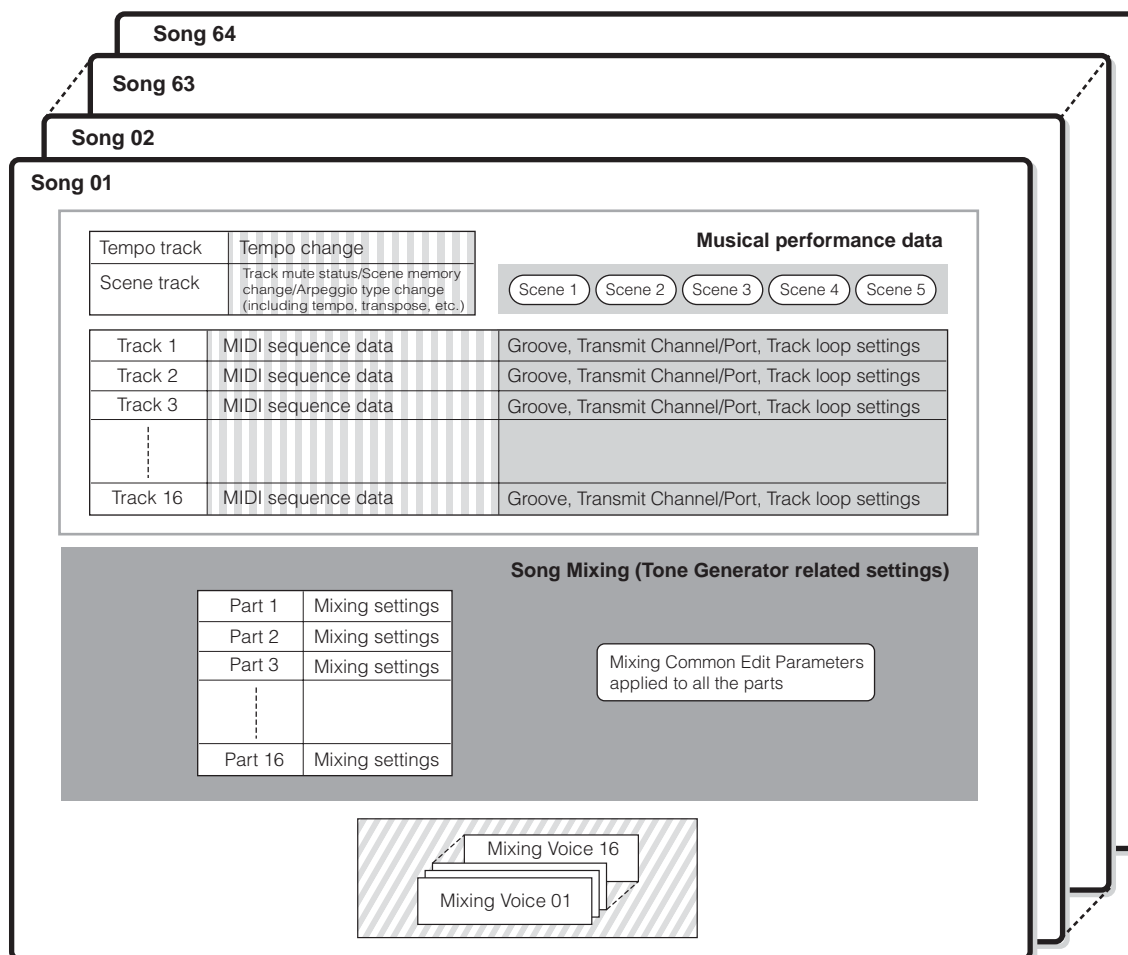

- Set in the Song Play mode
- Created in the Song Record mode, Song Edit mode, and Song Job mode
- Set in the Song Mixing mode and Song Mixing Edit mode
- Created in the Mixing Voice Edit mode

● **Song Mixing**

Even if you record your keyboard performance to a Song track, the setup data (non-note events such as voice, pan, volume) which for proper playback should be recorded at the top of the Song will not be recorded to it. For this reason, the setup data handled as Song Mixing settings should be stored in the Song Mixing Store mode.

Because the Song Mixing is a collection of settings related to the tone generator, it can be applied to the sequence data transmitted from the external MIDI sequencer as well as this synthesizer's Song playback.

● **Scene**

A Song Scene is a "snapshot" of important settings, and contains parameter settings such as transpose, tempo, and track mute and the tone generator related parameters controllable from the Knobs with the [PAN/SEND] or [TONE] lamp turned on, and the Control sliders. Five settings can be registered to the [SF1] – [SF5] buttons for each Song.

● **Song Chain**

This function allows Songs to be "chained" together for automatic sequential playback. The Song Chain can be created and played back from the [SONG] → [F6] CHAIN display. This instrument allows you to create one Song Chain data.

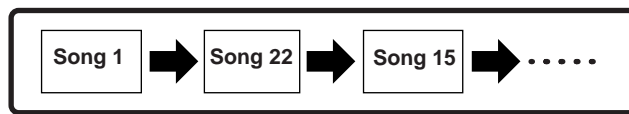

■ **Pattern data structure**

The following illustration shows the track structure of a Pattern. Patterns are created by recording MIDI sequence data to individual tracks, by assigning Phrases (Preset and User) which comprise the material for a Pattern to individual tracks, and by setting tone generator related parameters (in a Pattern Mixing).

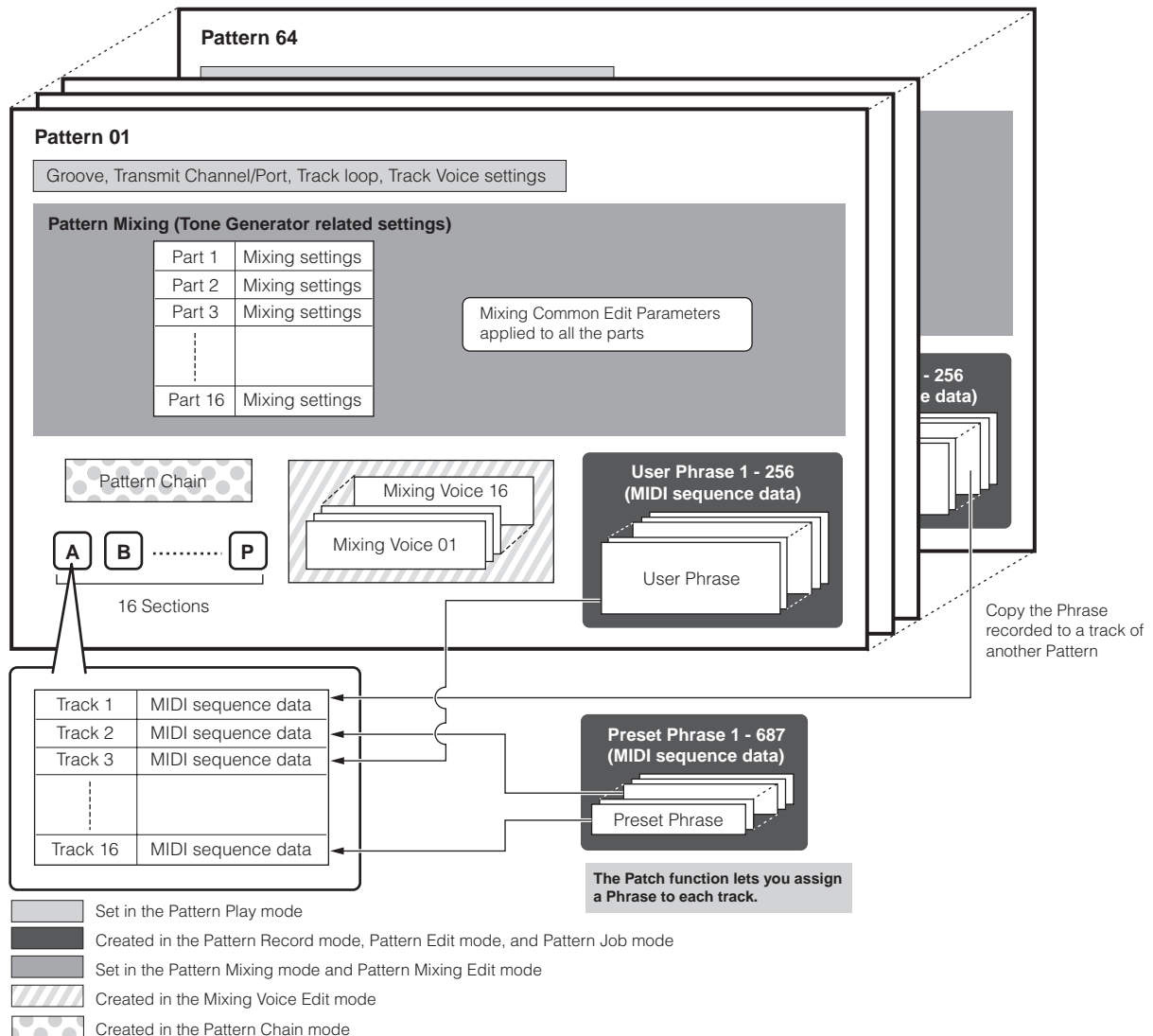

● **Pattern Mixing**

Even if you record your keyboard performance to a Pattern track, the setup data (non-note events such as voice, pan, volume) which for proper playback should be recorded at the top of the Pattern will not be recorded to it. For this reason, the setup data handled as Pattern Mixing settings should be stored in the Pattern Mixing Store mode. Unlike the Song, only the voice number is recorded to a track as a Track Voice (Phrase Voice) which is used for playback normally. Because the Pattern Mixing is a collection of settings related to the tone generator, it can be applied to the sequence data transmitted from the external MIDI sequencer as well as this synthesizer's Pattern playback.

● **Section**

A Pattern consists of one or more "Sections" (Pattern variations). You can play the Pattern by specifying a Section after selecting a Pattern.

● **Phrase**

This is the basic MIDI sequence data—and the smallest unit—used in creating a Pattern. "Phrase" is a short musical/ rhythmic passage for a single instrument, such as a rhythm pattern for the rhythm part, a bass line for the bass part, or a chord backing for the guitar part. This synthesizer features 687 Preset Phrases, and contains memory space for 256 of your own original User Phrases.

● **Pattern Chain**

Pattern Chain allows you to string several different Sections (within a single Pattern) together to make a single Song. You can have the synthesizer automatically change Sections by creating Pattern Chains in this way beforehand.

You can create the Pattern Chain by recording a Pattern playback with Section changes from the [PATTERN] → [F6] CHAIN display or by editing the timing of Section changes from the [PATTERN] → [F6] CHAIN → [EDIT] display. The created Pattern Chain can be played back when calling up the [PATTERN] → [F6] CHAIN display.

You can also use them when creating Songs based on a certain Pattern, since the created Pattern Chain can be converted into a Song from the [PATTERN] → [F6] CHAIN → [EDIT] → [F3] SONG display. This synthesizer lets you create one Pattern Chain for each Pattern.

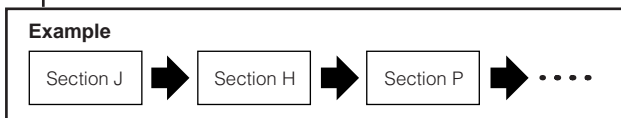
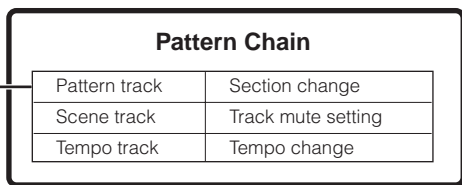

■ **MIDI tracks**

MIDI tracks are created by recording your keyboard performance in the Song Record mode/Pattern Record mode.

● **MIDI track recording method**

[SONG] or [PATTERN] → [REC] (Record) → [F1] SETUP → Type

The following explanations are important points for you to keep in mind as you record your User Songs/Patterns. The recording methods explained here should be set from the Setup display in the Song Record mode/Pattern Record mode before recording.

● **Realtime recording and Step recording**

Realtime recording

With realtime recording, the instrument functions in the same way as a tape recorder, recording the performance data as it is played. This allows you to capture all the nuances of an actual performance. This method is used for the Recording types explained below, such as Replace, Overdub, Loop, and Punch In/Out.

Step recording (Type = step)

With step recording, you can compose your performance by "writing" it down one event at a time. This is a non-realtime, step recording method—similar to writing music notation onto paper.

● **Replace and Overdub (Song/Pattern)**

Replace

You can use this method when you want to overwrite an already recorded track with new data. The first recording is lost, and the new one takes its place.

Overdub

You can use this method when you want to add more data to a track that already contains data. The first recording is kept, and the new one is added. This method lets you build up a complex phrase together with Loop recording (below).

● Loop Recording (Pattern)

[PATTERN] → [REC] (Record) → [F1] SETUP → loop = on

Pattern repeats the rhythm pattern of several measures (1 to 256 measures) in a “loop,” and its recording is also done using loops. This method is used when recording a Pattern Phrase using the Overdub method (above). As shown in the example below, notes that you record will play back from the next repetition (loop), letting you record while hearing previously recorded material.

When recording a rhythm of Bass Drum, Snare Drum, Hi-Hat cymbal in order:

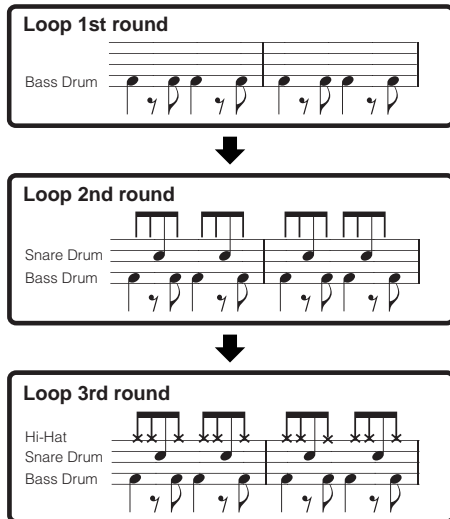

NOTE Loop Recording can only be used with Realtime recording.

● Punch In/Out (Song)

You can use this method when you want to re-record only over a specific area of the track. You'll need to set the start and end points before re-recording.

In the eight-measure example below, the third measures through the fifth measure are re-recorded.

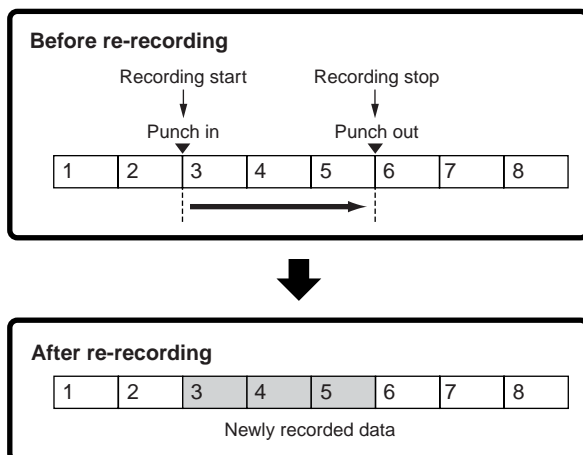

NOTE Punch In/Out Recording can only be used with Realtime recording.

NOTE Note that the Punch In/Out method always replaces (destroys) the original data over the specified area.

Effect Block

This block applies effects to the output of the tone generator block, processing and enhancing the sound using sophisticated DSP (digital signal processing) technology.

Effect structure

The effect processing of this synthesizer features the System Effects, Insertion Effects, Master Effect, Part EQ (Equalizer), and Master EQ (Equalizer).

■ System Effects (Reverb, Chorus)

System Effects are applied to the overall sound, whether it be a Voice, Performance, Song, and Pattern.

With System effects, the sound of each Part is sent to the effect according to the effect Send Level for each Part. The processed sound (referred to as “wet”) is sent back to the mixer, according to the Return Level, and output—after being mixed with the unprocessed “dry” sound. This arrangement lets you prepare an optimum balance of the effect sound and the original sound of the Parts.

Reverb

The Reverb effects add a warm ambience to the sound, simulating the complex reflections of actual performance spaces, such as a concert hall or a small club. A total of 20 different Reverb types are available.

Chorus

The Chorus effects use various types of modulation processing, including flanger and phaser, to enhance the sound in a variety of ways. A total of 49 types are available, including reverb and delay effects.

■ Insertion Effects A, B

Insertion effects can be applied individually to each part. Insertion effects are mainly used to directly process a single part. The depth of the effect is adjusted by setting the dry/wet balance. Since an Insertion effect can only be applied to one particular part, it should be used for sounds you want to drastically change or for sounds that use an effect unintended for other sounds. You can also set the balance so that only the effect sound is heard, by setting Wet to 100%.

This synthesizer features three sets of Insertion effects (one set has A and B units). They can be applied to three Parts (maximum) of the Performance, Song, and Pattern.

A total of 116 different Chorus types are available.

NOTE In the Voice mode, only one set of the Insertion effects is available.

■ Master Effect

This block applies effects to the final stereo output signal of the entire sound. A total of 8 different Master Effect types are available.

Bypassing the Effects (Effect Off)

You can bypass the Master Effect by turning on the [MASTER EFFECT] button with a single touch. The System Effect(s) or Insertion Effect(s) can be bypassed by turning on the [EFFECT BYPASS] button.

NOTE From the following display, you can select the specific effect(s) to be bypassed with the [EFFECT BYPASS] button.
[UTILITY] → [F1] GENERAL → [SF3] EF BYPS

Controlling the Master effect by using the Knobs

When pressing the [ARP FX] button and the [EQ] button simultaneously (both lamps light), you can control the knobs to adjust the Master effect related parameters specified in the [UTILITY] → [F4] CTL ASN → [SF5] MEF display of the Utility mode.

Equalizer (EQ)

Usually an equalizer is used to correct the sound output from amps or speakers to match the special character of the room, or to change the tonal character of the sound. The sound is divided into several frequency bands, and adjustments are made to the sound by raising or lowering the level of each band.

By adjusting the sound according to the genre—classical music being more refined, pop music more crisp, and rock music more dynamic—you can draw out the special characteristics of the music and make your performance more enjoyable.

Three separate EQ sections are available on the instrument: Element EQ, Part EQ, and Master EQ.

Element EQ

[VOICE] → Voice selection → [EDIT] → Element selection/Key selection → [F6] EQ

The Element EQ is applied to each element of the Normal Voice and each key of the Drum Voice. You can specify which shape is used among the two shapes described below and set the related parameters.

Peaking type

This type of EQ shape lets you attenuate/boost the signal at the specified Frequency setting.

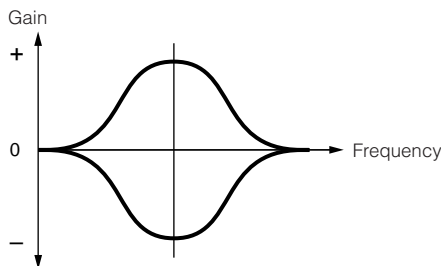

Shelving type

This type of EQ shape lets you attenuate/boost the signal at frequencies above or below the specified Frequency setting.

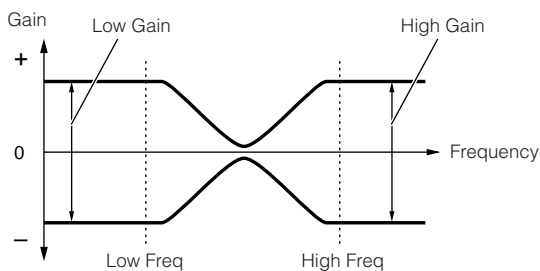

NOTE In addition to the individual gain controls, there is also an overall level parameter that attenuates/boosts the entire frequency range.

Part EQ

[PERFORM] → Performance selection → [EDIT] → Part selection → [F3] EQ

[SONG]/[PATTERN] → Song/Pattern selection → [MIXING] → [EDIT] → Part selection → [F3] EQ

This 3-band EQ is applied to each part of the Performance/Song/Pattern. The high band and low band are the shelving type. The middle band is the peaking type.

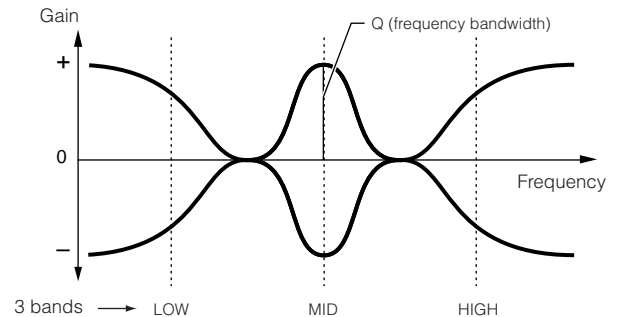

NOTE The part EQ is not available in the Voice mode.

Master EQ

[VOICE] → Voice selection → [UTILITY] → [F3] VOICE → [SF1] MEQ

[PERFORM] → Performance selection → [EDIT] → [COMMON] → [F2] OUT/MEF → [SF2] MEQ

[SONG]/[PATTERN] → Song/Pattern selection → [MIXING] → [EDIT] → [COMMON] → [F2] MEQ/MEF → [SF1] MEQ

Master EQ is applied to the final (post-effect), overall sound of the instrument. In this EQ, all bands can be set to peaking, or the lowest and highest bands can be set to shelving (as shown below).

EQ for which all bands are set to peaking type

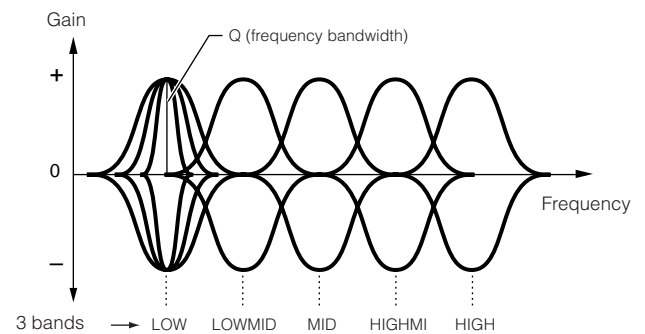

EQ for which LOW and HIGH are set to shelving type

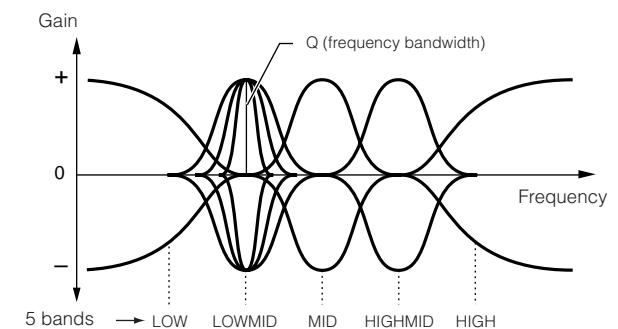

Effect connection in each mode

● In the Voice mode

The Effect parameters in the Voice mode are set for each Voice and the settings are stored as a User Voice. Note that the Master Effect and Master EQ parameters are set for all the Voices in the Utility mode. Once the Master Effect and EQ settings have been made, they can be stored as System settings by pressing the [STORE] button.

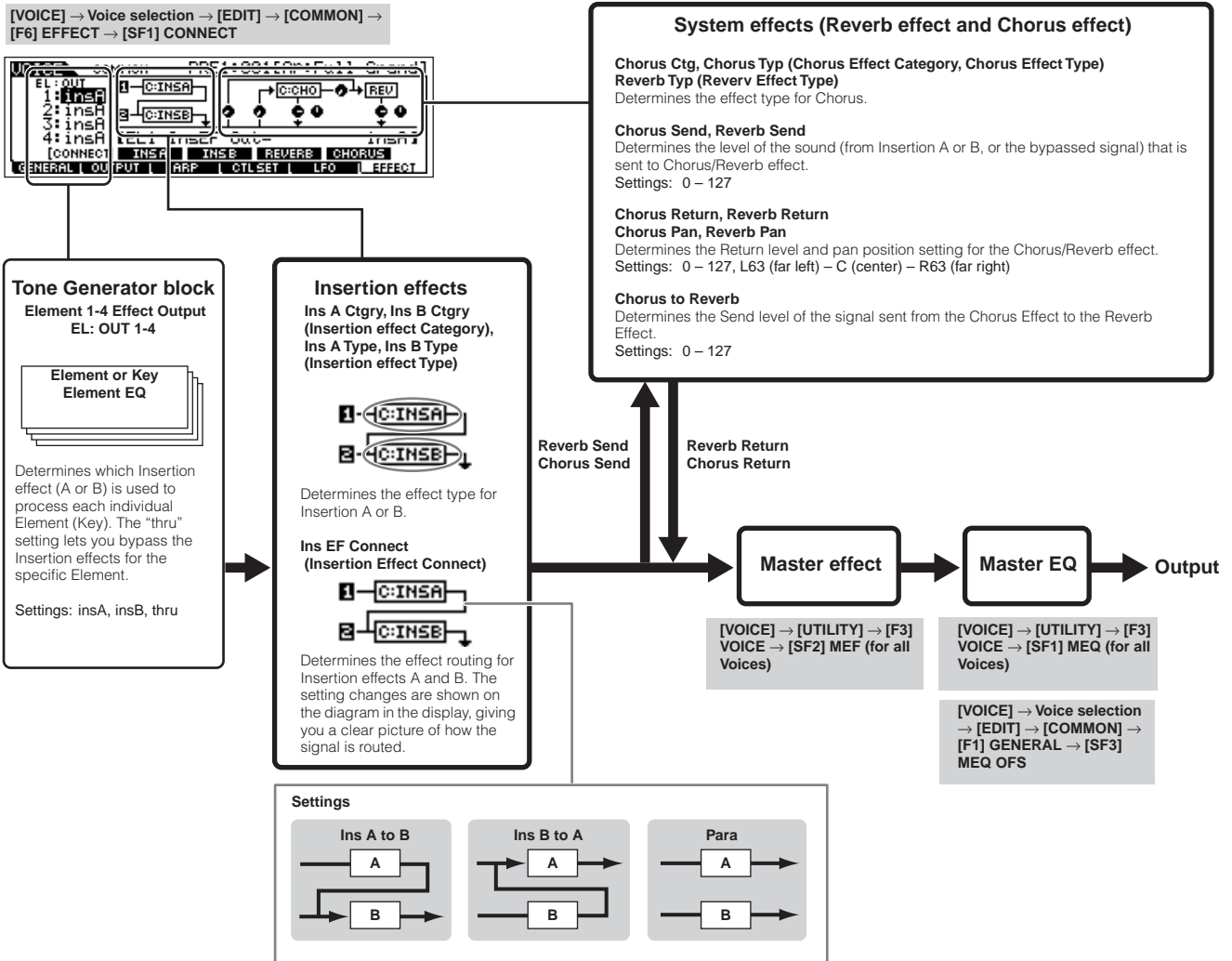

Basic Structure

● In the Performance mode

The Effect parameters in the Performance mode are set for each Performance.

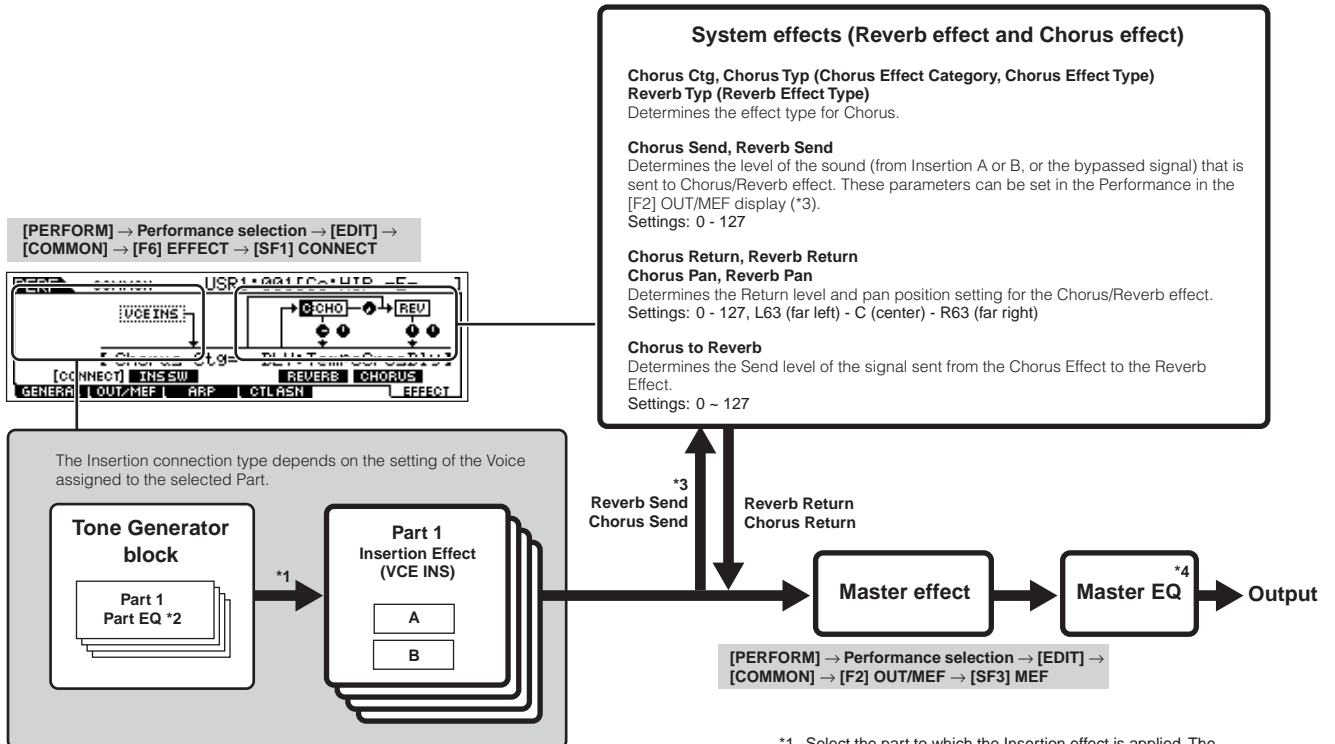

*1 Select the part to which the Insertion effect is applied. The Insertion effect depends on the setting of the Voice assigned to the selected part.
[PERFORM] → Performance selection → [EDIT] → [COMMON] → [F6] EFFECT → [SF2] INS SW

*2 [PERFORM] → Performance selection → [EDIT] → Part selection → [F3] EQ

*3 [PERFORM] → Performance selection → [EDIT] → [COMMON] → [F2] OUT/MEF → [SF1] OUT

*4 [PERFORM] → Performance selection → [EDIT] → [COMMON] → [F2] OUT/MEF → [SF2] MEQ

[PERFORM] → Performance selection → [EDIT] → [COMMON] → [F1] GENERAL → [SF3] MEQ OFS

● In the Song/Pattern mode

The Effect parameters in the Song/Pattern mode are set for each Song/Pattern.

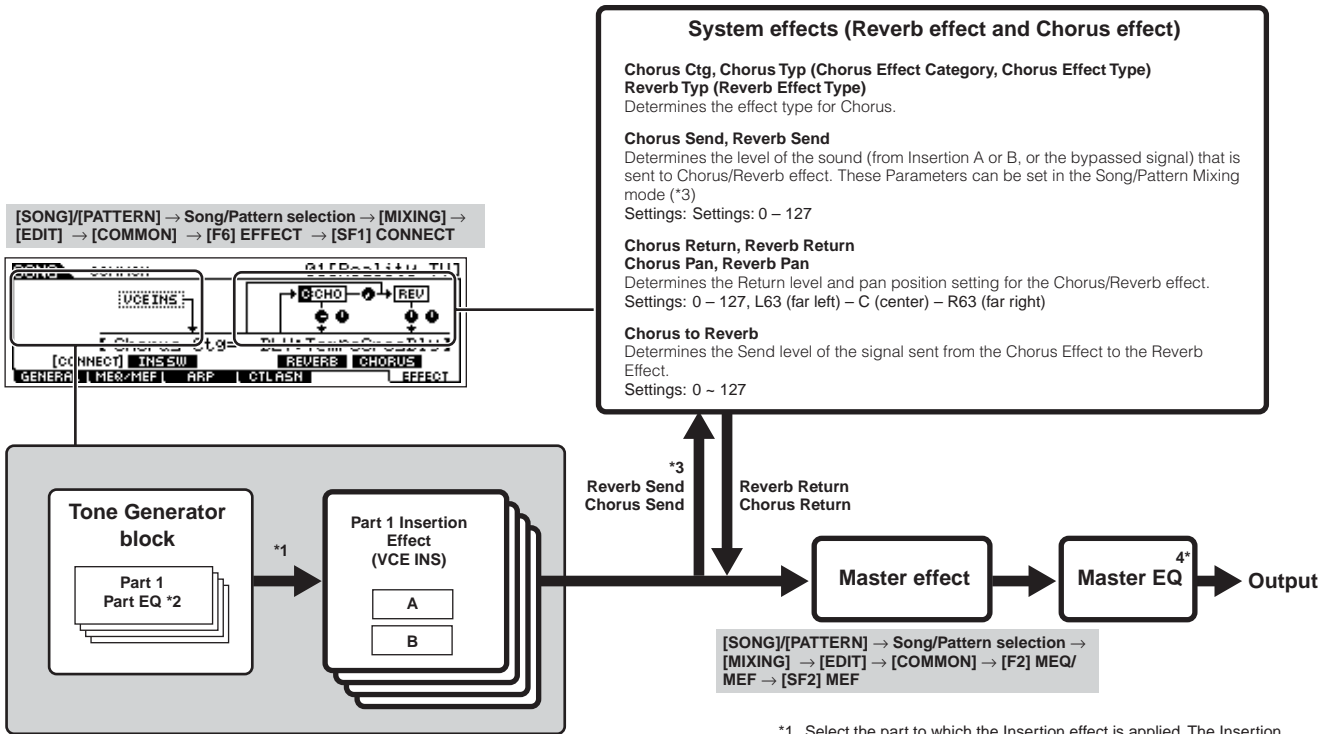

- *1 Select the part to which the Insertion effect is applied. The Insertion effect depends on the setting of the Voice assigned to the selected part.
 [SONG]/[PATTERN] → Song/Pattern selection → [MIXING] → [EDIT] → [COMMON] → [F6] EFFECT → [SF2] INS SW
- *2 [SONG]/[PATTERN] → Song/Pattern selection → [MIXING] → [EDIT] → Part selection → [F3] EQ
- *3 [SONG]/[PATTERN] → Song/Pattern selection → [MIXING] → [EDIT] → [COMMON] → [F4] EF SEND
- *4 [SONG]/[PATTERN] → Song/Pattern selection → [MIXING] → [EDIT] → [COMMON] → [F2] MEQ/MEF → [SF2] MEQ

Basic Structure

Arpeggio

This function lets you automatically trigger musical and rhythmic phrases using the current Voice by simply pressing a note or notes on the keyboard. The Arpeggio sequence also changes in response to the actual notes or chords you play, giving you a wide variety of inspiring musical phrases and ideas—both in composing and performing.

NOTE A single Arpeggio type can be played back at the same time even in the Performance, Song, and Pattern mode, enabling you to play multiple tone generator's parts simultaneously.

■ Category of the Arpeggio type

The Arpeggio types are divided into 18 categories as listed below.

LCD	Category Name	Description
Seq	Synth Sequence	Various arpeggio phrases suited for synth voices.
ChSq	Synth Chord Sequence	Various rhythmic chord phrases or synth voices.
HySq	Synth Hybrid Sequence	Various arpeggio types programmed so that bass phrases are played with the lower keys and chords or melodies are played with the midrange and higher keys. These arpeggio types are useful for split voice combinations. In addition, there are also Hybrid Velocity ("HybVel...") types that feature different phrases for different velocity ranges, letting you change the arpeggio phrase depending on how strongly you play the keyboard.
APKb	Acoustic Piano & Keyboard	Various arpeggio types suited for piano and other keyboard voices, such as electric piano and clav.
Orgn	Organ	Various arpeggio types suited for organ voices.
GtPl	Guitar & Plucked	Various arpeggio types suited for guitar and harp voices.
GtKM	Guitar—Keyboard Mega Voice	Various arpeggio types suited for guitar Keyboard Mega voices (see note below).
Bass	Bass	Various arpeggio types suited for bass or synth bass voices.
BaKM	Bass—Keyboard Mega Voice	Various arpeggio types suited for bass Keyboard Mega voices (see note below).
Strn	Strings	Various arpeggio types suited for strings and pizzicato voices.
Bras	Brass	Various arpeggio types suited for brass voices.
RdPp	Reed & Pipe	Various arpeggio types suited for saxophone and flute voices.
Lead	Synth Lead	Various arpeggio types suited for synth lead voices.
PdMe	Synth Pad & Musical FX	Various arpeggio types suited for synth pad voices and special musical effects voices, including percussive sounds.
CPrc	Chromatic Percussion	Various arpeggio types suited for chromatic percussion voices.
DrPc	Drum & Percussion	Various arpeggio types suited for drum and percussion voices (drum kits).
Comb	Combination	Various arpeggio types suited for Performances. These are combination arpeggios, with separate phrases suitable for drum voices, bass voices, and chord/melody instruments.
Cntr	Control	Various arpeggio types programmed primarily with Control Change and Pitch Bend data. These arpeggio types change the tone or pitch of the sound, rather than play specific notes. In fact, some types contain no note data at all. When using a type of this category, set the KeyMode parameter to "direct" in each mode.

■ Arpeggio playback types

The MO features a total of 1787 Arpeggio types divided into 18 categories, each with its own playback type designed for use with particular types of Voices, as described below.

● Arpeggios for Normal Voices

Arpeggio types (belonging to the categories except for the DrPC and Cntr) created for use of Normal Voices have the following two playback types.

Playback only of the played notes	The Arpeggio is played back using only the played note and its octave notes.
Playback of a programmed sequence according to the played chord	These Arpeggio types have the several sequences each of which is suited for a certain chord type. Even if you press only one note, the Arpeggio is played back using the programmed sequence—meaning that notes other than the ones you play may be sounded. Adding notes to those already held changes the sequence accordingly—in other words, the arpeggio plays back according to the chord you play.

NOTE The two playback types above are not distinguished by the category name or type name. You'll have to actually play the types and hear the difference.

NOTE Since these types are programmed for Normal Voices, using them with Drum Voices may not give musically appropriate results.

● Arpeggios for Drum/Percussion Voices—Category: DrPc

These arpeggio types are programmed specifically for use with Drum Voices, giving you instant access to various rhythm patterns. Three different playback types are available.

Playback of a drum pattern	Pressing any note(s) will trigger the same rhythm pattern.
Playback of a drum pattern, plus additional played notes (assigned drum instruments)	Pressing any note will trigger the same rhythm pattern. Adding notes to the one already held produces additional sounds (assigned drum instruments) for the drum pattern.
Playback only of the played notes (assigned drum instruments)	Playing a note or notes will trigger a rhythm pattern using only the notes played (assigned drum instruments). Keep in mind that even if you play the same notes, the triggered rhythm pattern differs depending on the order of the notes played. This gives you access to different rhythm patterns using the same instruments simply by changing the order in which you play the notes.

NOTE The three playback types above are not distinguished by the category name or type name. You'll have to actually play the types and hear the difference.

NOTE Since these types are programmed for Drum Voices, using them with Normal Voices may not give musically appropriate results.

● Arpeggios for Performances—Category: Comb

The Arpeggio types belonging to the category “Comb” are programmed so that different arpeggios are triggered—an arpeggio for a Normal Voice and an arpeggio for a Drum Voice—depending on the played note. These types are useful in the Performance mode in which multiple voices (Drum Voice and Normal Voice) are combined in a layer since these types enable you trigger the arpeggio for the Normal Voice and the Drum Voice at the same time.

● Arpeggios containing mainly non-note events—Category: Cntr

These arpeggio types are programmed primarily with Control Change and Pitch Bend data. They are used to change the tone or pitch of the sound, rather than play specific notes. In fact, some types contain no note data at all. When using a type of this category, set the KeyMode parameter to “direct” with the following operations.

Voice mode	[VOICE] → Voice selection → [EDIT] → [COMMON] → [F3] ARP → [SF1] TYPE → KeyMode
Performance	[PERFORM] → Performance selection → [EDIT] → [COMMON] → [F3] ARP → [SF1] TYPE → KeyMode
Song mode	[SONG] → Song selection → [MIXING] → [EDIT] → [COMMON] → [F3] ARP → [SF1] TYPE → KeyMode
Pattern mode	[PATTERN] → Pattern selection → [MIXING] → [EDIT] → [COMMON] → [F3] ARP → [SF1] TYPE → KeyMode

■ Arpeggio related parameters

The Arpeggio related parameters can be set from the following displays, depending on the selected mode.

● Voice mode

Arpeggio type parameters called up when selecting a Voice	[VOICE] → Voice selection → [F6] ARP	Page 152
	[VOICE] → Voice selection → [EDIT] → [COMMON] → [F3] ARP	Page 154
Assigning Arpeggio types to the [SF1] – [SF5] buttons for each Voice	[VOICE] → Voice selection → [F1] PLAY	Page 151
MIDI output parameters for Arpeggio playback for all the Voices	[VOICE] → [UTILITY] → [F3] VOICE → [SF3] ARP CH	Page 206

NOTE MIDI output parameters for Arpeggio playback are set for each Voice in the Voice mode. In the other modes, however, they can be set for each Performance, Song, and Pattern.

● Performance mode

Arpeggio type parameters called up when selecting a Performance (including MIDI output parameters for Arpeggio playback)	[PERFORM] → Performance selection → [F6] ARP	Page 171
	[PERFORM] → Performance selection → [EDIT] → [COMMON] → [F3] ARP	Page 173
Assigning Arpeggio types to the [SF1] – [SF5] buttons for each Performance	[PERFORM] → Performance selection → [F1] PLAY	Page 171

● Song mode

Parameters related to the Arpeggio type called up when selecting a Song (including MIDI output parameters for Arpeggio playback)	[SONG] → Song selection → [MIXING] → [EDIT] → [COMMON] → [F3] ARP	Page 190
Assigning Arpeggio types to the [SF1] – [SF5] buttons for each Song	[SONG] → Song selection → [F1] PLAY	Page 178
	[SONG] → Song selection → [RED] (Record) → [F3] ARP	Page 180
Arpeggio type parameters in recording	[SONG] → Song selection → [REC] (Record) → [F4] REC ARP	Page 180

NOTE Arpeggio related parameters in the Song mode belong to the Mixing. Therefore, if desired, store them to internal memory (DRAM) in the Song Mixing Store mode and save them to the USB storage device as Song data in the File mode.

● Pattern mode

Parameters related to the Arpeggio type called up when selecting a Pattern (including MIDI output parameters for Arpeggio playback)	[PATTERN] → Pattern selection → [MIXING] → [EDIT] → [COMMON] → [F3] ARP	Page 202
Assigning Arpeggio types to the [SF1] – [SF5] buttons for each Pattern	[PATTERN] → Pattern selection → [F1] Play	Page 196
	[PATTERN] → Pattern selection → [REC] (Record) → [F3] ARP	Page 198
Arpeggio type parameters in recording	[PATTERN] → Pattern selection → [REC] (Record) → [F4] REC ARP	Page 198

NOTE Arpeggio related parameters in the Pattern mode belong to the Mixing. Therefore, if desired, store them to internal memory (DRAM) in the Pattern Mixing Store mode and save them to the USB storage device as Pattern data in the File mode.

Internal Memory and File Management

As you use the MO, you'll create many different kinds of data, including Voices, Performances, Songs, and Patterns. This section describes how to maintain the various types of data and use the memory devices/media for storing them.

Maintaining data

You can maintain the data you've created via the following three methods.

● Store

This is a process of transferring or saving the created data of this synthesizer to a dedicated location (User Memory) in the internal memory. Each type of data can be stored with the following operations.

Voice	[VOICE] → Voice selection → [STORE]	Page 168
Performance	[PERFORM] → Performance selection → [STORE]	Page 177
Song Mixing	[SONG] → Song selection → [MIXING] → [STORE]	Page 192
Pattern Mixing	[PATTERN] → Pattern selection → [MIXING] → [STORE]	Page 202
Mixing Voice	[SONG] or [PATTERN] → Song/Pattern selection → [MIXING] → [F5] VCE ED → [STORE]	Page 204
Master	[MASTER] → Master selection → [STORE]	Page 218
System settings	[UTILITY] → [STORE] *	Page 205

* Please note that pressing the [STORE] in the Utility mode starts the Store operation of the System settings immediately.

⚠ CAUTION

Since Song Mixing, Pattern Mixing, and Mixing Voice data is stored to DRAM (page 150), all such data is lost when turning off the power—even if the data has been stored with the operations above. Make sure to save this data to the USB storage device in the File mode after storing.

⚠ CAUTION

Never attempt to turn off the power while data (e.g., Voice) is being written to Flash ROM (while an "Executing..." or "Please keep power on" message is shown). Turning the power off in this state may cause the system to freeze (due to corruption of data in the Flash ROM) and prevent normal startup the next time the power is turned on, as well as resulting in the loss of all user data.

● Save

[FILE] → [F2] SAVE

This is a process of transferring or saving the created data of this synthesizer to an external memory device (USB storage device). This process can be done in the File mode. The Save operation can be done via various methods, such as saving all data as a single file or saving a specified type of data (e.g., only Voices) as a single file. For details, see Memory Structure (page 149) and Reference (page 211). The saved data as files can be recalled by loading them in the File mode.

● Bulk Dump

This function lets you save the data in the Edit buffer (DRAM) or Flash ROM by transmitting it as Bulk data (system exclusive message) to an external MIDI instrument or sequence software on a computer. This can be done with the following operations.

Voice	[VOICE] → Voice selection → [JOB] → [F4] BULK
Performance	[PERFORM] → Performance selection → [JOB] → [F4] BULK
Song Mixing	[SONG] → Song selection → [MIXING] → [JOB] → [F4] BULK
Pattern Mixing	[PATTERN] → Pattern selection → [MIXING] → [JOB] → [F4] BULK
Master	[MASTER] → Master selection → [JOB] → [F4] BULK

NOTE Mixing Voice data cannot be transmitted as Bulk data via panel operations.

NOTE User Arpeggio data and some of the System settings are not handled as Bulk data.

NOTE The data in the User Memory of Flash ROM can be transmitted to an external MIDI instrument or computer upon reception of a bulk request message. For details about the bulk request message and bulk dump format, see the separate Data List.

Using the Voice Editor and Multi Part Editor

Voice data can be transmitted to a computer for editing with the Voice Editor software (page 112). The edited Voice on the instrument itself data can then be transmitted back to the instrument in banks as bulk data. Similarly, Voice data created in the Voice Edit mode can be sent to the computer in banks as bulk data.

Mixing data can also be transmitted to a computer for editing, using the Multi Part Editor software (page 112). The edited Mixing data can then be transmitted back to the instrument as bulk data. Mixing data created in the Mixing Edit mode on the instrument itself can also be sent to the computer in banks as bulk data.

Memory Structure

This diagram details the relationship among the functions of the MO and the internal memory and USB storage device.

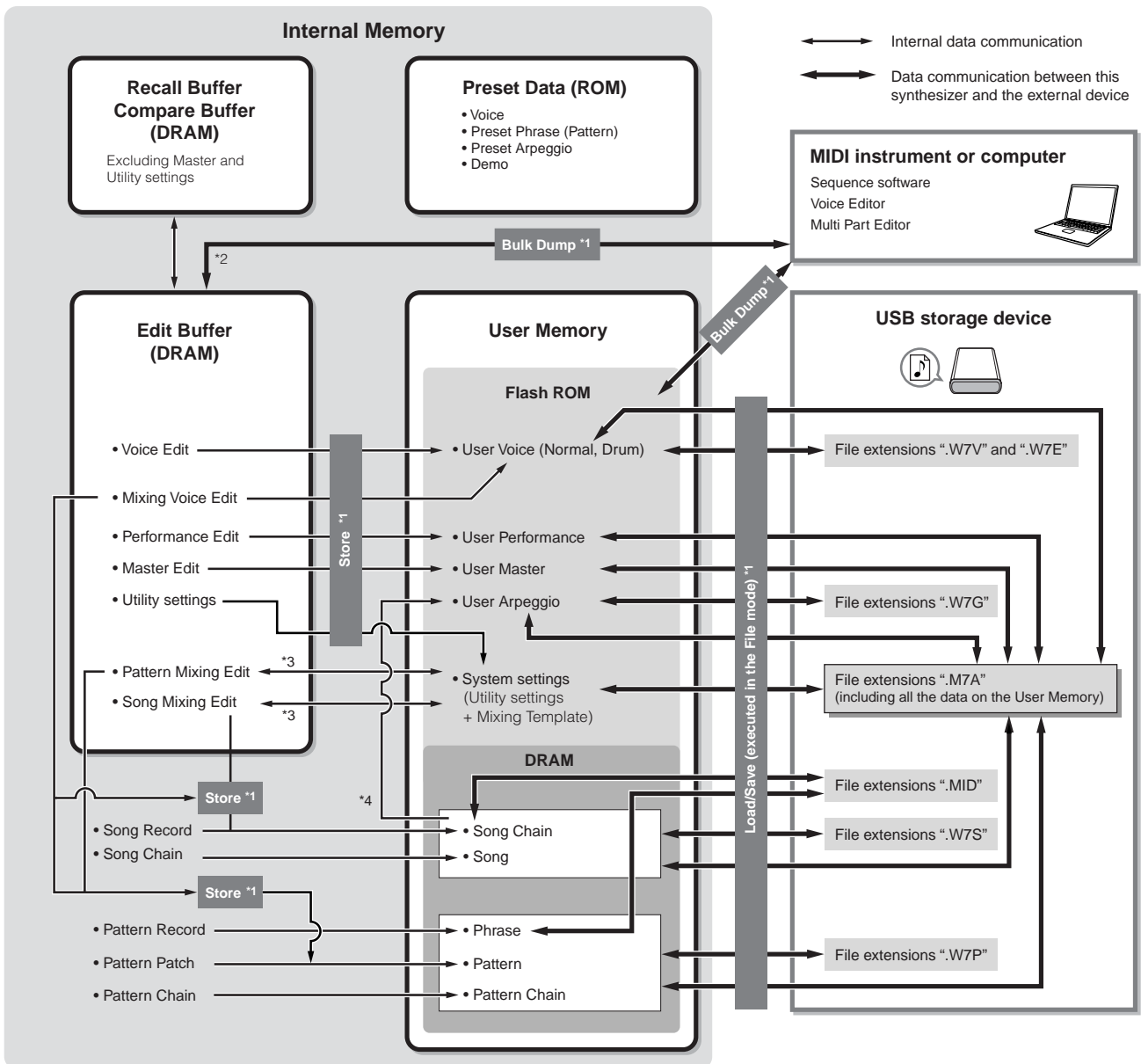

*1 For details on the Bulk Dump, Save, and Store operations, see page 148.

*2 Only the currently edited data can be transmitted as Bulk data. Note that the Mixing Voice cannot be transmitted as Bulk data.

*3 The Mixing settings can be stored/recalled as a template in the Song Mixing Job mode/Pattern Mixing Job mode.

*4 You can convert the MIDI sequence data recorded in the Song Record mode/Pattern Record mode to Arpeggio data. This can be executed with the following operations:

- [SONG] → [JOB] → [F5] TRACK → 07: Put Track to Arp
- [PATTERN] → [JOB] → [F5] TRACK → 06: Track to Arp

Internal Memory

Below are explanations of the basic terms used in the Memory Structure illustration on the previous page.

● Flash ROM

ROM (Read Only Memory) is memory designed specifically for reading out of data, and as such data cannot be written to it. Unlike conventional ROM, Flash ROM can be overwritten – allowing you to store your own original data. The contents of Flash ROM are maintained even when the power is turned off.

● DRAM

RAM (Random Access Memory) is memory designed specifically for data writing and data reading operations. There are two different kinds of RAM, depending on the condition for storing the data: SRAM (Static RAM) and DRAM (Dynamic RAM). The created data stored on DRAM is lost when the power is turned off. Because of this, you should always store any data residing in DRAM to the USB storage device before turning off the power.

● Edit Buffer and User Memory

The edit buffer is the memory location for edited data of these types: Voice, Performance, Master, Song Mixing, and Pattern Mixing. Data edited in this location will be stored to the User Memory.

If you select another Voice, Performance, Master, Song, or Pattern, the entire contents of the edit buffer will be rewritten with the newly selected Voice/Performance/Master/Song Mixing/Pattern Mixing data. Make sure to store any important data before selecting another Voice, etc.

● Edit Buffer and Recall Buffer

If you've selected another Voice/Performance/Song/Pattern without storing the one you were editing, you can recall your original edits, since the edit buffer's contents are stored in backup memory.

NOTE Keep in mind that the recall buffer is not available in the Master Edit mode.

Reference

Voice mode

Voice Play mode

[VOICE] → Voice selection

The Voice Play mode lets you perform a variety of general editing operations on the selected Voice. For more detailed and comprehensive editing operations, use the Voice Edit mode. Edited parameters with the exception of some parameters are stored to internal Flash ROM as a User Voice.

NOTE In the Voice Play mode and Voice Edit mode, you can set the parameters for each Voice. The parameters for all the Voices such as Master EQ and Master Effect can be set from the [UTILITY] → [F3] VOICE display in the Utility mode.

NOTE The parameters that have the same name in the Voice Play mode and in the Voice Edit mode have the same functions and settings.

[F1] PLAY

TCH (Transmit Channel)	Indicates the Keyboard MIDI transmit channel. You can change the Keyboard MIDI transmit channel by pressing the [TRACK SELECT] button so that its indicator lights and pressing any of the Number [1] – [16] buttons. The Keyboard MIDI transmit channel can be changed also with the following operation: [UTILITY] → [F5] MIDI → [SF1] CH → KBDTransCh.
OCT (Octave)	Indicates the Keyboard Octave setting. This can be changed with the following operation: [UTILITY] → [F1] GENERAL → [SF2] KBD → Octave.
ASA (ASSIGN A), ASB (ASSIGN B)	Indicates the functions assigned to the respective Knobs (printed "ASSIGN A" and "ASSIGN B") when the lamps of both the [PAN/SEND] and [TONE] buttons are turned on. The functions are assigned with the following operation: [UTILITY] → [F4] CTL ASN → [SF2] ASSIGN.
NOTE TCH (Transmit Channel), OCT (Octave), ASA (ASSIGN A), and ASB (ASSIGN B) settings do not belong to each Voice. Because of this, these are not stored as an individual Voice in the Voice Store mode (page 168).	
AS1 (ASSIGN 1), AS2 (ASSIGN 2)	Indicates the functions assigned to the respective Knobs (printed "ASSIGN 1" and "ASSIGN 2") when the lamps of both the [PAN/SEND] and [TONE] buttons are turned on. The functions are assigned by setting the Voice Edit common parameters with the following operation: [VOICE] → [EDIT] → [COMMON] → [F4] CTL SET.
[SF1] ARP1 (Arpeggio 1) – [SF5] ARP5 (Arpeggio 5)	You can register the desired Arpeggio types to these buttons and call them up any time during your keyboard performance. For details, see page 48.

[F3] EFFECT

Pressing the [F3] EFFECT button in the Voice Play mode calls up the same EFFECT display in the Voice Edit mode ([VOICE] → [EDIT] → [COMMON] → [F6] EFFECT). From this display, you can set the effect related parameters for the current Voice. For details, see page 158.

[F4] PORTA (Portamento)

From this display you can select monophonic or polyphonic playback and set the Portamento parameters. Portamento is used to create a smooth transition in pitch from the first note played on the keyboard to the next.

Mono/Poly	Determines whether the Voice is played back monophonically (single notes only) or polyphonically (multiple simultaneous notes). Settings: mono, poly NOTE When pressing the second note while holding the first note with the PortaSw set to on and the Mono/Poly set to on, the second note sound starts succeeding the transition of the first note, or the second note starts not from the EG (AEG/PEG/FEG) start point but from the EG (AEG/PEG/FEG) point the first note reaches. This realizes the legato performance. This legato degree can be set with the following operation: [VOICE] → [EDIT] → [COMMON] → [F1] GENERAL → [SF4] PORTA → LegatoSlope (page 153).
PortaSw (Portamento Switch)	Determines whether Portamento is applied to the current Voice or not. Settings: off, on
PortaTime (Portamento Time)	Determines the pitch transition time. Higher values result in longer transition times. Settings: 0 – 127
PortaMode (Portamento Mode)	Determines the Portamento mode. The behavior of the Portamento varies depending on whether Mono/Poly is set to "mono" or "poly." Settings: fingered, fulltime fingered Portamento is only applied when you play legato (playing the next note before releasing the previous one). fulltime Portamento is always applied.

Voice mode

Performance mode

Song mode

Pattern mode

Mixing Voice mode

Utility mode

File mode

Master mode

Reference

[F5] EG (Envelope Generator)

This display contains the basic EG settings, both volume and filter, for the Voice, as well as the filter's cutoff frequency and resonance settings. The settings made here are applied as offsets to the AEG and FEG settings in the Voice Edit mode. The full names of the available parameters are shown in the chart below, as they appear in the display.

	ATK	DCY	SUS	REL	DEPTH	CUTOFF	RESO
AEG	Attack time	Decay time	Sustain level	Release time	---	---	---
FEG			---		Depth	Cutoff frequency	Resonance

Settings: -64 – 0 – +63 (except --- above)

[F6] ARP (Arpeggio)

This display contains the basic settings for Arpeggio playback, including Type and Tempo. About the [SF1] – [SF5] buttons, see the explanation of the [F1] PLAY display.

Bank, Ctgr (Category), Type	These three parameters determine the Arpeggio Type. The three-letter prefix number before the Type name indicates the number within the selected Category. Settings: Refer to the separate Data List.
Tempo	Determines the Arpeggio Tempo. When MIDI Sync ([UTILITY] → [F5] MIDI → [SF3] SYNC → MIDI Sync) is set to "MIDI," "MIDI" is displayed here and cannot be set. Settings: 1 – 300
VelLimit (Velocity Limit)	Determines the lowest and highest velocity which can trigger the Arpeggio playback. The Arpeggio plays when you play notes at velocities within in this range. Settings: 1 – 127 NOTE Keys played outside the set limit sound normally without any Arpeggio.
Switch	Determines whether Arpeggio playback is on or off. You can also turn this on or off from the front panel with the [ARPEGGIO ON/OFF] button. Settings: off, on
Hold	Determines whether the Arpeggio playback is "held" or not. When this is set to "on," the Arpeggio cycles automatically, even if you release your fingers from the keys, and it continues to cycle until the next key is pressed. Settings: sync-off (see below), off, on sync-offWhen set to "sync-off," the Arpeggio playback continues to run silently, even when you release the keys. Pressing any key turns the Arpeggio playback on again. In other words, you can use the key to "un-mute" or "mute" (not start or stop) the Arpeggio playback by, respectively, holding it down or releasing it.

Voice Edit mode [VOICE] → Voice selection → [EDIT]

There are two kinds of Voices: Normal Voices and Drum Voices. The following section shows how to edit the different types of Voices and explains the parameters available. Note that the parameters available for editing differ depending on the Voice types (Normal Voice, Drum Voice).

Normal Voice Edit

When a Normal Voice is selected, the Voice Edit parameters are divided into Common Edit (parameters common to all four Elements), and Element Edit (parameters of individual Elements).

Common Edit [VOICE] → Normal Voice selection → [EDIT] → [COMMON]

These parameters are for making global (or common) edits to all four Elements of the selected Normal Voice.

[F1] GENERAL	
[SF1] NAME	From this display you can assign the category (sub and main) of the selected Voice, and create a name for the Voice. The Voice name can contain up to 10 characters. For specific instructions on naming, see Basic Operation on page 38.
[SF2] PLY MODE (Play mode)	From this display you can make various settings for the tone generator of this synthesizer, and assign different Micro Tuning settings.
Mono/Poly	Determines whether the Voice is played back monophonically (single notes only) or polyphonically (multiple simultaneous notes). Settings: mono, poly
KeyAsgnMode (Key Assign Mode)	When this is set to "single," double playback of the same note is prevented. This is useful when two or more instances of the same note are received nearly simultaneously, or without a corresponding note off message. To allow playback of each instance of the same note, set this to "multi." Settings: single, multi
M. TuningNo. (Micro Tuning Number)	Determines the tuning system for the Voice. Normally, this should be set to 00 (Equal temperament); however additional tuning systems are available for a variety of tuning applications and effects. Settings: See the Micro Tuning List on page 169.
M. TuningRoot (Micro Tuning Root)	Determines the root note of the Micro Tuning set above. Settings: C – B
[SF3] MEQ OFS (Master EQ Offset)	From this display you can adjust the master (global) EQ settings for the entire Voice. The settings made here are applied as offsets to the EQ settings (with the exception of "MID") in the Utility mode, with the following operation: [VOICE] → [UTILITY] → [F3] VOICE → [SF1] MEQ. Moreover, you can also tweak these settings directly from the four Knobs on the front panel when the [EQ] button is turned on. Settings: -64 – 0 – +63
[SF4] PORTA (Portamento)	From this display you can set the Portamento parameters for all parts of the selected performance. Portamento is used to create a smooth transition in pitch from the first note played on the keyboard to the next.
Switch	Determines whether Portamento is applied to your keyboard performance using the current Voice or not. Settings: off, on
Time	Determines the pitch transition time. Higher values result in a longer pitch change time. Settings: 0 – 127
Mode	Determines how the Portamento is applied to your keyboard performance. Settings: fingered, fulltime fingered Portamento is only applied when you play legato (playing the next note before releasing the previous one). fulltime Portamento is always applied.
TimeMode	Determines how the Time parameter above affects the Portamento effect. Settings: rate1, time1, rate2, time2 rate1 Pitch changes at the specified rate. time1 Pitch changes in the specified time. rate2 Pitch changes at the specified rate within an octave. time2 Pitch changes at the specified rate within an octave.
LegatoSlope	Determines the speed of the attack of legato notes, when Switch above is set to on and Mono/Poly is set to mono. (Legato notes "overlap" each other, the next being played before the previous is released.) The higher the value, the slower the attack rate. Settings: 0 – 7

Voice mode
Performance mode
Song mode
Pattern mode
Mixing Voice mode
Utility mode
File mode
Master mode
Reference

[SF5] OTHER	From this display you can set the control functions for the Knobs, and determine the up/down range for the Pitch Bend wheel.
KnobAssign	Determines the function for the assignable Knobs (1 – 4). Pressing the Knob Control Function button on the panel sets the desired function row, which is automatically stored to memory with the currently selected Voice. Settings: pan, tone, assign, MEQofs, MEF, arpFx
PB Upper (Pitch Bend range Upper), PB Lower (Pitch Bend range Lower)	Sets the amount (in semitones) by which the pitch of the note is varied when you move the Pitch bend wheel up/down. For example, a Lower setting of -12 would result in the pitch being lowered up to a maximum of one octave (12 semitones) when the Pitch Bend wheel is moved downwards. Similarly, setting the Upper parameter to +12 would result in a maximum pitch rise of one octave when the wheel is moved upwards. Settings: -48 – 0 – +24
AssignA, AssignB, Assign1, Assign2	This parameter offsets the value of each Dest (Destination) parameter. Please note that certain Destinations of Assign A/B change the absolute value.

[F2] OUTPUT	
Volume	Determines the output level of the Voice. Settings: 0 – 127
Pan	Determines the stereo pan position of the Voice. Moreover, you can also tweak these settings directly from the four Knobs on the front panel when the [PAN/SEND] button is turned on. Settings: L63 (far left) – C (center) – R63 (far right) NOTE When a stereo Voice is selected, this parameter setting may not be effective. Voices with Elements set to opposite Pan settings (set in [F4] AMP → [SF1] LVL/PAN → Pan)—i.e., one at L63 and another at R63—are considered stereo Voices.
RevSend	Determines the Send level of the signal sent from Insertion Effect A/B (or the bypassed signal) to the Reverb/Chorus effect. Moreover, you can also tweak these settings directly from the four Knobs on the front panel when the [PAN/SEND] button is turned on. Settings: 0 – 127
ChoSend	







NOTE For details on the Effect connections in the Voice mode, see page 142.

[F3] ARP (Arpeggio)

[SF1] TYPE	This display contains the basic settings for Arpeggio playback, including Type and Tempo.
Bank, Ctrg (Category), Type	These three parameters determine the Arpeggio Type. The three-letter prefix number before the Type name indicates the number within the selected Category. Settings: Refer to the separate Data List.
Tempo	Determines the Arpeggio Tempo. When MIDI Sync ([UTILITY] → [F5] MIDI → [SF3] SYNC → MIDI Sync) is set to "MIDI," "MIDI" is displayed here and Tempo cannot be set. Settings: 1 – 300
ChgTiming (Change Timing)	Determines the actual timing at which the Arpeggio type is switched when you select another type during Arpeggio playback. Settings: realtime, measure realtimeThe Arpeggio type is switched immediately when you select another type. measureThe Arpeggio type is switched at the top of the next measure after you select another type.
Switch	Determines whether Arpeggio is on or off. You can also turn this on or off from the front panel with the [ARPEGGIO ON/OFF] button. Settings: off, on
Hold	Determines whether the Arpeggio playback is "held" or not. When this is set to "on," the Arpeggio cycles automatically, even if you release your fingers from the keys, and it continues to cycle until the next key is pressed. Settings: sync-off (see below), off, on sync-offWhen set to "sync-off," the Arpeggio playback continues to run silently, even when you release the keys. Pressing any key turns the Arpeggio playback on again. In other words, you can use the key to "un-mute" or "mute" (not start or stop) the Arpeggio playback by, respectively, holding it down or releasing it.
KeyMode	Determines how the Arpeggio plays back when playing the keyboard. Settings: sort, thru, direct, sortdirect, thrudirect sortWhen you play specific notes (for example, the notes of a chord), the same sequence plays, no matter what order you play the notes. thruWhen you play specific notes (for example, the notes of a chord), the resulting sequence differs depending on the order of the notes. directNote events of the Arpeggio sequence do not play; only the notes you play on the keyboard are heard. This setting is for use with non-note Arpeggio data, such as Control Change or Pitch Bend. When the Arpeggio plays back, these events are applied to the sound of your keyboard performance. Use this setting when the Arpeggio types includes non-note data or when the Category type "Ctrl" is selected. sortdirectThe Arpeggio is played back according to the "sort" setting here, and the note pressed is also sounded. thrudirectThe Arpeggio is played back according to the "thru" setting here, and the note pressed is also sounded. NOTE Some Arpeggio types belonging to the "Cntr" Category may not have note events (page 146). When such an Arpeggio type is selected and the KeyMode is set to "sort" or "thru," no sound is produced even if you press the note on the keyboard. NOTE With the "sort" and "thru" settings, the order in which notes are played back will depend on the Arpeggio sequence data.
VelMode (Velocity Mode)	This determines the playback velocity of the Arpeggio, or how it responds to your own playing strength. Settings: original, thru originalThe Arpeggio plays back at the preset velocities included in the Arpeggio sequence data. thruThe Arpeggio plays back according to the velocity of your playing. For example, if you play the notes strongly, the playback volume of the Arpeggio increases.

Voice mode
Performance mode
Song mode
Pattern mode
Mixing Voice mode
Utility mode
File mode
Master mode

Reference

[SF2] LIMIT	
NoteLimit	<p>Determines the lowest and highest notes in the Arpeggio's note range. Notes played in this range trigger the Arpeggio.</p> <p>Settings: C -2 – G8</p> <p>NOTE For example, setting a Note Limit of "C5 – C4" lets you trigger the Arpeggio by playing notes in the two ranges of C -2 to C4 and C5 to G8; notes played between C4 and C5 have no effect on the Arpeggio.</p> <p>NOTE You can also set the range directly from the keyboard, by holding down the [INFORMATION] button and pressing the desired low and high keys.</p> <p>NOTE Please keep in mind that no sound is produced when the KeyMode is set to "sort" or "thru" and notes are played outside the Note Limit setting here.</p>
VelocityLimit	<p>Determines the lowest and highest velocity in the Arpeggio's velocity range. This lets you control when the Arpeggio sounds by your playing strength.</p> <p>Settings: 1 – 127</p> <p>NOTE You can also create separate low and high trigger ranges for the Arpeggio playback, with a velocity "hole" in the middle, by specifying the maximum value first. For example, setting a Velocity Limit of 93 – 34 lets you play the Arpeggio from two separate velocity ranges: soft (1 – 34) and hard (93 – 127). Notes played at middle velocities between 35 and 92 do not play the Arpeggio.</p>
[SF3] PLAY FX	
<p>These Play Effect parameters let you control the playback of the Arpeggio in useful and interesting ways. By changing the timing and velocity of the notes, you can change the rhythmic "feel" of the Arpeggio.</p>	
UnitMultiply (Unit Multiply)	<p>Adjusts the Arpeggio playback time. For example, if you set a value of 200%, the playback time will be doubled and the tempo halved. On the other hand, if you set a value of 50%, the playback time will be halved and the tempo doubled. Normal playback time is 100%.</p> <p>Settings: 50%, 66%, 75%, 100%, 133%, 150%, 200%</p>
Swing	<p>Delays notes on even-numbered beats (backbeats) to produce a swing feel.</p> <p>Settings: -120 – +120</p>
QuntValue (Quantize Value)	<p>Determines to what beats the note data in the Arpeggio sequence data will be aligned, or determines to what beats in the Arpeggio sequence data the swing is applied.</p> <p>Settings: 32nd note  16th note triplet  16th note  8th note triplet  8th note  1/4 note  1/4 note triplet </p>
QuntStrength (Quantize Strength)	<p>The Strength value sets the "strength" by which note events are pulled toward the nearest quantize beats. A setting of 100% produces exact timing set via the QuntValue parameter above. A setting of 0% results in no quantization.</p> <p>Settings: 0% – 100%</p>
VelocityRate	<p>Determines how much the Velocity of the Arpeggio playback is offset from the original value. For example, a setting of 100% means the original values are used. Settings below 100% will reduce the velocity of the Arpeggio notes, whereas settings above 100% will increase the velocities.</p> <p>Settings: 0% – 200%</p> <p>NOTE The Velocity cannot be decreased or increased beyond its normal range of 1 to 127; any values outside that range will automatically be limited to the minimum or maximum. If it exceeds 127, it will be limited to 127.</p>
GateTimeRate	<p>Determines how much the Gate Time (length) of the Arpeggio notes is offset from the original value. This determines how the original Gate Times are increased or decreased during Arpeggio playback. A setting of 100% means the original values are used. Settings below 100% will shorten the gate times of the Arpeggio notes, whereas settings above 100% will lengthen them.</p> <p>Settings: 0% – 200%</p> <p>NOTE The Gate Time cannot be decreased beyond its normal minimum of 1; any values outside that range will automatically be limited to the minimum.</p>
[F4] CTL SET (Controller Set)	
[SF1] SET1/2 – [SF3] SET5/6	
<p>Since up to six Controller Sets can be assigned to each Voice, three pages (Sets 1/2, Sets 3/4 and Sets 5/6) are provided. For more information on Controller Sets, see page 70.</p>	
ElementSw	<p>Determines whether or not the selected controller affects each individual Element.</p> <p>Settings: Elements 1 to 4 enabled ("1" to "4") or disabled ("-")</p> <p>NOTE This parameter is disabled when the Dest (Destination) described below is set to a parameter unrelated to the Voice Elements.</p>
Source	<p>Determines which panel controller is to be assigned and used for the selected Set. This controller then is used to control the parameter set in Destination below.</p> <p>Settings: PB (Pitch Bend Wheel), MW (Modulation Wheel), AT (After Touch), FC1 (Foot Controller 1), FS (Footswitch), RB (Ribbon Controller), BC (Breath Controller), AS1 (ASSIGN 1; Knob 3), AS2 (ASSIGN 2; Knob 4), FC2 (Foot Controller2)</p> <p>NOTE Keep in mind that unlike the other controllers, the ASSIGN A and B Knobs can each be assigned to one common function for the entire system of this synthesizer, and not to different functions for each individual Voice. Also refer to the Utility mode (page 208).</p>
Dest (Destination)	<p>Determines the parameter that is controlled by the Source controller (above).</p> <p>Settings: Details are given in the Controls List of the separate Data List.</p>
Depth	<p>Determines the degree to which the Source controller affects the Destination parameter. For negative values, the controller operation is reversed; maximum controller settings produce minimum parameter changes.</p> <p>Settings: -64 – 0 – +63</p>

Voice mode
Performance mode
Song mode
Pattern mode
Mixing Voice mode
Utility mode
File mode
Master mode
Reference

[F5] LFO (Low Frequency Oscillator)

From these displays, you can make a variety of LFO related settings. As its name suggests, the LFO creates waveforms of a low frequency. These waveforms can be used to vary the pitch, filter or amplitude to create effects such as vibrato, wah and tremolo.

[SF1] WAVE

Wave

Determines the LFO waveform used to vary the sound.

Settings: tri, tri+, sawup, sawdwn, squ1/4, squ1/3, squ, squ2/3, squ3/4, trpzp, S/H 1, S/H 2, user

Speed

Determines the speed of the LFO waveform. The higher the value, the faster the speed.

Settings: 0 – 63

TempoSync

Determines whether or not the LFO is synchronized to the tempo of the Arpeggio or sequencer (song or pattern).

Settings: off (not synchronized), on (synchronized)

TempoSpeed

This parameter is available only when TempoSync above has been set to "on." It allows you to make detailed note value settings that determine how the LFO pulses in sync with the Arpeggio or sequencer.

Settings: 16th, 8th/3 (eighth-note triplets), 16th. (dotted sixteenth notes), 8th, 4th/3 (quarter-note triplets), 8th. (dotted eighth notes), 4th (quarter notes), 2nd/3 (half-note triplets), 4th. (dotted quarter notes), 2nd (half notes), whole/3 (whole-note triplets), 2nd. (dotted half notes), 4th x 4 (quarter-note quadruplets; four quarter notes to the beat), 4th x 5 (quarter-note quintuplets; five quarter notes to the beat), 4th x 6 (quarter-note sextuplets; six quarter notes to the beat), 4th x 7 (quarter-note septuplets; seven quarter notes to the beat), 4th x 8 (quarter-note octuplets; eight quarter notes to the beat)

NOTE The actual length of the note depends on the internal or external MIDI tempo setting.

KeyOnReset

Determines whether or not the LFO is reset each time a note is pressed. The following three settings are available.

Settings: off, each-on, 1st-on

off.....The LFO cycles freely with no key synchronization. Pressing a key starts the LFO wave at whatever phase the LFO happens to be at that point.

each-on.....The LFO resets with each note you play and starts a waveform at the phase specified by the Phase parameter (below).

1st-on.....The LFO resets with every note you play and starts the waveform at the phase specified by the Phase parameter (below). However, if you play a second note while the first is being held, the LFO continues cycling according to the same phase as triggered by the first note. In other words, the LFO only resets if the first note is released before the second is played.

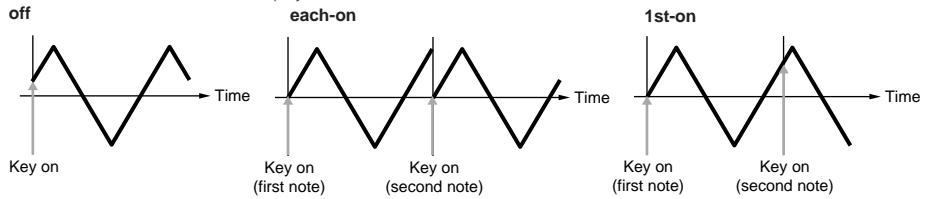

RandomSpeed

Determines the degree to which the LFO speed changes at random. A setting of "0" results in the original speed. Higher values result in a larger degree of speed change.

Settings: 0 – 127

[SF2] DELAY

Delay (Delay Time)

Determines the delay time between the moment you press note on the keyboard and the moment the LFO comes into effect. A higher value results in a longer delay time.

Settings: 0 – 127

FadeIn (Fade In Time)

Determines the amount of time for the LFO effect to fade in (after the Delay time has elapsed). A higher value results in a slower fade-in.

Settings: 0 – 127

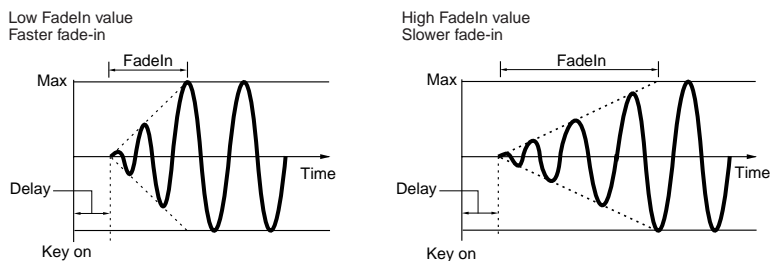

Hold (Hold Time)

Determines the length of time during which the LFO is held at its maximum level. A higher value results in a longer Hold time.

Settings: 0 – 127

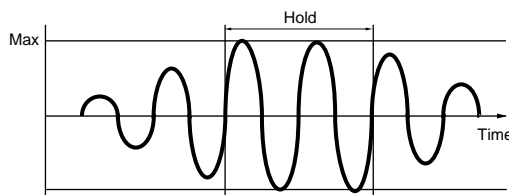

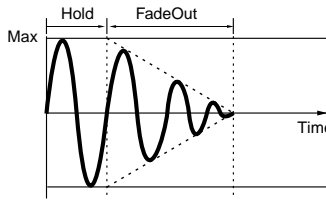
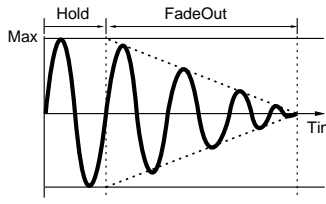
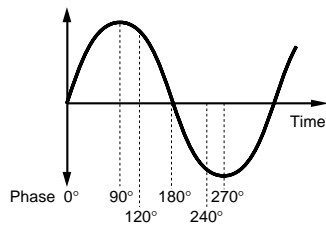
<p>FadeOut</p>	<p>Determines the amount of time for the LFO effect to fade out (after the Delay time has elapsed). A higher value results in a slower fade-out.</p> <p>Settings: 0 – 127</p> <div style="display: flex; justify-content: space-around;"> <div style="text-align: center;"> <p>Low FadeOut value Faster fade-out</p>  </div> <div style="text-align: center;"> <p>High FadeOut value Slower fade-out</p>  </div> </div>
<p>[SF3] PHASE</p>	
<p>Phase</p>	<p>Determines the value for the particular step selected in the Step parameter below.</p> <p>Settings: 0, 90, 120, 180, 240, 270</p> 
<p>Offset EL1 – EL4</p>	<p>Determines the offset values of the Phase parameter (above) for the respective Elements.</p> <p>Settings: +0, +90, +120, +180, +240, +270</p>
<p>[SF4] BOX1 – 3</p>	
<p>ElemSw (Element Switch)</p>	<p>Determines whether or not each Element is to be affected by the LFO. The Element number (1 – 4) is shown when the LFO is enabled; a dash (-) indicates the LFO is disabled for that Element.</p>
<p>Dest (Destination)</p>	<p>Determines the parameters which are to be controlled (modulated) by the LFO Wave.</p> <p>Settings: amd, pmd, fmd, reso (Resonance), pan, ELFOspd (Element LFO Speed)</p>
<p>Depth</p>	<p>Determines the LFO Wave Depth.</p> <p>Settings: 0 – 127</p>
<p>DptRatio EL1 – EL4 (Depth Offset Element 1 – Element 4)</p>	<p>Determines the offset values of the Depth parameter (above) for the respective Elements.</p> <p>Settings: 0 – 127</p>
<p>[SF5] USER</p>	
<p>Template</p>	<p>You can select a pre-programmed template for the LFO wave. The selected template's wave graph appears on the display and you can create the LFO wave by viewing it. Each time pressing the [SF1] random button, different LFO wave is appears on the display randomly.</p> <p>Settings: all0 Values of all the steps are set to 0. all64 Values of all the steps are set to 64. all127 Values of all the steps are set to 127. saw up Creates a saw shaped upward wave. saw down Creates a saw shaped downward wave. even step Values of all even steps are set to 0, and values of all odd steps are set to 127. odd step Values of all odd steps are set to 0, and values of all even steps are set to 127.</p>
<p>Slope</p>	<p>Determines the slope or ramp characteristics of the LFO wave.</p> <p>Settings: off (no slope), up, down, up&down</p>
<p>Value</p>	<p>Determines the value for the particular step selected in the Step parameter below.</p> <p>Settings: 0 – 127</p>
<p>Step</p>	<p>Numerator: Selects the desired step.</p> <p>Settings: 1 – 16</p> <p>Denominator: Determines the maximum number of steps.</p> <p>Settings: 2, 3, 4, 6, 8, 12, 16</p>

[F6] EFFECT

NOTE For details on the Effect connections in the Voice mode, see page 142. For details on the Effect Types, refer to the Effect Type list in the separate Data List booklet.

[SF1] CONNECT	This display gives you comprehensive control over the effects. For details about the parameters, see page 142.
[SF2] INS A (Insertion A)	These are for adjusting the various parameters of the Effect blocks. The number of parameters and values available differs depending on the currently selected effect type. For more information, see the Effect Type List in the separate Data List booklet. Note that the menu of the corresponding Effect block disappears when the "thru" type is selected.
[SF3] INS B (Insertion A)	
[SF4] REVERB	
[SF5] CHORUS	

Element Edit	[VOICE] → Normal Voice selection → [EDIT] → Element selection
---------------------	--

These parameters are for editing the individual Elements that make up a Normal Voice.

[F1] OSC (Oscillator)

[SF1] WAVE	From this display you can select the desired waveform or sound used for the Element.
ElementSw (Element Switch)	Determines whether the currently selected Element is on or off. Settings: off (inactive), on (active)
Wave No. (Waveform Number), WaveCtgr (Waveform Category)	Determines the Waveform for the selected Element. See the Waveform list in the separate Data List.
[SF2] OUTPUT	From this display you can set certain output parameters for the selected Element.
KeyOnDelay	Determines the time (delay) between the moment you press a note on the keyboard and the point at which the sound is played. You can set different delay times for each Element. Settings: 0 – 127
DelayTempoSync	Determines whether or not the KeyOnDelay is synchronized to the tempo of the Arpeggio or sequencer (song or pattern). Settings: off (not synchronized), on (synchronized)
DelayTempo	Determines the timing of the KeyOnDelay when the DelayTempoSync is set to on. Settings: 16th, 8th/3 (eighth-note triplets), 16th. (dotted sixteenth notes), 8th, 4th/3 (quarter-note triplets), 8th. (dotted eighth notes), 4th (quarter notes), 2nd/3 (half-note triplets), 4th. (dotted quarter notes), 2nd (half notes), whole/3 (whole-note triplets), 2nd. (dotted half notes), 4th x 4 (quarter-note quadruplets; four quarter notes to the beat), 4th x 5 (quarter-note quintuplets; five quarter notes to the beat), 4th x 6 (quarter-note sextuplets; six quarter notes to the beat), 4th x 7 (quarter-note septuplets; seven quarter notes to the beat), 4th x 8 (quarter-note octuplets; eight quarter notes to the beat)
InsEffectOut (Insertion Effect Output)	Determines which Insertion effect (A or B) is used to process each individual Element. The "thru" setting lets you bypass the Insertion effects for the specific key. (This parameter is the same as "EL: OUT" on the [F6] EFFECT → [SF1] CONNECT display in Normal Common Edit. Making a setting here automatically changes the setting of that parameter as well.) Settings: thru, insA (Insertion Effect A), insB (Insertion Effect B)
[SF3] LIMIT	
NoteLimit	Determines the lowest and highest notes of the keyboard range for each Element. The selected Element will sound only when you play notes within this range. Settings: C -2 – G8 NOTE You can also create a lower and an upper range for the Element, with a note range "hole" in the middle, by specifying the highest note first. For example, setting a Note Limit of "C5 - C4" lets you play the Element from two separate ranges: C -2 to C4 and C5 to G8. Notes played between C4 and C5 do not play the selected Element. NOTE You can also set the Center Key directly from the keyboard, by holding down the [INFORMATION] button and pressing the desired key.
VelocityLimit	Determines the minimum and maximum values of the velocity range within which each Element will respond. Each Element will only sound for notes played within its specified velocity range. For example, this lets you have one Element sound when you play softly and have a different one sound when you play strongly. Settings: 1 – 127 NOTE You can also create separate low and high ranges for the Element, with a velocity "hole" in the middle, by specifying the maximum value first. For example, setting a Velocity Limit of 93 - 34 lets you play the Element from two separate velocity ranges: soft (1 – 34) and hard (93 – 127). Notes played at middle velocities between 35 and 92 do not play the selected Element
VelCrossFade (Velocity Cross Fade)	This determines how gradually the sound of an Element decreases in volume in proportion to the distance of velocity changes outside the Velocity Limit setting (above). The practical application of this parameter is to create natural-sounding velocity crossfades, in which different Elements change gradually depending on how strongly or softly you play. The higher the value, the more gradual the level change. Settings: 0 – 127

Voice mode

Performance mode

Song mode

Pattern mode

Mixing Voice mode

Utility mode

File mode

Master mode

Reference

[F2] PITCH																						
[SF1] TUNE	From this display you can set various pitch-related parameters for the selected Element.																					
Coarse	Determines the pitch of each Element in semitones. Settings: -48 – 0 – +48																					
Fine	Determines the fine tuning for the pitch of each Element. Settings: -64 – 0 – +63																					
FineScaling	Determines the degree to which the notes (specifically, their position or octave range) affect the pitch in fine tuning (set above) of the selected Element, regarding C3 as the basic pitch. A positive setting will cause the pitch of lower notes to change lower and that of higher notes to change higher. Negative values will have the opposite effect. Settings: -64 – 0 – +63																					
Random	This lets you randomly vary the pitch of the Element for each note you play. This is effective in reproducing the natural pitch variations in acoustic instruments. It is also useful for creating unusual random pitch changes. The higher the value, the greater the pitch variation. A value of "0" results in no pitch change. Settings: 0 – 127																					
[SF2] VEL SENS (Velocity Sensitivity)	From this display you can determine how the Pitch EG responds to velocity.																					
EGTime, Segment	Determines the velocity sensitivity of the PEG's Time parameters. Select the Segment first, then set its Time parameter. Positive Time settings will play back the specified Segment faster in proportion to the played velocity and negative values will play it back slower. Settings: EGTime: -64 – 0 – +63 Settings: Segment: atk, atk+dcy, dcy, atk+rls, all atk (attack) EG Time Value affects Attack time. atk+dcy (attack + decay) EG Time Value affects Attack/Decay1 time. dcy (decay) EG Time Value affects Decay time. atk+rls (attack + release) EG Time Value affects Attack/Release time. all EG Time Value affects all PEG Time parameters.																					
EGDepth, Curve	Determines the velocity sensitivity of the PEG Level. Positive settings will cause the pitch change to rise the harder you play the keyboard, and negative values will cause it to fall. The Curve parameter lets you select from five different preset velocity curves (graphically indicated in the display), that determine how velocity affects the Pitch EG Depth. Settings: EGDepth: -64 – 0 – +63 Settings: Curve: 0 – 4																					
Pitch	Determines the velocity sensitivity of the Pitch. Extreme values produce greater variation in PEG Depth. For positive values, the harder you play the keys, the greater the change in PEG Depth. For negative values, the softer you play the keys, the greater the change in PEG Depth. Settings: -64 – 0 – +63																					
[SF3] PEG (Pitch Envelope Generator)	From this display you can make all the time and level settings for the Pitch EG, which determine how the pitch of the sound changes over time. These can be used to control the change in pitch from the moment a note is pressed on the keyboard to the moment the sound stops. The full names of the available parameters are shown in the chart below, as they appear in the display.																					
	<table border="1"> <thead> <tr> <th></th> <th>HOLD</th> <th>ATK</th> <th>DCY1</th> <th>DCY2</th> <th>REL</th> <th>DEPTH</th> </tr> </thead> <tbody> <tr> <th>TIME</th> <td>Hold time</td> <td>Attack time</td> <td>Decay1 time</td> <td>Decay2 time</td> <td>Release time</td> <td></td> </tr> <tr> <th>LEVEL</th> <td>Hold level</td> <td>Attack level</td> <td>Decay1 level</td> <td>Decay2 level</td> <td>Release level</td> <td>Depth</td> </tr> </tbody> </table> <p>Settings: TIME: 0 – 127 LEVEL: -128 – 0 – +127 DEPTH: -64 – 0 – +63</p> <p>NOTE For details on the PEG, see page 132.</p>		HOLD	ATK	DCY1	DCY2	REL	DEPTH	TIME	Hold time	Attack time	Decay1 time	Decay2 time	Release time		LEVEL	Hold level	Attack level	Decay1 level	Decay2 level	Release level	Depth
	HOLD	ATK	DCY1	DCY2	REL	DEPTH																
TIME	Hold time	Attack time	Decay1 time	Decay2 time	Release time																	
LEVEL	Hold level	Attack level	Decay1 level	Decay2 level	Release level	Depth																
[SF4] KEY FLW (Key Follow)	From this display you can set the Key Follow effect—in other words, how the pitch of the Element and its Pitch EG respond to the particular notes (or octave range) you play.																					
PitchSens (Pitch Sensitivity)	Determines the degree of the Key Follow effect (the pitch interval of adjacent notes). A Center Key setting is used as the basic setting. At +100 (the normal setting), adjacent notes are pitched one semitone (100 cents) apart. At 0, all notes are the same pitch. At +50, one octave is stretched out over twenty-four notes. For negative values, the settings are reversed. Settings: -200 – 0 – +200 NOTE This parameter is useful for creating alternate tunings, or for use with sounds that do not need to be spaced in semitones, such as pitched drum sounds in a Normal Voice.																					
▶ CenterKey	Determines the central note or pitch for the Key Follow effect on pitch. The note number set here is the same pitch as normal regardless of the Pitch Sensitivity setting. Depending on the Pitch Sensitivity parameter above, the further away from the Center Key the keys are played, the greater the degree of pitch change. Settings: C -2 – G8 NOTE You can also set the Center Key directly from the keyboard, by holding down the [INFORMATION] button and pressing the desired key.																					

Voice mode
Performance mode
Song mode
Pattern mode
Mixing Voice mode
Utility mode
File mode
Master mode
Reference

<p>EGTimeSens (EG Time Sensitivity)</p>	<p>Determines the degree to which the notes (specifically, their position or octave range) affect the Pitch EG times of the selected Element. The Center Key (next parameter) is used as the basic pitch for this parameter. A positive setting will cause the amplitude of lower notes to change slower and that of higher notes to change faster. Conversely, negative values will cause it to fall.</p> <p>Settings: -64 ~ 0 ~ +63</p>
<p>▶ CenterKey</p>	<p>Determines the central note or pitch for the Key Follow effect on Pitch EG. When the Center Key note is played, the PEG behaves according to its actual settings. The pitch change characteristics for other notes will vary in proportion to the EG Time settings.</p> <p>Settings: C -2 ~ G8</p> <p>NOTE You can also set the Center Key directly from the keyboard, by holding down the [INFORMATION] button and pressing the desired key.</p>

Pitch Sensitivity and Center Key

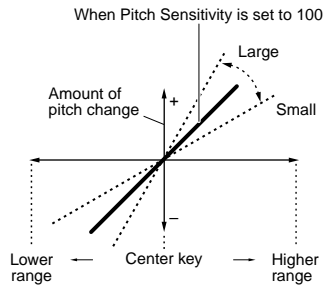

EG Time Sensitivity and Center Key

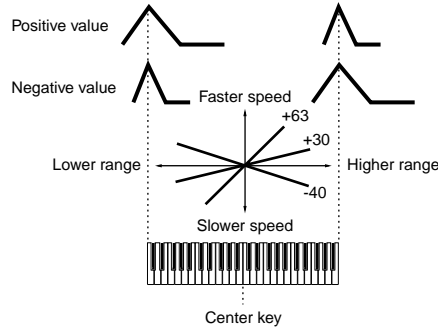

[F3] FILTER

[SF1] TYPE

	<p>From this display you can make comprehensive settings for the Filter unit. The available parameters differ depending on which Filter type is selected here.</p>
<p>Type</p>	<p>Basically, there are four different Filter types: an LPF (Low Pass Filter), an HPF (High Pass Filter), a BPF (Band Pass Filter) and a BEF (Band Elimination Filter). Each type has a different frequency response and produces a different effect on the sound. This synthesizer also features special combination Filter types, for additional sonic control.</p> <p>Settings: Refer to page 170.</p>
<p>Gain</p>	<p>Determines the Gain (the amount of boost applied to the signal sent to the Filter).</p> <p>Settings: 0 ~ 255</p>
<p>Cutoff</p>	<p>Determines the cutoff frequency for the Filter, or the central frequency around which the Filter is applied.</p> <p>Settings: 0 ~ 255</p>
<p>Resonance/Width</p>	<p>This parameter's function varies according to the selected Filter Type. If the selected filter is an LPF, HPF, BPF (excluding the BPFw), or BEF, this parameter is used to set the Resonance. For the BPFw, it is used to adjust the Width of the band. Resonance is used to set the amount of Resonance (harmonic emphasis) applied to the signal at the cutoff frequency. This can be used in combination with the cutoff frequency parameter to add further character to the sound. The Width parameter is used to adjust the width of the band of signal frequencies passed by the filter with the BPFw.</p> <p>Settings: 0 ~ 127</p>
<p>Distance</p>	<p>Determines the distance between the Cutoff frequencies, for the Dual Filter types (which feature two identical filters combined in parallel, and the LPF12 + BPF6 type).</p> <p>Settings: 0 ~ 255</p>
<p>HPFCutoff</p>	<p>Determines the central frequency for the Key Follow parameter (below) of the HPF. When a filter type "LPF12" or "LPF6" is selected, this parameter is available.</p> <p>Settings: 0 ~ 255</p>
<p>HPFKeyFlw (Key Follow)</p>	<p>Determines the Key Follow setting for the HPF Cutoff frequency. This parameter varies the center frequency according to the position of the notes played on the keyboard. A positive setting will raise the center frequency for higher notes and lower it for lower notes. A negative setting will have the opposite effect. This parameter is available only when the filter type "LPF12" or "LPF6" is selected.</p> <p>Settings: -200 ~ 0 ~ +200</p>
<p>[SF2] VEL SENS (Velocity Sensitivity)</p>	<p>From this display you can determine how the Filter and the FEG respond to velocity.</p>
<p>EGTime, Segment</p>	<p>Determines the velocity sensitivity of the FEG's Time parameters. Select the Segment first, then set its Time parameter. Positive Time settings will play back the specified Segment faster in proportion to the played velocity and negative values will play it back slower.</p> <p>Settings: EG Time: -64 ~ 0 ~ +63</p> <p>Settings: Segment: atk, atk+dcy, dcy, atk+rls, all</p> <p>atk (attack)EG Time Value affects Attack time.</p> <p>atk+dcy (attack + decay)EG Time Value affects Attack/Decay1 time.</p> <p>dcy (decay).....EG Time Value affects Decay time.</p> <p>atk+rls (attack + release).....EG Time Value affects Attack/Release time.</p> <p>allEG Time Value affects all FEG Time parameters.</p>

Voice mode

Performance mode

Song mode

Pattern mode

Mixing Voice mode

Utility mode

File mode

Master mode

Reference

EGDepth, Curve	<p>Determines the velocity sensitivity of the FEG Level. For positive settings, the more strongly you play the keyboard, the more Filter changes the sound. Negative settings do the opposite; the more softly you play, the more the sound changes. The Curve parameter lets you select from five different preset velocity curves (graphically indicated in the display), that determine how velocity affects the Filter EG.</p> <p>Settings: EGDepth: -64 - 0 - +63 Settings: Curve: 0 - 4</p>
Cutoff	<p>Determines the degree to which velocity affects the Cutoff frequency of the Filter EG. For positive values, the more strongly you play the keys, the greater the change in the Cutoff frequency. Negative values do the opposite; the more softly you play, the greater the change in frequency.</p> <p>Settings: -64 - 0 - +63</p>
Resonance	<p>Determines the degree to which velocity affects the Resonance of the Filter EG. For positive values, the more strongly you play the keys, the greater the Resonance change. Negative values do the opposite; the more softly you play, the greater the change in Resonance.</p> <p>Settings: -64 - 0 - +63</p>

[SF3] FEG (Filter Envelope Generator)	<p>From this display you can make all the time and level settings for the Filter EG, which determine how the tonal quality of the sound changes over time. These can be used to control the change in Cutoff Frequency from the moment a note is pressed on the keyboard to the moment the sound stops. The full names of the available parameters are shown in the chart below, as they appear in the display.</p> <table border="1" style="width: 100%; text-align: center;"> <thead> <tr> <th></th> <th>HOLD</th> <th>ATK</th> <th>DCY1</th> <th>DCY2</th> <th>REL</th> <th>DEPTH</th> </tr> </thead> <tbody> <tr> <td>TIME</td> <td>Hold time</td> <td>Attack time</td> <td>Decay1 time</td> <td>Decay2 time</td> <td>Release time</td> <td></td> </tr> <tr> <td>LEVEL</td> <td>Hold level</td> <td>Attack level</td> <td>Decay1 level</td> <td>Decay2 level</td> <td>Release level</td> <td>Depth</td> </tr> </tbody> </table> <p>Settings: TIME: 0 - 127 LEVEL: -128 - 0 - +127 DEPTH: -64 - 0 - +63</p> <p>NOTE For details on the FEG, see page 133.</p>		HOLD	ATK	DCY1	DCY2	REL	DEPTH	TIME	Hold time	Attack time	Decay1 time	Decay2 time	Release time		LEVEL	Hold level	Attack level	Decay1 level	Decay2 level	Release level	Depth
	HOLD	ATK	DCY1	DCY2	REL	DEPTH																
TIME	Hold time	Attack time	Decay1 time	Decay2 time	Release time																	
LEVEL	Hold level	Attack level	Decay1 level	Decay2 level	Release level	Depth																

[SF4] KEY FLW (Key Follow)	<p>From this display you can set the Key Follow effect for the Filter—in other words, how the tonal qualities of the Element and its Filter EG respond to the particular notes (or octave range) you play.</p>
-----------------------------------	--

CutoffSens (Cutoff Sensitivity)	<p>Determines the degree to which the notes (specifically, their position or octave range) affect the Filter of the selected Element. A Center Key setting (next parameter) of C3 is used as the basic setting by the Cutoff parameter. A positive setting will lower the Cutoff frequency for lower notes and raise it for higher notes. A negative setting will have the opposite effect.</p> <p>Settings: -200 - 0 - +200</p>
▶ CenterKey	<p>This indicates that the central note for Cutoff Sensitivity above is C3. At C3, the tone remains unchanged. For other notes played, the Cutoff Frequency varies according to the particular note and the Cutoff Sensitivity setting. Keep in mind that this is for display purposes only; the value cannot be changed.</p> <p>Settings: C -2 - G8</p>
EGTimeSens (EG Time Sensitivity)	<p>Determines the degree to which the notes (specifically, their position or octave range) affect the Filter EG times of the selected Element. The basic speed of change for the FEG is at the note specified in the Center Key (next parameter). A positive setting will cause slower changes for lower notes and faster changes for higher notes. A negative setting will have the opposite effect.</p> <p>Settings: -64 - 0 - +63</p>
▶ CenterKey	<p>Determines the central note or pitch for the Key Follow effect on Filter EG. Depending on the EG Time Sensitivity parameter above, the further away from the Center Key the keys are played, the more the time of the Filter EG deviates from the normal. When the Center Key note is played, the FEG behaves according to its actual settings. The Filter change characteristics for other notes will vary in proportion to the EG Time settings.</p> <p>Settings: C -2 - G8</p> <p>NOTE You can also set the Center Key directly from the keyboard, by holding down the [INFORMATION] button and pressing the desired key.</p>

Cutoff Sensitivity and Center Key

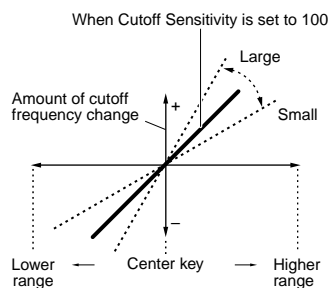

EG Time Sensitivity and Center Key

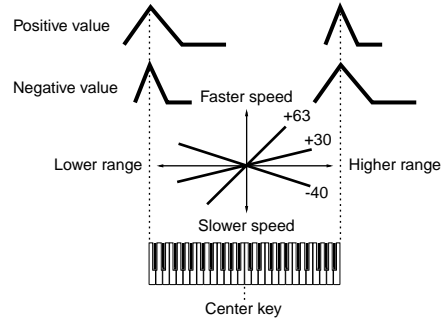

[SF5] SCALE (Filter Scaling)	<p>Filter Scaling controls the filter cutoff frequency according to the positions of the notes on the keyboard. You can divide the entire keyboard by four break points, and assign different offset values of Cutoff Frequency to them respectively. Refer to the setting example on page 169.</p> <p>Settings: BREAK POINT 1 - 4: C-2 - G8 OFFSET 1 - 4: 128 - 0 - +127</p> <p>NOTE You can also set the Break Point directly from the Keyboard, by holding down the [INFORMATION] button and pressing the desired key.</p>
-------------------------------------	---

Voice mode
Performance mode
Song mode
Pattern mode
Mixing Voice mode
Utility mode
File mode
Master mode
Reference

[F4] AMP (Amplitude)

[SF1] LVL/PAN (Level/Pan)

This display not only lets you make basic Level and Pan settings for each individual Element, it also gives you some detailed and unusual parameters for affecting Pan position.

Level

Determines the output level for the selected Element.
Settings: 0 – 127

Pan

Determines the stereo Pan position for the selected Element. This will also be used as the basic Pan position for the Alternate, Random and Scale settings.
Settings: L63 (far left) – C (center) – R63 (far right)

AlternatePan

Determines the amount by which the sound of the selected Element is panned alternately left and right for each note you press. The Pan setting (above) is used as the basic Pan position.
Settings: L64 – 0 – R63

RandomPan

Determines the amount by which the sound of the selected Element is panned randomly left and right for each note you press. The Pan setting is used as the Center Pan position.
Settings: 0 – 127

ScalingPan

Determines the degree to which the notes (specifically, their position or octave range) affect the Pan position, left and right, of the selected Element. At note C3, the main Pan setting (above) is used for the basic Pan position.
Settings: -64 – 0 – +63

[SF2] VEL SENS (Velocity Sensitivity Depth)

From this display you can determine how the Amplitude (volume) EG responds to velocity.

EG Time, Segment

Determines the velocity sensitivity of the AEG's Time parameters. Select the Segment first, then set its Time parameter. Positive Time settings will play back the specified Segment faster in proportion to the played velocity and negative values will play it back slower.
Settings: EG Time: -64 – 0 – +63
Settings: Segment: atk, atk+dcy, dcy, atk+rls, all
 atk (attack)EG Time Value affects Attack time.
 atk+dcy (attack + decay)EG Time Value affects Attack/Decay1 time.
 dcy (decay).....EG Time Value affects Decay time.
 atk+rls (attack + release).....EG Time Value affects Attack/Release time.
 allEG Time Value affects all AEG Time parameters.

Level, Curve

Determines the velocity sensitivity of the Amplitude EG Level. For positive settings, the more strongly you play the keyboard, the more the volume changes. Negative settings do the opposite; the more softly you play, the more the volume changes. The Curve parameter lets you select from five different preset velocity curves (graphically indicated in the display), that determine how velocity affects the Amplitude EG.
Settings: Level: 64 – 0 – +63
 Curve: 0 – 4

[SF3] AEG (Amplitude Envelope Generator)

From this display you can make all the time and level settings for the Amplitude EG, which determine how the volume of the sound changes over time. These can be used to control the change in volume from the moment a note is pressed on the keyboard to the moment the sound stops. The full names of the available parameters are shown in the chart below, as they appear in the display.

	INIT	ATK	DCY1	DCY2	REL	DEPTH
TIME	---	Attack time	Decay1 time	Decay2 time	Release time	
LVL/SW	Initial level	Attack level	Decay1 level	Decay2 level	---	---

Settings: TIME: 0 – 127
 LEVEL: 0 – 127
NOTE For details on the AEG, see page 134.

[SF4] KEY FLW (Key Follow)

From this display you can set the Key Follow effect for Amplitude—in other words, how the volume of the Element and its Amplitude EG respond to the particular notes (or octave range) you play.

LevelSens (Level Sensitivity)

Determines the degree to which the notes (specifically, their position or octave range) affect the volume of the selected Element. A Center Key setting of C3 is used as the basic setting. A positive setting will lower the output level for lower notes and raise it for higher notes. A negative setting will have the opposite effect.
Settings: -200 – 0 – +200

▶ **CenterKey**

This indicates that the central note for Level Sensitivity above is C3. At C3, the volume (level) remains unchanged. For other notes played, the volume varies according to the particular note and the Level Sensitivity setting. Keep in mind that this is for display purposes only; the value cannot be changed.

EGTimeSens (EG Time Sensitivity)

Determines the degree to which the notes (specifically, their position or octave range) affect the Amplitude EG times of the selected Element. The Center Key (next parameter) is used as the basic amplitude for this parameter. A positive setting will cause the amplitude of lower notes to change slower and that of higher notes to change faster. Negative values will have the opposite effect.
Settings: -64 – 0 – +63

Voice mode

Performance mode

Song mode

Pattern mode

Mixing Voice mode

Utility mode

File mode

Master mode

Reference

<p>► CenterKey</p>	<p>Determines the central note or pitch for the Key Follow effect on Amplitude EG. Depending on the EG Time Sensitivity parameter above, the further away from the Center Key the keys are played, the more the time of the Amplitude EG deviates from the norm.</p> <p>When the Center Key is played, the AEG behaves according to its actual settings. The amplitude change characteristics for other notes will vary in proportion to the EGTime settings.</p> <p>Settings: C -2 – G8</p> <p>NOTE You can also set the Center Key directly from the keyboard, by holding down the [INFORMATION] button and pressing the desired key.</p>
--------------------	---

Level Sensitivity and Center Key

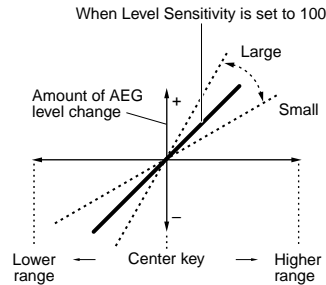

EG Time Sensitivity and Center Key

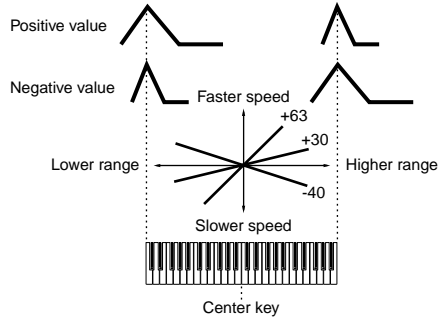

<p>[SF5] SCALE (Amplitude Scaling)</p>	<p>Amplitude Scaling controls the output level (set in the [F4] AMP í [SF1] LVL /PAN display) according to the positions of the notes on the keyboard. You can divide the entire keyboard by four break points, and assign different offset values of amplitude to them respectively. Refer to the setting example on page 169.</p> <p>Settings: BREAK POINT 1 – 4: C-2 – G8</p> <p>Settings: OFFSET 1 – 4: -128 – 0 – +127</p> <p>NOTE You can also set the Break Point directly from the Keyboard, by holding down the [INFORMATION] button and pressing the desired key.</p>
---	--

[F5] LFO (Low Frequency Oscillator)

This display gives you a comprehensive set of controls over the LFO for each individual Element. The LFO can be used to create vibrato, wah, tremolo and other special effects, by applying it to the pitch, filter and amplitude parameters.

<p>Wave</p>	<p>Determines the LFO waveform used to vary the sound.</p> <p>Settings: saw, tri, squ</p> <div style="display: flex; justify-content: space-around; align-items: flex-start;"> <div style="text-align: center;"> <p>saw (sawtooth wave)</p> </div> <div style="text-align: center;"> <p>tri (triangle wave)</p> </div> <div style="text-align: center;"> <p>squ (square wave)</p> </div> </div>
<p>Speed</p>	<p>Determines the speed of the LFO waveform. The higher the value, the faster the speed.</p> <p>Settings: 0 – 63</p>
<p>KeyOnReset</p>	<p>Determines whether or not the LFO is reset each time a note is played.</p> <p>Settings: off, on</p> <div style="display: flex; align-items: center; justify-content: center;"> <div style="text-align: center;"> <p>Off</p> </div> <div style="font-size: 2em; margin: 0 10px;">➔</div> <div style="text-align: center;"> <p>On</p> </div> </div>
<p>KeyOnDelay</p>	<p>Determines the delay time between the moment you play a note on the keyboard and the moment the LFO comes into effect. A higher value results in a longer delay time.</p> <p>Settings: 0 – 127</p>
<p>PMod (Pitch Modulation Depth)</p>	<p>Determines the amount (depth) by which the LFO waveform varies (modulates) the pitch of the sound. The higher the value, the greater the amount of pitch modulation.</p> <p>Settings: 0 – 127</p>
<p>FMod (Filter Modulation Depth)</p>	<p>Determines the amount (depth) by which the LFO waveform varies (modulates) the Filter Cutoff frequency. The higher the value, the greater the amount of filter modulation.</p> <p>Settings: 0 – 127</p>
<p>AMod (Amplitude Modulation Depth)</p>	<p>Determines the amount (depth) by which the LFO waveform varies (modulates) the amplitude or volume of the sound. The higher the value, the greater the amount of amplitude modulation.</p> <p>Settings: 0 – 127</p>
<p>FadeInTime</p>	<p>Determines the amount of time for the LFO effect to fade in (after the KeyOnDelay time has elapsed). A higher value results in a slower fade-in.</p> <p>Settings: 0 – 127</p>

Voice mode
 Performance mode
 Song mode
 Pattern mode
 Mixing Voice mode
 Utility mode
 File mode
 Master mode
 Reference

[F6] EQ (Equalizer)

Type

Determines the Equalizer Type. This synthesizer features a wide selection of various equalizer types, which can be used not only to enhance the original sound, but even completely change the character of the sound. The particular parameters and settings available depend on the specific Equalizer Type that is selected.

Settings: EQ L/H, P.EQ, boost6, boost12, boost18, thru

EQ L/H (Low/High).....This is a "shelving" equalizer, which combines separate high and low frequency bands.

P.EQ (Parametric EQ)The Parametric EQ is used to attenuate or boost signal levels (gain) around the Frequency. This type features 32 different "Q" settings, which determine the frequency band width of the equalizer.

boost6 (boost 6dB)/boost12 (boost 12dB)/boost18 (boost 18dB)

These can be used to boost the level of the entire signal by 6dB, 12dB and 18dB, respectively.

thru.....If you select this, the equalizers are bypassed and the entire signal is unaffected.

When set to EQ L/H

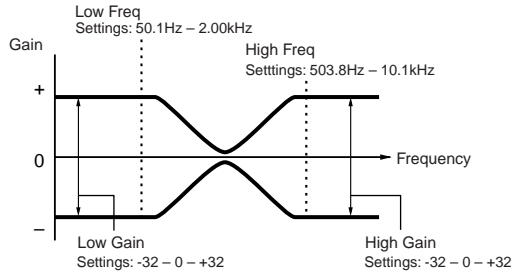

When set to P.EQ

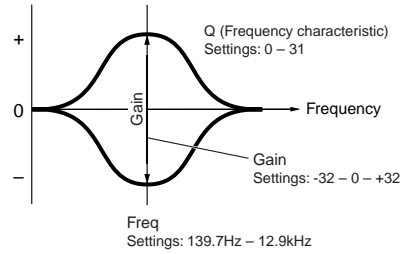

Voice mode

Performance mode

Song mode

Pattern mode

Mixing Voice mode

Utility mode

File mode

Master mode

Reference

Drum Voice Edit

When a Drum Voice is selected, Voice Edit parameters are divided into Common Edit (parameters common to all keys, up to 73), and Key Edit (parameters of individual keys).

Common Edit	[VOICE] → Drum Voice selection → [EDIT] → [COMMON]
--------------------	--

These parameters are for making global (or common) edits to all keys of the selected Drum Voice.

[F1] GENERAL	
[SF1] NAME	Same as in Normal Voice Common Edit. See page 153.
[SF3] MEQ OFS (Master EQ Offset)	
[SF5] OTHER	
[F2] OUTPUT	
Same as in Normal Voice Common Edit. See page 154. In addition, the following two parameters are also available.	
InsRevSend (Insertion Reverb Send)	Determines the Send level for the entire Drum Voice (all keys), sent from Insertion Effect A/B to the Reverb effect. Settings: 0 – 127
InsChoSend (Insertion Chorus Send)	Determines the Send level for the entire Drum Voice (all keys), sent from Insertion Effect A/B to the Chorus effect. Settings: 0 – 127

NOTE The parameters cannot be set independently for each Drum key.

NOTE For Normal Voices, the values are fixed at 127 (maximum).

[F3] ARP (Arpeggio)	
[SF1] TYPE	Same as in Normal Voice Common Edit. See page 154.
[SF2] LIMIT	
[SF3] PLAY FX	
[F4] CTL SET (Controller Set)	
Same as in Normal Voice Common Edit. See page 155. Please note that the Element Switch parameter is not available in Drum Voice Common Edit.	
[F6] EFFECT	
Same as in Normal Voice Common Edit. See page 158. The only difference here is that "KEY: OUT" appears in the [SF1] CONNECT display instead of "EL: OUT" (in Normal Common Effect).	

Key Edit	[VOICE] → Drum Voice selection → [EDIT] → Key selection
-----------------	---

These parameters are for editing the individual keys that make up a Drum Voice.

[F1] OSC (Oscillator)	
[SF1] WAVE	From this display you can select the desired wave or Normal Voice used for the individual Drum key.
Type	Determines whether a Wave or a Normal Voice is to be used for the selected key. Also, use the Bank, Number and Category parameters below to specify the desired Wave or Normal Voice. Settings: pre wav (Preset wave), voice NOTE When the Type is set to "voice" here, some parameters in the Drum Voice Edit mode cannot be edited.
ElementSw (Element Switch)	This parameter is available when Type (above) is set to "pre wav." This determines whether the currently selected key is on or off, or in other words, whether the wave for the key is active or inactive. Settings: on, off
Bank	This parameter is available when Type (above) is set to "voice." Any of the Normal Voice banks can be selected.
Number	Determines the Wave/Voice number. The number differs depending on the selected Type. For details about available Waves and Voices, refer to the separate Data List booklet. Settings: When Type is set to "pre wav": 0001 – 1859 When Type is set to "voice": 001 – 128
Category	Determines the Category of the Wave/Normal Voice. If you switch to another Category, the first Wave/Normal Voice in that Category will be selected. NOTE For more information about the Categories, refer to the separate Data List booklet.

Voice mode
Performance mode
Song mode
Pattern mode
Mixing Voice mode
Utility mode
File mode
Master mode
Reference

[SF2] OUTPUT	From this display you can set certain output parameters for the selected Drum key.
InsEFOut (Insertion Effect Output)	Determines which Insertion effect (A or B) is used to process each individual Drum key. The "thru" setting lets you bypass the Insertion effects for the specific key. Settings: thru, insA (Insertion Effect A), insB (Insertion Effect B)
RevSend (Reverb Send)	Determines the level of the Drum key sound (the bypassed signal) that is sent to Reverb effect. This is available only when Insertion Effect Output (above) is set to "thru." Settings: 0 – 127
ChoSend (Chorus Send)	Determines the level of the Drum key sound (the bypassed signal) that is sent to Chorus effect. This is available only when Insertion Effect Output (above) is set to "thru." Settings: 0 – 127
[SF5] OTHER	From this display you can set various parameters related to how the individual notes of the Drum Voice respond to the keyboard and MIDI data.
AssignMode	Selects sngl (single) or mlti (multi) Key Assign. When this is set to "sngl," double playback of the same note is prevented. To allow playback of each instance of the same note, set this to "mlti." Settings: sngl (single), mlti (multi)
RcvNoteOff (Receive Note Off)	Determines whether or not the selected Drum key responds to MIDI Note Off messages. Settings: off, on NOTE This parameter is only available if the Type parameter ([F1] OSC → [SF1] WAVE display) is set to "pre wav."
AlternateGroup	Sets the Alternate Group to which the key is assigned. In a real drum kit, some drum sounds cannot physically be played simultaneously, such as open and closed hi-hats. You can prevent keys from playing back simultaneously by assigning them to the same Alternate Group. Up to 127 Alternate Groups can be defined. You can also select "off" here if you wish to allow the simultaneous playback of sounds. Settings: off, 1 – 127 NOTE This parameter is only available if the Type parameter ([F1] OSC → [SF1] WAVE display) is set to "pre wav."

[F2] PITCH

[SF1] TUNE	From this display you can set various pitch-related parameters for the selected key.
Coarse	Determines the pitch of each Drum Key Wave (or Normal Voice) in semitones. Settings: -48 – +48 NOTE If a Normal Voice has been assigned to the key, this parameter adjusts the position of its note (not its pitch) relative to note C3.
Fine	Determines the fine tuning for the pitch of each Drum Key Wave (or Normal Voice). Settings: -64 – +63
[SF2] VEL SENS (Velocity Sensitivity)	This parameter is only available if the Type parameter ([F1] OSC → [SF1] WAVE display) is set to "pre wav."
Pitch	Determines how the pitch of the selected Drum key responds to velocity. For positive values, the more strongly you play the key, the higher the pitch becomes. For negative values, the more strongly you play the key, the lower the pitch. Settings: -64 – +63

[F3] FILTER

[SF1] CUTOFF	This synthesizer lets you apply a low pass filter and high pass filter to each individual Drum key—giving you exceptionally detailed and comprehensive sonic control over the Drum voice. Settings: This parameter is available when the Type is set to "pre wav" in the [F1] OSC → [SF1] WAVE display.
LPFCutoff	Determines the Cutoff frequency of the Low Pass Filter. Settings: 0 – 255
LPFReso	Determines the amount of Resonance (harmonic emphasis) applied to the signal at the Cutoff frequency. Settings: 0 – 127
HPFCutoff	Determines the Cutoff frequency of the High Pass Filter. Settings: 0 – 255
[SF2] VEL SENS (Velocity Sensitivity)	This parameter is only available if the Type parameter ([F1] OSC → [SF1] WAVE display) is set to "pre wav."
LPFCutoff	Determines the velocity sensitivity of the Low Pass Filter Cutoff frequency. For positive settings, the more strongly you play the keyboard, the higher the cutoff frequency becomes. For negative settings, the more strongly you play, the lower the cutoff frequency. Settings: -64 – 0 – +63

Voice mode

Performance mode

Song mode

Pattern mode

Mixing Voice mode

Utility mode

File mode

Master mode

Reference

[F4] AMP (Amplitude)

[SF1] LVL/PAN (Level/Pan)	This display not only lets you make basic Level and Pan settings for the sound of each individual Drum key, it also gives you some detailed and unusual parameters for affecting Pan position.
Level	Determines the output for the selected Drum key (Wave). This lets you make detailed balance adjustments among the various sounds of the Drum Voice. Settings: 0 – 127
Pan	Determines the stereo Pan position for the selected Drum key (Wave). This will also be used as the basic Pan position for the Alternate and Random settings. Settings: L63 (far left) – C (center) – R63 (far right)
AlternatePan	Determines the amount by which the sound of the selected Drum key is panned alternately left and right for each note you press. The Pan setting (above) is used as the basic Pan position. Settings: L64 – 0 – R63 NOTE This parameter is available when the Type is set to “pre wav” in the [F1] OSC → [SF1] WAVE display.
RandomPan	Determines the amount by which the sound of the selected Drum key is panned randomly left and right for each note you press. The Pan setting (above) is used as the Center Pan position. Settings: 0 – 127 NOTE This parameter is available when the Type is set to “pre wav” in the [F1] OSC → [SF1] WAVE display.

[SF2] VEL SENS (Velocity Sensitivity)

Level	Determines the velocity sensitivity of the Amplitude Envelope Generator's output level. Positive settings will cause the output level to rise the harder you play the keyboard and, conversely, negative values will cause it to fall. Settings: -64 – 0 – +63
--------------	--

[SF3] AEG (Amplitude Envelope Generator)

AttackTime	Settings: 0 – 127
Decay1Time	Settings: 0 – 127
Decay1Lvl (Level)	Settings: 0 – 127
Decay2Time	<p>Settings: 0 – 126, hold</p> <div style="display: flex; justify-content: space-around;"> <div style="text-align: center;"> <p>Decay2Time = 0 – 126</p> </div> <div style="text-align: center;"> <p>Decay2Time = hold</p> </div> </div>

[F6] EQ (Equalizer)

Same as in Normal Voice Element Edit. See page 164.
NOTE This parameter is available when the Type is set to “pre wav” in the [F1] OSC → [SF1] WAVE display.

Voice Job mode

[VOICE] → Voice selection → [JOB]

The Voice Job mode features several basic operations, such as Initialize and Copy. After setting parameters as required from the selected display, press the [ENTER] button to execute the Job.

[F1] INIT (Initialize)

This function lets you reset (initialize) all Voice parameters to their default settings. It also allows you to selectively initialize certain parameters, such as Common settings, settings for each Element/Drum key, and so on—very useful when creating a completely new Voice from scratch.

Type of parameter to be initialized

All: All data in the Common Edit and Element (Key) Edit modes
 Common: Data in the Common Edit mode
 EL (1 – 4): Data of the corresponding Element Edit parameters
 If “without Wave” is checked, the waves assigned to the Elements (Keys) will not be initialized.

NOTE In order to select “Common,” “EL,” or “without Wave,” the “ALL” box must be unchecked.
NOTE If you turn the check mark on when a Drum Voice is selected, you can select a specific Drum Key.

[F2] RECALL (Edit Recall)

If you are editing a Voice and select a different Voice without storing your edited one, all the edits you’ve made will be erased. If this happens, you can use Edit Recall to restore the Voice with your latest edits intact.

[F3] COPY

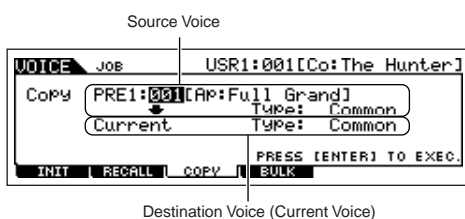

From this display you can copy Common and Element/Drum Key parameter settings from any Voice to the Voice you are editing. This is useful if you are creating a Voice and wish to use some parameter settings from another Voice.

Data type to be copied (Type)

Common: Data in the Common Edit mode
 Element (1 – 4): Data of the corresponding Element Edit parameters
 Key C0 – C6: Data of the corresponding Key Edit parameters

Copy procedure

1. Select the Source Voice.
 When “Current” is selected in the Source Voice, the Source Voice will be same as the Destination Voice. If you wish to copy one Element to another Element in the same Voice, select “Current.”
2. Select the Destination Voice (Current Voice).
 If the Source Voice type (Normal/Drum) differs from that of the Voice you are currently editing (destination), you will only be able to copy the Common parameters.
3. When “Element” or “Key” is selected in the Source Voice, select the Part/Key to be copied in the Destination Voice.
4. Press the [ENTER] button.

[F4] BULK (Bulk Dump)

This function lets you send all your edited parameter settings for the currently selected Voice to a computer or another MIDI instrument for data archiving. For details, see page 148.

NOTE In order to execute Bulk Dump, you’ll need to set the correct MIDI Device Number, with the following operation: [UTILITY] → [F5] MIDI → [SF1] CH → DeviceNo.

Voice Store mode

[VOICE] → Voice selection → [STORE]

This function lets you store your edited Voice to User memory. For details, refer to page 60 in the Quick Guide section.

Supplementary information

Micro Tuning List

[VOICE] → [EDIT] → [COMMON] → [F1] GENERAL → [SF2] PLY MODE → M.TuningNo./M.TuningRoot (page 153)

M.TuningNo.	Type	M.TuningRoot	Comments
00	Equal Temp (Equal temperament)	--	The "compromise" tuning used for most of the last 200 years of Western music, and found on most electronic keyboards. Each half step is exactly 1/12 of an octave, and music can be played in any key with identical pitch relationships. However, none of the intervals are perfectly in tune.
01	PureMaj (Pure major)	C – B	This tuning is designed so that most of the intervals (especially the major third and perfect fifth) in the major scale are pure. This means that other intervals will be correspondingly out of tune. You need to specify the key (C – B) you will be playing in.
02	PureMin (Pure minor)	C – B	The same as Pure Major, but designed for the minor scale.
03	Werckmeist (Werckmeister)	C – B	Andreas Werckmeister, a contemporary of Bach, designed this tuning so that keyboard instruments could be played in any key. Each key has a unique character.
04	Kirnberger	C – B	Johann Philipp Kirnberger, an 18th century composer, created this tempered scale to allow performances in any key.
05	Vallot&Yng (Vallotti & Young)	C – B	Francescatonio Vallotti and Thomas Young (both mid-1700s) devised this adjustment to the Pythagorean tuning, in which the first six fifths are lower by the same amount.
06	1/4 Shift (1/4 shifted)	--	This is the normal equal tempered scale shifted up 50 cents.
07	1/4 tone	--	Twenty-four equally spaced notes per octave. (Octaves are 24 notes apart.)
08	1/8 tone	--	Forty-eight equally spaced notes per octave. (Octaves are 48 notes apart.)
09	Indian	--	Designed for use Indian music (white keys only).
10	Arabic 1	C – B	Designed for use Arabic music.
11	Arabic 2		
12	Arabic 3		

Setting example of Filter Scaling

[VOICE] → [EDIT] → Element selection → [F3] FILTER → [SF5] SCALE (page 161)

The best way to understand Filter Scaling is by example. For the settings shown in the example display below, the basic Cutoff frequency value is 64, and the various Offset values at the selected Break point settings change that basic value accordingly. The specific changes to the Cutoff frequency are shown in the diagram below. The Cutoff frequency changes in a linear fashion between successive Break Points as shown.

VOICE		EL1		USR1:001[Co:The Hunter]			
		1	2	3	4		
BREAKPOINT		C#1	D#2	C 3	A 4		
OFFSET		- 4	+ 10	+ 17	+ 4		
TYPE		VEL SENS	REG	KEVFLW	[SCALE] KBD		
OSC		PITCH	FILTER	AMP	LFO	ER	

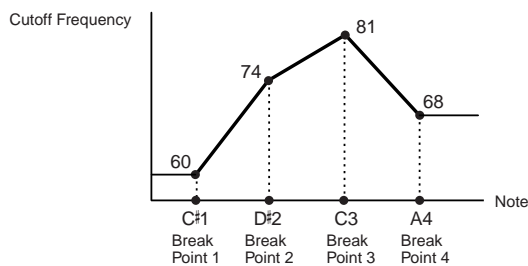

Setting example of Amplitude Scaling

[VOICE] → [EDIT] → Element selection → [F4] AMP → [SF5] SCALE (page 163)

The best way to understand Amplitude Scaling is by example. For the settings shown in the example display above, the basic Amplitude (volume) value for the selected Element is 80, and the various Offset values at the selected Break point settings change that basic value accordingly. The specific changes to the Amplitude are shown in the diagram below. The Amplitude changes in a linear fashion between successive Break Points as shown.

VOICE		EL1		USR1:001[Co:The Hunter]			
		1	2	3	4		
BREAKPOINT		C 1	C 2	D 4	D 6		
OFFSET		- 4	+ 10	+ 17	+ 4		
LVL/PAN		VEL SENS	REG	KEVFLW	[SCALE] KBD		
OSC		PITCH	FILTER	AMP	LFO	ER	

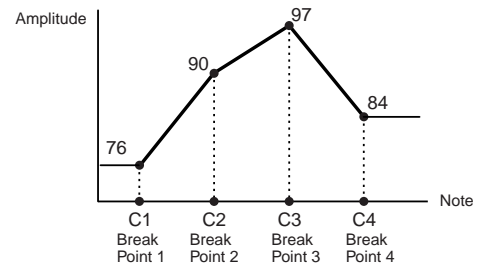

Filter Type List

[VOICE] → [EDIT] → Element selection → [F3] FILTER → [SF1] TYPE → Type (page 160)

LPF24D (24dB/oct Digital Low Pass Filter)

A dynamic 24dB/oct low-pass filter with a characteristic digital sound. Compared to the LPF24A type (below), this filter can produce a more pronounced resonance effect.

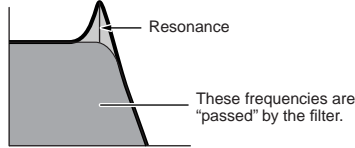

LPF24A (24dB/oct Analog Low Pass Filter)

A digital dynamic low-pass filter with characteristics similar to a 4-pole analog synth filter.

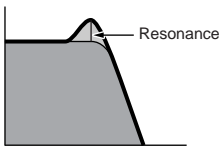

LPF18 (18dB/oct Low Pass Filter)

3-pole 18dB/oct low-pass filter.

LPF18s (18dB/oct Staggered Low Pass Filter)

3-pole 18dB/oct low-pass filter. This filter has a smoother cutoff slope than the LPF18 type.

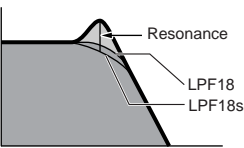

LPF12 (12dB/oct Low Pass Filter)

12dB/oct low-pass filter. This filter is designed to be used in conjunction with a high-pass filter.

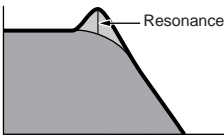

LPF6 (6dB/oct low-pass Filter)

1-pole 6dB/oct low-pass filter. No resonance. This filter is designed to be used in conjunction with a high-pass filter.

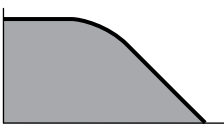

HPF24D (24dB/oct Digital High Pass Filter)

A dynamic 24dB/oct high-pass filter with a characteristic digital sound. This filter can produce a pronounced resonance effect.

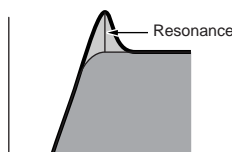

HPF12 (12dB/oct High Pass Filter)

12dB/oct dynamic high-pass filter.

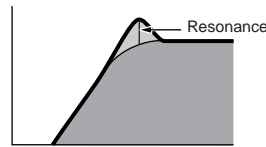

BPF12D (12dB/oct Digital Band Pass Filter)

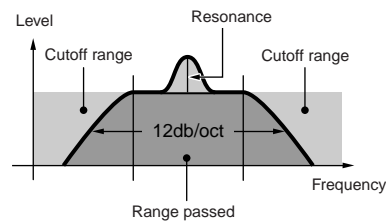

BPFw (Wide Band Pass Filter)

A 12dB/oct BPF that combines HPF and LPF filters to allow wider bandwidth settings.

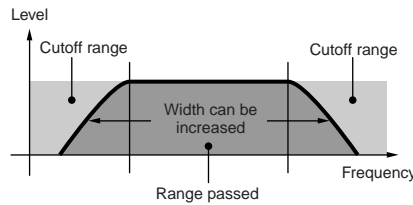

BPF6 (6dB/oct Band Pass Filter)

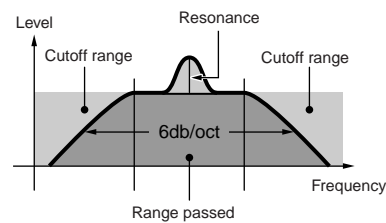

BEF12 (12dB/oct Band Elimination Filter)
BEF6 (6dB/oct Band Elimination Filter)

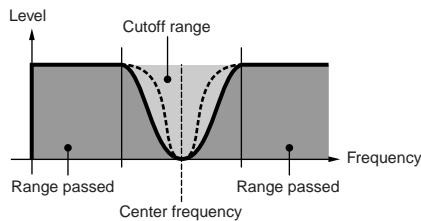

Dual LPF (Dual Low Pass Filter)

Two 12dB/oct low-pass filters connected in parallel.

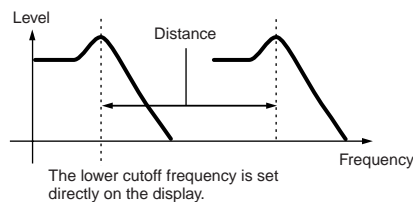

Dual HPF (Dual High Pass Filter)

Two 12dB/oct high-pass filters connected in parallel.

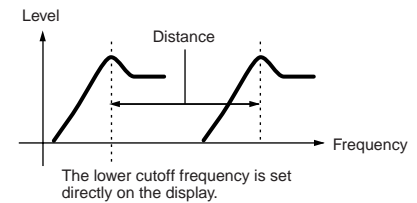

Dual BPF (Dual Band Pass Filter)

Two 6dB/oct band-pass filters connected in parallel.

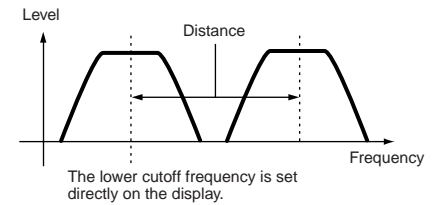

Dual BEF (Dual Band Elimination Filter)

Two 6dB/oct band-elimination filters connected in serial.

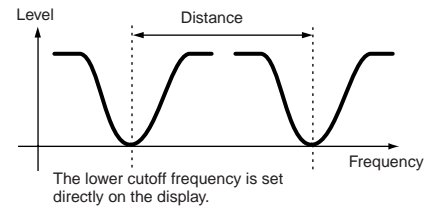

LPF12 + BPF6 (12dB/oct Low Pass Filter + 6dB/oct Band Pass Filter)

A combined low-pass and high-pass filter.

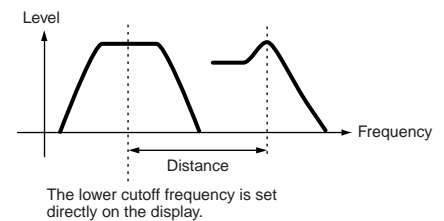

thru

The filters are bypassed and the entire signal is unaffected.

Voice mode

Performance mode

Song mode

Pattern mode

Mixing Voice mode

Utility mode

File mode

Master mode

Performance mode

Performance Play mode

[PERFORM] → Performance selection

The Performance Play mode lets you perform a variety of general editing operations on the selected Performance. For more detailed and comprehensive editing operations, use the Performance Edit mode. Edited parameters with the exception of some parameters are stored to internal Flash ROM as a User Performance.

NOTE The parameters that have the same name in the Performance Play mode and in the Performance Edit mode have the same functions and settings.

[F1] PLAY	
TCH (Transmit Channel)	Same as in Voice Play mode. These parameters are available both in the Voice mode and the Performance mode regardless of the selected Voice or Performance.
OCT (Octave)	
ASA (ASSIGN A), ASB (ASSIGN B)	
NOTE TCH (Transmit Channel), OCT (Octave), ASA (ASSIGN A), and ASB (ASSIGN B) settings do not belong to each Performance. Because of this, these are not stored as an individual Performance in the Performance Store mode (page 177).	
AS1 (ASSIGN 1), AS2 (ASSIGN 2)	Indicates the values obtained by controlling the respective Knobs (printed "ASSIGN 1" and "ASSIGN 2"). The functions assigned to these Knobs depend on the setting of the Voice assigned to each Part of the Performance.
[SF1] ARP1 (Arpeggio 1) – [SF5] ARP5 (Arpeggio 5)	You can register the desired Arpeggio types to these buttons and call them up any time during your keyboard performance. Refer to page 48 in the Quick Guide section.
[F2] VOICE	
From this display you can select a Voice for each Part and determine the note range it can be played from.	
[SF1] ADD	Press this button to assign a Voice to the selected Part.
[SF3] DELETE	Pressing this button deletes the Voice assignment for the selected Part, leaving the Part blank.
[SF4] LIMIT L (Note Limit Low)	This sets the lowest note of the range over which the voice of the selected part sounds. Simultaneously hold down this button and press the desired key on the keyboard to set the note.
[SF5] LIMIT H (Note Limit High)	This sets the highest note of the range over which the voice of the selected part sounds. Simultaneously hold down this button and press the desired key on the keyboard to set the note.
[F3] EFFECT	
Pressing the [F3] EFFECT button in the Performance Play mode calls up the same EFFECT display in the Performance Edit mode ([PERFORM] → [EDIT] → [COMMON] → [F6] EFFECT). From this display, you can set the effect related parameters for the current Performance.	
[F4] PORTA (Portamento)	
From this display you can set the Portamento parameters for each part. Portamento is used to create a smooth transition in pitch from the first note played on the keyboard to the next.	
PortaSw (Portamento Switch)	Determines whether Portamento is on or off for all Parts. Settings: off, on
PortaTime (Portamento Time)	Determines the pitch transition time. This parameter offsets the same parameter in the part edit (page 174). Higher values result in longer transition times. Settings: -64 – 0 – +63
PartSwitch	Determines whether Portamento is on or off for each individual Part. This is available only when the PortaSw (above) is set to on.
[F5] EG (Envelope Generator)	
This display contains the basic EG settings, both volume and filter. The settings made here are applied as offsets to the AEG and FEG settings in the Performance Edit mode (page 176). The parameters are the same as in the Voice Play mode. See page 152.	
[F6] ARP (Arpeggio)	
This display contains the basic settings for Arpeggio playback, including Type and Tempo. Note that the Performance mode lets you independently enable or disable Arpeggio playback for each Part. The parameters are the same as in the Voice Play mode (page 152) except for PartSw below.	
PartSw	Determines whether Arpeggio is on or off for the selected Part. The Parts for which boxes are checkmarked are enabled for Arpeggio play.

Voice mode

Performance mode

Song mode

Pattern mode

Mixing Voice mode

Utility mode

File mode

Master mode

Reference

Performance Edit mode

[PERFORM] → Performance selection → [EDIT]

Voice Edit parameters are divided into Common Edit (parameters common to all four Parts), and Part Edit (parameters of individual Parts).

Common Edit	[PERFORM] → Performance selection → [EDIT] → [COMMON]
--------------------	---

These parameters are for making global (or common) edits to all four Parts of the selected Performance.

[F1] GENERAL

[SF1] NAME	From this display you can assign the category (sub and main) of the selected Performance, and create a name for the Performance. The Performance name can contain up to 10 characters. For specific instructions on naming, see Basic Operation on page 38.
[SF3] MEQ OFS (Master EQ Offset)	Determines the offset values of the Master EQ in the [F2] OUT/MEF → [SF2] MEQ display. The level of each of the four bands (with the exception of "MID") can be adjusted. Moreover, you can also tweak these settings directly from the four Knobs on the front panel when the [EQ] button is turned on.
[SF4] PORTA (Portamento)	This display allows you to set the Portamento related parameters. The parameters are the same as in the Performance Play mode. See page 171.
[SF5] OTHER	From this display you can set the control functions for the Knobs and related parameters. With the exception of Pitch Bend, which cannot be set here, these parameters are the same as in the Voice Edit mode (page 154).

[F2] OUT/MEF (Output/Master Effect)

[SF1] OUT (Output)	
Volume	Determines the output level of the selected Performance. You can adjust the overall volume, keeping the balance between all Parts. Settings: 0 – 127
Pan	Determines the stereo pan position of the selected Performance. This parameter offsets the same parameter in the part edit setting. When the [PAN/SEND] button is turned on, you can also adjust this parameter using the Knob. Settings: L63 (far left) – C (center) – R63 (far right) NOTE A setting of "C" (center) maintains the individual Pan settings of each Part.
RevSend (Reverb send)	Determines the Send level of the signal sent from Insertion Effect A/B (or the bypassed signal) to the Reverb effect. When the [PAN/SEND] button is turned on, you can also adjust this parameter using the Knob. Settings: 0 – 127
ChoSend (Chorus send)	Determines the Send level of the signal sent from Insertion Effect A/B (or the bypassed signal) to the Chorus effect. When the [PAN/SEND] button is turned on, you can also adjust this parameter using the Knob. Settings: 0 – 127

NOTE For details on the Effect connections in the Performance mode, see page 143.

[SF2] MEQ (Master EQ)	
	From this display you can apply five-band equalization to all Parts of the selected Performance. You can raise or lower the signal level at the Frequency of each band (LOW, LOWMID, MID, HIGHMID, HIGH).
SHAPE	Determines whether the equalizer type used is Shelving or Peaking. The Peaking type attenuates/boosts the signal at the specified Frequency setting, whereas the Shelving type attenuates/boosts the signal at frequencies above or below the specified Frequency setting. This parameter is available only for the LOW and HIGH frequency bands. Settings: shelv (Shelving type), peak (Peaking type)
FREQ (Frequency)	Determines the center frequency. Frequencies around this point are attenuated/boosted by the Gain setting. Settings: LOW: Shelving 32Hz – 2.0kHz, Peaking 63Hz – 2.0kHz LOWMID, MID, HIGHMID: 100Hz – 10.0kHz HIGH: 500Hz – 16.0kHz
GAIN	Determines the level gain for the Frequency (set above), or the amount the selected frequency band is attenuated or boosted. Settings: -12dB – 0dB – +12dB
Q (Frequency Characteristic)	This varies the signal level at the Frequency setting to create various frequency curve characteristics. Settings: 0.1 – 12.0

NOTE For details on the EQ, see page 141.

[SF3] MEF (Master Effect)	
	From this display you can set the Master Effect related parameters.
Switch	Determines whether Master Effect is applied or not to the selected Performance. Settings: off, on
Type	Determines the Master Effect type. Settings: Refer to the Effect Types list in the separate Data List booklet.

NOTE The available parameters except for the above two differ depending on the currently selected effect type. Refer to the separate Data List booklet for details.

Voice mode

Performance mode

Song mode

Pattern mode

Mixing Voice mode

Utility mode

File mode

Master mode

Reference

[F3] ARP (Arpeggio)

From this display you can set the Arpeggio related parameters.

[SF1] TYPE	Same as in Normal Voice Common Edit. See page 154.
[SF2] LIMIT	
[SF3] PLAY FX (Play Effect)	
[SF4] OUT CH (Output Channel)	From this display you can set a separate MIDI output channel for the Arpeggio playback data, letting you have the Arpeggio sound from an external tone generator or synthesizer.
OutputSwitch	When this is set to on, Arpeggio playback data is output via MIDI. Settings: on, off
TransmitCh	Determines the MIDI transmit channel for Arpeggio playback data. When set to "KbdCh," the Arpeggio playback data is output via the MIDI Keyboard Transmit Channel ([UTILITY] → [F5] MIDI → KBDTransCh). Settings: 1 – 16, KbdCh (Keyboard Channel)

[F4] CTL ASN (Controller Assign)

You can assign Control Change numbers to the controllers listed below, letting you use the hardware controllers on the keyboard to alter the sound of external MIDI devices, via the appropriate MIDI messages. When the MO receives Control Change data corresponding to the settings here, the internal tone generator responds as if the instrument's controllers were used.

BC (Breath Controller)	The MO does not have a jack to connect a Breath Controller. However, the MO responds as if a Breath Controller was used when receiving Control Change messages over the Control Change number determined in this parameter.
RB (Ribbon Controller)	The MO does not have a Ribbon Controller. However, the MO responds as if a Ribbon Controller was used when receiving Control Change messages over the Control Change number determined in this parameter.
AS1 (Assign 1), AS2 (Assign 2)	Determines the Control Change number generated when you control the ASSGN 1 (Knob3) and the ASSIGN 2 (Knob4) with both the [PAN/SEND] and [TONE] lamp turned on.
FC1 (Foot Controller 1)	Determines the Control Change number generated when you use the Foot Controller connected to the FOOT CONTROLLER jack.
FC2 (Foot Controller 2)	The MO has only one jack for connection to a Foot Controller. However, the MO responds as if a 2nd Foot Controller was used when receiving Control Change messages over the Control Change number determined in this parameter.

NOTE Keep in mind that the functions of these controllers set here are not changed for the internal tone generator. The controller assignments for the MO itself depend on the settings of the Voices assigned to each Part.

[F6] EFFECT

This menu gives you comprehensive control over the effects. For details on the Effect connections in the Performance mode, see page 143.

[SF1] CONNECT (Connection)	For more information on parameters, refer to page 143.
[SF2] INS SW (Insertion Switch)	The Insertion Effects can be applied to up to three Parts. This display lets you set to which Parts the Insertion Effects are applied.
[SF4] REVERB	The number of parameters and values available differs depending on the currently selected effect type. Refer to the separate Data List booklet.
[SF5] CHORUS	

Part Edit	[PERFORM] → Performance selection → [EDIT] → Part selection
------------------	--

These parameters are for editing the individual Parts that make up a Performance.

[F1] VOICE	
[SF1] VOICE	
PartSw (Part Switch)	You can select a voice for each part. Set each pat to on or off. Settings: on, off
Bank	Determines the Voice Bank (page 40) for each Part.
Number	Determines the Voice Program number for each Part.
[SF2] MODE	
Mono/Poly	Determines the playback method of the Voice for each Part—monophonic (single notes only) or polyphonic (multiple notes). Settings: mono, poly NOTE This parameter is not available for the part to which the Drum Voice is assigned.
ArpSwitch (Arpeggio Switch)	Determines whether Arpeggio is on or off for the currently selected Part. Settings: on, off
[SF3] LIMIT	
NoteLimitH (Note Limit High)	Determines the lowest and highest notes of the keyboard range for each Part. Each Part will only sound for notes played within its specified range. Settings: C -2 – G8 NOTE If you specify the highest note first and the lowest note second, for example "C5 to C4," then the note range covered will be "C-2 to C4" and "C5 to G8." NOTE You can set the note by pressing the keyboard while holding the [INFORMATION] button.
NoteLimitL (Note Limit Low)	
VelLimitH (Velocity Limit High)	Determines the minimum and maximum values of the velocity range within which each Part will respond. Each Part will only sound for notes played within its specified velocity range. Settings: 1 – 127 NOTE If you specify the maximum value first and the minimum value second, for example "93 to 34," then the velocity range covered will be "1 to 34" and "93 to 127."
VelLimitL (Velocity Limit Low)	
[SF4] PORTA (Portamento)	
Switch	Determines whether Portamento is on or off. Settings: off, on
Time	Determines the pitch transition time. Higher values result in a longer pitch change time. Settings: 0 – 127
Mode	Determines the Portamento mode. Settings: fingr (fingered), full (full time) fingr (fingered)..... Portamento is only applied when you play legato (playing the next note before releasing the previous one). full (full time)..... Portamento is always applied. NOTE These Portamento parameters above are not available for the part to which the Drum voice is assigned.
[SF5] OTHER	
PB (Pitch Bend) Upper, PB (Pitch Bend) Lower	Determines the amount and direction of Pitch Bend range. Details are same as that in the Common Edit parameters in Normal Voice mode (page 154).
VelSensDpt (Velocity Sensitivity Depth)	Determines the degree to which the resulting volume of the tone generator responds to your playing strength. The higher the value, the more the volume changes in response to your playing strength (as shown at right). Settings: 0 – 127

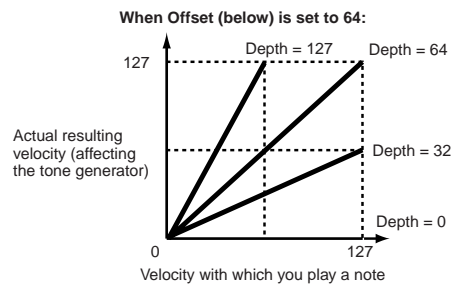

Reference
Voice mode
Performance mode
Song mode
Pattern mode
Mixing Voice mode
Utility mode
File mode
Master mode

<p>VelSensOfst (Velocity Sensitivity Offset)</p>	<p>Determines the amount by which played velocities are adjusted for the actual resulting velocity effect. This lets you raise or lower all velocities by the same amount—allowing you to automatically compensate for playing too strongly or too softly.</p> <p>Settings: 0 – 127</p> <div style="display: flex; justify-content: space-around;"> <div style="text-align: center;"> <p>When Depth (above) = 64 and Offset = 32</p> </div> <div style="text-align: center;"> <p>When Depth (above) = 64 and Offset = 64</p> </div> <div style="text-align: center;"> <p>When Depth (above) = 64 and Offset = 96</p> </div> </div>
---	--

[F2] OUTPUT

[SF1] VOL/PAN (Volume/Pan)	
Volume	Determines the volume for each part, allowing you to set the optimum level balance of all the Parts. Settings: 0 – 127
Pan	Determines the stereo pan position for each Part. Settings: L63 (far left) – C (center) – R63 (far right)
VoiceELPan (Voice Element Pan)	Determines whether the individual pan settings for each Voice (made via [VOICE] → [EDIT] → Element selection → [F4] AMP → [SF1] LVL/PAN → Pan) are applied or not. When this is set to “off,” the basic pan position for the selected Part is set to center. Settings: on, off
[SF2] EF SEND (Effect Send)	
RevSend (Reverb Send)	Determines the send level for the Reverb effect of the selected Part, giving you detailed control over the Reverb balance among the Parts. Settings: 0 – 127
ChoSend (Chorus Send)	Determines the send level for the Chorus effect of the selected Part, giving you detailed control over the Chorus balance among the Parts. Settings: 0 – 127
Dry Level	Determines the level of the unprocessed (dry) sound of the selected Part, letting you control the overall effect balance among the Parts. Settings: 0 – 127
[SF3] SELECT (Output Select)	
InsEF (Insertion Effect)	Determines whether the Insertion effects are applied to the output signal from the rear panel or not. Settings: on, off

[F3] EQ (Equalizer)

From this display you can adjust the EQ settings for each Part. Note that two different display types listed below are provided and you can switch between them by pressing the [SF5] button. Each display type features the same settings in a different format; use the type you feel most comfortable with.

- Display showing four Parts
- Display showing all parameters for one Part

Keep in mind that since all the available parameters cannot be simultaneously displayed in the four-Part display, you will need to use the cursor controls to scroll the display in order to see and set the other parameters.

For details about the Effect connection including the EQ in the Performance mode, see page 143.

LowFreq (Low Frequency)	Determines the center frequency of the low EQ band that is attenuated/boosted. Settings: 50.1 – 2.00K
LowGain (Low Gain)	Determines the amount of boost or attenuation applied to the low EQ band. Settings: -32 – +32
MidFreq (Middle Frequency)	Determines the center frequency of the middle EQ band that is attenuated/boosted. Settings: 139.7 – 10.1K
MidGain (Middle Gain)	Determines the amount of boost or attenuation applied to the middle EQ band. Settings: -32 – +32
MidReso (Middle Resonance)	Determines the resonance applied to the center frequency of the middle EQ band. Settings: 0 – 31
HighFreq (High Frequency)	Determines the center frequency of the high EQ band that is attenuated/boosted. Settings: 503.8 – 14.0K
HighGain (High Gain)	Determines the amount of boost or attenuation applied to the high EQ band. Settings: -32 – +32

Voice mode
 Performance mode
 Song mode
 Pattern mode
 Mixing Voice mode
 Utility mode
 File mode
 Master mode

Reference

[F4] TONE

You can set parameters related to the pitch and tone for each Part. Keep in mind that the settings made here are applied as offsets to the Voice Edit settings.

[SF1] TUNE

NoteShift Determines the pitch (key transpose) setting for each Part in semitones.
Settings: -24 – 0 – +24

Detune Determines the fine tuning for each part.
Settings: -12.8Hz – +12.7Hz

[SF2] FILTER

Keep in mind that the settings made here are applied as offsets to the filter settings in the Element Edit parameters of each Part's Voice.

Cutoff Determines the cutoff frequency for each Part. This parameter is available for the LPF when the filter used by the part is a combination type of LPF and HPF.
Settings: -64 – 0 – +63

Resonance Determines the amount of filter resonance or emphasis of the Cutoff Frequency for each Part.
Settings: -64 – 0 – +63

FEGDepth Determines the Filter Envelope Generator depth (amount of Cutoff Frequency) for each Part.
Settings: -64 – 0 – +63
NOTE For details about Filter, see page 133.

[SF3] FEG (Filter Envelope Generator)

From this display you can set the FEG (Filter Envelope Generator) parameters for each Part. Keep in mind that the settings made here are applied as offsets to the filter settings in the Element Edit parameters of each Part's Voice.

Attack (Attack Time) Determines each parameter of the FEG for each Part. For details about FEG, see page 133.

Decay (Decay Time) **Settings:** -64 – 0 – +63
NOTE These parameters are not available for the Drum Voice Parts.

Sustain (Sustain Level)

Release (Release Level)

[SF4] AEG (Amplitude Envelope Generator)

From this display you can set the AEG (Amplitude Envelope Generator) parameters for each Part. Keep in mind that the settings made here are applied as offsets to the filter settings in the Element Edit parameters of each Part's Voice.

Attack (Attack Time) Determines each parameter of the AEG for each Part. For details about AEG, see page 134.

Decay (Decay Time) **Settings:** -64 – 0 – +63
NOTE The Sustain and Release parameters are not available for the Drum Voice Parts.

Sustain (Sustain Level)

Release (Release Level)

[F5] RCV SW (Receive Switch)

From this display you can set how each individual Part responds to various MIDI data, such as Control Change and Program Change messages. When the relevant parameter is set to "on," the corresponding Part responds to the appropriate MIDI data.

Note that two different display types listed below are provided and you can switch between them by pressing the [SF5] button. Each display type features the same settings in a different format; use the type you feel most comfortable with.

- Display showing four Parts
- Display showing all parameters for one Part

Keep in mind that since all the available parameters cannot be simultaneously displayed in the four-Part display, you will need to use the cursor controls to scroll the display in order to see and set the other parameters.

Settings: See below.

CtrlChange (Control Change) Indicates all the Control Change messages.

PB (Pitch Bend) MIDI messages generated by using the Pitch Bend Wheel.

MW (Modulation Wheel) MIDI messages generated by using the Modulation Wheel.

RB (Ribbon Controller) MIDI messages for Ribbon Controller.

ChAT (Channel Aftertouch) MIDI messages for Channel Aftertouch.

FC1 (Foot Controller 1) MIDI messages generated by using the optional Foot Controller connected to the rear panel.

FC2 (Foot Controller 2) MIDI messages for Foot Controller 2.

Sus (Sustain) MIDI messages for Control Number 64 (Sustain). This parameter is not available for the Drum Voice Parts.

FS (Footswitch) MIDI messages generated by using the optional Footswitch connected to the FOOT SWITCH jack on the rear panel.

AS1 (Assign 1), AS2 (Assign 2) MIDI messages generated by using the ASSIGN 1 and ASSIGN 2 Knobs with both the [PAN/SEND] and [TONE] lamps turned on.

BC (Breath Controller) MIDI messages for Breath Controller.

Exp (Expression) MIDI messages (Expression) generated by using the optional Foot Controller connected to the rear panel.

Voice mode

Performance mode

Song mode

Pattern mode

Mixing Voice mode

Utility mode

File mode

Master mode

Reference

Performance Job mode**[PERFORM] → Performance selection → [JOB]**

The Performance Job mode features several basic operations, such as Initialize and Copy. After setting parameters as required from the selected display, press the [ENTER] button to execute the Job.

[F1] INIT (Initialize)

This function lets you reset (initialize) all Performance parameters to their default settings. It also allows you to selectively initialize certain parameters, such as Common settings, settings for each Part, and so on—very useful when creating a completely new Performance from scratch.

Type of parameter to be initialized

All: All data in the Performance
 Common: Data in the Common Edit mode
 Part 1 – 4: Data of the Part Edit parameters of the corresponding internal Part

NOTE In order to select “Common” or “Part,” the “ALL” box must be unchecked.

[F2] RECALL (Edit Recall)

If you are editing a Performance and select a different Performance without storing your edited one, all the edits you’ve made will be erased. If this happens, you can use Edit Recall to restore the Performance with your latest edits intact.

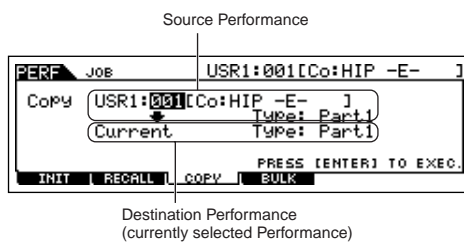
[F3] COPY

You can copy Part parameter settings from any Performance to a particular Part of the Performance you are editing. This is useful if you are creating a Performance and wish to use some parameter settings from another Performance.

Data type to be copied (Type)

Part 1 – 4: Data of the Part Edit parameters of the corresponding internal Part

Copy procedure

1. Select the Source Performance.
 When “Current” is selected in the Source Performance, the Source Performance will be same as Destination Performance. If you wish to copy one Part to another Part in same Performance, select “Current.”
2. Select the type of Source Performance (data that you want to copy).
3. Select which Parts will be replaced by the copied Part in the Destination Performance parameter.
 If you choose Arp (Arpeggio) or Effect, the Arpeggio data or Effect settings for the Voice assigned to the Source Part will be copied.
4. Press the [ENTER] button.

[F4] BULK (Bulk Dump)

This function lets you send all your edited parameter settings for the currently selected Performance to a computer or another MIDI instrument for data archiving. For details, see page 148.

NOTE In order to execute Bulk Dump, you’ll need to set the correct MIDI Device Number, with the following operation: [UTILITY] → [F5] MIDI → [SF1] CH → DeviceNo.

Performance Store mode**[PERFORM] → Performance selection → [STORE]**

This function lets you store your edited Performance to User memory. For details, refer to page 66 in the Quick Guide section.

Song mode

■ Creating Songs—basic procedure

Songs consist of the following three types of data:

- MIDI sequence data (created in the Song Record mode, Song Edit mode, and Song Job mode)
- Setup data (created in the Song Play mode)
- Mixing data (created in the Song Mixing mode/Mixing Edit mode and stored in the Song Mixing Store mode)

After creating the data in these modes described above, store the Mixing settings in the Song Mixing Store mode to archive it as Song data and save the entire Song to the USB storage device in the File mode.

NOTE Non-note MIDI events (such as Voice number, volume, pan, and effect send level) which are necessary at the start of a Song are not recorded as MIDI sequence data, but are stored instead as Mixing data.

⚠ CAUTION

Because Song data (MIDI sequence data, Setup data, and Mixing data) is recorded to DRAM (page 150), it will be lost when turning the power off. Make sure to save any Song data created via the Record, Edit, Job, and Mixing setting to the USB storage device in the File mode before turning the power off. For details on saving Song data, see page 211.

Song Play mode

[SONG] → Song selection

[F1] PLAY

Loc1 (Location 1), Loc2 (Location 2)	Indicates the measure number to which the Song playback can be jumped by using the Location feature (page 92).
Trans (Transpose)	Determines the key transpose setting for the entire Song, and can be adjusted in semitones. Settings: -36 – +36 NOTE If the Pattern includes a track that you do not want to transpose, set the Note Shift parameter for each Part ([SONG] → [MIXING] → [EDIT] → Part selection → [F4] TONE → [SF1] TUNE → NoteShift).
MEAS (Measure)	Indicates the current measure number and beat for the current Song. During playback, this indication changes automatically according to the Song playback. You can input the desired measure number directly by using the Number Input window called up via the [INFORMATION] button.
[SF1] ARP1 (Arpeggio 1) – [SF5] ARP5 (Arpeggio 5)	You can register the desired Arpeggio types and Song Scenes to these buttons and call them up any time during your keyboard performance. Refer to page 89 in the Quick Guide section.

[F2] GROOVE (Grid Groove)

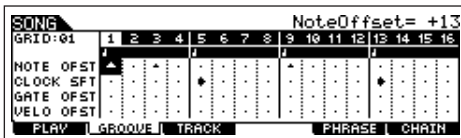

The Grid Groove function makes it possible to adjust the pitch, timing, length, and velocity of notes in a specified track via a 1-measure 16th-note grid to create "grooves" that would not be possible with precise sequencer-like programming. The Grid Groove function affects Song playback without actually changing the sequence data.

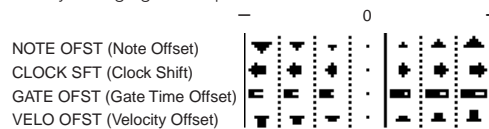

NOTE OFST (Note Offset)	Raises or lowers the pitch of the note(s) on the selected grid in semitones. Settings: -99 – +99
CLOCK SFT (Clock Shift)	Shifts the timing of the note(s) on the selected grid forward or back ward in clock increments. Settings: -120 – +120
GATE OFST (Gate time Offset)	Lengthens or shortens the note(s) on the selected grid in clock increments. Settings: -120 – +120
VELO OFST (Velocity Offset)	Increases or decreases the velocity of the note(s) on the selected grid. Settings: -127 – +127

[F3] TRACK

[SF1] CHANNEL	From this display you can set the MIDI output channel/port for each of the sixteen tracks of the corresponding internal/external tone generator. You can also simultaneously set multiple tracks (tracks 1 – 8 or tracks 9 – 16) to the same value as the currently selected track, by changing the parameter while holding the [SF2] 1 – 8 button or [SF3] 9 – 16 button.
OUT CH (Output Channel)	Sets up the MIDI output channel for each track. Tracks set to "Off" will not sound. Settings: off, 01 – 16 NOTE In the Song/Pattern mode, the MIDI message created by playing the keyboard/knobs/wheels is sent to the tone generator block or the external MIDI instruments via the MIDI output channel of the currently selected track.

Voice mode

Performance mode

Song mode

Pattern mode

Mixing Voice mode

Utility mode

File mode

Master mode

Reference

PORT	Determines the MIDI transmission port for the corresponding track. Playback data of tracks set to off is output via MIDI without any Port message. The internal tone generator parts of this synthesizer can be played back only over Port 1. Settings: off, 1 – 3 NOTE Port data can be output only through the USB terminal. No port data is transmitted through the MIDI OUT terminal, even if the corresponding track is set to a specific port number.
[SF2] OUT SW (Output Switch)	You can also simultaneously set multiple tracks (tracks 1 – 8 or tracks 9 – 16) to the same setting as the currently selected track, by changing the parameter while holding the [SF2] 1 – 8 button or [SF3] 9 – 16 button.
INT SW (Internal Switch)	Determines whether playback data is transmitted to the internal tone generator block or not. Settings: on, off
EXT SW (External Switch)	Determines whether playback data is output to the external MIDI tone generator via MIDI or not. Settings: on, off
[SF3] TR LOOP (Track Loop)	From this display you can determine whether the data in the selected track loops or not in playback. Using Loop can be an effective way to repeat short patterns and phrases throughout the Song. For details, see page 193. Settings: off, on

[F5] PHRASE

Specify the source phrase from the Preset Phrases (Dr1 – Dr4) and the User Phrases in the previously selected Pattern.

You can copy any of the Preset Phrases (Dr1 – Dr4) and User Phrases in the previously selected Pattern to the track of the currently selected song.

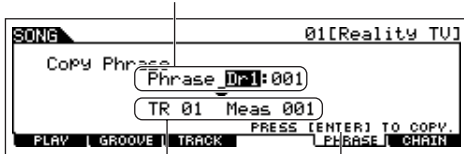

Specify the destination track and measure of the current selected song.

After completing the settings, press the [ENTER] button to execute Copy Phrase.

[F6] CHAIN

This function allows Songs to be “chained” together for automatic sequential playback. For details, refer to the Quick Guide on page 95.

- skip** Skips past (ignores) the selected chain number and continues playback from the next chain number.
- stop** Stops Song chain playback at that chain number. You can restart the Song chain playback from the next chain number by pressing the [▶] (Play) button.
- end** Indicates the end mark of the Song chain data.

Song Record mode [SONG] → Song selection → [REC]

Song Record Standby mode

[F1] SETUP

Type (Recording Type)	Determines the recording method. For details on each method, refer to page 138 in the Basic Structure section. Settings: When the RecTrack is set to any of 1-16: replace, overdub, punch, step When the RecTrack is set to tempo: replace, punch, step When the RecTrack is set to scene: replace, punch When the RecTrack is set to multi: replace, overdub, punch NOTE When “punch” is selected, “Punch-in measure: beat” and “Punch-out measure: beat” appear in the display and should be set. If you’ve set the Locate 1 and 2 points (Loc1, Loc2; see page 92), the punch-in/out points can be set with a single button press. Move the cursor to the punch-in/out value, and notice that a “COPYLOC” menu item appears. Press the [SF1] COPYLOC button, and the punch-in/out settings are automatically assigned to the existing Locate points. NOTE When “step” is selected, you should specify the event type to be entered.
Quantize	This parameter is available when the Recording Type is set to something other than “step.” Record quantize aligns the timing of notes automatically, as you record. You can set this parameter also by using the Note Type selection window called up via the [INFORMATION] button. For details, see page 35. Settings: off, 60 (32nd note), 80 (16th note triplet), 120 (16th note), 160 (8th note triplet), 240 (8th note), 320 (1/4 note triplet), 480 (1/4 note)
Event	This parameter is available when the Recording Type is set to “step.” This lets you specify the event type to be entered. Settings: note, p.bend (pitch bend), CC#000 – #119 (Control Change)
RecTrack	Determines the track to be recorded. Pressing the [F6] button lets you switch between Single Track recording and All Track recording. Settings: tempo, scene, 1 – 16, multi

Voice mode
Performance mode
Song mode
Pattern mode
Mixing Voice mode
Utility mode
File mode
Master mode
Reference

♩ (Tempo)	Determines the Song tempo. Settings: 001.0 – 300.0
Meas (Measure)	Determines the measure from which Song recording will be started.

[F2] VOICE

In this display you can set the voice related parameters for the recording track. The settings here affect the Part for which the receive channel (set in the Mixing mode) matches the transmit (output) channel of the recording track.

Voice	Determines the voice used in the recording track. When the cursor is located here, you can select a voice by using the Bank, Group, Number buttons and the Category Search function (page 42).
Volume	Determines the volume of the recording track. Settings: 0 – 127
Pan	Determines the stereo pan position of the recording track. Settings: L63 (Left) – C (Center) – R63 (Right)
InsEF (Insertion Effect Part Switch)	Determines whether the Insertion effects are applied to the recording track or not. Settings: on, off
♩ (Tempo)	Determines the Song tempo. Settings: 001.0 – 300.0
Meas (Measure)	Determines the measure from which Song recording will be started.

[F3] ARP (Arpeggio)

From this display you can set parameters related to the Arpeggio of the recording track.

Bank, Ctgr (Category), Type	These three parameters determine the Arpeggio Type. The three-letter prefix number before the Type name indicates the number within the selected Category. Settings: Refer to the separate Data List.
VelLimit (Velocity Limit)	Determines the lowest and highest velocity which can trigger the Arpeggio playback. The Arpeggio plays when you play notes at velocities within this range. Settings: 1 – 127
Hold	Determines whether the Arpeggio playback is "held" or not. When this is set to "on," the Arpeggio cycles automatically, even if you release your fingers from the keys, and it continues to cycle until the next key is pressed. Settings: sync-off, off, on NOTE About sync-off, see page 154.
PartSw (Part Switch)	Determines whether Arpeggio is on or off for the tone generator Part corresponding to the recording track. Settings: off, on
Meas (Measure)	Determines the measure from which Song recording will be started. This parameter is same as the Meas parameter in the [F1] SETUP display.

[SF1] ARP1 (Arpeggio 1) – [SF5] ARP5 (Arpeggio 5) You can register the desired Arpeggio types and Song Scenes to these buttons and call them up any time during your keyboard performance. Refer to page 89 in the Quick Guide section.

[F4] RECARP (Record Arpeggio)

RecArp (Record Arpeggio)	Determines whether the sequence data played by Arpeggio is recorded to the Song track or not. When this is set to on, the played sequence data is recorded. Settings: off, on
OutputSwitch	Determines whether the sequence data played by Arpeggio during recording is output via MIDI or not. When this is set to on, the played sequence data by Arpeggio during recording is output via MIDI. Settings: off, on
TransmitCh (Transmit Channel)	Determines the MIDI transmit channel of the Arpeggio playback during recording. Settings: 1 – 16, KbdCh

[F5] CLICK

Pressing the [F5] button lets you turn the click sound (metronome) on/off for recording.

[F6] ALL TR (All Track)/1TR (1 track)

Pressing the [F6] button lets you switch between Single Track recording and All Track recording.

Voice mode

Performance mode

Song mode

Pattern mode

Mixing Voice mode

Utility mode

File mode

Master mode

Reference

During Song Recording

[SONG] → Song selection → [REC] → [▶] (Play)

Realtime Recording	Refer to page 88 in the Quick Guide section.
Step Recording	Examples of Step Recording are described on page 193.

[F1] SETUP

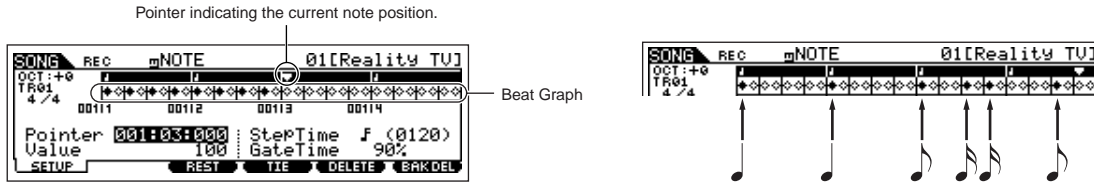

Beat Graph	This is the display in which notes are "placed" during step recording. When the meter is 4/4, the display is divided into four beats (one measure). Each diamond-shaped marker in the display represents one 32nd beat (each 1/4 note division is divided into eight 32nd beats). For example, if the following rhythmic pattern "♪♪♪♪♪" is entered in 4/4 time, a display like the one shown above right will appear.
Pointer	Determines the data-entry position. The triangular pointer above the beat graph indicates the data-entry position. To move the pointer right or left, use the [INC/YES] and [DEC/NO] buttons or the data dial.
Value	When the Event to be entered ([F1] SETUP → Event) is set to "note," this value specifies the velocity with which the note will be entered. Settings: When the Event is set to "note": 1 – 127, kbd, rnd1 – rnd4 When the Event is set to "p.bend": -8192 – +8191 When the Event is set to "CC (Control Change 001 – 119)": 000 – 127 When the Event is set to "tempo" with the RecTrack = tempo: 001 – 300 NOTE You can select "kbd" (keyboard) and "rnd1" – "rnd4" (random1 – 4) as well as the values 1 – 127 when the Event to be entered is set to "note." When "kbd" is selected, the actual playing strength will be entered as the velocity value. When one of the random settings is selected, a random velocity value will be entered.
StepTime	The "size" of the current recording step time for the next note to be entered. This determines to what position the pointer will advance after a note has been entered. Settings: 0001 – 0059, 32nd note, 16th note triplet, 16th note, 8th note triplet, 8th note, 1/4 note triplet, 1/4 note, half note, whole note
GateTime	Sets the gate time to produce slurs, staccato notes, etc. "Gate time" refers to the actual length of time the note sounds. For the same 1/4 note, for example, a long gate time will produce a slur while a short gate time will produce a staccato effect. Gate time is indicated as a percent value of the step time. A setting of 50% produces a staccato sound, values between about 80% and 90% produce normal note length, and a value of 99% will produce a slur. Settings: 1% – 200%

[F3] REST

Press [F3] to enter a rest as long as the specified step time. The point will move ahead to the next data-entry position. Rests do not appear on the display.
NOTE There is no actual data representing rests in the MIDI sequencer. When a "rest" is entered the pointer simply moves ahead to the next data-entry position, effectively leaving a rest.

[F4] TIE

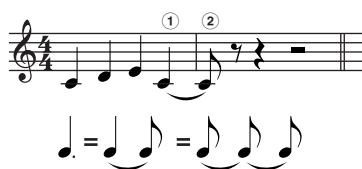

When the [F4] button is pressed to enter a tie, the preceding note is lengthened to the full step time. For example, in the phrase shown at left, note ① is entered with 1/4 note step time. If the step time is then changed to an 8th note and [F4] is pressed, note ② is entered.
Dotted notes can also be entered using the TIE function. To produce a dotted 1/4 note, for example, set the step time to an 8th note, enter a note and then press [F4] twice.
NOTE This display is available only when the Event to be entered is set to "note."

[F5] DELETE

Press this to actually delete the note events at the current cursor position.

[F6] BAK DEL (Back Delete)

Moves the pointer backward by one step and deletes all notes at that location.

NOTE Mistakenly entered notes can be erased by pressing [F6] immediately after they are entered (before changing the step time value).

Voice mode
Performance mode
Song mode
Pattern mode
Mixing Voice mode
Utility mode
File mode
Master mode
Reference

Song Edit mode

[SONG] → Song selection → [EDIT]

This mode gives you comprehensive, detailed controls for editing the MIDI events of individual Song tracks. MIDI events are messages (such as note on/off, note number, program change number, etc.) that make up the data of a recorded Song.

[F1] CHANGE

Shows the Event List of the selected Song track. For information on how to edit the Event List, see page 90.

[F2] VIEW FLT (View Filter)

The Event View Filter lets you select the event types that appear on the Event List display ([F1] CHANGE display). For example, if you wish to edit only note events, place a checkmark in the box next to "Note" so that only the note events appear in the Event List display.

Settings: Note, PitchBend, ProgramChange, ControlChange, Ch.AfterTouch, PolyAfterTouch, RPN (Registered Parameter Number), NRPN (Non Registered Parameter Number), Exclusive

[F5] CLR ALL (Clear All)	Press the [F5] button to remove all checkmarks at once.
[F6] SET ALL	Press the [F6] button to set checkmarks into all boxes.

[F4] TR SEL (Track Select)

You can switch between the display for 1 – 16 tracks, SCN (Scene) track, and TMP (Tempo) track by pressing this button.

[F5] INSERT

When the cursor is located at the desired position in the [F1] CHANGE display (Event List), pressing this button calls up the display for inserting new MIDI events in the Song mode or Pattern mode.

Note	This is the most common and prevalent type of data—the individual notes of a Song.
▶ NOTE (Note name)	Determines the note name or the specific keyboard pitch of the note. Settings: C -2 – G8
▶ GATE (Gate time)	Determines the length of time that a note actually sounds in beats and clocks. Settings: 00:001 – 999:479 NOTE On this synthesizer, one clock is 1/480th of a quarter note.
▶ VELO (Velocity)	Determines how strongly the selected note sounds. Settings: 1 – 127
PitchBend	These are the events that define continuous changes in pitch and these events are generated by Pitch Bend Wheel operation.
▶ DATA	Determines the Pitch Bend data. Settings: -8192 – +8191
ProgramChange	These events determine the Voice for the selected track.
▶ BANK	Determines the Voice bank. Settings: 000 – 127, *** NOTE Bank select MSB and LSB are actually part of the Control Change set of messages (below). However, since they apply specifically to Voice selection, they are grouped and described here.
▶ PC NO (Program Change Number)	Determines the specific Voice (from the bank selected by MSB and LSB above). Settings: 000 – 127 NOTE For a complete list of the available voice banks and numbers, refer to the Voice List in the separate Data List booklet.
ControlChange	These events control the sound and certain response characteristics of the voice, and are usually generated/recorded by moving a controller (such as a modulation wheel, knob, slider or foot controller).
▶ CTRL NO (Control Number)	Determines the Control Change number. Settings: 000 – 127 NOTE For details on the specific functions assigned to each of the numbers, see page 224.
▶ DATA	See page 224. Settings: 000 – 127
Ch.AfterTouch (Channel After Touch)	This event is generated when pressure is applied to a key after the note is played. NOTE The keyboard of the MO does not feature an Aftertouch function. However, you can insert Aftertouch events into the Song data from this display.
▶ DATA	This represents the amount of pressure applied to the key. Settings: 000 – 127
PolyAfterTouch (Polyphonic Aftertouch)	This event is generated when pressure is applied to a key after the note is played. Unlike Channel Aftertouch above, this is recorded and applied independently for each key pressed. NOTE The keyboard of the MO does not feature an Aftertouch function. However, you can insert Aftertouch events into the Song data from this display.
▶ NOTE (Note name)	Determines the key to which aftertouch is applied. Settings: C -2 – G8
▶ DATA	This represents the amount of pressure applied to the key. Settings: 000 – 127

RPN (Registered Parameter Number)	This event changes parameter values for each tone generator Part. This event is used to set Part settings such as Pitch Bend Sensitivity or Tuning.
▶ MSB-LSB	See page 225. Settings: 000 – 127
▶ DATA (Data Entry MSB-LSB)	See page 225. Settings: 000 – 127, ***
NOTE	Normally three types of control change data are sent: RPN MSB (101), RPN LSB (100), and Data Entry MSB (6). In this synthesizer, Data Entry LSB (38) is added to this and the resulting group of control change events is handled as one in this display.
NRPN (Non Registered Parameter Number)	These events are used to change the parameter values for each tone generator Part. They can be used to edit sounds via MIDI, allowing you to edit filter or EG settings, or adjust the pitch or level for each instrument of a drum voice.
▶ MSB-LSB	See page 225. Settings: 000 – 127
▶ DATA (Data Entry MSB-LSB)	See page 225. Settings: 000 – 127, ***
NOTE	Normally three types of control change data are sent: NRPN MSB (99), NRPN LSB (98), and Data Entry MSB (6). In this synthesizer, this group of control change events is handled as one in this display. For a complete list of the available RPN and NRPN numbers and their corresponding controls, refer to the MIDI Data Format in the separate Data List booklet.
Exclusive (System Exclusive)	A type of MIDI message used to exchange data unique to a specific model or type of device. Unlike other MIDI events, these events differ depending on the manufacturer/device, and are incompatible among different devices.
▶ DATA (HEX)	See page 226. Settings: 00 – 7F, F7 (Data must be entered in hexadecimal format.)

Song Job mode [SONG] → Song selection → [JOB]

The Song Job mode contains a comprehensive set of editing tools and data transform functions you can use to change the sound of the Song. It also includes a variety of convenient operations, such as copying or erasing data. After setting parameters as required from the selected display, press the [ENTER] button to execute the Job.

CAUTION

An “Executing...” message is shown when it takes a short amount of time to execute the Job. Never attempt to turn off the power while an “Executing...” message is shown. Turning the power off in this state results in loss of all user data.

[F1] UNDO/REDO

The Undo Job cancels the changes you made in your most recent recording session, editing session, or Job, restoring the data to its previous state. This allows you to recover from accidental data loss. Redo is available only after using Undo, and lets you restore the changes you made before undoing them.

CAUTION Undo/Redo does not work with Mixing Voice operations.

[F2] NOTE (Note data Job)

NOTE Before executing the Note data Job, make sure that you specify the track (01–16, all) and range (measure : beat : clock) to which the Job is applied.

01: Quantize	Quantization is the process of adjusting the timing of note events by moving them closer to the nearest exact beat. You can use this feature, for example, to improve the timing of a performance recorded in real time.
TR (Track) 001 : 1 : 000 – 999 : 4 : 479	Determines the track (01-16, all) and range of measures/beats/clocks over which the Job is applied.
Quantize (Resolution)	Determines to what beats the note data in the specified track will be aligned. Settings: 32nd note, 16th note triplet, 16th note, 8th note triplet, 8th note, 1/4 note triplet, 1/4 note, 16th note + 16th note triplet, 8th note + 8th note triplet
Strength	The Strength value sets the “strength” by which note events are pulled toward the nearest quantize beats. A setting of 100% produces exact timing. A setting of 0% results in no quantization. Settings: 000%–100%

Voice mode
Performance mode
Song mode
Pattern mode
Mixing Voice mode
Utility mode
File mode
Master mode
Reference

<p>SwingRate</p>	<p>Delays notes on even-numbered beats (backbeats) to produce a swing feel. For example, if the meter is 4/4 and the quantize value is quarter notes, the 2nd and 4th beats of the measure will be delayed. When a triplet quantize value is used, the last note of each triplet is delayed. When the quantize value is even-numbered, beats will be delayed.</p> <p>Settings: See below. If the quantize value is 1/4 note, 8th note, 16th note, 32nd note: 50% – 75% A setting of 100% is equivalent to twice the length of the specified quantize value. A setting of 50% produces exact timing and therefore no swing feel. Settings above 51% increase the amount of swing, with 75% being equivalent to a dotted-note delay.</p> <p>If the quantize value is 1/4 note triplet, 8th note triplet, 16th note triplet: 66% – 83% A setting of 100% is equivalent to three times the length of the specified quantize value. A setting of 66% produces exact timing and therefore no swing feel. Settings above 67% increase the amount of swing, with 83% being equivalent to a sextuplet delay.</p> <p>If the quantize value is 8th note + 8th note triplet, 16th note + 16th note triplet: 50% – 66% A setting of 100% is equivalent to twice the length of a 8th note or 16th note. A setting of 50% produces exact timing and therefore no swing feel. Settings above 51% increase the amount of swing, with 66% being equivalent to a triplet delay.</p> <p>NOTE If a swing value other than 100% results in notes being positioned after other non-swing notes, the latter notes are delayed accordingly.</p>
<p>GateTime</p>	<p>Determines the gate time (the length of time a note sounds) of the even-numbered backbeat notes to enhance the swing feel. When a triplet quantize value is used, the gate time of the last note of each triplet is adjusted. When the quantize value is 8th note + 8th note triplet or 16th note + 16th note triplet, the gate time of the even-numbered 8th note or 16th note beats will be adjusted. A setting of 100% leaves the original gate time unchanged. If an adjusted gate time value is less than 1, the value is rounded off to 1.</p> <p>Settings: 000%–200%</p>
<p>02: Modify Velocity</p>	<p>This Job alters the velocity values of the specified range of notes, letting you selectively boost or cut the volume of those notes. Velocity changes are calculated as follows: Adjusted velocity = (original velocity x Rate) + Offset If the result is 0 or less, the value is set to 1. If the result is higher than 127, the value is set to 127.</p>
<p>TR (Track) 001 : 1 : 000 – 999 : 4 : 479</p>	<p>Determines the track (01-16, all) and range of measures/beats/clocks over which the Job is applied.</p>
<p>SetAll</p>	<p>Sets the velocities of all target notes to the same fixed value (1 to 127). When set to "off" the Set All parameter has no effect. When set to a value other than "off" the Rate and Offset parameters are unavailable and appear as "****" on the display.</p> <p>Settings: off (0), 001–127</p>
<p>Rate</p>	<p>Determines the percentage by which the target notes will be shifted from their original velocities. Settings below 100% reduce the velocities, and settings above 100% increase the velocities proportionately. When the Set All parameter is not "OFF" this parameter appears as "****" and cannot be changed.</p> <p>Settings: 000% – 200%, ***</p>
<p>Offset</p>	<p>Adds a fixed value to the Rate-adjusted velocity values. A setting of 0 produces no change. Settings below 0 reduce the velocities, and settings above 0 increase the velocities. When the Set All parameter is not "OFF" this parameter appears as "****" and cannot be changed.</p> <p>Settings: -127 – +127, ***</p>
<p>03: Modify Gate Time</p>	<p>This Job alters the gate times of the specified range of notes. Gate time changes are calculated as follows: Adjusted gate time = (original gate time x Rate) + Offset If the result is 0 or less, the value is rounded off to 1.</p>
<p>TR (Track) 001 : 1 : 000 – 999 : 4 : 479</p>	<p>Determines the track (01-16, all) and range of measures/beats/clocks over which the Job is applied.</p>
<p>SetAll</p>	<p>Sets the gate times of all target notes to the same fixed value. When set to "off" the Set All parameter has no effect. When set to a value other than "off," the Rate and Offset parameters are unavailable and appear as "****" on the display.</p> <p>Settings: off (0), 0001 – 9999</p>
<p>Rate</p>	<p>Determines the percentage by which the gate time of the target notes will be changed. Settings below 100% shorten the notes, and settings above 100% lengthen the notes proportionately. When the Set All parameter (above) is set to something other than "off," this parameter appears as "****" and cannot be changed.</p> <p>Settings: 000% – 200%, ***</p>
<p>Offset</p>	<p>Adds a fixed value to the Rate-adjusted gate time values. A setting of 0 produces no change. Settings below 0 shorten the gate time, and settings above 0 lengthen the gate time. When the Set All parameter (above) is set to something other than "off," this parameter appears as "****" and cannot be changed.</p> <p>Settings: -9999 – +9999, ***</p>
<p>04: Crescendo</p>	<p>This Job lets you create a crescendo or decrescendo over the specified range of notes. (Crescendo is a gradual increase in volume, and decrescendo is a gradual decrease.)</p>
<p>TR (Track) 001 : 1 : 000 – 999 : 4 : 479</p>	<p>Determines the track (01-16, all) and range of measures/beats/clocks over which the Job is applied.</p>
<p>VelocityRange</p>	<p>Determines the intensity of the crescendo or decrescendo. The velocity values of the notes in the specified range are gradually increased or decreased starting at the first note in the range. The velocity of the last note in the range becomes the original velocity of the note plus the Velocity Range value. If the resultant velocity is outside the 1 – 127 range, it is set to 1 or 127 accordingly. Settings greater than 0 produce a crescendo, and settings less than 0 produce a decrescendo. A setting of 0 produces no effect.</p> <p>Settings: -127 – +127</p>

Voice mode

Performance mode

Song mode

Pattern mode

Mixing Voice mode

Utility mode

File mode

Master mode

Reference

05: Transpose	Transpose lets you change the key or pitch of the notes in the specified range.
TR (Track) 001 : 1 : 000 – 999 : 4 : 479	Determines the track (01-16, all) and range of measures/beats/clocks over which the Job is applied.
Note	Determines the range of note pitches over which the Job is applied. You can also set the Note directly from the Keyboard, by holding down the [INFORMATION] button and pressing the desired key. Settings: C-2 – G8
Transpose	Transposes notes in the specified range (in semitones). A setting of +12 transposes up one octave, while a setting of -12 transposes down an octave. A setting of 0 produces no change. Settings: -127 – +127
06: Glide	The Glide Job replaces all notes following the first note in the specified range with pitch bend data, producing smooth glides from note to note. This is ideal for producing guitar-like slide or note-bending effects.
TR (Track) 001 : 1 : 000 – 999 : 4 : 479	Determines the track (01 – 16, all) and range of measures/beats/clocks over which the Job is applied.
GlideTime	Determines the length of the glide. Higher values produce a longer glide between notes. Settings: 000 – 100
PBRange (Pitch Bend Range)	Determines the maximum pitch bend range to be applied by the Glide Job (in semitones). Settings: 01 – 24
07: Create Roll	This Job creates a series of repeated notes (like a drum roll) in the specified range with the specified continuous changes in clock step and velocity. This is ideal for creating fast staccato rolls and special stuttering effects.
TR (Track) 001 : 1 : 000 – 999 : 4 : 479	Determines the track (01 – 16) and range of measures/beats/clocks over which the Job is applied.
StartStep (Starting Step) EndStep (Ending Step)	Determines the size of the step (i.e. the number of clocks) between each note in the roll. Both the starting and ending clock values can be specified, making it easy to create rolls in which the step size varies during the roll. Settings: StartStep: 001 – 999, EndStep: 001 – 999
Note	Determines the specific note (or instrument in Drum voices) for the roll effect. You can also set the note directly from the Keyboard, by holding down the [INFORMATION] button and pressing the desired key. Settings: C-2 – G8
StartVelo (Starting Velocity) EndVelo (Ending Velocity)	Determines the velocity of the notes in the roll. Both the starting and ending velocity values can be specified, making it easy to create rolls in which the velocity increases or decreases. This lets you create rolls that gradually increase or decrease in volume (crescendo/decrescendo)—a technique often used in dance music. Settings: StartVelo: 001 – 127, EndVelo: 001 – 127
08: Sort Chord	This Job sorts chord events (simultaneous note events) by order of pitch. The sort affects the order of the notes in the Event List display (page 90), but does not change the timing of the notes. When used to pre-process chords before using the Separate Chord Job (below), Chord Sort can be used to simulate the “stroke” or strumming sound of guitars and similar instruments.
TR (Track) 001 : 1 : 000 – 999 : 4 : 479	Determines the track (01 – 16, all) and range of measures/beats/clocks over which the Job is applied.
Type	Determines how the chord note data is sorted. Settings: up, down, up&down, down&up up The notes are sorted in ascending order. After executing this Job with this setting, execute the Separate Chord Job to create a guitar-like upstroke strum. down..... The notes are sorted in descending order. After executing this Job with this setting, execute the Separate Chord Job to create a guitar-like downstroke strum. up&down Sorts chord notes on downbeats in ascending order and chord notes on upbeats in descending order, based on the Grid setting (below). down&up Sorts chord notes on downbeats in descending order and chord notes on upbeats in ascending order, based on the Grid setting (below).
Grid	Determines the type of note that serves as the basis for the Chord Sort Job. Settings: 32nd note, 16th note triplet, 16th note, 8th note triplet, 8th note, 1/4 note triplet, 1/4 note
09: Separate Chord	This Job slightly separates notes in chords within the specified range, inserting a specified number of clocks between each note. Use this Job after the Chord Sort Job above, to create guitar-like upstroke or downstroke effects.
TR (Track) 001 : 1 : 000 – 999 : 4 : 479	Determines the track (01 – 16, all) and range of measures/beats/clocks over which the Job is applied.
Clock	Determines the number of clock cycles inserted between adjacent chord notes. Settings: 000 – 999 NOTE Note that there are 480 clock cycles per quarter note. NOTE It is not possible to separate chords so that they cross the next chord or they overstep the range (set above).

[F3] EVENT (Event Job)

NOTE Before executing the Event Job, make sure that you specify the track and range (measure : beat : clock) to which the Job is applied. Please note that the track to be specified varies depending on the Job.

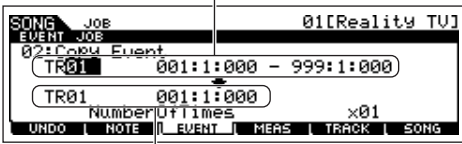
01: Shift Clock	This Job shifts all data events in the specified range forward or backward by the specified number of clocks.	
TR (Track) 001 : 1 : 000 – 999 : 4 : 479	Determines the track (01 – 16, TMP, SCN, all) and range of measures/beats/clocks over which the Job is applied.	
Clock	Determines the amount by which the data will be delayed or advanced in measures, beats, and clocks. Settings: 000:0:000 – 999:3:479	
Direction	Determines the direction in which the data will be shifted. ADVANCE moves the data toward the beginning of the sequence, while DELAY shifts the data toward the end of the sequence. Settings: Advance, Delay	
02: Copy Event	Source track and range in measures, beats, and clocks  Destination track and the top (measure, beat, and clock) of the destination.	This Job copies all data from a specified source range to a specified destination location. Execute this Job after setting: <ul style="list-style-type: none"> • Source track (01 – 16, TMP, SCN, all) • Source range (measure : beat : clock) • Destination track (01 – 16, TMP, SCN, all) • Destination range (measure : beat : clock) • Top measure of destination • Count (number of times data is to be copied)
NumberOfTimes	Determines the number of times the data is copied. Settings: 01 – 99	

CAUTION When Copy Event is executed, any data already existing at the Destination location will be overwritten.

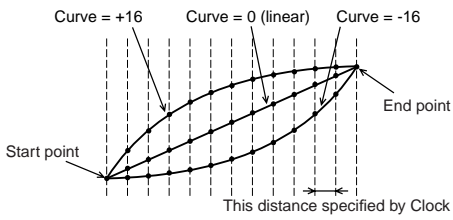
03: Erase Event	This Job clears all specified events from the specified range, effectively producing a segment of silence.	
TR (Track) 001 : 1 : 000 – 999 : 4 : 479	Determines the track (01 – 16, TMP, SCN, all) and range of measures/beats/clocks over which the Job is applied.	
Event Type	Determines the event type to be erased. All events are cleared when ALL is selected. Individual control change numbers can be specified when erasing control change events. Settings: When TR is set to 01 – 16: Note (Note events), PC (Program Change), PB (Pitch Bend), CC (Control Change)*, CAT (Channel Aftertouch), PAT (Polyphonic Aftertouch), EXC (System Exclusive), All (all events) When TR is set to "TMP" (Tempo): TMP (tempo) When TR is set to "SCN" (Scene): SceneMemory (Scene change information), TrackMute (Track mute setting change information) * You can also specify the CC No. (Control Change number).	
04: Extract Event	This Job moves all instances of specified event data from a specified range of a track to the same range in a different track.	
TR (Track) 001 : 1 : 000 – 999 : 4 : 479	Determines the track (01 – 16) and range of measures/beats/clocks over which the Job is applied.	
EventType	Selects the event type to be extracted. Specific note and control change numbers can also be specified as required. Settings: Note, PC (Program Change), PB (Pitch Bend), CC (Control Change), CAT (Channel Aftertouch), PAT (Polyphonic Aftertouch), EXC (System Exclusive)	
→ TR	Determines the destination track (01 – 16).	
05: Create Continuous Data	This Job creates continuous pitch bend or control change data over the specified range.	
TR (Track) 001 : 1 : 000 – 999 : 4 : 479	Determines the track (01 – 16, TMP, all) and range of measures/beats/clocks over which the Job is applied.	
EventType	Determines the event type to be created. Settings: PB (Pitch Bend), CC (Control Change)*, CAT (Channel Aftertouch), EXC (System Exclusive), TMP (Tempo) * You can also specify the CC No. (Control Change number).	
Data (Data Range)	Determines the lower and upper limits for the data range to be created. The left value is the lower limit, and the right value is the upper limit. Settings: When Event Type is set to PB: -8192 – +8191 When Event Type is set to TMP: 1.0 – 300.0 When Event Type is set to other: 0 – 127	
Clock	Determines the number of clocks to be inserted between each created event. Settings: 001 – 999	
Curve	Determines the "curve" of the continuous data. Refer to the graph for approximate curve shapes. Settings: -16 – +16	

Voice mode
Performance mode
Song mode
Pattern mode
Mixing Voice mode
Utility mode
File mode
Master mode

Reference

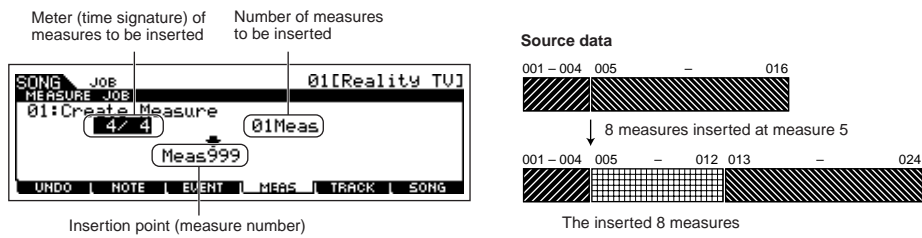

NumberOfTimes	Determines the number of times the data creation is to be repeated. For example, if data is created in the range M001:1:000 – M003:1:000 and this parameter is set to 03, the same data will be created at M003:1:000 – M005:1:000 and M005:1:000 – M007:1:000. This Job lets you insert continuous volume or filter cutoff variations to create tremolo or wah effects. Settings: 01 – 99
06: Thin Out	This Job thins out the specified type of continuous data in the specified range—allowing you to free up memory space for other data or further recording.
TR (Track) 001 : 1 : 000 – 999 : 4 : 479	Determines the track (01 – 16, TMP, all) and range of measures/beats/clocks over which the Job is applied.
EventType	Determines the event type to be thinned. Settings: PB (Pitch Bend), CC (Control Change)*, CAT (Channel Aftertouch), PAT (Polyphonic Aftertouch), TMP (Tempo) * You can also specify the CC No. (Control Change number). NOTE The Thin Out Job will not work on continuous data that has a clock interval of greater than 60 clocks per event.
07: Modify Control Data	This Job lets you change the values of a specified type of control change data—pitch bend, control change, aftertouch, etc.—in the specified range. Data changes are calculated as follows: Modified value = (original value x Rate) + Offset. The modified value cannot exceed the minimum/maximum limits of the parameter. Any result lower than the minimum is set to the minimum; any result higher than the maximum is set to the maximum.
TR (Track) 001 : 1 : 000 – 999 : 4 : 479	Determines the track (01 – 16, TMP, all) and range of measures/beats/clocks over which the Job is applied.
EventType	Determines the event type to be modified. Settings: PB (Pitch Bend), CC (Control Change)*, CAT (Channel Aftertouch), PAT (Polyphonic Aftertouch), TMP (Tempo) * You can also specify the CC No. (Control Change number).
SetAll	Sets all target events to the same fixed value. When set to “off,” the Set All parameter has no effect. When set to a value other than “off,” the Rate and Offset parameters are unavailable and appear as “****” on the display. Settings: off, 000 –127 (-8192 – +8191 for pitch bend, 0.1 – 300.0 for tempo)
Rate	Determines the percentage by which the target events will be shifted from their original values. When the Set All parameter (above) is set to something other than “off,” this parameter appears as “****” and cannot be changed. Settings: 000% – 200%, ***
Offset	Adds a fixed value to the Rate-adjusted event values. When the Set All parameter (above) is set to something other than “off,” this parameter appears as “****” and cannot be changed. Settings: -127 – 127 (-8192 – +8191 for pitch bend, -275 – +275 for tempo), ***
08: Beat Stretch	This Job performs time-expansion or compression over the selected range. Keep in mind that this operation affects all event timing, note step times, and note gate times.
TR (Track) 001 : 1 : 000 – 999 : 4 : 479	Determines the track (01 – 16, all) and range of measures/beats/clocks over which the Job is applied.
Rate	Determines the amount of time expansion or compression as a percentage. Settings higher than 100% produce expansion, and settings below 100% produce compression. Settings: 025%–400%

[F4] MEAS (Measure Job)

01: Create Measure	This Job creates empty measures at the specified location in all tracks.  <p>Meter (time signature) of measures to be inserted Number of measures to be inserted</p> <p>Source data</p> <p>001 – 004 005 – 016</p> <p>8 measures inserted at measure 5</p> <p>001 – 004 005 – 012 013 – 024</p> <p>The inserted 8 measures</p> <p>Insertion point (measure number)</p>
Meter of measures to be inserted	Determines the meter or time signature of the measures to be created. You may find it convenient to use this parameter when you need to create a Song that incorporates meter changes. Settings: 1/16 – 16/16, 1/8 – 16/8, 1/4 – 8/4
Insertion point (Measure number)	Determines the insert point (measure number) at which the newly created blank measures will be inserted. Settings: 001 – 999
Number of measures to be inserted	Determines the number of empty measures to be created and inserted. Settings: 01 – 99

NOTE When empty measures are inserted, measure and meter data following the insert point are moved forward accordingly.

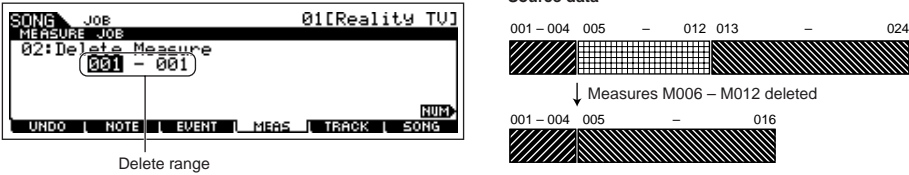
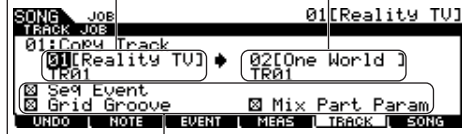
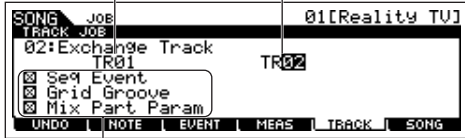
NOTE If the insert point is set after the last measure containing data, only the meter data at that point is set without actually inserting the measures.

<p>02: Delete Measure</p>	<p>This Job deletes the specified measures. Measure and meter data following the deleted measures are moved backward accordingly.</p>  <p>Delete range</p>
<p>Delete Range</p>	<p>Settings: 001 - 999</p>
<p>[F5] TRACK (Track Job)</p>	
<p>01: Copy Track</p>	<p>Source Song and Track Destination Song and Track</p>  <p>Data Type to be copied</p> <p>This Job copies all data from a specified source track to the specified destination track.</p> <p>CAUTION The copy operation overwrites any data previously existing on the destination track.</p>
<p>Data Type to be copied</p>	<p>Determines the type(s) of data to be copied. Select the desired type by checkmarking the appropriate box.</p> <p>Settings: Seq Event (all events in the track), Grid Groove (for the selected track), Mix Part Param (all Mixing Part parameters),</p>
<p>02: Exchange Track</p>	<p>Target tracks for the Exchange operation (01 - 16)</p>  <p>Data Type to be exchanged</p> <p>This Job exchanges or “swaps” the specified type of data between two specified tracks in the current Song.</p>
<p>Data Type to be exchanged</p>	<p>Determines the type(s) of data to be exchanged. Select the desired type by checkmarking the appropriate box.</p> <p>Settings: Seq Event (all events in the track), Grid Groove (for the selected track), Mix Part Param (all Mixing Part parameters)</p>
<p>03: Mix Track</p>	<p>Track A (01 - 16) Track B (01 - 16)</p>  <p>Settings: 01 - 16</p> <p>This Job mixes all data from two selected tracks (“A” and “B”), and places the result in track B. One useful application for this would be to free up the data in track A, letting you record new data to it.</p>
<p>Target tracks for the Mix operation</p>	<p>Settings: 01 - 16</p>
<p>04: Clear Track</p>	<p>Track for which data will be cleared (01 - 16, TMP, SCN, all)</p>  <p>Data to be cleared</p> <p>This Job deletes all data of the selected type from the selected track, or from all tracks.</p>
<p>Data type to be cleared</p>	<p>Determines the type(s) of data to be cleared. Select the desired type by checkmarking the appropriate box.</p> <p>Settings: Seq Event (all events in the track), Grid Groove (for the selected track), Mix Part Param (all Mixing Part parameters)</p>
<p>05: Normalize Play Effect</p>	<p>This Job rewrites the data in the selected track so that it incorporates the current Grid Groove settings.</p> <p>TR (Track)</p> <p>Determines the Song track to which the Job is applied.</p> <p>Settings: 01 - 16, all</p>
<p>06: Divide Drum Track</p>	<p>Separates the note events in a drum performance assigned to a specified track, and places the notes corresponding to different drum instruments in separate tracks (tracks 1 through 8).</p> <p>TR (Track)</p> <p>Determines the Song track to which the Job is applied.</p> <p>Settings: 01 - 16</p>
<p>07: Put Track To Arp</p>	<p>This Job copies data in the specified measures of a track for creating Arpeggio data. For details, refer to page 97 in the Quick Guide section.</p>

Voice mode

Performance mode

Song mode

Pattern mode

Mixing Voice mode

Utility mode

File mode

Master mode

Reference

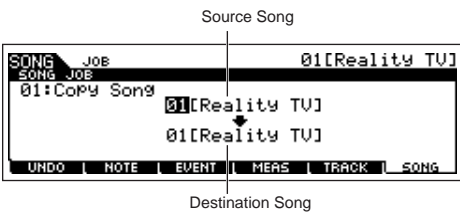
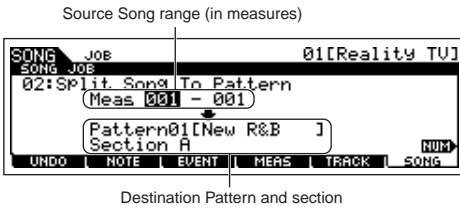
[F6] SONG (Song Job)		
<p>01: Copy Song</p>	 <p>Source Song</p> <p>Destination Song</p>	<p>This Job copies all data from a selected source Song to a selected destination Song. The Mixing Voice used by the source Song is also copied.</p> <p>CAUTION This Job overwrites any data already existing in the destination Song.</p>
<p>02: Split Song To Pattern</p>	 <p>Source Song range (in measures)</p> <p>Destination Pattern and section</p>	<p>This Job allows you to copy a part of the current Song – all 16 tracks over a specific range of measures – to a specific Pattern, letting you use Song data to create a Pattern.</p> <p>CAUTION This Job overwrites any data already existing in the destination Pattern and section.</p>
<p>03: Clear Song</p>	<p>This Job deletes all data from the selected Song or all Songs, including the Mixing Voices.</p>	
<p>04: Song Name</p>	<p>This Job lets you assign a name to the selected Song. See “Basic Operation” on page 38.</p>	

Song Mixing mode [SONG] → Song selection → [MIXING]

In this mode, you can set up mixing data for your songs, and set various parameters for the tone generator parts—including the desired Voice, as well as its level, pan, EQ, effect and other settings. Song Mixing parameters are not actually part of the Song sequence data in each track, but rather are settings for the tone generator, as it is played back by the Song data. As such, the Song Mixing parameter settings are not recorded to the Song tracks.

CAUTION

Parameter settings made in the Song Mixing mode and Song Mixing Edit mode should be stored to internal memory (DRAM) as part of the Song data. In addition, make sure to save the entire Song data (including the Mixing settings) to the USB storage device, since the data in DRAM is stored only temporarily (page 150).

NOTE Parameter settings in the Song Mixing mode and Song Mixing Edit mode can be stored as a template to internal Flash ROM, as well as being stored as part of a Song. See page 94 for details.

[F1] VOL/PAN

From this display you can set the Pan and Volume for each Part (track).

<p>PAN</p>	<p>Determines the stereo pan position for each part.</p> <p>Settings: L63 (far left) – C (center) – R63 (far right)</p>
<p>VOLUME</p>	<p>Determines the volume for each Part, allowing you to set the optimum level balance of all the Parts.</p> <p>Settings: 0 – 127</p> <p>NOTE You can also adjust the Volume by using the Control Sliders. See page 52 for details.</p>

[F2] VOICE

From this display you can select a voice for each Part. Mixing Voices can also be selected.

NOTE The Category Search function can also be used to select Voices here, except for Mixing Voices.

[F3] EFFECT

Pressing the [F3] EFFECT button in the Song Mixing mode calls up the [SONG] → [MIXING] → [EDIT] → [COMMON] → [F6] EFFECT display in the Song Mixing Edit mode. From this display, you can set the effect related parameters for the current Song. See page 144 for details.

[F4] EF SEND (Effect Send)

From this display you can make basic effect settings for each Part—Send Level for the System Effect (Reverb, Chorus) as well as the Dry Level for Insertion Effects.

NOTE For information on the effect connections in the Song mode, see page 144.

[F5] VCE ED (Mixing Voice Edit)

Press the [F5] VCE ED button in the Song Mixing mode to enter the Mixing Voice Edit mode. Press the [EXIT] button to return to the original display in the Song Mixing mode.

Normal Voices can be edited specifically for use with the Song/Pattern modes, creating a dedicated “Mixing Voice.” Refer to “Mixing Voice mode” on page 203 for details.

Voice mode
Performance mode
Song mode
Pattern mode
Mixing Voice mode
Utility mode
File mode
Master mode
Reference

[F6] TEMPLATE	
[SF1] MIX	From this display you can copy the Mixing Template to the Mixing settings of currently edited Part. As soon as a Template is selected, the relevant Mixing settings will be automatically loaded. NOTE In addition to the Mixing settings, the tempo setting stored in the Mixing Template will also be automatically loaded.
[SF2] PERFORMANCE	From this display you can copy the Part settings of the Performance to the currently edited Song. As soon as a Performance is selected, the relevant settings of all Parts will be copied. This display is similar to the [F5] PF COPY display in Song Mixing Job mode (page 192). However, this display is different from the [F5] PF COPY display in two major points: <ul style="list-style-type: none"> • All parameters are copied simultaneously. • The Receive Channel settings are assigned to the destination automatically, according to the following rules. <ol style="list-style-type: none"> 1) When note limit settings for all Parts are the same and the Part Switch and ArpSwitch parameters are both set to ON, the same Receive Channel is assigned to the Parts. 2) When Note Limit settings for the Parts are different and Part Switch is set to ON for the Parts, Parts whose ArpSwitch parameter is set to OFF are given different Receive Channel values, while other Parts are set to the same channel. 3) For those Parts which Part Switch is set to OFF, Receive Channel is also set to OFF. NOTE In addition to the Part settings, the Arpeggio tempo setting stored in the Performance will also be copied.

Song Mixing Edit mode [SONG] → Song selection → [MIXING] → [EDIT]

This mode provides more detailed Mixing parameters than in the Song Mixing mode. Keep in mind that Song Mixing parameters are not actually part of the Song sequence data in each track, but rather are settings for the tone generator, as it is played back by the Song data. As such, the Song Mixing parameter settings are not recorded to the Song tracks.

CAUTION
Parameter settings made in the Song Mixing mode and Song Mixing Edit mode should be stored to internal memory (DRAM) as part of the Song data. In addition, make sure to save the entire Song data (including the Mixing settings) to the USB storage device, since the data in DRAM is stored only temporarily (page 150).

NOTE Parameter settings in the Song Mixing mode and Song Mixing Edit mode can be stored as a template to internal Flash ROM, as well as being stored as part of a Song. See page 94 for details.

Common Edit [SONG] → Song selection → [MIXING] → [EDIT] → [COMMON]

Use Common Edit to edit the settings common to all Parts.

[F1] GENERAL	
[SF1] MEQ OFS (Master EQ Offset)	The Song Mixing parameters feature global EQ settings for all Parts of the selected Song (see "MEQ," below). The settings made here in this display are applied as offsets to those MEQ settings. Settings: -64 – +63
[SF5] OTHER	
KnobAssign	Determines the function for the assignable Knobs (1 – 4). Pressing any of the Knob Control Function buttons on the panel sets the desired function row, which is automatically stored to memory with the currently selected Song. Settings: pan, tone, assign, partEQ, MEF, arpFx
Assign A, Assign B, Assign 1, Assign 2	This lets you directly set and memorize the value for each Assign Knob (A, B, 1, and 2), from the Knob itself. Simply tweak the knob to the desired setting. Settings: -64 – 0 – +63
[F2] MEQ/MEF (Master EQ/Master Effect)	
[SF1] MEQ (Master EQ)	From this display you can apply five-band equalization to all Parts of the selected Song. The parameters are the same as in Performance Common Edit. See page 172.
[SF2] MEF (Master Effect)	From this display you can set parameters related to the Master Effect (page 140). The parameters are the same as in Performance Common Edit. See page 172.
[F3] ARP (Arpeggio)	
[SF1] TYPE	The basic parameters (e.g., type) of the Arpeggio are provided in this display. This is the same as in Normal Voice Common Edit (page 154), except that the Tempo setting is not available here, since the Arpeggio plays according to the Song tempo.
[SF2] LIMIT	Same as in Normal Voice Common Edit. See page 155.
[SF3] PLAY FX (Play Effect)	Same as in Normal Voice Common Edit. See page 155.
[SF4] OUT CH (Output Channel)	Same as in Performance Common Edit. See page 173.

Reference
Voice mode
Performance mode
Song mode
Pattern mode
Mixing Voice mode
Utility mode
File mode
Master mode

[F4] CTL ASN (Controller Assign)

From this display, you can assign Control Change numbers to the hardware controllers of the instrument (such as the Knobs), for each Song. The parameters are the same as in Performance Common Edit. See page 173.

[F6] EFFECT

NOTE For information on the effect connections in the Song mode, see page 144.

[SF1] CONNECT	For more information on parameters, refer to page 144.
[SF2] INS SW (Insertion Switch)	The Insertion Effects can be applied to up to three parts. This display lets you set to which parts the Insertion Effects are applied.
[SF4] REVERB	The number of parameters and values available differs depending on the currently selected effect type. For more information, see the Effect Type List in the separate Data List booklet.
[SF5] CHORUS	

Part Edit	[SONG] → Song selection → [MIXING] → [EDIT] → Part selection
------------------	---

These parameters are for editing the individual Parts that make up a Song Mixing.

[F1] VOICE

[SF1] VOICE	Determines the Voice for each Part. For details, see page 76. NOTE When the cursor is located on the Bank, you can select a Voice (with the exception of Mixing Voices) via the method explained in the Quick Guide on page 40.
[SF2] MODE	
Mono/Poly	Determines the playback method of the Voice for each Part—monophonic (single notes only) or polyphonic (multiple notes). Settings: mono, poly NOTE This parameter is not available for the part to which a Drum Voice is assigned.
ArpSwitch (Arpeggio Switch)	Determines whether Arpeggio is on or off for the currently selected Part. Settings: on, off NOTE Only Parts having the same receive channel can be applied simultaneously.
ReceiveCh (Receive Channel)	Determines the MIDI receive channel for the selected Part. Since MIDI data may be coming from many channels at once, you should set this to match the particular channel over which the desired controlling data is being sent. Settings: 01 – 16, off
[SF3] LIMIT	From this display you can determine the note range and velocity range for each Part. The parameters are the same as in Performance Part Edit. See page 174.
[SF4] PORTA (Portamento)	Determines the Portamento parameters for each Part. The parameters are the same as in Performance Part Edit. See page 174.
[SF5] OTHER	Same as in Performance Part Edit. See page 174.

[F2] OUTPUT

[SF1] VOL/PAN (Volume/Pan)	Same as in Performance Part Edit. See page 175.
[SF2] EF SEND (Effect Send)	Same as in Performance Part Edit. See page 175.
[SF3] SELECT (Output Select)	Same as in Performance Part Edit. See page 175.

[F3] EQ (Equalizer)

From this display you can set parameters related to the Part EQ. The parameters are the same as in Performance Part Edit. See page 175.

[F4] TONE

[SF1] TUNE	Same as in Performance Part Edit. See page 176.
[SF2] FILTER	Same as in Performance Part Edit. See page 176.
[SF3] FEG (Filter Envelope Generator)	From this display you can set the FEG (Filter Envelope Generator) parameters for each Part. The parameters offset the same parameters of the assigned Voice set in the Voice (Element) Edit mode (page 161). The parameters are the same as in Performance Part Edit. See page 176. NOTE The FEG setting is not available for Parts to which Drum Voices have been assigned.
[SF4] AEG (Amplitude Envelope Generator)	From this display you can set the AEG (Amplitude Envelope Generator) parameters for each Part. The parameters offset the same parameters of the assigned Voice set in the Voice (Element) Edit mode (page 162). The parameters are the same as in Performance Part Edit. See page 176. NOTE Sustain and Release settings are not available for Parts to which Drum Voices have been assigned.

Voice mode
Performance mode
Song mode
Pattern mode
Mixing Voice mode
Utility mode
File mode
Master mode
Reference

[F5] RCV SW (Receive Switch)

From this display you can set how each individual Part responds to various MIDI data, such as Control Change and Program Change messages. When the relevant parameter is set to “on,” the corresponding Part responds to the appropriate MIDI data.

Note that two different display types listed below are provided and you can switch between them by pressing the [SF5] button. Each display type features the same settings in a different format; use the type you feel most comfortable with.

• **Display showing four Parts**

This display type shows the Receive Switch status for four Parts at a time. Set the desired Part on or off, for the corresponding MIDI data type. To view and edit another set of four Parts, press the appropriate Number button, [1] to [16].

Keep in mind that since all the available parameters cannot be simultaneously displayed, you will need to use the cursor controls to scroll the display in order to see and set the other parameters.

• **Display showing all parameters for one Part**

This display type shows all of the Receive Switch settings for a single selected Part. Set the desired MIDI data type on or off for the selected Part. To select other Parts, use the Number [1] – [16] buttons (making sure that the [TRACK SELECT] button is on).

Song Mixing Job mode

[SONG] → Song selection → [MIXING] → [JOB]

The Song Mixing Job mode features several basic operations, such as Initialize and Copy. After setting parameters as required from the selected display, press the [ENTER] button to execute the Job.

[F1] INIT (Initialize)

This function lets you reset (initialize) all Song Mixing parameters to their default settings. It also allows you to selectively initialize certain parameters, such as Common settings, settings for each Part, and so on—very useful when creating a completely new Song Mixing program from scratch.

Type of parameter to be initialized: GM, All, Common (Common parameter settings for the selected Song Mixing), Part 1 – 16

[F2] RECALL (Edit Recall)

If you are editing a Song Mixing program and select a different program without storing your edited one, all the edits you’ve made will be erased. If this happens, you can use Edit Recall to restore the Song Mixing program with your latest edits intact.

[F3] COPY

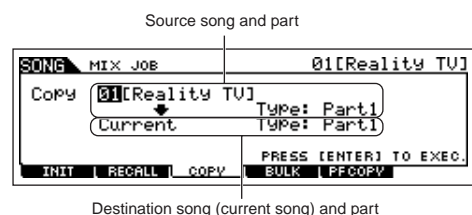

From this display you can copy Part parameter settings from any Song Mixing program including the currently edited (but not yet stored) one to a particular Part of the Song Mixing program you are editing. This would come in handy when you want to use some settings from another program. The procedure is basically the same as in the [F3] COPY display in the Performance Job mode. Refer to page 177.

[F4] BULK (Bulk Dump)

This function lets you send all your edited parameter settings for the currently selected Song Mixing program to a computer or another MIDI instrument for data archiving.

NOTE In order to execute Bulk Dump, you’ll need to set the correct MIDI Device Number. For details, see page 209.

[F5] PF COPY (Performance Copy)

This convenient operation lets you copy certain settings of the four Parts in a performance to the Song Mixing program currently being edited. The display is similar to the [F6] TEMPLATE → [SF2] PERFORM display in the Song Mixing mode. However, the following points differ.

- You can select the desired parameters.
- The MIDI receive channel settings are set to match the basic channel settings (page 209). When the basic channel is set to “omni,” the receive channel here is set to 1.

Song Mixing Store mode

[SONG] → Song selection → [STORE]

This function lets you store your edited Song Mixing program to User memory (DRAM). For details, refer to page 98 in the Quick Guide section.

Voice mode

Performance mode

Song mode

Pattern mode

Mixing Voice mode

Utility mode

File mode

Master mode

Reference

■ Supplementary information

Song Track Loop—setting example

[SONG] → [F3] TRACK → [SF3] TR LOOP (Track Loop) page 179

In the example below, a 40-measure song has been recorded and Track 1 is set to play back normally over the 40 measures. Track 2 has been set to loop, and will repeat until the [] (Stop) button is pressed.

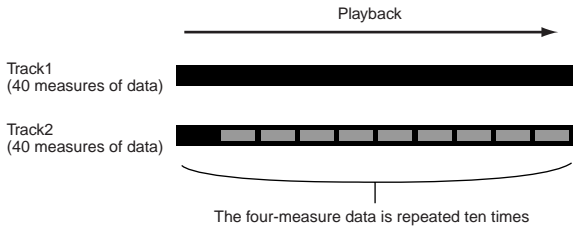

When Track Loop has been set to on, you can specify the range to be looped. (Only the end point can be set; the start point of looped playback is fixed to the beginning of the song.)

⚠ CAUTION

Please note that changing the Track Loop from off to on will delete the data of the area that is not looped.

- 1 Press [F1] to call up the Song Play display. Here, change the change the current measure—this will be used for the last measure of the loop.

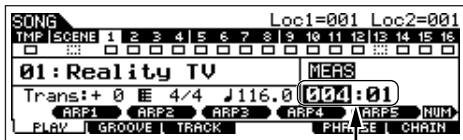

In this example, set to "004."

- 2 Call up the [F3] TRACK → [SF3] TR LOOP display and move the cursor to the track to be looped.

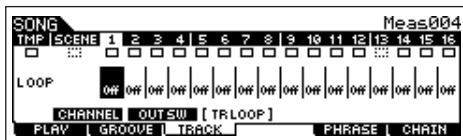

- 3 Set the selected track to on by using the [INC/YES] and [DEC/NO] buttons or the data dial. (The display prompts you for confirmation.)

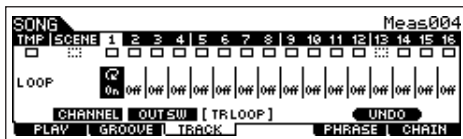

If you want to restore the deleted data and return the selected track to off, press the [SF5] UNDO button.

⚠ CAUTION

The Undo function can only be used on the last Track Loop operation. If you've set other tracks to loop, the data of those previous tracks cannot be recovered.

Step Recording — examples

[SONG] or [PATTERN] → [REC] → [F1] SETUP → Type page 179 = step

This section explains how to step-record notes, using three specific examples.

NOTE The explanations here using the Song mode display apply also to the Pattern mode.

• Example 1

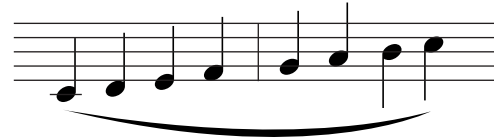

- 1 Set the parameters as illustrated below.

Press the Record button to call up the display below. Here, we'll set the Step Time to (480) so that quarter notes will be entered, and set the GateTime to 100% to have the notes play in legato.

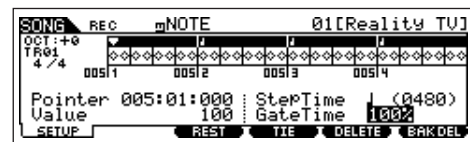

- 2 Play the keys C, D, E, F, G, A, B and C in order.

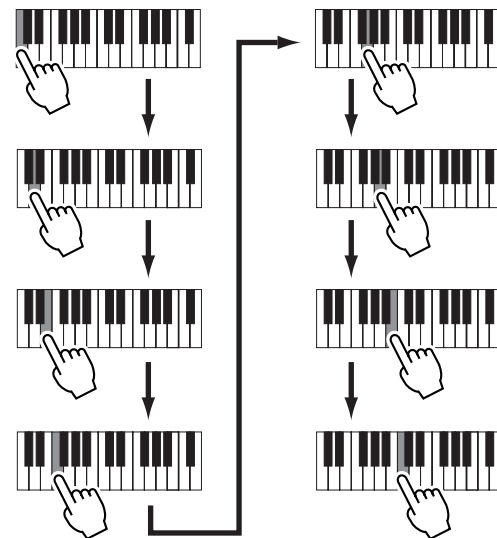

Each time you press a key and release it, the pointer moves forward by one step and the played note is recorded.

- 3 Move the pointer to the top (beginning) of the song and press the [▶] (Play) button to hear the note data you just recorded in steps 1 and 2.

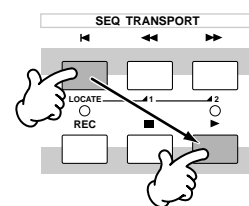

Voice mode

Performance mode

Song mode

Pattern mode

Mixing Voice mode

Utility mode

File mode

Master mode

Reference

• Example 2 (Using the Tie function)



1 Set the parameters as illustrated below.

Since the first note is a half note, set the StepTime to the half-note icon (a value of 960), and set the GateTime to 80%, since you don't want the notes to play in legato.

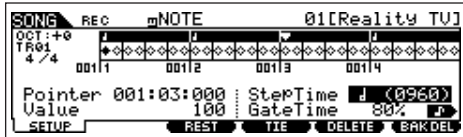

2 Enter the first note F.



1 Press and release F.

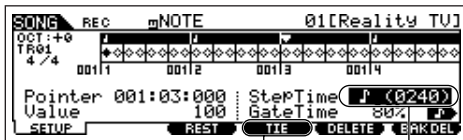

2 Change this to an eighth note (240).

3 Press the [F4] button to tie the two F notes (half note and 8th note).



3 Enter the next 8th notes.

Keep the display settings unchanged for the remaining notes in the measure, and press/release each key one by one as shown below.



4 Follow the instructions below to enter the next dotted half note.



1 Change this to a quarter note (480).

2 Press and release A.

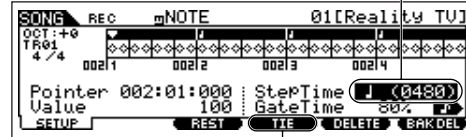

3 Press the [F4] button twice to expand the quarter note to a dotted half note.



5 Enter the last quarter note by pressing and releasing F.



6 Move the pointer to the top (beginning) of the song and press the [▶] (Play) button to hear the note data you just recorded in steps 1 – 5.

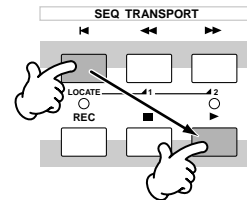

• Example 3 (Using the Rest function)



1 Set the parameters as illustrated below.

Set the StepTime to a quarter note (480) and the Gate Time to 80%.

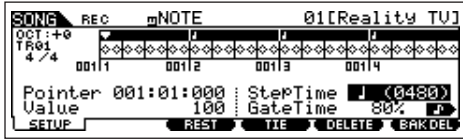

2 Enter the first note, F.

Press and release F.

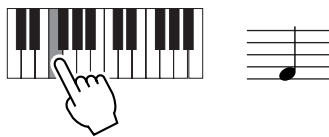

3 Enter the next 8th rest as shown below.

1 Change this to an eighth note (240), since we'll be entering an eighth-note rest.

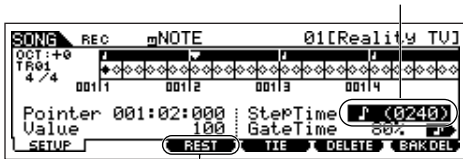

2 Enter the selected rest value (eighth note) by pressing the [F3] button



4 Enter the next 8th note A.

Press and release A.

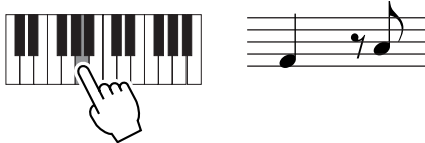

5 Enter the next 4th note C as shown below.

1 Change this value to 480, since the rest value is a quarter note.

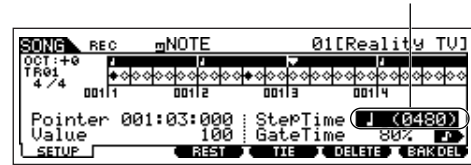

2 Press and release C.

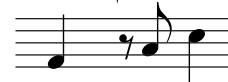

6 Enter the next 8th rest as you did in step 3 above.



7 Enter the last 8th note, F.

Press and release F.



8 Move the pointer to the top (beginning) of the song and press the [▶] (Play) button to hear the note data you just recorded in steps 1 – 7.

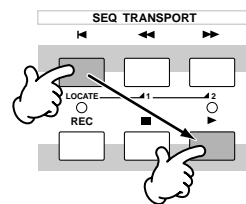

TIP Entering a chord

In Step recording, you can also enter chords. Press and hold down each note of the chord in succession, then release them all together to record them as a chord. Keep in mind that notes are not actually recorded to a track until they are released.

Pattern mode

■ Creating Patterns—basic procedure

Patterns consist of the following three types of data:

- MIDI sequence data (created in the Pattern Record mode, Pattern Edit mode, and Pattern Job mode)
- Setup data (created in the Pattern Play mode)
- Mixing data (created in the Pattern Mixing mode/Mixing Edit mode and stored in the Pattern Mixing Store mode)

After creating the data in these modes described above, store the Mixing settings in the Pattern Mixing Store mode to archive it as Pattern data and save the entire Pattern to the USB storage device in the File mode.

NOTE Non-note MIDI events (such as Voice number, volume, pan, and effect send level) which are necessary at the start of a Pattern are not recorded as MIDI sequence data, but are stored instead as Mixing data.

⚠ CAUTION

Because Pattern data (MIDI sequence data, Setup data, and Mixing data) is recorded to DRAM (page 150), it will be lost when turning the power off. Make sure to save any Pattern data created via the Record, Edit, Job, and Mixing setting to the USB storage device in the File mode before turning the power off. For details on saving Pattern data, see page 98.

Pattern Play mode

[PATTERN] → Pattern selection

[F1] PLAY

Trans (Transpose)

Determines the key transpose setting for the Pattern, and can be adjusted in semitones.

Settings: -36 – +36

NOTE If the Pattern includes a track that you do not want to transpose, set the Not Shift parameter for each Part ([PATTERN] → [MIXING] → [EDIT] → Part selection → [F4] TONE → [SF1] TUNE → NoteShift).

MEAS (Measure)

Indicates the current measure number and beat for the current Pattern. During playback, this indication changes automatically according to the Pattern playback. You can input the desired measure number directly by using the Number Input window called up via the [INFORMATION] button.

[SF1] ARP1 (Arpeggio 1) – [SF5] ARP5 (Arpeggio 5)

You can register the desired Arpeggio types to these buttons and call them up any time during your keyboard performance.

[F2] GROOVE (Grid Groove)

Same as in the Song Play mode. See page 178.

[F3] TRACK

[SF1] CHANNEL

Same as in the Song Play mode. See page 178.

[SF2] OUT SW (Output Switch)

Same as in the Song Play mode. See page 179.

[SF3] TR VCE (Track Voice)

Determines whether the program change data contained in the phrase data is effective or not. For most purposes, this should be set to “off.” For example, if a phrase has embedded Voice changes (program change messages) but you don’t want the Voice to change in the middle of the phrase, set this to “off.” Tracks that are set to “off” here automatically play back with the Voice number assigned to the Part set in the Mixing mode.

NOTE The Phrase Voice embedded in the Phrase can be specified from the Voice display in the Pattern Record mode (page 198).

[F4] PATCH

Refer to page 78 in the Quick Guide section.

From this display, you can assign a Preset phrase or a User phrase (recorded in the Pattern Record mode) to each track and create a Pattern that contains up to 16 tracks.

NOTE The Patch function allows you to use only User phrases recorded to a track of the currently selected Pattern. If you wish to use User phrases recorded to tracks of other Patterns, use the Phrase Data Copy function, selected with [SF5] button.

Section

Shows the current edited section. For details about how to change sections, see page 75.

Meas

Shows Measure: Beat for current playback location.

[SF4] CLEAR

This clears the Phrase assignment to the currently selected track and leaves the track empty.

[SF5] COPY

Source Pattern number, phrase number

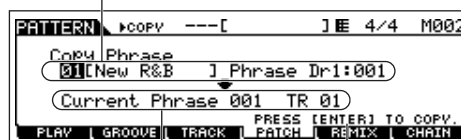

Destination phrase and track of the current edited Pattern

After setting, press the [ENTER] button to copy the phrase.

The User phrases that can be assigned with the Patch function are limited to the ones contained in the currently selected Pattern. This function lets you copy phrases in another Pattern to the selected one. Press the [SF5] button to call up the display shown at left. After setting the parameters as needed, press the [ENTER] button to copy the phrase data.

⚠ CAUTION

The copy operation overwrites any data previously existing in the destination phrase.

Reference
Voice mode
Performance mode
Song mode
Pattern mode
Mixing Voice mode
Utility mode
File mode
Master mode

[F5] REMIX

This function gives you a variety of semi-random presets for dividing the MIDI sequence data and altering the note lengths, letting you create completely new variations of a Pattern.

Set the parameters below, then press the [ENTER] button to execute the Remix operation. You can press the Play button at this point to hear the results of the Remix. If you're not satisfied with the results, try another Type/Variation and press [ENTER]. If you want to keep the changes, press [SF5] OK. (Undo cannot be used with Remix.) To return to the original display without altering the data, press the [SF4] CANCEL button.

NOTE Since the remixed data is stored as a new phrase and assigned to the current track, the original phrase data remains as an unassigned phrase.

Type	Determines how the data in a measure will be divided and rearranged. The division and rearrangement rules are different for each remix type. The type is also shown graphically in the display. Settings: 1 – 16
Variation	Determines how the original MIDI sequence data will be modified. Settings: Normal 1 – 16, Roll 1 – 16, Break 1 – 16, Fill 1 – 48 Normal 1 – 16 The original data is only divided and rearranged. 16 variations are provided. Roll 1 – 16 In addition to division and rearrangement, some portions of the data may be played with a roll effect. 16 variations are provided. Break 1 – 16 In addition to division and rearrangement, some portions of the data may be deleted to create breaks. 16 variations are provided. Fill 1 – 48 In addition to division and rearrangement, some portions of the data may be played with a roll effect. 48 variations are provided.
Interval	Determines the measure(s) to which Remix is applied. Settings: 1 – 8 For example, when set to "1," Remix is applied to all measures. When set to "2," Remix is applied to measures 2, 4, 6, etc. (every other measure). When set to "3," Remix is applied to measures 3, 6, 9, etc. (every third measure).

[F6] CHAIN Refer to page 84 in the Quick Guide section.

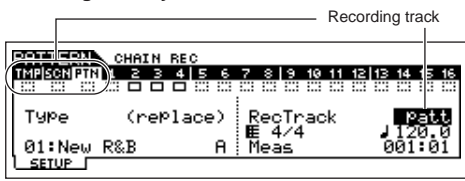
Pattern Chain Play mode	[PATTERN] → [F6] This mode lets you play the programmed section chain sequence created in the Pattern Record mode and Pattern Edit mode. The parameters are the same as in the [F1] PLAY display.
Pattern Chain Record mode	[PATTERN] → [F6] → [REC] Recording Standby mode  You can select one of the following tracks for recording. <ul style="list-style-type: none"> • patt (Pattern): Records section changes during playback • tempo: Records tempo change information during playback • scene: Records track mute settings during playback During Recording [PATTERN] → [F6] → [REC] → [▶] (Play) When recording the tempo track, you can change the tempo value. When recording the scene track, you can change the track mute setting. When recording the Pattern track, you can change the section.

Pattern Chain Edit mode	[PATTERN] → [F6] → [EDIT]
[F1] CHANGE	The Pattern Chain Edit mode makes it possible to edit the order of the sections in a chain, as well as insert tempo, and scene/mute event data. Call up the desired track display by pressing the [F4] TR SEL button to edit the selected track.
Pattern Track Edit	From this display, you can edit the section changes for each measure. Move the cursor to the "Section" column for the desired measure, and enter the desired section. To set the end of the chain, enter an END mark at the appropriate measure. To clear the event at the currently selected location, press the [F6] CLEAR button.
Scene Track Edit	You can edit the track mute change in beats. Use the [F5] INSERT and [F6] DELETE button to insert/delete the event.
Tempo Track Edit	You can edit the tempo change in beats. Use the [F5] INSERT and [F6] DELETE button to insert/delete the event.

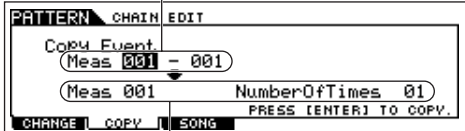
[F2] COPY	<p>Source range</p>  <p>Top measure of destination</p> <p>This display lets you copy all Pattern chain events from a specified range of measures (source) to a destination location. After specifying the source range in measures, the top measure of the destination location, and NumberOfTimes (number of times the data is copied), press the [ENTER] button to execute the Copy operation.</p> <p>CAUTION This operation overwrites any events already existing at the destination.</p>
------------------	--

[F3] SONG	This function converts the Pattern chain data to Song data (standard MIDI format) and places the results in the normal Song tracks. After specifying the desired destination Song and measure number to which the converted data is to be copied, then press the [ENTER] button to execute. CAUTION This operation overwrites any data already existing at the destination range.
------------------	--

Voice mode
 Performance mode
 Song mode
 Pattern mode
 Mixing Voice mode
 Utility mode
 File mode
 Master mode
 Reference

Pattern Record mode

[PATTERN] → Pattern selection → [REC]

Pattern Record Standby mode

[F1] SETUP

Type (Recording Type)	Determines the recording method. For information on each method, refer to page 138 in the Basic Structure section. Settings: replace, overdub, step NOTE Unlike in the Song Record mode, Punch recording is not available for Pattern recording.
Loop	Turns loop recording ON or OFF. When ON, the phrase will play repeatedly during real-time recording. This can be handy when recording drum parts (page 139), allowing you to add different instruments on each pass. When OFF recording stops after one pass through the phrase. Settings: on, off
Quantize	Same as in the Song Record mode. See page 179.
Event	Same as in the Song Record mode. See page 179.
♩ (Tempo)	Determines the Pattern tempo. Settings: 001.0 – 300.0 NOTE Unlike in Songs, Scene track and Tempo track are not available for Patterns.
Meas (Measure)	Determines the measure from which Pattern recording will be started.

[F2] VOICE

From this display you can set Voice-related parameters for the selected track. The settings made here affect the tone generator parts whose MIDI receive channels match the MIDI transmit channel of the song track. The Voice set here becomes the phrase Voice (page 79). Parameters are the same as in the Song Record mode. See page 180.

[F3] ARP (Arpeggio)

From this display you can set parameters related to the Arpeggio of the recording track. Parameters are the same as in the Song Record mode. See page 180.

[F4] REC ARP (Record Arpeggio)

From this display you can determine whether the sequence data played by Arpeggio is recorded to the Pattern track or not. Parameters are the same as in the Song Record mode. See page 180.

[F5] CLICK

Pressing the [F5] button lets you turn the click sound (metronome) on/off for recording.

During Pattern Recording

[PATTERN] → Pattern selection → [REC] → [▶] (Play)

Realtime Recording	Refer to page 82 in the Quick Guide section.
Step Recording	Examples of Step Recording are described on page 193. Parameters in the displays are the same as in the Song Record mode. See page 181.

Pattern Edit mode

[PATTERN] → Pattern selection → [EDIT]

Same as in the Song Edit mode. See page 182.

Voice mode

Performance mode

Song mode

Pattern mode

Mixing Voice mode

Utility mode

File mode

Master mode

Reference

Pattern Job mode [PATTERN] → Pattern selection → [JOB]

The Pattern Job mode contains a comprehensive set of editing tools and functions you can use to change the sound of the Pattern. It also includes a variety of convenient operations, such as copying or erasing data. After setting parameters as required from the selected display, press the [ENTER] button to execute the Job.

CAUTION

An “Executing...” message is shown when it takes a short amount of time to execute the Job. Never attempt to turn off the power while an “Executing...” message is shown. Turning the power off in this state results in loss of all user data.

[F1] UNDO/REDO

The Undo Job cancels the changes you made in your most recent recording session, editing session, or Job, restoring the data to its previous state. This allows you to recover from accidental data loss. Redo is available only after using Undo, and lets you restore the changes you made before undoing them.

CAUTION Undo/Redo does not work with Mixing Voice operations.

[F2] NOTE (Note data Job)

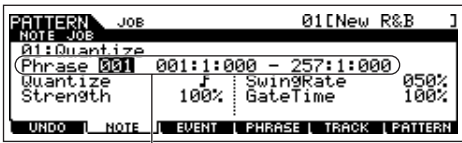

The Note data Jobs in the Pattern mode are basically same as in the Song Job mode. However, unlike in the Song Job mode, Pattern Note data Jobs are applied to the phrases (001 – 256) and a selected range in the phrase (measure : beat : clock).

Specify the phrase and the range (in measures/beats/clocks) over which the Job is applied.

01: Quantize	Same as in the Song Job mode. See page 183.
02: Modify Velocity	Same as in the Song Job mode. See page 184.
03: Modify Gate Time	Same as in the Song Job mode. See page 184.
04: Crescendo	Same as in the Song Job mode. See page 184.
05: Transpose	Same as in the Song Job mode. See page 185.
06: Glide	Same as in the Song Job mode. See page 185.
07: Create Roll	Same as in the Song Job mode. See page 185.
08: Sort Chord	Same as in the Song Job mode. See page 185.
09: Separate Chord	Same as in the Song Job mode. See page 185.



[F3] EVENT (Event Job)

The Event Jobs in the Pattern mode are basically same as in the Song Job mode. However, unlike in the Song Job mode, Pattern Event Jobs are applied to the phrases (001 – 256) and a selected range in the phrase (measure : beat : clock).

01: Shift Clock	Same as in the Song Job mode. See page 186.
02: Copy Event	Same as in the Song Job mode. See page 186.
03: Erase Event	Same as in the Song Job mode. See page 186. NOTE Unlike in the Song Job mode, “Tempo,” “Scene Memory,” or “Track Mute” cannot be selected as Event Types.
04: Extract Event	Same as in the Song Job mode. See page 186.
05: Create Continuous Data	Same as in the Song Job mode. See page 186. NOTE Unlike in the Song Job mode, “Tempo” cannot be selected as an Event Type.
06: Thin Out	Same as in the Song Job mode. See page 187.
07: Modify Control Data	Same as in the Song Job mode. See page 187. NOTE Unlike in the Song Job mode, “Tempo” cannot be selected as an Event Type.
08: Beat Stretch	Same as in the Song Job mode. See page 187.

[F4] PHRASE (Phrase Job)

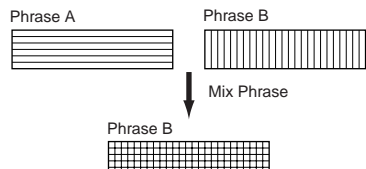
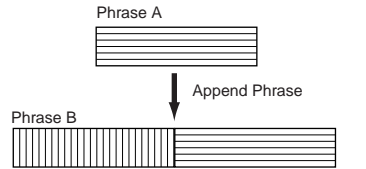
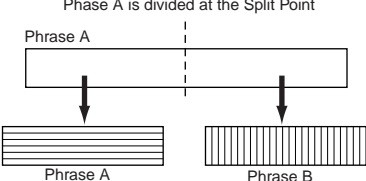
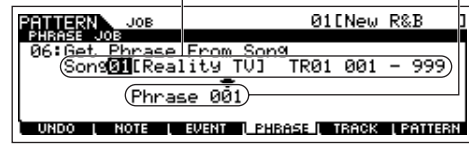
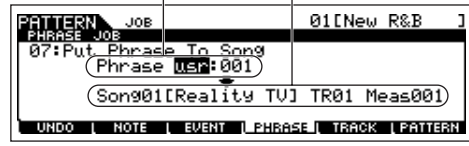
01: Copy Phrase	<p>Selects the Pattern and phrase to be copied. (Preset phrase also can be selected.)</p> <p>The screenshot shows the 'PHRASE JOB' screen for '01New R&B'. It displays '01:Copy Phrase' with 'Source' set to '01New R&B' and 'Destination' set to '01New R&B' with a range of 'Dr1:001'. The 'PHRASE' field is set to '004'. At the bottom, there are menu options: UNDO, NOTE, EVENT, PHRASE, TRACK, and PATTERN.</p> <p>Specify the destination Pattern and phrase.</p>	<p>This Job copies a selected phrase to the designated destination phrase. After specifying the source Pattern and phrase and the destination Pattern and phrase, press the [ENTER] button to execute this Job.</p> <p>CAUTION Any previous data in the copy destination will be overwritten.</p>
02: Exchange Phrase	<p>This Job exchanges or “swaps” the contents of two specified phrases (“A” and “B”).</p>	

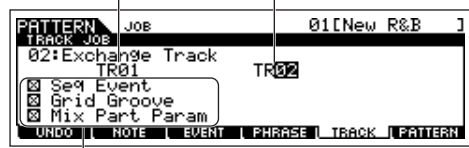
<p>03: Mix Phrase</p>	<p>This Job mixes all data from two selected user phrases ("A" and "B"), and places the result in phrase B.</p>	
<p>04: Append Phrase</p>	<p>This Job appends one phrase (A) to the end of another (B) to create one longer phrase (B).</p>	
<p>05: Split Phrase</p>	<p>This Job splits a selected phrase (A) into two separate phrases (A and B). The data before the split point is stored to the original phrase A and the data after the split point is moved and stored to another phrase B. You can also set the Meters of the phrase A and B after the Split Phrase Job.</p> <p>NOTE When either Pattern or Phrase is set to "off," the split Phrase B data is erased.</p> <p>CAUTION The Job overwrites any data already existing in destination phrase B.</p>	
<p>06: Get Phrase From Song</p>	<p>Source Song, track, and range of measures to be copied. Destination phrase</p> 	<p>This Job copies a segment of sequence-track data from a Song into the designated destination phrase.</p> <p>After specifying the source Song/track/range of measures to be copied and the destination phrase, press the [ENTER] button to execute this Job.</p> <p>CAUTION The Job overwrites any data already existing in the destination phrase.</p>
<p>07: Put Phrase To Song</p>	<p>Source phrase Destination Song, track, and top measures</p> 	<p>This Job copies a selected user phrase into a specified area of a selected song.</p> <p>After specifying the source phrase and destination Song/track/top measure, press the [ENTER] button to execute this Job.</p> <p>CAUTION The Job overwrites any data already existing in the destination track.</p>
<p>08: Clear Phrase</p>	<p>This Job deletes all data from the selected phrase.</p>	
<p>09: Phrase Name</p>	<p>This Job lets you assign a name (of up to eight characters) to the selected phrase. For instructions on naming, refer to page 38 in the Basic Operation section.</p>	
<p>[F5] TRACK (Track Job)</p>		
<p>01: Copy Track</p>	<p>Source Pattern, section, and track Destination Pattern, section, and track</p>  <p>Types of data to be copied</p>	<p>This Job copies all data from a specified source track to the specified destination track. The types of data to be copied are the same as in the Song Job mode. See page 188.</p>
<p>02: Exchange Track</p>	<p>Target tracks for the Exchange operation</p>  <p>Types of data to be exchanged</p>	<p>This Job exchanges or "swaps" the specified type of data between two specified tracks in the current Pattern and section. The types of data to be exchanged are the same as in the Song Job mode. See page 188.</p>

Voice mode
 Performance mode
 Song mode
 Pattern mode
 Mixing Voice mode
 Utility mode
 File mode
 Master mode

Reference

<p>03: Clear Track</p>	<p>Section and track from which data is to be cleared</p>  <p>Types of data to be cleared</p>	<p>This Job deletes all data of the selected type from the selected Pattern track. The types of data to be cleared are the same as in the Song Job mode. See page 188.</p>
<p>04: Normalize Play Effect</p>	<p>This Job rewrites the data in the selected track so that it incorporates the current Grid Groove settings. After specifying a track (TR 01 – 16) to which this Job is applied, press the [ENTER] button to execute this Job.</p>	
<p>05: Divide Drum Track</p>	<p>Separates the note events in a drum performance assigned to a specified track, and places the notes corresponding to different drum instruments in separate tracks (tracks 1 through 8). After specifying a track (TR 01 – 16) to which this Job is applied, press the [ENTER] button to execute this Job.</p> <p>NOTE This job requires 8 empty User Phrases. If there aren't enough empty tracks, an error message appears. If this happens, use the Clear Track Job (above) to delete some User Phrases, then try the Job again.</p>	
<p>06: Put Track To Arp</p>	<p>This Job copies data in the specified measures of a section/track for creating Arpeggio data. For details, refer to page 97 in the Quick Guide section.</p>	

[F6] PATTERN (Pattern Job)

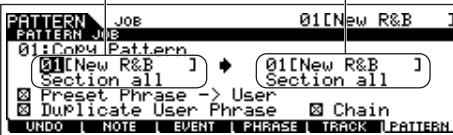
<p>01: Copy Pattern</p>	<p>Source Pattern and section Destination Pattern and section</p> 	<p>This Job copies all data from a selected source Pattern to a selected destination Pattern. After specifying the source Pattern/section, and the destination Pattern/section, as well as setting the checkboxes as necessary, press the [ENTER] button to execute this Job.</p>
<p>NOTE If you set the source section to "all," the destination section is also set to "all" automatically. With this status, execute this Job to copy the entire source Pattern data to the destination.</p>		
<p>Preset Phrase → User</p>	<p>When this box is checkmarked, Preset Phrases (if included in the source Pattern) are copied to the User Phrase, which will be assigned to the destination Pattern.</p>	
<p>Duplicate User Phrase</p>	<p>When this box is checkmarked, User Phrases (if included in the source Pattern) are copied to another User Phrase, which will be assigned to the destination Pattern. However, if the Pattern number of the source is same as the number of destination, another User Phrase will be not created.</p>	
<p>Chain</p>	<p>When this box is checkmarked, Pattern chain data (if included in the source Pattern) is copied to the destination Pattern.</p>	

<p>02: Append Pattern</p>	<p>Source Pattern and section Destination Pattern and section</p> 	<p>Appends one Pattern to the end of another to create one longer Pattern with all 16 tracks.</p> <p>NOTE If the Pattern length becomes greater than 256 measures as a result of the Append Pattern Job, an error message will be displayed and the Job will be aborted.</p>
<p>Keep Original Phrase</p>	<p>When this box is checkmarked, the original destination Pattern data is retained in memory, along with the new appended Pattern data. If the box is not checkmarked, the original destination Pattern is erased and replaced with the newly created data.</p> <p>NOTE When the KEEP ORIGINAL PHRASE checkbox is checked, this Job requires twice the number of empty user phrases as the number of tracks containing data in which to store the appended phrase data. If the required space is unavailable, an alert message will appear and the Job will be aborted. If this occurs use the Clear Phrase Job (page 200) to delete unused phrases and try again.</p>	

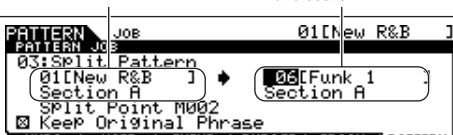
<p>03: Split Pattern</p>	<p>Source Pattern and section Destination Pattern and section</p> 	<p>This Job splits a selected Pattern (all 16 tracks data) into two Patterns. After the Split Pattern operation, the part of the Pattern before the specified Split Point will remain, and the part following the Split Point will be moved to the destination Pattern.</p> <p>CAUTION The Job overwrites any data already existing in the destination Pattern.</p>
<p>Split Point</p>	<p>Determines the Split Point by setting a measure number.</p>	
<p>Keep Original Phrase</p>	<p>When this box is checkmarked, the original Source Pattern data is retained in memory and the results of the Split Job are written to empty phrases. When this box is not checkmarked, the original Source Pattern is erased and replaced with the newly created data.</p>	

NOTE When the KEEP ORIGINAL PHRASE checkbox is checked, this Job requires twice the number of empty user phrases as the number of tracks containing data in which to store the appended phrase data. If the required space is unavailable, an alert message will appear and the job will be aborted. If this occurs use the Clear Phrase Job (page 200) to delete unused phrases and try again.

Voice mode
 Performance mode
 Song mode
 Pattern mode
 Mixing Voice mode
 Utility mode
 File mode
 Master mode

Reference

04: Clear Pattern	This Job deletes all data from the selected Pattern, or from all Patterns. When the specific section is selected to be cleared, you can unmark the Chain box. If the Chain box is not checkmarked, the Pattern Chain data will be kept even though the Clear Pattern Job is executed.
05: Pattern Name	This Job lets you assign a name to the selected Pattern. For instructions on naming, refer to page 38 in the Basic Operation section.

Pattern Mixing mode

[PATTERN] → Pattern selection → [MIXING]

In this mode, you can set up mixing data for your patterns, and set various parameters for the tone generator parts—including the desired Voice, as well as its level, pan, EQ, effect and other settings.

Pattern Mixing parameters are not actually part of the Pattern sequence data in each track, but rather are settings for the tone generator, as it is played back by the Pattern data. As such, the Pattern Mixing parameter settings are not recorded to the Pattern tracks.

Mixing operations and parameters are the same as those of the Song Mixing mode. See page 189.

CAUTION

Parameter settings made in the Pattern Mixing mode and Pattern Mixing Edit mode should be stored to internal memory (DRAM) as part of the Pattern data. In addition, make sure to save the entire Pattern data (including the Mixing settings) to the USB storage device, since the data in DRAM is stored only temporarily (page 150).

NOTE Parameter settings in the Pattern Mixing mode and Pattern Mixing Edit mode can be stored as a template to internal Flash ROM, as well as being stored as part of a Pattern. See page 94 for details.

Pattern Mixing Edit mode

[PATTERN] → Pattern selection → [MIXING] → [EDIT]

This mode provides more detailed Mixing parameters than in the Pattern Mixing mode.

Keep in mind that Pattern Mixing parameters are not actually part of the Pattern sequence data in each track, but rather are settings for the tone generator, as it is played back by the Pattern data. As such, the Pattern Mixing parameter settings are not recorded to the pattern tracks.

Mixing operations and parameters are the same as those of the Song Mixing Edit mode. See page 190.

CAUTION

Parameter settings made in the Pattern Mixing mode and Pattern Mixing Edit mode should be stored to internal memory (DRAM) as part of the Pattern data. In addition, make sure to save the entire Pattern data (including the Mixing settings) to the USB storage device, since the data in DRAM is stored only temporarily (page 150).

NOTE Parameter settings in the Pattern Mixing mode and Pattern Mixing Edit mode can be stored as a template to internal Flash ROM, as well as being stored as part of a Pattern. See page 94 for details.

Pattern Mixing Job mode

[PATTERN] → Pattern selection → [MIXING] → [JOB]

Same as in the Song Mixing Job mode. See page 192.

Pattern Mixing Store mode

[PATTERN] → Pattern selection → [MIXING] → [STORE]

This function lets you store your edited Pattern Mixing to User memory (DRAM).

For details, refer to page 98 in the Quick Guide section.

Mixing Voice mode

■ Creating Mixing Voices — basic procedure

The Mixing Voice mode provides most of the same Normal Voice editing parameters as the Voice mode, with the main exception that these Voices are dedicated for use with the Songs and Patterns, and are stored specifically as Mixing Voices. The Mixing Voice Job mode lets you use the supplementary functions like Copy and Delete. After completing the Mixing Voice editing, you can store the edited Voice to a User Bank to internal memory (Flash ROM) or you can store it as a part of the current Song/Pattern data to internal memory (DRAM). When storing the edited Mixing Voice as a part of the current Song/Pattern data, make sure to save the data to a USB storage device in the File mode.

Mixing Voice Edit mode	[SONG] or [PATTERN] → [MIXING] → [F2] VOICE → Normal Voice selection → [F5] VCE ED
-------------------------------	---

The Mixing Voice Edit mode is divided into Common Edit, for setting parameters common to all four Elements, and Element Edit, for setting parameters of individual Elements.

Common Edit	[SONG] or [PATTERN] → [MIXING] → [F2] VOICE → Normal Voice selection → [F5] VCE ED → [COMMON]
--------------------	--

These parameters are for making global (or common) edits to all four Elements of the selected Normal Voice.

NOTE The Mixing Voice Edit parameters are basically the same as those in the Voice Edit mode. However, some parameters having the same name as those in the Song Mixing/Pattern Mixing Part Edit mode are not available in the Mixing Voice Edit mode.

[F1] GENERAL
Same as in the Normal Voice Common Edit mode. See page 153. Please note that the [SF3] MEQ OFS (Master EQ Offset) display is not available in the Mixing Voice Edit mode.
[F2] OUTPUT
Same as in the Normal Voice Common Edit mode. See page 154.
[F4] CTL SET (Controller Set)
Same as in the Normal Voice Common Edit mode. See page 155.
[F5] LFO
Same as in the Normal Voice Common Edit mode. See page 156.
[F6] EFFECT
Same as in the Normal Voice Common Edit mode. See page 158. Please note that the [SF4] REVERB and [SF5] CHORUS displays are not available in the Mixing Voice Edit mode.
NOTE When the Insertion Switch of the selected Part is off (page 191), this display will be unavailable.

Element Edit	[SONG] or [PATTERN] → [MIXING] → [F2] VOICE → Normal Voice selection → [F5] VCE ED → Element selection
---------------------	---

These parameters are for editing the individual Elements that make up a Normal Voice.

[F1] OSC (Oscillator)
Same as in the Normal Voice Element Edit mode. See page 158.
[F2] PITCH
Same as in the Normal Voice Element Edit mode. See page 159.
[F3] FILTER
Same as in the Normal Voice Element Edit mode. See page 160.
[F4] AMP (Amplitude)
Same as in the Normal Voice Element Edit mode. See page 162.
[F5] LFO (Low Frequency Oscillator)
Same as in the Normal Voice Element Edit mode. See page 163.
[F6] EQ (Equalizer)
Same as in the Normal Voice Element Edit mode. See page 164.

Voice mode
Performance mode
Song mode
Pattern mode
Mixing Voice mode
Utility mode
File mode
Master mode
Reference

Mixing Voice Job mode

[SONG] or [PATTERN] → [MIXING] → [F5] VCE ED → [JOB]

The Mixing Voice Job mode features two basic operations, Copy and Delete. After setting parameters as required from the selected display, press the [ENTER] button to execute the Job.

[F2] RECALL

If you are editing a Mixing Voice and select a different Mixing Voice, Mixing program, Song or Pattern without storing your edited one, all the edits you've made will be erased. Edits are also erased if the current part to which the edited Mixing Voice is assigned receives a program change from an external MIDI instrument.

If this happens, you can use Edit Recall to restore the Mixing Voice with your latest edits intact by pressing the [ENTER] button from the [F2] RECALL display.

NOTE Since a Recall Buffer for the Mixing Voice is prepared for each Part of the current Song or Pattern, you can specify the Part to which the Mixing Voice to be recalled is assigned before executing the Edit Recall.

[F3] COPY

Source song/pattern and part

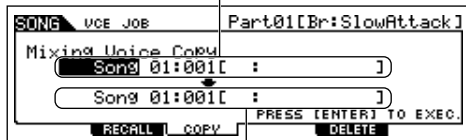

Destination song/pattern and part

This Job lets you copy the Mixing Voice stored to a specified Part in one Song/Pattern to a Part in another Song/Pattern.

[F5] DELETE

This Job lets you delete a Mixing Voice assigned to a specified Song/Pattern's Part.

Mixing Voice Store mode

[SONG] or [PATTERN] → [MIXING] → [F5] VCE ED → [STORE]

This function lets you store your edited Mixing Voice to User memory (Flash ROM or DRAM). For details, refer to page 78 in the Quick Guide section.

Utility mode

The Utility mode features a variety of important settings related to overall operation of the MO. These settings can also be stored—simply press the [STORE] button from any mode (with the exception of the Utility Job mode), and store the data to internal Flash ROM as system settings (page 150). You can also save the settings to a USB storage device in the File mode.

Utility mode

[UTILITY]

In this mode, you can set parameters that apply to the entire system of this instrument.

This mode is actually a sub-mode of the Voice/Performance/Song/Pattern mode. Press the [UTILITY] button in each mode to enter the Utility mode and press the [EXIT] button after making settings to go back to the previous mode.

[F1] GENERAL	
[SF1] TG (Tone Generator)	From this display you can make overall settings for the internal tone generator. Settings here do not affect MIDI messages transmitted to the external MIDI instrument.
Volume	Determines the overall volume of the instrument. Settings: 0 – 127
NoteShift	Determines the amount (in semitones) by which the pitch of all notes is shifted. Settings: -24 – 0 – +24
Tune	Determines the fine tuning (in 0.1 cent steps) of the internal tone generator's overall sound. Settings: -102.4 – +102.3
BCCurve (Breath Controller Curve)	<p>These four curves determine how the sound of the internal tone generator responds to use of a Breath Controller. The setting here affects the Destination parameters when the Source is set to "BC," both of which can be set in the CTL SET displays ([VOICE] → [EDIT] → [COMMON] → [F4] CTL SET). The graph shown in the display indicates the controller response curve. (The horizontal line represents the received breath control values, while the vertical line represents the actual response of the internal tone generator.)</p> <p>NOTE The MO does not have the Breath Controller jack. However, keep in mind that if the same MIDI Control Change messages as Controller Set are received from an external device, the internal tone generator also responds to those messages as if the unsupported/unavailable MIDI controller was used on the MO.</p> <p>Settings: thru, soft, hard, wide</p>
[SF2] KBD (Keyboard)	From this display you can set the keyboard-related parameters. The settings here affect the MIDI messages generated by playing the keyboard.
Octave	Determines the amount in octaves by which the range of the keyboard is shifted up or down. This setting can be changed also by pressing any of the [OCTAVE] buttons on the MO6. Settings: -3 – 0 – +3
Transpose	Determines the amount in semitones by which the range of the keyboard is shifted up or down. Settings: -11 – 0 – +11 NOTE If you transpose beyond the note range limits (C-2 and G8), notes in the adjacent octaves will be used. For example, a transposed note of F9 will be changed to F8.
VelCurve (Velocity Curve)	<p>These five curves determine how the actual velocity will be generated and transmitted according to the velocity (strength) with which you play notes on the keyboard. The graph shown in the display indicates the velocity response curve. (The horizontal line represents the received velocity values (strength of your playing), while the vertical line represents the actual velocity values transmitted to the internal/external tone generators.)</p> <p>Settings: norm, soft, hard, wide, fixed</p> <p>norm (normal)..... This linear "curve" produces one-to-one correspondence between the strength of your keyboard playing (velocity) and the actual sound change.</p> <p>soft..... This curve provides increased response, especially for lower velocities. In other words, playing softly results in higher response than the "norm" curve.</p> <p>hard..... This curve provides increased response, especially for higher velocities. In other words, playing hard results in higher response than the "norm" curve.</p> <p>wide..... This setting provides opposite response curves for lower and higher velocities. It widens the apparent dynamic range of the controller, producing less sound change in the softer range and more change in the higher range.</p> <p>fixed..... This setting produces the same amount of sound change (set in Fixed Velocity below), no matter what your playing strength.</p>
FixedVelocity	This parameter is only available if you select the "fixed" Velocity Curve above. The velocity of the note you play is fixed at the value set here. Settings: 1 – 127
[SF3] EF BYPS (Effect Bypass)	From this display you can select the specific effect(s) to be bypassed when the [EFFECT BYPASS] button is turned on.
Insertion	When this is set to on and the [EFFECT BYPASS] button is turned on, the internal Insertion Effect is bypassed.
System	
▶ Reverb	When this is set to on and the [EFFECT BYPASS] button is turned on, the Reverb effect is bypassed.
▶ Chorus	When this is set to on and the [EFFECT BYPASS] button is turned on, the Chorus effect is bypassed.
NOTE	For details about the Effects, see page 140.

[SF4] OTHER	
AutoLoad	Determines whether the Auto Load function is on or off. When this is on, the instrument will automatically load the specified files (from USB storage device) to User memory—whenever the power is turned on. For details about the Auto Load function, see page 102. Settings: on, off
PowerOnMode	This determines the default power-on mode (and memory bank)—letting you select which condition is automatically called up when you turn the power on. Settings: performance, voice (USR1), voice (PRE1), GM, last, master performancePerformance Play mode (User Performance 001) voice (USR1).....Voice Play mode (User Voice "USR1: 001") voice (PRE1).....Voice Play mode (Preset Voice "PRE 1: 001") GMVoice Play mode (GM Voices "GM: 001") lastThe mode and program number registered the last time by the procedure on page 210. masterMaster Play mode (User Master 001)
CtrlReset (Controller Reset)	Determines the status of the controllers (Modulation Wheel, Aftertouch, Foot Controller, Breath Controller, Knobs, etc.) when switching between voices. When this is set to "hold," the controllers are kept at the current setting. When this is set to "reset," the controllers are reset to the default states (below). Settings: reset, hold If you select "reset," the controllers will be reset to the following states/positions: Pitch Bend Center Modulation Wheel Minimum Aftertouch Minimum Foot Controller Maximum Breath Controller Maximum Foot Switch Off Expression Maximum Foot Volume Maximum Sustain Off

[F2] OUTPUT

L&RGain	Set the output gain of the L/MONO and R jacks. Settings: 0dB, +6dB
--------------------	--

[F3] VOICE [VOICE] → [UTILITY] → [F3]

These special voice-related settings are available only when entering the Utility mode from the Voice mode, letting you set parameters related to all the Voices.

[SF1] MEQ (Master EQ)	From this display you can apply five-band equalization to all Voices, raising or lowering the level of each frequency band (LOW, LOWMID, MID, HIGHMID, HIGH). The parameters are the same as in the Performance Common Edit. See page 172. Settings: For details about EQ, see page 141.
------------------------------	--

[SF2] MEF (Master Effect)	From this display you can set the Master Effect related parameters applied to all the Voices. The parameters are the same as in the Performance Common Edit. See page 172.
----------------------------------	--

[SF3] ARP CH (Arpeggio Channel)	From this display you can set parameters related to output of the Arpeggio MIDI data in the Voice mode.
--	---

OutputSwitch	This enables or disables MIDI data output for the Arpeggio function. When this is set to "on," Arpeggio data is sent via MIDI—allowing you to send the Arpeggio data to an external sequencer or play back the Arpeggios on connected MIDI tone generators. Settings: on (enable), off (disable)
---------------------	--

TransmitCh (Transmit channel)	Determines the MIDI channel through which Arpeggio playback data will be sent (when Output Switch above is on). Settings: 1 – 16
--------------------------------------	--

[SF4] CTL ASN (Controller Assign)	Sets the parameters related to the controllers in the Voice mode. Details on each parameter are the same as in Performance Common Edit. See page 173.
--	---

[F3] SEQ (Sequencer) [SONG] or [PATTERN] → [UTILITY] → [F3]

These special song- and pattern-related settings are available only when entering the Utility mode from the Song or Pattern mode.

[SF1] CLICK	From this display you can set the parameters related to the click sound (metronome) that is used during recording or playback in the Song/Pattern mode.
--------------------	---

Mode	Determines whether and when the metronome click will sound. Settings: off, rec, rec/play, all offThe click will not sound. recThe click will sound during song/pattern recording only. rec/playThe click will sound during song/pattern recording and playback. allThe click will always sound.
-------------	---

Beat	Determines on which beats the metronome click will sound. Settings: 16 (16th notes), 08 (8th notes), 04 (quarter notes), 02 (half notes), 01 (whole notes)
-------------	--

Volume	Determines the click sound volume. Settings: 0 – 127
---------------	--

Type	Determines the click sound type. Settings: 1 – 10
-------------	---

Reference
Voice mode
Performance mode
Song mode
Pattern mode
Mixing Voice mode
Utility mode
File mode
Master mode

RecCount	<p>Sets the number of count-in measures provided before recording actually starts after pressing the [▶] (Play) button in the Record standby mode.</p> <p>Settings: off (Recording starts as soon as the [▶] button is pressed), 1 meas – 8 meas</p>
<p>NOTE Since the click sound is created with the internal tone generator, using click playback affects the overall polyphony of this synthesizer.</p>	
[SF2] FILTER (MIDI Filter)	<p>From this display you can set which MIDI events will be recognized/transmitted via MIDI. The settings made here apply only to Song/Pattern playback data; they do not affect the MIDI events generated by your keyboard playing or panel operations in the Voice and Performance modes.</p> <p>MIDI events to which the Filter is applied: Note, PgmChange (Program Change), CtrlChange (Control Change), PB (Pitch Bend), ChAt (Channel Aftertouch), PolyAT (Polyphonic Aftertouch), Exclusive</p>
[SF3] OTHER	
PtnQuantize (Pattern Quantize)	<p>Determines the quantize value for Pattern switching during playback. When set to "1," Patterns (sections) will always switch on the first beat of the measure during playback. When "1/16" is selected, Patterns (sections) can be switched on any 16th beat during playback.</p> <p>Settings: 1 (1 measure), 1/2 (Half note), 1/4 (Quarter note), 1/8 (8th note), 1/16 (16th note)</p>
PtnTempoHold (Pattern Tempo Hold)	<p>Determines whether or not the tempo setting will switch to the tempo value stored with each Pattern when a new Pattern is selected during playback. When set to "on," the tempo will be retained when Patterns are switched. When set to "off," the tempo will switch to that stored with the new Pattern when Patterns are switched.</p> <p>Settings: on, off</p> <p>NOTE The tempo setting data in the Pattern Chain is not affected by this parameter.</p>
SongEventChase	<p>Event Chase allows you to specify which non-note data types are properly recognized during fast-forward and rewind operations. Normally, if a Song or Pattern is played back from mid-point and/or fast-forward or rewind are used, certain data types (such as Program Change, Pitch Bend, and Control Change) may not play back as expected. Setting this to a specific event ensures the playback integrity of the event, even when fast forwarding or rewinding.</p> <p>Settings: Off, PC (Program Change), PC+PB+Ctrl (Program Change+Pitch Bend+Control Change), all (All events)</p> <p>NOTE Keep in mind that settings other than "off" may result in slower operation—for example, a pause before starting playback, or slower rewind/fast forward speed.</p> <p>NOTE When this is set to "all," an excessive amount of MIDI data may be generated, possibly resulting in a MIDI error on the connected device.</p>
DumpInterval (Bulk Dump Interval Time)	<p>When playing back system exclusive data (bulk data) that is recorded on the sequence tracks, this sets the interval that is inserted for each 1KB.</p> <p>When sending bulk data from this synthesizer to a connected MIDI device, a MIDI error may result if the device cannot handle large amounts of data in a short time. This parameter compensates for that by setting an interval that provides enough time for the receiving device to process the bulk data.</p> <p>Settings: 0 – 900 (msec)</p> <p>NOTE The playback may be a little slower depending on the currently set interval. Also when a MIDI error occurs, try to set the interval a little higher and send the data again.</p>
LoadMix	<p>Determines whether the Mixing settings are loaded (on) or not (off) when the Song/Pattern number is changed.</p> <p>Settings: off, on</p> <p>NOTE This setting affects the Song/Pattern change during Song/Pattern chain playback.</p>

[SF4] QUICK SET

If you use the MO for a variety of sequencer based applications and switch between those applications, the Quick Setup comes in handy. It allows you to instantly reconfigure the instrument for four different applications. The following parameters are changed in Quick Setup.

- [UTILITY] → [F5] MIDI → [SF2] SWITCH → Local Ctrl
- [UTILITY] → [F5] MIDI → [SF3] SYNC → MIDI Sync
- [UTILITY] → [F5] MIDI → [SF3] SYNC → SeqCtrl
- [SONG]/[PATTERN] → [F3] TRACK → [SF3] OUT SW → INT SW, EXT SW
- [SONG]/[PATTERN] → [REC] → [F4] RECARP → OutputSwitch

NOTE The INT SW, EXT SW, and OutputSwitch parameters are set for each Song/Pattern. Therefore, when changing a Song/Pattern number, the parameter values are changed. Make sure to execute Quick Setup again after changing a Song/Pattern.

NOTE When the MIDI Sync parameter is set to "MIDI," you can only use the Arpeggio while receiving Timing Clock (MIDI Clock) messages from the external sequencer. Keep in mind that some sequencers only transmit Timing Clock messages during playback of the song file.

1. When using only the MO

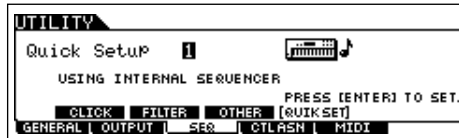

- LocalCtrl..... on
- MIDI Sync..... internal
- SeqCtrl..... in/out
- INT SW..... on (all tracks)
- EXT SW..... on (all tracks)
- OutputSwitch..... off

2. When recording a Song on the MO to a computer/sequencer

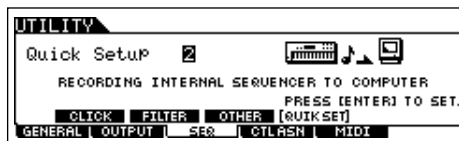

- LocalCtrl..... off
- MIDI Sync..... midi
- SeqCtrl..... in
- INT SW..... off (all tracks)
- EXT SW..... on (all tracks)
- OutputSwitch..... off

Set the MIDI Thru (MIDI Echo) setting in the sequencer to on.

3. When using the MO as a tone generator for a computer/sequencer

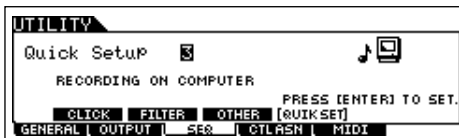

- LocalCtrl..... off
- MIDI Sync..... internal
- SeqCtrl..... off
- INT SW..... off (all tracks)
- EXT SW..... on (all tracks)
- OutputSwitch..... off

Set the MIDI Thru (MIDI Echo) setting in the sequencer to on. If you wish to synchronize the MO's Arpeggio with the tempo setting on the computer sequencer, set the MIDI Sync parameter to "MIDI."

4. When recording the Arpeggio to a computer/sequencer

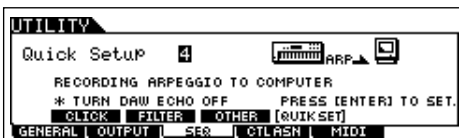

- LocalCtrl..... on
- MIDI Sync..... MIDI
- SeqCtrl..... in
- INT SW..... on (all tracks)
- EXT SW..... on (all tracks)
- OutputSwitch..... on

Set the MIDI Thru (MIDI Echo) setting in the sequencer to off.

NOTE When playing back the song data including the Arpeggio MIDI data, turn the [ARPEGGIO ON/OFF] button off.

[F4] CTL ASN (Controller Assign)

[SF1] ARP (Arpeggio)

Switch	Determines the Control Change Number that controls on/off status of Arpeggio playback. Settings: 00 – 95
Hold	Determines the Control Change Number that controls on/off status of Arpeggio Hold (page 152). Settings: 00 – 95

[SF2] ASSIGN

**ASA (Assign A)
Dest (Destination)**

You can assign specific functions to the Knob 1 and 2 (ASSIGN A and B) when the [PAN/SEND] and [TONE] lamps are on. Two parameters are available here. The first (ASA) determines the Control Change number generated by the ASSIGN A knob. The second, Destination (Dest), determines what parameter or aspect of the sound is affected by the knob. Keep in mind that if the same MIDI Control Change messages as set here are received from an external device, the internal tone generator also responds to those messages.
Settings: Refer to the separate Data List booklet.

**ASB (Assign B)
Dest (Destination)**

Two parameters are available here. The first (ASB) determines the Control Change number generated by the ASSIGN B knob. The second, Destination (Dest), determines what parameter or aspect of the sound is affected by the knob. Keep in mind that if the same MIDI Control Change messages as set here are received from an external device, the internal tone generator also responds to those messages.
Settings: Refer to the separate Data List booklet.

Voice mode
Performance mode
Song mode
Pattern mode
Mixing Voice mode
Utility mode
File mode
Master mode

Reference

[SF3] FT SW (Footswitch)	
FSAssign (Footswitch Assign)	<p>From this display you can determine the Control Change number generated by using the Footswitch connected to the FOOT SWITCH jack. Keep in mind that if the same MIDI Control Change messages set here are received from an external device, the internal tone generator also responds to those messages as if the Footswitch of the instrument was used.</p> <p>Settings: 000 – 101 (000, 032: off, 096: Arpeggio Switch, 097: Arpeggio Hold, 098: playback start/stop in the Sequence Play mode, 099/100: Program Change INC/DEC 101: Octave Rest)</p>
[SF4] REMOTE	<p>Two different computer software control modes can be selected here, as well as the respective MIDI port settings for control. When you've made the desired settings, press the [ENTER] button to actually call up the preset control templates for the software. For details, refer to the Quick Guide on page 113.</p>
[SF5] MEF (Master Effect)	<p>From this display you can set the parameters related to the Master Effect Control slider operations. (Press both the [ARP FX] and [EQ] buttons so that their lamps light.)</p>
Knob1 – Knob4	<p>Assigns a parameter of the Master Effect to each Knob. Available parameters differ depending on the selected Master Effect type.</p>
[F5] MIDI	
[SF1] CH (Channel)	<p>From this display you can make basic MIDI settings.</p>
BasicRcvCh (Basic Receive Channel)	<p>Determines the MIDI receive channel when this synthesizer is set to single-timbre tone generator mode (Voice/ Performance modes).</p> <p>Settings: 1 – 16, omni (all channels), off</p> <p>NOTE In the multi-timbral tone generator mode (Song and Pattern modes), each Part receives MIDI data according to its assigned MIDI receive channel ([SONG] or [PATTERN] → [MIXING] → [EDIT] → Part selection → [F1] VOICE → [SF2] MODE → ReceiveCh).</p>
KBDTransCh (Keyboard Transmit Channel)	<p>Determines the MIDI channel over which the instrument sends MIDI data (to an external sequencer, tone generator, or other device). This parameter is available in the single-timbre tone generator mode (Voice/ Performance modes).</p> <p>Settings: 1 – 16, off</p> <p>NOTE In the multi-timbral tone generator mode (Song and Pattern modes), MIDI data generated by playing the keyboard (and its controllers) is sent to the internal tone generator and external devices via the MIDI output channel, which corresponds to the selected Part number.</p>
DeviceNo. (Device Number)	<p>Determines the device number used by this synthesizer in receiving or transmitting data. This number must match the Device Number of the external MIDI device when transmitting/receiving bulk data, parameter changes or other system exclusive messages.</p> <p>Settings: 1 – 16, all, off</p>
[SF2] SWITCH	
BankSel	<p>This switch enables or disables Bank Select messages, both in transmission and reception. When this is set to "on," this synthesizer responds to incoming Bank Select messages, and it also transmits appropriate Bank Select messages (when using the panel).</p> <p>Settings: off, on</p>
PgmChange (Program Change)	<p>This switch enables or disables Program Change messages, both in transmission and reception. When this is set to "on," this synthesizer responds to incoming Program Change messages, and it also transmits appropriate Program Change messages (when using the panel).</p> <p>Settings: off, on</p>
CtrlChange (Control Change mode)	<p>Determines how this synthesizer receives and recognizes the AEG Sustain MIDI message. When set to mode1, it is received as a Parameter Change. When set to mode2, it is received as a Control Change message.</p> <p>Settings: mode1, mode2</p>
LocalCtrl (Local Control On/Off)	<p>This determines whether or not the tone generator of the instrument responds to your keyboard playing. Normally, this should be set to "on"—since you'll want to hear the sound of the MO as you play it. However, for external sequencer applications, you may need to set this to "off" to avoid getting "double" notes, in which the tone generator of the instrument is played twice—once by the keyboard and once again by the keyboard data routed through the sequencer.</p> <p>Even if this is set to "off," the data will be transmitted via MIDI. Also, the internal tone generator block will respond to messages received via MIDI.</p> <p>Settings: off, on</p>
RcvBulk (Receive Bulk)	<p>Determines whether or not Bulk Dump data can be received.</p> <p>Settings: protect (not received), on (received)</p>

[SF3] SYNC (Synchronization)	From this display you can set various parameters related to MIDI clock and synchronization.
MIDI Sync	<p>Determines whether Song/Pattern/Arpeggio playback will be synchronized to the instrument's internal clock or an external MIDI clock.</p> <p>Settings: internal, MIDI, MTC</p> <p>internalSynchronization to internal clock. Use this setting when this synthesizer is to be used alone or as the master clock source for other equipment.</p> <p>MIDISynchronization to a MIDI clock received from an external MIDI instrument via MIDI.</p> <p>MTC (MIDI Time Code).....Synchronization to an MTC signal received via MIDI. MMC signals are transmitted via MIDI. Use this setting when this synthesizer is to be used as a MIDI slave, such as when synchronized to an MTC-capable MTR. The MTC Sync function is available only in the Song mode.</p> <p>NOTE Please keep in mind that the song or pattern will not start even if you press the [▶] (Play) button when the MIDI Sync is set to other than "internal."</p> <p>NOTE MTC (MIDI Time Code) allows simultaneous synchronization of multiple audio devices via standard MIDI cables. It includes data corresponding to hours, minutes, seconds, and frames. This synthesizer does not transmit MTC. A device such as the Yamaha AW2400 is necessary in order to use this synthesizer as an MTC master.</p> <p>NOTE MMC (MIDI Machine Control) allows remote control of multitrack recorders, MIDI sequencers, etc. A MMC-compatible multitrack recorder, for example, will automatically respond to start, stop, fast forward, and fast reverse operations performed on the controlling sequencer, thus keeping playback of the sequencer and multitrack recorder aligned.</p>
ClockOut	<p>Determines whether MIDI clock (F8) messages will be transmitted via MIDI.</p> <p>Settings: on (transmitted), off</p>
SeqCtrl (Sequencer Control)	<p>Determines whether Sequencer Control signals—start, continue, stop, and song position pointer—will be received and/or transmitted via MIDI.</p> <p>Settings: off, in, out, in/out</p> <p>offNot transmitted/recognized.</p> <p>inRecognized but not transmitted.</p> <p>outTransmitted but not recognized.</p> <p>in/outTransmitted/recognized.</p>
MTC StartOffset	<p>Determines the specific time code point from which sequence playback starts, when MTC is received. This feature can be used to accurately align playback of this synthesizer with an external MTC-compatible device.</p> <p>Settings: Hour : Minute : Second : Frame</p> <p>Hour00 – 23</p> <p>Minute00 – 59</p> <p>Second00 – 59</p> <p>Frame00 – 29</p>
[SF4] OTHER	
MIDI IN/OUT	<p>Determines which physical output terminal(s) will be used for transmitting/receiving MIDI data: MIDI IN/OUT or USB.</p> <p>Settings: MIDI, USB</p> <p>NOTE Two types of terminals above cannot be used at the same time.</p>
ThruPort (Through Port)	<p>Many computer sequencers are capable of transmitting data over several MIDI ports, effectively breaking the 16-channel barrier. When using the USB terminal for MIDI transmission/reception, you can have this synthesizer respond to MIDI data over one port, while relaying the data for another port number (you can set here) to a separate tone generator (connected to the MIDI OUT terminal).</p> <p>In this way, 16 channels of data can be played on this synthesizer and another 16 can be played on the connected MIDI device.</p> <p>Settings: 1 – 8</p>
BulkInterval (Bulk Interval)	<p>Determines an interval time for transmitting the bulk data, when using the Bulk Dump function on the MO (page 148) or receiving Bulk Request messages from an external device.</p>

Reference

Utility Job mode

[UTILITY] → [JOB]

In this Mode, you can restore this synthesizer's User memory (page 149) to the factory default settings (Factory Set). For details, see page 26.

Supplementary

Setting the default display when turning the power on

[UTILITY] → [F1] GENERAL → [SF4] OTHER → PowerOnMode

- 1 Enter the desired mode and the program number you wish to call up first when turning the power on.
- 2 Press the [ENTER] button while holding the [STORE] button to register the mode and program number set in step 1.
- 3 Set the PowerOnMode parameter to "last" in the [UTILITY] → [F1] GENERAL → [SF4] OTHER display.
- 4 Press the [STORE] button to store the Utility setting made in step 3 above.
- 5 Turn the power off and turn the power on again to call up the mode/program number set in step 2 to the display.

File mode

The File mode provides tools for transferring data between the instrument and USB storage device.

NOTE For details about USB storage devices, see page 31.

NOTE For details about the relationship between the data created on this synthesizer and the files for saving, see page 149.

File mode

[FILE]

NOTE For information on how to select a file/folder and how to create a new folder, see page 213.

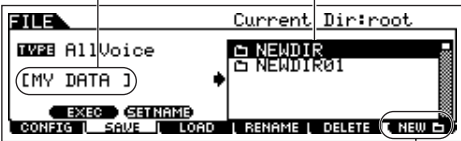
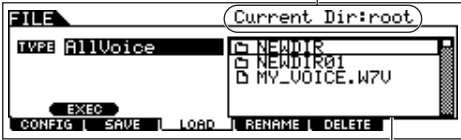
[F1] CONFIG	
[SF1] CURRENT	From this display you can set the parameters about the currently recognized USB storage device.
USB Device	Select the partition in the device. You can transfer files between the partition in the slot selected below and this instrument.
▶ Slot	If using a USB storage device compatible with multiple media, select the slot number. The desired partition can be selected in the right box.
Status	Indicates the status of the storage device recognized by this synthesizer.
▶ Free	Indicates the amount of unused (free) memory on the current device.
▶ Total	Indicates the amount of total memory on the current device.
[SF2] FORMAT	Before you can use a new USB storage device with this synthesizer, you will need to format it. Use this operation to format the USB storage device and assign a Volume Label to it. For instructions on formatting, see page 213.
Slot	Selects a slot to be accessed when the connected USB storage device supports multiple media. Settings: 1 – 8
Type	Specifies the partition to be formatted. Settings: all, partition1 – 4
Volume Label	Names the Volume Label. For instructions on naming, refer to page 38 in the Basic Operation section.
[F2] SAVE	
<div style="display: flex; justify-content: space-between;"> <div style="width: 45%;"> <p>File/Folder name File/Folder selection box</p>  <p>Press the [F6] NEW button to create a new folder.</p> </div> <div style="width: 50%;"> <p>This operation lets you save files to a USB storage device. For instructions on saving files of the various data types, refer to the following pages: page 60 (Voices), page 67 (Performances), page 99 (Songs and Patterns).</p> </div> </div>	
TYPE	Among the various types of data created on this synthesizer, you can save all of them or only a specific type of data to a single file. This parameter determines which specific type of data will be saved to a single file. Settings: Refer to "Supplementary information" on page 214.
[SF1] EXEC	Executes saving of the file into the selected folder. NOTE The [ENTER] button on the panel is used to call up the contents of the selected folder.
[SF2] SETNAME	Copies the file/folder name selected in the File/Folder selection box into the File name column.
[F6] NEW	Creates a new folder in the current folder.
[F3] LOAD	
<div style="display: flex; justify-content: space-between;"> <div style="width: 45%;"> <p>Currently selected folder (directly)</p>  <p>File/Folder selection box</p> </div> <div style="width: 50%;"> <p>This operation lets you load files from a USB device to this synthesizer. You can also perform on the keyboard while playing backing parts from an SMF file contained in the USB storage device. See page 213.</p> </div> </div>	
TYPE	Among the various types of data saved in a single file on a USB storage device, you can load all of them or only a specific type of data to this synthesizer. This parameter determines which specific type of data will be loaded from a single file. Settings: Refer to "Supplementary information" on page 214.
[SF1] EXEC	Executes loading of the file. NOTE The [ENTER] button on the panel is used to call up the contents of the selected folder.

[F4] RENAME

Select the desired file type. Select the file/folder to be renamed.

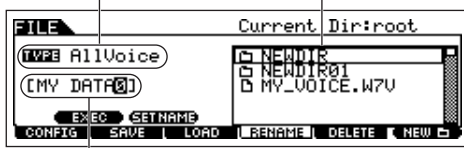

Rename the selected file/folder here.

From this display you can rename files or folders in the selected USB storage device, using up to eight alphabetic and numeric characters. Files are named according to the MS-DOS naming convention. If the file name contains spaces and other characters unrecognized in MSDOS, these characters will automatically be replaced by “_” (underscore) characters when saving.

[SF1] EXEC

Executes renaming of the file.

NOTE The [ENTER] button on the panel is used to call up the contents of the selected folder.

[SF2] SETNAME

Copies the file/folder name selected in the File/Folder selection box into the File name column.

[F6] NEW

Creates a new folder within the current folder.

[F5] DELETE

Select the desired file type.

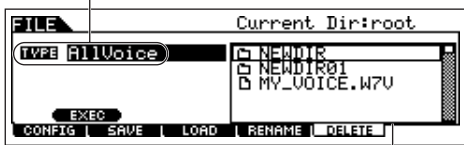

Select the file or folder to be deleted.

From this display you can delete files/folders from the selected USB storage device. Select the desired file or folder as shown below, then press the [SF1] EXEC button.

NOTE When you wish to delete a folder, delete all the files and folders contained in the folder beforehand. Please keep in mind that only folders that contain no files or other nested folders can be deleted.

■ Supplementary information

File (F)/Folder (D) selection

The instructions and illustrations below show you how to select files and folders on the USB storage devices within the File mode.

Move the cursor to the desired file or folder by using the [INC/YES] and [DEC/NO] buttons or the data dial.

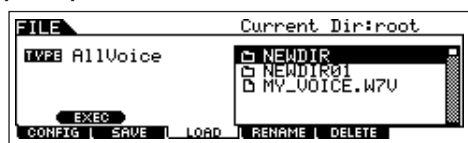

To return to the next highest level, press the [EXIT] button.

To call up the contents of a desired folder, highlight the folder and press the [ENTER] button.

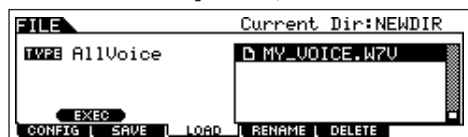

Move the cursor to the desired file or folder by using the [INC/YES] and [DEC/NO] buttons or the data dial.

Playing back the SMF (Standard MIDI file) from the USB storage device

In the File mode, you can play back directly the SMF file saved in the USB storage device. This is useful if you are playing a keyboard with the accompaniment of SMF file.

- 1 Connect the USB storage including the SMF file device to this instrument.
- 2 Enter the Song mode or Pattern mode, then select the Song or Pattern which has desired the Mixing settings.
- 3 Press the [FILE] button to enter the File mode.
- 4 Press the [F3] LOAD button.
- 5 Move the cursor to the TYPE, then select the Song or Pattern.

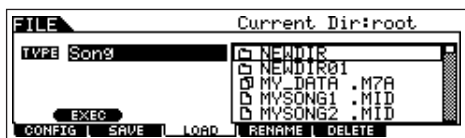

- 6 Select the SMF file.

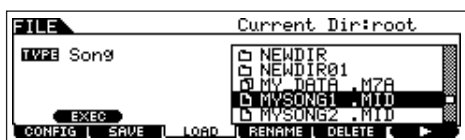

- 7 Press the [F6] (Play) button to play back the SMF file with the Mixing settings of currently selected Song or Pattern. Press the (Stop) button again to stop the playback.

- 8 Try playing the keyboard along with the accompaniment of the SMF file.

To select the Track for keyboard performance, turn the [TRACK SELECT] button on, then press the any of Number [1] – [16] buttons. Also, you can control the sound of each Part by using the Knobs and Control sliders as the Song mode and Pattern mode.

Formatting a USB storage device

Before you can use a new USB storage device with this synthesizer, you will need to format it. Follow the instructions below.

⚠ CAUTION

If data is already saved on the USB storage device, be careful not to format it. If you format the USB storage device, all the previously recorded data will be deleted.

- 1 Connect a USB storage device to the USB TO DEVICE connector.

If necessary, insert the proper media into the slot of the USB storage device.

- 2 Press the [FILE] mode to enter the File mode.

- 3 Press the [F1] CONFIG button, then [SF2] FORMAT button to call up the Format display.



- 4 Select the slot and partition to be formatted.

Specify the slot number at the right top of the display as necessary and select the partition to be formatted at the Type value location in the second line of the display.

- 5 Set the Volume Label.

Move the cursor to the "Volume Label" and input a Volume Label. For instructions on naming, refer to page 38 in the Basic Operation section.

- 6 Press the [ENTER] button. (The display prompts you for confirmation.)

Press the [DEC/NO] button to cancel the Format operation.

- 7 Press the [INC/YES] button to execute the Format.

After formatting has been completed, a "Completed" message appears and operation returns to the original display.

⚠ CAUTION

While formatting is in process, make sure to follow these precautions:

- Never remove or eject the media from the device (USB storage).
- Never unplug or disconnect any of the devices.
- Never turn off the power of the MO or the relevant devices.

NOTE By executing the Format operation in the File mode, the USB storage device will be formatted to MS-DOS or Windows format. The formatted USB storage device may not be compatible with other devices such as a Macintosh computer or digital camera.









File types that can be handled by the MO

File types that can be saved from the instrument to the USB storage device [FILE] → [F2] SAVE → TYPE

TYPE	File extension*	Description
All	.M7A	All data in this synthesizer's internal User Memory (Flash ROM) is treated as a single file, and can be saved to the USB storage device.
AllVoice	.W7V	All the User Voice data in this synthesizer's internal User Memory (Flash ROM) is treated as a single file, and can be saved to the USB storage device. However, the Mixing Voices are not saved.
UserARP	.W7G	All the User Arpeggio data in this synthesizer's internal User Memory (Flash ROM) is treated as a single file, and can be saved to the USB storage device.
AllSong	.W7S	All the User Song data in this synthesizer's internal User Memory (DRAM) is treated as a single file, and can be saved to the USB storage device.
AllPattern	.W7P	All the User Pattern data in this synthesizer's internal User Memory (DRAM) is treated as a single file, and can be saved to the USB storage device.
SMF	.MID	Sequence track (1 – 16) and Tempo track data of Songs or Patterns created in the Song/Pattern mode can be saved to the USB storage device as Standard MIDI File (format 0) data.
Voice Editor	.W7E	All the User Voice data stored on User Banks (Flash ROM) is handled as a single file and saved to the USB storage device. The saved file can be loaded to the MO6/MO8 Voice Editor (page 112) on your computer.

* Assigned to the file which can be saved.

File types that can be loaded from USB storage device to the instrument [FILE] → [F3] LOAD → TYPE

TYPE	File extension*	Description
All	.M7A	Files of the "All" type saved to USB storage device can be loaded and restored to the instrument. When the box at the left of "without System" is checkmarked, only the Utility mode settings will not be loaded.
AllVoice	.W7V	Files of the "All Voice" type saved to USB storage device can be loaded and restored to the instrument.
Voice	.M7A .W7V	A specified voice in a file that is saved to the USB storage device as "All" or "All Voice" type can be individually selected and loaded to the instrument. Please note that the file icons  of "M7A" and "W7V" are changed to  (as virtual folders) when this file type is selected (Quick Guide on page 62).
Performance	.M7A	A specified performance in a file that is saved to the USB storage device as "All" type can be individually selected and loaded to the instrument. Please note that the file icon  of "M7A" is changed to  (as a virtual folder) when this file type is selected (Quick Guide on page 68).
UserARP	.W7G	Files of the "UserARP" type saved to USB storage device can be loaded and restored to the instrument.
AllSong	.W7S	Files of the "All Song" type saved to USB storage device can be loaded and restored to the instrument.
Song	.M7A .W7S .MID	A specified Song in a file that is saved to the USB storage device as "All" or "All Song" type can be individually selected and loaded to the instrument. Please note that the file icons  of "M7A" and "W7S" are changed to  (as virtual folders) when this file type is selected (Quick Guide on page 101). In addition, selecting this file type lets you load the Standard MIDI file (format 0, 1) to a specific Song.
AllPattern	.W7P	Files of the "All Pattern" type saved to USB storage device can be loaded and restored to the instrument.
Pattern	.M7A .W7P .MID	A specified Song in a file that is saved to the USB storage device as "All" or "All Pattern" type can be individually selected and loaded to the instrument. Please note that the file icons  of "M7A" and "W7P" are changed to  (as virtual folders) when this file type is selected (Quick Guide on page 101). In addition, selecting this file type lets you load the Standard MIDI file (format 0, 1) to a specific section of a Pattern.
Voice Editor	.W7E	The Voice data edited via the MO6/MO8 Voice Editor on your computer can be loaded to the instrument.

* Assigned to the file which can be loaded.

NOTE • The "All Voice," "UserARP," "All Song," "All Pattern," and "Voice Editor" files using the MOTIF ES can be loaded to the MO. These file extensions are same as the MO.

• The "All" (.W2A), "All Voice" (.W2V), and "Voice Editor" (.W2E) files using the MOTIF also can be loaded to the MO as the file types below.

File Type	File extension
All Voice	.W2V
Voice	.W2A, .W2V
Voice Editor	.W2E

• Keep in mind that the Voices may not produce the exact same sound as those on the original instrument, since the contents of the preset Waveforms and the Effect structure are different between the two instrument series.

Reference
Voice mode
Performance mode
Song mode
Pattern mode
Mixing Voice mode
Utility mode
File mode
Master mode

Master mode

Master Play mode

[MASTER] → Master selection

The Master Play mode lets you perform a variety of general editing operations on the selected Master. For more detailed and comprehensive editing operations, use the Master Edit mode. Edited parameters with the exception of some parameters are stored to internal Flash ROM as a User Master.

[F1] PLAY

OCT (Octave)	Indicates Keyboard Octave setting set via the [OCTAVE] buttons. This can be changed also with the following operation: [UTILITY] → [F1] GENERAL → [SF2] KBD → Octave.
ASA (ASSIGN A), ASB (ASSIGN B)	Indicates the functions assigned to the respective Knobs (printed "ASSIGN A" and "ASSIGN B") when the lamps of both the [PAN/SEND] and [TONE] buttons are turned on. The functions are assigned from the [UTILITY] → [F4] CTL ASN → [SF2] ASSIGN display.

NOTE OCT (Octave), ASA (ASSIGN A), and ASB (ASSIGN B) settings are not independently assignable for each Master. Because of this, these are not stored as an individual Master in the Master Store mode (page 218).

AS1 (ASSIGN 1), AS2 (ASSIGN 2)	Indicates the values obtained by controlling the respective Knobs (printed "ASSIGN 1" and "ASSIGN 2") when the lamps of both the [PAN/SEND] and [TONE] buttons are turned on. The functions assigned to these knobs depend on the setting of the Voice selected as a Master program.
---	--

[SF1] ARP1 (Arpeggio 1) - [SF5] ARP5 (Arpeggio 5)

You can call up the Arpeggio types by pressing these buttons to which the Arpeggio types are assigned. The Arpeggio type assigned to each button depends on the program (Voice, Performance, Song, Pattern) selected as a Master.

[F2] MEMORY

From this display you can set basic parameters for the Master, including the mode that is called up with the Master and the program number.

Mode	Determines the mode that is called up when the Master number is selected. Settings: Voice, Performance, Pattern, Song
Memory	Determines the Program number that is called up when the Master is selected. Settings: When the Mode is set to Voice: Select a Voice bank and number. When the Mode is set to Performance: Select a Performance bank and number. When the Mode is set to Pattern: Select a Pattern and section. When the Mode is set to Song: Select a Song number.
ZoneSwitch	Determines whether the Zone function is used (on) or not (off). See page 123 for details about the Zone function. NOTE When the Mode is set to "Voice" or "Performance" and the Zone Switch is turned on, only Zone 1 can be used in the default setting (playing Zones 2-4 will produce no sound). You can use these Zones by setting various parameters in the Master Edit mode.

Voice mode

Performance mode

Song mode

Pattern mode

Mixing Voice mode

Utility mode

File mode

Master mode

Reference

Master Edit mode

[MASTER] → Master selection → [EDIT]

The Master Edit is divided into Common Edit, for setting parameters common to all four Zones, and Zone Edit, for setting parameters of individual Zones.

When Zone Switch is set to on in the [F2] MEMORY display in the Master Play mode, only the Common Edit is available.

Common Edit

[MASTER] → Master selection → [EDIT] → [COMMON]

These parameters are for making global (or common) edits to all four Zones of the selected Master.

[F1] NAME

From this display you can create a name for the Master. For instructions on naming, refer to page 38 in the Basic Operation section.

[F2] OTHER

Knob/Slider	<p>From this display you can set which row of Knob/Slider functions will be lit and selected.</p> <p>Settings:</p> <p>pan..... Selecting the Master lights the [PAN/SEND] lamp, for control over the Pan/Send row. tone..... Selecting the Master lights the [TONE] lamp, for control over the Tone row. assign..... Selecting the Master lights the [PAN/SEND] and [TONE] lamps, for control over the Assign row. MEQofs or partEQ..... Selecting the Master lights the [EQ] lamp, for control over the EQ row. When the Mode is set to Voice, MEQofs is available. When the Mode is set to Performance, Song, or Pattern, partEQ is available. MEF..... Selecting the Master lights the [ARP FX] and [EQ] lamps, for control over the Master Effects row. arpFx..... Selecting the Master lights the [ARP FX] lamp, for control over the Arpeggio FX row. zone..... Selecting the Master lights no lamp and automatically calls up the Knob/Slider functions specifically set for each respective Zone (page 126). This is available only when the Zone Switch is set to on in the [F2] MEMORY display in the Master Play mode.</p>
--------------------	--

Zone Edit

[MASTER] → Master selection → [EDIT] → Zone selection

These parameters are for editing the individual Zones that make up a Master. Zone Edit is available only when the Zone Switch is turned on in the [F2] MEMORY display in the Master Play mode.

[F1] TRANS (Transmit)

From this display you can set how each Zone transmits MIDI messages when you play the keyboard.

TransCh (Transmit Channel)	<p>Determines the MIDI Transmit Channel for each Zone.</p> <p>Settings: 1 – 16</p>
TGSwitch (Tone Generator Switch)	<p>Determines whether or not MIDI data for each Zone is transmitted to the internal tone generator.</p> <p>Settings: on, off</p>
MIDISwitch	<p>Determines whether or not MIDI data for each Zone is transmitted to an external MIDI device.</p> <p>Settings: on, off</p>

[F2] NOTE

From this display you can set the pitch- and keyboard-related parameters for each Zone — allowing you to set up Zone splits and determine the pitch range for each Zone.

Octave	<p>Determines the amount in octaves by which the range of the Zone is shifted up or down.</p> <p>Settings: -3 - 0 (Default) - +3</p>
Transpose	<p>Determines the amount in semitones by which the range of the Zone is shifted up or down.</p> <p>Settings: -11 - 0 (Default) - +11</p>
NoteLimitH, L (High, Low)	<p>Determines the lowest and highest notes of the range for each Zone. The selected Zone will sound only when you play notes within this range.</p> <p>Settings: C -2 - G8</p> <p>NOTE You can also set the range directly from the keyboard, by holding down the [INFORMATION] button and pressing the desired low and high keys.</p>

[F3] TX SW (Transmit Switch)

From this display you can set how the playing of each individual Zone affects transmission of various MIDI messages, such as Control Change and Program Change messages. When the relevant parameter is set to “on,” playing the selected Zone will transmit the corresponding MIDI messages. Note that two different display types are provided (see below). Each display type features the same settings in a different format; use the type you feel most comfortable with.

- Display showing four Zones
- Display showing all parameters for one Zone

Keep in mind that since all the available parameters cannot be simultaneously displayed in the four-Zone display, you will need to use the cursor controls to scroll the display in order to see and set the other parameters.

Settings:

Bank (TG)	Determines whether or not to transmit Bank Select MSB/LSB messages to the internal tone generator.
PC (TG)	Determines whether or not to transmit Program Change messages to the internal tone generator.
Bank (MIDI)	Determines whether or not to transmit Bank Select MSB/LSB messages to the external tone generator via MIDI.
PC (MIDI)	Determines whether or not to transmit Program Change messages to the external tone generator via MIDI.
PB (Pitch Bend)	Determines whether or not to transmit Pitch Bend messages to the internal and external tone generator.
MW (Modulation Wheel)	Determines whether or not to transmit MIDI messages generated by using the Modulation Wheel to the internal and external tone generator.
Vol (Volume)	Determines whether or not to transmit Volume messages to the internal and external tone generator.
Pan	Determines whether or not to transmit Pan messages to the internal and external tone generator.
Slider	Determines whether or not to transmit MIDI messages generated by using the Sliders to the internal and external tone generator.
FC1 (Foot Controller1)	Determines whether or not to transmit MIDI messages generated by pressing the optional Foot Controller to the internal and external tone generator.
FS (Footswitch)	Determines whether or not to transmit MIDI messages generated by pressing the Footswitch connected to the FOOT SWITCH jack to the internal and external tone generator.
Knob	Determines whether or not to transmit MIDI messages generated by using the Knobs to the internal and external tone generator.

[F4] PRESET

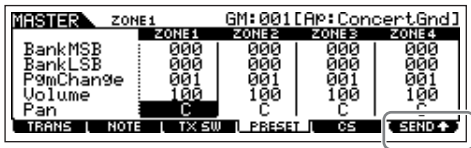

From this display you can make the Voice-related settings for each Zone, in the selected Master program number. In this way, selecting a different Master automatically calls up a completely different set of Voices and Voice-related settings for the four Zones.

NOTE Using the [F6] SEND button, you can select whether the settings in PRESET display are immediately applied or not. If the [F6] SEND button is turned on (SEND ON), each MIDI messages will be output from the MO as soon as you changed each parameter in this display. If the [F6] SEND button is turned off (SEND OFF), each MIDI messages will be output from the MO after you store the edited Master and then select the Master again. However, the parameters set to off in the [F1] TRANS or [F3]TX SW display cannot be output.

BankMSB, BankLSB, PgmChange (Program Change)	Determines the Voice assignment for each Zone in the selected Master. Settings: Refer to the Voice List in the separate Data List booklet.
Volume	Determines the output level of the Voice in each Zone. Settings: 0 – 127
Pan	Determines the stereo pan position of the Voice in each Zone. Settings: L64 (Left) – C (Center) – R63 (Right)

[F5] KN/CS (Knob/Control Slider)

From this display you can determine which Control Change numbers are used for the Knobs and Sliders for each Zone. These settings are available only when the Knob/Slider parameter (in the [F2] OTHER display in Common Edit) is set to “zone.”

Settings: off, 1 – 95

Voice mode
Performance mode
Song mode
Pattern mode
Mixing Voice mode
Utility mode
File mode
Master mode

Reference

Master Job mode

[MASTER] → [JOB]

The Master Job mode contains two convenient operations (called “Jobs”)—one letting you initialize (reset) the Master data, and the other letting you transmit your edited Master data to an external MIDI device or computer.

After setting parameters as required from the selected display, press the [ENTER] button to execute the Job.

[F1] INIT (Initialize)

This function lets you reset (initialize) all Master parameters to their default settings. It also allows you to selectively initialize certain parameters, such as Common settings, settings for each Zone, and so on — very useful when creating a completely new Master from scratch.

Parameter Types (for Initializing): All, Common, Zone

ALL	All settings for the selected Master are initialized.
Common	Common parameter settings for the selected Master are initialized.
Zone	You can initialize the Zone setting to one of the following three types.
Split	Splits the keyboard range using Zone 1 and Zone 2. “UpperCh” determines the MIDI transmit channel of the upper range of the keyboard, “LowerCh” determines the MIDI transmit channel of the lower range of the keyboard, and “SplitPoint” determines the note (C2 – G8) number which separates the upper range and lower range of the keyboard.
4Zone	Initializes all four Zones.
Layer	Lets you layer two parts using Zone 1 and Zone 2. “UpperCh” and “LowerCh” determine the MIDI transmit channels of the two Zones respectively.

[F4] BULK (Bulk Dump)

This function lets you send all your edited parameter settings for the currently selected Master to a computer or another MIDI device for data archiving. For details, page 148.

NOTE In order to execute Bulk Dump, you'll need to set the correct MIDI Device Number, with the following operation: [UTILITY] → [F5] MIDI → [SF1] CH → DeviceNo.

Master Store mode

[MASTER] → Master selection → [STORE]

This function lets you store your edited Master to User memory (Flash ROM).

For details, refer to page 123 in the Quick Guide section.

Voice mode

Performance mode

Song mode

Pattern mode

Mixing Voice mode

Utility mode

File mode

Master mode

Reference

Appendix

Information Displays

The convenient Information displays let you see at-a-glance some of the more important settings relevant to each mode. Select the desired mode, then press the [INFORMATION] button to call up the Information display for that mode. To exit from the display, press the button again (or any other panel button).

Voice mode

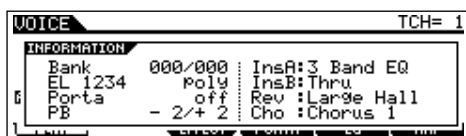

Bank

Indicates the MSB/LSB (page 224) of the currently selected Voice bank.

EL 1234

Indicates the currently selected Voice, on/off status of the four Elements and mono/poly (page 151) status.

Porta (Portamento)

Indicates the Portamento switch on/off status of the currently selected Voice.

PB (Pitch Bend)

Indicates the Upper/Lower setting of the Pitch Bend range.

InsA (Insertion A), InsB (Insertion B), Rev (Reverb), Cho (Chorus)

Indicates the currently selected effect type for each effect block (page 140).

Performance mode



Bank

Indicates the MSB/LSB (page 224) of the currently selected Performance bank.

Ins (Insertion)

Indicates the Part number to which the Insertion effect is applied.

Rev (Reverb), Cho (Chorus)

Indicates the currently selected effect type for each effect block (page 140).

Song mode

● Song Play mode

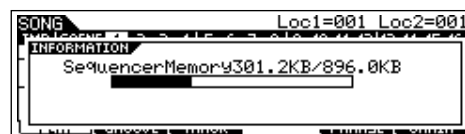

Indicates the amount of currently unused (available) memory (DRAM) for song recording.

● Song Mixing mode

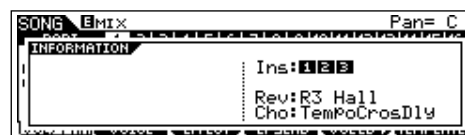

Ins (Insertion)

Indicates the Part number to which the Insertion effect is applied.

Rev (Reverb), Cho (Chorus)

Indicates the currently selected effect type for each effect block (page 140).

● Mixing Voice Edit mode

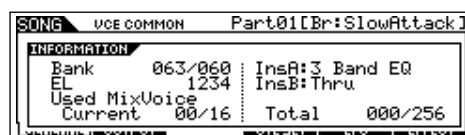

Bank

Indicates the MSB/LSB (page 224) of the currently selected Voice bank.

EL 1234

Indicates the currently selected Voice, and the on/off status of the four Elements.

InsA (Insertion A), InsB (Insertion B)

Indicates the currently selected effect type for each effect block.

Used Mix Voice

Current

Indicates the number of Parts using the Mixing Voices in the currently selected Song.

Total

Indicates the total number of Parts using the Mixing Voices in all the Songs and Patterns.

Pattern mode

● Pattern Play mode



Indicates the amount of currently unused (available) memory (DRAM) for Pattern Phrase recording.

● Pattern Mixing mode

Same as in the Song Mixing mode.

● Mixing Voice Edit mode

Same as in the Song Mixing Voice Edit mode.

Utility mode



MIDI IN/OUT

Indicates which physical output terminal(s) will be used for transmitting/receiving MIDI data.

● Auto Load

This is available only when the [SF4] OTHER display is selected from [F1] GENERAL.



Indicates the slot number and volume label of the directory of the USB storage device specified in the Auto Load function.

● Quick Setup

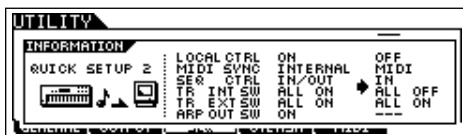

Indicates the parameter values/settings before and after the Quick Setup function is used. For details on Quick Setup, see page 208.

File mode



USB Free

Indicates the amount of currently available (unused) memory of the connected USB storage device.

Slot, Volume Label

Indicates the slot number and volume label of USB storage device's directory used in the File mode.

Current Dir (Current Directory)

Indicates the currently selected directory.

Master mode

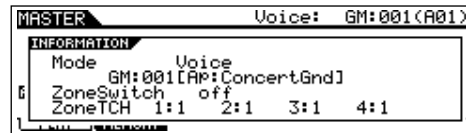

Mode

Indicates the mode and program number memorized to the currently selected Master.

ZoneSwitch

Indicates the on/off status of the Zone switch.

ZoneTCH (Zone Transmit Channel)

Indicates the MIDI transmit channel of each Zone (when the Zone Switch is set to on).

Remote Control mode

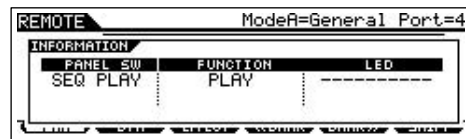

For details, see page 117.

Display Messages

LCD Indication	Explanation
Are you sure ? [YES]/[NO]	Confirms whether you want to execute a specified operation or not. Press [INC/YES] or [DEC/NO] as required.
Arp memory full	The internal memory for Arpeggio data is full, preventing storing the recorded sequence data as an Arpeggio.
Arpeggio type stored	The current Arpeggio type has been stored to one of the [SF1] - [SF5] buttons.
Bad USB device	The USB storage device is unusable. Format the USB storage device and try again.
Bulk protected.	Bulk data was received when RcvBulk was set to "protect." (See page 209.)
Can't make folder.	No more directories can be created below the current level.
Can't undo OK? [YES]/[NO]	When certain Song/Pattern Jobs are executed, internal memory becomes too full for use of the Undo operation. Press [INC/YES] if this is OK, or [DEC/NO] to abort the operation. Try again after erasing unwanted Songs, Patterns, or User phrases.
Choose user phrase.	You have attempted to record a Pattern track to which a preset phrase is assigned. If you wish to use a preset phrase as raw material for Pattern recording, copy it to a User phrase before recording.
Completed.	The specified load, save, format, or other Job has been completed.
Device number is off.	Bulk data cannot be transmitted/received since the device number is off.
Device number mismatch.	Bulk data cannot be transmitted/received since the device numbers don't match.
Executing...	A format operation or Job is being executed. Please wait.
File already exists.	A file having the same name as the one you are about to save already exists.
File not found.	The file of the specified type cannot be found on the USB storage device
Folder is too deep.	Directories below this level cannot be accessed.
Folder not empty.	You have attempted to delete a folder that contains data.
Illegal check box.	No check boxes have been checked in a Sequencer track Job which requires a check box selection. Check the appropriate check box.
Illegal file	The file specified for loading is unusable by the MO or cannot be loaded in the current mode.
Illegal file name.	The specified file name is invalid. Try entering a different name.
Illegal input.	An invalid input or value has been specified. Check the input method or value.
Illegal measure.	An invalid measure number has been specified in the Song/Pattern mode. Select the measure again.
Illegal phrase number.	An invalid phrase number has been specified in the Pattern mode. Select the phrase again.
Illegal track number.	An invalid track number has been specified in the Song/Pattern mode. Select the track again.
Incompatible USB device	A USB device which cannot be used with the MO has been connected to the USB TO DEVICE connector.
Meter mismatch	In the Pattern Job mode, the meter (time signature) of the destination Pattern is different from the meter of the source Pattern.
MIDI buffer full.	Failed to process the MIDI data because too much data was received at one time.
MIDI checksum error.	An error occurred when receiving bulk data.
MIDI data error.	An error occurred when receiving MIDI data.
Mixing stored	In the Song/Pattern mode, the Mixing settings have been loaded from the file.
Mixing Voice full	The Mixing Voice cannot be stored because the number of Voices already stored has exceeded the maximum capacity.
No data.	When a Song/Pattern Job is executed, the selected track or range contains no data. Select an appropriate track or range. In addition, this message appears when a Job related to a Mixing Voice cannot be executed because the specified Mixing Voice is not available.
No F7 (End of Exc.)	Exclusive data has been entered or changed without the necessary "End of Exclusive" byte (F7). Make sure F7 is included.
No response from USB device	There is no response from the USB device connected to the USB TO DEVICE terminal.
Not empty folder	You have attempted to delete a folder that contains data.
Now loading... (xxxx)	Indicates that a file is being loaded.
Now saving... (xxxx)	Indicates that a file is being saved.
Now scanning auto loaded files	Scanning for the files specified for Auto Load.
Now working...	Canceling the Load/Save operation by pressing the [EXIT] button.
Overwrite? [YES]/[NO]	A save operation will overwrite data on the USB storage device, and this message confirms whether it is OK to continue or not. Press [INC/YES] or [DEC/NO] as required.
Pattern length mismatch.	A Pattern Job will result in the length of a Pattern being greater than 256 measures.
Phrase length mismatch	A Pattern Job will result in the length of a phrase being greater than 256 measures.
Phrase number overflow	The maximum number of phrases (256) has been exceeded when recording, executing a Pattern Job, or editing.
Please keep power on.	The data is being written to Flash ROM. Never attempt to turn off the power while data is being written to Flash ROM. Turning the power off while this message is shown results in loss of all user data and may cause the system to freeze (due to corruption of data in the Flash ROM). This may also result in the MO being unable to properly start up the next time the power is turned on.

LCD Indication	Explanation
Please stop sequencer.	The operation you've attempted to execute cannot be done during Song/Pattern playback.
Power on mode stored	The setting of the program number automatically selected when turning the power on has been stored.
Read only file.	You have attempted to delete, rename, or overwrite a read-only file.
Receiving MIDI bulk	The MO is receiving MIDI bulk data.
Recording stopped	The recording has been stopped since the memory became full.
Scene & Arpeggio type stored	The Song Scene and current Arpeggio type have been stored to one of the [SF1] – [SF5] buttons.
Seq memory full.	The internal memory for Sequence data is full, preventing any further operation (such as recording, editing, Job execution, MIDI reception/transmission, or loading from the USB storage device). Try again after erasing unwanted Song, Pattern, or User phrase data.
System memory crashed.	Writing data to Flash ROM has failed.
This performance uses user voices.	The performance you have loaded includes User voice data. Check whether the voice you saved exists at the appropriate User voice bank.
Too many favorites	You've attempted to assign more than 257 voices to the Favorite category.
Too many fixed notes	When converting the song or pattern data to the Arpeggio data, the amount of different notes in the data to be converted has exceeded sixteen.
Transmitting MIDI bulk	The MO is transmitting MIDI bulk data.
Unknown file format.	File format is not recognized.
USB connection terminated. Press [ENTER].	A break in the connection with the USB storage device has occurred because of an abnormal electric current. Disconnect the USB storage device from the USB TO DEVICE connector, then press the [ENTER] button.
USB device connecting	Recognizing the USB storage device connected to the USB TO DEVICE terminal.
USB device full.	The USB storage device is full and no more data can be saved. Use a new USB storage device, or make space by erasing unwanted data from the USB storage device.
USB device not ready.	A USB storage device is not properly inserted in or connected to the MO.
USB device read/write error.	An error occurred while reading or writing to/from a USB storage device.
USB device unformatted.	The disk is not formatted, or the format is unusable by the MO.
USB device write protected.	The USB storage device is write protected, or you have attempted to write to a read-only medium such as CD-ROM.
USB power consumption exceeded.	The power consumption of the USB storage device connected to the USB TO DEVICE connector exceeds the regulated value.
USB transmission error	An error occurs when communicating with the USB storage device.
Utility stored	The settings in the Utility mode have been stored.

About MIDI

MIDI (Musical Instrument Digital Interface) is a standard which allows electronic musical instruments to communicate with each other, by sending and receiving compatible Note, Control Change, Program Change and various other types of MIDI data, or messages.

This synthesizer can control other MIDI devices by transmitting note related data and various types of controller data. It can also be controlled by incoming MIDI messages which automatically determine the tone generator mode, select MIDI channels, voices and effects, change parameter values, and of course play the voices specified for the various Parts.

MIDI channels

MIDI performance data is assigned to one of sixteen MIDI channels. Using these channels, 1 – 16, the performance data for sixteen different instrument parts can be simultaneously sent over one MIDI cable.

Think of the MIDI channels as TV channels. Each TV station transmits its broadcasts over a specific channel.

Your home TV set receives many different programs simultaneously from several TV stations and you select the appropriate channel to watch the desired program.

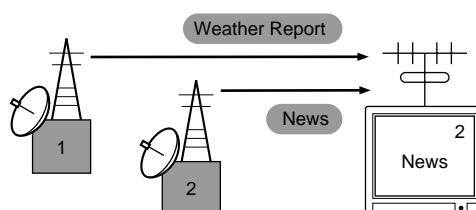

MIDI operates on the same basic principle.

The transmitting instrument sends MIDI data on a specific MIDI channel (MIDI Transmit Channel) via a single MIDI cable to the receiving instrument. If the receiving instrument's MIDI channel (MIDI Receive Channel) matches the Transmit Channel, the receiving instrument will sound according to the data sent by the transmitting instrument.

For information on how to set the MIDI transmit channel and the MIDI receive channel, see page 104.

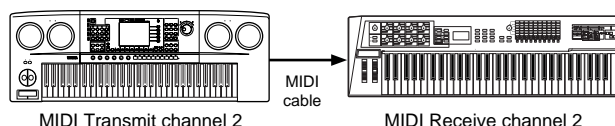

MIDI channel and MIDI port

MIDI data is assigned to one of sixteen channels. However, we can overcome the sixteen-channel limit by using separate MIDI "ports," each supporting sixteen channels. For details, see page 107.

MIDI Messages Transmitted/Recognized by this synthesizer

MIDI messages can be divided into two groups: Channel messages and System messages. Below is an explanation of the various types of MIDI messages which this synthesizer can recognize/transmit. The messages transmitted/recognized by this synthesizer are shown in the MIDI Data Format and MIDI Implementation Chart of the separate Data List.

NOTE Some of the following explanations are described in a general sense, and not necessarily as how they relate to the MO. For details about the behavior of MO when receiving each MIDI message, refer to the "MIDI Data Format" and the "MIDI Implementation Chart" in the separate Data List.

CHANNEL MESSAGES

Channel messages contain data related to the performance on the keyboard for the specific channel.

■ Note On/Note Off (Key On/Key Off)

Messages which are generated when the keyboard is played.

Reception note range = C-2 (0) – G8 (127), C3 = 60

Velocity range = 1 – 127 (Only the Note On velocity is received)

Note On: Generated when a key is pressed.

Note Off: Generated when a key is released.

Each message includes a specific note number which corresponds to the key which is pressed, plus a velocity value based on how hard the key is struck.

■ Control Change

Control Change messages let you select a voice bank, control volume, panning, modulation, portamento time, brightness and various other controller parameters, through specific Control Change numbers which correspond to each of the various parameters.

Bank Select MSB (Control #000)

Bank Select LSB (Control #032)

Messages which select variation voice bank numbers by combining and sending the MSB and LSB from an external device. The functions of MSB and LSB messages differ depending on the tone generator mode. MSB numbers select voice type (Normal Voice or Drum Voice), and LSB numbers select voice banks.

(For more information about Banks and Programs, see Voice List in the separate Data List.)

A new bank selection will not become effective until the next Program Change message is received.

Modulation (Control #001)

Messages which control vibrato depth using the Modulation Wheel.

Setting the value to 127 produces maximum vibrato and 0 results in vibrato off.

Portamento Time (Control #005)

Messages which control the duration of portamento, or a continuous pitch glide between successively played notes. When the parameter Portamento Switch (Control #065) is set to on, the value set here can adjust the speed of pitch change.

Setting the value to 127 produces maximum portamento time and 0 results in minimum portamento time.

Data Entry MSB (Control #006)

Data Entry LSB (Control #038)

Messages which set the value for the parameter specified by RPN MSB/LSB (page 225) and NRPN MSB/LSB (page 225). Parameter value is determined by combining the MSB and LSB.

Main Volume (Control #007)

Messages which control the volume of each Part.

Setting the value to 127 produces maximum volume and 0 results in volume off.

Pan (Control #010)

Messages which control the stereo panning position of each Part (for stereo output).

Setting the value to 127 positions the sound to the far right and 0 positions the sound to the far left.

Expression (Control #011)

Messages which control intonation expression of each Part during performance.

Setting the value to 127 produces maximum volume and 0 results in volume off.

Hold1 (Control #064)

Messages which control sustain on/off.

Setting the value between 64 – 127 turns the sustain on, between 0 – 63 turns the sustain off.

Portamento Switch (Control #065)

Messages which control portamento on/off.

Setting the value between 64 – 127 turns the portamento on, between 0 – 63 turns the portamento off.

Sostenuto (Control #066)

Messages which control sostenuto on/off.

Holding specific notes and then pressing and holding the sostenuto pedal will sustain those notes as you play subsequent notes, until the pedal is released.

Setting the value between 64 – 127 turns the sostenuto on, between 0 – 63 turns the sostenuto off.

Harmonic Content (Control #071)

Messages which adjust the filter resonance set for each Part.

The value set here is an offset value which will be added to or subtracted from the voice data. Higher values will result in a more characteristic, resonant sound. Depending on the voice, the effective range may be narrower than the range available for adjustment.

Release Time (Control #072)

Messages which adjust the AEG release time set for each Part.

The value set here is an offset value which will be added to or subtracted from the voice data.

Attack Time (Control #073)

Messages which adjust the AEG attack time set for each Part.

The value set here is an offset value which will be added to or subtracted from the voice data.

Brightness (Control #074)

Messages which adjust the filter cutoff frequency set for each Part.

The value set here is an offset value which will be added to or subtracted from the voice data. Lower values result in a softer sound.

Depending on the voice, the effective range may be narrower than the range available for adjustment.

Decay Time (Control #075)

Messages which adjust the AEG decay time set for each Part. The value set here is an offset value which will be added to or subtracted from the voice data.

Effect1 Depth (Reverb Send Level) (Control #091)

Messages which adjust the send level for the Reverb effect.

Effect3 Depth (Chorus Send Level) (Control #093)

Messages which adjust the send level for the Chorus effect.

Data Increment (Control #096)**Decrement (Control #097) for RPN**

Messages which increase or decrease the MSB value of pitch bend sensitivity, fine tune, or coarse tune in steps of 1. You will need to assign one of those parameters using the RPN in the external device in advance. The data byte is ignored. When the maximum value or minimum value is reached, the value will not be incremented or decremented further. (Incrementing the fine tune will not cause the coarse tune to be incremented.)

NRPN (Non-Registered Parameter Number) LSB (Control #098)**NRPN (Non-Registered Parameter Number) MSB (Control #099)**

Messages which adjust a voice's vibrato, filter, EG, drum setup or other parameter settings.

First send the NRPN MSB and NRPN LSB to specify the parameter which is to be controlled. Then use Data Entry (page 224) to set the value of the specified parameter. Note that once the NRPN has been set for a channel, subsequent data entry will be recognized as the same NRPN's value change. Therefore, after you use the NRPN, you should set a Null (7FH, 7FH) value to nullify further changes and prevent unexpected results.

RPN (Registered Parameter Number) LSB (Control #100)**RPN (Registered Parameter Number) MSB (Control #101)**

Messages which offset, or add or subtract values from a Part's pitch bend sensitivity, tuning, or other parameter settings. First send the RPN MSB and RPN LSB to specify the parameter which is to be controlled. Then use Data Increment/Decrement to set the value of the specified parameter. Note that once the RPN has been set for a channel, subsequent data entry will be recognized as the same RPN's value change. Therefore after you use the RPN, you should set a Null (7FH, 7FH) value to avoid unexpected results.

The following RPN numbers can be received.

RPN MSB	RPN LSB	PARAMETER
00	00	Pitch Bend Sensitivity
00	01	Fine Tune
00	02	Coarse Tune
7F	7F	Null

Channel Mode Messages

The following Channel Mode Messages can be received.

2nd BYTE	3rd BYTE	MESSAGE
120	0	All Sounds Off
121	0	Reset All Controllers
123	0	All Notes Off
126	0 – 16	Mono
127	0	Poly

All Sounds Off (Control #120)

Clears all sounds currently sounding on the specified channel. However, the status of channel messages such as Note On and Hold On is maintained.

Reset All Controllers (Control #121)

The values of the following controllers will be reset to the defaults.

CONTROLLER	VALUE
Pitch Bend Change	0 (center)
Aftertouch	0 (off)
Polyphonic Aftertouch	0 (off)
Modulation	0 (off)
Expression	127 (max)
Hold1	0 (off)
Portamento	0 (off)
Sostenuto	0 (off)
Soft Pedal	0 (off)
Portamento Control	Cancels the Portamento source key number
RPN	Number not specified; internal data will not change
NRPN	Number not specified; internal data will not change

All Notes Off (Control #123)

Clears all notes currently on for the specified channel. However, if Hold1 or Sostenuto is on, notes will continue sounding until these are turned off.

Mono (Control #126)

Performs the same function as when an All Sounds Off message is received, and if the 3rd byte (mono number) is in the range of 0 – 16, it sets the corresponding channel to Mono Mode (Mode 4: $m = 1$).

Poly (Control #127)

Performs the same function as when an All Sounds Off message is received, and sets the corresponding channel to Poly Mode.

Program Change

Messages that determine which voice to select for each Part. With a combination of Bank Select, you can select not only basic voice numbers, but also variation voice bank numbers. For a list of the Voices, see the separate Data List.

■ Pitch Bend

Pitch Bend messages are continuous controller messages that allow the pitch of designated notes to be raised or lowered by a specified amount over a specified duration.

■ Channel Aftertouch

Messages which let you control the sounds by the pressure you apply to the keys after the initial striking of the keys, over the entire channel.

This synthesizer does not transmit this data from the keyboard; however, this synthesizer does properly respond to this data when received from an external device.

■ Polyphonic Aftertouch

Messages which let you control the sounds by the pressure you apply to the keys after the initial striking of the keys, for each individual key. This synthesizer does not transmit this data from the keyboard; however, the data is transmitted from the internal sequencer.

SYSTEM MESSAGES

System messages are the data related to the overall system of the device.

■ System Exclusive Messages

System Exclusive messages control various functions of this synthesizer, including master volume and master tuning, tone generator mode, effect type and various other parameters.

General MIDI (GM) System On (Song mode/Pattern only)

When “General MIDI system on” is received, the MO will receive the MIDI messages which are compatible with GM System Level 1, and consequently will not receive NRPN and Bank Select messages.

F0 7E 7F 09 01 F7 (Hexadecimal)

NOTE Make sure that the interval between this message and the first note data of the song is at least a quarter note or greater in length.

Master Volume

When received, the Volume MSB will be effective for the System Parameter.

F0 7F 7F 04 01 11 mm F7 (Hexadecimal)

* mm (MSB) = appropriate volume value, 11 (LSB) = ignored

■ System Realtime Messages

These messages control the sequencer, that is to say Song and Pattern.

Active Sensing (FEH)

Once FEH (Active Sensing) has been received, if no MIDI data is subsequently received for longer than an interval of approximately 300 msec, the MO will perform the same function as when All Sounds Off, All Notes Off, and Reset All Controllers messages are received, and will then return to a status in which FEH is not monitored.

Timing Clock (F8H)

This message is transmitted with a fixed interval (24 times per 1/4 note) to synchronize connected MIDI instruments. You can select whether the sequencer block uses the internal Timing Clock, or external Timing Clock messages received via MIDI IN by setting the MIDI Sync parameter: [UTILITY] → [F5] MIDI → [SF3] SYNC → MIDI Sync.

Start (FAH)

This message lets the MIDI sequence data start playing back from the beginning. This message will be transmitted when pressing the [▶] (Play) button at the top of the Song or Pattern.

Continue (FBH)

This message lets the MIDI sequence data start playing back from the current song position. This message will be transmitted when pressing the [▶] (Play) button at the middle of the Song or Pattern.

Stop (FCH)

This message causes MIDI sequence data (song) to stop playing back. This message will be transmitted when pressing the [■] (Stop) button during playback.

NOTE You can select whether this synthesizer will transmit Timing Clock, Start, Continue, and Stop messages by setting the SeqCtrl parameter: [UTILITY] → [F5] MIDI → [SF3] SYNC → SeqCtrl.

■ System Common Message

System Common messages also control the sequencer, including Song Select and Song Position Pointer messages.

Troubleshooting

If you hear no sound or a strange sound, first check the items described below and take appropriate action. You may be able to solve the problem by resetting the instrument to the factory settings (page 26). (Make sure to back up any important data to an external device first.)

If the problem persists, consult your Yamaha dealer.

■ No sound comes from the speakers.

- Are all four Control sliders set to appropriate levels (other than zero or minimum)?
- Has the Local Control switch been set to off?
If this is set to off, the internal tone generator will not sound.

[UTILITY] → [F5] MIDI → [SF2] SWITCH → Local Ctrl (page 209)

- Have you turned on the power of this instrument and all connected external equipment?
- Have you made all the appropriate level settings—including the Master Volume on this instrument and the volume settings on any connected external equipment?
- Is the Foot Controller pressed down (when it is connected to the FOOT CONTROLLER jack)?
- Are you using an external MIDI controller and are the MIDI volume and/or MIDI expression settings too low?
- Is this instrument properly connected to related external equipment (e.g., amplifier or speaker) via audio cables?
- Are the effect and filter settings appropriate?
If you are using the filter, try changing the cutoff setting. Some cutoff settings may mute the sound entirely.

[VOICE] → [EDIT] → [COMMON] → [F6] EFFECT (page 158)

[PERFORM] → [EDIT] → [COMMON] → [F6] EFFECT (page 173)

[SONG]/[PATTERN] → [MIXING] → [F3] EFFECT (pages 189, 202)

[VOICE] → [EDIT] → Element/Key selection → [F3] FILTER (page 160)

[PERFORM] → [EDIT] → Part selection → [F4] TONE → [SF2] FILTER (page 176)

[SONG]/[PATTERN] → [MIXING] → [EDIT] → Part selection → [F4] TONE → [SF2] FILTER (pages 191, 202)

[SONG]/[PATTERN] → [UTILITY] → [F3] SEQ → [SF2] FILTER (page 207)

- Are the volume or level settings too low?

[UTILITY] → [F1] GENERAL → [SF1] TG → Volume (page 205)

[VOICE] → [EDIT] → [COMMON] → [F2] OUTPUT → Volume (page 154)

[VOICE] → [EDIT] → Element/Key selection → [F4] AMP → [SF1] LVL/PAN → Level (page 162)

[PERFORM] → [EDIT] → [COMMON] → [F2] OUT/MEF → [SF1] OUT → Volume (page 172)

[PERFORM] → [EDIT] → Part selection → [F2] OUTPUT → [SF1] VOL/PAN → Volume (page 175)

[SONG]/[PATTERN] → [MIXING] → [EDIT] → Part selection → [F2] OUTPUT → [SF1] VOL/PAN → Volume (pages 191, 202)

- Are the element switch, note limit, velocity limit parameters set appropriately?

[VOICE] → [EDIT] → Element/Key selection → [F1] OSC → [SF1] WAVE → ElementSw (page 158)

[VOICE] → [EDIT] → Element/Key selection → [F1] OSC → [SF3] LIMIT (page 158)

[PERFORM] → [F2] VOICE (page 171)

[PERFORM] → [EDIT] → Part selection → [F1] VOICE → [SF1] VOICE → PartSw (page 174)

[PERFORM] → [EDIT] → Part selection → [F1] VOICE → [SF3] LIMIT (page 174)

- When the Performance/Song/Pattern produces no sound, has a Voice been assigned to each Part?

[PERFORM] → [F2] VOICE (page 171)

[SONG]/[PATTERN] → [MIXING] → [F2] VOICE (pages 189, 202)

- When the Song/Pattern produces no sound, are the output port/channel of each track in the Song/Pattern Play mode and the receive port/channel of each Part in the Mixing set appropriately?

[SONG]/[PATTERN] → [F3] TRACK (pages 178, 196)

[SONG]/[PATTERN] → [MIXING] → [EDIT] → Part selection → [F1] VOICE → [SF2] MODE → ReceiveCh (pages 191, 202)

- When the Song/Pattern produces no sound, is the Velocity Offset parameter in the Groove display set appropriately?

[SONG]/[PATTERN] → [F2] GROOVE → VELO OFST (pages 178, 196)

■ Playback continues without stopping.

- When the [ARPEGGIO ON/OFF] button is turned on, press it so that its lamp is turned off.
- When in the Song/Pattern mode, press the [■] (Stop) button.
- When the click sound continues, check the following settings. If the parameter is set to “all,” set it to something other than “all.”

[SONG]/[PATTERN] → [UTILITY] → [F3] SEQ → [SF1] CLICK → Mode (page 206)

■ Distorted sound.

- Are the effect settings appropriate? (Some effect types or settings can cause distortion.)

[VOICE] → [EDIT] → [COMMON] → [F6] EFFECT (page 158)

[PERFORM] → [EDIT] → [COMMON] → [F6] EFFECT (page 173)

[SONG]/[PATTERN] → [MIXING] → [F3] EFFECT (pages 189, 202)

- Are the filter settings appropriate? (Excessively high filter resonance settings can cause distortion.)

[VOICE] → [EDIT] → Element/Key selection → [F3] FILTER (page 160)

[PERFORM] → [EDIT] → Part selection → [F4] TONE → [SF2] FILTER (page 176)

[SONG]/[PATTERN] → [MIXING] → [EDIT] → Part selection → [F4] TONE → [SF2] FILTER (pages 191, 202)

- Is the volume set so high that clipping is occurring?

[UTILITY] → [F1] GENERAL → [SF1] TG → Volume (page 205)

[VOICE] → [EDIT] → [COMMON] → [F2] OUTPUT → Volume (page 154)

[PERFORM] → [EDIT] → [COMMON] → [F2] OUT/MEF → [SF1] OUT → Volume (page 172)

[SONG]/[PATTERN] → [MIXING] → [F1] VOL/PAN → VOLUME (pages 189, 202)

■ Sound is choppy and intermittent.

- Are you exceeding the maximum polyphony of this instrument? (page 134)

■ Only one note sounds at a time.

- Is the Mono/Poly parameter set to “mono”?
If you wish to play chords, set this parameter to “poly.”

[VOICE] → [F4] PORTA → Mono/Poly (page 153)

[PERFORM] → [EDIT] → Part selection → [F1] VOICE → [SF2] MODE → Mono/Poly (page 174)

[SONG]/[PATTERN] → [MIXING] → [EDIT] → Part selection → [F1] VOICE → [SF2] MODE → Mono/Poly (pages 191, 202)

■ Pitch or intervals are wrong.

- Is the Master Tune parameter set at a value other than “0”?

[UTILITY] → [F1] GENERAL → [SF1] TG → Tune (page 205)

- Is the Note Shift parameter set at a value other than “0”?

[UTILITY] → [F1] GENERAL → [SF1] TG → NoteShift (page 205)

- When the voice produces a wrong pitch, is the appropriate tuning system selected from Micro Tuning parameter?

[VOICE] → [EDIT] → [COMMON] → [F1] GENERAL → [SF2] PLY MODE → M.TuningNo. (page 153)

- When the voice produces a wrong pitch, is the LFO Pitch Modulation Depth set too high?

[VOICE] → [EDIT] → Element/Key selection → [F5] LFO → PMod (page 163)

- When the Performance/Song/Pattern produces a wrong pitch, is the Note Shift or Detune parameter of each Part set to a value other than “0”?

[PERFORM] → [EDIT] → Part selection → [F4] TONE → [SF1] TUNE (page 176)

[SONG]/[PATTERN] → [MIXING] → [EDIT] → Part selection → [F4] TONE → [SF1] TUNE (pages 191, 202)

- When the Performance/Song/Pattern produces a wrong pitch, is the Note Offset parameter in the Groove display set to a value other than “0”?

[SONG]/[PATTERN] → [F2] GROOVE → NOTE OFST (pages 178, 196)

■ No effects are applied.

- Is the [EFFECT BYPASS] button turned off?
- Are the Knobs (for REVERB and CHORUS) set to appropriate levels (other than zero or minimum)?
- Have any or all of the Elements’ Effect Output parameters been set to “thru” in the effect setting display?

[VOICE] → [EDIT] → [COMMON] → [F6] EFFECT → [SF1] CONNECT → EL: OUT 1-4 (page 142)

- Have any or all of the effect types been set to “thru” or “off”? (pages 142 – 144)
- When this occurs in the Performance/Song/Pattern mode, check whether the Insertion Switch (INS SW) parameters are set properly or not.

[PERFORM] → [EDIT] → [COMMON] → [F6] EFFECT → [SF2] INS SW (page 173)

[SONG]/[PATTERN] → [MIXING] → [F3] EFFECT → [SF2] INS SW (pages 189, 202)

■ The Edit Indicator appears, even when parameters are not being edited.

- Keep in mind that simply moving a Knob or Slider changes the parameter, automatically displaying the Edit indicator.

■ Cannot start the Arpeggio.

- Check whether the [ARPEGGIO] button is turned on or off.
- Have you selected a User Arpeggio type (with no User data)?
- Are the Arpeggio related parameters such as Note Limit and Velocity Limit set appropriately?

[VOICE] → [EDIT] → [COMMON] → [F3] ARP → [SF2] LIMIT (page 155)

[PERFORM] → [EDIT] → [COMMON] → [F3] ARP → [SF2] LIMIT (page 173)

[SONG]/[PATTERN] → [MIXING] → [EDIT] → [COMMON] → [F3] ARP → [SF2] LIMIT (pages 190, 202)

- When this occurs in the Performance/Song/Pattern mode, check whether the Arpeggio Switch parameter for each Part is set properly or not.

[PERFORM] → [EDIT] → Part selection → [F1] VOICE → [SF2] MODE → ArpSwitch (page 174)

[SONG]/[PATTERN] → [MIXING] → [EDIT] → Part selection → [F1] VOICE → [SF2] MODE → ArpSwitch (pages 191, 202)

- Is the MIDI sync parameter set to “internal” (using internal clock)?

[UTILITY] → [F5] MIDI → [SF3] SYNC → MIDI Sync = internal (page 210)

■ Cannot stop the Arpeggio.

- When Arpeggio playback does not stop even if you release the key, set the Arpeggio Hold parameter to “off.”

[VOICE] → [EDIT] → [COMMON] → [F3] ARP → [SF1] TYPE → Hold (page 152)

[PERFORM] → [EDIT] → [COMMON] → [F3] ARP → [SF1] TYPE → Hold (page 173)

[SONG]/[PATTERN] → [MIXING] → [EDIT] → [COMMON] → [F3] ARP → [SF1] TYPE → Hold (pages 190, 202)

■ The Song/Pattern cannot be started even when pressing the [▶] (Play) button.

- Does the selected Song or Pattern (phrase) actually contain data?
- Is the Remote Control feature turned on?
- Is the MIDI sync parameter set to “internal” (using internal clock)?

[UTILITY] → [F5] MIDI → [SF3] SYNC → MIDI Sync = internal (page 210)

■ **Song/Pattern (Phrase) cannot be recorded.**

- Is there enough free memory for recording? The total memory capacity determines the number of Songs/Patterns (phrases) that can be recorded. For example, if the memory contains Songs/Patterns (phrases) that use up a large amount of memory, the memory may become full even though the available Pattern or Song numbers are not all used.
- In the Pattern Record mode, does the specified track to which the Phrase is assigned have preset data? Recording cannot be done to a track that contains preset data.

■ **Cannot enter the Pattern Job mode/Pattern Mixing mode.**

- Check whether this instrument is in the Pattern Chain mode or not. If so, exit from the Pattern Chain mode, then press the [JOB] button or [MIXING] button.

■ **The drum sound is wrong or unexpected when changing the transpose value.**

- This is normal. Changing the transpose setting while playing a Drum Voice will produce different sounds for the same keys played.

■ **Data communication between the computer and this instrument does not work properly.**

- Check whether the Port setting on the computer is appropriate or not.
- Is the cable setting (MIDI, USB) in the Utility mode appropriate?

[UTILITY] → [F5] MIDI → [SF4] OTHER → MIDI IN/OUT (page 210)

■ **This instrument does not sound properly even when playing back song data on a computer or a MIDI instrument connected to this instrument.**

- Make sure to set this instrument to the Song mode or Pattern mode. To play back multiple channels simultaneously, Song mode or Pattern mode must be selected.

■ **MIDI bulk data transmission/reception does not work properly.**

- Is Bulk data receive protection enabled?
Turn the Receive Bulk parameter to “on.”

[UTILITY] → [F5] MIDI → [SF2] SWITCH → RcvBulk (page 209)

- When receiving recorded data with the internal Bulk Dump function, the device number must be set to the same value as that used when transmitting/recording.

[UTILITY] → [F5] MIDI → [SF1] CH → DeviceNo. (page 209)

- When transmission does not work properly, is the device number of the MIDI instrument connected to this instrument set to match the DeviceNo. parameter?

[UTILITY] → [F5] MIDI → [SF1] CH → DeviceNo. (page 209)

- When using the Voice Editor/Multi Part Editor, have you set a sufficient Dump Interval?
The Dump Interval in the Editor Setup dialog must be set to 20ms or greater. For details refer to the PDF manual included with the Editor.

■ **Data cannot be saved in the USB storage device**

- Is the connected USB storage device write protected? (Write-protect should be set to off for saving data.)
- Is the connected USB storage device properly formatted?

[FILE] → [F1] CONFIG → [SF2] FORMAT (page 211)

■ **Cannot enter the Edit mode**

- Is the Category Search function turned on?
After exiting from the Category Search function, press the [EDIT] button.
- Is this instrument in the File mode?
After exiting from the File mode, press the [EDIT] button.

Specifications

Keyboards	MO8	88 keys, Balanced Hammer Effect Keyboard (Initial Touch)
	MO6	61 keys, LC Keyboard (Initial Touch)
Tone Generator block	Tone Generator	AWM2
	Polyphony	64 notes
	Multi Timbral Capacity	16 parts (internal)
	Wave	175MB (when converted to 16-bit linear format), 1,859 waveforms
	Voice	Preset: 512 normal voices + 64 drum kits GM: 128 normal voices + 1 drum kit User: 128 x 2 (Bank 1: Original, Bank 2: Picked up from Preset) Normal Voice + 32 drum kits
	Performance	User: 256 (up to 4 parts)
	Filter	18 types
	Effect System	Reverb x 20 types, Chorus x 49 types, Insertion (A, B) x 116 types x 3 blocks, Master Effect x 8 types, Master Equalizer (5 bands), Part EQ (3 bands, stereo)
	Sequencer block	Note Capacity
Note Resolution		480 ppq (parts per quarter note)
Maximum Polyphony		124 notes
Tempo		1 – 300
Recording type		Real time replace, Real time overdub (with the exception of the Pattern Chain), Real time punch (Song only), Step (with the exception of the Pattern Chain)
Tracks		Pattern Mode: 16 phrase tracks Pattern Chain Mode: Pattern track, Tempo track, Scene track Song Mode: 16 sequence tracks (Loop on/off can be set for each track), Tempo track, Scene track
Patterns		64 patterns (x 16 sections) Measures: 256 maximum
Phrases		Preset Phrases: 687 phrases User Phrases: 256 per pattern
Songs		64 songs Mixing voices: 16 per pattern (256 maximum) Mixing templates: 32
Arpeggio		Preset x 1787 types, User x 256 types * MIDI Sync, MIDI transmit/receive channel, Velocity Limit, and Note Limit can be set.
Scene Memory		5 per Song
Sequence Format		MO6/MO8 Original format (compatible with MOTIF ES) SMF format 0, 1 (Format 1 load only)
Others		Master
	Sequence Software compatible with the Remote Control function	<ul style="list-style-type: none"> • For Windows Cubase SX 3, SQ01 V2, SONAR 4, MO6/MO8/MOTIF ES/MOTIF-RACK ES/MOTIF-RACK/S90 ES Multi Part Editor • For Macintosh Cubase SX 3, Logic Pro 7, Digital Performer 4.52, MO6/MO8/MOTIF ES/MOTIF-RACK ES/MOTIF-RACK/S90 ES Multi Part Editor *Functions to be controlled by the MO6/MO8 differ depending on the software you use.
	Controllers	Pitch Bend wheel, Modulation wheel, Assignable Control Sliders (4), Assignable Knobs (4), Data dial
	Display	240 x 64 dot graphic backlit LCD
	Connectors	OUTPUT L/MONO, R (standard phone jack) PHONES (standard stereo phone jack) DIGITAL OUT (RCA-pin) FOOT CONTROLLER FOOT SWITCH MIDI IN/OUT/THRU USB (TO HOST, TO DEVICE) DC INLET
	Power Consumption	13.5 W
	Dimensions, Weight	MO6: 1,023(W) x 382.7(D) x 101.9(H) mm., 10.4kg MO8: 1,357(W) x 386(D) x 167(H) mm, 21kg
	Accessories	Power adapter, Owner's Manual (this book), Data List

* Specifications and descriptions in this owner's manual are for information purposes only. Yamaha Corp. reserves the right to change or modify products or specifications at any time without prior notice. Since specifications, equipment or options may not be the same in every locale, please check with your Yamaha dealer.

Index

Numerics

[1] – [16] buttons	17, 34
1/4 Shift (1/4 shifted)	169
1/4 tone	169
1/8 tone	169

A

[A] – [H] buttons	17, 34
Accessories	6
Active Sensing (FEH)	226
ADD	171
AEG (Amplitude Envelope Generator)	134, 162, 176, 191
Aftertouch	72
All Notes Off	225
All Sounds Off	225
ALL TR (All Track)/1TR (1 track)	180
AlternatePan	162
AltNateGroup	59
AMod (Amplitude Modulation Depth)	163
AMP (Amplitude)	162, 167
Amplitude	134
Append Pattern	201
Append Phrase	200
Arabic 1 – 3	169
ARP (Arpeggio)	152, 171, 173, 180, 190, 208
ARP CH (Arpeggio Channel)	206
[ARP FX] button	51
ARP1 – ARP5	40, 74
Arpeggio	48, 78, 88, 89
[ARPEGGIO ON/OFF] button	48
Arpeggio type	145
ArpSwitch (Arpeggio Switch)	174, 191
AS1 (ASSIGN 1)	151, 171, 173, 215
AS2 (ASSIGN 2)	151, 171, 173, 215
ASA (ASSIGN A)	151, 171, 208, 215
ASB (ASSIGN B)	151, 171, 208, 215
ASSIGN	208
ASSIGN A/B	71
Assign1/2	154
AssignA/B	154
AssignMode	166
Attack (Attack Time)	176
Attack Time	224
AutoLoad	206
AWM2	129

B

BAK DEL (Back Delete)	181
Band Elimination Filter	133
Band Pass Filter	133
Bank	17
Bank Select LSB	224
Bank Select MSB	224
BankSel	209
BasicRcvCh (Basic Receive Channel)	209
BC (Breath Controller)	173
BCCurve (Breath Controller Curve)	205
Beat Graph	181
Beat Stretch	187
BEF12 (12dB/oct Band Elimination Filter)	170
BEF6 (6dB/oct Band Elimination Filter)	170
BOX1 – 3	157

BPF12D (12dB/oct Digital Band Pass Filter)	170
BPF6 (6dB/oct Band Pass Filter)	170
BPFw (Wide Band Pass Filter)	170
Breath Controller	72
Brightness	224
BULK (Bulk Dump)	168, 177, 192, 218
Bulk Dump	148

C

Cable clip	18
[CATEGORY SEARCH] button	42
CenterKey	159, 160, 161, 162
CH (Channel)	209
Ch.AfterTouch (Channel After Touch)	182
CHAIN	179, 197
CHANGE	182, 197
CHANNEL	196
Channel Aftertouch	226
CHANNEL MESSAGE	224
Channel Mode Message	225
ChgTiming (Change Timing)	154
Chorus	140
Chorus Ctg	142
Chorus Pan	142
Chorus Return	142
Chorus Send	142
Chorus to Reverb	142
Chorus Typ	142
ChoSend (Chorus Send)	154, 166, 172, 175
CLEAR	196
Clear Pattern	202
Clear Phrase	200
Clear Song	189
Clear Track	188, 201
CLICK	80, 180, 206
CLOCK SFT (Clock Shift)	178
ClockOut	210
Coarse	159
Common Edit	53, 63, 94
Compare	36
Computer	107
CONFIG	211
Continue (FBH)	226
Contrast control	21
Control Change	182, 224
Control Change Number	72
Control slider	52
Controller	128
Controller Set	70
COPY	168, 177, 192, 196, 197, 204
Copy Event	186
Copy Pattern	201
Copy Phrase	199
Copy Song	189
Copy Track	188, 200
Create Continuous Data	186
Create Measure	187
Create Roll	185
Crescendo	184
CTL ASN (Controller Assign)	173, 191, 206, 208
CTL SET (Controller Set)	155
CtrlChange (Control Change mode)	209
CtrlReset (Controller Reset)	206
CURRENT	211
Cursor buttons	35

Curve	159, 161, 162
Cutoff	160, 161, 176
Cutoff Frequency	133
CutoffSens (Cutoff Sensitivity)	161

D

Data Decrement	225
Data dial	35
Data Entry LSB	224
Data Entry MSB	224
Data Increment	225
DAW	110
[DAW REMOTE] button	115
DC IN	20
[DEC/NO] button	35
Decay (Decay Time)	176
Decay Time	225
DELAY	156
Delay (Delay Time)	156
DelayTempo	158
DelayTempoSync	158
DELETE	171, 181, 204, 212
Delete Measure	188
Demo Songs/Patterns	73
Depth	70, 155, 157
Dest (Destination)	155, 157, 208
Destination	70, 71
Detune	176
DeviceNo. (Device Number)	209
DIGITAL OUT	19
Display Message	221
Distance	160
Divide Drum Track	188, 201
DptRatio EL1 – EL4 (Depth Offset Element 1 – Element 4)	157
DRAM	150
[DRUM KITS] button	41
Drum Voice	41, 132
Drum Voice Edit	57
Dry Level	175
Dual BEF (Dual Band Elimination Filter)	170
Dual BPF (Dual Band Pass Filter)	170
Dual HPF (Dual High Pass Filter)	170
Dual LPF (Dual Low Pass Filter)	170
DumplInterval (Bulk Dump Interval Time)	207

E

Echo	109
Edit Buffer	150
[EDIT] button	24, 53, 63
Edit indicator	36
Edit Recall	37
EF BYPS (Effect Bypass)	205
EF SEND (Effect Send)	175, 189, 191
EFFECT	140, 151, 158, 171, 173, 189, 191
[EFFECT BYPASS] button	16, 140
Effect connection	142
Effect Off	140
Effect1 Depth	225
Effect3 Depth	225
EG (Envelope Generator)	152, 171
EGDepth	159, 161
EGTime	159, 160, 162
EGTimeSens (EG Time Sensitivity)	160, 161, 162

- Element 53
 Element Edit 53
 Element EQ 141
 Element Switch 70
 ElementSw (Element Switch) 155, 158
 ElemSw (Element Switch) 157
 [ENTER] button 17
 EQ (Equalizer) 164, 167, 175, 191
 [EQ] button 51
 Equal Temp (Equal temperament) 169
 Equalizer (EQ) 141
 Erase Event 186
 Event 179, 198
 EVENT (Event Job) 186, 199
 Exchange Phrase 199
 Exchange Track 188, 200
 Exclusive (System Exclusive) 183
 EXEC 211, 212
 [EXIT] button 28
 Expression 224
 EXT SW (External Switch) 179
 Extract Event 186
- F**
- [F1] – [F6] buttons 33
 Factory Settings 26
 FadeIn (Fade In Time) 156
 FadeInTime 163
 FadeOut 157
 Favorite Category 43
 FC1 (Foot Controller 1) 173
 FC2 (Foot Controller 2) 173
 FEG (Filter Envelope Generator) 133, 161, 176, 191
 FEGDepth 176
 [FILE] button 24, 148
 File mode 211
 File types 214
 FILTER 133, 160, 166, 176, 191
 FILTER (MIDI Filter) 207
 Filter Type List 170
 Fine 159
 FineScaling 159
 FixedVelocity 205
 Flash ROM 150
 FMod (Filter Modulation Depth) 163
 FOOT CONTROLLER 69
 FOOT SWITCH 69
 FORMAT 211
 FREQ (Frequency) 172
 FSAssign (Footswitch Assign) 209
 FT SW (Footswitch) 209
- G**
- Gain 160, 172
 GATE OFST (Gate time Offset) 178
 GateTime 181
 GateTimeRate 155
 General MIDI (GM) System On 226
 Get Phrase From Song 200
 Glide 185
 GM Preset Bank 40
 GM Voice 132
 GROOVE (Grid Groove) 178, 196
 Groove function 83, 88
- H**
- Harmonic Content 224
 High Pass Filter 133
 HighFreq (High Frequency) 175
 HighGain (High Gain) 175
 Hold 152, 154, 180, 208
 Hold (Hold Time) 156
 Hold1 224
 HPF12 (12dB/oct High Pass Filter) 170
 HPF24D (24dB/oct Digital High Pass Filter) 170
 HPFCutoff 160, 166
 HPFKeyFlw (Key Follow) 160
- I**
- [INC/YES] button 35
 Indian 169
 [INFORMATION] button 17, 37
 Information Display 219
 INIT (Initialize) 168, 177, 192, 218
 Ins A Ctgry 142
 Ins A Type 142
 Ins B Ctgry 142
 Ins B Type 142
 Ins EF Connect 142
 InsChoSend (Insertion Chorus Send) 165
 InsEF (Insertion Effect Part Switch) 180
 InsEF (Insertion Effect) 175
 InsEffectOut (Insertion Effect Output) 158
 INSERT 182
 Insertion Effect 140
 InsRevSend (Insertion Reverb Send) 165
 INT SW (Internal Switch) 179
 Interval 197
- J**
- [JOB] button 24
- K**
- KBD (Keyboard) 205
 KBDTransCh (Keyboard Transmit Channel) 209
 KEY FLW (Key Follow) 159, 162
 KeyAsgnMode (Key Assign Mode) 153
 Keyboard 16
 Keyboard Mega Voice 130
 KeyMode 154
 KeyOnDelay 158, 163
 KeyOnReset 156, 163
 Kirnberger 169
 KN/CS (Knob/Control Slider) 217
 Knob 51, 56, 65, 96
 Knob/Slider 216
 KnobAssign 154
- L**
- L&RGain 206
 Layer 46, 127
 LCD display 16
 LegatoSlope 153
 Level 162
 LevelSens (Level Sensitivity) 162
 LFO (Low Frequency Oscillator) 134, 156, 163
 LIMIT 155, 158
 LIMIT H (Note Limit High) 171
 LIMIT L (Note Limit Low) 171
- LOAD 211
 LoadMix 207
 Loc1 (Location 1) 74, 178
 Loc2 (Location 2) 74, 178
 Local Control 109
 LocalCtrl (Local Control On/Off) 209
 Loop 80, 198
 Loop Recording 139
 Low Pass Filter 133
 LowFreq (Low Frequency) 175
 LowGain (Low Gain) 175
 LPF12 (12dB/oct Low Pass Filter) 170
 LPF12 + BPF6 (12dB/oct Low Pass Filter + 6dB/oct Band Pass Filter) 170
 LPF18 (18dB/oct Low Pass Filter) 170
 LPF18s (18dB/oct Staggered Low Pass Filter) 170
 LPF24A (24dB/oct Analog Low Pass Filter) 170
 LPF24D (24dB/oct Digital Low Pass Filter) 170
 LPF6 (6dB/oct low-pass Filter) 170
 LPFCutoff 166
 LPFReso 166
- M**
- M. TuningNo. (Micro Tuning Number) 153
 M. TuningRoot (Micro Tuning Root) 153
 Main Volume 224
 Master 105
 [MASTER] button 24, 122
 Master Edit mode 216
 Master Effect 140
 [MASTER EFFECT] button 16
 Master EQ 141
 Master Job mode 218
 Master mode 122, 215
 Master Play mode 215
 Master Store mode 218
 Master Volume 226
 [MASTER VOLUME] slider 16
 Maximum Polyphony 134
 MEAS (Measure Job) 187
 MEAS (Measure) 74, 178, 180, 196, 198
 Meas (Measure) 180
 MEF (Master Effect) 172, 190, 206, 209
 MEMORY 215
 Memory structure 149
 MEQ (Master EQ) 172, 190, 206
 MEQ OFS (Master EQ Offset) 153, 172, 190
 Micro Tuning List 169
 MidFreq (Middle Frequency) 175
 MidGain (Middle Gain) 175
 MIDI 209, 223
 MIDI channel 107, 223
 MIDI connections 104
 MIDI IN/OUT/THRU 18, 104, 210
 MIDI Message 223
 MIDI port 107, 223
 MIDI Sync 210
 MIDISwitch 216
 MidReso (Middle Resonance) 175
 MIX 190
 Mix Phrase 200
 Mix Track 188
 Mixing 76, 129
 [MIXING] button 24
 Mixing Voice 78
 Mixing Voice Edit mode 203
 Mixing Voice Job mode 204
 Mixing Voice mode 203

Mixing Voice Store mode204
 MMC107
 MODE24
 Mode153, 174, 215
 Mode A113
 Mode B113
 Mode structure27
 Mode table28
 Modify Control Data187
 Modify Gate Time184
 Modify Velocity184
 Modulation224
 Modulation wheel50
 Mono225
 Mono/Poly151, 153, 174, 191
 MTC106
 MTC StartOffset210
 MTR (Multi Track Recorder)106
 Multi Part Editor112, 148
 Multi-timbral Tone Generator134
 [MUTE] button45, 75

N

NAME153, 172, 216
 Naming38
 NEW211, 212
 Normal Voice40, 132
 Normal Voice Edit53, 153
 Normalize Play Effect188, 201
 NOTE182, 216
 Note (Key) settings37
 NOTE (Note data Job)183, 199
 NOTE OFST (Note Offset)178
 Note On/Note Off (Key On/Key Off)224
 NoteLimit155, 158
 NoteLimitH (Note Limit High)174, 216
 NoteLimitL (Note Limit Low)174, 216
 NoteShift176, 205
 NRPN (Non Registered Parameter Number) ...183

O

OCT (Octave)40, 151, 171, 215
 Octave205, 216
 [OCTAVE UP] and [OCTAVE DOWN] buttons ..29
 Offset EL1 – EL4157
 OSC (Oscillator)132, 158, 165
 OUT CH (Output Channel)178
 OUT SW (Output Switch)196
 OUTPUT L/MONO and R19
 OutputSwitch173, 180, 206
 Overdub138

P

Pan154, 162, 172, 175, 180, 189, 224
 [PAN/SEND] button51
 Part Edit63, 94
 Part EQ141
 Part structure135
 PartSw (Part Switch)171, 174, 180
 PartSwitch171
 PATCH196
 Pattern23, 73, 136
 PATTERN (Pattern Job)201
 [PATTERN] button24
 Pattern Chain84, 138
 Pattern Chain Edit mode197

Pattern Chain Play mode197
 Pattern Chain Record mode197
 Pattern Edit mode90, 198
 Pattern Job mode90, 199
 Pattern Mixing138
 Pattern Mixing Edit mode93, 202
 Pattern Mixing Job mode202
 Pattern Mixing mode202
 Pattern Mixing Store mode202
 Pattern mode196
 Pattern Name202
 Pattern Play mode196
 Pattern Record mode198
 Pattern Track Edit197
 PB (Pitch Bend) Lower174
 PB (Pitch Bend) Upper174
 PB Lower (Pitch Bend range Lower)154
 PB Upper (Pitch Bend range Upper)154
 Peaking type141
 PEG (Pitch Envelope Generator)132, 159
 [PERFORM] button24
 PERFORMANCE190
 Performance23, 129
 Performance Edit mode63, 172
 Performance Job mode177
 Performance mode171
 Performance Play mode44, 171
 Performance Store mode177
 PF COPY (Performance Copy)192
 PgmChange (Program Change)209
 Phase157
 PHONES19
 PHRASE138, 179
 PHRASE (Phrase Job)199
 Phrase Name200
 Phrase Voice79
 PITCH132, 159, 166
 Pitch Bend182, 226
 Pitch Bend wheel50
 PitchSens (Pitch Sensitivity)159
 PLAY FX155
 PMod (Pitch Modulation Depth)163
 Pointer181
 Poly225
 PolyAfterTouch (Polyphonic Aftertouch)182
 Polyphonic Aftertouch226
 PORT179
 PORTA (Portamento) 151, 153, 171, 172, 174, 191
 Portamento Switch224
 Portamento Time224
 PortaMode (Portamento Mode)151
 PortaSw (Portamento Switch)151, 171
 PortaTime (Portamento Time)151, 171
 PowerOnMode206, 210
 PRESET217
 Preset Bank40
 Preset Phrase78
 Program33
 Program Change182, 225
 PtnQuantize (Pattern Quantize)207
 PtnTempoHold (Pattern Tempo Hold)207
 Punch In/Out88, 139
 PureMaj (Pure major)169
 PureMin (Pure minor)169
 Put Phrase To Song200
 Put Track To Arp188, 201

Q

Q (Frequency Characteristic)172
 Quantize80, 179, 183, 198
 QUICK SET208
 Quick Setup109
 QuntStrength (Quantize Strength)155
 QuntValue (Quantize Value)155

R

Random159
 RandomPan162
 RandomSpeed156
 RB (Ribbon Controller)173
 RCV SW (Receive Switch)176, 192
 RcvBulk (Receive Bulk)209
 RcvNoteOff (Receive Note Off)59, 166
 Realtime Recording82, 88, 138
 RECALL (Edit Recall)168, 177, 192, 204
 Recall Buffer150
 RecArp (Record Arpeggio)180
 RecCount207
 Receive Channel104
 ReceiveCh (Receive Channel)191
 RecTrack179
 Redo93
 Release (Release Level)176
 Release Time224
 REMIX197
 REMOTE209
 Remote control113
 RENAME212
 Replace138
 Reset All Controllers225
 Resonance133, 160, 161, 176
 REST181
 Reverb140
 Reverb Pan142
 Reverb Return142
 Reverb Send142
 Reverb Typ142
 RevSend (Reverb Send)154, 166, 172, 175
 Ribbon Controller72
 RPN (Registered Parameter Number)183
 RPN (Registered Parameter Number) LSB225
 RPN (Registered Parameter Number) MSB225

S

SAVE148, 211
 sawtooth wave163
 SCALE (Amplitude Scaling)163
 SCALE (Filter Scaling)161
 ScalingPan162
 Scene137
 Scene Track Edit197
 Section138
 [SECTION] button17
 Segment159, 160, 162
 SELECT (Output Select)191
 Separate Chord185
 SEQ (Sequencer)206
 SEQ TRANSPORT buttons16
 SeqCtrl (Sequencer Control)210
 Sequencer136
 SETNAME211, 212
 [SF1] – [SF5] buttons33
 SHAPE172

- Shelving type 141
 Shift Clock 186
 Single Timbre Tone Generator 134
 Slave 105
 Slope 157
 SMF (Standard MIDI File) 100
 [SOLO] button 45, 55, 75
 SONG 197
 Song 23, 73, 136
 SONG (Song Job) 189
 [SONG] button 24
 Song Chain 95, 137
 Song Edit mode 90, 182
 Song Job mode 90, 183
 Song Location 92
 Song Mixing 137
 Song Mixing Edit 93
 Song Mixing Edit mode 190
 Song Mixing Job mode 192
 Song Mixing mode 189
 Song Mixing Store mode 192
 Song mode 178
 Song Name 189
 Song Play mode 178
 Song Record mode 179
 Song Scene 89
 Song Track Loop 193
 SongEventChase 207
 Sort Chord 185
 Sostenuuto 224
 Source 70, 155
 Specifications 231
 Speed 156, 163
 Split 47, 127
 Split Pattern 201
 Split Phrase 200
 Split Song To Pattern 189
 square wave 163
 [STANDBY/ON] switch 20
 Start (FAH) 226
 Step 157
 Step Recording 82, 88, 138, 193
 StepTime 181
 Stop (FCH) 226
 Store 148
 [STORE] button 24, 148
 Studio Connections 112
 Sustain (Sustain Level) 176
 Swing 155
 SWITCH 209
 Switch 152, 153, 154, 172, 174, 208
 SYNC (Synchronization) 210
 System Common Message 226
 System Effect 140
 System Exclusive Message 226
 SYSTEM MESSAGE 226
 System Realtime Message 226
- T**
- TCH (Transmit Channel) 40, 151, 171
 TEMPLATE 190
 Template 94, 157
 Tempo 152, 154, 180, 198
 Tempo Track Edit 197
 TempoSpeed 156
 TempoSync 156
 TG (Tone Generator) 205
 TGSwitch (Tone Generator Switch) 216
 Thin Out 187
 Thru Port 108, 210
 TIE 181
 Time 153, 174
 TimeMode 153
 Timing Clock (F8H) 226
 TONE 176, 191
 [TONE] button 51
 Tone Generator 129
 TR LOOP (Track Loop) 179
 TR SEL (Track Select) 182
 TR VCE (Track Voice) 196
 TRACK 196
 TRACK (Track Job) 188, 200
 [TRACK SELECT] button 17
 Trans 74
 TRANS (Transmit) 216
 Trans (Transpose) 178, 196
 TransCh (Transmit Channel) 216
 Transmit Channel 43, 45, 104
 TransmitCh (Transmit Channel) 173, 180, 206
 Transpose 29, 185, 205, 216
 triangle wave 163
 Troubleshooting 227
 TUNE 159, 176, 191, 205
 TX SW (Transmit Switch) 217
 TYPE 160
 Type 80
 Type (Recording Type) 179, 198
- U**
- Undo 93
 UNDO/REDO 183, 199
 UnitMultiply (Unit Multiply) 155
 USB 18, 30, 107
 USB TO DEVICE connector 31
 USB TO HOST connector 31
 USB-MIDI driver 110
 User Bank 40
 User Memory 150
 User Phrase 81
 USR 40
 [UTILITY] button 24
 Utility Job mode 210
 Utility mode 205
- V**
- Vallot&Yng (Vallotti & Young) 169
 Value 157, 181
 Variation 197
 VCE ED (Mixing Voice Edit) 189
 VEL SENS (Velocity Sensitivity Depth) 162
 VEL SENS (Velocity Sensitivity) 159, 160
 VelCrossFade (Velocity Cross Fade) 158
 VelCurve (Velocity Curve) 205
 VelLimit (Velocity Limit) 152, 180
 VelLimitH (Velocity Limit High) 174
 VelLimitL (Velocity Limit Low) 174
 VelMode (Velocity Mode) 154
 VELO OFST (Velocity Offset) 178
 VelocityLimit 155, 158
 VelocityRate 155
 VelSensDpt (Velocity Sensitivity Depth) 174
 VelSensOfst (Velocity Sensitivity Offset) 175
 VIEW FLT (View Filter) 182
 Voice 23, 129, 180
 [VOICE] button 24
 Voice Edit 53
 Voice Edit mode 153
 Voice Editor 112, 148
 Voice Job mode 168
 Voice mode 151
 Voice Play mode 40, 151
 Voice Store mode 168
 VoiceELPan (Voice Element Pan) 175
 Volume 154, 172, 175, 180, 189, 205
- W**
- Wave 156, 163
 Wave No. (Waveform Number) 158
 WaveCtgr (Waveform Category) 158
 Werckmeister (Werckmeister) 169
 Width 160
- Z**
- Zone 123
 Zone Edit 216
 ZoneSwitch 215

Memo

Memo

Memo

For details of products, please contact your nearest Yamaha representative or the authorized distributor listed below.

Pour plus de détails sur les produits, veuillez-vous adresser à Yamaha ou au distributeur le plus proche de vous figurant dans la liste suivante.

Die Einzelheiten zu Produkten sind bei Ihrer unten aufgeführten Niederlassung und bei Yamaha Vertragshändlern in den jeweiligen Bestimmungsländern erhältlich.

Para detalles sobre productos, contacte su tienda Yamaha más cercana o el distribuidor autorizado que se lista debajo.

NORTH AMERICA

CANADA

Yamaha Canada Music Ltd.
135 Milner Avenue, Scarborough, Ontario,
M1S 3R1, Canada
Tel: 416-298-1311

U.S.A.

Yamaha Corporation of America
6600 Orangethorpe Ave., Buena Park, Calif. 90620,
U.S.A.
Tel: 714-522-9011

CENTRAL & SOUTH AMERICA

MEXICO

Yamaha de México S.A. de C.V.
Calz. Javier Rojo Gómez #1149,
Col. Guadalupe del Moral
C.P. 09300, México, D.F., México
Tel: 55-5804-0600

BRAZIL

Yamaha Musical do Brasil Ltda.
Av. Reboucas 2636-Pinheiros CEP: 05402-400
Sao Paulo-SP. Brasil
Tel: 011-3085-1377

ARGENTINA

Yamaha Music Latin America, S.A.
Sucursal de Argentina
Viamonte 1145 Piso2-B 1053,
Buenos Aires, Argentina
Tel: 1-4371-7021

PANAMA AND OTHER LATIN AMERICAN COUNTRIES/ CARIBBEAN COUNTRIES

Yamaha Music Latin America, S.A.
Torre Banco General, Piso 7, Urbanización Marbella,
Calle 47 y Aquilino de la Guardia,
Ciudad de Panamá, Panamá
Tel: +507-269-5311

EUROPE

THE UNITED KINGDOM

Yamaha-Kemble Music (U.K.) Ltd.
Sherbourne Drive, Tilbrook, Milton Keynes,
MK7 8BL, England
Tel: 01908-366700

IRELAND

Danfay Ltd.
61D, Sallynoggin Road, Dun Laoghaire, Co. Dublin
Tel: 01-2859177

GERMANY

Yamaha Music Central Europe GmbH
Siemensstraße 22-34, 25462 Rellingen, Germany
Tel: 04101-3030

SWITZERLAND/LIECHTENSTEIN

Yamaha Music Central Europe GmbH,
Branch Switzerland
Seefeldstrasse 94, 8008 Zürich, Switzerland
Tel: 01-383 3990

AUSTRIA

Yamaha Music Central Europe GmbH,
Branch Austria
Schleiergasse 20, A-1100 Wien, Austria
Tel: 01-60203900

CZECH REPUBLIC/SLOVAKIA/ HUNGARY/SLOVENIA

Yamaha Music Central Europe GmbH,
Branch Austria, CEE Department
Schleiergasse 20, A-1100 Wien, Austria
Tel: 01-602039025

POLAND

Yamaha Music Central Europe GmbH
Sp.z. o.o. Oddział w Polsce
ul. 17 Stycznia 56, PL-02-146 Warszawa, Poland
Tel: 022-868-07-57

THE NETHERLANDS/ BELGIUM/LUXEMBOURG

Yamaha Music Central Europe GmbH,
Branch Benelux
Clarissenhof 5-b, 4133 AB Vianen, The Netherlands
Tel: 0347-358 040

FRANCE

Yamaha Musique France
BP 70-77312 Marne-la-Vallée Cedex 2, France
Tel: 01-64-61-4000

ITALY

Yamaha Musica Italia S.P.A.
Combo Division
Viale Italia 88, 20020 Lainate (Milano), Italy
Tel: 02-935-771

SPAIN/PORTUGAL

Yamaha-Hazen Música, S.A.
Ctra. de la Coruna km. 17, 200, 28230
Las Rozas (Madrid), Spain
Tel: 91-639-8888

GREECE

Philippos Nakas S.A. The Music House
147 Skiathou Street, 112-55 Athens, Greece
Tel: 01-228 2160

SWEDEN

Yamaha Scandinavia AB
J. A. Wettergrens Gata 1
Box 30053
S-400 43 Göteborg, Sweden
Tel: 031 89 34 00

DENMARK

YS Copenhagen Liaison Office
Generatorvej 6A
DK-2730 Herlev, Denmark
Tel: 44 92 49 00

FINLAND

F-Musiikki Oy
Kluuvikatu 6, P.O. Box 260,
SF-00101 Helsinki, Finland
Tel: 09 618511

NORWAY

Norsk filial av Yamaha Scandinavia AB
Grini Næringspark 1
N-1345 Østerås, Norway
Tel: 67 16 77 70

ICELAND

Skifan HF
Skeifan 17 P.O. Box 8120
IS-128 Reykjavik, Iceland
Tel: 525 5000

OTHER EUROPEAN COUNTRIES

Yamaha Music Central Europe GmbH
Siemensstraße 22-34, 25462 Rellingen, Germany
Tel: +49-4101-3030

AFRICA

Yamaha Corporation,
Asia-Pacific Music Marketing Group
Nakazawa-cho 10-1, Hamamatsu, Japan 430-8650
Tel: +81-53-460-2312

MIDDLE EAST

TURKEY/CYPRUS

Yamaha Music Central Europe GmbH
Siemensstraße 22-34, 25462 Rellingen, Germany
Tel: 04101-3030

OTHER COUNTRIES

Yamaha Music Gulf FZE
LB21-128 Jebel Ali Freezone
P.O.Box 17328, Dubai, U.A.E.
Tel: +971-4-881-5868

ASIA

THE PEOPLE'S REPUBLIC OF CHINA

Yamaha Music & Electronics (China) Co.,Ltd.
25/F., United Plaza, 1468 Nanjing Road (West),
Jingan, Shanghai, China
Tel: 021-6247-2211

HONG KONG

Tom Lee Music Co., Ltd.
11/F., Silvercord Tower 1, 30 Canton Road,
Tsimshatsui, Kowloon, Hong Kong
Tel: 2737-7688

INDONESIA

PT. Yamaha Music Indonesia (Distributor)
PT. Nusantik
Gedung Yamaha Music Center, Jalan Jend. Gatot
Subroto Kav. 4, Jakarta 12930, Indonesia
Tel: 21-520-2577

KOREA

Yamaha Music Korea Ltd.
Tong-Yang Securities Bldg. 16F 23-8 Yoido-dong,
Youngdungpo-ku, Seoul, Korea
Tel: 02-3770-0660

MALAYSIA

Yamaha Music Malaysia, Sdn., Bhd.
Lot 8, Jalan Perbandaran, 47301 Kelana Jaya,
Petaling Jaya, Selangor, Malaysia
Tel: 3-78030900

PHILIPPINES

Yupangco Music Corporation
339 Gil J. Puyat Avenue, P.O. Box 885 MCPO,
Makati, Metro Manila, Philippines
Tel: 819-7551

SINGAPORE

Yamaha Music Asia Pte., Ltd.
#03-11 A-Z Building
140 Paya Lebor Road, Singapore 409015
Tel: 747-4374

TAIWAN

Yamaha KHS Music Co., Ltd.
3F, #6, Sec.2, Nan Jing E. Rd. Taipei.
Taiwan 104, R.O.C.
Tel: 02-2511-8688

THAILAND

Siam Music Yamaha Co., Ltd.
891/1 Siam Motors Building, 15-16 floor
Rama 1 road, Wangmai, Pathumwan
Bangkok 10330, Thailand
Tel: 02-215-2626

OTHER ASIAN COUNTRIES

Yamaha Corporation,
Asia-Pacific Music Marketing Group
Nakazawa-cho 10-1, Hamamatsu, Japan 430-8650
Tel: +81-53-460-2317

OCEANIA

AUSTRALIA

Yamaha Music Australia Pty. Ltd.
Level 1, 99 Queensbridge Street, Southbank,
Victoria 3006, Australia
Tel: 3-9693-5111

NEW ZEALAND

Music Houses of N.Z. Ltd.
146/148 Captain Springs Road, Te Papapa,
Auckland, New Zealand
Tel: 9-634-0099

COUNTRIES AND TRUST TERRITORIES IN PACIFIC OCEAN

Yamaha Corporation,
Asia-Pacific Music Marketing Group
Nakazawa-cho 10-1, Hamamatsu, Japan 430-8650
Tel: +81-53-460-2312



Yamaha Web Site (English only)
<http://www.yamahasyth.com/>

Yamaha Manual Library
<http://www.yamaha.co.jp/manual/>

U.R.G., Pro Audio & Digital Musical Instrument Division, Yamaha Corporation
© 2005 Yamaha Corporation

WF68510 510MWCP58.2-01A0
Printed in Japan