



DIGITAL WORKSTATION

Tyros



English

Deutsch

Français

**Owner's Manual
Bedienungsanleitung
Mode D'emploi**



SPECIAL MESSAGE SECTION

PRODUCT SAFETY MARKINGS: Yamaha electronic products may have either labels similar to the graphics shown below or molded/stamped facsimiles of these graphics on the enclosure. The explanation of these graphics appears on this page. Please observe all cautions indicated on this page and those indicated in the safety instruction section.

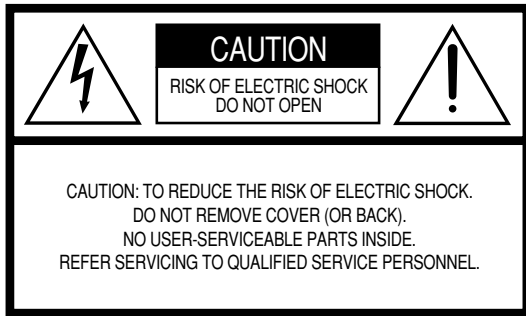

The exclamation point within the equilateral triangle is intended to alert the user to the presence of important operating and maintenance (servicing) instructions in the literature accompanying the product.

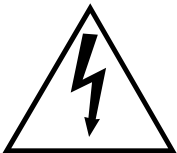

The lightning flash with arrowhead symbol, within the equilateral triangle, is intended to alert the user to the presence of uninsulated “dangerous voltage” within the product’s enclosure that may be of sufficient magnitude to constitute a risk of electrical shock.

IMPORTANT NOTICE: All Yamaha electronic products are tested and approved by an independent safety testing laboratory in order that you may be sure that when it is properly installed and used in its normal and customary manner, all foreseeable risks have been eliminated. **DO NOT** modify this unit or commission others to do so unless specifically authorized by Yamaha. Product performance and/or safety standards may be diminished. Claims filed under the expressed warranty may be denied if the unit is/has been modified. Implied warranties may also be affected.

SPECIFICATIONS SUBJECT TO CHANGE: The information contained in this manual is believed to be correct at the time of printing. However, Yamaha reserves the right to change or modify any of the specifications without notice or obligation to update existing units.

ENVIRONMENTAL ISSUES: Yamaha strives to produce products that are both user safe and environmentally friendly. We sincerely believe that our products and the production methods used to produce them, meet these goals. In keeping with both the letter and the spirit of the law, we want you to be aware of the following:

Battery Notice: This product MAY contain a small non-rechargeable battery which (if applicable) is soldered in place. The average life span of this type of battery is approximately five years. When replacement becomes necessary, contact a qualified service representative to perform the replacement.

Warning: Do not attempt to recharge, disassemble, or incinerate this type of battery. Keep all batteries away from children. Dispose of used batteries promptly and as regulated by applicable laws. Note: In some areas, the servicer is required by law to return the defective parts. However, you do have the option of having the servicer dispose of these parts for you.

Disposal Notice: Should this product become damaged beyond repair, or for some reason its useful life is considered to be at an end, please observe all local, state, and federal regulations that relate to the disposal of products that contain lead, batteries, plastics, etc.

NOTICE: Service charges incurred due to lack of knowledge relating to how a function or effect works (when the unit is operating as designed) are not covered by the manufacturer’s warranty, and are therefore the owners responsibility. Please study this manual carefully and consult your dealer before requesting service.

NAME PLATE LOCATION: The graphic below indicates the location of the name plate. The model number, serial number, power requirements, etc., are located on this plate. You should record the model number, serial number, and the date of purchase in the spaces provided below and retain this manual as a permanent record of your purchase.

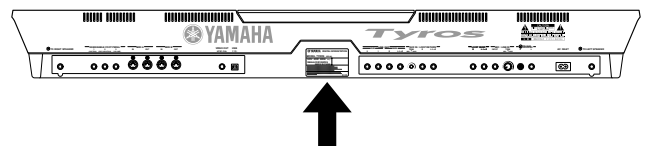

Model _____

Serial No. _____

Purchase Date _____

IMPORTANT SAFETY INSTRUCTIONS

INFORMATION RELATING TO PERSONAL INJURY, ELECTRICAL SHOCK, AND FIRE HAZARD POSSIBILITIES HAS BEEN INCLUDED IN THIS LIST.

WARNING- When using any electrical or electronic product, basic precautions should always be followed. These precautions include, but are not limited to, the following:

- 1.** Read all Safety Instructions, Installation Instructions, Special Message Section items, and any Assembly Instructions found in this manual **BEFORE** making any connections, including connection to the main supply.
- 2.** Main Power Supply Verification: Yamaha products are manufactured specifically for the supply voltage in the area where they are to be sold. If you should move, or if any doubt exists about the supply voltage in your area, please contact your dealer for supply voltage verification and (if applicable) instructions. The required supply voltage is printed on the name plate. For name plate location, please refer to the graphic found in the Special Message Section of this manual.
- 3.** This product may be equipped with a polarized plug (one blade wider than the other). If you are unable to insert the plug into the outlet, turn the plug over and try again. If the problem persists, contact an electrician to have the obsolete outlet replaced. Do **NOT** defeat the safety purpose of the plug.
- 4.** Some electronic products utilize external power supplies or adapters. Do **NOT** connect this type of product to any power supply or adapter other than one described in the owners manual, on the name plate, or specifically recommended by Yamaha.
- 5.** **WARNING:** Do not place this product or any other objects on the power cord or place it in a position where anyone could walk on, trip over, or roll anything over power or connecting cords of any kind. The use of an extension cord is not recommended! If you must use an extension cord, the minimum wire size for a 25' cord (or less) is 18 AWG. **NOTE:** The smaller the AWG number, the larger the current handling capacity. For longer extension cords, consult a local electrician.
- 6.** Ventilation: Electronic products, unless specifically designed for enclosed installations, should be placed in locations that do not interfere with proper ventilation. If instructions for enclosed installations are not provided, it must be assumed that unobstructed ventilation is required.
- 7.** Temperature considerations: Electronic products should be installed in locations that do not significantly contribute to their operating temperature. Placement of this product close to heat sources such as; radiators, heat registers and other devices that produce heat should be avoided.
- 8.** This product was **NOT** designed for use in wet/damp locations and should not be used near water or exposed to rain. Examples of wet/damp locations are; near a swimming pool, spa, tub, sink, or wet basement.
- 9.** This product should be used only with the components supplied or; a cart, rack, or stand that is recommended by the manufacturer. If a cart, rack, or stand is used, please observe all safety markings and instructions that accompany the accessory product.
- 10.** The power supply cord (plug) should be disconnected from the outlet when electronic products are to be left unused for extended periods of time. Cords should also be disconnected when there is a high probability of lightning and/or electrical storm activity.
- 11.** Care should be taken that objects do not fall and liquids are not spilled into the enclosure through any openings that may exist.
- 12.** Electrical/electronic products should be serviced by a qualified service person when:
 - a. The power supply cord has been damaged; or
 - b. Objects have fallen, been inserted, or liquids have been spilled into the enclosure through openings; or
 - c. The product has been exposed to rain; or
 - d. The product does not operate, exhibits a marked change in performance; or
 - e. The product has been dropped, or the enclosure of the product has been damaged.
- 13.** Do not attempt to service this product beyond that described in the user-maintenance instructions. All other servicing should be referred to qualified service personnel.
- 14.** This product, either alone or in combination with an amplifier and headphones or speaker/s, may be capable of producing sound levels that could cause permanent hearing loss. **DO NOT** operate for a long period of time at a high volume level or at a level that is uncomfortable. If you experience any hearing loss or ringing in the ears, you should consult an audiologist.
IMPORTANT: The louder the sound, the shorter the time period before damage occurs.
- 15.** Some Yamaha products may have benches and/or accessory mounting fixtures that are either supplied as a part of the product or as optional accessories. Some of these items are designed to be dealer assembled or installed. Please make sure that benches are stable and any optional fixtures (where applicable) are well secured **BEFORE** using. Benches supplied by Yamaha are designed for seating only. No other uses are recommended.

PLEASE KEEP THIS MANUAL

PRECAUTIONS

PLEASE READ CAREFULLY BEFORE PROCEEDING

* Please keep this manual in a safe place for future reference.



WARNING

Always follow the basic precautions listed below to avoid the possibility of serious injury or even death from electrical shock, short-circuiting, damages, fire or other hazards. These precautions include, but are not limited to, the following:

Power supply/Power cord

- Only use the voltage specified as correct for the instrument. The required voltage is printed on the name plate of the instrument.
- Check the electric plug periodically and remove any dirt or dust which may have accumulated on it.
- Use only the supplied power cord/plug.
- Do not place the power cord near heat sources such as heaters or radiators, and do not excessively bend or otherwise damage the cord, place heavy objects on it, or place it in a position where anyone could walk on, trip over, or roll anything over it.

Do not open

- This instrument contains no user-serviceable parts. Do not attempt to disassemble or modify the internal components in any way.

Water warning

- Do not expose the instrument to rain, use it near water or in damp or wet conditions, or place containers on it containing liquids which might spill into any openings.
- Never insert or remove an electric plug with wet hands.

Fire warning

- Do not put burning items, such as candles, on the unit. A burning item may fall over and cause a fire.

If you notice any abnormality

- If the power cord or plug becomes frayed or damaged, or if there is a sudden loss of sound during use of the instrument, or if any unusual smells or smoke should appear to be caused by it, immediately turn off the power switch, disconnect the electric plug from the outlet, and have the instrument inspected by qualified Yamaha service personnel.



CAUTION

Always follow the basic precautions listed below to avoid the possibility of physical injury to you or others, or damage to the instrument or other property. These precautions include, but are not limited to, the following:

Power supply/Power cord

- When removing the electric plug from the instrument or an outlet, always hold the plug itself and not the cord. Pulling by the cord can damage it.
- Remove the electric plug from the outlet when the instrument is not to be used for extended periods of time, or during electrical storms.
- Do not connect the instrument to an electrical outlet using a multiple-connector. Doing so can result in lower sound quality, or possibly cause overheating in the outlet.

Location

- Do not expose the instrument to excessive dust or vibrations, or extreme cold or heat (such as in direct sunlight, near a heater, or in a car during the day) to prevent the possibility of panel disfiguration or damage to the internal components.
- Do not use the instrument in the vicinity of a TV, radio, stereo equipment, mobile phone, or other electric devices. Otherwise, the instrument, TV, or radio may generate noise.
- Do not place the instrument in an unstable position where it might accidentally fall over.
- Before moving the instrument, remove all connected cables.
- Use only the stand specified for the instrument. When attaching the stand or rack, use the provided screws only. Failure to do so could cause damage to the internal components or result in the instrument falling over.
- Do not place objects in front of the instrument's air vent, since this may prevent adequate ventilation of the internal components, and possibly result in the instrument overheating.

Connections

- Before connecting the instrument to other electronic components, turn off the power for all components. Before turning the power on or off for all components, set all volume levels to minimum. Also, be sure to set the volumes of all components at their minimum levels and gradually raise the volume controls while playing the instrument to set the desired listening level.

Maintenance

- When cleaning the instrument, use a soft, dry cloth. Do not use paint thinners, solvents, cleaning fluids, or chemical-impregnated wiping cloths.

Handling caution

- Do not insert a finger or hand in any gaps on the instrument.
- Never insert or drop paper, metallic, or other objects into the gaps on the panel or keyboard. If this happens, turn off the power immediately and unplug the power cord from the AC outlet. Then have the instrument inspected by qualified Yamaha service personnel.
- Do not place vinyl, plastic or rubber objects on the instrument, since this might discolor the panel or keyboard.
- Do not rest your weight on, or place heavy objects on the instrument, and do not use excessive force on the buttons, switches or connectors.
- Do not operate the instrument for a long period of time at a high or uncomfortable volume level, since this can cause permanent hearing loss. If you experience any hearing loss or ringing in the ears, consult a physician.

Saving data

Saving and backing up your data

- RAM data (see page 65) is lost when you turn off the power to the instrument. Save the data to the User, Floppy Disk or optional Hard Disk drives. Saved data may be lost due to malfunction or incorrect operation. Save important data to a floppy disk or optional hard disk.
- When you change settings in a display page and then exit from that page, System Setup data (listed in the Parameter Chart of the separate Data List booklet) is automatically stored. However, this edited data is lost if you turn off the power without properly exiting from the relevant display.

Backing up the floppy disk

- To protect against data loss through media damage, we recommend that you save your important data onto two floppy disks.

Caution for data operations

Make sure NEVER to turn the TYROS' power off during any kind of data operation involving the USER/FD/HD drives — such as saving, deleting, or copying/pasting — until the operation is completely finished. (Make sure to wait until the alert message shown below disappears.) Turning the power off during the operation results in the loss of the data being saved or pasted to the respective drive.

Keeping the power on during such operations is particularly important in regard to the USER drive. Turning off the power while performing a save/delete/paste operation with the USER drive may result in loss of ALL data on the USER drive (upon the next power on) — and not just the data in question. In other words, if you are performing a save/delete/paste operation on only the song data of the USER drive and you turn off the power before the operation is completed, you risk losing ALL your USER drive data — including all voices, styles, Multi Pad banks and Registration Memory presets you've saved to the USER drive.



**Now executing.
(Don't turn off the power now,
otherwise the data may be damaged.)**

This caution also applies to creating a new folder on the USER drive or using the factory reset operation (page 159).

Yamaha cannot be held responsible for damage caused by improper use or modifications to the instrument, or data that is lost or destroyed.

Always turn the power off when the instrument is not in use.

Handling the Floppy Disk Drive(FDD) and Floppy Disk

Precautions

Be sure to handle floppy disks and treat the disk drive with care. Follow the important precautions below.

Compatible Disk Type

3.5" 2DD and 2HD type floppy disks can be used.

Inserting/Ejecting Floppy Disks

- To insert a floppy disk into the disk drive:
 - Hold the disk so that the label of the disk is facing upward and the sliding shutter is facing forward, towards the disk slot. Carefully insert the disk into the slot, slowly pushing it all the way in until it clicks into place and the eject button pops out.

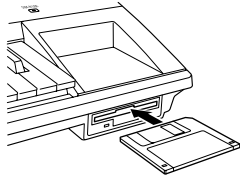

NOTE

- When the TYROS is turned on, the LED below the floppy disk slot will be lit indicating that the Disk Drive is ready to use.

- To eject a floppy disk:
 - Before ejecting the disk, be sure to confirm that the FDD is stopped (check if the LED below the floppy disk slot is off). Press the eject button slowly as far as it will go; the disk will automatically pop out. When the disk is fully ejected, carefully remove it by hand.

DISK IN USE

This lamp lights during disk read/write operations, such as when a disk has been inserted, during recording, playback, formatting, etc.

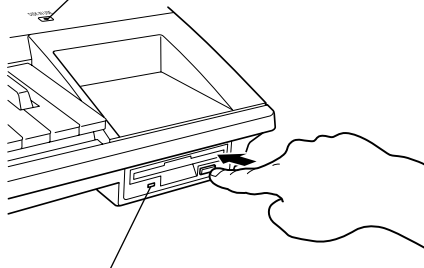

This lamp is always on when the power is on, regardless of the disk operation.

- Never attempt to remove the disk or turn the power off during recording, reading and playing back. Doing so can damage the disk and possibly the disk drive.
- If the eject button is pressed too quickly, or if it is not pressed in as far as it will go, the disk may not eject properly. The eject button may become stuck in a half-pressed position with the disk extending from the drive slot by only a few millimeters. If this happens, do not attempt to pull out the partially ejected disk, since using force in this situation can damage the disk drive mechanism or the floppy disk. To remove a partially ejected disk, try pressing the eject button once again, or push the disk back into the slot and then repeat the eject procedure.
- Be sure to remove the floppy disk from the disk drive before turning off the power. A floppy disk left in the drive for extended periods can easily pick up dust and dirt that can cause data read and write errors.

Cleaning the Disk Drive Read/Write Head

- Clean the read/write head regularly. This instrument employs a precision magnetic read/write head which, after an extended period of use, will pick up a layer of magnetic particles from the disks used that will eventually cause read and write errors.
- To maintain the disk drive in optimum working order Yamaha recommends that you use a commercially-available dry-type head cleaning disk to clean the head about once a month. Ask your Yamaha dealer about the availability of proper head-cleaning disks.
- Never insert anything but floppy disks into the disk drive. Other objects may cause damage to the disk drive or floppy disks.

About the Floppy Disks

- To handle floppy disks with care:
 - Do not place heavy objects on a disk or bend or apply pressure to the disk in any way. Always keep floppy disks in their protective cases when they are not in use.
 - Do not expose the disk to direct sunlight, extremely high or low temperatures, or excessive humidity, dust or liquids.
 - Do not open the sliding shutter and touch the exposed surface of the floppy disk inside.
 - Do not expose the disk to magnetic fields, such as those produced by televisions, speakers, motors, etc., since magnetic fields can partially or completely erase data on the disk, rendering it unreadable.
 - Never use a floppy disk with a deformed shutter or housing.
 - Do not attach anything other than the provided labels to a floppy disk. Also make sure that labels are attached in the proper location.
- To protect your data (Write-protect Tab):
 - To prevent accidental erasure of important data, slide the disk's write-protect tab to the "protect" position (tab open).

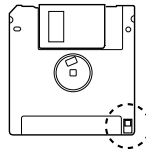

Write protect tab ON (locked or write protected)

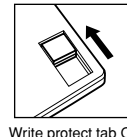

Write protect tab OFF (unlocked or write enabled)

- Data backup
 - For maximum data security Yamaha recommends that you keep two copies of important data on separate floppy disks. This gives you a backup if one disk is lost or damaged. To make a backup disk use the Disk Copy function on page 157.

Congratulations!

You are the proud owner of an extraordinary electronic keyboard. The Yamaha TYROS combines the most advanced tone generation technology with state-of-the-art digital electronics and features to give you stunning sound quality with maximum musical versatility. In order to make the most of your TYROS' features and vast performance potential, we urge you to read the manual thoroughly while trying out the various features described. Keep the manual in a safe place for later reference.

Packing List

- TYROS
- AC power cord x 1
- Music rest and brackets
- CD-ROM
- Owner's Manual (this book), Data List, Installation Guide
- USB cable

■ About the included CD-ROM

The accompanying CD-ROM features special software for use with the TYROS. Included is a Voice Editor, which gives you comprehensive and intuitive editing tools for the TYROS, and a File Utility, which lets you easily transfer data between the storage device connected to your TYROS and a computer. For details, see the separate Installation Guide or the online manuals included with the software.

CAUTION

- *Do NOT attempt to play back Track 1 (which contains the software data) on an audio CD player. Doing so may result in damage to your audio equipment and speakers, as well as your hearing.*

- The photos of the harpsichord, bandoneon, hackbrett, music box, dulcimer and cimbalom, shown in the displays of the TYROS, are courtesy of the Gakkigaku Shiriyokan (Collection for Organology), Kunitachi College of Music.
- The following instruments, shown in the displays of the TYROS, are on display at the Hamamatsu Museum of Musical Instruments: balafon, gender, kalimba, kanoon, santur, gamelan gong, harp, hand bell, bagpipe, banjo, carillon, mandolin, oud, pan flute, pungi, rabab, shanai, sitar, steel drum, tambra.
- This product is manufactured under license of U.S. Patents No.5231671, No.5301259, No.5428708, and No.5567901 from IVL Technologies Ltd.
- The bitmap fonts used in this instrument have been provided by and are the property of Ricoh Co., Ltd.
- Apple and Macintosh are trademarks of Apple Computer, Inc.
- IBM-PC/AT is a trademark of International Business Machines Corporation.
- Windows is the registered trademark of Microsoft® Corporation.
- All other trademarks are the property of their respective holders.

The illustrations and LCD screens as shown in this owner's manual are for instructional purposes only, and may appear somewhat different from those on your instrument.

Note that all display examples shown in this manual are in English.



GM System Level 1

“GM System Level 1” is a standard specification that defines the arrangement of voices in a tone generator and its MIDI functionality, ensuring that data can be played back with substantially the same sounds on any GM-compatible tone generator, regardless of its manufacturer or model. Tone generators and song data that meet the “GM System Level 1” bear this GM logo.



GM System Level 2

“GM System Level 2” is a standard specification that enhances the original “GM System Level 1” and improves song data compatibility. It provides for increased polyphony, greater voice selection, expanded voice parameters, and integrated effect processing. Tone generators and song data that meet the “GM System Level 2” specifications bear this GM2 logo.



XG

“XG” is a tone generator format that expands the voice arrangement of the “GM System Level 1” specification to meet the ever-increasing demands of today’s computer peripheral environment, providing richer expressive power while maintaining upward compatibility of data. “XG” greatly expands “GM System Level 1” by defining the ways in which voices are expanded or edited and the structure and type of effects. When commercially available song data bearing the XG logo is played back on a tone generator which bears the XG logo, you will enjoy a full musical experience that includes unlimited expansion voices and effect functions.



XF

The Yamaha XF format enhances the SMF (Standard MIDI File) standard with greater functionality and open-ended expandability for the future. The TYROS is capable of displaying lyrics when an XF file containing lyric data is played.



Vocal Harmony

Vocal Harmony employs state-of-the-art digital signal processing technology to automatically add appropriate vocal harmony or harmonies to a lead vocal line sung by the user. Vocal Harmony can even change the character and gender of the lead voice as well as the added voices to produce a wide range of vocal harmony effects.



DOC

The DOC voice allocation format provides data playback compatibility with a wide range of Yamaha instruments and MIDI devices, including the Clavinova series.



Style File Format

The Style File Format —SFF— is Yamaha’s original style file format which uses a unique conversion system to provide high-quality automatic accompaniment based on a wide range of chord types. The TYROS uses the SFF internally, reads optional SFF style disks, and creates SFF styles using the Style Creator function.

This product incorporates and bundles computer programs and contents in which Yamaha owns copyrights or with respect to which it has license to use others’ copyrights. Such copyrighted materials include, without limitation, all computer software, styles files, MIDI files, WAVE data and sound recordings. Any unauthorized use of such programs and contents outside of personal use is not permitted under relevant laws. Any violation of copyright has legal consequences. DON’T MAKE, DIS-TRIBUTE OR USE ILLEGAL COPIES.

Copying of the commercially available software is strictly prohibited except for your personal use.

How to use the manual

Starting Up..... page 20

Before going on to any other part of the manual, we strongly suggest you read this section first. It shows you how to get started playing and using your new TYROS.

Quick Guide..... page 24

Unless you enjoy reading manuals, you're probably eager to start playing your new TYROS right now. If so, read this section.

Contents..... page 10

Application Index page 12

This special index is organized by functions and applications — not by single words — allowing you to quickly and easily find how to perform a particular operation or explore a topic of interest.

Panel Controls and Terminals..... page 16

Use this section to find out about all of the buttons and controls of the TYROS.

Basic Operations..... page 60

Here, we'll show you the basic structure in handling and organizing the data of the TYROS in files and the basic operations using the LCD display.

Function Tree page 75

This lists all functions of the TYROS according to their hierarchical structure, letting you easily see the relationship of the various functions and quickly locate desired information.

Reference page 78

Once you're familiar with everything above, lightly go over this comprehensive guide to all functions. You won't need (or want) to read everything at once, but it is there for you to refer to when you need information about a certain feature or function.

Troubleshooting..... page 164

If the TYROS does not function as expected or you have some problem with the sound or operation, refer to this section before calling your Yamaha dealer or service center. Most common problems and their solutions are covered here in a very simple and easy-to-understand way.

Glossary..... page 166

Important words and technical terms not fully explained in the manual are covered here.

Data List (separate)

This contains various important lists such as the Direct Access Chart, Chord Fingering Chart for Style playback, Voice List, Style List, Effect Type List, MIDI Data Format, MIDI Implementation Chart.

Installation Guide (separate)

Included with the TYROS are various software programs (on the CD-ROM) that let you use your computer with the TYROS for recording, data storage, and more. Refer to this guide for instructions on installing the included software.

Contents

Handling the Floppy Disk Drive(FDD) and Floppy Disk....	6
Congratulations!	7
Packing List	7
Panel logos	8
How to use the manual	9
Contents	10
Application Index.....	12
Panel Controls and Terminals.....	16
Top Panel & Connections	16
Rear Panel & Connections	18

Starting Up **20**

Power Supply.....	20
Optional Speaker.....	20
Music Rest	21
Turning the Power On/Off.....	22
Raising and Closing the Display Panel	23

Quick Guide **24**

Turning the Power On and Playing the Demos	24
Turning the Power On and Viewing the Main Display ...	24
Playing the Demos	24
Playing Voices.....	26
Selecting a Voice (RIGHT1) and playing the keyboard.....	26
Playing Two or Three Voices Simultaneously	27
Playing Different Voices with the Left and Right Hands	28
Adjusting the Octave Setting	28
Organ Flutes.....	29
Collecting your favorite voices to the User drive or floppy disk	30
Selecting and Playing a Style	
— Auto Accompaniment (ACMP)	32
Playing a melody with your right hand and playing chords with your left hand	32
Pattern Variation (Sections)	34
One Touch Setting	36
Adjusting the Volume Balance between the Style and the Keyboard	36
Turning Style Parts On/Off and Changing Voices	37
Playing Styles from Floppy Disks	37
The Multi Pads.....	38
Playing the Multi Pads.....	38
Using Chord Match.....	38
Voice Effects	39
Applying Harmony to Your Right-hand Melody	39
Calling Up Ideal Setups for Your Music	
— Music Finder	40
Selecting the desired music genre from the Record List.....	40
Searching the Ideal Setups by Keyword	41
Creating a Set of Favorite Records	42

Song Playback.....	43
Playback of Song Disks	43
Using Song Position Markers	44
Adjusting the Volume Balance between the Song and the Keyboard	45
Turning Song Parts On/Off	45
Singing with a Connected Microphone.....	46
Connecting a microphone.....	46
Singing Along with Lyrics.....	46
Applying harmony to your voice	47
Keyboard and Vocal Practice using the Guide function	48
Selecting a Guide menu	48
Keyboard Practice using “Follow Lights”	49
Vocal Practice using “Vocal Cue Time”	50
Saving and Recalling Custom Panel Setups	
— Registration Memory.....	51
Saving your Panel Setups to a Registration Memory.....	51
Saving your Registration Memory to the User drive ..	52
Recalling a Registration Memory Setup	53
Recording Your Performances and Creating Songs — Song Recording.....	54
Quick Recording	54
Multi Recording.....	56
Connecting to a Computer	58
Initial Setup.....	58
Using the Voice Editor.....	59
Using the File Utility.....	59

Basic Operations

— Organizing Your Data **60**

Display-based Controls	60
Help/Display Messages	61
Direct Access — Instant Selection of Displays	62
Basic Structure of File/Folder and Memory Drives	62
Folder/File Operations using the Open/Save Display	66
Creating a New Folder	67
Selecting (Opening) a Folder/File	67
Copying Folders/Files (Copy & Paste)	68
Moving Folders/Files (Cut & Paste)	68
Deleting Folders/Files	69
Saving Files	69
Naming Folders/Files	70
Changing the Open/Save Display View	71
About the Highlight Cursor in the Display	73
About the Panel Button Colors	73
About the Keyboard	74
Keyboard Sections and Their Functions	74
Synchro Start On/Off.....	74
Function Tree	75

Reference	78	Mixing Console	134
Voices	78	Part Settings	135
Voices and Keyboard Parts	78	Song Auto Revoice	136
Voice Types	79	Effects	136
Voice Effects	81	Equalizer (EQ)	139
Changing Pitch on the TYROS	82	Master Compressor	140
Organ Flutes (Sound Creator)	83	Line Out Settings	140
Sound Creator Parameters (Organ Flutes Voices)	83	MIDI	142
Voice Creating (Sound Creator)	85	MIDI System Settings	146
Sound Creator Parameters (Normal Voices)	86	MIDI Transmit Settings	146
Song Playback	88	MIDI Receive Settings	147
Displaying Music Notation	88	Setting the Chord Root for	
Displaying Lyrics	90	Style Playback via MIDI receive	148
Song Position	91	Setting the Chord Type for	
Song Playback Related Parameters	92	Style Playback via MIDI receive	148
Song Creator (Digital Recording)	94	MFC10 Settings	148
Record Mode Settings (Setting up for Re-recording)	95	Making Global and Other Important Settings	
Editing Data for each Channel	96	– Function	150
Step Recording for Chord data using the Event List	98	Tuning	150
Step Recording for Notes using the Event List	100	Voice Set	151
Step Recording for System Exclusive Messages		Video Out Settings	151
using the Event List	106	Controller	152
Step Recording for Lyrics using the Event List	106	Harmony/Echo	154
Style Playback (Auto Accompaniment)	108	Other Settings (Utility)	156
Chord Fingerings	108		
Fade In/Out	109	Appendix	160
Tempo	109	Installing the Optional Speakers	160
Synchro Start and Synchro Stop	110	Installing an Optional Hard Disk	162
Programmable One Touch Setting (OTS)	110	Troubleshooting	164
Instant Style Selection	111	Glossary	166
Style Playback Related Settings	112	Specifications	168
Style Creator (Digital Recording)	114	Index	170
Basic Settings and Realtime Recording for			
each part (channel)	116		
Step Recording for Notes using the Event List	117		
Assembling a Style from Existing Pattern Data	118		
Groove and Dynamics	118		
Editing Data for each Channel	120		
Making Style File Format Settings	120		
Custom Style Recording via			
an External Sequence Recorder	122		
The Multi Pads	124		
Multi Pad Editing using the Open/Save display	124		
Multi Pad Creating/Editing (Digital Recording)	124		
Music Finder	126		
Music Finder Record Editing	126		
Saving Music Finder Records as a single file	126		
Registration Memory	128		
Freeze	128		
Registration Sequence	128		
Using a Microphone	130		
Vocal Harmony Edit	130		
Talk Setting	132		
Microphone Overall Settings	132		

Starting up before turning the power on

- Setting up the music rest Page 21
- Connecting headphones Page 16
- Turning the power on/off Pages 22, 24

Listening to the TYROS

- Playing the Demos Page 24
- Playing songs
 - Playing a Disk song Page 43
 - Turning parts (channels) of the song on/off Page 45
 - Adjusting the balance between the song and keyboard Page 45
- Playing styles
 - Playing Preset styles Page 32
 - Turning parts (channels) of the style on/off Page 37
 - Adjusting the balance between the style and keyboard Page 36
 - Playing styles from floppy disk Page 37
- Playing the Multi Pads Page 38

Playing the Keyboard

- Selecting a Voice (RIGHT1) and playing the keyboard Page 26
- Playing two or three voices simultaneously Page 27
- Playing different voices with the left and right hands Page 28
- Understanding the four keyboard parts (RIGHT1, 2, 3, and LEFT) Page 74
- Playing the drum/percussion voices Page 79
- Playing the Mega Voices Page 80
- Understanding Initial touch and Aftertouch Pages 81, 154
- Setting the touch sensitivity of the keyboard Page 154
- Turning Initial Touch on or off for each keyboard part (RIGHT1, 2, 3, LEFT) Page 154
- Turning Aftertouch on or off for each keyboard part (RIGHT1, 2, 3, LEFT) Page 154
- Setting the Modulation wheel for each keyboard part (RIGHT 1, 2, 3, LEFT) Page 154

Practicing the keyboard performance

- Using the Metronome Page 156
- Displaying and playing along with the music notation of the song during playback.....
 - Song Score Page 88
 - Guide Page 49

Selecting the programs and settings of the TYROS

- Voices Page 26
- Styles Page 32
- Multi Pad banks Page 38
- Songs Page 43
- Music Finder records Page 40
- Registration Memory banks Page 53
- Registration Memory numbers Page 53
- One Touch Setting numbers Page 36
- Harmony/Echo types Page 154
- MIDI templates Page 145
- Effect types Page 138
- Vocal Harmony types Page 47
- Master EQ types Page 139
- Master Compressor types Page 140

Using the LCD display

- Understanding and using the Main display Page 24
- Viewing the Song Lyrics on the LCD display Page 46, 90
- Viewing the Song Score on the LCD display Pages 50, 88
- Showing the display contents on a separate TV monitor Pages 18, 151

Playing style playback chords with your left hand and melodies with your right — Auto Accompaniment (ACMP) feature

- Selecting and playing a style Page 32
- Learning how to play specific chord types Chord Tutor Page 108
- Learning how to play (indicate) chords for style playback Chord Fingering Page 108
- Applying automatic harmony or echo to your right-hand melodies Harmony/Echo Pages 39, 154
- Automatically changing the chords of the Multi Pads
with your left-hand play Chord Match Page 38

Instantly selecting custom panel settings

- Calling up ideal panel setups Programmable Music Finder Pages 40, 126
- Changing setups to match the style Programmable One Touch Setting (OTS) Pages 36, 110
- Saving and recalling custom panel setups Registration Memory Pages 51, 128

Creating sounds, styles, songs, and more

- Data that can be created using the TYROS' features Pages 63 - 65
- Creating your original voices Sound Creator Page 85
- Creating your original Organ Flutes voices Sound Creator Page 83
- Creating your original styles Style Creator Page 114
 - Assembling a custom style from existing patterns Page 118
 - Recording a rhythm pattern Page 116
 - Memorize panel settings to the One Touch Setting contained in the style Page 110
- Creating your original songs
 - Recording your keyboard performance Pages 54 - 57
 - Inputting notes one by one Pages 98 - 105
 - Inputting and editing lyrics Page 106
 - Entering Markers in a song Pages 44, 106
- Creating your original Multi Pads Page 124
- Creating a Registration Memory bank Pages 52 - 53
- Creating new Music Finder records Page 126
- Creating new Vocal Harmony types Page 130
- Creating new Effect types Page 138
- Creating custom Master EQ settings Page 139
- Creating custom Master Compressor settings Page 140
- Naming the created data Page 70
- Saving the created data as a file Page 69

Understanding the organization and structure of the TYROS

- About the various types of data/files managed with the TYROS Pages 63 - 65
- About files and folders Page 63
- About the color-coded button lamps Page 73
- About the memory structure Pages 63 - 65
- About basic operations Pages 60 - 74
- About the tone generator parts Page 134
- About the effect structure Page 136

Controlling and adjusting the pitch

- Adjusting the overall pitch of the TYROS..... Master Tune Page 150
- Tuning the individual notes of the keyboard..... Scale Tune Page 150
- Adjusting the octave of the keyboard..... Pages 28, 135
- Transposing notes (Master Transpose, Keyboard Transpose, Song Transpose)..... Pages 82, 135
- Setting [TRANSCOPE] button to independently control separate parts Page 154
- Using the PITCH BEND wheel Page 82
- Using the MODULATION wheel..... Page 82

Using foot pedals

- Connecting foot pedals to the TYROS..... Page 18
- Assigning specific functions to each foot pedal Page 152
- Using a foot pedal to change Registration Memory numbers..... Registration Sequence Page 128

Singing with a connected microphone

- Connecting a microphone to the TYROS..... Page 46
- Automatically applying vocal harmonies to your voice..... Vocal Harmony Page 47
- Applying effects to your voice Page 130
- Singing while following along with the Lyrics on the display Page 46
- Singing while following along with the Lyrics on a separate TV monitor Page 90
- Singing with the Guide functions and song playback..... Page 50
- Using the Talk Setting function..... Page 132
- Matching the Song Transpose setting to a comfortable singing pitch Page 135
- Matching the Keyboard Transpose setting to a comfortable singing pitch Page 135

Live performance tips and techniques

- Assigning specific panel operations/functions for foot control Page 152
- Calling up Registration Memory numbers in custom-set order..... Registration Sequence Page 128
- Using a foot pedal to change Registration Memory numbers..... Page 128
- Using an optional MFC10 Foot Controller with the TYROS..... Page 148
- Using the Fade In/Out feature..... Page 109
- Using Song Position Markers to jump within a song and loop sections..... Page 44

Group performance tips and techniques

- Independently transposing the song and keyboard pitch to match your singing range Page 135
- Tuning the overall sound of the TYROS to match other instruments Page 150
- Synchronizing the TYROS to other MIDI instruments..... Page 146

Learning about MIDI

- About MIDI note events (playing the keyboard) Page 142
- About MIDI program changes (selecting voices) Page 142
- About MIDI events in songs, styles, and Multi Pads Page 142

Connecting external equipment to the TYROS

- Connecting a set of optional speakers.....Page 160
- Connecting external audio equipment and effect units.....Page 19
- Connecting MIDI instruments and devices.....Page 143
- Connecting an optional MFC10 Foot Controller.....Page 148
- Connecting a computer via USB.....Page 58
- Connecting a separate TV monitor.....Page 151

Computer applications

- What you can do with MIDI using a computer and the TYROS.....Page 58
- Connecting a computer to the TYROS using a USB cable.....Page 58
- Using the Voice Editor software.....Page 58
- Using the File Utility software.....Page 58

Using disks — data storage options

- Installing an optional Hard Disk unit to the TYROS.....Page 162
- Formatting the optionally installed Hard Disk.....Page 157
- Formatting floppy disks.....Page 157
- Backing up your floppy disk (copying from one floppy disk to another).....Page 157

Other Tips

- Registering your name to the TYROS.....Page 158
- Importing a favorite picture for the Main display background.....Page 158
- Importing a favorite picture for the Song Lyrics background.....Page 90
- Importing custom icons for voice/style/song indications in the Open/Save display.....Page 70
- Displaying the bank select and program numbers in the Voice Selection screen
(Open/Save display for voices).....Page 156
- Specifying style playback chords from an external MIDI instrument.....Page 148

Panel Controls and Terminals

■ Top Panel & Connections

Music Rest

The TYROS is supplied with a music rest that can be attached to the instrument as shown.

Page 21

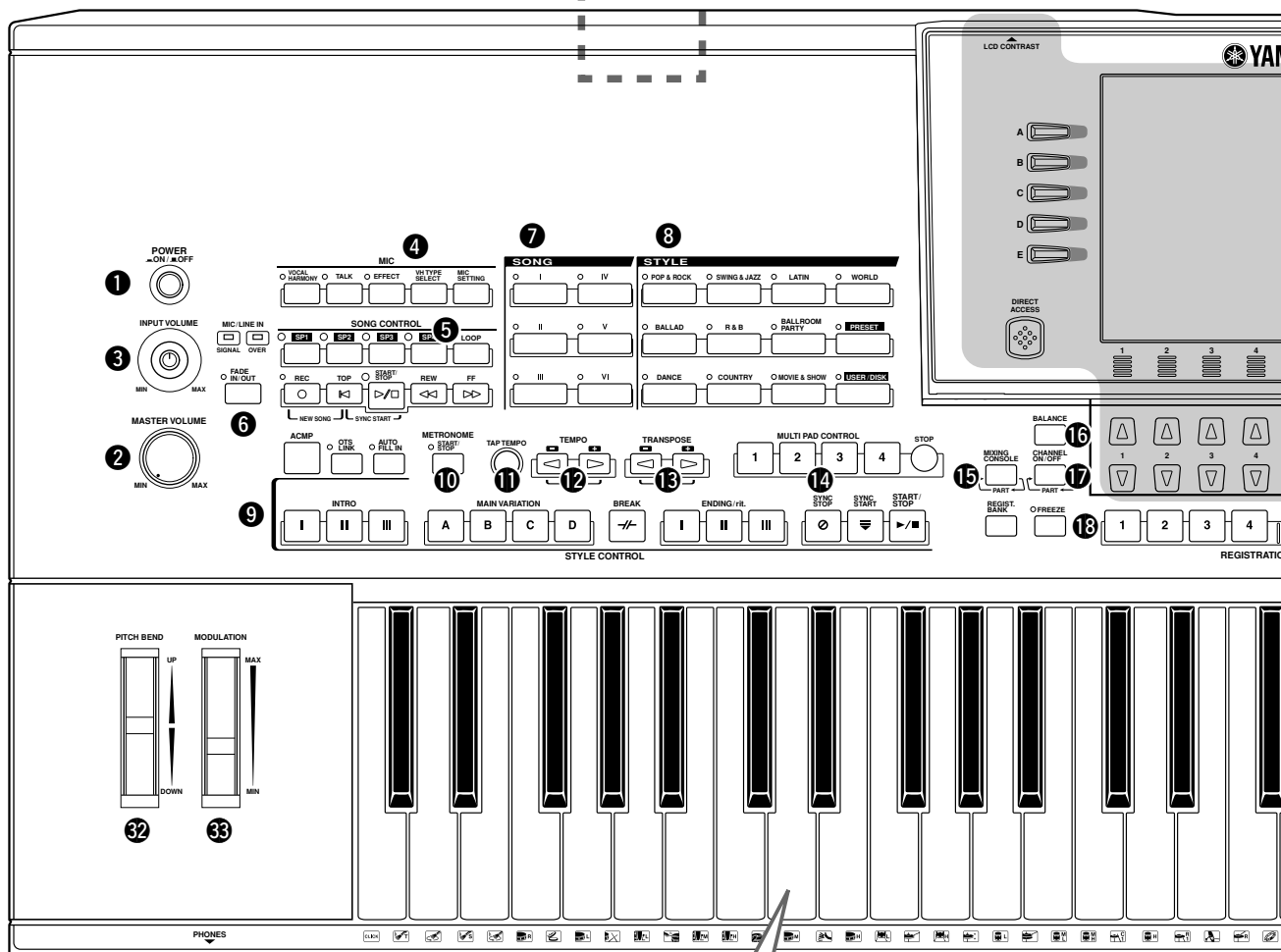
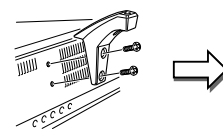

Keyboard

The keyboard of the TYROS is equipped with a touch response feature (initial touch and after touch) that lets you dynamically and expressively control the level of the voices with your playing strength – just as on an acoustic instrument.

Page 81

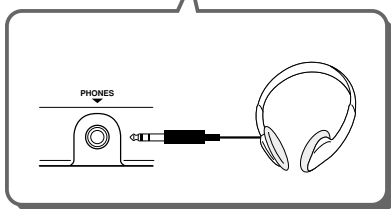

- ❶ POWER ON/OFF switch..... Pages 22, 24
- ❷ MASTER VOLUME control Page 22
- ❸ INPUT VOLUME control Pages 46, 130
- ❹ MIC buttons..... Pages 130
- ❺ SONG CONTROL buttons Page 43
- ❻ FADE IN/OUT buttons..... Page 109
- ❼ SONG buttons Pages 43, 72
- ❽ STYLE buttons..... Pages 32, 111
- ❾ STYLE CONTROL buttons Page 34
- ❿ METRONOME button..... Page 156
- ⓫ TAP button Page 109
- ⓬ TEMPO button..... Page 109
- ⓭ TRANSPOSE button Page 82
- ⓮ MULTI PAD buttons Pages 38, 124
- ⓯ MIXING CONSOLE button Page 134
- ⓰ BALANCE button..... Pages 36, 45
- ⓱ CHANNEL ON/OFF button..... Pages 37, 45
- ⓲ REGISTRATION MEMORY buttons Pages 51, 128

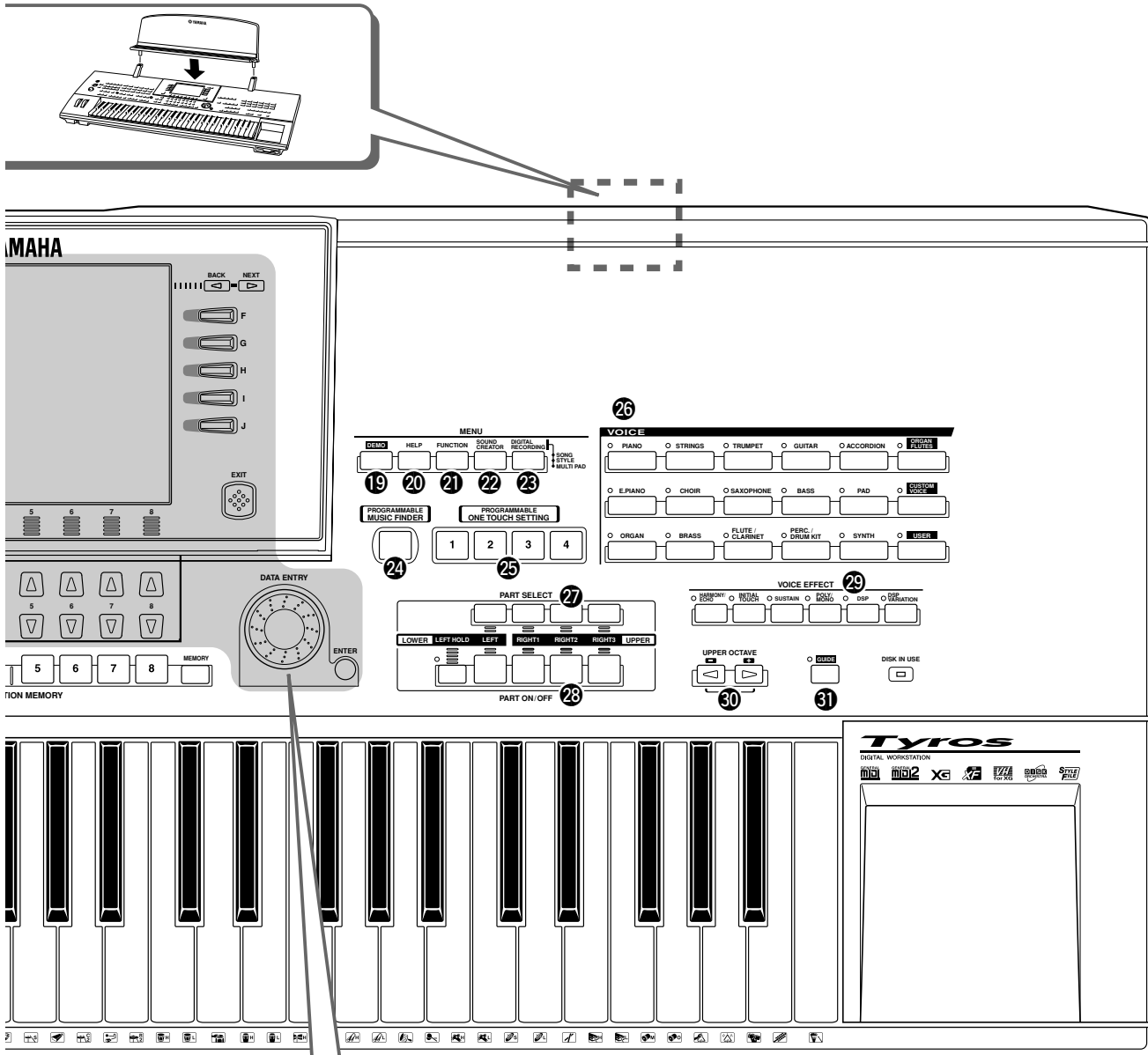

Liquid Crystal Display (LCD) and Related Buttons/Controls

- LCD contrast
- LCD (A-J) buttons
- LCD (1-8) up/down buttons
- DIRECT ACCESS button
- EXIT button
- DATA ENTRY dial
- ENTER button

Page 23, 60

Floppy Disk Drive **Page 6**

The TYROS also features a built-in disk drive that lets you save all your important original data to floppy disk for future recall. The TYROS is compatible with a wide variety of disk formats, allowing you to playback song data on commercially available XG, GM, DOC, and Disklavier Piano Soft disks.

19 DEMO button	Page 24	26 VOICE buttons.....	Pages 26, 79
20 HELP button	Page 61	27 PART SELECT buttons.....	Pages 26, 78
21 FUNCTION button	Page 150	28 PART ON/OFF buttons	Pages 26, 78
22 SOUND CREATOR button.....	Pages 29, 83, 85	29 VOICE EFFECT buttons.....	Pages 39, 81
23 DIGITAL RECORDING button	Pages 94, 116, 124	30 UPPER OCTAVE buttons	Page 28
24 PROGRAMMABLE MUSIC FINDER button.....	Pages 40, 126	31 GUIDE button	Page 48
25 PROGRAMMABLE ONE TOUCH SETTING buttons	Pages 36, 110	32 PITCH BEND wheel	Page 82
		33 MODULATION wheel	Page 82

■ Rear Panel & Connections

IMPORTANT

• Since the TYROS has no built-in speakers, you need to monitor its sound output via external audio equipment. Alternatively, you could use a pair of headphones.

CAUTION

• Make sure that the POWER switch is in the OFF (extended) position before making any connections. If you make connections while the POWER switch is on, you risk damaging external equipment such as the amp or speakers.

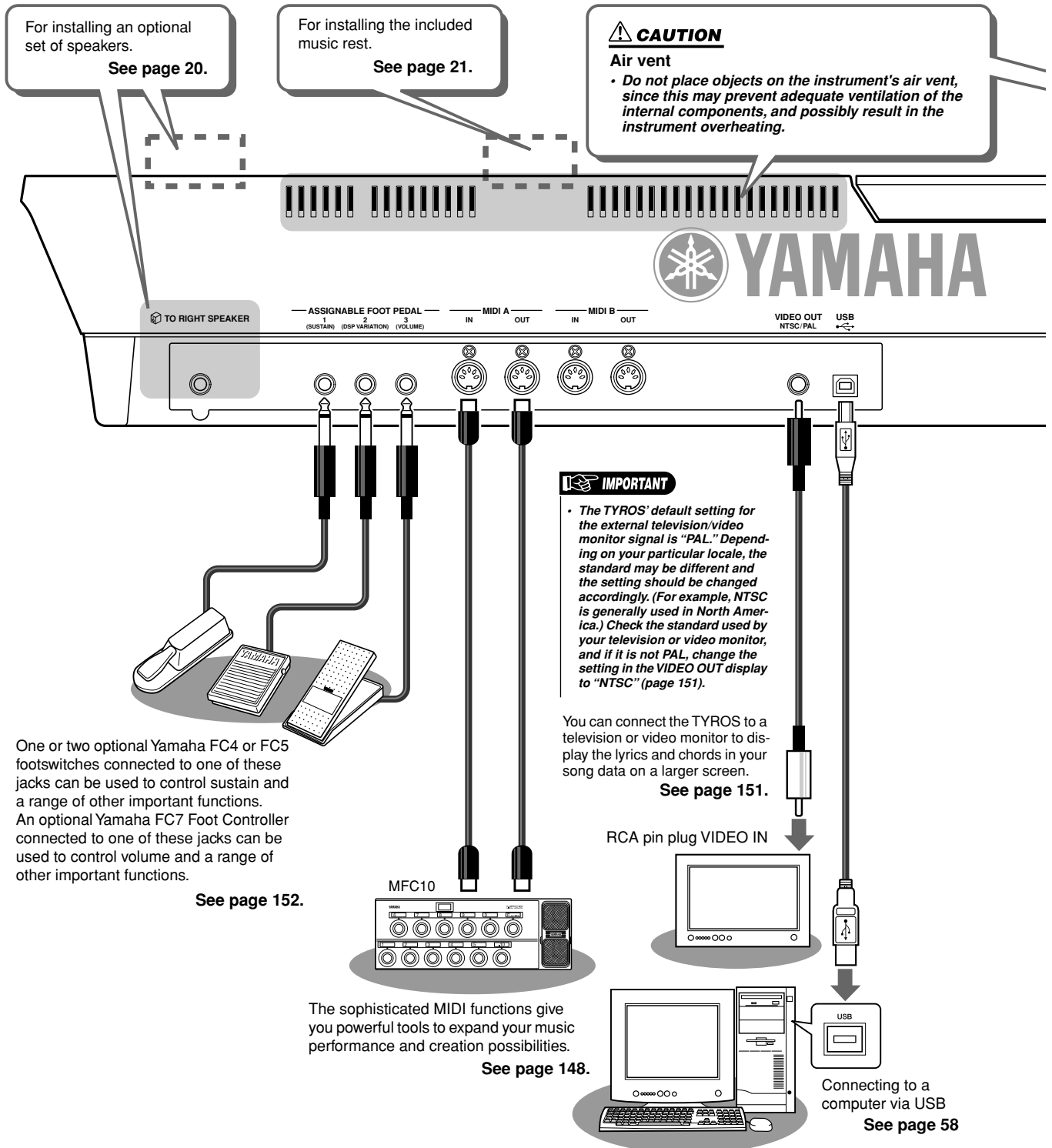

For installing an optional set of speakers.
See page 20.

For installing the included music rest.
See page 21.

CAUTION
Air vent
• Do not place objects on the instrument's air vent, since this may prevent adequate ventilation of the internal components, and possibly result in the instrument overheating.

IMPORTANT

• The TYROS' default setting for the external television/video monitor signal is "PAL." Depending on your particular locale, the standard may be different and the setting should be changed accordingly. (For example, NTSC is generally used in North America.) Check the standard used by your television or video monitor, and if it is not PAL, change the setting in the VIDEO OUT display to "NTSC" (page 151).

One or two optional Yamaha FC4 or FC5 footswitches connected to one of these jacks can be used to control sustain and a range of other important functions. An optional Yamaha FC7 Foot Controller connected to one of these jacks can be used to control volume and a range of other important functions.

See page 152.

You can connect the TYROS to a television or video monitor to display the lyrics and chords in your song data on a larger screen.
See page 151.

The sophisticated MIDI functions give you powerful tools to expand your music performance and creation possibilities.
See page 148.

Connecting to a computer via USB
See page 58

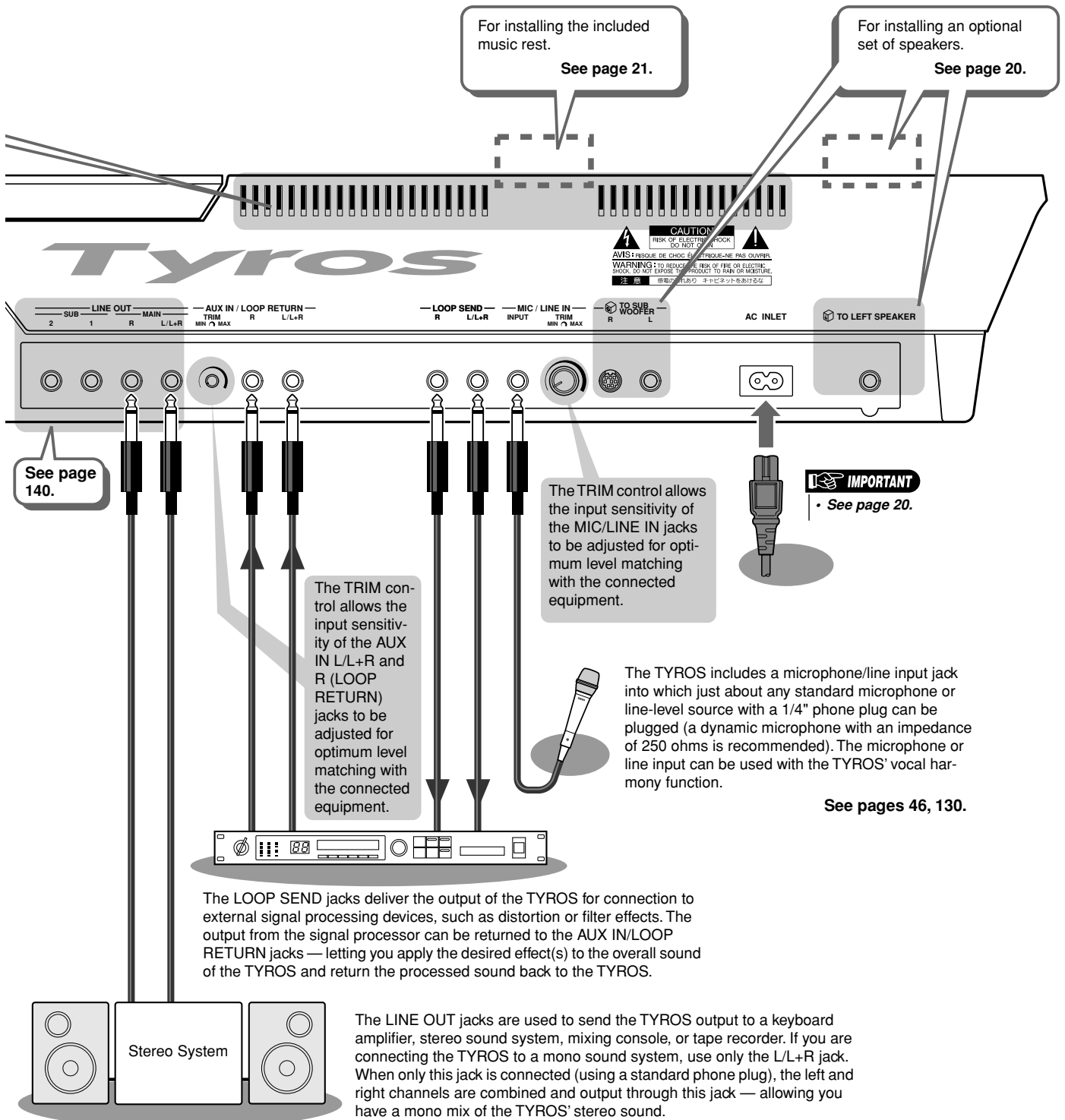

Starting Up

This section contains information about setting up your TYROS and preparing to play. Be sure to read through this section carefully before turning the power on.

Power Supply

- 1** Make sure the POWER ON/OFF switch on the TYROS is set to OFF.
- 2** Connect the supplied power cord to the AC INLET terminal on the instrument's rear panel.

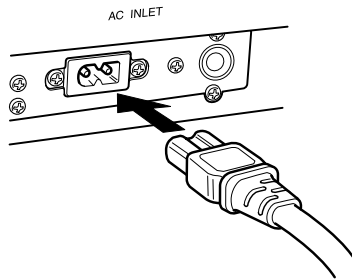

- 3** Connect the other end of the power cord to an AC outlet. Make sure your TYROS meets the voltage requirement for the country or region in which it is being used.

⚠ WARNING

- Make sure your TYROS is rated for the AC voltage supplied in the area in which it is to be used (as listed on the rear panel). Connecting the unit to the wrong AC supply can cause serious damage to the internal circuitry and may even pose a shock hazard!

⚠ WARNING

- Use only the AC power cord supplied with the TYROS. If the supplied cord is lost or damaged and needs to be replaced, contact your Yamaha dealer. The use of an inappropriate replacement can pose a fire and shock hazard!

⚠ WARNING

- The type of AC power cord provided with the TYROS may be different depending on the country in which it is purchased (a third prong may be provided for grounding purposes). Improper connection of the grounding conductor can create the risk of electrical shock. Do NOT modify the plug provided with the TYROS. If the plug will not fit the outlet, have a proper outlet installed by a qualified electrician. Do not use a plug adapter which defeats the grounding conductor.

Optional Speaker

Since the TYROS has no built-in speakers, you'll need to use an external speaker system — such as the optional TRS-MS01, which is designed specifically for the TYROS. For instructions on installing the TRS-MS01 to the TYROS, see page 160.

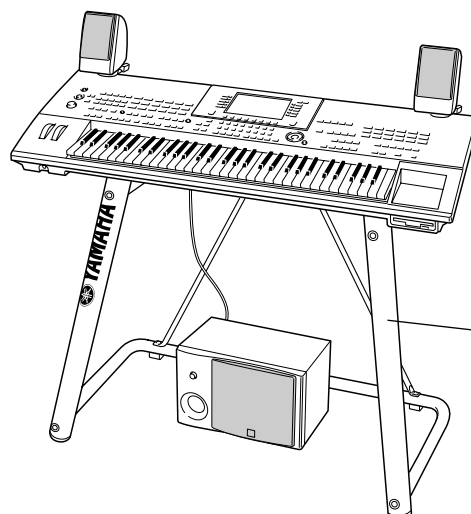

Shown here is the optional L-7S Keyboard Stand.

Music Rest

Check carefully that all parts (two music rest brackets and one music rest, shown below) are included before following the instructions below. You'll also need a Phillips screwdriver.

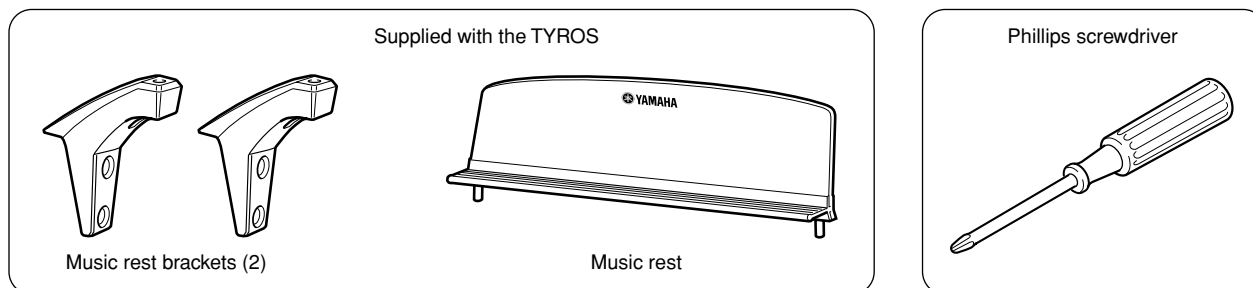

- 1** Remove the four screws from the rear panel of the TYROS with a Phillips screwdriver.

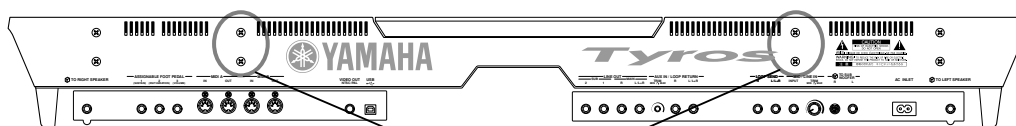

Screws for attaching the music rest brackets

- 2** Using the screws you removed in step #1 above, fasten the two music rest brackets to the rear panel of the TYROS.

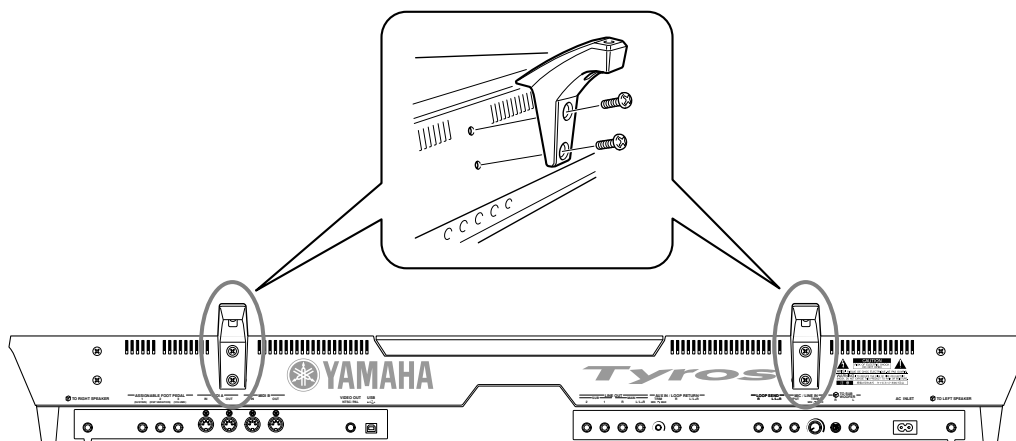

- 3** Attach the music rest to the brackets.

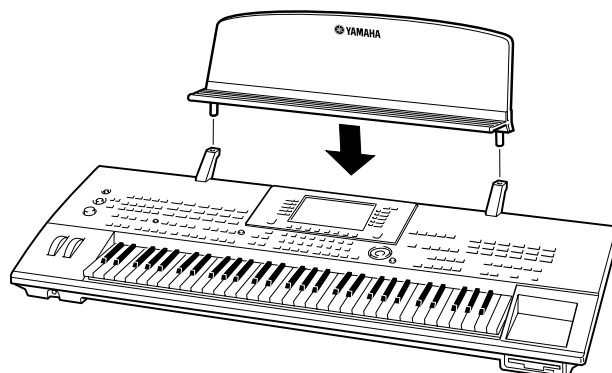

Turning the Power On/Off

Turning the Power On

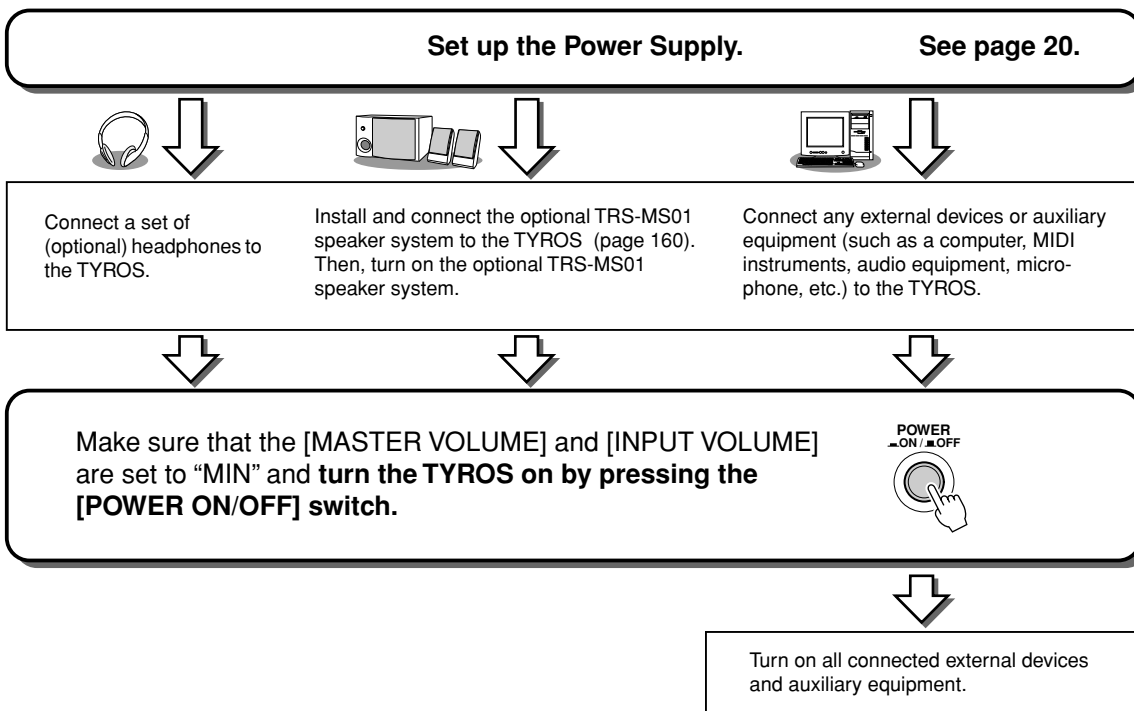

Turning the Power Off

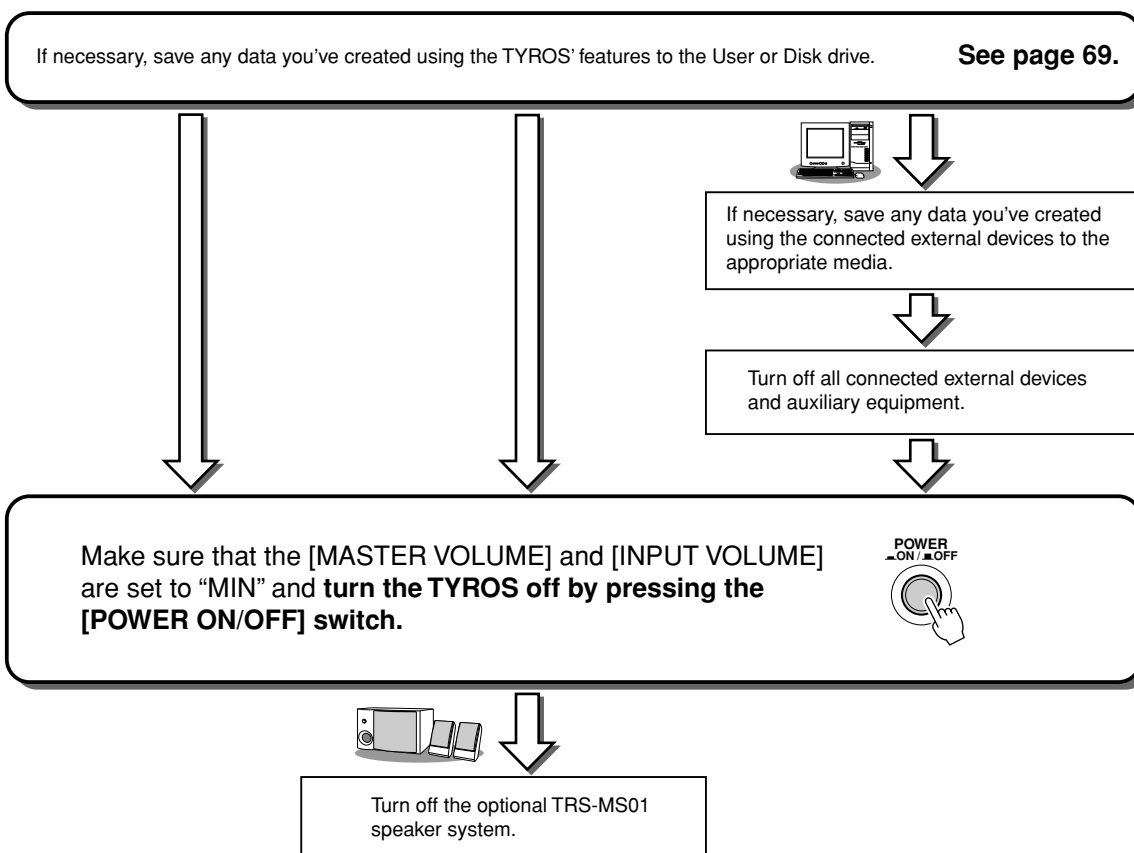

Raising and Closing the Display Panel

The TYROS features a semi-detachable display panel that can be tilted and adjusted — with four different latch points — to the most convenient viewing angle.

■ Raising the Display Panel.....

Unfasten the lock located at the back of the display panel. Then lift the panel and tilt it toward you.

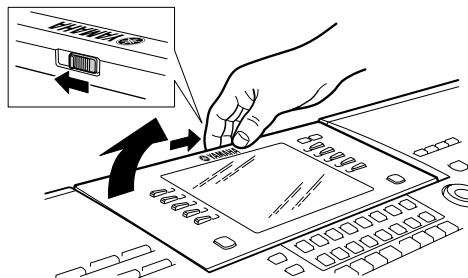

The panel will click as you tilt it back; these clicks are the four latched positions. Once you've reached a satisfactory position, release the panel. It will gently fall back to the nearest latched position.

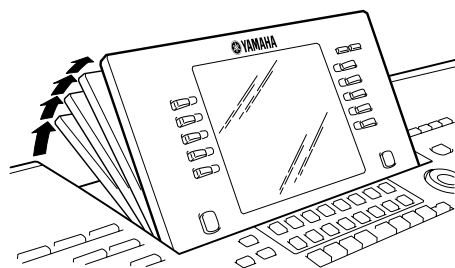

■ Closing the Display Panel.....

To return the panel to its closed and locked position, gently pull it back toward you until the position is vertical, then push it down until it locks into place.

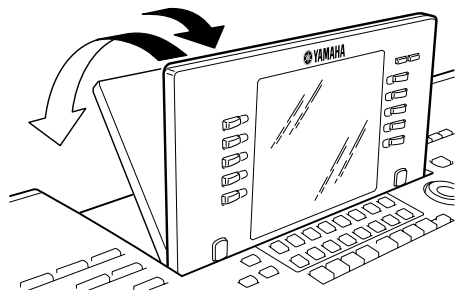

Setting the LCD contrast

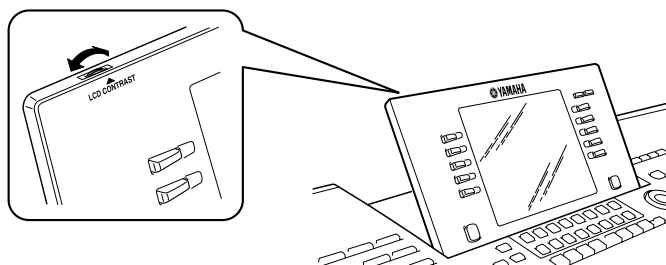

Quick Guide

Turning the Power On and Playing the Demos

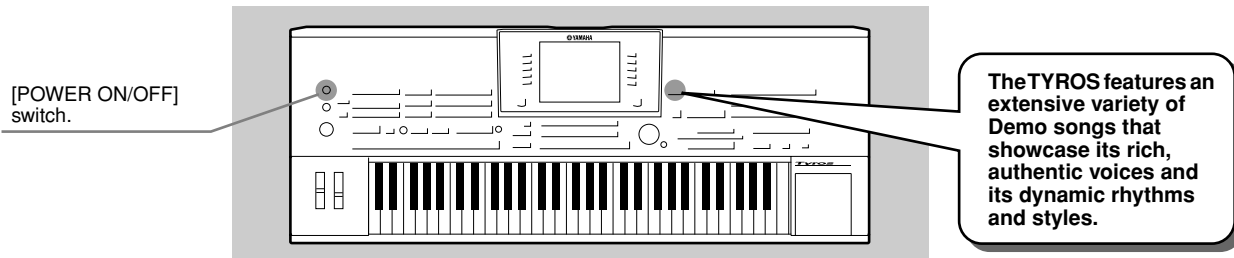

Turning the Power On and Viewing the Main Display

After setting up the instrument and making all necessary connections, turn the Power On by pressing the [POWER ON/OFF] switch (page 22).

An Opening “splash” display appears, followed by the Main display — which is the “home base” screen, showing the basic settings and important information for the instrument.

See below for details on each part of the Main display. Relevant page numbers for each are included.

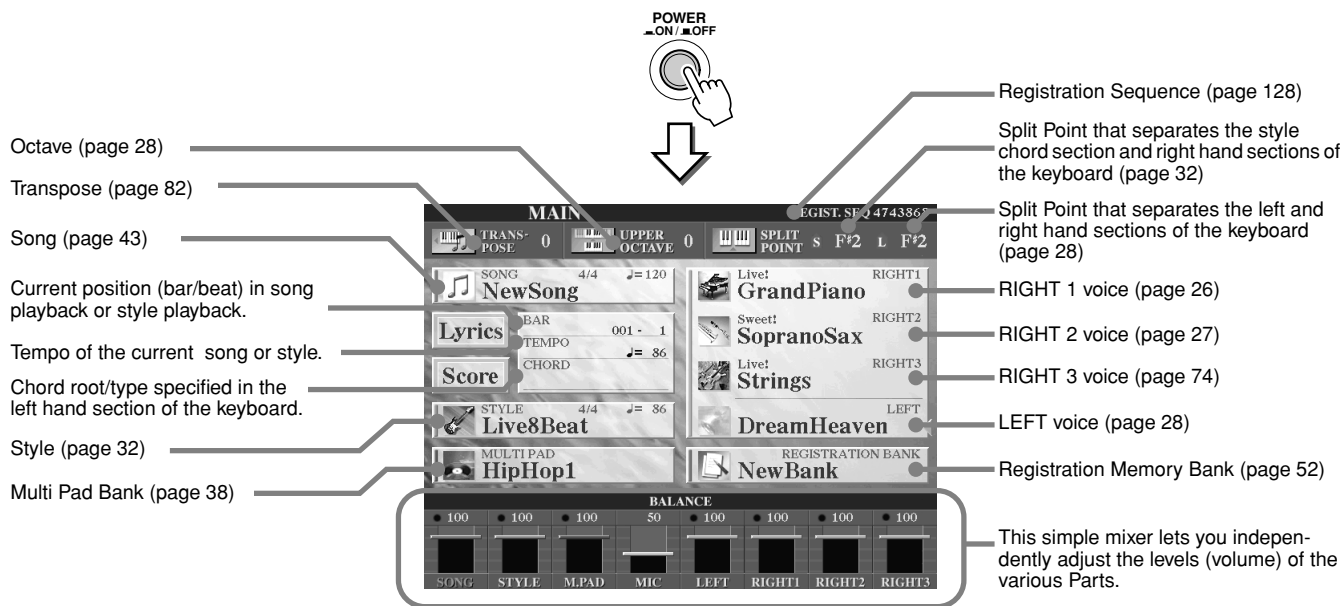

Playing the Demos

The Demos are more than just songs — they also provide helpful, easy-to-understand introductions to the features, functions and operations of the TYROS. In a way, the Demos are an interactive “mini-manual” complete with sound demonstrations and text explaining how to use the instrument and showing what it can do for you.

The TYROS can display text in any one of several languages. Text is used for the Demos (below), Help (page 61), and the Display Messages (page 62). Before playing the Demo, select the desired language by following the instructions below.

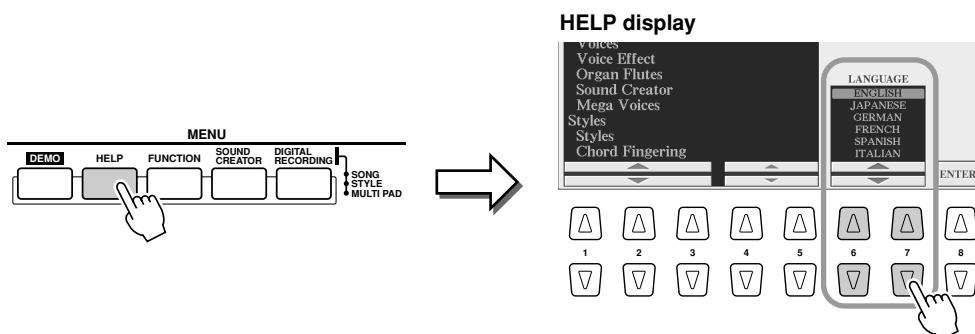

To call up the Demo display and start the Demo songs, press the [DEMO] button. To stop the Demo songs and return to the Main display, press the [EXIT] button. You may need to press the [EXIT] button several times depending on the display.

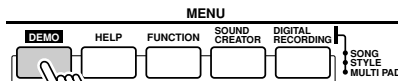

Press the [DEMO] button to start repeated playback of the Demo's "Overview" menu displays. To select specific Demo topics from these displays, follow the instructions below.

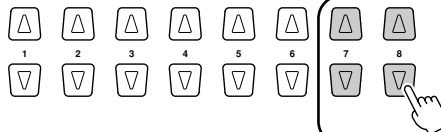
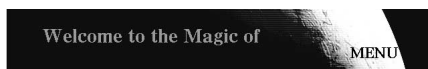

Even if you do not press any of these buttons, the demo song plays back repeatedly, calling up the various displays in sequence.

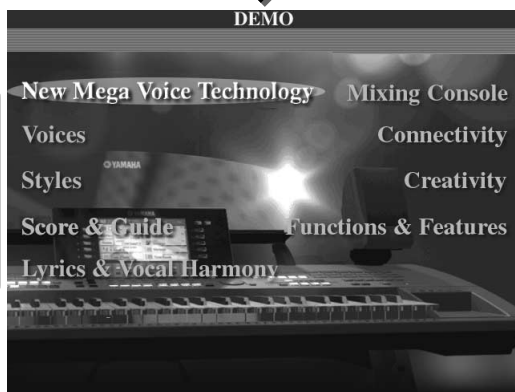

Press any of the LCD buttons to call up the display of the corresponding function.

- A
- B
- C
- D
- E

Press any of the LCD buttons to call up the display of the corresponding function.

- F
- G
- H
- I
- J



Select the desired numbered word or topic in the display by pressing the corresponding LCD button.

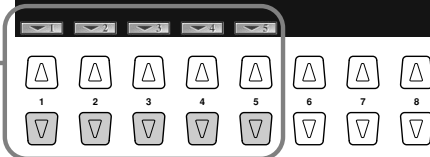

Depending on the particular display, you may need to use the [BACK]/[NEXT] buttons to call up other topics and menus.

Playing Voices

Reference on page 78 →

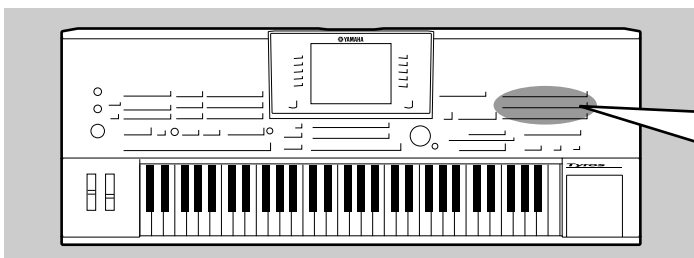

The TYROS has a huge selection of various musical instrument voices which you can play. Try out the different voices on your own — checking the voice name printed above each VOICE button on the panel, or referring to the voice list in the separate Data List booklet.

Selecting a Voice (RIGHT1) and playing the keyboard

▶ **1** Turn the RIGHT1 part on by pressing the [PART ON/OFF] button.

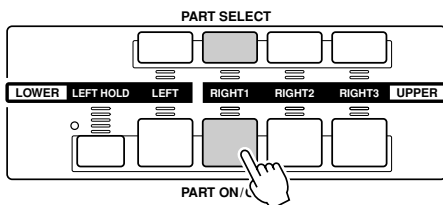

▶ **2** Press one of the [VOICE] buttons to call up the Voice selection display.

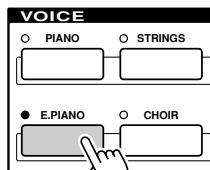

In this example, Galaxy EP is selected — one of the E.PIANO category voices.

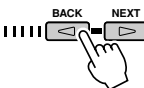

If necessary, use the [BACK]/[NEXT] buttons to call up the PRE-SET page.

NOTE

The voice selection display shown here is called the “Open/Save” display for the voice. The Open/Save display actually has two different display modes: 1) a direct selection display (shown at left), and 2) a numeric input display that lets you select the voice by inputting the voice number (file number in the folder). For details, see page 71.

▶ **3** Select a Voice.



For this example, JazzChorus is selected.

NOTE

The voice selected here is called voice RIGHT 1. See page 74 for more information on voice RIGHT1.

▶ **4** Play the selected voice.

Try it out!



Playing Two or Three Voices Simultaneously

- ▶ **1** Turn the RIGHT2 part on by pressing the [PART ON/OFF] button.

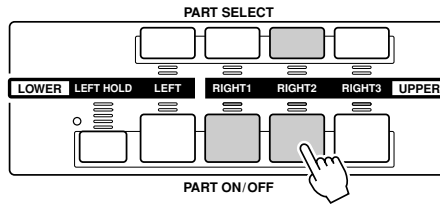

NOTE

- The voice selected here is called voice RIGHT 2. See page 74 for more information on voice RIGHT2.

- ▶ **2** Press one of the [VOICE] buttons to call up the Voice selection display.

Do this in the same way as you did in step #2 on page 26. In this step, press the [PAD] button.

- ▶ **3** Select a Voice.

Do this in the same way as you did in step #3 on page 26. In this step, select *Insomnia*.

- ▶ **4** Play the selected voices.

Try it out!

The voice selected for RIGHT1 (page 26) and the voice selected here are sounded simultaneously in a layer.

Voice RIGHT 3 can be set in the same way described above, by using the [RIGHT3] button instead.

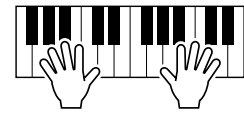

Try out some of these other voices...

Category	Voice Name	Comment
Piano	Live! GrandPiano	Stereo-sampled grand piano, with realistic sound over entire keyboard range.
E.Piano	Cool! Galaxy EP	Rich and dynamic DX-type Electric Piano.
	Cool! E.Piano	Four different samples with varying dynamics, for realistic and expressive timbre changes.
Organ	Cool! JazzOrgan	Organ sample with authentic chorus vibrato.
	Rotor Organ	Organ sample with realistic rotary speaker.
Accordion	Musette	Realistic, French type accordion.
	Sweet! Harmonica	Exceptionally natural harmonica sound with natural vibrato.
Guitar	Live! SteelGuitar	Stereo-sampled steel guitar, velocity switching according to dynamics and playing style.
	Cool! JazzGuitar	Dynamic, fingered jazz guitar.
	Lead Guitar	Soulful guitar sound with natural distortion.
Strings	Live! Strings	Rich, stereo-sampled strings orchestra.
	Live! Allegro	Rich, stereo-sampled strings orchestra with fast attack.
	Sweet! Violin	Excellent solo violin with natural vibrato.
Trumpet	Sweet! Trump	Expressive trumpet with natural vibrato.
	Sweet! MutedTrump	Jazzy muted trumpet with natural vibrato.
Brass	Live! HyperBrass	Stereo-sampled powerful brass section.
	Live! FrenchHorns	Stereo-sampled authentic orchestral French horn ensemble.
Saxophone	Sweet! AltoSax	Smooth alto sax with natural vibrato.
	Sweet! SopranoSax	Soprano sax with natural vibrato. Very expressive. Play long notes.
Flute/Clarinet	Sweet! Oboe	Realistic oboe with natural vibrato.
	Sweet! Flute	Flute with natural vibrato. Very expressive. Play strongly to get realistic overblown sample.
Choir	Sweet! PanFlute	Authentic pan flute with natural vibrato.
	Live! Gospel	Stereo choir with individual, smooth vibrato.
Synthesizer	DreamHeaven	Beautiful synth pad.
	Matrix	Expressive synth lead. Play long notes.
Percussion	Drums StandardKit	Stereo sampled drums with velocity switching of up to four layers. Also check out Live! Funk Kit.
	Drums BrushKit	Stereo sampled drums played by brush. Check out toms and cymbals.
	Live! SFX CubanKit/ Live! SFX PopLatinKit	Stereo sampled percussion with various playing styles.

Playing Different Voices with the Left and Right Hands

- ▶ **1** Turn the LEFT part on by pressing the appropriate [PART ON/OFF] button.

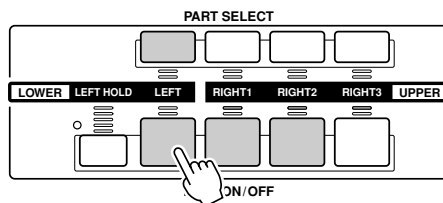

- ▶ **2** Press one of the [VOICE] buttons to call up the Voice selection display.

Do this in the same way as you did in step #2 on page 26. In this step, press the [BASS] button.

- ▶ **3** Select a Voice.

Do this in the same way as you did in step #3 on page 26. In this step, select FingerBass.

- ▶ **4** Play the selected voices.

Try it out!

The notes you play with your left hand sound one voice, while the notes you play with your right sound a different voice (or voices).

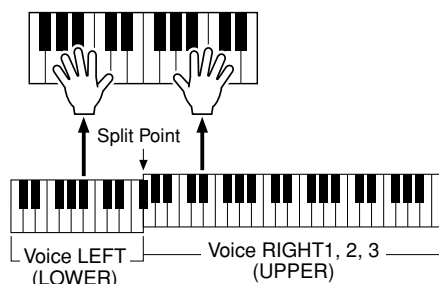

Voices RIGHT 1 - 3 are meant to be played with the right hand. Voice LEFT is played with the left hand.

NOTE

- The point on the keyboard that separates voice LEFT and voice RIGHT1 - 3 is called the "split point." Refer to page 112 for instructions on setting the split point.

Adjusting the Octave Setting

The [UPPER OCTAVE] button allows the RIGHT1, RIGHT2, and RIGHT3 parts to be simultaneously transposed up or down by one octave.

NOTE

- Press the [+] and [-] buttons simultaneously to instantly reset the octave value to 0.

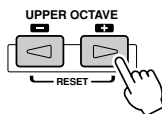

Organ Flutes

The TYROS uses advanced digital modeling technology to recreate the legendary sound of vintage organs. Just as on a traditional organ, you can create your own sound by increasing and decreasing the levels of the flute footages.

- ▶ **1** Press the [ORGAN FLUTES] button to call up the Organ Flutes voice selection display.

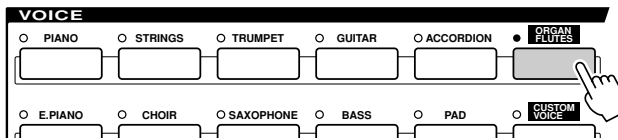

- ▶ **2** Select the desired Organ voice and play the keyboard. *Try it out!*

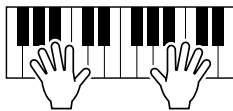

- ▶ **3** Press the [SOUND CREATOR] button to call up the display for adjusting various parameters of the Organ Flutes voice. Use the LCD [1] - [8] buttons to adjust the footage settings.

Use these to select the desired page of parameters.

CAUTION
If you wish to store the settings here, make sure to save the settings as a User Voice before selecting another voice or turning the power off.

Use LCD [D] button to adjust the 16' or 5 1/3' footage. You can select the desired footage (16' or 5 1/3') with the [E] LCD button.

The footage settings determine the basic sound of the organ flutes.
The term "footage" is a reference to the sound generation of traditional pipe organs, in which the sound is produced by pipes of different lengths (in feet).

- ▶ **4** Try out some of the other Organ Flutes voices.

Collecting your favorite voices to the User drive or floppy disk

The TYROS has a huge amount of high-quality voices, covering an exceptionally broad range of instrument sounds — making it perfect for virtually every musical application. However, the sheer number of voices may seem overwhelming at first. That’s why we’ve decided to show you this somewhat advanced technique for gathering together the voices you like to use the most, and putting them in one easy-to-use location.

To start with, you should know a little about the Memory Drives and the Open/Save display (explained briefly below). Should you want to know more, details are given on page 63. For the moment, though, keep in mind that the User drive and Floppy Disk drive are memory locations that you can use to store and recall your important data.

● Memory Drive Types

PRESET drive	Internal memory drive to which the preprogrammed voices are installed as preset voices.
USER drive	Internal memory that allows both reading and writing of data.
FD drive	For transferring data to and from floppy disk, with the TYROS’ floppy disk drive.

NOTE

• In addition to the three memory drive types described here, you can also use an optional hard disk drive (HD) — provided one is installed to the TYROS.

- **Open/Save display**..... From this type of display you can select (open) various files — such as voices, (pages 26 - 29), styles (page 32), songs (page 43), and Registration Memory banks (page 52) — as well as save the various files to the User drive or Disk drive.

▶ **1** Press the [USER] button to call up the Voice selection (Open/Save) display for the User drive.

In this case, any keyboard part (RIGHT 1 - 3) can be selected.

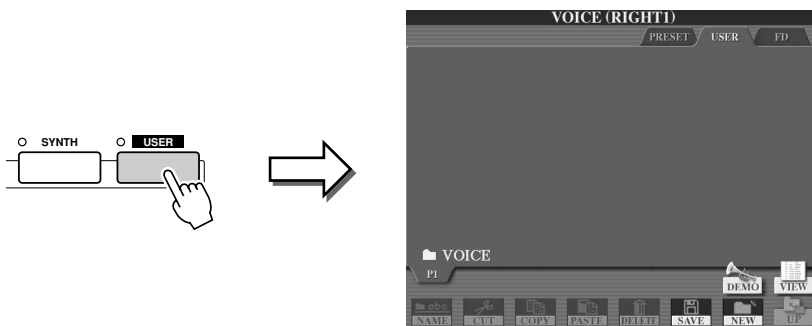

▶ **2** From this display (path), make a new folder to which your favorite voices are to be saved.

Press the [NEW] LCD button (lower [7] button).

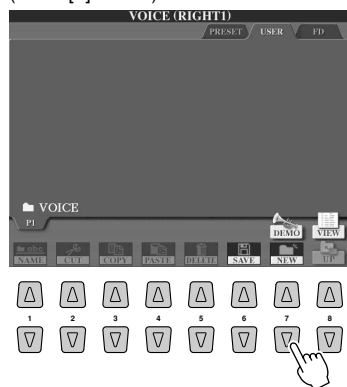

Press the [OK] LCD button (upper [8] button).

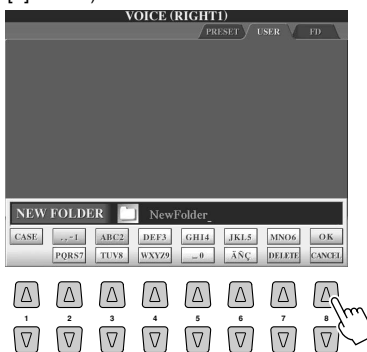

The new folder is created.

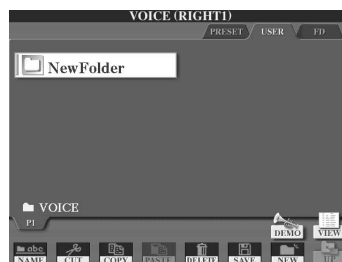

You can name the new folder from the pop-up window that appears at the bottom of the LCD display. For details about naming, see page 70).

▶ 3 Copy your favorite voices from the Preset drive to the User drive.

In this case, any keyboard part (RIGHT 1 - 3) can be selected.

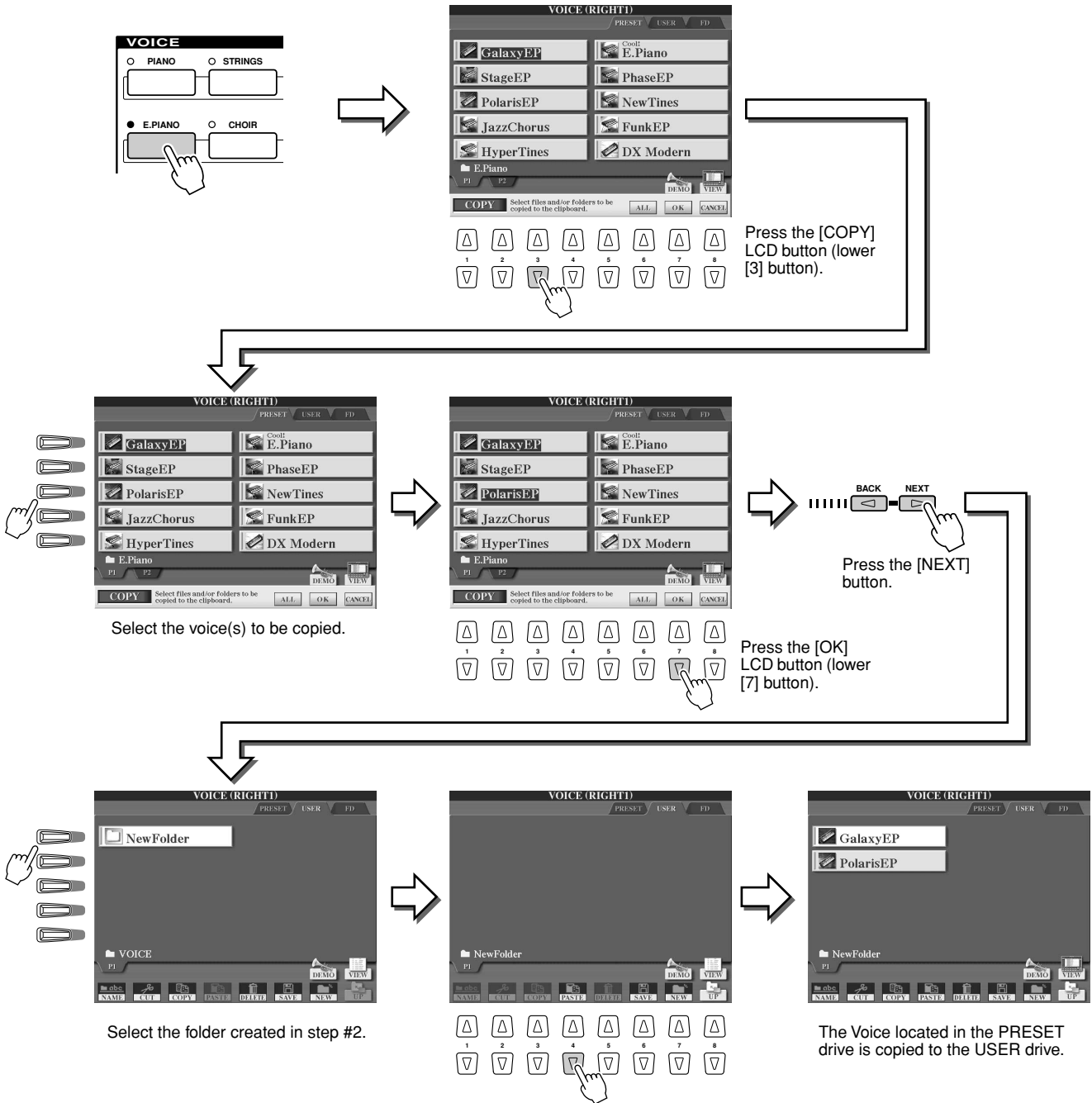

▶ 4 Repeat step #3 as often as necessary until all your favorite voices are contained in this display.

Also try copying preset voice(s) to floppy disk in the same way as explained here.



Selecting and Playing a Style — Auto Accompaniment (ACMP)

Reference on page 108 →

The auto accompaniment (style playback) feature puts a full backing band at your fingertips. To use it, all you have to do is play the chords with your left hand as you perform and the selected accompaniment style matching your music will automatically play along, instantly following the chords you play. With the auto accompaniment (style playback) function, even a solo performer can enjoy playing with the backing of an entire band or orchestra.

The TYROS features a variety of accompaniment styles (rhythm patterns) in a variety of different musical genres. Try out the different styles on your own — checking the style name printed above each STYLE button on the panel, or referring to the style list in the separate Data List booklet.

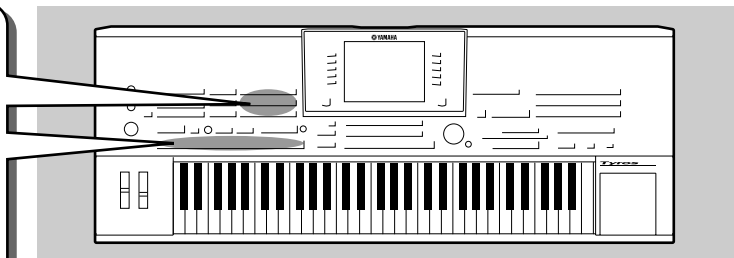

Playing a melody with your right hand and playing chords with your left hand

▶ **1** Press one of the [STYLE] buttons to call up the Style selection display.

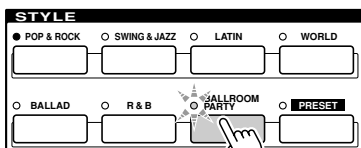

For this example, BALLROOM PARTY is selected.



NOTE

The style selection display shown here is called the “Open/Save” display for the style. The Open/Save display actually has two different display modes: 1) a direct selection display (shown at left), and 2) a numeric input display that lets you select the style by inputting the style number (file number in the folder). For details, see page 71.

▶ **2** Select a Style.



For this example, Swingfox is selected.

▶ **3** Turn Auto Accompaniment on.

Press the [ACMP] so that its indicator lights. The specified left-hand section of the keyboard becomes the Chord section, and chords played in this section are automatically detected and used as a basis for fully automatic accompaniment with the selected style.

Press the [ACMP] button again to turn Auto Accompaniment off.

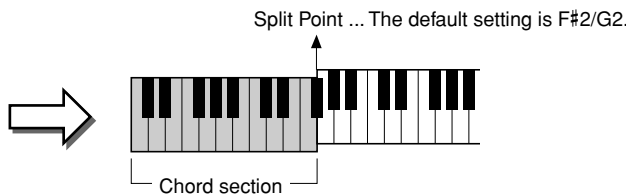
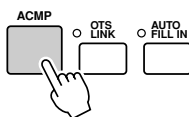

NOTE

ACMP is an abbreviation for ACCOMPANIMENT.

NOTE

For details about the Split Point, see pages 74 and 112.

▶ **4** Turn Sync Start on.

Press the [SYNC START] to enable synchronized start (standby). (The indicator lights.) Press the [SYNC START] button again to turn Sync Start off.

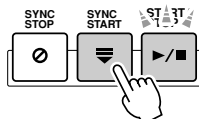

NOTE

The [START/STOP] button flashes in sync with the current tempo (page 109) while Sync Start is on.

▶ **5** As soon as you play a chord with your left hand, the selected style starts.

For this example, play a C major chord (as shown below).

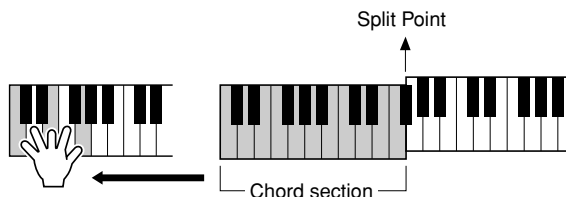

NOTE

- The [START/STOP] button flashes in sync with the beat. The red color flashes at the first beat and the green color flashes at the other beats.

▶ **6** Try playing other chords with your left hand and play a melody with your right hand.

Try it out!

For information on how to enter chords, see page 108 and the Chord Fingering Chart listed in the separate Data List booklet.

The chord root/type specified with your left hand will be shown at the center of the Main display.

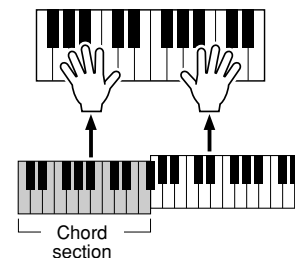

▶ **7** Press the [START/STOP] button to stop style playback.

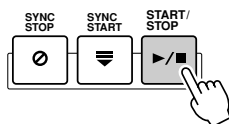

Try out some of the other styles...

Category	Style Name	Comment
Pop&Rock	Live8Beat	A modern 'live' sound field featuring the great new Mega-guitars — if you want to sound like a real band, check this out!
	Unplugged 1	A popular recent trend has been to unplug the instruments and play them acoustically. Listen to how accurately this sound is recreated — but don't unplug your TYROS!
Ballad	PowerBallad	A fantastic 'CD quality' sound field — listen to the amazing realism of the new strings in intro II.
	6-8SlowRock1	No one can resist the 50's — the music transcends the generations. Try intro III and reminisce!
	EasyBallad	Laid back and smooth, this style can be used for many of your favourite ballads. Intro III showcases the powerful new French Horn sound.
Dance	Ibiza2002	Using new drum, bass and synth voices, this vibe is fresh from the sun-drenched island.
Swing&Jazz	BigBandFast1	Sparkling new sounds are used to revive the Golden Age of the big band. Swing along with this style and enjoy complete control over an entire big band.
	Dixieland1	Close your eyes and listen to this traditional Dixieland style and you could almost be in New Orleans, the birthplace of Jazz. Try main D for the full Dixie band.
R&B	JazzFunk	A genre born in the late seventies, this style delivers all the typical jazzy rhythms and funky beats you would expect. Check out the new Mega-clean guitar with the brass and sax sections, it's hard to believe you are hearing a keyboard!
Country	ModCntryBlid1	Complete with the high-quality well-produced sound of modern country music, this style demonstrates yet another soundfield possible from the powerful TYROS tone generator.
Latin	BrazilianSamba	Super-realistic percussion samples bring this Latin American style to life. Check out the rhythmical variations between Main A - D.
BallroomParty	PubPiano	Now you don't even have to leave the comfort of your own living room to enjoy a good old fashioned sing-along!
Movie&Show	MovieSwing	Everyone loves the movies and the soundtrack plays a major part in setting the mood. Intro III features the mix of strings and french horns so typical of filmscores.
World	Flamenco	A fiery Spanish dance. Listen to the fantastic new Mega-guitar — you may find it hard to believe you're listening to a keyboard!
	IrishDance	This authentic Celtic masterpiece comes complete with the complex and exciting rhythms associated with traditional Irish music.

■ **Stop Accompaniment function**

When auto accompaniment is turned on and Syncro Start is off, you can play chords in the left-hand (accompaniment) section of the keyboard with the style stopped, and still hear the accompaniment chord. In this condition — called "Stop Accompaniment" — any valid chord fingerings (page 108) are recognized and the chord root/type are shown in the LCD. Since the TYROS properly recognizes the chord, you can also use the Chord Match function (page 38) with the Multi Pads or the Harmony effect (page 39) without having to play back a style.

Pattern Variation (Sections)

The TYROS features a wide variety of style “sections” that allow you to vary the arrangement of the accompaniment to match the song you are playing. They are: Intro, Main, Fill-in, Break and Ending. By switching among them as you play, you can easily produce the dynamic elements of a professional-sounding arrangement in your performance.

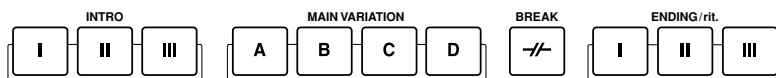

NOTE

• Depending the selected style, not all sections may have data. The lamp of the section button that contains data lights in green, and the lamp of the section button that contains no data does not light (page 73).

- **INTRO**.....This is used for the beginning of the song. When the intro finishes playing, style playback shifts to the main section. The length of the intro (in measures) differs depending on the selected style. The TYROS also features three different intros.
- **MAIN**.....This is used for playing the main part of the song. It plays a rhythm pattern of several measures, and repeats indefinitely until another section’s button is pressed. There are 4 variations on the basic pattern, A - D and the style playback sound changes harmonically based on the chords you play with your left hand.
- **FILL IN**.....The fill-in sections let you add dynamic variations and breaks in the rhythm of the accompaniment, to make your performance sound even more professional. Turn the [AUTO FILL IN] button on, simply press one of the MAIN (A, B, C, D) buttons as you play, and the selected fill-in section plays automatically (AUTO FILL), spicing up the auto accompaniment. When the fill-in is finished, it leads smoothly into the selected main section (A, B, C, D). There are four variations for the fill-in sections, each specially programmed to match the selected main section. Even when [AUTO FILL] is turned off, pressing the same button of the currently playing section automatically plays a fill-in before returning to the same main section.
- **BREAK**.....This lets you add dynamic breaks in the rhythm of the accompaniment, to make your performance sound even more professional.
- **ENDING**.....This is used for the ending of the song. When the ending is finished, the style playback stops automatically. The length of the ending (in measures) differs depending on the selected style. The TYROS features three different endings.

▶ **1-4** Select the desired style using the steps described on page 32.

▶ **5** Turn [AUTO FILL IN] on.

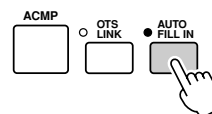

▶ **6** Press any of the [INTRO] buttons.

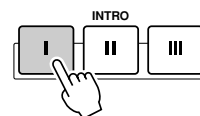

▶ **7** As soon as you play a chord with your left hand, the Intro of the selected style starts.

For this example, play a C major chord (as shown below).

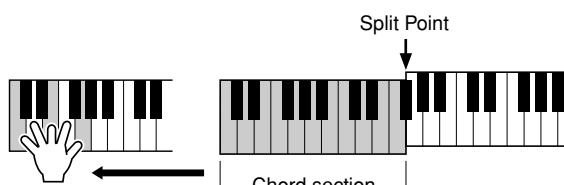

When the playback of the intro is finished, it automatically leads into the main section.

▶ **8** Press any of the accompaniment section buttons as desired. (See the Accompaniment Structure Diagram on the next page.) *Try it out!*

After the corresponding Fill-in is played back, it automatically leads to the main section.

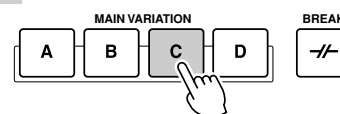

▶ **9** Press any of the [ENDING] buttons.

This switches to the ending section. When the ending is finished, style playback automatically stops.

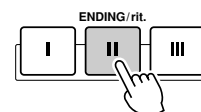

■ Accompaniment Structure Diagram

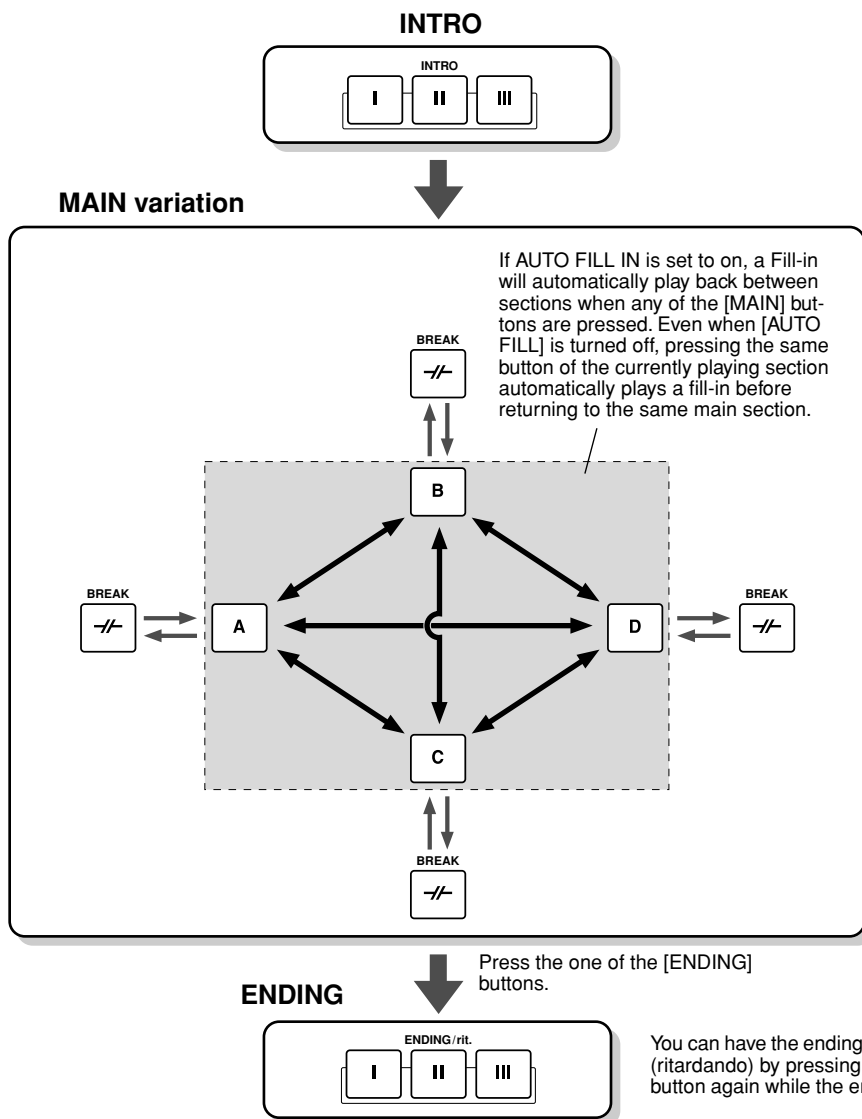

NOTE

- The section button lamps are conveniently color-coded as to their particular operation, as described below.
 - **Off**
The section contains no data and cannot be played.
 - **Green**
The section contains data and can be played.
 - **Red**
During style playback, this indicates the section that is currently playing. When style playback is stopped, this indicates the section that is set to play.
 - **Red (flashing)**
This indicates the section that will be played next, following the one whose button is lit up in red (not flashing).

NOTE

- The indicator of the destination section (MAIN A/B/C/D) will flash while the corresponding fill-in is playing. During this time you can change the destination section by pressing the appropriate MAIN [A], [B], [C] or [D] button.
- An Intro does not necessarily have to be at the beginning! If you want, you can play an Intro section in the middle of your performance by simply pressing the [INTRO] button at the desired point.
- Watch your timing with the Break sections. If you press a [BREAK] button too close to the end of the measure (i.e., after the final eighth note), the Break section starts playing from the next measure. This also applies to the Auto Fill-in.
- If you want to come back into the style right away after an Ending, simply press the [INTRO] button while the Ending section is playing.
- If you press one of the [MAIN] button while the ending is playing, a fill-in will immediately start playing (when the [AUTO FILL IN] is turned on), continuing with the main section.
- If you press the [SYNC START] button while a style is playing, style playback will stop and Syncro Start will be set to on.
- You can begin style playback by using an ending instead of an intro section.

■ Other Convenient Controls

- **Fade in/out**.....The [FADE IN/OUT] button can be used to produce smooth fade-ins and fade-outs when starting and stopping the accompaniment. This also applies to song playback. page 109



- **Tap**The auto accompaniment can be started at any tempo you desire by “tapping” out the tempo with the [TAP TEMPO] button. page 109



- **Syncro Stop**.....When the Syncro Stop function is engaged, accompaniment playback will stop completely when all keys in the auto-accompaniment section of the keyboard are released. Accompaniment playback will start again as soon as a chord or note is played. page 110



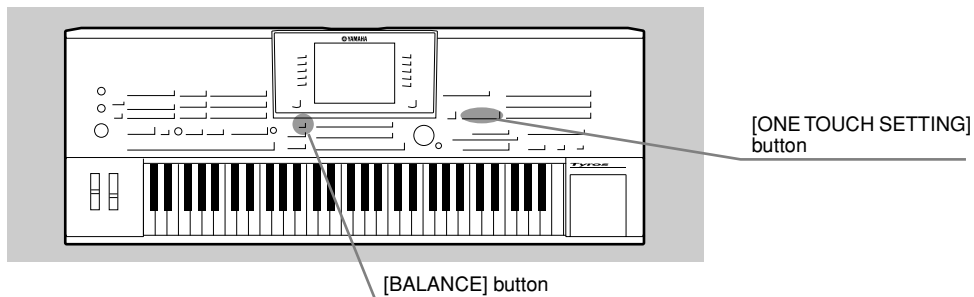

One Touch Setting

One Touch Setting is a powerful and convenient feature that automatically calls up the most appropriate panel settings (voice number, etc.) for the currently selected style, with the touch of a single button.

▶ **1** Select a style.

▶ **2** Press one of the [ONE TOUCH SETTING] buttons.

Auto Accompaniment and Sync Start will automatically be turned on.

In addition, various panel settings (such as voices, effects, etc.) that match the selected style can be instantly recalled with just a single button press.

▶ **3** As soon as you play a chord with your left hand, the style starts.

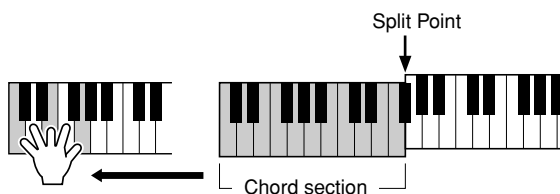
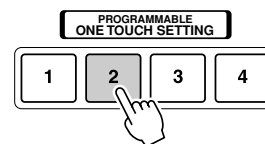

▶ **4** Try out other One Touch Setting setups. *Try it out!*

▶ **5** Stop style playback by pressing the STYLE [START/STOP] button or any of the [ENDING] buttons.

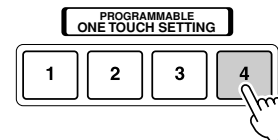

You can also create your own One Touch Setting setups. For details, refer to page 110.

Adjusting the Volume Balance between the Style and the Keyboard

Press the [BALANCE] button so that the mixer window (pop-up) appears at the bottom of the LCD display.

You can adjust the volume balance between style playback and your right-hand keyboard performance by using LCD buttons [2], [5], [6], [7], and [8].

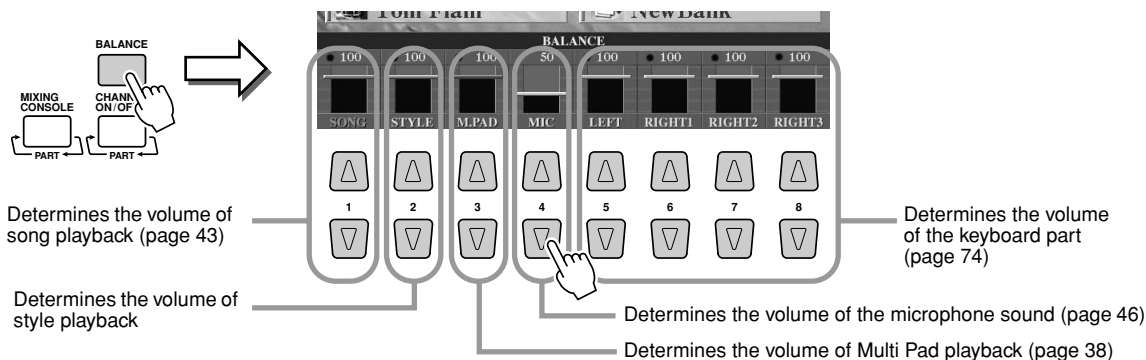

Turning Style Parts On/Off and Changing Voices

Press the [CHANNEL ON/OFF] button so that the pop-up window appears at the bottom of the LCD display. You can turn each part (channel) on or off by using the lower LCD [1] - [8] buttons during style playback. Pressing any of the upper LCD [1] - [8] button calls up the voice selection display which lets you select and change the voice of the corresponding part (channel). Try replacing the default voice with different voices of your own selection.

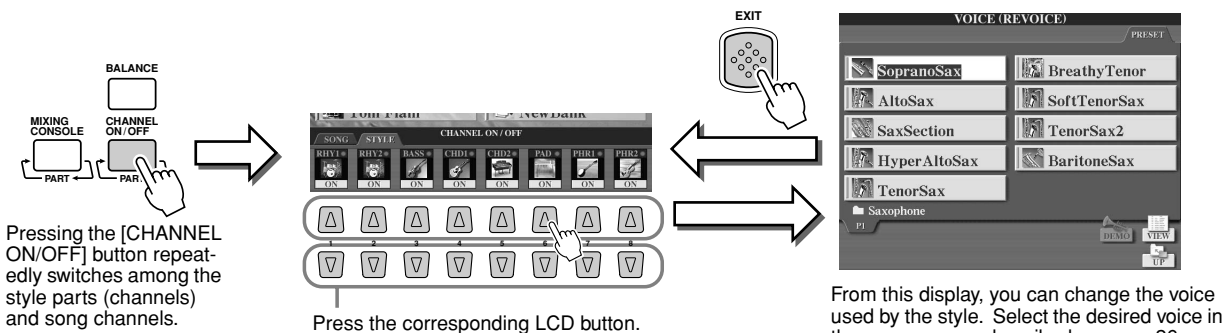

Playing Styles from Floppy Disks

The TYROS can play back style files contained on the floppy disk. Because the TYROS is compatible with the Style File format, the TYROS can directly play back style files contained on commercially available floppy disks bearing the Style File logo (page 8). The TYROS can also play back the disk style files created via various Yamaha keyboards such as the CVP-209/207/205/203/201, PSR-2000/1000, PSR-8000, PSR-9000, and 9000Pro.

- ▶ **1** Insert the floppy disk that contains the style file(s) into the floppy disk drive.
- ▶ **2** Press any of the STYLE buttons, then press the [NEXT] button to select the FD drive and display the files contained on the floppy disk.
- ▶ **3** Select and play the desired style (page 32).

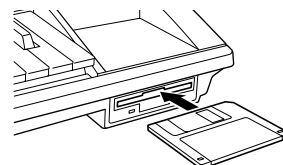

Try it out!

NOTE

• It may be necessary to wait for a while in step #3 until the TYROS can start the style, since it takes some time to read the style data from the floppy disk.

■ **Tip — Convenient way to select styles**

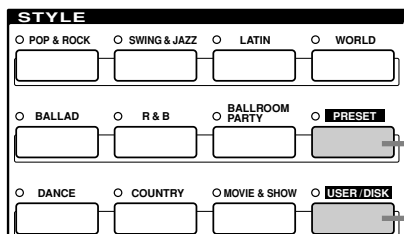

The explanations on page 32 apply when this button is turned on. When the [PRESET] button is on (and [USER] is off), press any of the named STYLE buttons to call up the preset style files for the corresponding category.

Page 111

When the [USER] button is on (and [PRESET] is off), press any of the named STYLE buttons to call up the root directory of the User drive.

Note: The root directory is the default setting. If you have installed an optional hard disk drive to the TYROS, you can assign each STYLE button to call up any specified folder on the drive.

Page 111

The Multi Pads

Reference on page 124 ➔

The Multi Pads can be used to play a number of short pre-recorded rhythmic and melodic sequences that can be used to add impact and variety to your keyboard performances.

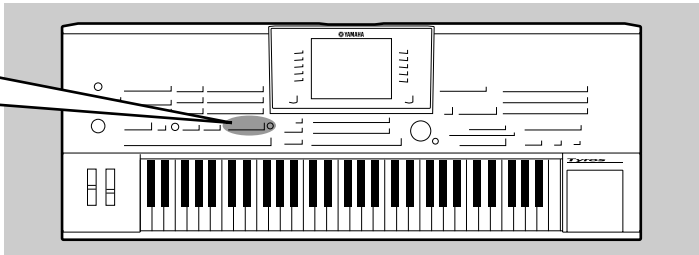
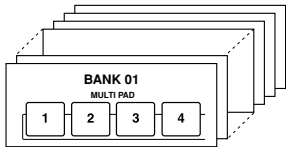

Playing the Multi Pads

1 Select a Multi Pad Bank.

Press the LCD [E] button to call up the Multi Pad Bank selection (Open/Save) display and select the desired Bank.

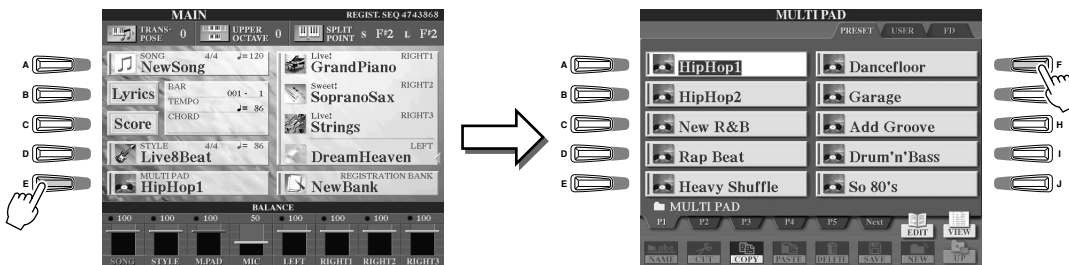

2 Press any of the Multi Pads.

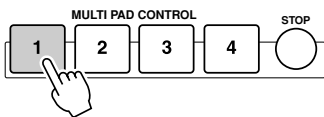

The corresponding phrase (in this case, for Pad 1) starts playing back in its entirety as soon as the pad is pressed. To stop it, press and release the [STOP] button.

NOTE

- Simply tap any of the Multi Pads at any time to play back the corresponding phrase at the currently set tempo.
- You can even play two, three, or four Multi Pads at the same time.
- Pressing the pad during its playback will stop playing and begin playing from the top again.

● About the color of the Multi Pads

- Green: Indicates that the corresponding pad contains data (phrase).
- Red: Indicates that the corresponding pad is playing back.

● Multi Pad data

There are two types of Multi Pad data. Some types will play back once and stop when they reach to the end.

Others will play back repeatedly until you press the [STOP] button.

● Stopping playback of the Multi Pads

- To stop all pads, press and release the [STOP] button.
- To stop specific pads, simultaneously hold down the [STOP] button and press the pad or pads you wish to stop.

Using Chord Match

Many of the Multi Pad phrases are melodic or chordal and you can have these phrases automatically change chords as you do with your left hand. While a style is playing back and [ACMP] is on, simply play a chord with your left hand and press any of the Multi Pads — Chord Match changes the pitch to match the chords you play. You can also use this with the style stopped (with the Stop Accompaniment function; page 33). Keep in mind that some Multi Pads are not affected by Chord Match.

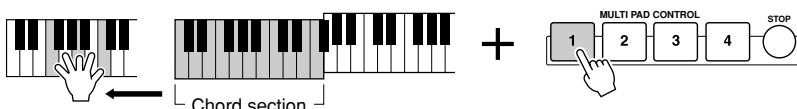

In this example, the phrase for Pad 2 will be transposed into F major before playing back. Try out other various chord types while playing the Multi Pads.

Voice Effects

Reference on pages 81, 154 ➔

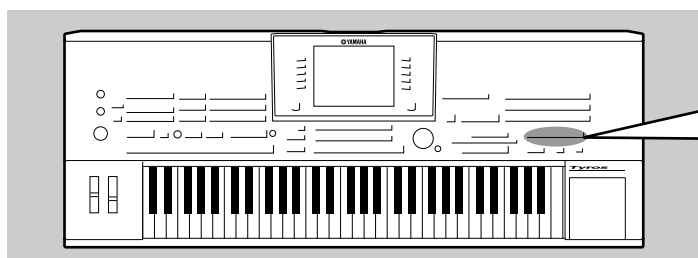

The TYROS features a sophisticated multi-processor effect system which can add extraordinary depth and expression to your sound. This effect system can be turned on or off by using the following buttons.

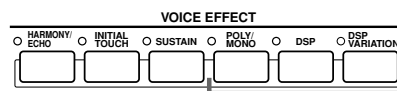

These three effect systems are applied to the currently selected keyboard part (RIGHT1, 2, 3, or LEFT).

- **HARMONY/ECHO** See below.
- **INITIAL TOUCH** This button turns the touch response of the keyboard on or off. When OFF, the same volume is produced no matter how strongly or softly you play the keyboard.
- **SUSTAIN** When this feature is ON, all notes played on the keyboard with the UPPER part (RIGHT1, 2, 3) have a longer sustain.
- **POLY/MONO** This determines whether the Part's Voice is played monophonically (only one note at a time) or polyphonically.
- **DSP** This button turns effects on or off independently for the RIGHT 1, RIGHT 2, RIGHT 3 and LEFT parts.
- **DSP VARIATION** This button can be used to switch between variations of the DSP effect. For example, this lets you change the rotating speed (slow/fast) of the rotary speaker effect.

Applying Harmony to Your Right-hand Melody

Among the Voice Effects, Harmony is one of the most impressive. It automatically adds harmony parts to the notes you play with your right hand — immediately giving you a more full and professional sound.

- ▶ **1** Turn the [Harmony/Echo] button on.
- ▶ **2** Turn on both the [ACMP] button and [SYNC START] button (page 32) and make sure that the RIGHT 1 part is on (page 26).
- ▶ **3** Play a chord with your left hand to start the style (page 33) and play some notes in the right-hand range of the keyboard.

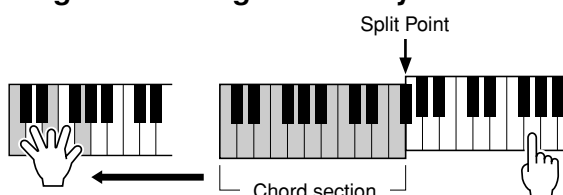

In this example, harmony notes in the scale of C major (the chord played in the left hand) are automatically added to the notes played in the right-hand range of the keyboard.

You can also use the Harmony effect with the style stopped (with the Stop Accompaniment function; page 33). Simply hold down a chord with your left hand and play a melody with your right.

Try out Harmony/Echo with some of the voices below...

Many of the voices have been automatically set to play certain Harmony/Echo types that match the particular voice. Try out some of the voices below — playing chords with your left hand and melodies with your right — and listen to the various Harmony and Echo effects.

Category	Voice	Harmony/Echo type	Category	Voice	Harmony/Echo type
Piano	Live! Grand	Standard Trio	Guitar	CrunchGtr	RockDuet
	Accordian	Tutti Accrd		PedalSteel	Country Duet
Strings	Live! Strs	Block	Saxophone	MoonLight	Full Chord
	ChamberStrs	4-way Open	Percussion	Vibraphone	Trill
	Harp	Strum		Timpani	Tremolo

Calling Up Ideal Setups for Your Music — Music Finder

Reference on page 126 →

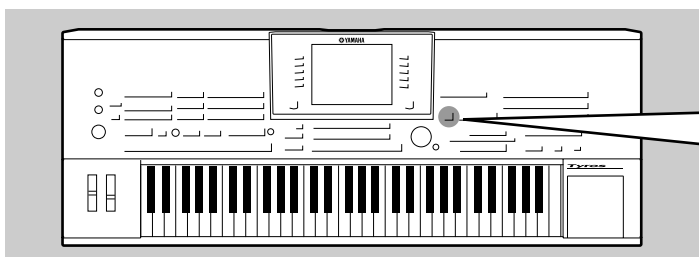

If you want to play in a certain genre of music but don't know which style and voice settings would be appropriate, the convenient Music Finder function can help you out. Simply select the desired music genre from among the "Records" that make up the Music Finder and the TYROS automatically makes all appropriate panel settings to let you play in that music style!

Selecting the desired music genre from the Record List

1 Press the [MUSIC FINDER] button to call up the Music Finder display.

The Music Finder display contains various "records" — each of which has pre-assigned panel settings to match the corresponding song title or music genre. Each record has the following four items.

- **MUSIC** Contains the song title or music genre that describes each record, letting you easily find the desired music style.
- **STYLE** The preset style assigned to the record.
- **BEAT** The time signature registered to each Record.
- **TEMPO** The assigned tempo setting for the record.

MUSIC	STYLE	BEAT	TEMPO
69 Summers Long	FusionShuffle	4/4	144
A Bossa Out Of Tune?	Country2-4	4/4	132
A Brand New Day Of A Wiza-	HipHopLight	4/4	120
A Bridge To Cross Troubled -	Caribbean	4/4	80
A Cozy Life In Italy	Fast8BShuffle	4/4	88
A Feeling Of Love Tonight	Caribbean	4/4	76
A Fire Lighter	60'sRock3	4/4	129
A Flowers Kiss?	Cool8Beat	3/4	158
A Greek Called Zorba	Live8Beat	4/4	86
A Jolly Good Fellow	JazzSamba	6/8	112
A Little Caribbean Love	CntryTwoStep	4/4	95
A March For Radetsky	PopLatin	4/4	110
A Nickel In The Nickelodeon	JazzWaltzSlow	4/4	200

If necessary, press the [BACK]/[NEXT] button to call up the "ALL" page. All the preset Records built into the TYROS are listed on this page.

2 Select the desired Record in the list.

Rotate the [DATA ENTRY] dial to move the cursor on the Record list. Once the desired song name or music genre is highlighted, press the [ENTER] button to call up the corresponding Music Finder setup. Keep in mind that the panel setup actually called up is the one pre-programmed as the One Touch Setting.

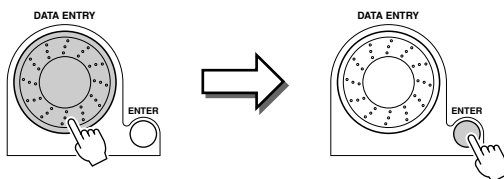

3 Play the styles.

Try it out!



Searching the Ideal Setups by Keyword

The Music Finder feature of the TYROS has a wide range of more than 1000 different records — making it exceptionally versatile, yet difficult to find a desired setup. That’s where the Search function comes in handy. It lets you quickly and easily find the records that you want to use.

- ▶ **1** Press the [SEARCH1] LCD button ([I] button) on the Music Finder display to call up the Search display.

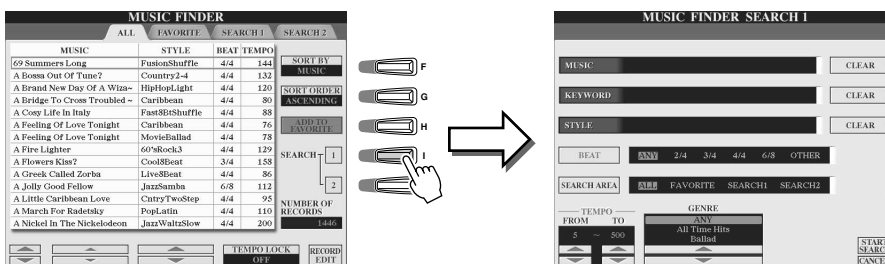

- ▶ **2** Enter the search criteria and start the search.

Press one of these buttons to call up the pop-up window for searching by music genre or keyword. Text entry is done in the same way as with file names (page 70). After entering the music genre or keyword, press the [OK] LCD button to return back to this display.

Press this button to call up the Style selection display. After selecting the desired style, press the [EXIT] button to return back to this display. This convenient function lets you find all songs that use a certain accompaniment style.

Press this button to specify the time signature for the search. Pressing the button alternates among the selections. Selecting “Any” searches through all records, regardless of the time signature.

Selects a specific location for searching. You can further narrow down your search by using the SEARCH 1 and 2 selections.

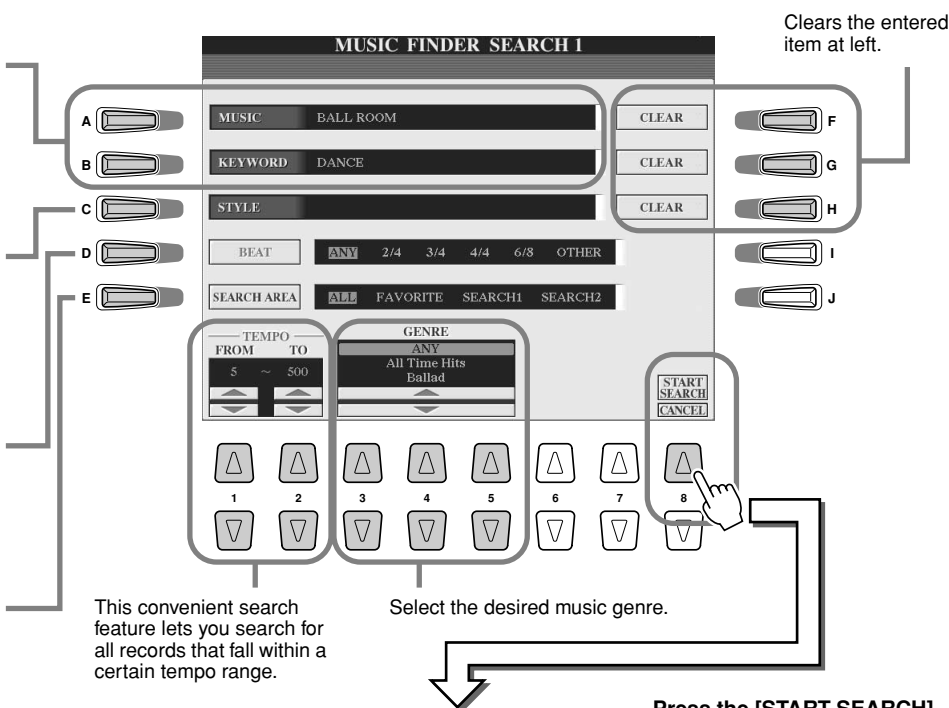

NOTE

- If you wish to further narrow down your search or search another music genre, use the SEARCH 2 display.

Press the [START SEARCH] LCD button to execute the search. The Search 1 display appears, showing the results of the search.

MUSIC	STYLE	BEAT	TEMPO	SEARCH BY
A Bossa Out Of Tune?	FusionShuffle	4/4	144	MUSIC
A Bossa Out Of Tune?	Country2-4	4/4	132	MUSIC
A Brand New Day Of A Wiza-	HipHopLight	4/4	120	MUSIC
A Bridge To Cross Troubled-	Caribbean	4/4	80	MUSIC
A Cozy Life In Italy	Fast8BShuffle	4/4	88	MUSIC
A Feeling Of Love Tonight	Caribbean	4/4	76	MUSIC
A Feeling Of Love Tonight	MovieBallad	4/4	78	MUSIC
A Fire Lighter	60sRock3	4/4	129	MUSIC
A Flowers Kiss?	CoolBeat	3/4	158	MUSIC
A Greek Called Zorba	Live8Beat	4/4	86	MUSIC
A Jolly Good Fellow	JazzSamba	6/8	112	MUSIC
A Little Caribbean Love	CrazyTwoStep	4/4	92	MUSIC
A March For Radetsky	PopLatin	4/4	110	MUSIC
A Nickel In The Nickelodeon	JazzWaltzSlow	4/4	200	MUSIC

- ▶ **3** Select the desired record from the list on the SEARCH1 display and play the music style.

Try it out!

Song Playback

Reference on page 88 →

You can play MIDI song data directly from the TYROS. This includes not only the preset demo songs, but also commercially available song data on floppy disk, as well as songs you've created with the Song Recording function (page 54) or Song Creator function (page 94). (For information on compatible song data, see page 8.)

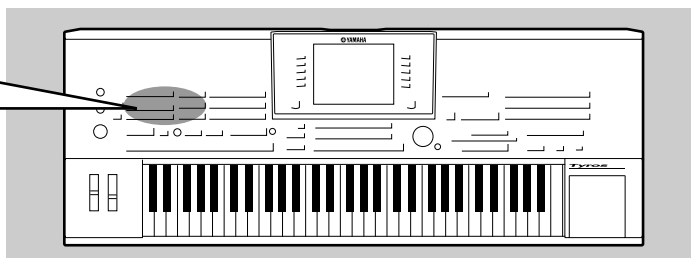

Playback of Song Disks

- ▶ **1** Insert the disk containing MIDI song data into the disk drive.

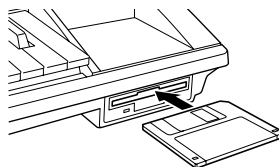

IMPORTANT

• Make sure to read the section "Using the Floppy Disk Drive (FDD) and Floppy Disks" on page 6.

- ▶ **2** Press any of the SONG buttons to call up the song selection display.

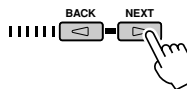
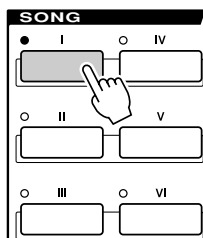

If necessary, use the [BACK]/[NEXT] buttons to call up the FD (Floppy Disk) page.

NOTE

• The song selection display shown here is called the "Open/Save" display for the song. The Open/Save display actually has two different display modes: 1) a direct selection display (shown at left), and 2) a numeric input display that lets you select the voice by inputting the song number. For details, see page 71.

- ▶ **3** Select a song on the floppy disk.

Selecting a song is done in the same way as selecting a voice or style.

- ▶ **4** Press the SONG CONTROL [START/STOP] button to start the selected song.

This button lets you record your keyboard performance as a song MIDI song data. **Page 54**

During playback, you can have the song return to the top and play back again from the beginning by pressing this button. When playback is stopped, pressing this button returns the song to the beginning.

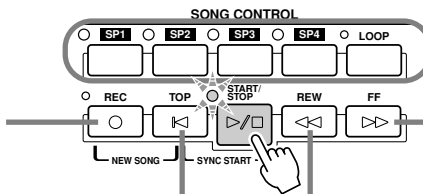

These buttons let you use markers in the song data — for easy navigation, and for setting up playback loops. **Page 44**

Moves forward one measure when pressed briefly, or scrolls forward continuously (fast forward) when held. Press this button to call up the SONG POSITION pop-up window on the LCD display.

Moves back one measure when pressed briefly, or scrolls backward continuously (fast reverse) when held. Press this button to call up the SONG POSITION pop-up window on the LCD display.

- ▶ **5** Press the SONG CONTROL [START/STOP] button again to stop the song.

■ Viewing Song Lyrics and Score

- When the song data contains lyric data, you can view it by using the [Lyrics] LCD button on the Main display. Page 46
- You can also view the song score (notation) by using the [Score] LCD button on the Main display. Page 49

Using Song Position Markers

Song Position markers (SP 1 - SP 4) can be placed in the song data. This not only lets you navigate quickly and easily through the song data, but also lets you set up convenient playback loops — allowing you to create dynamic song arrangements “on the fly,” as you perform.

■ Jumping among song positions.....

▶ 1 Select a song and start playing back from the top of the song.

Press the [TOP] button (if necessary) and press the [START/STOP] button.

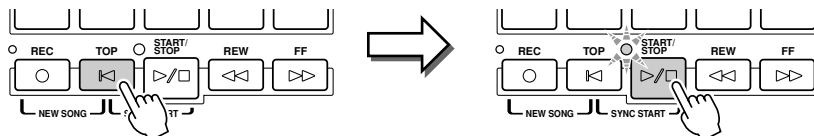

▶ 2 Enter a marker to the desired song position by double-clicking one of the [SP] buttons during playback.

As the song is playing back, double-click (press twice quickly) one of the [SP1] - [SP4] buttons at the point you wish you enter a marker. The corresponding button flashes in green, and the marker for that button is entered to the 1st beat of the appropriate measure.

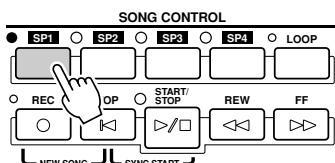

If a marker has already been entered to the button, the lamp is lit in green or red. Double-clicking on the button will set the marker to a new song position.

Continue to enter other markers in the same way. The illustration below shows an example of how all of the markers may be entered in a song.

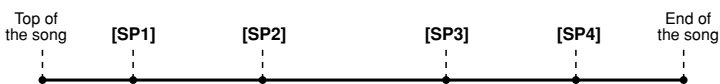

▶ 3 Stop song playback.

▶ 4 Now that you've entered markers in step #2 above, try using them to jump around in the song and navigate among the song positions. *Try it out!*

● Jumping to a marker, then starting playback

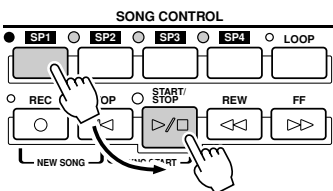

In this example, song playback starts from the top of the measure assigned to the [SP1] button (in step #2 above).

● Jumping to a marker during playback

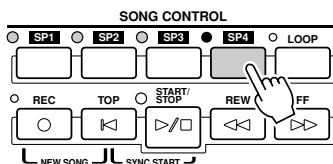

In this example, song playback continues to the end of the current measure, then jumps to the selected marker — the top of the measure assigned to the [SP4] button (in step #2 above). You can cancel the jump by pressing the same button ([SP4]) again before the actual jump. (Be careful not to double-click the button.)

▶ 5 Stop song playback.

■ Using markers in loop playback.....

Try using the markers you registered in step #2 above to play back the separate “sections” of the song in loops.

▶ 1 Go to the top of the song to which you've entered the markers and start it.

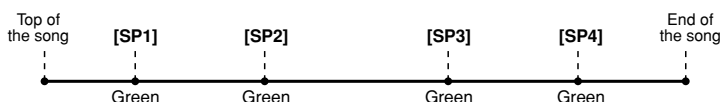

NOTE

- You also can enter the marker by stopping the song at the desired position and double-clicking any of the [SP1] - [SP4] buttons. Whether executed during playback or while playback is stopped, the marker is always entered at the top of the current measure.

CAUTION

- To store your marker settings, save the song data to the User drive, FD drive, or HD drive (if an optional hard disk has been installed). Keep in mind that the marker settings will be lost if you select another song or turn the power off without saving the song data. For details on saving song data, see step #8 on page 55.

NOTE

- Be careful to press the [SP1] - [SP4] button only once when jumping among markers. Pressing a button twice (double-clicking) will change the marker position.

The [SP1] button changes from green to red after the [SP1] point has played back.

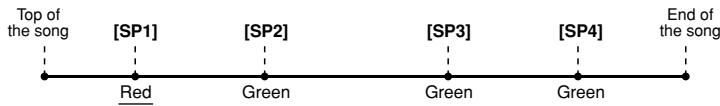

▶ **2 Turn the [LOOP] button on after passing the [SP1] point.**

The song plays back up to the [SP2] point, then goes back to [SP1] and loops between the two points (as shown).



▶ **3 Turn the [LOOP] button off by pressing it again.**

The loop in step #2 above continues indefinitely until you turn the [LOOP] button off. When you turn it off, playback continues past the [SP2] point and on to [SP3]. (The [SP2] button changes from green to red after the [SP2] point is passed.)

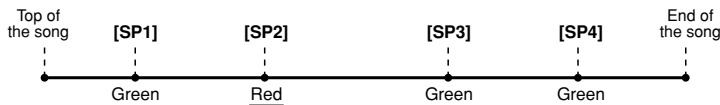

▶ **4 Turn the [LOOP] button on again before reaching the [SP3] point.**

Turning the [LOOP] button on again here starts a new loop — this time between the [SP2] and [SP3] points (as shown).



▶ **5 Continue looping the remaining “sections” of the song ([SP2]- [SP3] and [SP3] - end) in the same way, repeating steps #3 and #4 above.**

▶ **6 Stop song playback.**

Adjusting the Volume Balance between the Song and the Keyboard

Press the [BALANCE] button so that the mixer window (pop-up) appears at the bottom of the LCD display (page 36). You can adjust the volume balance between song playback and your right-hand keyboard performance by using LCD buttons [1], [5], [6], [7], and [8].

Turning Song Parts On/Off

Press the [CHANNEL ON/OFF] button so that the pop-up window appears at the bottom of the LCD display. You can turn each part (channel) on or off by using the lower LCD [1] - [8] buttons during song playback.

Pressing the [CHANNEL ON/OFF] button repeatedly switches among the style parts (channels) and song channels.

Press the LCD button corresponding to the part (channel) you wish to turn on or off.

SONG	STYLE	1	2	3	4	5	6	7	8
ON	ON	ON	ON	ON	ON	ON	ON	ON	ON
ON	ON	ON	ON	ON	ON	ON	ON	ON	ON

Singing with a Connected Microphone

Reference on page 130 →

The TYROS is equipped with an input jack, letting you connect another audio source — such as a microphone for your voice, an electric guitar, or a CD player — and mix it with the sounds of the TYROS. The fun doesn't stop there, however. With the Vocal Harmony feature (page 47), you can also apply various harmony and echo effects to your voice or guitar playing. Or use the TYROS for karaoke and sing-alongs — applying various DSP effects to your voice, as you sing with the auto accompaniment or song playback.

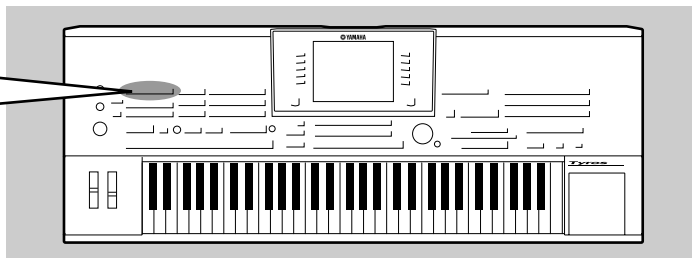

Connecting a microphone

- ▶ **1** Set the [TRIM] control on the rear panel and the [INPUT VOLUME] on the front panel both to “MIN.”

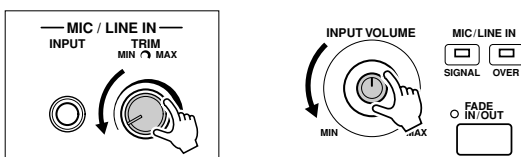

NOTE

- To avoid possible feedback or other interference, separate the microphone from the speakers as much as possible.

- ▶ **2** Connect a microphone to the MIC/LINE IN jack.

The MIC/LINE jack accepts 1/4” phone plugs.

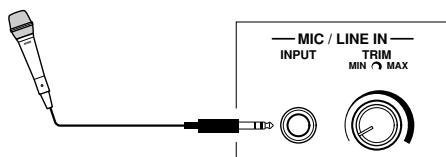

IMPORTANT

- Since the MIC/LINE IN jack is highly sensitive, it may pick up and produce noise when nothing is connected. To avoid this, always set the INPUT VOLUME to minimum when nothing is connected to the MIC/LINE IN jack.

- ▶ **3** Turn the power on.
- ▶ **4** Adjust the [TRIM] control on the rear panel and the [INPUT VOLUME] on the front panel while singing into the microphone.
 - Since the input level from the microphone may be low, set the [TRIM] control close to “MAX.”
 - Adjust the controls while checking the OVER and SIGNAL lamps.

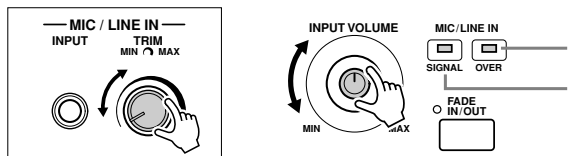

The OVER lamp lights when the input level is too high. Make sure to adjust the INPUT VOLUME so that this lamp does not light.

The SIGNAL lamp lights to indicate that an audio signal is being received.

NOTE

- Make sure to set the [INPUT VOLUME] to “MIN” before performing the following operations.
- Connecting a microphone to the TYROS
- Removing a microphone from the TYROS
- Turning the TYROS’ power off
- You may find that microphone sound is distorted, even though the OVER lamp is not lit. If so, try setting the [TRIM] control on the rear panel close to “MIN” and adjusting the [INPUT VOLUME] control on the front panel until the level is appropriate.
- Since the input level from the mixer or audio equipment may be high, set the [TRIM] control on the rear panel close to “MIN.”

Singing Along with Lyrics

Try playing a song that contains lyric data, then sing along with it using the connected microphone.

- ▶ **1** Select a song that contains lyric data (page 43).
- ▶ **2** Go back to the Main display by pressing the [EXIT] button and press the [Lyrics] LCD button to call up the Lyrics display.

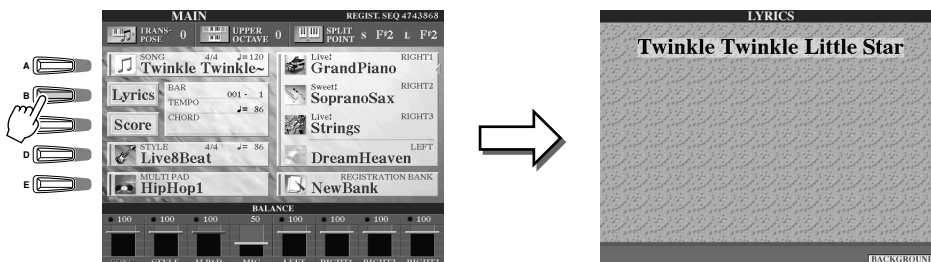

- ▶ **3** Turn the Effect for the microphone sound on, if desired.
- ▶ **4** Start song playback.
- ▶ **5** Sing the song while viewing the lyrics on the display.
- ▶ **6** Stop the song.

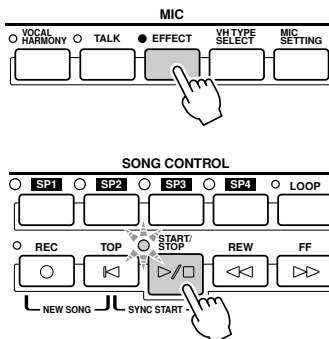

NOTE

The lyrics indicated on the LCD display can be output via the [VIDEO OUT] terminal. You can have only the lyrics of the song output via VIDEO OUT, even when another display is called up. This lets you select other displays and still have the lyrics shown on the monitor. For details, see page 151.

Applying harmony to your voice

Use the sophisticated Vocal Harmony function to automatically apply harmony to your voice as you sing into the connected microphone.

- ▶ **1** Turn Vocal Harmony on.
- ▶ **2** Press the [VH TYPE SELECT] button to call up the Vocal Harmony type selection display and select one of the types.

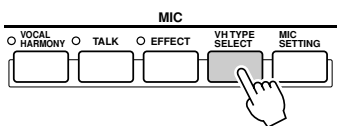
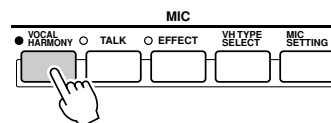

For this example, "JazzSisters" is selected.

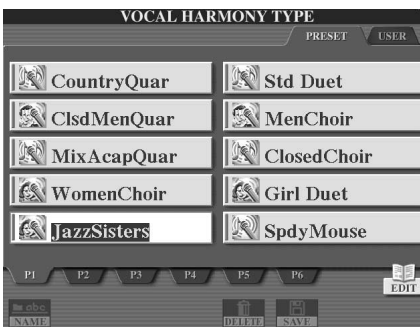
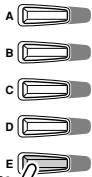

- ▶ **3** Turn the [ACMP] button on.
- ▶ **4** Play and hold down chords in the left-hand section of the keyboard as you sing along with the accompaniment.

Try it out!

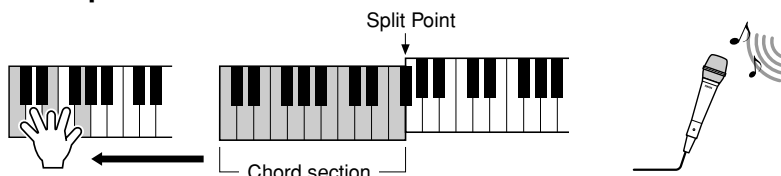

The harmony is applied to your voice according to the chord you play. Try out various chords.

NOTE

If you experience distorted or out-of-tune sound from the Vocal Harmony feature, your vocal microphone may be picking up extraneous sounds (other than your voice) – the Style playback sound from the TYROS, for example. In particular, bass sounds can cause mistracking of the Vocal Harmony feature. The solution to this problem is to ensure that as little extraneous sound as possible is picked up by your vocal microphone:

- Sing as closely to the microphone as possible.
- Use a uni-directional microphone.
- Turn down the MASTER VOLUME, STYLE volume or SONG volume control.

■ Vocal Harmony Chords

Vocal Harmony is triggered by the chords you play. In the example instructions above, the chords played in the style chord section of the keyboard are used to trigger the Vocal Harmony. Depending on the Harmony Mode setting and the particular application, different chords can be used to trigger Vocal Harmony (as listed below). For details, see page 133.

Chords that trigger Vocal Harmony	Required settings (Harmony mode)
Chords specified in the style chord section of the keyboard	CHORDAL
Chords specified in the Upper part (RIGHT1 - 3) section of the keyboard	VOCODER
Chords specified in the Lower part (LEFT) section of the keyboard	VOCODER
Chord data contained in the XF song	CHORDAL
Detected chords based on notes contained in the song data	CHORDAL, VOCODER

Keyboard and Vocal Practice using the Guide function

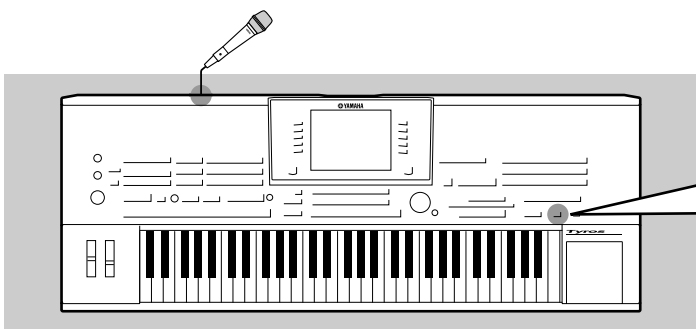

The educational and fun Guide features make it easy to learn new music. They indicate the notes you should play, when you should play them, and how long you should hold them down. What's more, with a connected microphone, the TYROS makes sing-alongs more fun and interesting as well. Here, you'll also learn how to practice music effectively using the Song Score function of the Guide features, reading the music score shown in the LCD.

Selecting a Guide menu

Call up the SONG SETTING display by following the procedure below and select a Guide menu.

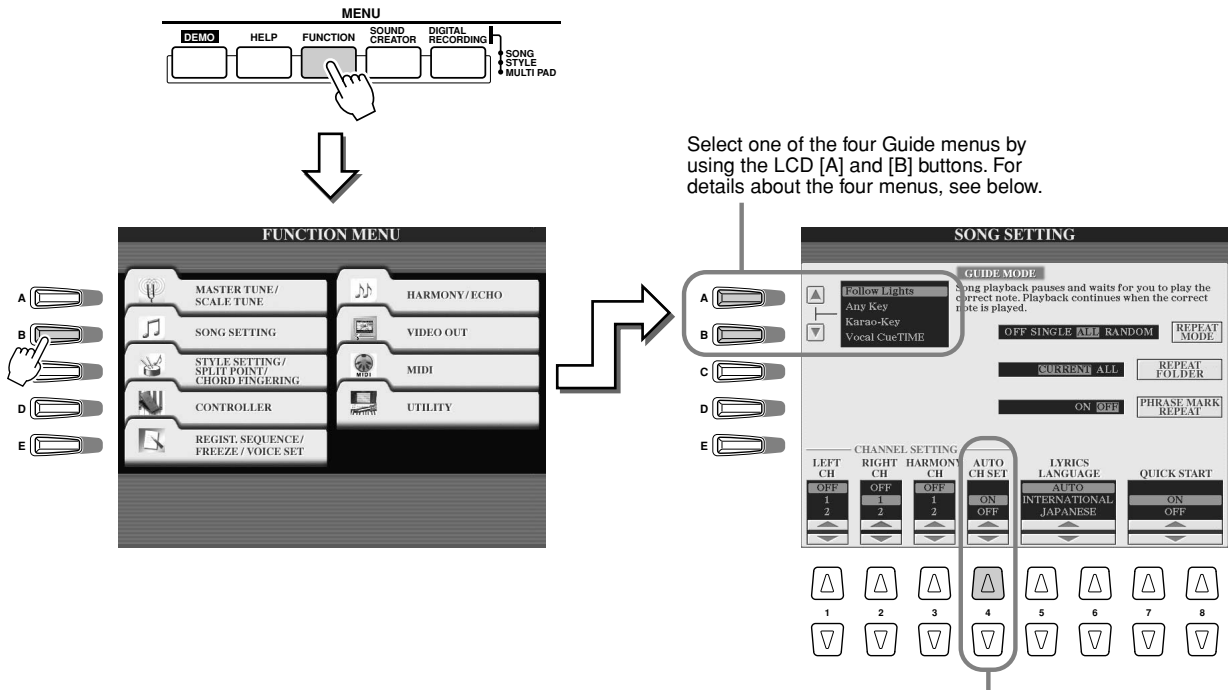

Select one of the four Guide menus by using the LCD [A] and [B] buttons. For details about the four menus, see below.

Since the commercially available song data may be already programmed with fixed channels for the Guide features, set this parameter to ON.

■ Guide menu for keyboard practice

- **Follow Lights**.....When this is selected, song playback pauses, waiting for you to play the notes correctly. When you play the correct notes, song playback continues. Follow Lights was developed for the Yamaha Clavinova series. This function is used for practicing purposes, with built-in lamps on the keyboard indicating the notes to be played. Even though the TYROS does not have these lamps, you can use the same function by following the indications in the displayed notation with the Song Score function.
- **Any Key**With this function, song playback pauses and waits for you to play any key. When you play the keyboard in correct time with the music (any key is fine), song playback continues. (For this function, the notes of the keyboard do not sound.)

■ Guide menu for sing-along

- **Karao-Key**.....This function lets you control the song and accompaniment playback with just one finger, while you sing along. Simply play a key on the keyboard in time with music (any key is fine) and the accompaniment parts of the song follow your playing. (For this function, the notes of the keyboard do not sound.)
- **Vocal Cue Time**With this function, song playback pauses, waiting for you to sing the notes correctly. When you sing the correct notes, song playback continues.

Keyboard Practice using "Follow Lights"

- ▶ **1** Select the desired song for practicing the keyboard (page 43).
- ▶ **2** Call up the SONG SETTING display by following the procedure described on the previous page and select "Follow Lights." If necessary, specify the channel settings.
- ▶ **3** Press the [EXIT] button to go back to the Main display.
- ▶ **4** Call up the Song Score display by pressing the [Score] LCD button ([C] button).

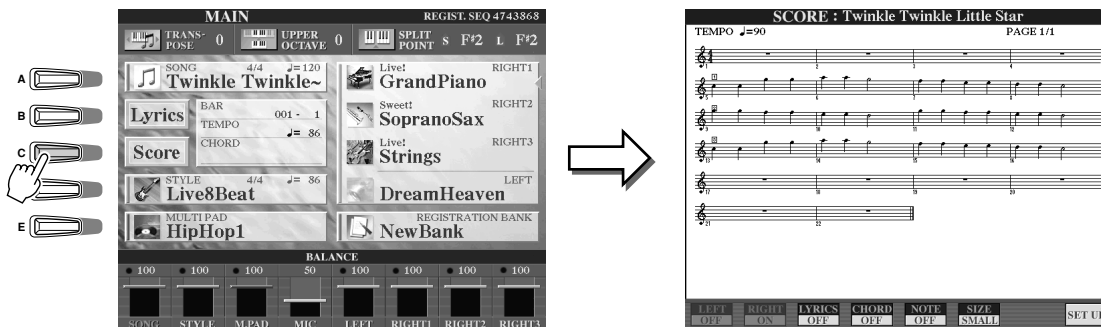

- ▶ **5** Turn the [GUIDE] button on.



- ▶ **6** Start the song playback.

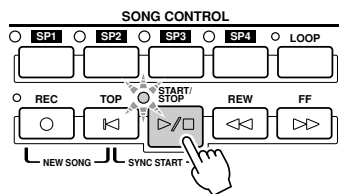

- ▶ **7** Song playback automatically pauses, indicating that you should play a certain melody note.

Try it out!

Look at the notation in the LCD to see which note to play.

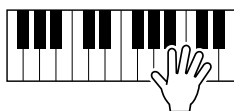

- ▶ **8** To stop the practice session in the middle of the song, stop song playback.

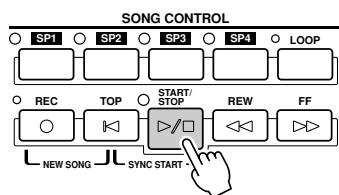

Vocal Practice using "Vocal Cue Time"

- ▶ **1** Connect a microphone to the TYROS (page 46).
- ▶ **2** Select the desired song for singing.
- ▶ **3** Call up the SONG SETTING display by following the procedure described on page 48 and select "Vocal Cue TIME." If necessary, specify the channel settings.
- ▶ **4** Press the [EXIT] button to go back to the Main display.
- ▶ **5** Call up the Song Score display by pressing the [Score] LCD button ([C] button).

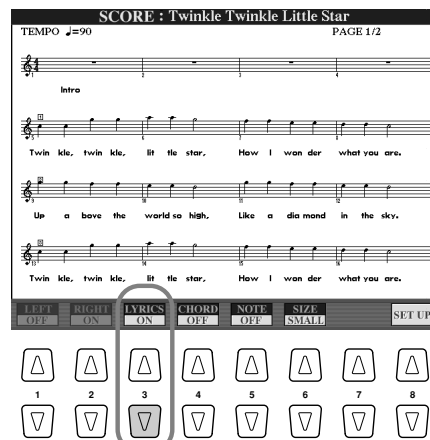
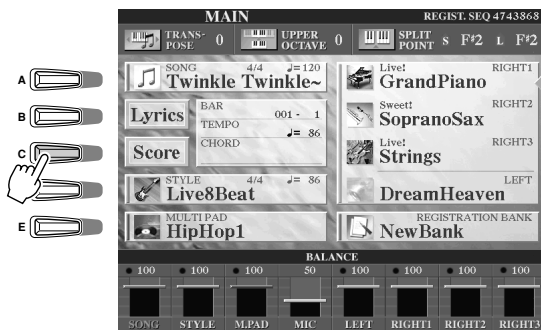

Press the lower LCD [3] button so that the lyrics appear on the score.

- ▶ **6** Turn the [GUIDE] button on.
- ▶ **7** Start song playback.

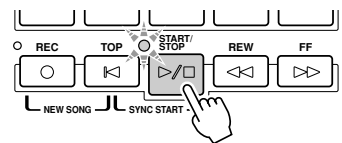

- ▶ **8** Song playback automatically pauses, indicating that you should sing a certain melody note. *Try it out!*
Look at the notation in the LCD to see which note to sing.
- ▶ **9** To stop the practice session in the middle of the song, stop song playback.

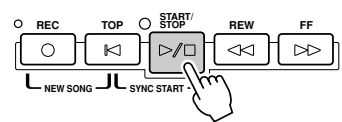
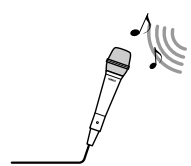

Saving and Recalling Custom Panel Setups — Registration Memory

Reference on page 128 →

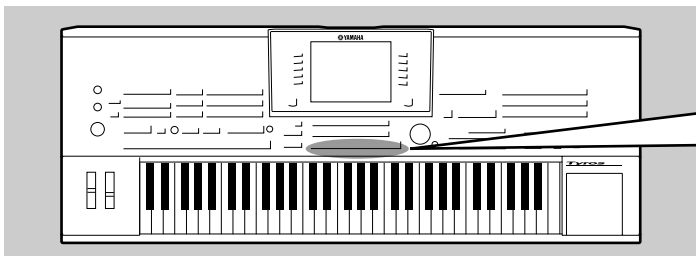

Since the TYROS is such a sophisticated instrument with such a variety of controls and functions — voice, style, and effect settings, just to name a few — it may be difficult to get a handle on them all. This is where the convenient Registration Memory can help. It allows you to save virtually all panel settings to a Registration Memory setting, and then instantly recall your custom panel settings by pressing a single button.

NOTE

• For a list of Registration Memory setup parameters, refer to the separate Data List.

Saving your Panel Setups to a Registration Memory

- ▶ **1** Set up the panel controls (such as voice, style, effects, and so on) as desired.
- ▶ **2** Press the [MEMORY] button in the REGISTRATION MEMORY section.

NOTE

• When a checkmark is entered to the SONG box, the current path (currently selected folder) of the song file can be memorized to Registration Memory. The path for DOC or Disklavier Piano Soft disks, however, cannot be memorized to Registration Memory. If you wish to memorize the path for DOC or Disklavier Piano Soft disks, copy the desired files to the User drive and memorize the corresponding User drive path.

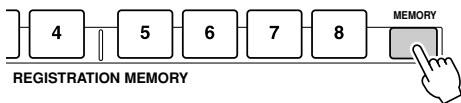

You can determine whether the settings are to be memorized (on) or not (off) for each parameter group. Enter checkmarks only to those parameter groups you want to be memorized.

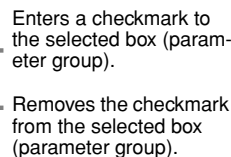
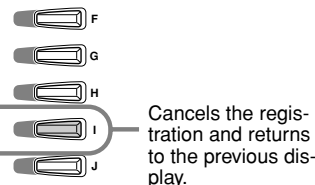
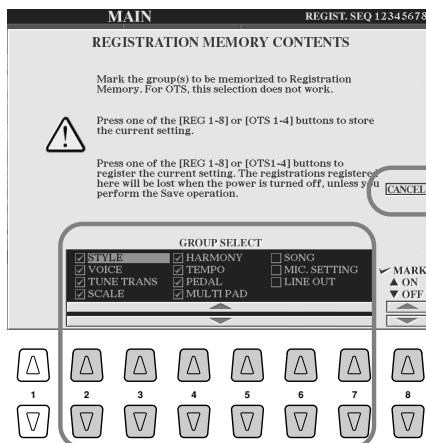

Moves the cursor to the parameter group. You can move the cursor by using the [DATA ENTRY] dial.

- ▶ **3** Press the numbered [REGISTRATION MEMORY] button to which you wish to memorize the panel setup.

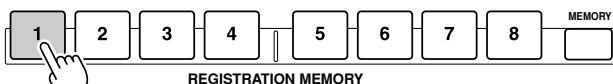

The memorized button becomes red.

- ▶ **4** Memorize various panel setups to other buttons by repeating steps #1 - #3.



The button to which the panel setup has just been memorized lights red and the button to which the panel setup was previously memorized lights green – the lit buttons indicating that each contains panel setup data.

- ▶ **5** Referring to the instructions on page 52, save the eight memorized buttons as a single Registration Memory bank to the User drive (page 30).

CAUTION

• Any panel setup previously memorized to the selected REGISTRATION MEMORY button (indicator is green or red) will be erased and replaced by the new settings.

CAUTION

• The panel settings memorized via step #1 through #4 are stored temporarily on RAM (page 65). Therefore, they will be lost if you change the Registration Memory bank (page 52) or you turn the power off without executing step #5.

Saving your Registration Memory to the User drive

The TYROS allows you to save all eight memorized buttons as a single Registration Memory bank. You can save as many Registration Memory banks as you want, up to the internal memory capacity of the TYROS.

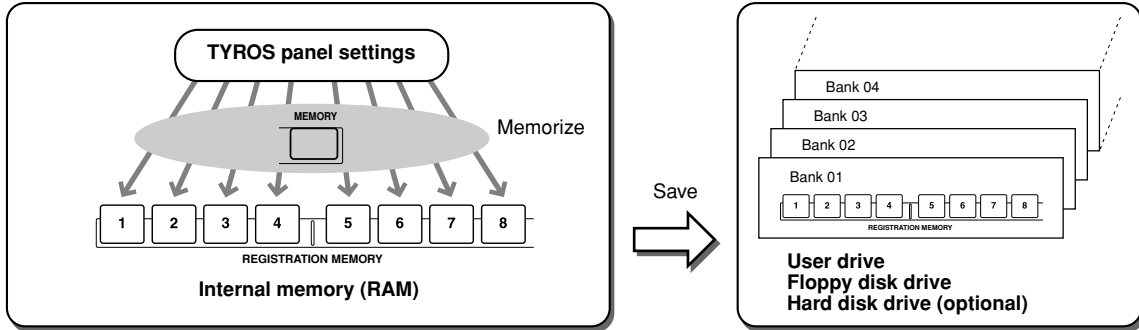

For future recall, you'll need to save your Registration Memory settings to the user drive or Disk drive. Please keep in mind that the panel settings memorized to each button will be lost if you change the Registration Memory bank or you turn the power off without saving them.

In these example instructions, we'll save them to the User drive.

▶ **1 Memorize your custom panel settings to each of the eight Registration Memory buttons, as described on page 51.**

It is not necessary to memorize settings for all eight buttons. If a button has no memorized data, it is unlit.

▶ **2 Press the [REGIST BANK] button to call up the Registration Memory Bank selection (Open/Save) display.**

NOTE

• You can also call up the Registration Memory Bank selection display from the Main display.

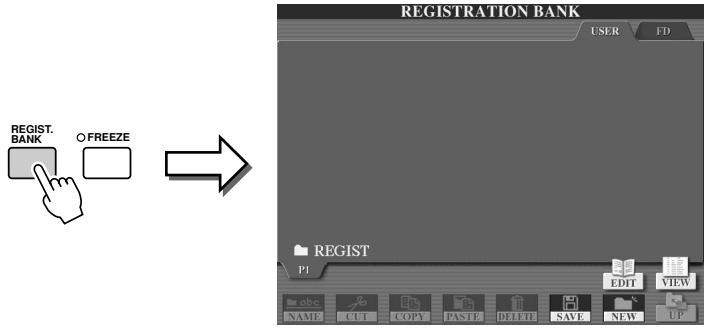

▶ **3 If desired, call up the Registration Edit display and make other settings for Registration Memory, such as naming.**

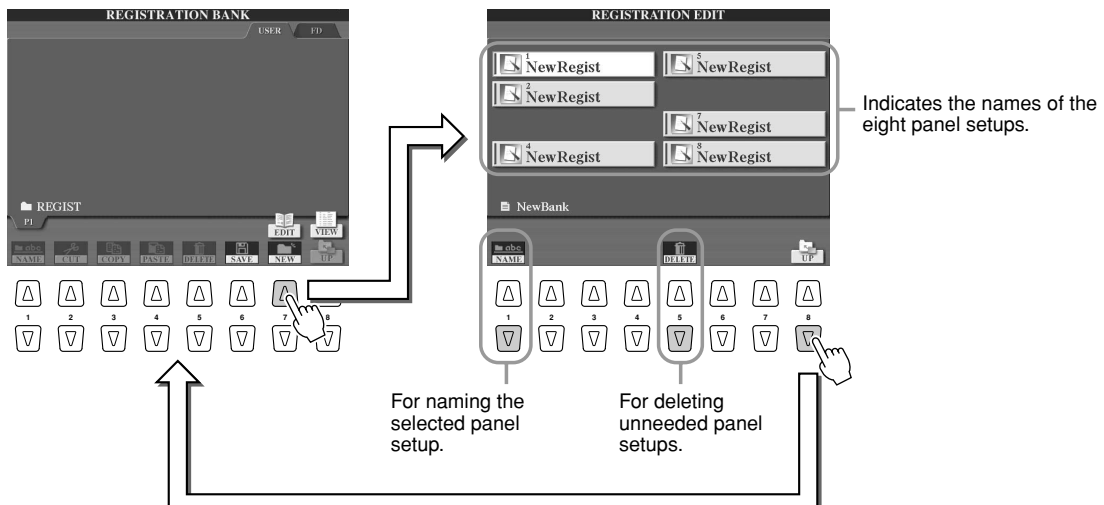

- ▶ **4** Go back to the Registration Memory Bank selection (Open/Save) display and execute the Save operation.

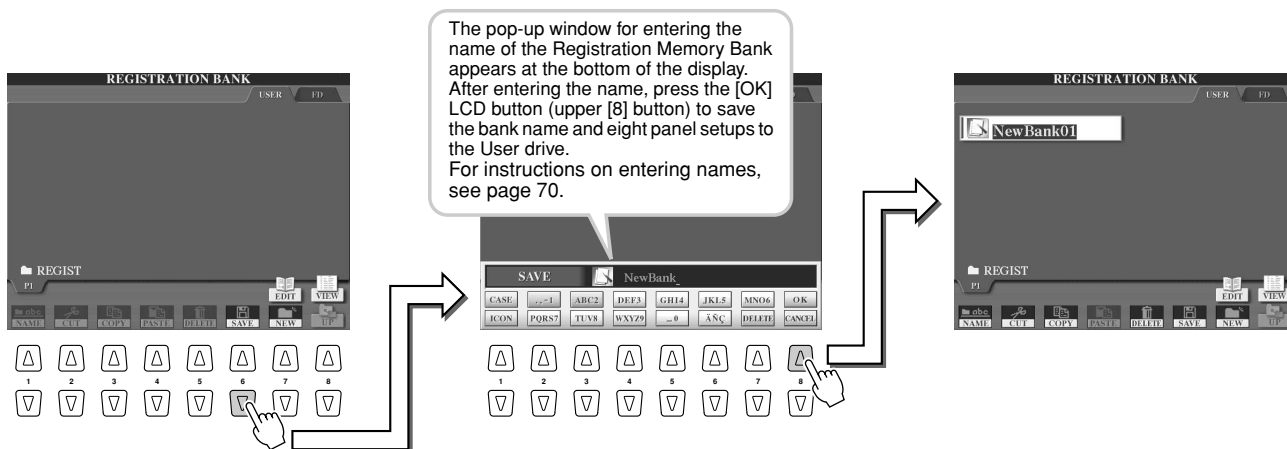

Recalling a Registration Memory Setup

- ▶ **1** Press the [REGIST BANK] button to call up the Registration Memory Bank selection (Open/Save) display.

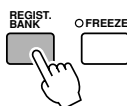

- ▶ **2** Select a Registration Memory bank.

Selecting a Registration Memory bank is done in the same way as selecting a voice (page 26) or style (page 32).

- ▶ **3** Press one of the green-lit numbered buttons in the Registration Memory section.

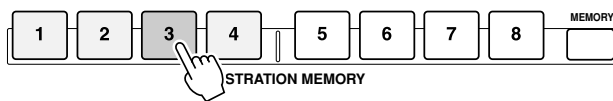

Confirm whether the correct panel settings have been called up or not.

■ Leaving certain parameters unchanged by Registration Memory

— Freeze functionpage 128

Registration Memory lets you recall all the TYROS panel settings you made with a single button press. However, there may be times that you want certain parameters and settings to remain the same, even when changing Registration Memory presets. For example, you may want to switch voices or effect settings while keeping the same accompaniment style. This is where the Freeze function comes in handy. It lets you maintain the settings of certain parameter groups and leave them unchanged, even when selecting other Registration Memory buttons.

- 1** Select the parameter group you want left unchanged or “frozen” (page 128).
- 2** Turn the [FREEZE] button on.
- 3** Change the Registration Memory number.

■ Calling up Registration Memory numbers in order

— Registration Sequencepage 128

As convenient as the Registration Memory buttons are, there may be times during a performance when you want to quickly switch between settings — without having to take your hands from the keyboard. By assigning a footswitch to control Registration Sequence, you can use your foot to step through the Registration Memory presets — in the order you’ve specified.

Recording Your Performances and Creating Songs — Song Recording

Reference on page 94 →

The powerful and easy-to-use Song Creator feature lets you record your own keyboard performances to the user drive, floppy disk, or the optionally installed hard disk. With multiple channels for recording, comprehensive editing features, plus the use of the style and the Multi Pads, you can record complex, fully orchestrated pieces of music in any music style or arrangement – from solo piano and church organ to rock band, big band, Latin ensemble, and even a full symphony orchestra – quickly, easily and all by yourself!

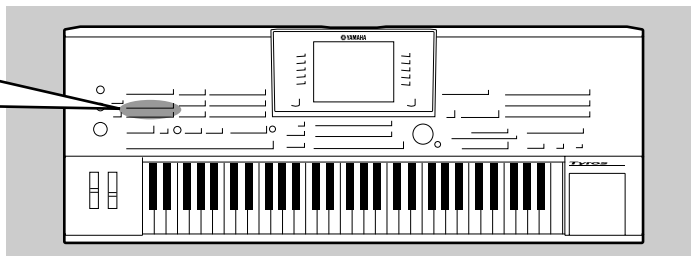

- **Quick Recording**
With this method, you can quickly and easily record a song, without having to make detailed settings.
- **Multi Recording**
With this method, you can record data to each channel independently, one by one, until you have a finished multi-channel song. This method also lets you record several channels simultaneously. To use this, set which part (Right1 - 3, LEFT, Multi Pad, each part of the selected style, etc) is assigned to each MIDI channel before recording.

Memory operations in Song Recording

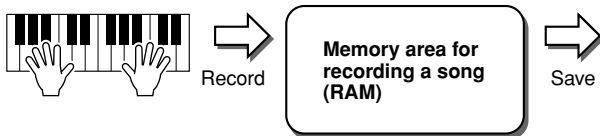

Load a song to be recorded/edited to this area.

- **When creating a new song:**
Load an empty song data to this memory area by pressing the [REC] button and the [TOP] button simultaneously.
- **When editing/re-recording the already recorded song:**
Load the song data to this memory area by selecting the desired song saved to the USER/FD/HD (optional) drives.

Memory drives for saving the recorded song

- User drive
- Floppy disk drive
- Hard disk drive (optional)



Quick Recording

▶ **1** Press the SONG CONTROL [REC] button and the [TOP] button simultaneously to prepare a blank song (“New Song”) to the Memory area for recording (shown above).

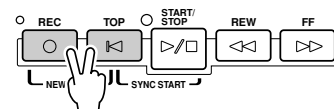

▶ **2** Press the [REC] button to enter the Song Record mode. The [REC] button and the [START/STOP] button flash.

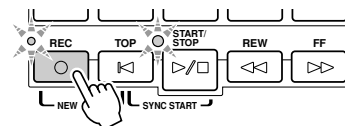

▶ **3** Make the desired panel settings for your keyboard performance. Below are some important things you should or may want to do before recording:

- Check the on/off status of each keyboard part (RIGHT1, RIGHT2, RIGHT3, LEFT). pages 26, 27, 28
- Check the voice of each keyboard part (RIGHT1, RIGHT2, RIGHT3, LEFT). pages 26, 27, 28
- Set the desired tempo. page 109
- Determine the time signature (beat) by selecting a style (even when you do not use a style)..... page 32
- Turn the [ACMP] and [SYNC START] button on if you wish to use style playback. page 32
- Make the desired panel settings using One Touch Setting, if you want to use style playback. page 36
- Check whether the selected style is appropriate or not. If necessary, select the desired style..... page 32
- Check whether the selected Multi Pad Bank is appropriate or not. If necessary, select the desired bank..... page 38
- Turn on [HARMONY/ECHO] if desired..... page 39
- Press one of the REGISTRATION MEMORY buttons if desired..... page 53

▶ 4 Start recording.

Try it out!

The SONG CONTROL [REC] button (that flashes before recording) lights continuously after recording starts. Below are details on how recording can be started.

● **Recording starts as soon as you play a key on the keyboard.**

- When turning the [ACMP] and the [SYNC START] on, style playback and recording start simultaneously as soon as a chord is played in the style chord section of the keyboard (the left side of the split point).
- When turning the [ACMP] on and the [SYNC START] off, recording starts as soon as a chord is played in the style chord section of the keyboard (the left side of the split point) with the Stop Accompaniment (page 33).

● **Recording starts by pressing the SONG CONTROL [START/STOP] button.**

If you start recording in this way, “empty” data is recorded until you play a note on the keyboard. This is useful for creating a measure or two of silence at the top of a song. It can also be used for starting a song with a short one- or two-beat pick-up or lead-in.

- The rhythm parts (channels) of style playback and recording start simultaneously by pressing the STYLE CONTROL [START/STOP] button.

● **Multi Pad playback and recording start simultaneously as soon as you press any of the Multi Pads.**

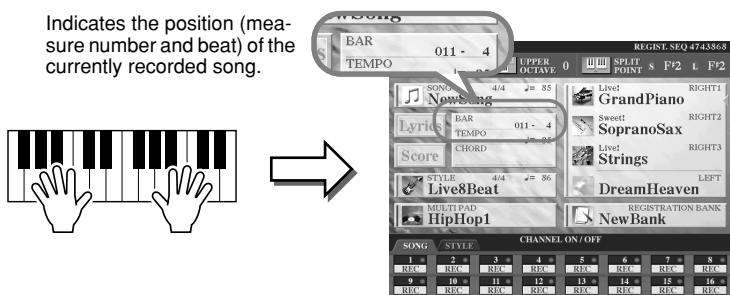

▶ 5 Press the [REC] button to stop recording.

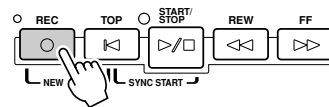

▶ 6 Listen to your newly recorded performance.

Press the [TOP] button so that the song playback position returns back to the top and press the SONG CONTROL [START/STOP] button.

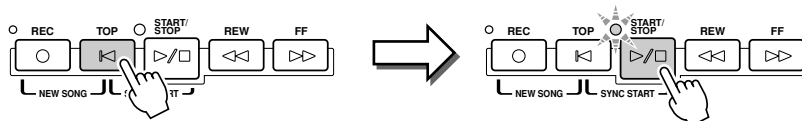

▶ 7 If necessary, re-record a specific section of the recorded song or record an additional section to the end of the recorded song.

Try it out!

Repeat steps #2 - #6 above. You can selectively re-record parts of the song by starting recording in the middle of the song and stopping it when desired, or you can record continuously all the way to the end of the song.

▶ 8 Make sure to save the song data to the USER or FD drive when recording is completed.

Call up the USER or FD page of the Song selection (Open/Save) display by pressing one of the SONG buttons and execute the save.

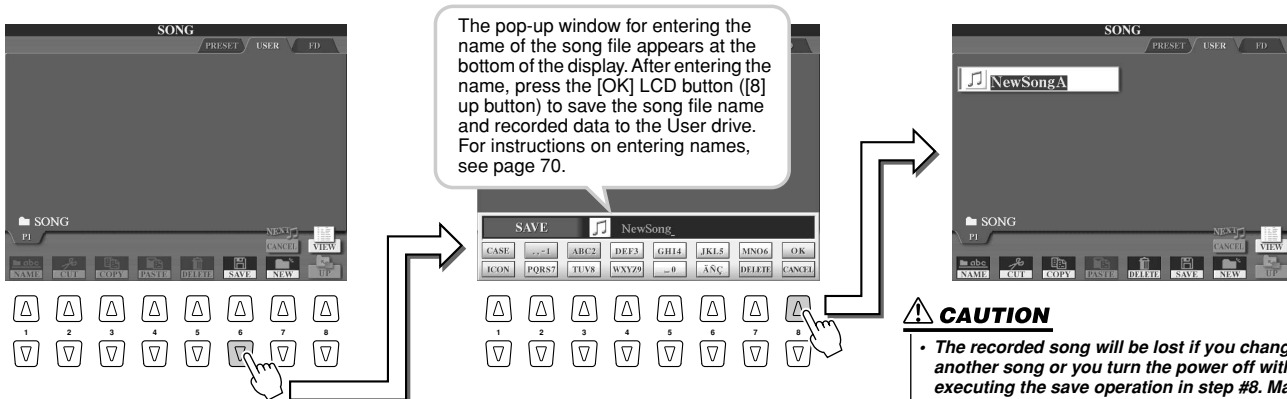

CAUTION

- The recorded song will be lost if you change to another song or you turn the power off without executing the save operation in step #8. Make sure to execute the save operation in step #8.

■ One song — sixteen MIDI channels.....

On the TYROS, a single song can contain separate data for up to sixteen MIDI channels. When recording your own performance, you'll need to assign each part you play to a separate MIDI channel. With Quick Recording (on the previous page), the TYROS takes care of this chore for you — letting you record a song without having to worry about which part goes to which channel. However, you'll increase your understanding of the recording process and gain greater flexibility and control by reading through the sections below — which cover recording rules and characteristics, and show you how to use Multi Recording as well as re-record an existing Quick Recording song.

● Default MIDI channel/part assignments

MIDI channel recorded to a song	Default part when recording a new song from scratch	
1	RIGHT1	Keyboard parts
2	LEFT	
3	RIGHT2	
4	RIGHT3	
5	MULTI PAD 1	Multi Pads
6	MULTI PAD 2	
7	MULTI PAD 3	
8	MULTI PAD 4	
9	RHYTHM 1	Style parts
10	RHYTHM 2	
11	BASS	
12	CHORD 1	
13	CHORD 2	
14	PAD	
15	PHRASE 1	
16	PHRASE 2	

● Recording method and default part settings

	Quick Recording	Multi Recording
When recording a new song:	All channels are automatically assigned for recording, with each channel assigned a specific part. (See chart at left.)	Channels to be recorded must be enabled for recording manually. However, parts are automatically assigned to MIDI channels, as shown in the chart at left.
When re-recording an already recorded song:	The channel/part assignments made in the original recording are maintained.	Channels to be recorded must be enabled for recording manually. The channel/part assignments made in the original recording are maintained.

NOTE

- You can change channel/part assignments from the defaults above before actually recording. More specifically, even after entering the Record mode (step #2 below) via Quick Recording, you can still manually enable recording channels and set channel/part assignments via Multi Recording.

Multi Recording

- Press the SONG CONTROL [REC] button and the [TOP] button simultaneously to prepare a blank song ("New Song") to the Memory area for recording (shown above).

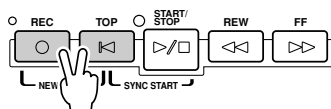

- While holding the [REC] button, select the channel to be recorded and assign the part to the selected channel on the pop-up window that appears at the bottom of the LCD display.

Here, set channel 1 to "REC."

Assign the part to the channel set to REC.

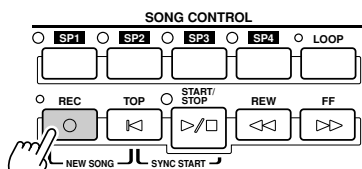

While holding the [REC] button...
Set the desired channel to REC.

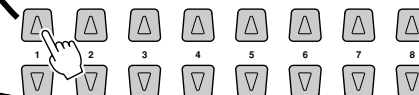

* Select the channel to be recorded and assign the part to the selected channel.

- ▶ **3 Make the desired panel settings for your keyboard performance.**
(Refer to the list of possible settings in step #3 of Quick Recording above.)

▶ **4 Start recording.**

Try it out!

Recording is started in the same way as in Quick Recording.



▶ **5 Press the [REC] button to stop recording.**

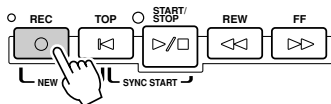

▶ **6 Listen to your newly recorded performance.**

Press the [TOP] button so that the song playback position returns back to the top, then press the SONG CONTROL [START/STOP] button.

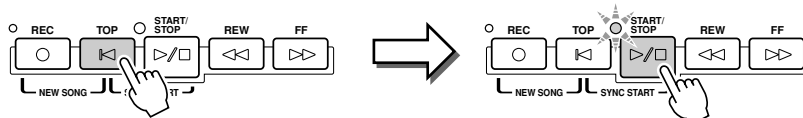

NOTE

- When recording without style playback, using the Metronome function (page 156) can make your recording sessions much more efficient.

▶ **7 If desired, record another channel.**

Try it out!

Repeat steps #2 - #6 above.

▶ **8 Make sure to save the song data to the USER or FD drive when recording is completed.**

Call up the USER or FD page of the Song selection (Open/Save) display and execute the save. For details, see step #8 on page 55.

CAUTION

- The recorded song will be lost if you change another song or you turn the power off without executing the save operation in step #8. Make sure to execute the save operation in step #8.

■ **Re-recording or editing the already-recorded song.....**

Here in the “Quick Guide,” you’ve learned how to create a new song by recording. The following features of the Song Creator function allow you to re-record or edit the already-recorded song.

- Re-recording a specific section of the already-recorded song (Punch In/Out) Page 94
- Editing the recorded data for each channel
 - Quantizing, or aligning the timing Page 96
 - Deleting the data of the specified channel Page 96
 - Mixing (Merging) the data of the specified two channels Page 97
 - Transposing the recorded note data of each channel Page 97
 - Initial settings such as voice, volume, tempo and so on Page 97
- Editing the chord data by using the Event List..... Page 98
- Editing the channel data by using the Event List..... Page 100
- Editing the System Exclusive message data by using the Event List..... Page 106
- Editing the lyric data by using the Event List Page 106

Connecting to a Computer

By connecting a computer, you can transfer data between the TYROS and the computer via MIDI, and use the computer to control, edit and organize data on the TYROS. For example, you can use the included Voice Editor program to edit the TYROS' custom voices. There is also a special File Utility program that lets you use your computer to manage files in the USER/FD/HD (optional) drive.

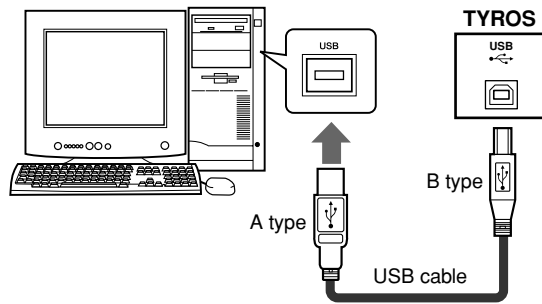

USB

USB

USB is an abbreviation for Universal Serial Bus. It is a serial interface for connecting a computer with peripheral devices, and enables much faster data transfer compared to conventional serial port connections. Also, it allows "hot swapping" (connecting peripheral devices while the power to the computer is on).

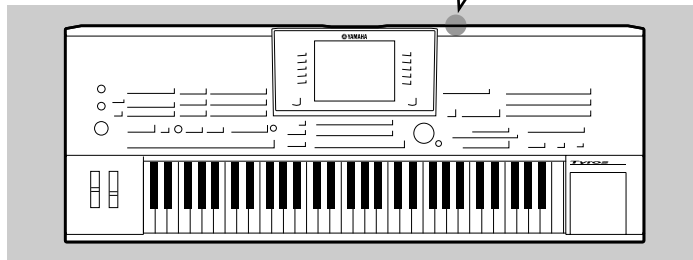

NOTE

- There are two ways to connect the TYROS to a computer: MIDI cable and USB cable. In the following instructions, we'll use a USB cable.

■ What you can do with a computer

- Manage files in the USER/FD/HD (optional) drive of the TYROS using the File Utility software on the included CD-ROM. File Utility also lets you transmit your TYROS files to a computer, and vice versa.
- Create Custom Voices using the Voice Editor software on the included CD-ROM.
- Record performance data (1-16 channels) using the TYROS style playback to a computer running sequence software, such as XGworks. After recording, you can edit the data with the computer, then play it back using the TYROS' tone generator.

⚠ CAUTION

Disconnecting/connecting the USB cable or turning the power off/on may cause the computer operation to hang-up, or may stop the TYROS from functioning properly. Be careful NOT to disrupt the USB connection or turn the power on/off in the following operating conditions.

- While the TYROS is recognizing the device or while loading the driver.
- While starting or shutting down the operating system.
- While computer operation is suspended (with power management controls such as sleep or hibernation).
- While a MIDI application is starting.

The computer may also hang up and/or the TYROS' functions may stop if you do the following:

- Turn the power on/off, or connect/disconnect the cable too often.
- Enter the sleep mode while transmitting the MIDI data, and resume operation.
- Disconnect/connect the cable while the TYROS is on.
- Turn the TYROS on/off, start the computer, or install driver software while a huge amount of data is being transferred.

Initial Setup

Instructions are given below in basic outline format. For details, refer to the separate Installation Guide.

- ▶ **1 Confirm the minimum system requirements of the software you wish to use.**
 - For software on the included CD-ROM (such as Voice Editor, File Utility, USB MIDI driver, etc.), refer to the separate Installation Guide.
 - For other software, refer to the relevant manual or documentation.
- ▶ **2 Connect the computer to the TYROS using a USB cable.**

- ▶ **3 Start the computer and install the required MIDI driver.**
 - For a computer running Windows, install the USB MIDI driver. Refer to the separate Installation Guide.
 - For a Macintosh computer, install OMS. Refer to the separate Installation Guide.
- ▶ **4 Install the desired software to a computer.**
 - To install software from the included CD-ROM (such as Voice Editor, File Utility, USB MIDI driver, etc.), refer to the separate Installation Guide.
 - To install other software, refer to the relevant manual or documentation.

Using the Voice Editor

You can expand the sonic palette of the TYROS by creating your own original voices — using the Voice Editor (included on the CD-ROM). The voices you create can be saved to the PRESET drive on the TYROS as Custom Voices, and can be called up any time by pressing the [CUSTOM VOICE] button.

- ▶ **1 Turn the computer's power on, then turn the TYROS' power on.**
- ▶ **2 Start Voice Editor on the computer.**
- ▶ **3 Edit the voice parameters on the computer to create your original voice.**
For details, refer to the Voice Editor documentation on the CD-ROM.
- ▶ **4 When you've finished editing transfer the edited voice from the computer to the TYROS.**

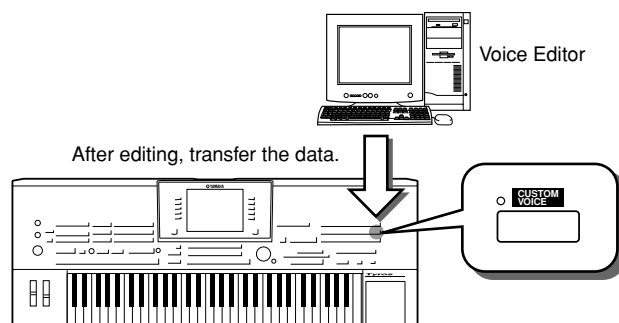

- ▶ **5 Exit the Voice Editor.**
- ▶ **6 Press the [CUSTOM VOICE] button and play your custom voice.** *Try it out!*

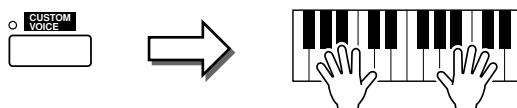

Using the File Utility

- ▶ **1 Turn the computer's power on, then turn the TYROS' power on.**
- ▶ **2 Start File Utility on the computer.**
- ▶ **3 Manage files/folders in the USER/FD/HD (optional) drive of the TYROS using File Utility.**
For details, refer to the File Utility documentation on the CD-ROM.

Basic Operations — Organizing Your Data

Display-based Controls

As you've seen in "Quick Guide" above, the TYROS features an exceptionally large and easy-to-understand display. It provides comprehensive at-a-glance information on all current settings, and gives you convenient, intuitive control over the TYROS' functions.

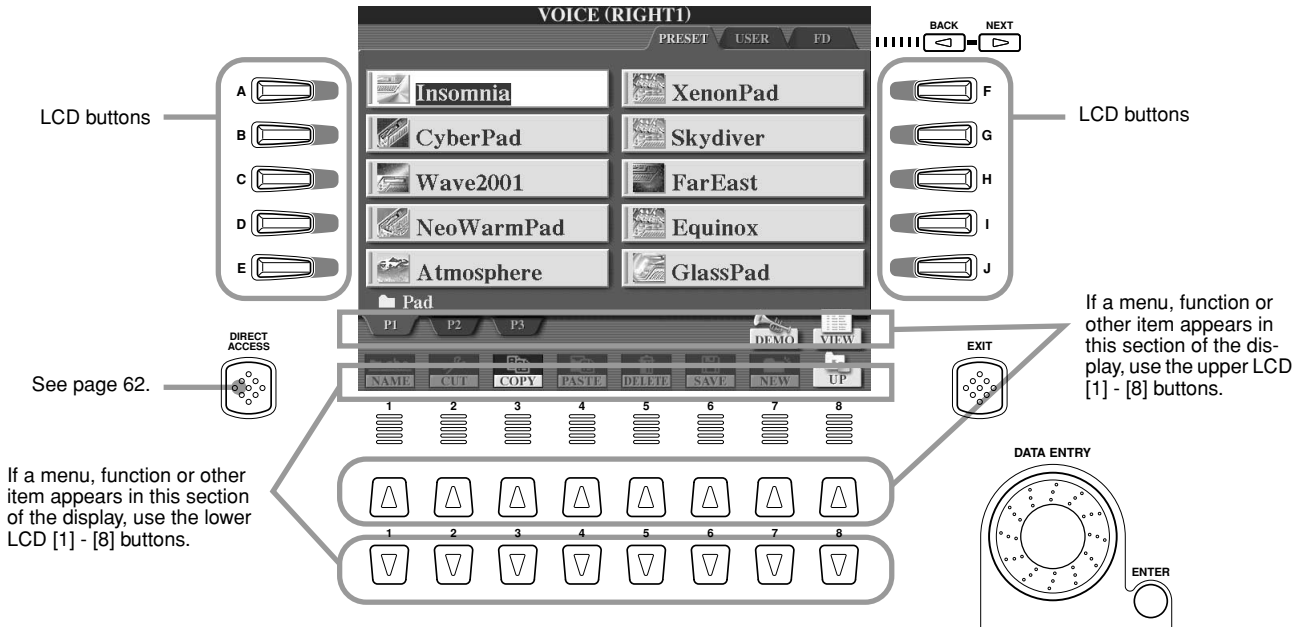

■ LCD (Liquid Crystal Display) buttons.....

The LCD [A] - [J] buttons are used to select the corresponding menu. In the Open/Save display (page 66) shown above, for example, the LCD [A] - [J] buttons can be used to select the corresponding respective voices.

The LCD [1] - [8] buttons are divided into eight sets of upper/lower buttons, and are used to make selections or adjust settings (up or down correspondingly) for functions shown directly above them. In the Open/Save display (page 66) shown above, for example, the upper LCD [1] - [8] buttons can be used to select the menus [P1] - [VIEW] in the upper row, and the lower LCD [1] - [8] buttons can be used to select the menus [NAME] - [UP] in the lower row. Also in the above example, the upper LCD [4] - [6] buttons are inactive and have no effect, because there are no menu items in the display that correspond to these buttons.

■ [DATA ENTRY] dial and [ENTER] button

Depending on the selected LCD display, the [DATA ENTRY] dial can be used in the following two ways.

● Entering the values

For parameters indicated at the bottom of the Main display (such as the "slider" controls in the mixer window; page 36), you can conveniently use the [DATA ENTRY] dial in tandem with the LCD [1] - [8] buttons. Simply select the desired parameter with the appropriate LCD button (the name changes color), then use the [DATA ENTRY] dial to adjust it.

This convenient technique also works well with pop-up parameters such as Tempo and Transpose. Simply press the appropriate button (ex., [TEMPO +]), then rotate the [DATA ENTRY] dial and press [ENTER] to close the window.

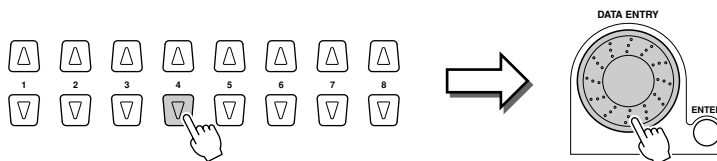

● Selecting files (voice, style, song, and so on)

When one of the Open/Save displays (page 66) is shown, you can use the [DATA ENTRY] dial and the [ENTER] button to select a file (voice, style, song, and so on). Rotate the [DATA ENTRY] dial to move the highlight and press the [ENTER] button to actually call up the highlighted file. In the Open/Save display for voices shown above, for example, rotate the [DATA ENTRY] dial to move the cursor to the desired voice and press the [ENTER] button to actually call up the selected voice.

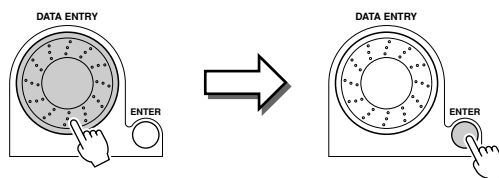

■ [BACK]/[NEXT] button.....

These buttons are used mainly to change the pages of displays that have “tabs” at the top, such as the Open/Save display (page 66).

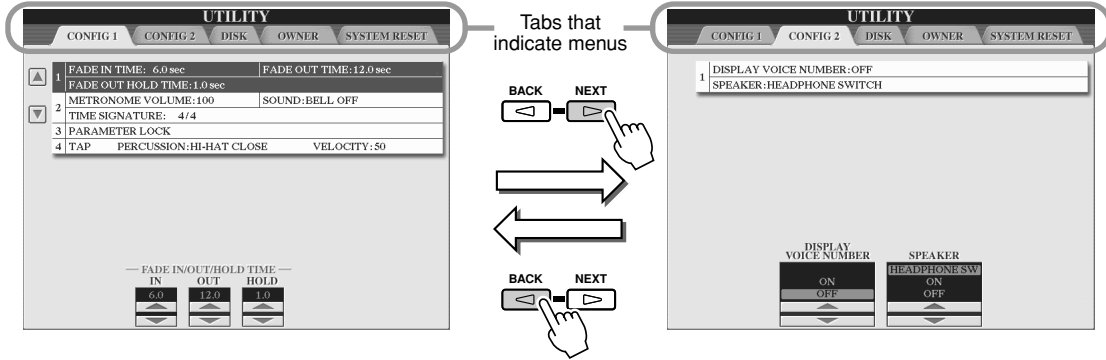

■ [EXIT] button.....

No matter where you are in the TYROS display hierarchy, the [EXIT] button will return you to the next highest level or to the previously indicated display. Since the TYROS has so many different displays, you may occasionally find yourself confused as to which operation’s display is currently shown. If this happens, you can return to “home base” by pressing the [EXIT] button several times. This returns the TYROS to the default Main display (page 24) — the same display that appears when the power is turned on.



Help/Display Messages

■ Help

The Help messages give you informative explanations and descriptions of the main functions and features of the TYROS.

1 Press the [HELP] button.

2 Select the desired Help topic.

3 Call up the explanation display of the selected topic.

Select the Language, if necessary. The language selected here is also used for various “Messages” shown during operations.

NOTE

- Selecting a different language here may cause the following problems.
 - Some characters of the file names you entered may be garbled.
 - Files may not be accessible.

Restoring the original language solves the above problems. Reading the files on the computer with a different language system may cause similar problems to those above.

Use these to select different pages.

■ Display Messages.....

Thanks to the large LCD panel, the TYROS can display comprehensive messages and prompts that clearly guide you through the various operations. When such messages appear, simply follow the instructions as shown by pressing the corresponding LCD button.

NOTE

- These messages can be displayed in one of five different languages. You can select the desired language of the display messages. See page 61.

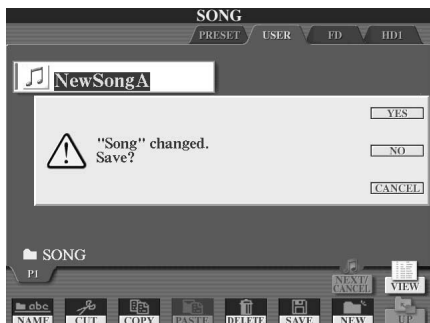

Direct Access — Instant Selection of Displays

With the convenient Direct Access function, you can instantly call up the desired display — with just a single additional button press. Press the [DIRECT ACCESS] button and a message appears in the display prompting you to press the appropriate button. Then, simply press the button corresponding to the desired setting display to instantly call up that display. In the example below, Direct Access is used to call up the display for selecting the Guide settings (page 48). Refer to the separate Data List for a list of the displays that can be called up with the Direct Access function.

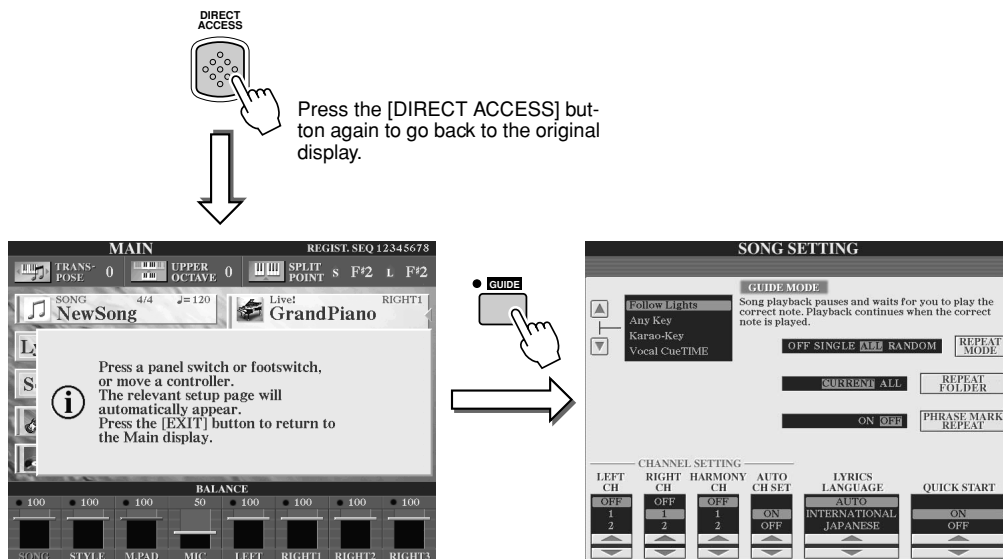

NOTE

- Here's a convenient way to return to the Main display (page 24) from any other display: Simply press the [DIRECT ACCESS] button, then the [EXIT] button.

Basic Structure of File/Folder and Memory Drives

The TYROS utilizes a variety of data types — including voices, styles, songs and registration memory settings. Much of this data is already programmed and contained in the TYROS; you can also create and edit your own data with some of the functions on the instrument. All this data is stored in separate files — just as is done on a computer. Here, we'll show you the basic structure in handling and organizing the data of the TYROS in files and folders using several memory drives.

■ Data files.....

The following 11 types of data are handled by the TYROS as files. These can be viewed or selected mainly by using the respective Open/Save display.

- **Voices (of musical instruments)**..... pages 26, 78
- **Styles**..... pages 32, 108
- **Songs**..... pages 43, 88
- **Multi Pad Banks**..... pages 38, 124
- **Registration Memory Banks**..... pages 51, 128
- **User Effects**
 - Vocal Harmony types* pages 47, 130
 - User Effects* page 138
 - User Master EQ* page 139
 - User Master Compressor* page 140
- **MIDI Setup**
 - MIDI template page 145
- **System Setup**..... page 159
- **Music Finder****..... pages 40, 126, 159
- **Main Picture (displayed on the background of the Main display)**..... page 158
- **Lyrics Background Picture** page 90

NOTE

- The Main Picture and the Lyrics Background Picture cannot be created from the TYROS.

*These data cannot be saved to the FD or HD (optional) drive individually.

**The Music Finder feature handles all the Records including the preset and additionally created records as a single file.

■ File groups and folders.....

The file types described above are organized into “folders” and stored as such. In the case of voices, the same type of instrument sounds are stored together as files in their own folders — such as Piano, Strings, and Trumpet. The similarly organized buttons on the panel can be considered folders as well, for the various voices and styles.

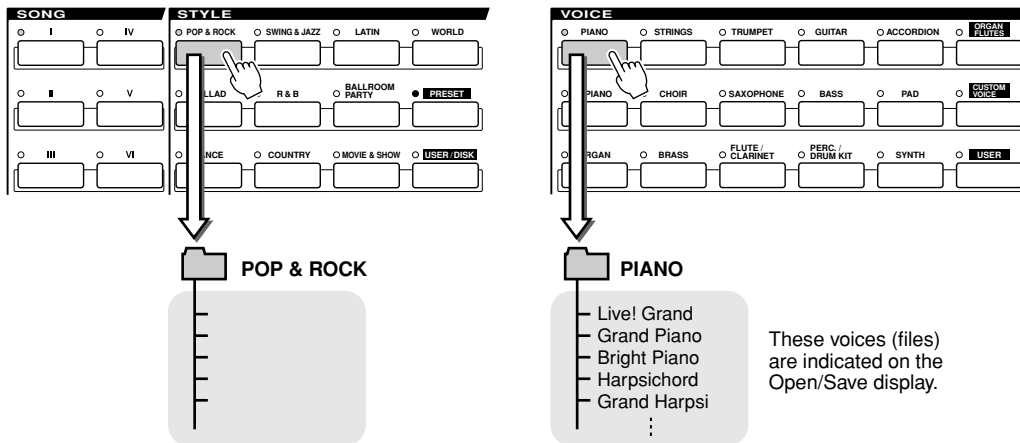

■ Memory Drives to which folders/files are saved.....

Folders and files described above are saved to the following memory drives.

- **PRESET drive**..... The files that are pre-programmed and installed internally to the TYROS are kept here. Preset files can be loaded (called up) but cannot be re-written to the drive, because it uses ROM (Read Only Memory).
- **USER drive**..... Files kept here are those containing your own original data, created or edited using the various functions of the TYROS. Since this internal drive uses Flash ROM, the contents are maintained even when the power is turned off.
- **FD drive** You can also store your original data to floppy disk. Commercially available disk software can also be called up here. Naturally, these files are available only when the appropriate disk is inserted in the floppy disk drive.
- **HD drive (optional)**... An optional hard disk drive can be installed to the TYROS. Created data can be saved here and recalled.

Files and Memory Drives

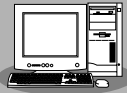

● Voice Editor

You can create your original voice as a Custom Voice on Preset drive by using a computer and the included Voice Editor software. Normally, data cannot be stored to the Preset drive; however, voice data created with the Voice Editor can be stored to the Preset drive.



● File Utility

You can manage files (copy, etc) on User drive or Disk drive by using a computer and the included File Utility software.

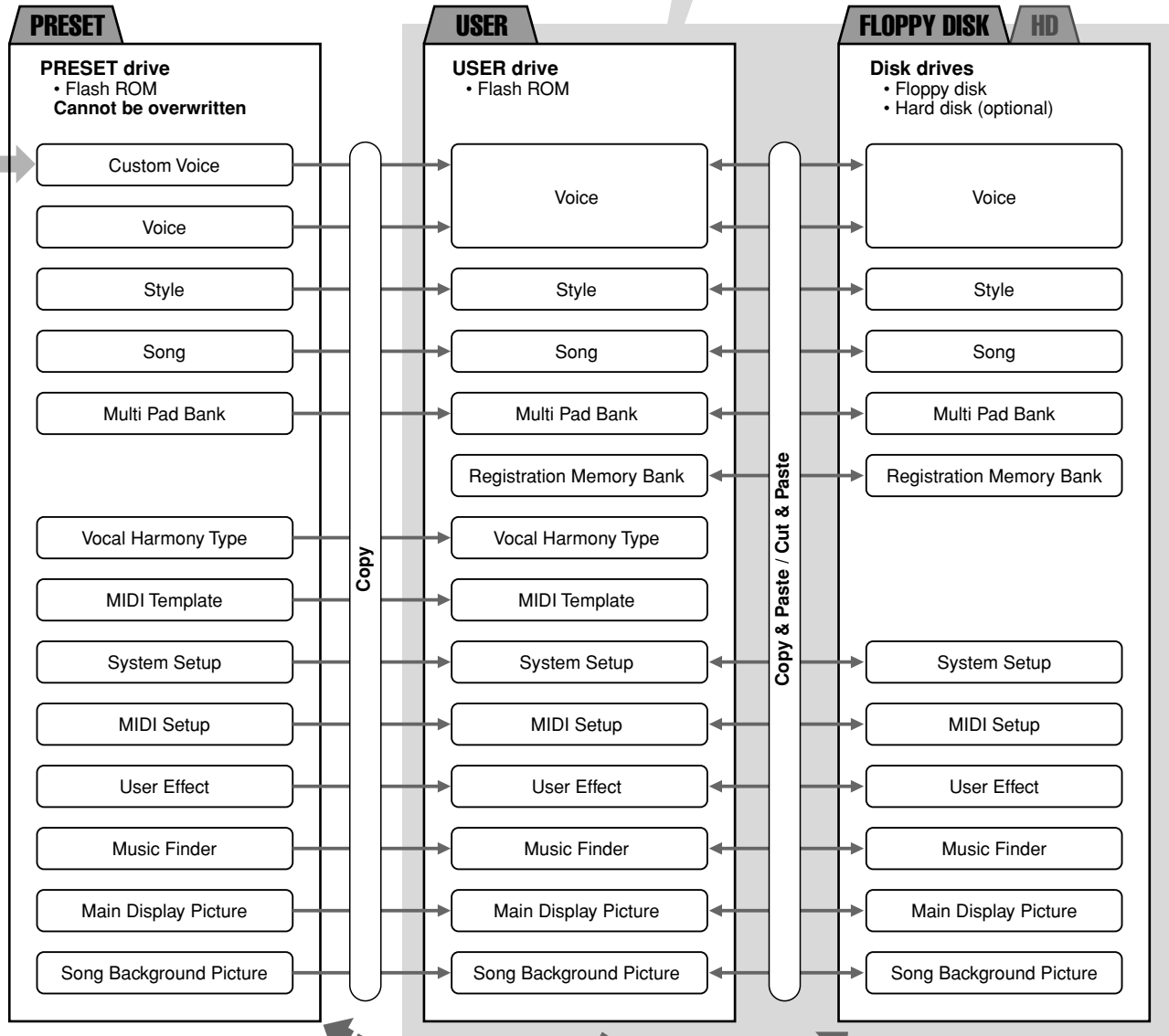

This is the Voice Open/Save display called up by pressing the [PIANO] button in the VOICE section.

NOTE

- The Open/Save display indicates only those files that can be managed from the selected display. The FD (Floppy Disk) drive of the Voice Open/Save display, for example, indicates only voices even if style or song files are saved to the floppy disk.

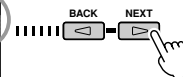

Select a Memory drive by using the [BACK]/[NEXT] buttons.

■ TYROS' Features and Memory Drives

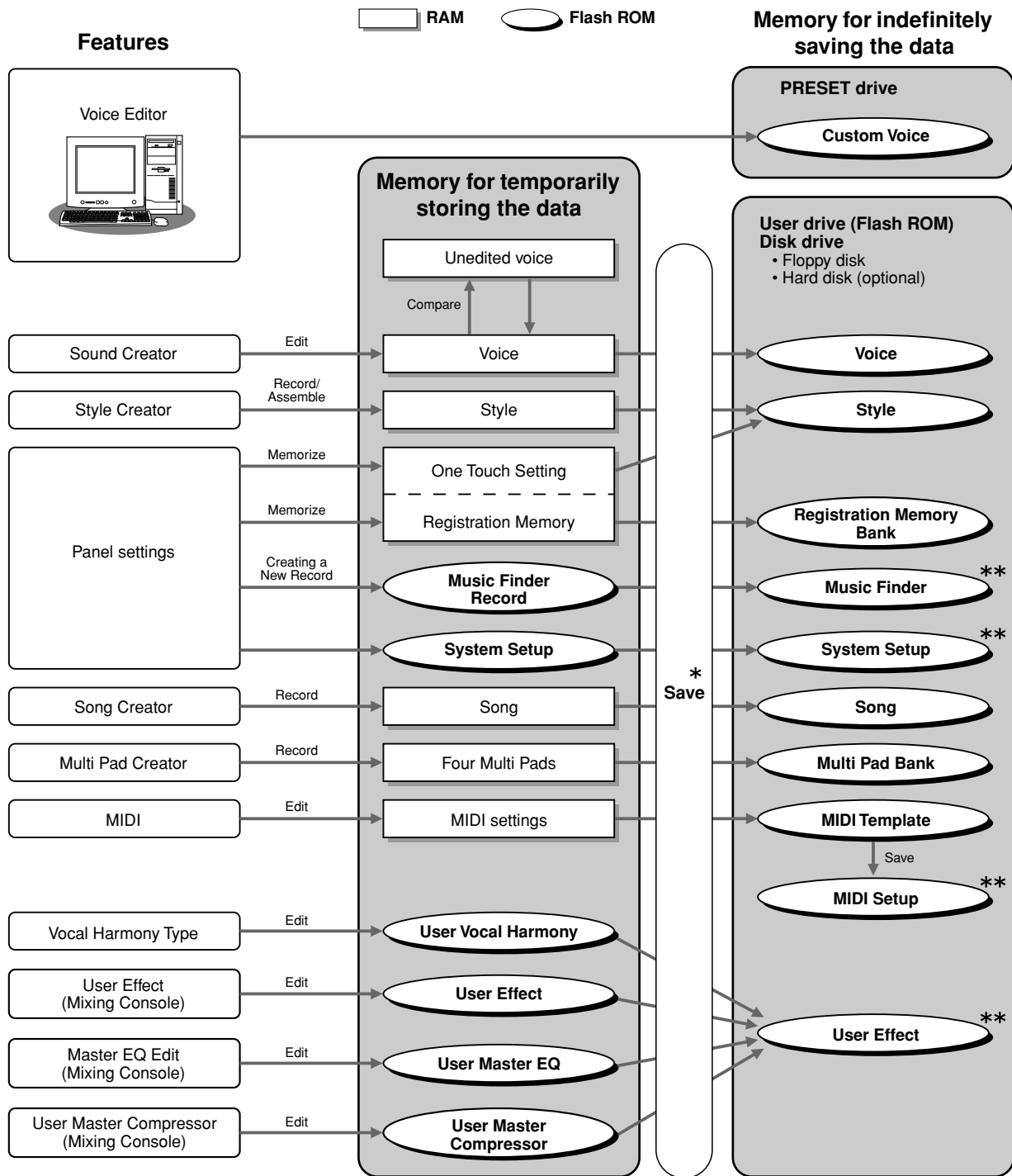

CAUTION

• The data in Flash ROM is maintained even when the power is turned off. Data in RAM, on the other hand, is lost when you select another file or turn the power off. Make sure to save the necessary data on RAM to User drive (Flash ROM) or Disk drive (floppy disk or optionally installed hard disk) before selecting another file or turning the power off.

* The Save operation is executed from the Open/Save display.

**The corresponding Open/Save display can be called up from the [FUNCTION] → UTILITY → SYSTEM RESET display.

Creating a New Folder

As your TYROS data library grows, you'll want to organize it in various folders. This operation lets you create new folders on the User, Floppy Disk and optional Hard Disk drives. The basic procedure is described below; for a specific example (using Voices), see page 30 in the Quick Guide.

- ▶ **1** Call up the page (path) of the Open/Save display for which you wish to create a new folder.
- ▶ **2** Press the [NEW] LCD button (lower [7] button) below the LCD display to call up the pop-up window for entering the folder name.



NOTE

- On the User drive, folder directories can contain up to four levels. The maximum total number of files and folders which can be stored is 3,200, but this may differ depending on the length of the file names.
- On the User/FD (Floppy Disk)/HD (optionally installed Hard Disk), the maximum number of files which can be stored in a folder will be 250.

- ▶ **3** Enter the name of the new folder. See page 70 for instructions on entering names.
- ▶ **4** Press the [OK] LCD button (upper [7] button) to actually create the new folder.

Selecting (Opening) a Folder/File

You can select a folder/file in two ways — by using the LCD letter buttons or by using the [DATA ENTRY] dial.

How to select a file using the LCD buttons

▶ **1** Select a memory drive.

▶ **2** If there are more folders/files in the drive than can be displayed on a single page (the maximum is ten), use these buttons to select the additional pages.

▶ **3** Press the letter button corresponding to the desired folder/file.

- NOTE**
- Double-clicking the appropriate [A] -[J] button calls up the corresponding file and closes the Open/Save display.

How to select a file using the dial

▶ **1** Select a memory drive.

▶ **2** Turn the dial to select the desired file/folder. (The selected item is highlighted.)

▶ **3** Press the [ENTER] button to call up the selected file.

- NOTE**
- Double-clicking the [ENTER] button calls up the corresponding file and closes the Open/Save display.

Copying Folders/Files (Copy & Paste)

Folders and files can be freely copied among the installed drives, with the exception of the Preset drive — data can be copied **from** the Preset drive, but not **to** it. The basic procedure is described below; for a specific example (using Voices), see page 30 in the Quick Guide.

- ▶ **1 Call up the page (path) of the Open/Save display, where the relevant folders/files are located.**
- ▶ **2 Press the [COPY] LCD button (lower [3] button) at the bottom the LCD display.**

The pop-up window for the copy operation appears at the bottom of the LCD display. To return to the original display, press the [CANCEL] LCD button.

NOTE

- The Open/Save display does not let you directly copy a file/folder from one floppy disk to another. If you want to do this, use the DISK TO DISK COPY function on the [FUNCTION] → UTILITY → DISK display (page 157).



- ▶ **3 Select the desired folders/files to be copied.**
Press the LCD letter button that corresponds to the desired folder/file. Several files/folders can be selected together, even those from other pages. Press the [ALL] LCD button (lower [6] button) to select all the folders/files indicated on the current display including the other pages. When the [ALL] LCD button (lower [6] button) is pressed, [ALL] changes to [ALL OFF] letting you release or cancel the selection.
- ▶ **4 Press the [OK] LCD button (lower [7] button) to return to the Open/Save display.**
- ▶ **5 Call up the destination display.**
The Preset drive cannot be selected as the destination. Create a new folder (page 67) at the destination page (path) as needed.
- ▶ **6 Press the [PASTE] LCD button (lower [4] button).**
The folders/files copied from the source page (path) appear on the display.

Moving Folders/Files (Cut & Paste)

Folders and files can be freely moved among the installed drives, with the exception of the Preset drive — data can be copied and moved **from** the Preset drive, but not **to** it.

- ▶ **1 Call up the page (path) of the Open/Save display, where the relevant folders/files are located.**
- ▶ **2 Press the [CUT] LCD button (lower [2] button) at the bottom the LCD display.**
The pop-up window for the Cut operation appears at the bottom of the display. To return to the original display, press the [CANCEL] LCD button.

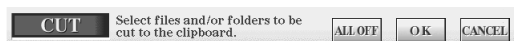

- ▶ **3 Select the desired folders/files to be moved.**
The operation is the same as in step #3 of “Copying Folders/Files (Copy & Paste).” See above.
- ▶ **4 Press the [OK] LCD button (lower [7] button) to return back to the Open/Save display.**
- ▶ **5 Call up the destination display.**
The Preset drive cannot be selected as the destination. Create a new folder (page 67) at the destination page (path) as needed.
- ▶ **6 Press the [PASTE] LCD button (lower [4] button).**
The folders/files moved from the source page (path) appear on the display.

Deleting Folders/Files

Folders and files can be freely deleted from the installed drives, with the exception of the Preset drive.

- ▶ **1** Call up the page (path) of the Open/Save display, where the relevant folders/files are located.
- ▶ **2** Press the [DELETE] LCD button (lower [5] button) at the bottom the LCD display. The pop-up window for the Delete operation appears at the bottom of the display. To return to the original display, press the [CANCEL] LCD button.

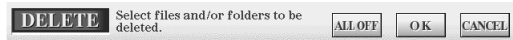

- ▶ **3** Select the desired folders/files to be deleted. The operation is the same as in step #3 of “Copying Folders/Files (Copy & Paste).” See page 68.
- ▶ **4** Press the [OK] LCD button (lower [7] button). A confirmation prompt appears.
- ▶ **5** Follow the on-screen instructions.

Saving Files

This operation lets you save your original custom data (such as songs and voices you’ve created) to the User, Floppy Disk or optional Hard Disk drives.

Note that if you’re saving the currently open file, step #1 is not necessary.

- ▶ **1** After you’ve created a song or voice in the relevant Song Creator or Sound Creator display, press the [SAVE] LCD button. The corresponding Open/Save display appears.

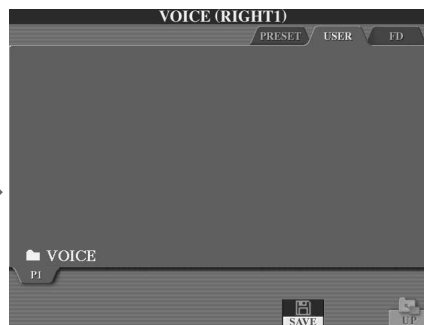
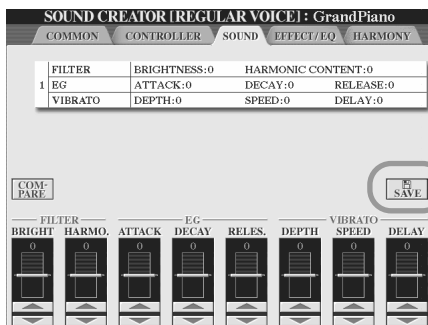

NOTE

- For some editing operations — such as User Effect, User Master EQ, and User Master Compressor — a pop-up window (like that in step #3 here) will be called up instead of the Open/Save display. In this case, steps #2 and #3 are unnecessary.

- ▶ **2** Call up the destination display.
- ▶ **3** Press the [SAVE] LCD button (lower [6] button). The pop-up window for the Save operation appears at the bottom of the display. To return to the original display, press the [CANCEL] LCD button.



- ▶ **4** Enter the file name (page 70).
- ▶ **5** Press the [OK] LCD button (lower [7] button).
- ▶ **6** Press the [OK] button again to actually save the file.

Naming Folders/Files

Folders and files on the installed drives can be freely renamed. You can also name files you've created. The instructions below apply when calling up the Name operation from the Open/Save display. For other cases, go directly to step #5 below.

- ▶ **1 Call up the page (path) of the Open/Save display, where the relevant folders/files are located.**
- ▶ **2 Press the [NAME] LCD button (lower [1] button) at the bottom the LCD display.**
The pop-up window for the Name operation appears at the bottom of the display. To return to the original display, press the [CANCEL] LCD button.

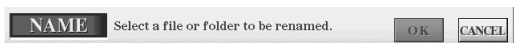

- ▶ **3 Select the desired folder or file to be named.**
- ▶ **4 Press the [OK] LCD button (lower [7] button).**
The pop-up window for entering the name appears at the bottom of the display. To return to the original display, press the [CANCEL] LCD button.
- ▶ **5 Input the name of the selected folder or file.**

DATA ENTRY Move the cursor to the desired position by using the [DATA ENTRY] dial.

Press the appropriate button, corresponding to the character you wish to enter. Several different characters are assigned to each button, and the characters change each time you press the button. To actually enter the selected character, move the cursor or press another letter-input button.

Press the [OK] LCD button (upper [8] button) to actually enter the new name and return to the original display.

Select the desired upper row menu by using the upper LCD [1] - [8] buttons.

Select the desired lower row menu by using the lower LCD [1] - [8] buttons.

Press the [CANCEL] LCD button (lower [8] button) to delete all of the characters on the line at once and return to the original display.

Deletes the character at the cursor.

Pressing this (lower [6] button) before actual entry of the character adds a special character mark (umlaut, accent, Japanese "ゝ" and "ゝ") to the character. Pressing this (lower [6] button) after actually entering a character calls up the miscellaneous character list. Move the cursor to the desired mark by using the [DATA ENTRY] dial, then press the [OK] LCD button (upper [8] button) or [ENTER] button to enter the character and return back to the Name original pop-up window.

Call up the ICON SELECT display by pressing the lower [1] button. This lets you change the icon at the left of the file name.

Change the type of character by using the [1] up button.

- If you select Japanese as the Language in the [FUNCTION] → UTILITY → OWNER display (page 158), the following different types of characters and sizes can be entered:
 - かな漢 (kana-kan).... Hiragana and kanji, marks (full size)
 - カナ (kana) Katakana (normal size), marks (full size)
 - カナ (kana) Katakana (half size), marks (half size)
 - ABC Alphabet (capital and small letters, full size), numbers (full size), marks (full size)
 - ABC Alphabet (capital and small letters, half size), numbers (half size), marks (half size)
- If you've selected a language other than Japanese in the [FUNCTION] → UTILITY → OWNER display (page 158), the following types of characters are available:
 - CASE Alphabet (capital letters, half size), numbers (half size), marks (half size)
 - case Alphabet (lowercase letters, half size), numbers (half size), marks (half size)

NOTE

• The example pop-up menu shown here appears when the Language parameter is set to "ENGLISH" on the [FUNCTION] → UTILITY → OWNER display (page 158) and the type of characters here is set to "ABC (half size)."

- ▶ **6 Press the [OK] LCD button (lower [8] button) to actually enter the new name for the item and return to the original display.**

■ **Converting into Kanji (Japanese language)**.....

This applies only if you are using the “かな漢 (kana-kan)” button (in Japanese). When the input “hiragana” characters are shown in reverse display (highlighted), press the [ENTER] button one or several times to convert the characters into the appropriate kanji. The reversed area can be changed by the [DATA ENTRY] dial. The converted area can be changed back to “hiragana” by the [DELETE] LCD button (lower [7] button). The reversed area can be cleared at once by the [CANCEL] LCD button (lower [8] button). To actually enter the change, press the [OK] LCD button (upper [8] button) or enter the next character. To enter the “hiragana” itself (without converting it), press the [OK] LCD button (upper [8] button).

Changing the Open/Save Display View

The Open/Save display actually has two different view types. One is Direct Selection, which we’ve seen up until this point. The other is Number Input, which lets you open files according to their numbers. Switch between the two types by pressing the upper [7] LCD button.

Open/Save display — Direct Selection



Open/Save display — Number Input

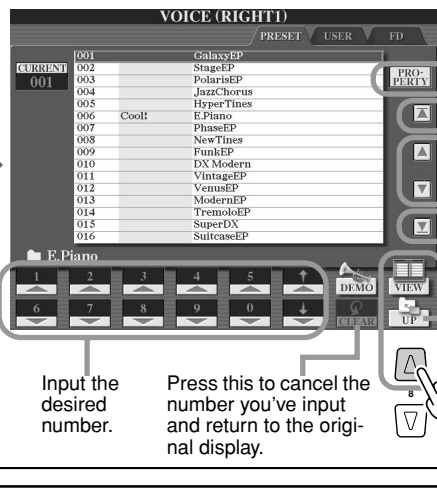

- Shows the property of the drive/folder/file.
- Moves the cursor to the top of this page (path).
- Scrolls up/down through the file list on this page (path).
- Moves the cursor to the end of this page (path).
- Calls up the upper level directory page.

Input the desired number. Press this to cancel the number you've input and return to the original display.

From the Direct Selection type, you select the desired file directly by pressing the appropriate LCD letter button. The Number Input type, on the other hand, lets you call up the desired file by entering the appropriate file number (see below). Since the TYROS has many files spread out over several pages, Number Input may be quicker and more convenient — providing you know the number of the file.

■ **Number Input type — Entering numbers**.....

To select voice number 128, for example, press the [1], [2] and [8] LCD buttons in sequence as shown below, and press the [ENTER] button. Entering one- or two-digit numbers is done in the same way.

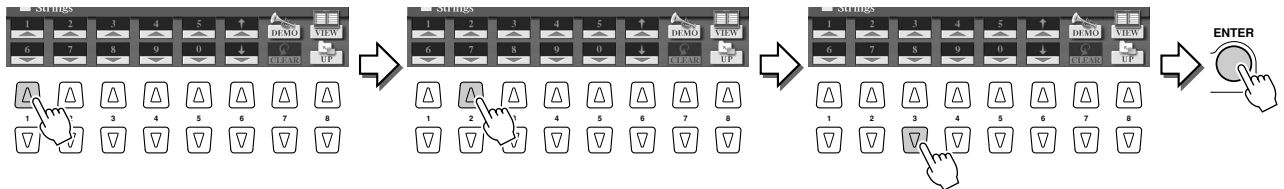

When you select the next or previous file, press the [▲] or [▼] LCD button.



■ **Number Input type — Memorizing paths.....**

The location of the folders and files currently indicated on the LCD display is referred to as a “path.” The Open/Save display for songs and styles lets you memorize the current path to one of the panel buttons. Even if your data is scattered across the drive in a complex hierarchy of folders and paths, you can instantly call up a specific file — no matter how deeply hidden — with a single button-press.

In the example instructions below, the Open/Save display for songs is used.

- ▶ **1 First, select the Number Input type, then call up the path to be memorized to the button and press the [MEMORY] LCD button (LCD [E] button).**

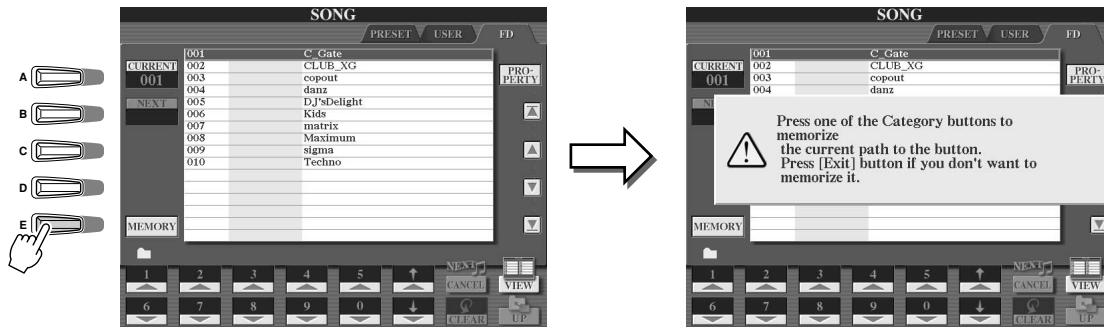

- ▶ **2 Press the desired button in the SONG section (for songs) to which the path (selected in step #1 above) is to be memorized.**

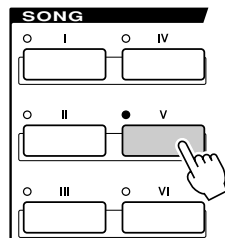

- ▶ **3 Call up the other path (for example, the Open/Save display for voices) and press the same button as in step #2.**
You will see the display same as shown in step #1.

Paths for style files can also be memorized, as explained above. See page 111 for details.

About the Highlight Cursor in the Display

As we've seen up to this point, the LCD display lets you select various types of files such as voice, style, song, and lets you adjust the parameter value of various functions. The highlight cursor is another convenient, colorful feature of the LCD display, since it clearly indicates (by a red border and highlighted background) the file to be selected or the parameter to be adjusted.

■ Cursor indication of files (voices, styles, songs, etc.)

The currently selected voice which will sound when you play the keyboard.

You can move the cursor around the Open/Save display by using the [DATA ENTRY] dial. The highlighted item is not actually selected until you press the [ENTER] button.



■ Cursor indication of parameters



In this display (Mixing Console), the selected parameter for editing is highlighted; use the [DATA ENTRY] dial to adjust the parameter.

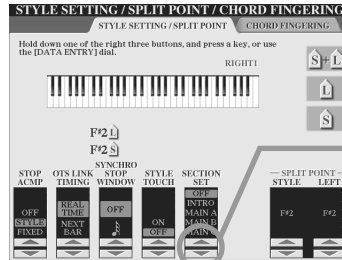

In this display (Microphone Setting), the selected arrow indicators are highlighted in red. Use the [DATA ENTRY] dial to adjust the selected parameter.

About the Panel Button Colors

The panel buttons listed in the chart below light in one of two colors: green or red. This easy-to-understand color-coding scheme indicates the status of the button/function, as described here.

- **Off**No data is currently assigned to the button.
- **Green**Data has been assigned to the button.
- **Red**Data has been assigned to the button and the button is active or playing back.

For details about each button, see below.

	Off	Green	Red
[REGISTRATION MEMORY] buttons	No panel settings are memorized to the button.	Panel settings are memorized to the button.	Panel settings are memorized to the button and the button is active (was selected last).
[PROGRAMMABLE ONE TOUCH SETTING] buttons	No panel settings are memorized to the button.	Panel settings are memorized to the button.	Panel settings are memorized to the button and the button is active (was selected last).
INTRO [I] - [III] buttons MAIN VARIATION [A] - [D] buttons [BREAK] button ENDING/rit.[I] - [III] buttons	The corresponding section of the selected style has no data.	The corresponding section of the selected style has data.	The corresponding section of the selected style has data and is active.
[SP1] - [SP4] buttons	No song position marker is assigned to the button.	A song position marker is assigned to the button.	A song position marker is assigned to the button and represents the latest marker to be passed during playback.
MULTI PAD [1] - [4]	No data is assigned to the Multi Pad.	Data is assigned to the Multi Pad.	Active (playing back).

About the Keyboard

The TYROS keyboard features various functions and performance conveniences that are simply unavailable on an acoustic instrument. As explained in the Quick Guide for example, it allows you to play several different voices together in a layer, or play one voice with your left hand while you play a different voice (or even three layered voices!) with your right. Below is a summary of the keyboard-related functions and modes.

Keyboard Sections and Their Functions

● Playing a single voice

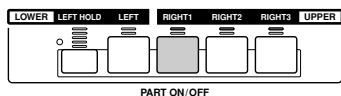

VOICE RIGHT1

● Playing two voices in a layer

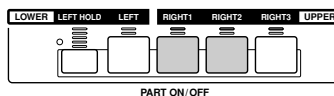

VOICE RIGHT1 + RIGHT2

● Playing three voices in a layer

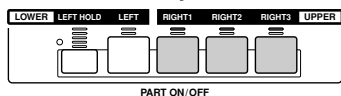

VOICE RIGHT1 + RIGHT2 + RIGHT3

● Playing separate voices with the right and left hands

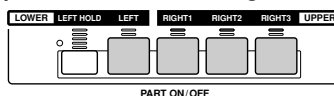

VOICE LEFT VOICE RIGHT1 + RIGHT2 + RIGHT3

Split Point..... The point on the keyboard that separates the left-hand section and the right-hand section.

● When [ACMP] (style playback) is turned on:

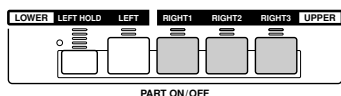

Chord section for style playback

VOICE RIGHT 1 - 3

Split Point..... The point on the keyboard that separates the chord section and the right-hand section.

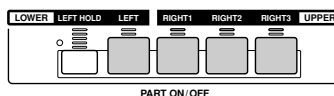

Chord section + VOICE LEFT

VOICE RIGHT 1 - 3

Split Point



When the Split Point for the Chord section and the Split Point for the Voice are set to different points (notes):



Split Point for the Chord section

Split Point for the Voice

Synchro Start On/Off

The convenient Synchro Start function lets you start style or song playback by simply playing a key on the keyboard. Naturally, it should be set to on (standby) when you want to use it.

● Synchro Start — Style Playback (page 32)

Turn it on or off by pressing the [SYNC START] button in the STYLE CONTROL section. When Synchro Start is on, style playback behaves in two different ways, depending on the [ACMP] button status:

- When [ACMP] is off — Only the Rhythm part (channel) of the selected style starts as soon as you play any key on the keyboard.
- When [ACMP] is on — All parts of the selected style start as soon as you play a key/chord in the Chord section of the keyboard. (Playing in any other section does not start the style.)



● Synchro Start — Song Playback

To turn Synchro Start on or off, simultaneously hold down the [TOP] button and press the [START/STOP] button in the SONG CONTROL section. When Synchro Start is on, the song starts from the current position as soon as you play the keyboard.

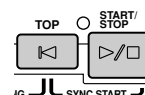

Function Tree

- **Button/Controller**Indicates the Button/Controller that you should use at first for entering the corresponding function. Numbers at the left end correspond to the ones in “Top panel & connections” on page 16.
- **LCD title**This appears at the top of the LCD display called up by operating the Button/Controller. “---” indicates that no LCD display is called up by operating the Button/Controller.
- **Function**Describes the function that can be executed on the LCD display called up by operating the Button/Controller. Describes the function of the Button/Controller itself if the LCD title is “---.”

	Button/Controller	LCD title	Function	Page
①	POWER ON/OFF switch	---	Turning the POWER on or off	22, 24
②	MASTER VOLUME control	---	Adjusting the overall volume	22
③	INPUT VOLUME control	---	Adjusting the microphone sound volume	46, 130
④	MIC buttons			
	[VOCAL HARMONY] button	---	Turning Vocal Harmony on or off	47, 130
	[TALK] button	---	Calling up the Talk Settings related to the microphone sound	132
	[EFFECT] button	---	Turning the effect for the microphone sound on or off	130
	[VH TYPE SELECT] button	VOCAL HARMONY TYPE	Selecting/producing the Vocal Harmony effect	47, 130
	[MIC SETTING] button	MICROPHONE SETTING		
		OVERALL SETTING	Setting microphone related parameters such as EQ, Noise Gate, and Compressor	132
		TALK SETTING	Setting the Talk Setting related parameters	132
⑤	SONG CONTROL buttons			
	[SP1] - [SP4] buttons	---	Entering Song Position Markers to the selected song and executing jumps among the Markers.	44, 91
	[LOOP] button	---	Turning looped playback (between Markers) on or off	44, 91
	[REC] button	(Pop-up window)	Recording a song	54
	[TOP] button	---	Going directly to the top measure of the selected song	43
	[START/STOP] button	---	Starting/stopping playback or recording of the selected song	43
	[REW] button	(Pop-up window)	Fast reverse of the song playback position	43, 91
	[FF] button	(Pop-up window)	Fast forward of the song playback position	43, 91
⑥	FADE IN/OUT buttons	---	Producing smooth fade-ins and fade-outs when starting and stopping the style/song	109
⑦	SONG buttons	SONG	The Open/Save display for songs	43, 66
⑧	STYLE buttons			
	[POP & ROCK] - [WORLD] button	STYLE	The Open/Save display of the category (path) that corresponds to the selected button	37, 111
	[PRESET] button	STYLE	Enabling selection of the style categories from the [POP & ROCK] - [WORLD] buttons, as printed on the panel	37, 111
	[USER/DISK] button	STYLE	Enabling selection of custom-entered categories from the [POP & ROCK] - [WORLD] buttons, as saved by user	37, 111
⑨	STYLE CONTROL buttons			
	[ACMP] button	---	Turning ACMP (Auto Accompaniment) on or off	32
	[OTS LINK] button	---	Turning the OTS Link function on or off	110
	[AUTO FILL IN] button	---	Turning the Auto Fill in on or off	35
	[INTRO] buttons	---	Playing the Intro sections of the selected style	34
	[MAIN VARIATION] buttons	---	Playing the Main sections of the selected style	34
	[BREAK] button	---	Playing the Break sections of the selected style	34
	[ENDING/rit.] button	---	Playing the Ending sections of the selected style	34
	[SYNC STOP] button	---	Turning Sync Stop on or off	110
	[SYNC START] button	---	Turning Sync Start on or off	32, 110
	[START/STOP] button	---	Starting/stopping style playback	33
⑩	METRONOME button	---	Starting/stopping the Metronome	156
⑪	TAP TEMPO button	---	Tapping out the tempo of the style playback	109
⑫	TEMPO button	(Pop-up window)	Changing the tempo of the Style/Multi Pad/Song playback	109
⑬	TRANPOSE button	(Pop-up window)	Transposing the pitch up or down	82
⑭	MULTI PAD CONTROL buttons			
	[1] - [4] buttons	---	Playing the Multi Pads	38, 124
	[STOP] button	---	Stopping the Multi Pad playback	38, 124

Button/Controller	LCD title	Function	Page	
15 MIXING CONSOLE button	MIXING CONSOLE		134	
	VOL/VOICE	Adjusting the volume and pan for each part and setting the Song Auto Revoice	135	
	FILTER	Adjusting the Harmonic content and Brightness for each part	135	
	TUNE	Adjusting the pitch related parameters for each part including the transpose setting	135	
	EFFECT	Adjusting the effect depth for each part and setting the Effect type/parameter for each block	136	
	EQ	Selecting/producing a Master EQ type and adjusting the EQ gain for each part	139	
	CMP	Selecting/producing a Master compressor type	140	
	LINE OUT	Line out settings for each part and for each instrument (key) of the drum voice	140	
16 BALANCE button	(Pop-up window)	Adjusting the volume balance among parts	36, 45	
17 CHANNEL ON/OFF button	(Pop-up window)	Turning each channel (part) of the selected song/style playback on or off	37, 45	
18 REGISTRATION MEMORY buttons	[REGIST BANK] button	REGISTRATION BANK	Open/Save display for Registration Memory Banks	52
	[FREEZE] button	---	Turning the Freeze function on or off	128
	[1] - [8] buttons	---	Recalling various panel settings	51
	[MEMORY] button	REGISTRATION MEMORY CONTENTS	Memorizing various panel settings to Registration Memory/One Touch Setting	51
19 DEMO button	DEMO	Demo song selection/playback	24	
20 HELP button	HELP	Viewing explanations of the TYROS features and selecting the language for the display messages	61	
21 FUNCTION button	MASTER TUNE/SCALE TUNE			
	MASTER TUNE	Setting the overall pitch of the TYROS	150	
	SCALE TUNE	Tuning each individual note of the octave	150	
	SONG SETTING	Setting the song playback related parameters, such as Guide function settings	92	
	STYLE SETTING/SPLIT POINT/CHORD FINGERING			
	STYLE SETTING/SPLIT POINT	Setting the style playback related parameters, such as Split Point settings	112	
	CHORD FINGERING	Selecting the way in which chords are played with your left hand	108	
	CONTROLLER			
	FOOT PEDAL	Assigning the foot pedal function	152	
	KEYBOARD/PANEL	Setting the keyboard related parameters, such as Initial Touch and Aftertouch	154	
	REGIST. SEQUENCE/FREEZE/VOICE SET			
	REGISTRATION SEQUENCE	Setting the Registration Memory Sequence	128	
	FREEZE	Specifying which settings are affected by the Freeze function	128	
	VOICE SET	Determining whether the preset settings are recalled or not when a new voice is selected	151	
	HARMONY/ECHO	Selecting a Harmony/Echo type and setting related parameters	39, 154	
	VIDEO OUT	Setting the display characteristics that are output to a television or video monitor connected to the [VIDEO OUT] jack	151	
	MIDI	Selecting a MIDI template	144	
	SYSTEM	MIDI system-related parameter settings	146	
	TRANSMIT	MIDI transmit channel settings	146	
	RECEIVE	MIDI receive channel settings	147	
	ROOT	MIDI chord root settings that determines whether or not the TYROS recognizes the received note event as the chord root for the style playback	148	
	CHORD DETECT	MIDI chord root settings that determines whether or not the TYROS recognizes the received note event as the chord type for the style playback	148	
	MFC10	Setting the parameters related to a connected optional MFC10	148	
	UTILITY			
	CONFIG 1	Setting various parameters such as the Fade In/Out and the metronome	156	
	CONFIG 2	Setting the parameter that determines whether the voice program change number will be indicated on the Open/Save display for voices and the parameter that determines whether the optionally installed speaker will sound or not.	156	
	DISK	Executing the disk related operations such as the Disk copy function and format	156	
OWNER	Executing operations such as registering your name to the TYROS	158		
SYSTEM RESET	Resetting the internal Flash ROM to the Factory Set	158		

Button/Controller	LCD title	Function	Page	
22 SOUND CREATOR button	SOUND CREATOR	Creating a User Voice	83, 85	
	COMMON	Setting values of various parameters called up when a User Voice is selected	86	
	CONTROLLER	Setting values of parameters related to the Modulation Wheel and After-touch for a User Voice	86	
	SOUND	Setting values of important sound-shaping parameters, such as Filter and EQ	87	
	EFFECT/EQ	Setting parameters of the Effect/EQ type called up when a User voice is selected	87	
	HARMONY	Setting values of harmony related parameters called up when a User voice is selected	87	
23 DIGITAL RECORDING button	SONG CREATOR	Creating a User Song	94	
	REC MODE	Setting parameters that determine how recording starts and stops, such as Punch In/Out settings	95	
	CHANNEL	Editing recorded song data for each part (channel)	96	
	CHD	Recording Chord data for the style playback using the Event List	98	
	1-16	Recording MIDI events for each channel using the Event List	100	
	SYS/EX.	Recording System Exclusive Messages using the Event List	106	
	LYRICS	Recording Lyrics data using the Event List	106	
	STYLE CREATOR	Creating a User Style	114	
	BASIC	Setting basic parameters such as beat, pattern length, section/part (channel) to be recorded	116	
	ASSEMBLY	Assembling an original style by combining existing rhythm patterns from other styles	118	
	GROOVE	Altering the timing for each section, velocity of notes for each channel	118	
	CHANNEL	Editing recorded style data for each part (channel)	120	
	PARAMETER	Editing various parameters related to the Style File Format	120	
	EDIT	Recording MIDI events for each channel using the Event List	117	
	MULTI PAD CREATOR	Creating a User Multi Pad	124	
	RECORD	Turning Repeat and Chord Match on or off, and recording a Multi Pad	124	
	EDIT	Recording MIDI events for each pad using the Event List	125	
24 PROGRAMMABLE MUSIC FINDER button	MUSIC FINDER	Selecting/Editing /Searching a Record of the Music Finder	40, 126	
25 PROGRAMMABLE ONE TOUCH SETTING buttons				
	[1] - [4]	---	Calling up various panel settings that match the selected style	36, 110
26 VOICE buttons	VOICE	Open/Save display for voices	26, 66	
27 PART SELECT buttons	---	Selecting a keyboard part from among four parts (RIGHT 1, 2, 3, LEFT)	78	
28 PART ON/OFF buttons	---	Turning each keyboard part (RIGHT 1, 2, 3, LEFT) on or off	74, 78	
29 VOICE EFFECT buttons				
	[HARMONY/ECHO] button	---	Turning Harmony/Echo on or off	39, 154
	[INITIAL TOUCH] button	---	Turning Initial Touch on or off	39, 81
	[SUSTAIN] button	---	Turning Sustain on or off	39, 81
	[POLY/MONO] button	---	Setting the selected keyboard part to Poly or Mono	39, 81
	[DSP] button	---	Setting the DSP effect of the selected keyboard part to on or off	39, 81
[DSP VARIATION] button	---	Setting the DSP effect variations of the selected keyboard part to on or off	39, 81	
30 UPPER OCTAVE buttons	---	Transposing Upper parts (RIGHT1 - 3) up or down by one octave	28	
31 GUIDE button	---	Turning the Guide function on or off	48	
32 PITCH BEND wheel	---	Bending notes played on the keyboard up or down	82	
33 MODULATION wheel	---	Applying a vibrato effect to notes played on the keyboard	82	

Voices and Keyboard Parts

As you know by now, the TYROS has a wide variety of musical instrument sounds, referred to as “voices.” And, as shown on page 74, the TYROS allows you to independently select and play up to four voice parts at the same time in a number of ways. Any voice can be assigned to any part. Since there are four different parts, be careful to confirm which parts are selected, and make sure not to confuse one part for another as you select voices for them. See below for details on confirming the currently selected part, and instructions on selecting parts.

You can confirm the currently selected part by checking which lamp of the [PART SELECT] buttons lights. To select the desired keyboard part, press the corresponding part button.

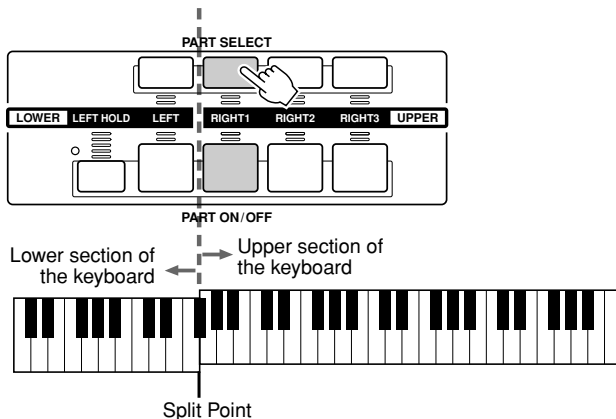

If you want to turn only a specified part on, press the corresponding LCD button from the Main display.

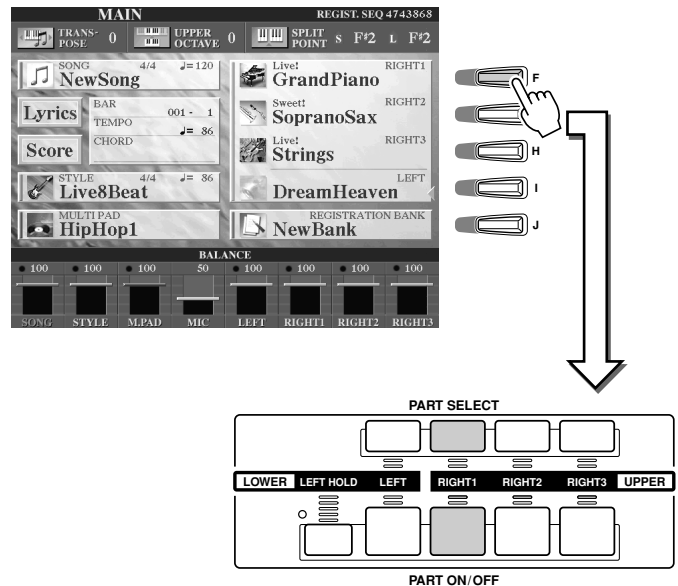

■ Note names of the keyboard

Each key has a note name; for example, the lowest (farthest left) key on the keyboard corresponds to C1 and the highest (farthest right) key to C6.

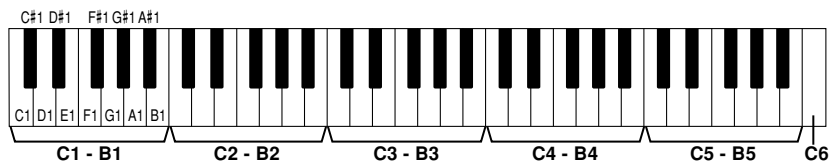

■ Left Hold

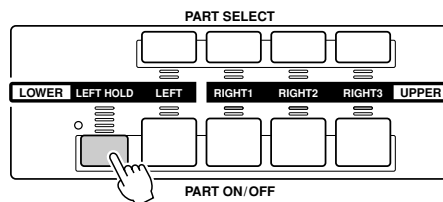

This function causes the LEFT part voice to be held even when the keys are released. Non-decaying voices such as strings are held continuously, while decay-type voices such as piano decay more slowly (as if the sustain pedal has been pressed). This function is especially effective when used with style playback. For example, if you play and release a chord in the Chord section of the keyboard (with the Left part on and the Left voice set to Strings), the strings part sustains, adding a natural richness to the overall accompaniment sound.

Voice Types

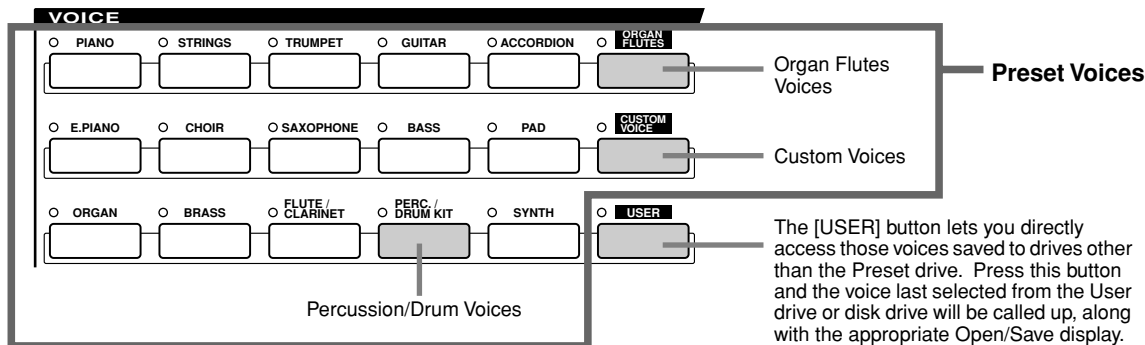

The buttons of the VOICE section (excepting USER) are used to call up the relevant voice selection (Open/Save) display for the Preset drive. Pressing one of the buttons calls up the voice selection display corresponding to the selected category, and the last selected voice in the category is automatically called up. Five of these voice categories (below) are slightly different from the others and deserve special explanation.

Organ Flutes Voices.....

Press the [ORGAN FLUTES] button to call up the Open/Save display for selecting among the special organ voices. You can also use the Sound Creator features to create your own original organ sounds.

Just as on a traditional organ, you can create your own sounds by adjusting the levels of the flute footages.

Percussion/Drum Kit Voices.....

When one of the Drum Kit or SFX Kit voices in the [PERC./DRUM] group is selected, you can play various drums and percussion instruments or SFX (sound effects) sounds on the keyboard. The drum and percussion instruments played by the various keys are marked by symbols below the keys. Some of the instruments in the different drum kit voices sound different even though they have the same name, while others are essentially the same.

See the separate Data List for a complete listing of the Drum Kit and SFX Kit assignments.

When "Standard Kit 1" is selected:

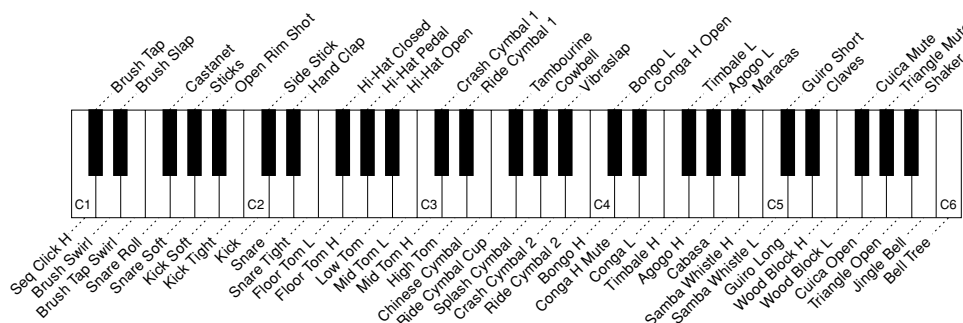

NOTE

- The Transpose functions (page 82) do not affect the Drum Kit or SFX Kit voices.

GM&XG Voices and GM2 Voices.....

You can select the GM/XG/GM2 voices (page 8) directly via panel operations. Press one of the VOICE buttons to call up the Open/Save display for voices, then press the [UP] LCD button (lower [8] buttons) and call up the P2 page containing the "GM&XG" folder and the "GM2" folder.

Custom Voices.....

Normally, data cannot be stored to the Preset drive; however, voice data created with the Voice Editor software (pages 59, 85) can be saved to the Preset drive as Custom Voice data. Custom Voices saved to the Preset drive can be called up via the [CUSTOM VOICE] button.

■ Mega Voices

These specially programmed voices are not indicated among the VOICE buttons on the panel. In fact, they are not even intended to be played from the TYROS keyboard. The Mega voices are primarily designed for use with recorded MIDI sequence data (such as songs and styles). Some of the guitar and bass voices in particular have been created as Mega voices for the TYROS, and are easily distinguished from the normal voices by their icons in the Open/Save displays. What makes Mega voices special is their use of velocity switching. Normal voices use velocity switching, too — to make the sound quality and/or level of a voice according to how strongly or softly you play it. This makes the TYROS voices sound authentic and natural. However, with Mega voices, each velocity range (the measure of your playing strength) has a completely different sound.

For example, a Mega guitar voice includes the sounds of various performance techniques (as shown below). In conventional instruments, different voices having those sounds would be called up via MIDI and played in combination to achieve the desired effect. However, now with Mega voices, a convincing guitar part can be played with just a single voice, using specific velocity values to play the desired sounds.

Because of the complex nature of these voices and the precise velocities need to play the sounds, they're not intended for playing from the keyboard. They are, however, very useful and convenient when creating MIDI data — especially when you want to avoid using several different voices just for a single instrument part.

● Example Mega Voice — Guitar

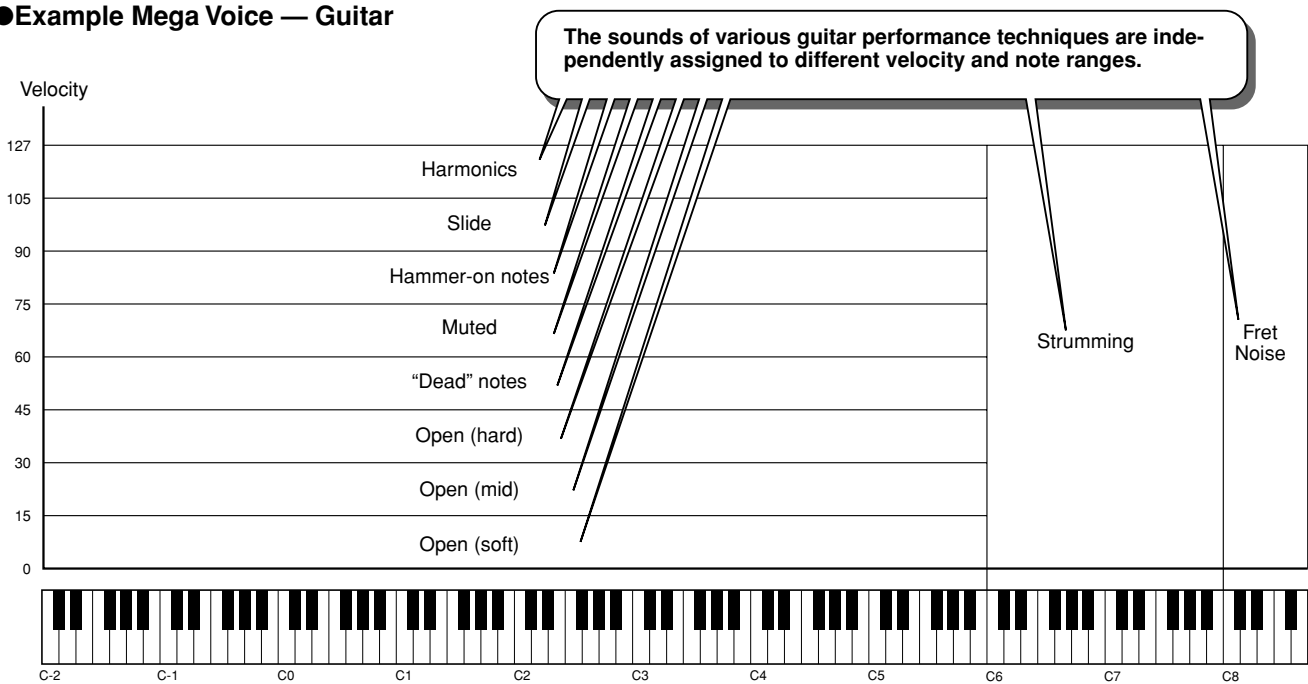

Sound maps for the TYROS' Mega voices (like the one above) are given in the separate Data List booklet. Take full advantage of the Mega voices and refer to these maps when creating MIDI sequence data for songs, styles, and Multi Pads.

NOTE

Since the Mega voices are fundamentally different from the other voices of the TYROS, you should keep in mind the following points and precautions when working with them.

Unexpected or undesired sounds may result depending on the settings or conditions below:

- Initial Touch setting in the [FUNCTION] → CONTROLLER → KEYBOARD/PANEL display (page 154)
- Harmony/Echo settings in the [FUNCTION] → HARMONY/ECHO display (page 154)
- Touch sensitivity-related settings in the Sound Creator (page 86)
- Playing keys in the left-hand Chord sections when Stop Accompaniment (page 112) is set to "STYLE."

Unexpected or undesired sounds may result depending on the settings below, when editing or creating data for songs, styles, and Multi Pads:

- When selecting a Mega voice from the Revoice display of a style (page 37).
- When changing the velocity values of several notes at once in the Event List displays of song, style, or Multi Pad (page 100).
- When changing the velocity values of several notes at once with the Velocity Change function (page 120) and the Dynamics function (page 118) in the Style Creator function.
- When changing the note numbers of several specified channels at once with the Channel Transpose function (page 97) in the Song Creator function.

Mega voices are unique to the TYROS and are not compatible with other models. Any song/style/Multi Pad data you've created on the TYROS using the Mega voices will not sound properly when played back on other instruments.

Maximum Polyphony

The TYROS features a maximum polyphony of 128 notes. Since style playback uses a number of the available notes, the full 128 notes will not be available on the keyboard when a style is played back. The same applies to the Voice RIGHT1, RIGHT2, RIGHT3, LEFT, Multi Pad, and Song functions. When the maximum polyphony is exceeded, notes are played using last-note priority.

Voice Effects

Quick Guide on page 39 ➔

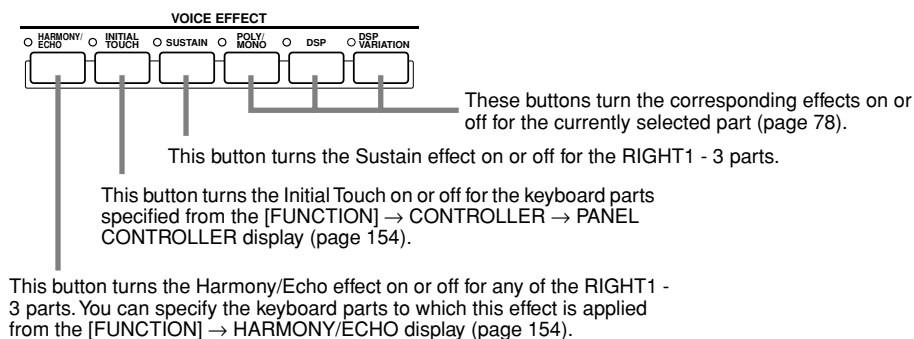

■ Harmony/Echo

See page 39 in “Quick Guide” and page 154 in “Reference.”

■ Initial Touch

The keyboard of the TYROS is equipped with a touch response feature that lets you dynamically and expressively control the level of the voices with your playing strength — just as on an acoustic instrument. There are two types of touch response on the TYROS keyboard (described below): Initial Touch and Aftertouch. Initial Touch can be turned on or off from the panel.

Two types of touch response equipped with the keyboard of the TYROS

● Initial Touch

With this function, the TYROS senses how strongly or softly you play the keys, and uses that playing strength to affect the sound in various ways, depending on the selected voice. This allows you to play with greater expressiveness and add effects with your playing technique.

You can set the keyboard parts to which Initial Touch is applied from the [FUNCTION] → CONTROLLER → PANEL CONTROLLER display (page 154).

● Aftertouch

With this function, the TYROS senses how much pressure you apply to the keys while playing, and uses that pressure to affect the sound in various ways, depending on the selected voice. This also gives you more expressive control over the sound and effects.

You can set the keyboard parts to which Aftertouch is applied from the [FUNCTION] → CONTROLLER → PANEL CONTROLLER display (page 154).

The default settings for Aftertouch and how it affects a voice can be changed from the Sound Creator function (page 85) and saved along with a User voice.

■ Sustain

When this feature is ON, all notes played on the upper section of the keyboard (RIGHT1 - 3 parts) have a longer sustain. The Sustain level for each voice can be adjusted via the Sound Creator function (page 85) and can be saved as a User voice.

■ Poly/Mono

This determines whether the part's voice is played monophonically (only one note at a time) or polyphonically. When this is set to “MONO,” the Portamento effect can be controlled (depending on the selected voice) by playing legato.

The Poly/Mono setting and the degree of the Portamento effect (Portamento Time) are pre-programmed for each voice. These can be changed via the Sound Creator function (page 86) and saved as a User voice. Portamento Time can also be adjusted from the Mixing Console (page 134).

■ DSP and DSP Variation

With the digital effects built into the TYROS you can add ambience and depth to your music in a variety of ways — such as adding reverb that makes you sound like you are playing in a concert hall.

- The [DSP] button turns the DSP (Digital Signal Processor) effect on or off for the currently selected keyboard part.
- The [DSP VARIATION] button lets you switch between two variations of the DSP effect. You could use this while you play, for example, to change the rotating speed (slow/fast) of the rotary speaker effect.

Changing Pitch on the TYROS

The TYROS has a variety of pitch-related controls and functions, as described below.

■ PITCH BEND Wheel.....

Use the TYROS PITCH BEND wheel to bend notes up (roll the wheel away from you) or down (roll the wheel toward you) while playing the keyboard. The Pitch Bend is applied to all the keyboard parts (RIGHT1 - 3 and LEFT). The PITCH BEND wheel is self-centering and will automatically return to normal pitch when released.

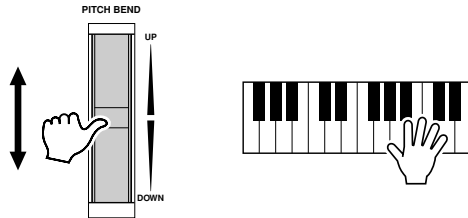

NOTE

- The maximum pitch bend range can be changed on the MIXING CONSOLE display (page 135).
- If the Pitch Bend range is set to more than 1200 cents (1 octave) via MIDI, the pitch of some voices may not be raised or lowered completely.

■ MODULATION Wheel

The Modulation function applies a vibrato effect to notes played on the keyboard. This is applied to all the keyboard parts (RIGHT1 - 3 and LEFT).

Moving the MODULATION wheel down (towards MIN) decreases the depth of the effect, while moving it up (towards MAX) increases it.

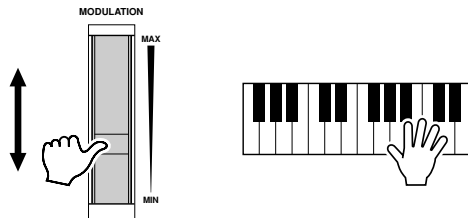

NOTE

- To avoid accidentally applying modulation, make sure the MODULATION Wheel is set at MIN before you start playing.
- The MODULATION Wheel can be set to control a different parameter other than vibrato (page 86).

■ Transpose

With this function, you can transpose the pitch of the TYROS up or down over a range of ± 2 octaves in semitone steps. Three transposing methods (Keyboard, Song, and Master) are available; select the desired method in the [FUNCTION] → CONTROLLER → KEYBOARD/PANEL display (page 154), then use the [TRANSCOPE] buttons to change the value.

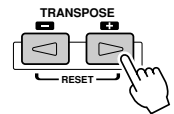

● Keyboard Transpose

The [TRANSCOPE] buttons affect the pitch of the keyboard sound, the style playback pitch, and the pitch of the Multi Pads for which Chord Match has been set to on. Note that the transposition is applied from the next note (or style chord) played, after one of the [TRANSCOPE] buttons has been pressed.

● Song Transpose

The [TRANSCOPE] buttons affect only song playback.

Note that the transposition is applied from the next note of song playback after one of the [TRANSCOPE] buttons has been pressed.

● Master Transpose

The [TRANSCOPE] buttons affect the overall pitch of the TYROS.

Normal pitch (transpose value of "0") can be recalled at any time by pressing both the [+] and [-] buttons simultaneously.

The transposition can be adjusted from the Mixing Console display (page 135).

■ Upper Octave.....

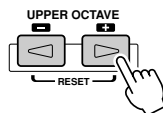

See page 28 in "Quick Guide."

Organ Flutes (Sound Creator)

Quick Guide on page 29 →

The TYROS features a variety of lush, dynamic organ voices that you can call up with the [ORGAN FLUTES] button. It also gives you the tools to create your own original organ sounds by using the Sound Creator (called up with the [SOUND CREATOR] button).

Just as on a traditional organ, you can create your own sounds by adjusting the levels of the flute footages.

Basic Procedure (Organ Flutes)

1 Press the [ORGAN FLUTES] button to call up the Open/Save display for organ voices.

2 Press the [SOUND CREATOR] button to call up the Sound Creator display.

3 Select the desired menu with the [BACK]/[NEXT] buttons and set the appropriate parameters.

4 Press the [SAVE] LCD button to call up the Open/Save display of the User drive and save the settings here as a User voice to the drive. For details, see page 69.

The [1] LCD buttons are used to adjust either the 16' or 5-1/3' footages. Select the desired footage here, then adjust it with the [1] LCD buttons.

Adjust the footage.

CAUTION
If you select another voice without saving the settings, the settings will be lost. If you wish to store the settings here, make sure to save the settings as a User Voice before selecting another voice or turning the power off.

Sound Creator Parameters (Organ Flutes Voices)

The Organ Flutes parameters are organized into three different pages, and can be set as described in step #3 of the “Basic Procedure” above. These can also be programmed as part of the Voice Set parameters (page 151), to be automatically called up when the voice is selected.

FOOTAGE

ORGAN TYPE	This LCD button specifies the type of organ tone generation to be simulated: Sine or Vintage.
ROTARY SP SPEED	This LCD button alternately switches between the slow and fast rotary speaker speeds when a rotary speaker effect is selected for the Organ Flutes (see “DSP Type” below), and the VOICE EFFECT [DSP] button is turned on (this LCD button has the same effect as the VOICE EFFECT [VARIATION] button).
VIBRATO ON/OFF	This LCD button alternately turns the vibrato effect for the Organ Flutes voice ON or OFF.
VIBRATO DEPTH	This LCD button sets the Vibrato depth to one of three levels: 1 (low), 2 (mid), or 3 (high).
16' - 1' (Footage)	These LCD buttons determine the basic sound of the organ flutes. The term “footage” is a reference to the sound generation of traditional pipe organs, in which the sound is produced by pipes of different lengths (in feet). The longer the pipe, the lower the pitch of the sound. Hence, the 16' setting determines the lowest pitched component of the voice, while the 1' setting determines the highest pitched component. The higher the value of the setting, the greater the volume of the corresponding footage. Mixing various volumes of the footages lets you create your own distinctive organ sounds.

■ VOL/ATTACK

VOL (Volume)	Adjusts the overall volume of the Organ Flutes. The longer the graphic bar, the greater the volume.
RESP (Response)	Affects both the attack and release (page 87) portion of the sound, increasing or decreasing the response time of the initial swell and release, based on the FOOTAGE controls. The higher the value, the slower the swell and release.
VIBRATO SPEED	Determines the speed of the vibrato effect controlled by the Vibrato On/Off and Vibrato Depth above.
MODE	The MODE control selects between two modes: FIRST and EACH. In the FIRST mode, attack is applied only to the first notes played and held simultaneously; while the first notes are held, any subsequently played notes have no attack applied. In the EACH mode, attack is applied equally to all notes.
4', 2 2/3', 2'	These determine the attack sound volume of the ORGAN FLUTE voice. The 4', 2 2/3' and 2' controls increase or reduce the volume of attack sound at the corresponding footages. The longer the graphic bar, the greater the attack sound volume.
LENG (Length)	Affects the attack portion of the sound producing a longer or shorter decay immediately after the initial attack. The longer the graphic bar, the longer the decay.

■ EFFECT/EQ

REVERB DEPTH	See "Effect" on page 136.
CHORUS DEPTH	See "Effect" on page 136.
DSP DEPTH	See "Effect" on page 136.
DSP ON/OFF	See "Effect" on page 136.
DSP TYPE	Determines the DSP effect type to be applied to the Organ Flutes voice by selecting a Category and a type. If any other effect type than "Rotary Speaker" is selected, the [ROTARY SP SPEED] LCD button in the FOOTAGE page will not control rotary speaker speed. Instead, it will have the same effect as the VOICE EFFECT [DSP VARIATION] button.
VARIATION	<p>ON/OFF Turns the DSP Variation on or off for the selected organ voice.</p> <p>PARAMETER Indicates the parameter to which the variation is applied depending on the selected DSP type.</p> <p>VALUE Adjusts the degree of the DSP variation parameter.</p>
EQ LOW/HIGH	These determine the Frequency and Gain of the Low and High EQ bands.

Voice Creating (Sound Creator)

The TYROS has a Sound Creator feature that allows you to create your own voices by editing some parameters of the existing voices. Once you've created a voice, you can save it as a User voice to the User drive or Disk drive for future recall.

User Voices and Custom Voices

On the TYROS, you can create your own original voices (by editing the built-in Preset voices) in one of two ways. This section shows you how to create voices with the Sound Creator function.

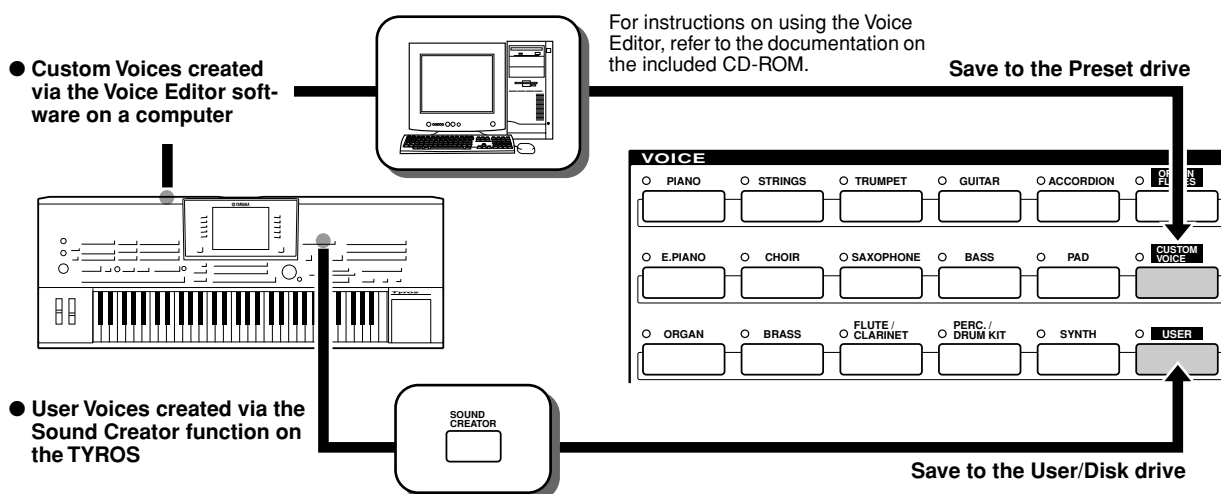

Basic Procedure (Sound Creator)

1 Select the desired voice (other than an Organ Flutes voice).

2 Press the [SOUND CREATOR] button to call up the Sound Creator display.

You can compare the sound of the original (unedited) voice with the edited voice.

3 Select the desired menu with the [BACK]/[NEXT] buttons and set the appropriate parameters.

4 Press the [SAVE] LCD button to call up the Open/Save display of the User drive and save the settings here as a User voice to the drive. For details, see page 69.

NOTE

- User voices can also be created by editing Custom voices (created on a computer). You can also edit any previously created User voice to make a new voice.

SOUND CREATOR [REGULAR VOICE]: Strings1

COMMON CONTROLLER SOUND EFFECT/EQ HARMONY

VOLUME:79	TOUCH SENSE:64
1 PART OCTAVE RIGHT1/RIGHT2/RIGHT3:0	LEFT:1
MONO/POLY:POLY	PORTAMENTO TIME:10

COM-PARE SAVE

VOLUME TOUCH SENSE PART OCTAVE MONO/POLY PORTAMENTO TIME

79 64 1 0 10

CAUTION

If you select another voice without saving the settings, the settings will be lost. If you wish to store the settings here, make sure to save the settings as a User Voice before selecting another voice or turning the power off.

Sound Creator Parameters (Normal Voices)

The Sound Creator parameters are organized into five different pages, and can be set as described in step #3 of the “Basic Procedure” above. These can also be programmed as part of the Voice Set parameters (page 151), to be automatically called up when the voice is selected.

Keep in mind that these parameters do not apply to the Organ Flutes voices, which have their own set of parameters (page 83).

■ COMMON

VOLUME	Determines the volume of the current edited voice.
TOUCH SENSE	Determines the touch sensitivity, or how greatly the volume responds to your playing strength. A setting of “0” produces more extreme drops in level, the more softly you play, while a setting of “64” is normal response, and “127” produces high volume for any playing strength (fixed).
OCTAVE	Shifts the octave range of the edited voice up or down in octaves. When the edited voice is used as any of the RIGHT1 - 3 parts, the R1/R2/R3 parameter is available; when the edited voice is used as the LEFT part, the LEFT parameter is available.
MONO/POLY	Determines whether the edited voice is played monophonically or polyphonically (page 81).
PORTAMENTO TIME	Sets the portamento time when the edited voice is set to “MONO” above.

■ CONTROLLER

● MODULATION

The Modulation Wheel can be used to modulate the parameters below as well as the pitch (vibrato). Here, you can set the degree to which the Modulation wheel modulates each of the following parameters.

FILTER	Determines the degree to which the Modulation Wheel modulates the Filter Cutoff Frequency. See next page for details about Filter.
AMPLITUDE	Determines the degree to which the Modulation Wheel modulates the amplitude (volume).
LFO PMOD	Determines the degree to which the Modulation Wheel modulates the pitch, or the vibrato effect.
LFO FMOD	Determines the degree to which the Modulation Wheel modulates the Filter modulation, or the wah effect.
LFO AMOD	Determines the degree to which the Modulation Wheel modulates the amplitude, or the tremolo effect.

● AFTERTOUCH

Aftersustain can be used to modulate the parameters below. Here, you can set the degree to which Aftersustain modulates each of the following parameters.

FILTER	Determines the degree to which Aftersustain modulates the Filter Cutoff Frequency. See next page for details about Filter.
AMPLITUDE	Determines the degree to which Aftersustain modulates the amplitude (volume).
LFO PMOD	Determines the degree to which Aftersustain modulates the pitch, or the vibrato effect.
LFO FMOD	Determines the degree to which Aftersustain modulates the Filter modulation, or the wah effect.
LFO AMOD	Determines the degree to which Aftersustain modulates the amplitude, or the tremolo effect.

■ SOUND

● FILTER

Filter is a processor that changes the timbre or tone of a sound by either blocking or passing a specific frequency range. The parameters below determine the overall timbre of the sound by boosting or cutting a certain frequency range. In addition to making the sound either brighter or more mellow, Filter can be used to produce electronic, synthesizer-like effects.

BRIGHTNESS	Determines the cutoff frequency or effective frequency range of the filter (see diagram). Higher values result in a brighter sound.
HARMONIC CONTENT	<p>Determines the emphasis given to the cutoff frequency (resonance), set in BRIGHTNESS above (see diagram). Higher values result in a more pronounced effect.</p> <p>The left graph shows Volume on the y-axis and Frequency (pitch) on the x-axis. A solid line represents the filter response, which is flat until a 'Cutoff Frequency' and then drops off. A dashed line shows the response with a resonance peak at the cutoff frequency. A horizontal double-headed arrow indicates the 'Cutoff range'. Below the x-axis, a shaded area is labeled 'These frequencies are "passed" by the filter.' The right graph shows a similar setup but with a more pronounced resonance peak at the cutoff frequency, labeled 'Resonance'.</p>

● EG (Envelope Generator)

The EG (Envelope Generator) settings determine how the level of the sound changes in time. This lets you reproduce many sound characteristics of natural acoustic instruments — such as the quick attack and decay of percussion sounds, or the long release of a sustained piano tone.

ATTACK	Determines how quickly the sound reaches its maximum level after the key is played. The higher the value, the slower the attack.
DECAY	Determines how quickly the sound reaches its sustain level (a slightly lower level than maximum). The higher the value, the slower the decay.
RELEASE	<p>Determines how quickly the sound decays to silence after the key is released. The higher the value, the slower the release.</p> <p>The graph shows Level on the y-axis and Time on the x-axis. The envelope starts at 'Key on' (indicated by a hand icon) and rises linearly through the 'ATTACK' phase to a peak. It then falls linearly through the 'DECAY' phase to a 'Sustain Level'. It remains at this level until 'Key off' (indicated by a hand icon), after which it falls linearly through the 'RELEASE' phase to zero.</p>

● VIBRATO

DEPTH	Determines the intensity of the Vibrato effect (see diagram). Higher settings result in a more pronounced Vibrato.
SPEED	Determines the speed of the Vibrato effect (see diagram).
DELAY	<p>Determines the amount of time that elapses between the playing of a key and the start of the Vibrato effect (see diagram). Higher settings increase the delay of the Vibrato onset.</p> <p>The graph shows Level on the y-axis and Time on the x-axis. The signal remains flat until a 'DELAY' period. Then, it oscillates sinusoidally. The 'SPEED' is the time between two consecutive peaks, and the 'DEPTH' is the vertical distance between a peak and a trough.</p>

■ EFFECT/EQ

Same as in “Organ Flutes” on page 84, with the exception of the PANEL SUSTAIN parameter, which determines the sustain level applied to the edited voice when turning the [SUSTAIN] button in the VOICE EFFECT section on.

■ HARMONY

Same as in the [FUNCTION] → HARMONY/ECHO display. See page 154.

Song Playback

Quick Guide on page 43 ➔

The song playback features of the TYROS let you play MIDI song (sequence) data. This includes commercially available song data on floppy disk (GM- or XG-compatible), and performances you've recorded yourself with the Song Recording features (page 54) and saved to one of the drives. In addition, the TYROS can display music notation and lyrics, and you can use the sophisticated Guide functions to practice the keyboard and your singing as well. This section explains detailed settings about song playback that are not covered in "Quick Guide."

Displaying Music Notation

To view the music notation of the selected song, press the [Score] LCD button on the Main display. This lets you read the music while the song plays back. That's not all, though; there's much more you can do:

- Read the score while the song is stopped and practice it on your own.
- Use the notation to practice playing just the melody part, while the accompaniment provides the backing. Simply turn off the right-hand part (channel) from the display.
- If the song has lyric data, you can read the lyrics from the display and sing along while the song plays. Connect a microphone and you can even have your voice mixed with the song as it plays.
- With the sophisticated Guide features, you can let the TYROS "teach" you how to play the song properly — and even how to sing it with the correct pitches.

Basic Procedure (Score)

1 Select a song.

2 Go back to the Main display and press the [Score] LCD button.



3 As the song plays back, a red "ball" bounces along through the score, indicating the current position.

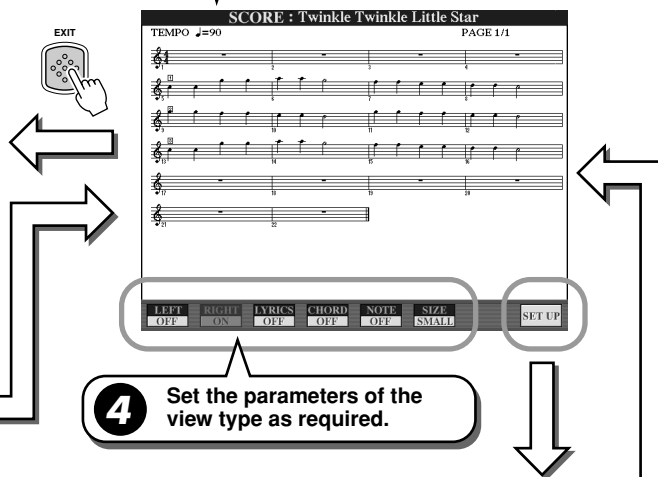

4 Set the parameters of the view type as required.

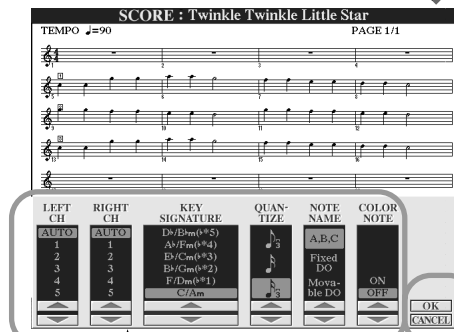

5 Set the detailed parameters of the view type as required.

NOTE

- The displayed notation is generated by the TYROS based on the song MIDI data. As a result, it may not be exactly the same as commercially available sheet music of the same song — especially when displaying notation of complicated passages or many short notes.
- Some song data has been recorded with special "free tempo" settings. For such song data, the tempo, beat, measure and music notation will not be displayed correctly.
- If all of the notes in a certain measure cannot fit in one line, the measure is extended to the next line.
- The notation functions cannot be used to create song data by inputting notes. For information on creating song data, see page 100.
- You can increase the number of measures that will be displayed by decreasing the other items to be displayed (parts, lyrics, chords, etc.).

■ Notation View parameters (Step #4 on the previous page)

LEFT	Enables/disables display of the left-hand key range. Depending on other settings, this parameter may be unavailable and may appear grayed out. If this is the case, go to the detailed setting display (described below; step #4 on the previous page) and set the LEFT CH. parameter below to any channel except "AUTO." Or, go to the [FUNCTION] → SONG SETTING display (page 92) and set the LEFT parameter to any channel except "OFF." RIGHT (next parameter) and LEFT cannot be turned off at the same time.
RIGHT	Enables/disables display of the right-hand key range. Channel 1 is automatically selected when the LEFT CH. parameter below is set to any channel except "AUTO" or [RIGHT] is set to [OFF] from the [FUNCTION] → SONG SETTING display (page 92). RIGHT and LEFT (above) cannot be turned off at the same time.
LYRICS	Enables/disables display of the lyrics. If the selected song does not contain lyric data, lyrics are not displayed.
CHORD	Enables/disables display of the chords. If the selected song does not contain chord data, chords are not displayed.
NOTE	Enables/disables display of the note name (pitch). The note name is indicated at the left of the note. When the space between the notes is too small, the indication may be moved to the top left of the note.
SIZE	Determines the display resolution (or zoom level) of the notation.

■ Notation View detailed parameters (Step #5 on the previous page)

LEFT CH (channel)/RIGHT CH (channel)	Determines which MIDI channel in the song data is used for the left-hand/right-hand part. This setting returns to AUTO when a different song is selected. AUTO The MIDI channels in the song data for the right- and left-hand parts are assigned automatically — setting the parts to the same channel as the channel which is specified in the [FUNCTION] → SONG SETTING display (page 92). 1-16 Assigns the specified MIDI channel (1 - 16) to each of the left- and right-hand parts. OFF (LEFT CH only) No channel assignment – this disables display of the left-hand key range.
KEY SIGNATURE	This lets you enter key signature changes in the middle of a song, at the stopped position. This menu is useful when the selected song contains no key signature settings for displaying notation.
QUANTIZE	This gives you control over the note resolution in the notation, letting you shift or correct the timing of all displayed notes so that they line up to a particular note value. Make sure to select the smallest note value which is used in the song.
NOTE NAME	Selects the type of the note name indicated at the left of the note in the notation from among the following three types. The settings here are available when the NOTE parameter above is set to ON. A, B, C Note names are indicated as letters (C, D, E, F, G, A, B). FIXED DO Note names are indicated in solfeggio and differ depending on the selected language (page 61). English Do Re Mi Fa Sol La Ti Japanese..... ド レ ミ ファ ソ ラ シ German Do Re Mi Fa Sol La Si French Ut Re Mi Fa Sol La Si Spanish Do Re Mi Fa Sol La Si Italian..... Do Re Mi Fa Sol La Si MOVABLE DO Note names are indicated in solfeggio according to the scale intervals, and as such are relative to the key. The root note is indicated as Do. For example, in the key of G major the root note of Sol would be indicated as Do. As with "Fixed Do," the indication differs depending on the selected language.
COLOR NOTE	When this is set to ON, the notes in the display appear in color (C: red, D: yellow, E: green, F: orange, G: blue, A: purple, and B: white).

Displaying Lyrics

If the selected song has lyric data, you can have the lyrics shown in the display by pressing the [Lyrics] LCD button in the Main display. The Lyrics feature offers a number of useful possibilities:

- The phrases to be sung are highlighted in time with the music, making it easy to follow the words and sing along with the song. Connect a microphone and you can even have your voice mixed with the song accompaniment as it plays.
- Connect an external TV monitor to the TYROS, and you can have the lyrics displayed on the TV — for group sing-alongs and the like. You can even set the TYROS so that the lyrics are shown on the TV monitor while the LCD of the instrument displays a different operation or function. (Select [FUNCTION] → VIDEO OUT.)

Basic Procedure (Lyrics)

1 Select a song.

2 Go back to the Main display and press the [Lyrics] LCD button.

3 As the song plays back, the lyrics are shown in succession in the LCD display.

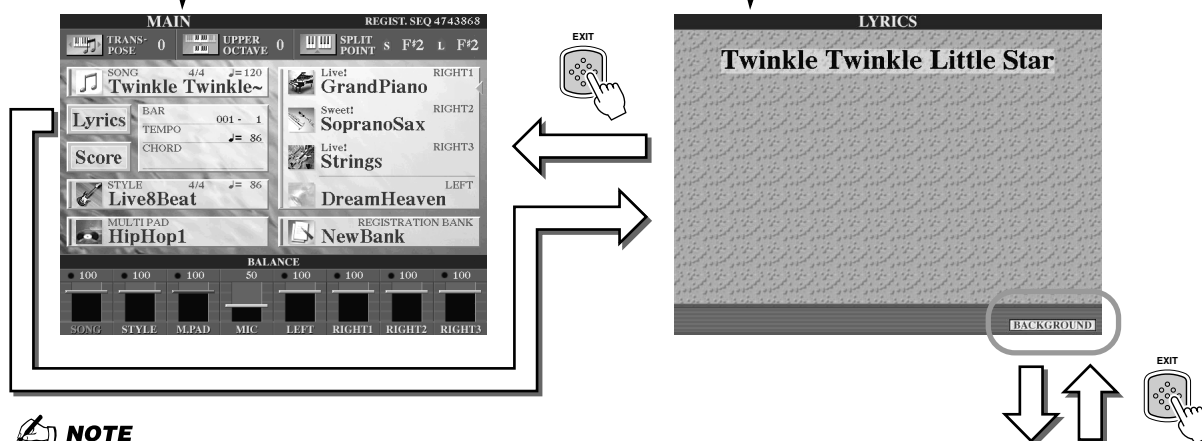

NOTE

- The language used for lyrics display depends on the particular lyric data. If the lyrics are garbled or unreadable, you can remedy this by changing the "LYRICS LANGUAGE" setting from the [FUNCTION] → SONG SETTING display.
- When the background color is specified in the song data, the BACKGROUND setting cannot be changed.
- If the selected song does not contain lyric data, lyrics are not displayed.
- If the selected song contains chord data, chord names are displayed with the lyrics.

You can change the background picture of the Lyrics display. Press the [BACKGROUND] LCD button to call up the Open/Save display for picture files and select the desired one. Press the [EXIT] button to return back to the Lyrics display.

Displaying the Lyrics on the external TV monitor

- 1** Connect the TV monitor to the VIDEO OUT terminal of the TYROS (page 18).
- 2** Turn the TV monitor and the TYROS ON.
- 3** Set the SCREEN CONTENT parameter to "LYRICS" on the [FUNCTION] → VIDEO OUT display (page 151).

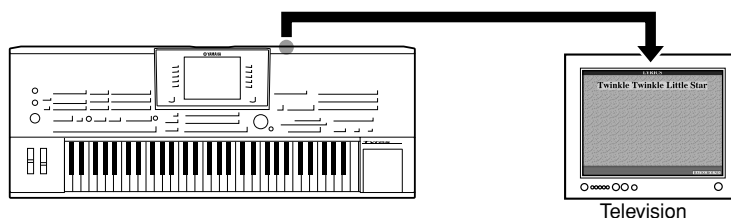

When the SCREEN CONTENT parameter is set to "LYRICS," only the lyrics of the song are output via VIDEO OUT, regardless of the display that is called up on the instrument itself. This lets you select other displays and still have the lyrics shown on the external monitor.

- 4** Play the song by following the Basic Procedure (Lyrics) above.

Song Position

The TYROS provides the following song position features.

- The current song position is indicated on the Main display as measure/beat number during playback — letting you easily see where you are in the song.
- Pressing the [FF] or [REW] button automatically calls up a pop-up window showing the current measure number (or Phrase Mark number) in the Main display.

Indicates the current measure in song playback.



This menu appears only when the song data contains Phrase Marks.

This determines which is used for song position, Bar (measure) or Phrase Mark. When this is set to "PHRASE MARK," you can use the [FF] or [REW] buttons to navigate through the Phrase Marks in the song.

- You can put Song Position markers in the song data using the [SP1] - [SP4] buttons (page 44). This not only lets you navigate quickly and easily through a song, but also lets you set up convenient playback loops.

■ Song Position Marker

This section covers two additional Marker-related features and details. For basic information on using the Markers for jump playback and loop playback, refer to page 44 in the Quick Guide.

● Jump Markers

The Markers explained in the Quick Guide on page 44 are also called "Jump Markers." They can be set in the song data by pressing the [SP1] - [SP4] buttons. In the Event List display of the Song Creator (page 106), they are indicated as "SPJ-01" - "SPJ-04." In the Event List, they can be moved freely to other positions and can even be copied to create identical Marker numbers at other positions. When the same Marker number is contained at different locations in the song, the latest occurring one is used as an Loop End Marker (below).

● Loop End Marker

Loop End Markers can be used for putting additional Markers in song data, providing even greater versatility. Creating a Loop End Marker is done within the Event List (and not with the [SP1] - [SP4] buttons on the panel), by simply copying one "SPJ" Jump Marker event to another position in the song.

For basic information on loop playback between successive Jump Markers, refer to page 44 in the Quick Guide.

The examples below show how Loop End Markers can be used in song playback.

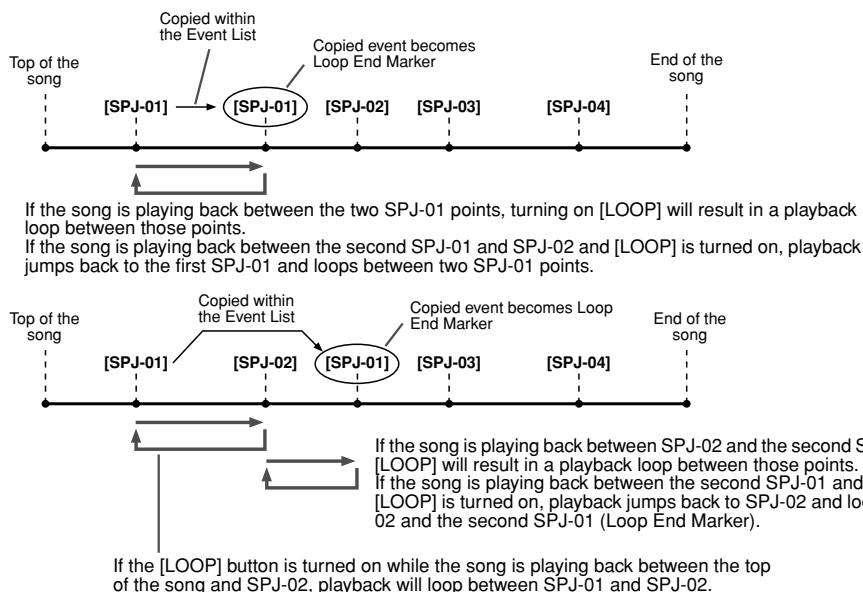

NOTE

- Loop playback problems may occur if successive Markers are too close to one another.
- When the effect settings of the jump destination (the position you're jumping to) differ from those at the jump source, glitches or drop-outs in the sound may result. This is because of limitations in the effect processors of the TYROS.
- When using the Guide function (the [GUIDE] lamp is on) with jump playback, keep in mind that the Guide indication may not be able to stay in time with the jumps.

In the examples above, the actual data of the Loop End Marker is identical to the event it was copied from — only the location of the copied Marker provides it with this different function.

In song playback, the markers formatted as "SPJ-xxxxx" (xxxxx: any character except 01 - 04 and any number of letters is OK) are handled as Loop End Markers. Since the Event List in the Song Creator function does not let you freely name Markers, the instructions above are recommended for creating new Markers. However, with sequence software on a computer, you can create new Markers and assign appropriate names to them. By naming Markers in this way, you can easily distinguish between Loop End Markers and Jump Markers in the Event List.

Song Playback Related Parameters

The TYROS has a variety of song playback functions — which can be accessed by pressing [FUNCTION] → SONG SETTING.

- Listen to (or practice along with) your favorite song repeatedly — with Repeat Playback.
- Play back all of the songs in a particular folder — repeatedly or at random — for your listening pleasure.
- Play back all of the songs in all of the folders. Each of the SONG [I] - [VI] buttons has wealth of songs — put them all together and you've got a lot of music you can play repeatedly or at random.

If you want, you can interrupt this automatic jukebox at any time and select a song for playback by using the [NEXT/CANCEL] LCD button in the song selection (Open/Save) display. Simply enter the number of the song you want to hear next, and it will be put in the rotation.

Here, the settings on the [FUNCTION] → SONG SETTING display and the Open/Save display for songs are explained together with the points above.

Song Setting — Basic Procedure

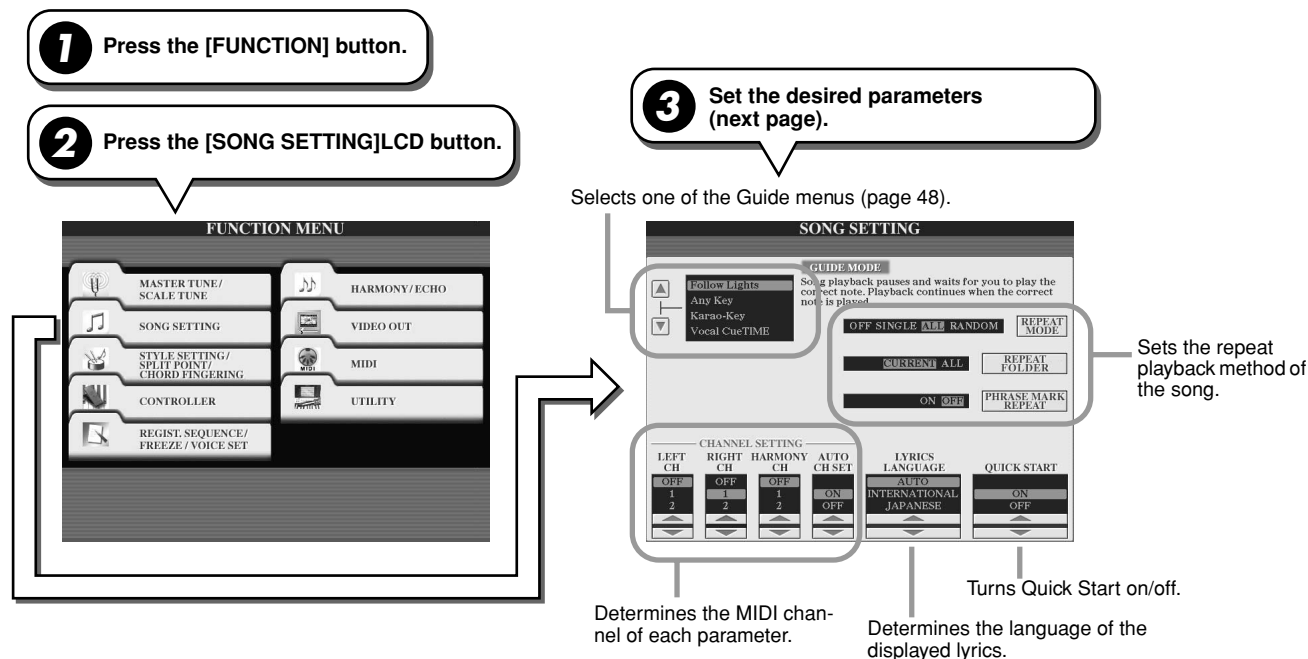

Next/Cancel — Basic Procedure

- 1** While a song is playing back, call up the Open/Save display for songs.
- 2** Press the desired song LCD button so that the NEXT mark appears inside the file box indicating that the selected song has been set to play next. You can cancel this setting by pressing the [NEXT/CANCEL] button and selecting another song.

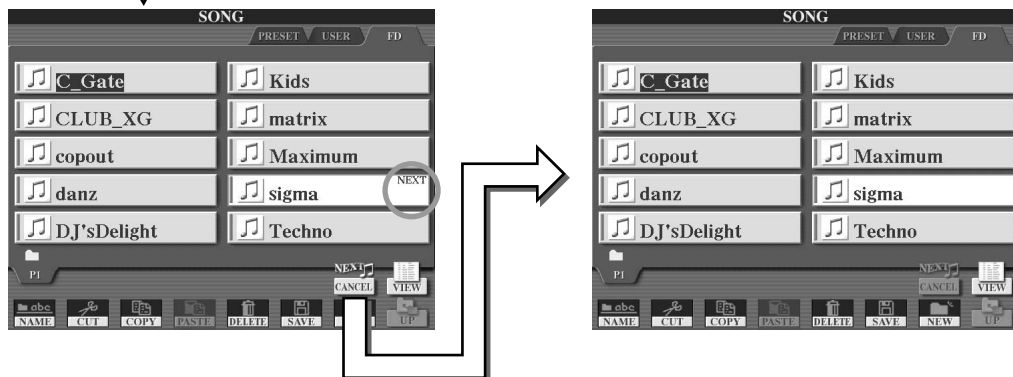

The following parameters can be set in step #3 in “Basic Procedure” on page 92.

■ Repeat Playback parameters

REPEAT MODE	Determines the method of repeat playback.
	<p>OFF Plays through the selected song, then stops.</p> <p>SINGLE Plays through the selected song repeatedly.</p> <p>ALL Continues playback through all the songs in the specified folder repeatedly.</p> <p>RANDOM Continues playback at random through all the songs in the specified folder repeatedly.</p>
REPEAT FOLDER	Determines the directory in which the songs are played in sequence when the REPEAT MODE is set to “ALL” or “RANDOM.” Here, the directory refers to the path (page 72) memorized to each of the SONG [I] - [VI] buttons.
	<p>CURRENT Sequentially plays all songs in the directory containing the currently selected song, starting with the currently selected song.</p> <p>ALL Sequentially plays all songs in all directories (memorized to the SONG [I] - [VI] buttons). Playback starts with the currently selected song, then the remainder of the songs in the current directory, followed by the songs in the other directories.</p>
PHRASE MARK REPEAT	Phrase Mark is a pre-programmed part of some song data, which specifies a certain location (set of measures) in the song. When this is on, the section corresponding to the specified Phrase Mark number is repeatedly played back (page 91)

■ MIDI Channel parameters

LEFT CH	This parameter is available when the AUTO CH SET below is set to “OFF.” This parameter determines which MIDI channel in the song data is assigned to the Left-hand part of the Guide function and the Song Score function.
RIGHT CH	This parameter is available when the AUTO CH SET below is set to OFF. This parameter determines which MIDI channel in the song data is assigned to the Right-hand part of the Guide function and the Song Score function.
HARMONY CH	Determines the MIDI channel in the song data of which the note events are used for applying the Vocal Harmony to the microphone sound.
AUTO CH SET	When set to “ON,” this automatically sets the proper MIDI channels for the Right and Left hand parts preprogrammed in the commercially available song data. Normally, this should be set to “ON.” If this is set to “OFF,” the LEFT CH and RIGHT CH parameters above are available.

■ Lyric Display parameters

LYRICS LANGUAGE	Determines the language of the displayed lyrics.
	<p>AUTO When the language is specified in the song data, the lyrics are displayed accordingly. When the language is not specified in the song data and the Language parameter on the [FUNCTION] → UTILITY → OWNER display (page 158) is set to JAPANESE, the lyrics language is regarded as JAPANESE below. When the language is not specified in the song data and the Language parameter on the [FUNCTION] → UTILITY → OWNER display (page 158) is set to something other than JAPANESE, the lyrics language is regarded as INTERNATIONAL below.</p> <p>JAPANESE Handles the displayed lyrics as Japanese.</p> <p>INTERNATIONAL Handles the displayed lyrics as a western language.</p>

■ Quick Start parameter

QUICK START	On some commercially available song data, certain settings related to the song (such as voice selection, volume, etc.) are recorded to the first measure, before the actual note data. When Quick Start is set to “ON,” the TYROS reads all initial non-note data of the song at the highest possible speed, then automatically slows down to the appropriate tempo at the first note. This allows you to start playback as quickly as possible, with a minimum pause for reading of data.
-------------	--

Song Creator (Digital Recording)

Quick Guide on pages 54 - 57 ➔

This section explains operations not covered in the Quick Guide, including Step Recording and re-recording or editing existing song data. For basic information on recording a song using Quick Recording and Multi Recording, refer to the Quick Guide.

Realtime Recording and Step Recording

You can record your keyboard performance as MIDI data in two different ways: Realtime and Step.

- **Realtime Recording** This method records performance data in real time, overwriting any data already present in the destination channel. The new data replaces the previous data. This method is covered in the “Quick Guide.”
- **Step Recording** This method lets you compose your performance by “writing” it down one event at a time. This is a non-realtime, manual recording method – similar to writing music notation onto paper. By using the Event List (pages 98, 100, 106), you can input notes, chords and other events one by one.

Punch In/Out

Page 95

This Realtime recording method lets you re-record only over a specific area of the already-recorded song. Data between the Punch In point and the Punch Out point is overwritten with the material recorded. Keep in mind that the parts before and after the Punch In/Out section are not recorded over — they play back normally to guide you in and out of the recording. You can specify the Punch In and Punch Out points as measure numbers beforehand for automatic operation, or manually execute the Punch In/Out recording by using a Foot Pedal or simply by playing the keyboard. Set the Punch In/Out related parameters on the [DIGITAL RECORDING] → SONG CREATOR → REC MODE display and re-record the already-recorded song by following the instructions described in the “Quick Guide.”

Step Recording using the Event List

Pages 98, 100, 106

Song data is made up of various recorded MIDI events, including global events for the entire song and specific events for each channel. The MIDI Event List is a useful Song Creator tool that arranges all events in a song in chronological order (in measures, beats, clocks), and allows you to make detailed changes to those events. Among the events included are:

- Chord/SectionThese style playback events let you enter Chords and Sections (Intro, Main, Ending, and so on).
- MIDI channel (1 - 16) dataChannel-specific events, such as note on/off, program change (voice number), control change messages (including volume and pan of the Mixing Console settings), and pitch bend
- System Exclusive Messages.....Events that affect all channels, such as tempo and beat (time signature)
- Lyrics.....Song Lyric data

Remember that you can also use Realtime Recording to re-record a song that has already been created with Step Recording.

Basic Procedure (Song Creator)

1 Select an already-recorded song or a new song (page 54).

2 Press the [DIGITAL RECORDING] button.



3 Press the [SONG CREATOR] LCD button.

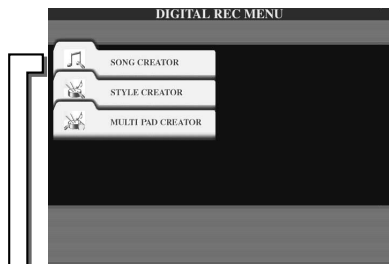

NOTE

• From the Song Creator display you can fast-forward or rewind through the song as desired — letting you quickly navigate to and check different sections of the song.

Determines the Punch In/Out settings on this page if you wish to re-record the already-recorded song.

Re-record the song by following the instructions (from step #2 to end) in the Quick Guide.

4 This page lets you edit the already-recorded song data by converting for each channel.

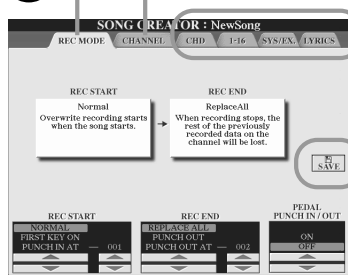

These pages let you create the song data by using the MIDI event list.

CAUTION
After completing the song creation, make sure to execute the Save operation. The recorded song will be lost if you change to another song or you turn the power off without executing the save operation.

The operations corresponding to step #4 is covered in the following page.

Record Mode Settings (Setting up for Re-recording)

The following parameters can be set when you call up the REC MODE page in step #4 of the Basic Procedure. Set the parameters below and press the [REC] button to re-record an existing song by following the instructions (from step #2 to end) in the “Quick Guide.”

■ REC START settings.....

NORMAL	Pressing the SONG [START/STOP] button or playing the keyboard with [SYNC START] on starts overwrite recording.
FIRST KEY ON	The song plays back normally, then starts overwrite recording as soon as you play the keyboard.
PUNCH IN AT	The song plays back normally up to the indicated Punch In measure, then starts overwrite recording at the specified Punch In measure (set with the corresponding LCD button).

■ REC END settings.....

REPLACE ALL	This deletes all data following the point at which recording is stopped.
PUNCH OUT	The song position at which recording is stopped is regarded as the Punch Out point. This setting maintains all data following the point at which recording is stopped.
PUNCH OUT AT	Actual overwrite recording continues until the specified Punch Out measure (set with the corresponding LCD button), at which point recording stops and normal playback continues.

■ PEDAL PUNCH IN/OUT settings.....

When this is set to ON, you can use Foot Pedal 2 to control the punch-in and punch-out points. While a song is playing back, pressing (and holding) Foot Pedal 2 instantly enables Punch In recording, while releasing the pedal stops recording (Punch Out). You can press and release Foot Pedal 2 as often as you want during playback to punch in/out of overwrite recording. Note that the current function assignment of the sostenuto pedal is cancelled when the Pedal Punch In/ Out function is set to ON.

Examples for re-recording depending on the REC MODE settings

The TYROS features several different ways you can re-record or replace a specific section of an already recorded channel. The illustrations below indicate a variety of situations in which selected measures in an eight-measure phrase are re-recorded.

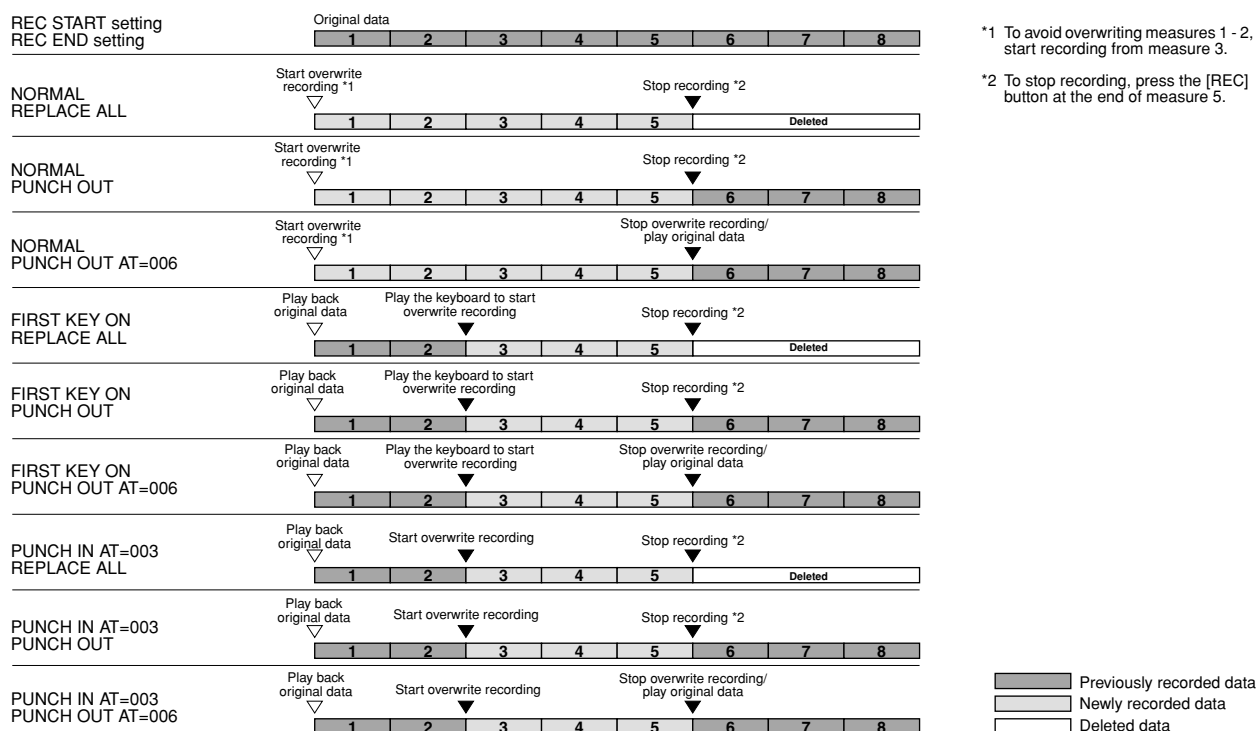

Editing Data for each Channel

To set the following parameters, call up the CHANNEL page in step #4 of the Basic Procedure on page 94.

1 Select a menu.

3 Executes the operation for the displayed page. After the operation (with the exception of the SETUP page) is completed, this button changes to [UNDO], letting you restore the original data if you are not satisfied with the Operation results. The Undo function only has one level; only the previous operation can be undone.

2 Set the parameters as desired.

4 **CAUTION**

After you've finished creating/editing a song, make sure to execute the Save operation. The recorded song will be lost if you change to another song or you turn the power off without executing the save operation.

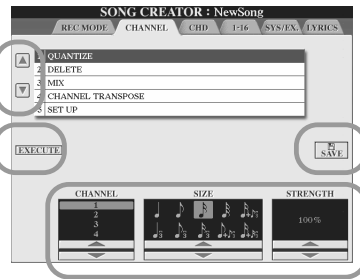

■ Quantize (set in step #2 above)

Quantize lets you “clean up” or “tighten” the timing of a previously recorded track. For example, the following musical passage has been written with exact quarter-note and eighth-note values.



When actually recording the passage in real time, however, you may not play it with perfect accuracy. Quantize allows you to align all the notes so that the timing is absolutely accurate to the specified note value.

CHANNEL	Determines which MIDI channel in the song data is to be quantized.
SIZE	<p>Selects the quantize size (resolution). Set the Quantize size to correspond to the shortest note value in the channel you are working with. For example, if the data was recorded with both quarter notes and eighth notes, use 1/8 note for the Quantize size. If you apply a 1/4 note Quantize size, the eighth notes would be moved on top of the quarter notes.</p> <p>One measure of eighth notes before quantization After 1/8 note quantization</p> <p>Settings:</p> <p> 1/4 note 1/8 note 1/16 note 1/32 note 1/16 note+ 1/8 note triplet* 1/4 note triplet 1/8 note triplet 1/16 note triplet 1/8 note+ 1/8 note triplet* 1/16 note+ 1/16 note triplet* </p> <p>The three Quantize settings marked with asterisks (*) are exceptionally convenient, since they allow you to quantize two different note values at the same time, without compromising the quantization of either one. For example, if you have both straight 1/8 notes and 1/8 note triplets recorded to the same channel, and you quantize to straight 1/8 notes, all notes in the channel are quantized to straight 1/8 notes – completely eliminating any triplet feel in the rhythm. However, if you use the 1/8 note + 1/8 note triplet setting, both the straight and triplet notes will be quantized correctly.</p>
STRENGTH	<p>Determines how strongly the notes will be quantized. If a value less than 100% is selected, notes will be moved toward the specified quantization beats only by the specified amount. Applying less than 100% quantization lets you preserve some of the “human” feel in the recording.</p> <p>Quarter-note length</p> <p>Original data (assuming 4/4 meter)</p> <p>Quantizing strength =100</p> <p>Quantizing strength =50</p>

■ Delete

This lets you delete recorded data of the specified channel in the song data. Select the channel to be deleted by using the upper/lower LCD [1] - [8] buttons and press the [EXECUTE] LCD button.

■ **Mix (set in step #2 on the previous page)**.....

This function lets you mix the data of two channels and place the results in a different channel. It also lets you copy the data from one channel to another.

SOURCE1	Determines the MIDI channel (1 - 16) to be mixed. All MIDI events of the channel specified here are copied to the destination channel.
SOURCE2	Determines the MIDI channel (1 - 16) to be mixed. Only note events of the channel specified here are copied to the destination channel. Besides the values 1 - 16, there is a "COPY" setting that allows you to copy the data from Source 1 to the destination channel.
DESTINATION	Determines the channel into which the mix or copy results will be placed.

■ **Channel Transpose**

This allows you to transpose the recorded data of individual channels up or down by a maximum of two octaves in semitone increments.

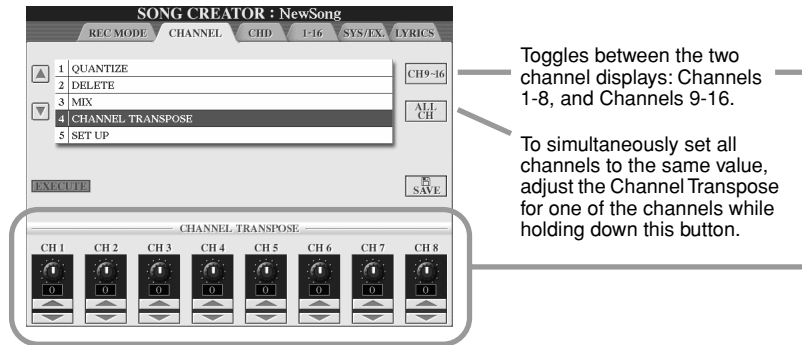

■ **Setup (set in step #2 on the previous page)**.....

The current settings of the Mixing Console (page 134) display and panel button settings can be recorded to the top position of the song as Setup data. The panel settings recorded here are automatically recalled as soon as the song starts.

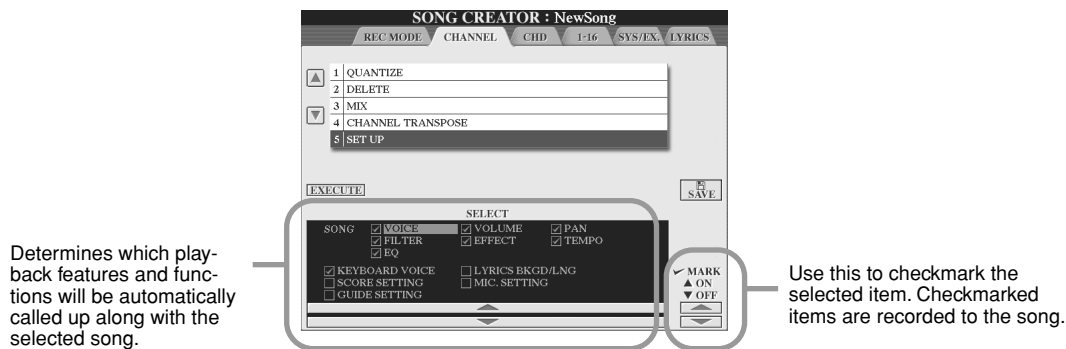

Determines which playback features and functions will be automatically called up along with the selected song.

SONG	Records the tempo setting and all settings made from the Mixing Console.
KEYBOARD VOICE	Records the current panel settings, including the voice of the keyboard-played parts (RIGHT1, 2, 3, and LEFT) and their on/off status. Panel settings recorded here are same as the ones memorized to the One Touch Setting (page 110). Unlike the other items in this chart, this can be recorded at any point in a song.
SCORE SETTING	Records the settings of the Score display.
GUIDE SETTING	Records the settings of the Guide functions. When the settings are recorded, selecting a song automatically turns on the Guide functions.
LYRICS BKGD/LNG	Records the settings of the Lyrics display.
MIC. SETTING	Stores the microphone settings in the Mixing Console (page 134) display and the Vocal Harmony settings.

Step Recording for Chord data using the Event List

The explanations here apply when you call up the CHD page in step #4 of the Basic Procedure on page 94. This feature makes it possible to record Style playback chord changes one at a time with precise timing. Since the changes don't have to be entered in real time, it is easy to create complex chord changes and accompaniment — even before recording the melody.

Use the CHD display if you wish to edit the already-recorded Chord events one by one.

Use the STEP RECORD display if you wish to enter the Chord events from scratch.

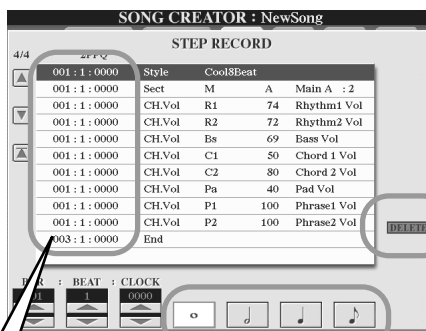
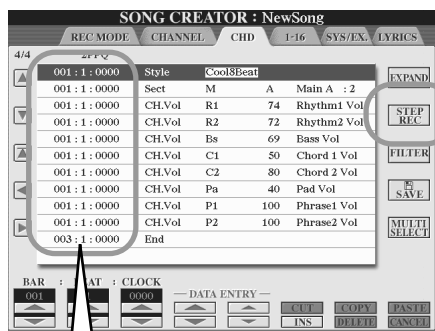

The song position at which you edit or input the event is indicated by the following three values.

001 : 1 : 1440
 Measure number (BAR) Beat Clock
 ... 1920 clocks per 1/4-note.

This sets the "size" of the next Chord/Section event to be entered in step recording, and determines to what position the pointer will advance after the event has been entered.

■ Entering Chord/Section events from scratch.....

For example, the following chord progression can be entered by the procedure described below.

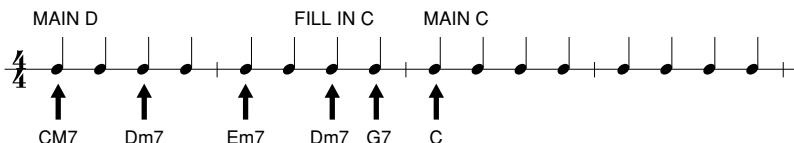

▶ **1** Press the [MAIN D] button to specify the section and enter the chords as shown at right.

ACMP QTS LINK AUTO FILL IN

MAIN VARIATION

A B C **D** (with hand icon pointing to it)

001 : 1 : 000
CM7

↓

001 : 3 : 000
Dm7

↓

002 : 1 : 000
Em7

Sect:
Indicates the Section change event.

Chord:
Indicates the Chord change event.

Select this resolution and play chords as shown at right.

NOTE

• Make sure to turn [AUTO FILL IN] off.

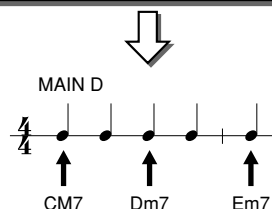

- ▶ **2** Press the [AUTO FILL IN] button and press the [MAIN C] button to specify the section (Fill In C) then enter the chords as shown at right.

Select this resolution and play chords as shown at right.

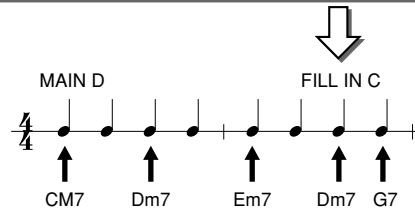

- ▶ **3** Enter the chords as shown at right.

Select this resolution and play chords as shown at right.

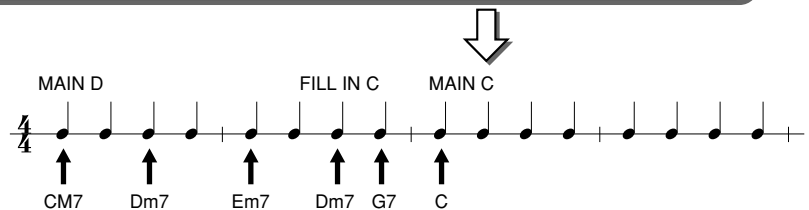

- ▶ **4** Move the song position to the top and play the song to hear the newly recorded chord progression.

You can also move the song position to the top of the song by using this LCD button.

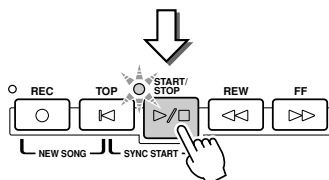

IMPORTANT

- The chord progression can be played back only from this STEP RECORD display. To play the chords, you'll need to press the [EXPAND] LCD button (next page) on the CHD display to convert the events recorded here to song data.

■ Editing existing Chord events.....

The Chord events already entered to the STEP RECORD display can be edited from the CHD display. With the exception of the Expand function explained below, the operations for the CHD display are the same as that of the channel data editing display (1-16 page) described on page 105.

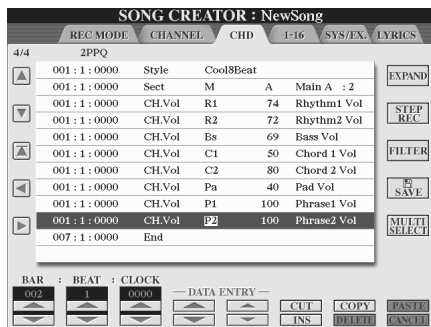

Press this to convert the recorded chord and section entries into song data. You'll need to execute the Expand operation to properly play back the data you entered in the STEP RECORD page (described on the previous page).

NOTE

• Chord and Section data recorded with Realtime Recording cannot be indicated and edited on this display.

Events handled on the Chord Event list display (CHD page)

- Style
- Tempo
- Chord — Chord root, Chord type, On Bass Chord
- Sect — Style Section (Intro, Main, Fill In, Break, Ending)
- OnOff — On/off status for each part (channel) of the style
- CH.Vol — Volume for each part (channel) of the style
- S.Vol — Overall volume of the style

Step Recording for Notes using the Event List

The explanations here apply when you call up the “1-16” page in step #4 of the Basic Procedure on page 94. This page lets you create a song by entering notes one by one for each channel with precise timing, without having to perform them in real time. The TYROS lets you record the chords for style playback and the melody (explained here) separately.

Use the 1-16 display if you wish to edit the already-recorded Note events one by one for each channel.

Use the STEP RECORD display if you wish to enter the Note events from scratch.

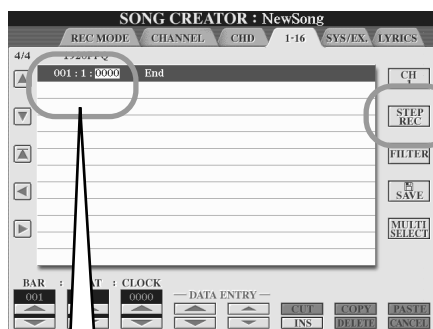

The song position at which you edit or input the event is indicated by the following three values.

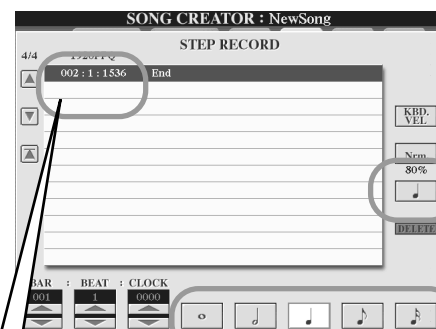
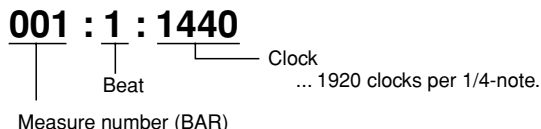

Pressing the button alternately switches the note selectors (at the bottom of the display) among three basic note values: normal, dotted and triplet.

This sets the “size” of the next note event to be entered, and determines to what position the pointer will advance after it has been entered.

NOTE

• To input rests, simply specify the position for the next note (using the [BAR], [BEAT], and [CLOCK] LCD buttons) and input the note. Any “empty” interval between two successive notes is automatically registered as a rest.

■ Entering note events from scratch.....

This section explains how to step-record notes, using three specific examples.

Example 1



▶ 1 Set the parameters below in sequence.

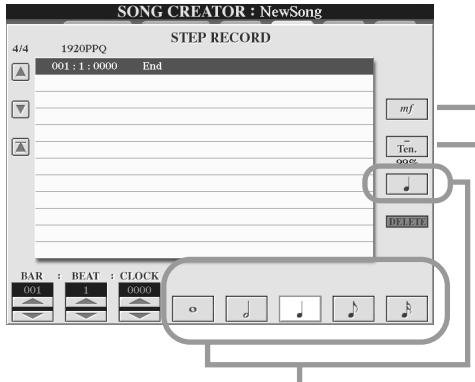



Use these buttons to set the "size" or "resolution" of the current recording step time for the next note to be entered. Here, we'll set the resolution to a 1/4 note, as specified in the example.

Determines the velocity (loudness) of the note to be entered. Here, we'll select "mf," as specified in the example.

Value	Actual recorded velocity
Kbd.Vel	Actual playing strength
fff	127
ff	111
f	95
mf	79
mp	63
p	47
pp	31
ppp	15

Sets the Gate Time, or the length of the note (as a percentage). Here, we'll select "Tenuto," as specified in the example.

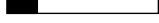
Value	Actual recorded velocity
Normal	 80%
Tenuto	 99%
Staccato	 40%
Staccatissimo	 20%
Manual	The gate time (note length) can be set to any desired percentage by using the [DATA ENTRY] dial.

▶ 2 Play the keys C, D, E, F, G, A, B and C in order, as specified in the example.

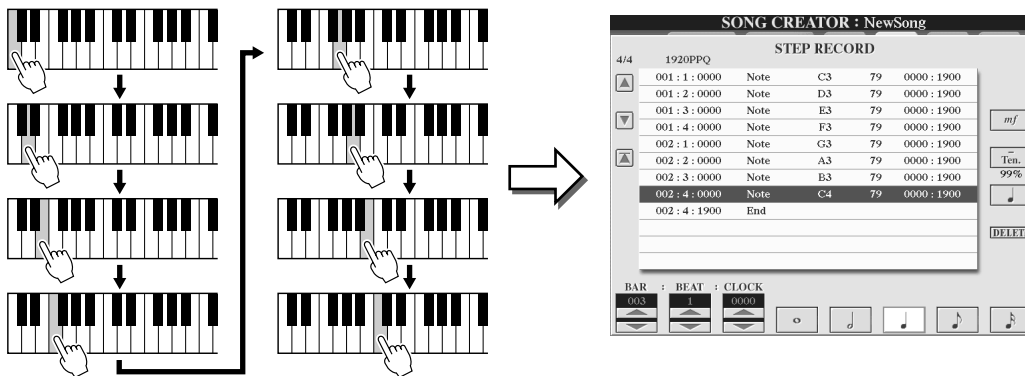

▶ 3 Move the cursor to the beginning of the song by pressing the [TOP] button, and press the SONG [START/STOP] button to hear the newly entered notes.

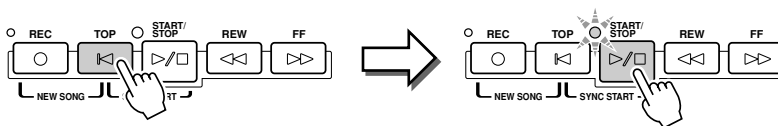

Example 2



In this example, keep in mind that one of the steps involves holding down a key on the keyboard while executing the operation.

▶ **1** Set the parameters below in sequence.

Determines the velocity (loudness) of the note to be entered. Here, we'll select "mp," as specified in the example.

Sets the Gate Time, or the length of the note (as a percentage). Here, we'll select "Normal," as specified in the example.

Use these buttons to set the resolution of the next note(s). Here, we'll set the resolution to a half note, as specified in the example.

▶ **2** Enter the note F, as specified in the example.

While holding F on the keyboard, press the 1/8 note LCD button. This enters a half note (for "F") and a tied 8th.

▶ **3** Set the parameters below in sequence.

Sets the Gate Time, or the length of the note (as a percentage). Here, we'll select "Staccato," as specified in the example.

Use these buttons to set the resolution of the next notes. Here, we'll set the resolution to an 1/8 note, as specified in the example.

▶ **4** Play the keys E, F and A, as specified in the example.

▶ **5** Set the parameters below in sequence.

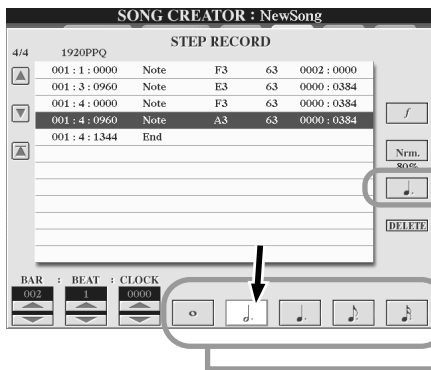

Determines the velocity (loudness) of the note to be entered. Here, we'll select "f," as specified in the example.

Sets the Gate Time, or the length of the note (as a percentage). Here, we'll select "Normal," as specified in the example.

Use these buttons to set the resolution of the next note. Here, we'll set the resolution to a **dotted half note**, as specified in the example.

▶ **6** Play an A on the keyboard, as specified in the example.

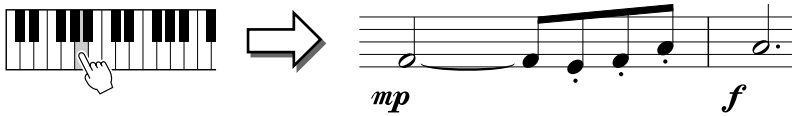

▶ **7** Set the parameters below in sequence.

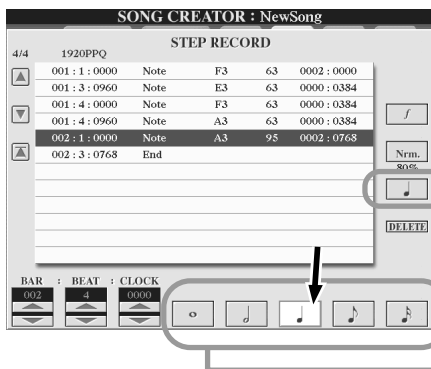

Use these buttons to set the resolution of the next note. Here, we'll set the resolution to a **1/4 note**, as specified in the example.

▶ **8** Play an F on the keyboard, as specified in the example.



▶ **9** Move the cursor to the beginning of the song by pressing the [TOP] button, and press the SONG [START/STOP] button to hear the newly entered notes.

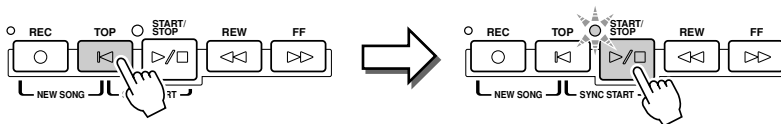

Example 3



To properly enter the tied notes here, keep in mind that you'll need to hold the keys down during the entire operation until all the notes are entered.

- ▶ **1** Set the parameters below in sequence.

SONG CREATOR : NewSong
STEP RECORD

4/4 1920PPQ
001 : 1 : 0000 End

ff

Norm.

Normal

Use these buttons to set the resolution of the next note. Here, we'll set the resolution to an 1/8 note, as specified in the example.

- ▶ **2** Enter the note C3, as specified in the example.

Do not release C3 yet. Keep holding the note as you execute the following steps.

While holding the key C3, press the 1/8 note LCD button.

- ▶ **3** Enter the note E3.

Do not release C3 and E3 yet. Keep holding the notes as you execute the following steps.

While holding the keys C3 and E3, press the 1/8 note LCD button.

- ▶ **4** Enter the note G3.

Do not release C3, E3 and G3 yet. Keep holding the notes as you execute the following steps.

While holding the keys C3, E3 and G3, press the 1/8 note LCD button.

▶ **5 Enter the note C4.**

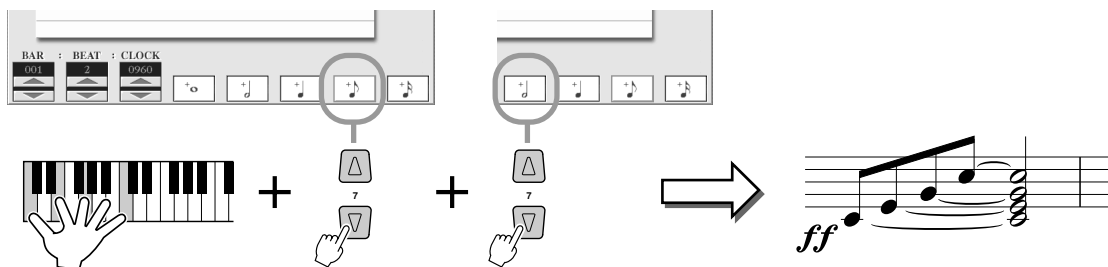

While holding the keys C3, E3, G3 and C4, press the 1/8 note LCD button, then press the half note LCD button. All notes in the example have now been entered and you can release the keys.

▶ **6 Move the cursor to the beginning of the song by pressing the [TOP] button, and press the SONG [START/STOP] button to hear the newly entered notes.**

■ **Editing existing Note events on the STEP RECORD display**

Note events and other various channel events already entered to the STEP RECORD display can be edited from the 1-16 display. The explanations below also apply to other Event List displays (CHD, SYS/EX., LYRICS).

Use these to move the song position (cursor) up/down and select the desired event.

Moves the song position (cursor) to the beginning position of the data.

Use these to move the cursor left/right and select the desired parameter of the highlighted event.

Determines the current position of the data.

Determines the channel for the MIDI event edited here or entered to the STEP RECORD display.

Calls up the Filter display (page 107), letting you select only the events you wish to be shown in the Event List.

Holding this button down while using the [A] and [B] buttons lets you select multiple events. This convenient feature lets you select several events together, making it possible to change the values of many different events at once, or easily and quickly copy many events to another location.

If the value at the cursor has been changed, pressing this restores the original value.

CUT, COPY, PASTE and DELETE are the same functions as those in the Open/Save display, except that these apply to MIDI events, not files.

For coarse adjustment of the event value. Keep in mind that moving the cursor away from the just edited value or starting the song playback automatically enters that value.

For fine adjustment of the event value. You can use the [DATA ENTRY] dial to adjust the value. Keep in mind that moving the cursor away from the just edited value or starting the song playback automatically enters that value.

Adds a new event to the Event List.

Events handled on the Note Event list display (1-16 page)

Note (Note on/off)	Messages which are generated when the keyboard is played. Each message includes a specific note number which corresponds to the key which is pressed, plus a velocity value based on how hard the key is played.
Ctrl (Control Change)	Controller settings such as volume, pan (edited via the Mixing Console described on page 134), etc.
Prog (Program Change)	Determines the voice (program) number. For details on program change messages and how to set them, refer to the separate Data List booklet (Voice List).
P.Bnd (Pitch Bend)	Events generated by controlling the PITCH BEND wheel. These events bend the pitch of notes up or down.
A.T. (Aftertouch)	Determines the aftertouch value.

For details on the events above, refer to the separate Data List booklet (MIDI Data Format).



Step Recording for System Exclusive Messages using the Event List

The explanations here apply when you call up the SYS/EX. page in step #4 of the Basic Procedure on page 94. From this display, you can edit recorded System events which do not belong to a specific MIDI channel, such as tempo and beat (time signature). The instructions for this display are basically the same as those for the channel data editing display (1-16 page) described on page 105.

Events handled on the System Exclusive (SYS/EX.) Event list display

ScBar (Score initial measure)	This determines the number of the top measure. You cannot move the song position to the measure before the one set here. When the song is selected, the measure (bar) number set here is indicated on the Main display. Pressing the [TOP] button moves the song position to the measure (bar) number set here.
Tempo	Determines the tempo value.
Time (Time signature)	Determines the time signature.
Key (Key signature)	Determines the key, as well as the major/minor setting. This setting is used for displaying the notation (Song Score function).
XG Prm (XG parameters)	Allows you to make various detailed changes to the data. For more information on XG parameters, refer to the separate Data List booklet (MIDI Data Format).
SYS/EX. (System Exclusive)	Displays the System Exclusive data in the song. Keep in mind that you cannot create new data or change the contents of the data here; however, you can delete, cut, copy, and paste the data.
Meta (Meta event)	Displays the SMF meta events in the song. Keep in mind that you cannot create new data or change the contents of the data here; however, you can delete, cut, copy, and paste the data.
Marker (Song Position Marker)	Displays the Song Position Marker (SPJ-01 - 04) in the song. Keep in mind that you cannot create new data or change the contents of the data here; however, you can delete, cut, copy, and paste the data.

Step Recording for Lyrics using the Event List

The explanations here apply when you call up the LYRICS page in step #4 of the Basic Procedure on page 94. From this display, you can edit recorded Lyrics events. The instructions for this display are basically the same as those for the channel data editing display (1-16 page) described on page 105.

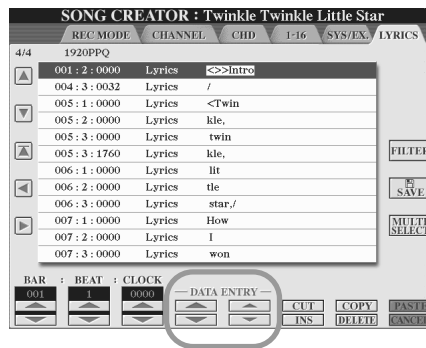

Pressing one of these buttons from the Lyrics display calls up the pop-up window for entering lyrics to the currently selected position. Entering lyrics is done in the same way as naming files, as described on page 70.

Events handled on the Lyrics Event list display

Name (Song name)	Determines the song name. This calls up the pop-up window for entering a name.
Lyrics	Allows you to enter lyrics.
Code (Other controls)	CR : Enters a line break in the lyrics text. LF : Unavailable on the TYROS. On some MIDI devices, such as sequencers, this event may delete the currently displayed lyrics and display the next set of lyrics.

Customizing the Event List – Filter

Because the Event List displays (CHD, 1-16, SYS/EX. and LYRICS) contain a wide variety of events, it may be difficult to pinpoint the ones you want to edit. This is where the Filter function comes in handy. It lets you determine which event types will be shown in the Event List displays. To call up the Filter display below, press the [FILTER] LCD button from any of the Event List displays.

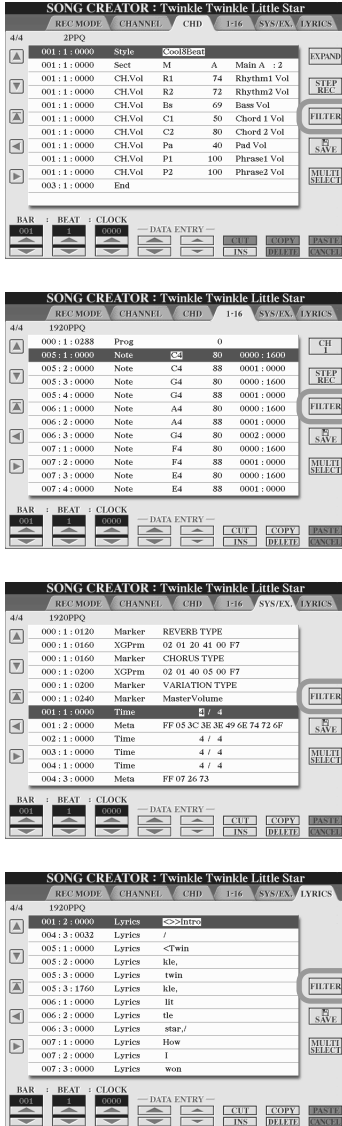

Select the desired Filter category from the three below, then checkmark the items you want to be shown in the Event List displays.

- MAIN** : Displays all main types of events.
- CTRL CHG** : Displays all specific Control Change message events.
- STYLE** : Displays all types of style playback related events.

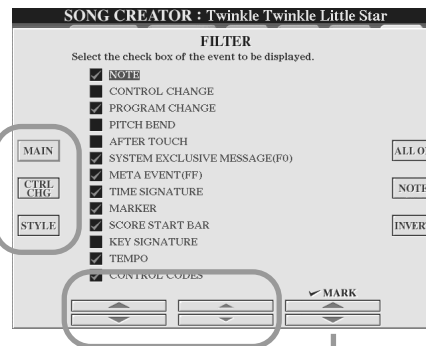

Enters checkmarks for all event types.

Selects only note data; checkmarks for all other boxes are removed.

Reverses the checkmark settings for all boxes. In other words, this enters checkmarks to all boxes that were previously unchecked and vice versa.

Select an event type to be checked or unchecked.

Enters/removes the checkmark for the selected event type. The checked event types can be shown on the Event List displays.

Style Playback (Auto Accompaniment)

Quick Guide on pages 32 - 37 ➔

This section explains important style-related operations not covered in the Quick Guide. For basic information on playing styles, refer to the Quick Guide.

Chord Fingerings

The chords (or simplified chord indications) you play in the left-hand section of the keyboard are used for several performance functions:

- When [ACMP] is turned on (page 32), the left-hand section of the keyboard becomes the Chord section and the selected style is played back according to the chords specified in the left-hand section of the keyboard. The specified chords are also used for Vocal Harmony (page 47), the Harmony (Voice) effect (page 39), and the Multi Pads (when used with Chord Match; page 38).
- When the [ACMP] is turned off (page 32) and the LEFT part is turned on, the notes played as the Left part are recognized as chords. These chords have no effect on style playback, but are used for Vocal Harmony (page 47), the Harmony (Voice) effect (page 39), and the Multi Pads (when used with Chord Match; page 38).

There is also a convenient Chord Tutor function that shows you which notes you need to play to make certain chords. (Press [FUNCTION] → CHORD FINGERING.)

The explanations here show how to specify chords. Call up the [FUNCTION] → CHORD FINGERING display and follow the instructions below.

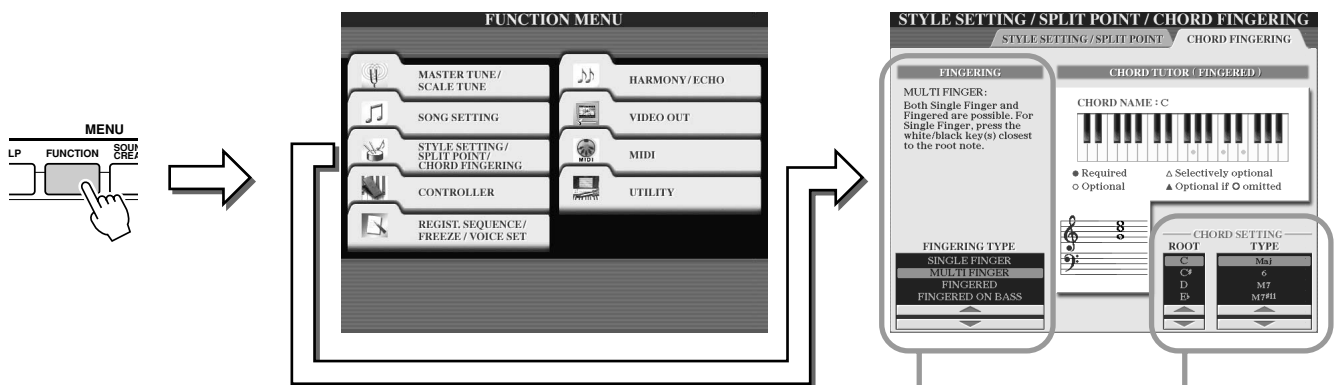

Selects the fingering type, which determines how the chords are specified (which notes you should play). See below for details.

Chord Tutor
Specify the Chord Root and Type here, and the notes of the chord are indicated in the keyboard illustration above. Depending on the chord, some notes may be omitted.

■ Seven types of Chord Fingerings

● SINGLE FINGER

Makes it simple to produce orchestrated accompaniment using major, seventh, minor and minor-seventh chords by pressing a minimum number of keys on the Chord section of the keyboard. This type is available only for style playback. The abbreviated chord fingerings described below are used:



For a major chord, press the root key only.



For a seventh chord, simultaneously press the root key and a white key to its left.



For a minor chord, simultaneously press the root key and a black key to its left.



For a minor-seventh chord, simultaneously press the root key and both a white and black key to its left.

● FINGERED

Lets you finger your own chords on the Chord section of the keyboard, while the TYROS supplies appropriately orchestrated rhythm, bass, and chord accompaniment in the selected style. The Fingered recognizes the various chord types which are listed on the separate Data List booklet and can be looked up using the Chord Tutor function above.

● FINGERED ON BASS

Accepts the same fingerings as the Fingered, but the lowest note played in the Chord section of the keyboard is used as the bass note, allowing you to play “on bass” chords (in the Fingered mode the root of the chord is always used as the bass note).

● MULTI FINGER

Automatically detects Single Finger or Fingered chord fingerings, so you can use either type of fingering without having to switch fingering types.

● AI FINGERED

Basically the same as FINGERED, with the exception that less than three notes can be played to indicate the chords (based on the previously played chord, etc.).

● **FULL KEYBOARD**

Detects chords in the entire key range. Chords are detected in a way similar to Fingered, even if you split the notes between your left and right hands — for example, playing a bass note with your left hand and a chord with your right, or by playing a chord with your left hand and a melody note with your right.

● **AI FULL KEYBOARD**

When this advanced fingering type is engaged, the TYROS will automatically create appropriate accompaniment while you play just about anything, anywhere on the keyboard using both hands. You don't have to worry about specifying the style chords. Although the AI Full Keyboard type is designed to work with many songs, some arrangements may not be suitable for use with this feature. This type is similar to FULL KEYBOARD, with the exception that less than three notes can be played to indicate the chords (based on the previously played chord, etc.). 9th, 11th and 13th chords cannot be played. This type is available only for style playback.

The following list shows the conditions in which the notes played in the left-hand section of the keyboard can be recognized as a chord.

Selected Fingering type	[ACMP] off, LEFT part off	[ACMP] off, LEFT part on	[ACMP] on, LEFT part off	[ACMP] on, LEFT part on
SINGLE FINGER	Not recognized	Recognized via FINGERED	Recognized via the selected Fingering type.	Recognized via the selected Fingering type.
FINGERED	Not recognized	Recognized via the selected Fingering type.	Recognized via the selected Fingering type.	Recognized via the selected Fingering type.
FINGERED ON BASS	Not recognized	Recognized via the selected Fingering type.	Recognized via the selected Fingering type.	Recognized via the selected Fingering type.
MULTI FINGER	Not recognized	Recognized via FINGERED	Recognized via the selected Fingering type.	Recognized via the selected Fingering type.
AI FINGERED	Not recognized	Recognized via the selected Fingering type.	Recognized via the selected Fingering type.	Recognized via the selected Fingering type.
FULL KEYBOARD	Not recognized	Recognized via the selected Fingering type.	Recognized via the selected Fingering type.	Recognized via the selected Fingering type.
AI FULL KEYBOARD	Not recognized	Not recognized	Recognized via the selected Fingering type.	Recognized via the selected Fingering type.

Fade In/Out

The [FADE IN/OUT] button can be used to produce smooth fade-ins and fade-outs when starting and stopping the style/song playback. This affects the overall sound of the TYROS — including the your keyboard performance and the Multi Pads, as well as the styles and songs.

▶ **1 Press the [FADE IN/OUT] button so that its indicator lights.**



▶ **2 Start the style playback.**

The sound will gradually fade in. The [FADE IN/OUT] indicator will flash during the fade-in, and then go out when full volume has been reached.



NOTE

• The time of the fade-in/fade-out can also be set (page 156).

▶ **3 Press the [FADE IN/OUT] button again so that its indicator lights.**

The indicator will flash during the fade out, then the style playback will stop when the fade-out is complete.

Tempo

Each style of the TYROS has been programmed with a default or standard tempo; however, this can be changed to any value between 5 and 500 beats per minute by using the [TEMPO] button. This can be done either before the style playback is started or while it is playing. When you select a different style while the style is not playing, the “default” tempo for that style is also selected. If the style is playing, the same tempo is maintained even if you select a different style.

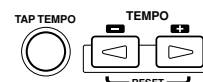

■ **Tap function**

This useful function lets you press the [TAP TEMPO] button to tap out the tempo and automatically start the style at that tapped speed. Simply tap (press/release) the button (four times for a 4/4 time signature), and the style playback starts automatically at the tempo you tapped. The tempo can also be changed during playback by tapping the button twice at the desired tempo.

● **When a 4-beat style is selected**

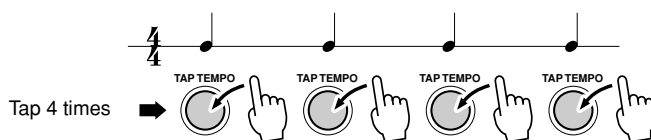

* When a 3-beat style is selected, tap 3 times.

Synchro Start and Synchro Stop

Quick Guide on page 32 ➔

When [SYNC START] (Synchro Start) is turned on, you can automatically have style playback start as soon as you play a chord in the chord section of the keyboard. When [SYNC STOP] (Synchro Stop) is on, the accompaniment plays as long as you hold a chord. In other words, you can abruptly stop the accompaniment simply by releasing your left hand from the keyboard. Since turning on [SYNC STOP] automatically enables [SYNC START] as well, you can instantly start up and stop the accompaniment by alternately playing chords and releasing them.

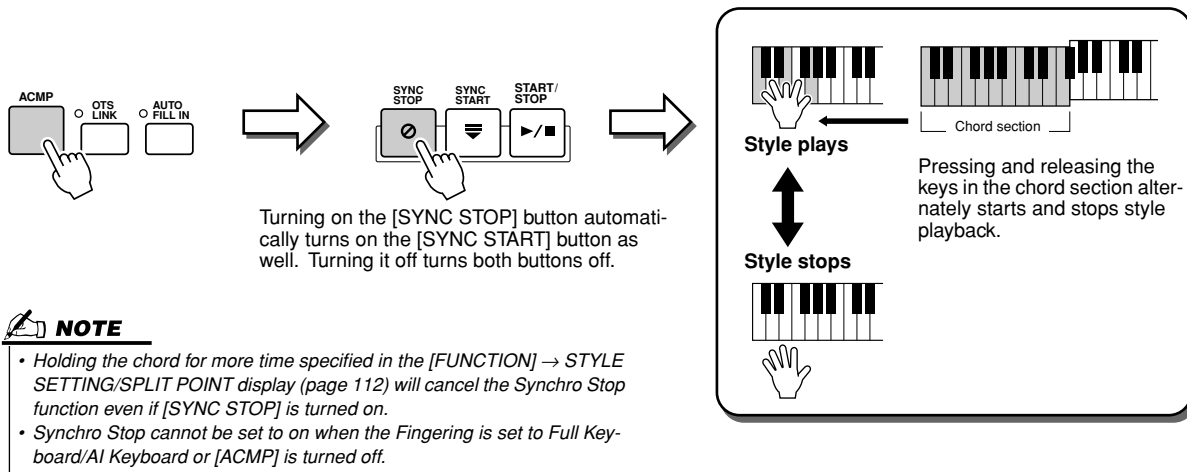

Programmable One Touch Setting (OTS)

Quick Guide on page 36 ➔

One Touch Setting (OTS) is a convenient function that allows you to call up the most appropriate panel settings for the currently selected style — with the touch of a single button. Press any one of the four [ONE TOUCH SETTING] buttons to instantly call up the following pre-programmed settings for style play.

- [ACMP] and [SYNC START] are automatically turned on, letting you start the style as soon as you play a left-hand chord on the keyboard.
- Custom panel settings (for voices, keyboard parts, effects, etc.) designed to best match the selected style are automatically called up — letting you instantly reconfigure the instrument to suit the music you play.

The TYROS actually has three different features that let you instantly call up complete panel setups: One Touch Setting (described here), Music Finder, and Registration Memory. One Touch Setting differs from the other two in that each OTS panel setting is dedicated to a particular style — first, you select a style for your performance, then you press a [ONE TOUCH SETTING] button to match the panel settings to that style.

■ OTS Link.....

The convenient OTS (One Touch Setting) Link function lets you automatically have One Touch Settings change when you select a different Main section (A - D). The Main sections A, B, C, and D correspond to One Touch Settings 1, 2, 3, and 4, respectively. This is especially powerful for live performance situations, letting you instantly and easily reconfigure the instrument as you play.



■ Memorizing the panel settings to the OTS.....

The TYROS features four different One Touch Settings for each of the preset styles. Though each has been specially programmed to match the style, you can change the settings as desired. The changed One Touch Settings can be saved as the selected style to the User or Disk drive.

⚠ CAUTION

- Make sure to save your OTS settings as a style file to the User or Disk drive (see Save operation instructions on page 69, step #2 to end). The panel settings memorized to each OTS button will be lost if you change the style or turn the power off without executing the Save operation.

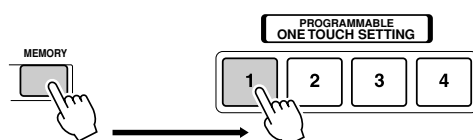

Press the [MEMORY] button of Registration Memory and press any of the [ONE TOUCH SETTING] buttons.

Instant Style Selection

If you've created your own styles and built up a collection of style data on the User drive or optional Hard Disk drive, you'll soon have many style files to select from — making it difficult to call up your favorite styles. This function lets you memorize the path of a specific style to a specific STYLE button. Even if your data is scattered across the drive in a complex hierarchy of folders and paths, you can instantly call up a specific file — no matter how deeply hidden — with a single button-press.

- ▶ **1** Call up the Open/Save display for styles with the Number Input Type (page 71).
- ▶ **2** First, select the style to be memorized by calling up the appropriate path, then press the [MEMORY] LCD button.

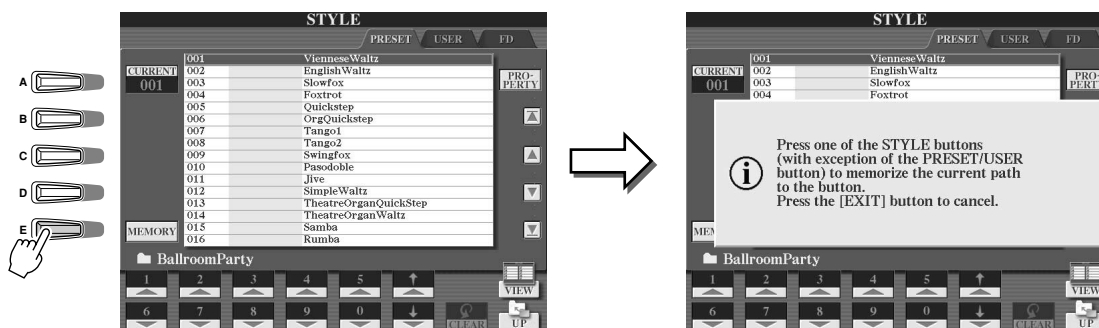

- ▶ **3** Check that the path set in step #2 above has been properly memorized. First, call up a different path (for example, the Open/Save display for voices), then select the path just memorized by turning on the [USER/DISK] button and pressing the appropriate STYLE button.

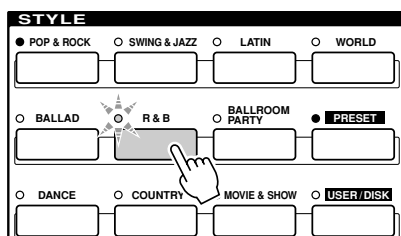

- ▶ **4** Call up the other path (for example, the Open/Save display for voices) and call up the path memorized in step #3 by following the instructions below.

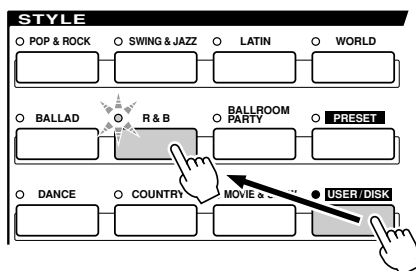

Turn [USER/DISK] on and press appropriate STYLE button (set in step #3 above).

Style Playback Related Settings

The TYROS has a variety of style playback functions, including Split Point and many others — which can be accessed by pressing [FUNCTION] → STYLE SETTING/SPLIT POINT.

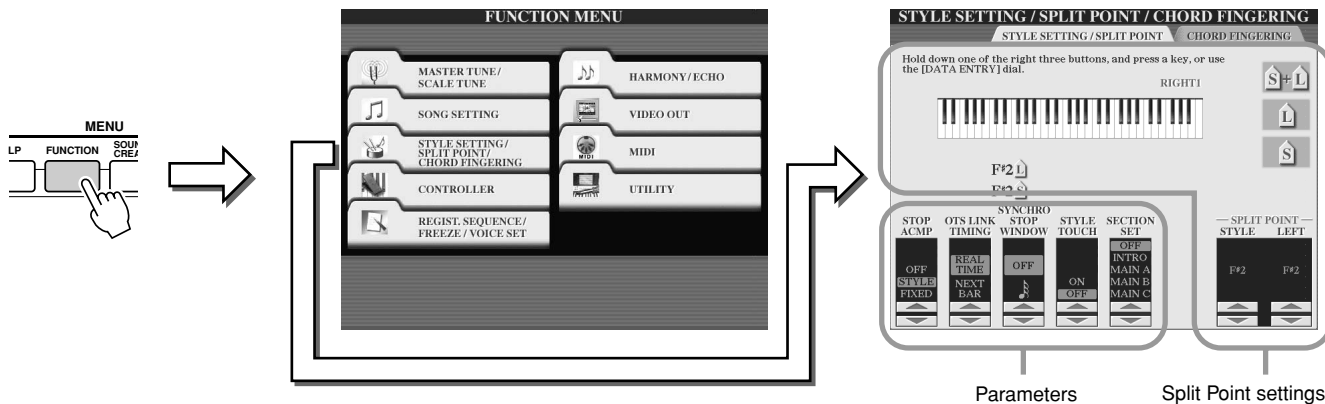

Split Point

These are the settings (there are two Split Points) that separate the different sections of the keyboard: the Chord section, the LEFT part section and the RIGHT 1-3 section. The two Split Point settings (below) are specified as note names.

- Split Point (S) — separates the Chord section for style playback from the section(s) for playing voices (RIGHT 1-3, LEFT)
- Split Point (L) — separates the two sections for playing voices, LEFT and RIGHT 1-3.

These two settings can be set to the same note (as in the default) or two different notes as desired.

Setting the Split Point (S) and the Split Point (L) to the same note

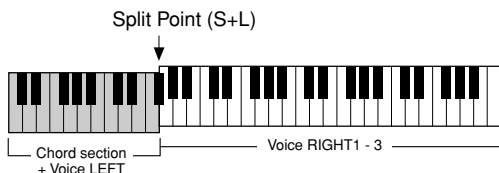

Press the [S+L] LCD button and rotate the [DATA ENTRY] dial, or press the desired key on the keyboard while holding the [S+L] LCD button.

Setting the Split Point (S) and the Split Point (L) to different notes

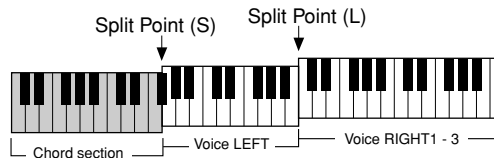

To set Split Point (L), press the [L] LCD button and rotate the [DATA ENTRY] dial, or press the desired key on the keyboard while holding the [L] LCD button.

To set Split Point (S), press the [S] LCD button and rotate the [DATA ENTRY] dial, or press the desired key on the keyboard while holding the [S] LCD button.

Split Point (L) cannot be set lower than Split Point (S), and Split Point (S) cannot be set higher than Split Point (L).

Stop Accompaniment

When auto accompaniment is turned on and Syncro Start is off, you can play chords in the left-hand (accompaniment) section of the keyboard with the style stopped, and still hear the accompaniment chord. In this condition — called “Stop Accompaniment” — any valid chord fingerings are recognized and the chord root/type are shown in the LCD. Since the TYROS properly recognizes the chord, you can also use the Chord Match function (page 38) with the Multi Pads or the Harmony effect (page 39) without having to play back a style.

From the display above, you can determine whether the chord played in the chord section will sound or not in the Stop Accompaniment status.

- OFF.....The chord played in the chord section will not sound.
- STYLE.....The chord played in the chord section will sound via the voices for the Pad part and the Bass channel of the selected style.
- FIXEDThe chord played in the chord section will sound via the certain voice regardless of the selected style.

NOTE

- The chord detected by playing the Stop Accompaniment can be recorded to a song regardless of the setting here. Please note that the voice sound will be recorded when set to “STYLE,” and will not be recorded when set to “OFF” or “FIXED.”

■ OTS Link Timing

This applies to the OTS Link function (page 110). This parameter determines the timing in which the One Touch Settings change with the MAIN VARIATION [A] - [D] change. (The [OTS LINK] button must be on.)

- Real Time.....One Touch Setting is immediately called up when you press a [MAIN VARIATION] button.
- Next Bar.....One Touch Setting is called up at the next measure, after you press a [MAIN VARIATION] button.

■ Synchro Stop Window

This determines how long you can hold a chord before the Synchro Stop function is automatically cancelled. When the [SYNC STOP] button is turned on and this is set to a value other than “OFF,” this automatically cancels the Synchro Stop function if you hold a chord for longer than the time set here. This conveniently resets style playback control to normal, letting you release the keys and still have the style play.

■ Style Touch

Turns touch response for the style playback on/off. When this is set to “ON,” the style volume changes in response to your playing strength in the chord section of the keyboard.

■ Section Set

Determines the default section that is automatically called up when selecting different styles (when style playback is stopped). When set to “OFF” and style playback is stopped, the active section is maintained even if the different style is selected.

When any of the Main A-D sections is not included in the style data, the nearest section is automatically selected. For example, when Main D is not contained in the selected style, Main C will be called up.

Simultaneously Playing a Song and a Style

When playing back a song and a style at the same time, channels 9 - 16 of the song data are replaced with style channels — allowing you to use the styles and features in place of the accompaniment parts of the song. This provides added flexibility to your performance, letting you independently control style playback and song playback.

NOTE

- The style stops when you stop the song. If the accompaniment style is playing and you start the song, the accompaniment automatically stops.
- Some of the songs have been created using the built-in styles. For these songs, the styles are automatically started when starting song playback.

Style Creator (Digital Recording)

The powerful Style Creator feature lets you create your own original styles, which can then be used for style playback — just as with the preset styles.

Style Data Structure — Creating Styles

Each style is made up of fifteen sections (Intro I - III, Main A - D, Fill In A - D, Break, Ending I - III) as rhythm pattern variations. Each of these fifteen sections in turn has eight different parts (channels), made up of MIDI sequence data — making a total of 120 separate sets of MIDI data contained in a single style. With the Style Creator feature, you can create a style by separately recording the necessary MIDI data, or by importing pattern data from other existing styles.

Each style contains 120 MIDI data sequences (15 Sections x 8 Parts)

Section	Part	RHYTHM 1	RHYTHM 2	BASS	CHORD 1	CHORD 2	PAD	PHRASE 1	PHRASE 2
INTRO I		●	●	○	○	○	○	○	○
INTRO II		●	●	○	○	○	○	○	○
INTRO III		●	●	○	○	○	○	○	○
MAIN A		●	●	○	○	○	○	○	○
MAIN B		●	●	○	○	○	○	○	○
MAIN C		●	●	○	○	○	○	○	○
MAIN D		●	●	○	○	○	○	○	○
FILL IN A		●	●	○	○	○	○	○	○
FILL IN B		●	●	○	○	○	○	○	○
FILL IN C		●	●	○	○	○	○	○	○
FILL IN D		●	●	○	○	○	○	○	○
BREAK		●	●	○	○	○	○	○	○
ENDING I		●	●	○	○	○	○	○	○
ENDING II		●	●	○	○	○	○	○	○
ENDING III		●	●	○	○	○	○	○	○

- For these parts containing preset data, new material can be over-dubbed (recorded).
- For these parts containing preset data, new material cannot be over-dubbed (recorded). These parts can be recorded only after deleting their preset data.

● Using Preset Styles

As shown in the chart at right, when you select the internal preset style that is the closest to the type of style you wish to create and call up the Style Creator display, the preset style data will be copied to a special memory location for creating. You can create an original style by adding, deleting, or replacing data from this memory location.

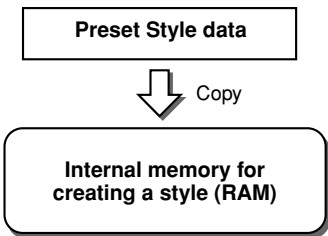

NOTE

• The DSP1 effect settings (page 136) cannot be stored in the User style data, and as such cannot be edited in the Style Creator function. This means that any DSP1 effect settings in the Preset style (such as changing speeds of the rotary speaker effect) will be deleted from the copied Preset style data, and be unavailable for creating a style.

● Recording and Assembling

The Style Creator provides two basic ways to create MIDI sequence data of each part: Recording, which allows you to record parts from the keyboard (using Realtime or Step Recording), and Assembly, which lets you bring various pattern data together by copying from other styles. Both methods, Recording and Assembly, replace the original data with the new data.

In the case of chart shown at right, for example, INTRO I and MAIN A are created by recording the new data to all the parts, and MAIN B is created by assembling the pattern data for all parts from the other styles. INTRO III and ENDING A - C are created by keeping and using the original data. MAIN C and FILL IN A are created via three ways: Recording, Assembly, and using the original data.

Example style — created by Recording, Assembly and original data

Section	Part	RHYTHM 1	RHYTHM 2	BASS	CHORD 1	CHORD 2	PAD	PHRASE 1	PHRASE 2
INTRO I		■	■	■	■	■	■	—	—
INTRO II		□	□	□	□	□	□	■	■
INTRO III		□	□	□	□	□	□	□	□
MAIN A		■	■	■	■	■	■	■	■
MAIN B		■	■	■	■	■	■	■	■
MAIN C		■	□	■	□	■	□	□	■
MAIN D		—	—	—	—	—	—	—	—
FILL IN A		■	■	□	■	—	■	□	□
FILL IN B		□	□	□	□	□	□	□	□
FILL IN C		□	□	□	■	□	□	□	□
FILL IN D		—	—	—	—	—	—	—	—
BREAK		□	□	■	□	□	□	□	□
ENDING I		□	□	□	□	□	□	□	□
ENDING II		□	□	□	□	□	□	□	□
ENDING III		□	□	□	□	□	□	□	□

- Creating data by recording
- Copying data from other styles (Assembly)
- No change (maintaining the original data)
- No data

● Loop Recording and Overdub Recording

The Song Creator (Song Recording) feature records your keyboard performance as MIDI data. Recording a style data via the Style Creator, however, is done in a different way. Here are some of the aspects in which style recording differs from song recording:

- **Loop Recording** Style playback repeats the rhythm patterns of several measures in a “loop,” and style recording is also done using loops. For example, if you start recording with a two-measure main section, the two measures are repeatedly recorded. Notes that you record will play back from the next repetition (loop), letting you record while hearing previously recorded material.
- **Overdub Recording** This method records new material to a part (channel) already containing recorded data, without deleting the original data. In style recording, the recorded data is not deleted, except when using functions such as Rhythm Clear (page 117) and Delete function (page 116). For example, if you start recording with a two-measure MAIN section, the two measures are repeated many times. Notes that you record will play back from the next repetition, letting you overdub new material to the loop while hearing previously recorded material.

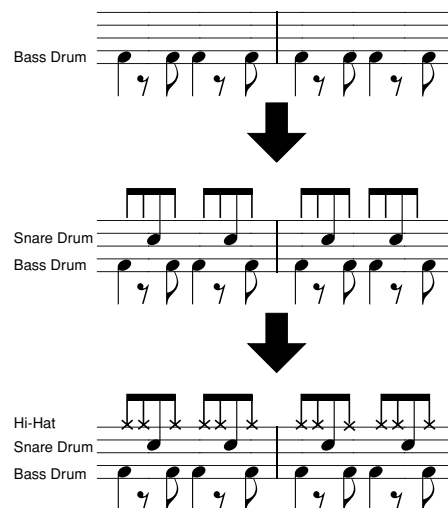

Using the recording methods above, the Style Creator feature lets you record complete rhythm patterns (like the one above) quickly and easily.

● Rhythm Parts and Pitched Parts

Creating or recording the Rhythm parts (containing non-pitched data) differs from recording other parts (containing pitched data) in the following ways.

- Note data can be overdubbed to existing Rhythm parts of a preset style, whereas other pitched parts can be newly recorded to only after all existing preset data on the part is deleted.
- Style parts (channels) other than Rhythm parts are played back according to the chord root/type specified in the chord section of the keyboard. The notes output from style parts (channels) other than Rhythm parts are transposed from the Source Pattern (described below) according to the chord root/type specified in the chord section of the keyboard. The Style Creator lets you set the parameters that determine how the note is transposed and set the parameters that determine how notes held through chord changes will be handled.

Special Parameter Settings based on Style File Format

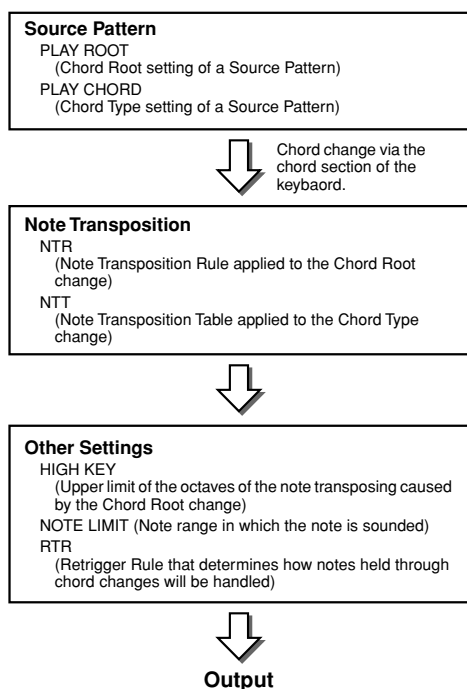

The Style File Format (SFF) combines all of Yamaha’s auto accompaniment (style playback) know-how into a single unified format. By using the Style Creator, you can take advantage of the power of the SFF format and freely create your own styles.

The chart shown at left indicates the process by which the style is played back. (This does not apply to the rhythm track.) These parameters can be set via the Style Creator feature.

● Source Pattern..... page 121

There are a variety of possibilities for style playback notes, depending on the particular root note and chord type that are selected. The style data is appropriately converted depending on the chord changes you make during your performance. This basic style data that you create with the Style Creator is referred to as the “Source Pattern.”

● Note Transposition..... page 121

This parameter group features two parameters that determine how the notes of the Source Pattern are to be converted in response to chord changes.

● Other Settings..... page 122

Using the parameters of this group, you can fine-tune how style playback responds to the chords you play. For example, the Note Limit parameter allows you to have the voices of the style sound as realistic as possible by shifting the pitch to an authentic range — ensuring that no notes sound outside the natural range of the actual instrument (e.g., very low notes of a piccolo sound).

Basic Procedure (Style Creator)

- 1 First, select the desired style and one of its sections.
- 2 Press the [DIGITAL RECORDING] button.
- 3 Press the [STYLE CREATOR] LCD button.

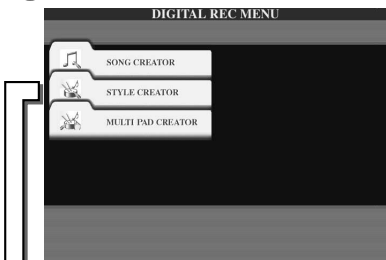
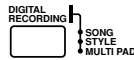

NOTE

- Any voice can be selected for the RHY1 channel, with the exception of Organ Flutes.
- Only Drum Kit/SFX Kit can be selected for the RHY 2 channel.
- For the non-rhythm channels (BASS - PHR 2), all voices with the exception of the Organ Flutes voice/Drum Kit/SFX Kit can be selected.

NOTE

- You can also select the desired section for recording by pressing the appropriate panel button. Pressing one of the Section buttons (including the [AUTO FILL IN] button) calls up the SECTION pop-up window, from which you can change Sections.
- To actually enter the change, press the [OK] LCD button.

- 4 Select a section and part (channel) to be created or recorded, and set the basic parameters for style creation.
- Execute Realtime recording.
Execute Assembly (page 118).
Edit the already-recorded parts (channels).
Execute Step Recording using the Event List.

CAUTION

After you've finished creating/editing a style, make sure to execute the Save operation. The recorded style will be lost if you change to another style or you turn the power off without executing the save operation (page 69).

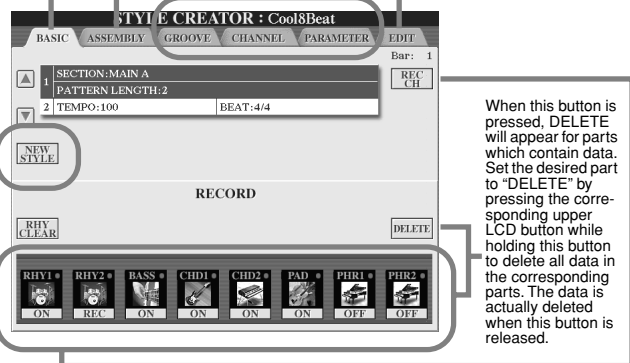

When this button is pressed, DELETE will appear for parts which contain data. Set the desired part to "DELETE" by pressing the corresponding upper LCD button while holding this button to delete all data in the corresponding parts. The data is actually deleted when this button is released.

Set the desired part (channel) to "REC" by pressing the corresponding lower LCD button while holding the [REC CH] button. Only one part (channel) can be recorded at a time.

Press the LCD up button to call up the Open/Save display for voices to change the voice of the selected part. Press the [EXIT] button to return to this display.

You can also turn each part's playback on/off during recording by pressing the lower LCD button.

Press this if you want to create a style from scratch by deleting all data of the selected style.

This operation corresponding to step #4 is covered in the following page.

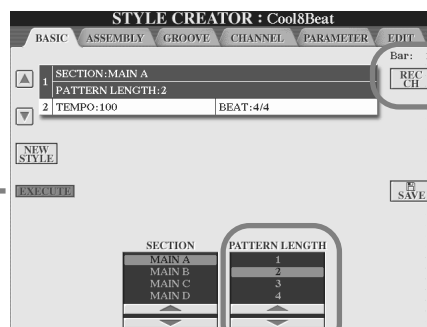

Select a section to be created.

Select the desired number of measures for the selected section (except for FILL IN sections, which are fixed at 1 measure). Press the [EXECUTE] LCD button to actually enter the new settings, and check it by pressing the [START/STOP] button in the STYLE CONTROL section to hear style playback.

NOTE

- You cannot overdub-record (page 115) new material to any parts (channels) that contain preset data, with the exception of the Rhythm parts (channels). Make sure to delete preset data of non-Rhythm parts before recording, by using the [DELETE] LCD button above.

Basic Settings and Realtime Recording for each part (channel)

The explanations here apply when you call up the BASIC page in step #4 of the Basic Procedure above. Refer to the illustrations above for information about the basic style creation parameters. For actual instruction steps for recording, see the sections below.

■ Recording note events to a Rhythm part (channel)

- ▶ 1 Select one of the Rhythm parts as a recording part on the BASIC display (above).

- ▶ **2** Press the **STYLE CONTROL [START/STOP]** button to start recording of the Rhythm part. You can hear the selected style in a playback loop as you record. Turn the playback parts on/off as desired.
- ▶ **3** **Overdub drum/percussion instruments to the part by playing the appropriate keys.** You can also delete certain percussion sounds while recording. While holding the [RHY CLEAR] LCD button, press the key on the keyboard corresponding to the instrument you want to cancel. This Rhythm Clear function deletes all instances of the instrument in the part.
- ▶ **4** Press the **STYLE CONTROL [START/STOP]** button again to stop recording (looped playback).

■ Recording note events to a Bass/Chord/Pad/Phrase part (channel).....

- ▶ **1** Select one of the parts (other than a Rhythm part) by following the instructions in step #4 of “Basic Procedure” on page 116.

You cannot record new material to the Bass/Chord/Pad/Phrase part (channel) that has preset data. If the selected part to be recorded has preset data, make sure to delete it (in step #4 of “Basic Procedure” on page 116).

- ▶ **2** Start recording.

You can start recording in one of two ways:

- Press the **STYLE CONTROL [START/STOP]** button.
- Press the **STYLE CONTROL [SYNC START]** button to enable Synchro Start standby, then play a key on the keyboard.

Turn the playback parts on/off as desired.

The recording repeats indefinitely (until stopped) in a loop. Notes that you record will play back from the next repetition, letting you record while hearing previously recorded material.

Rules when recording non-rhythm parts

- Use only the CM7 scale tones when recording the BASS and PHRASE parts (i.e., C, D, E, G, A, and B).
- Use only the chord tones when recording the CHORD and PAD parts (i.e., C, E, G, and B).



C = Chord notes
C, R = Recommended notes

Using the data recorded here, the auto accompaniment (style playback) is appropriately converted depending on the chord changes you make during your performance. The chord which forms the basis for this note conversion is called the Source Chord, and is set by default to CM7 (as in the example illustration above).

You can change the Source Chord (its root and type) from the PARAMETER display on page 120. Keep in mind that when you change the Source Chord from the default CM7 to another chord, the chord notes and recommended notes will also change. For details on chord notes and recommended notes, see page 121.

- ▶ **3** Press the **STYLE CONTROL [START/STOP]** button again to stop recording (and looped playback).

NOTE

- For the **INTRO** and **ENDING** sections, any appropriate chord or chord progression can be used. (You need not follow the rules described at left.)
- If you want to record the pattern with a Source Chord other than CM7, set the **PLAY ROOT** and **PLAY CHORD** parameters on the **PARAMETER** page (page 120) before performing step #2.

Step Recording for Notes using the Event List

The explanations here apply when you call up the **EDIT** page in step #4 of the Basic Procedure on page 116. The **EDIT** page contains the Event List, in which you can record notes with absolutely precise timing. This Step Recording procedure is essentially the same as that for Song Recording (pages 100 - 105), with the exception of the points listed below:

- In the Song Creator, the End Mark position can be changed freely; in the Style Creator, it cannot be changed. This is because the length of the style is automatically fixed, depending on the selected section. For example, if you create a style based on a section of four measures length, the End Mark position is automatically set to the end of the fourth measure, and cannot be changed in the Step Recording display.
- Recording channels (parts) can be changed in the Song Creator; however, they cannot be changed in the Style Creator.
- In the Style Creator, only the channel events and System Exclusive messages can be entered. Chord and Lyrics events are not available. You can switch between the two types of Event Lists by pressing the LCD [F] button.

Assembling a Style from Existing Pattern Data

The explanations here apply when you call up the ASSEMBLY page in step #4 of the Basic Procedure on page 116. This convenient function lets you combine style elements — such as rhythm, bass, and chord patterns — from existing styles, and use them to create your own original sections and styles.

Assembling pattern data as shown below at left using “Cool 8Beat” as a basis, for example, results in the display below at right.

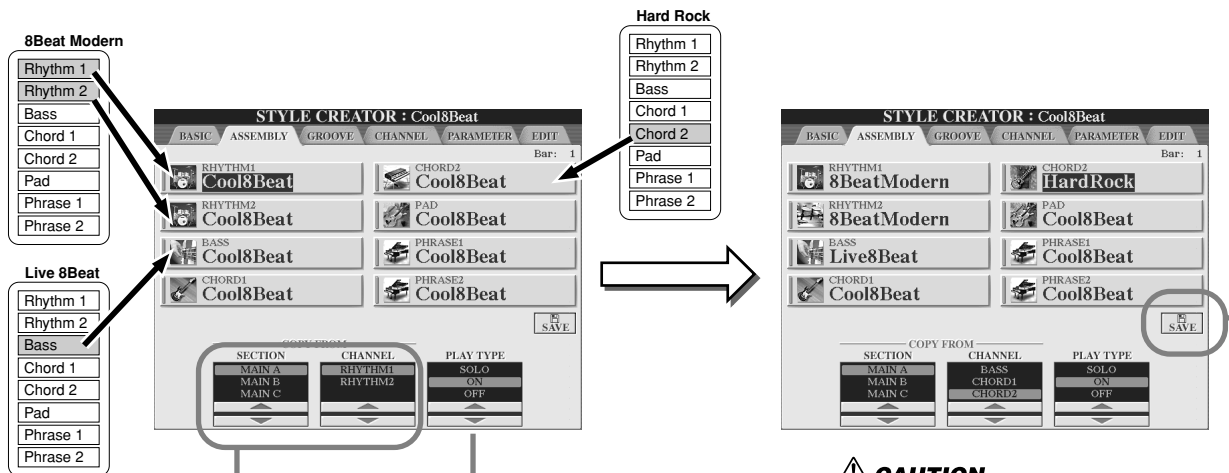

Select the desired part (channel) by pressing one of the LCD [A] - [D], [F] - [I] buttons and press the same button to call up the Open/Save display for styles, from which you can select the desired style. After selecting the style, press the [EXIT] button to return to this display, then select the desired sections and channels to be copied.

Determines the playback setting for each channel. You can assemble the accompaniment style while the style section and channel that will be copied are playing.

- **SOLO**
Mutes all but the selected channel. Any parts (channels) set to ON in the RECORD pop-up window on the BASIC page are played back simultaneously.
- **ON**
Plays back the selected part (channel). Any parts (channels) set to ON in the RECORD pop-up window on the BASIC page are played back simultaneously.
- **OFF**
Mutes the selected part (channel).

CAUTION

After you've finished creating/editing a style, make sure to execute the Save operation. The recorded style will be lost if you change to another style or you turn the power off without executing the save operation (page 69).

Groove and Dynamics

The explanations here apply to when you call up the GROOVE page in step #4 of the Basic Procedure on page 116. These versatile features give you a wide variety of tools for changing the rhythmic feel of your created style.

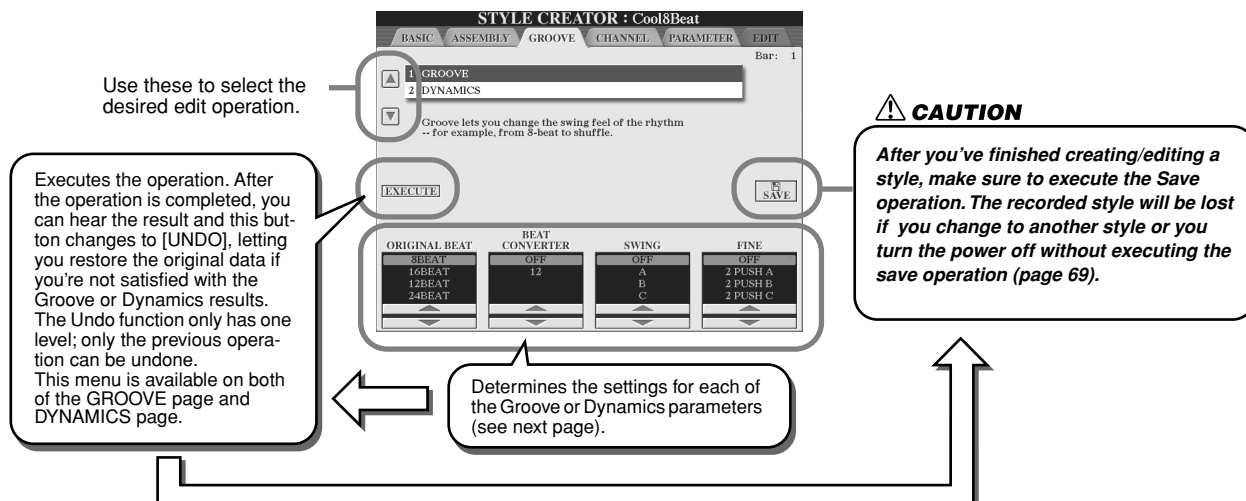

■ Groove

This lets you add swing to the music or change the “feel” of the beat by making subtle shifts in the timing (clock) of the style. The Groove settings are applied to all parts of the selected style.

ORIGINAL BEAT	Specifies the beats to which Groove timing is to be applied. In other words, if “8 Beat” is selected, Groove timing is applied to the 8th notes; if “12 Beat” is selected, Groove timing is applied to 8th-note triplets.
BEAT CONVERTER	Actually changes the timing of the beats (specified in the ORIGINAL BEAT parameter above) to the selected value. For example, when ORIGINAL BEAT is set to “8 Beat” and BEAT CONVERTER is set to “12,” all 8th notes in the section are shifted to 8th-note triplet timing. The “16A” and “16B” Beat Converter which appear when ORIGINAL BEAT is set to “12 Beat” are variations on a basic 16th-note setting.
SWING	Produces a “swing” feel by shifting the timing of the back beats, depending on the ORIGINAL BEAT parameter above. For example, if the specified ORIGINAL BEAT value is “8 Beat”, the Swing parameter will selectively delay the 2nd, 4th, 6th, and 8th beats of each measure to create a swing feel. The settings “A” through “E” produce different degrees of swing, with “A” being the most subtle and “E” being the most pronounced.
FINE	Selects a variety of Groove “templates” to be applied to the selected section. The “PUSH” settings cause certain beats to be played early, while “HEAVY” settings delay the timing of certain beats. The numbered settings (2, 3, 4, 5) determine which beats are to be affected. All beats up to the specified beat — but not including the first beat — will be played early or delayed (for example, the 2nd and 3rd beats, if “3” is selected). In all cases, “A” types produce minimum effect, “B” types produce medium effect, and “C” types produce maximum effect.

■ Dynamics

This changes the velocity/volume (or accent) of certain notes in the style playback. The Dynamics settings are applied to each part (channel) or all parts (channels) of the selected style.

CHANNEL	Selects the desired channel (part) to which Dynamics is to be applied.
ACCENT TYPE	Determines the type of accent applied — in other words, which notes in the part(s) are emphasized with the Dynamics settings.
STRENGTH	Determines how strongly the selected Accent Type (above) will be applied. The higher the value, the stronger the effect.
EXPAND/COMP.	Expands or compresses the range of velocity values. Values higher than 100% expand the dynamic range, while values lower than 100% compress it.
BOOST/CUT	Boosts or cuts all velocity values in the selected section/channel. Values above 100% boost the overall velocity, while values below 100% reduce it.

Editing Data for each Channel

The explanations here apply when you call up the CHANNEL page in step #4 of the Basic Procedure on page 116.

1 Use these to select the desired edit operation.

2 Select a channel (part) of which data edit is to be executed.

3 Set the parameters for executing the data edit.

4 Executes the selected operation on the respective page. After the operation is completed, you can hear the result and this button changes to [UNDO], letting you restore the original data if you're not satisfied with the result of each operation. The Undo function only has one level; only the previous operation can be undone.

5 **CAUTION**
After you've finished creating/editing a style, make sure to execute the Save operation. The recorded style will be lost if you change to another style or you turn the power off without executing the save operation (page 69).

QUANTIZE	Same as in the Song Creator. See page 96.
VELOCITY CHANGE	Boosts or cuts the velocity of all notes in the specified channel, according to the percentage specified here.
BAR COPY	This function allows data to be copied from one measure or group of measures to another location within the specified channel. SOURCE specifies the first (TOP) and last (LAST) measures in the region to be copied. DEST specifies the first measure of the destination location, to which the data is to be copied.
BAR CLEAR	This function clears all data from the specified range of measures within the selected channel.
REMOVE EVENT	This function lets you remove specific events from the selected channel.

Making Style File Format Settings

The explanations here apply when you call up the PARAMETER page in step #4 of the Basic Procedure on page 116. This display provides a variety of style controls — such as determining how the pitch and sound of the recorded style change when playing the chords in the left-hand range of the keyboard. Parameter settings on this display are available only when any of the non-rhythm parts are set to “REC” on the RECORD pop-up window on the BASIC page. For details about the relationship between the parameters, refer to “Style File Format” on page 115.

NOTE

- When NTR is set to “Root Fixed” and NTT is set to “Bypass,” the “Source Root” and “Source Chord” parameters are changed to “Play Root” and “Play Chord,” respectively. In this case, you can change chords and hear the resulting sound for all channels.

1 Use these to select the desired edit operation.

2 Select the desired channel (part) to be edited.

3 Set the parameters of the channel specified at left.

4 **CAUTION**
After you've finished creating/editing a style, make sure to execute the Save operation. The recorded style will be lost if you change to another style or you turn the power off without executing the save operation (page 69).

NOTE

- Normally in the Style Creator, you can hear your original style-in-process with the Source Pattern. However, there is a way to hear it played by a specific chord and root. To do this, set NTR to “Root Fixed” and NTT to “Bypass,” then change the newly displayed “Play Root” and “Play Chord” parameters to the desired settings.

● SOURCE ROOT/CHORD

These settings determine the original key of the source pattern (i.e., the key used when recording the pattern). The default setting of CM7 (with a Source Root of “C” and a Source Type of “M”), is automatically selected whenever the preset data is deleted prior to recording a new style, regardless of the Source Root and Chord included in the preset data. When you change Source Root / Chord from the default CM7 to another chord, the chord notes and recommended notes will also change, depending on the newly selected chord type.

When the Source Root C:

C = Chord notes
C, R = Recommended notes

● NTR (Note Transposition Rule)

This determines the relative position of the root note in the chord, when converted from the Source Pattern in response to chord changes.

<p>ROOT TRANS (Root Transpose)</p>	<p>When the root note is transposed, the pitch relationship between notes is maintained. For example, the notes C3, E3 and G3 in the key of C become F3, A3 and C4 when they are transposed to F. Use this setting for channels that contain melody lines.</p>	<p>When playing a C major chord.</p> <p>When playing an F major chord.</p>
<p>ROOT FIXED (Root Fixed)</p>	<p>The note is kept as close as possible to the previous note range. For example, the notes C3, E3 and G3 in the key of C become C3, F3 and A3 when they are transposed to F. Use this setting for channels that contain chord parts.</p>	<p>When playing a C major chord.</p> <p>When playing an F major chord.</p>

● NTT (Note Transposition Table)

This sets the note transposition table for the source pattern.

BYPASS	No transposition. The part (channel) of which the NTT is set to this is played back without note conversion even if you change the chord during style playback.
MELODY	Suitable for melody line transposition. Use this for melody channels such as Phrase 1 and Phrase 2.
CHORD	Suitable for chord transposition. Use this for the Chord 1 and Chord 2 channels, especially when they contain piano or guitar-like chordal parts.
MELODIC MINOR	When the played chord changes from a major to a minor chord, this table lowers the third interval in the scale by a semitone. When the chord changes from a minor to a major chord, the minor third interval is raised by a semitone. Other notes are not changed. Use this for melody channels of Sections which respond only to major/minor chords, such as Intros and Endings.
MELODIC MINOR 5th Var.	In addition to the Melodic Minor transposition above, augmented and diminished chords affect the 5th note of the Source Pattern.
HARMONIC MINOR	When the played chord changes from a major to a minor chord, this table lowers the third and sixth intervals in the scale by a semitone. When the chord changes from a minor to a major chord, the minor third and flatted sixth intervals are raised by a semitone. Other notes are not changed. Use this for chord channels of Sections which respond only to major/minor chords, such as Intros and Endings.
HARMONIC MINOR 5th Var.	In addition to the Harmonic Minor transposition above, augmented and diminished chords affect the 5th note of the Source pattern.
NATURAL MINOR	When the played chord changes from a major to a minor chord, this table lowers the third, sixth and seventh intervals in the scale by a semitone. When the chord changes from a minor to a major chord, the minor third, flatted sixth and flatted seventh intervals are raised by a semitone. Other notes are not changed. Use this for chord channels of Sections which respond only to a Major/minor chord such as Intros and Endings.
NATURAL MINOR 5th Var.	In addition to the Natural Minor transposition above, augmented and diminished chords affect the 5th note of the Source pattern.
DORIAN	When the played chord changes from a major to a minor chord, this table lowers the third and seventh intervals in the scale by a semitone. When the chord changes from a minor to a major chord, the minor third and flatted seventh intervals are raised by a semitone. Other notes are not changed. Use this for chord channels of Sections which respond only to a Major/minor chord such as Intros and Endings.
DORIAN 5th Var.	In addition to the Dorian transposition above, augmented and diminished chords.

● NTT BASS ON/OFF

The part (channel) for which this parameter is set to on recognizes on-bass chords allowed in the FINGERED ON BASS fingering mode, regardless of the NTT setting.

● **HIGH KEY**

This sets the highest key (upper octave limit) of the note transposition for the chord root change. Any notes calculated to be higher than the highest key are transposed down to the next lowest octave. This setting is available only when the NTR parameter (page 121) is set to “Root Trans.”

Example — When the highest key is F.

Root changes → CM C#M . . . FM F#M . . .

Notes played → C3-E3-G3 C#3-F3-G#3 F3-A3-C4 F#2-A#2-C#3

● **NOTE LIMIT**

This sets the note range (highest and lowest notes) for voices recorded to the style channels. By judicious setting of this range, you can ensure that the voices sound as realistic as possible — in other words, that no notes outside the natural range are sounded (e.g., high bass sounds or low piccolo sounds). The actual notes that sound are automatically shifted to the set range.

Example — When the lowest note is C3 and the highest is D4.

Root changes → CM C#M . . . FM . . .

Notes played → E3-G3-C4 F3-G#3-C#4 F3-A3-C4

● **RTR**

These settings determine whether notes stop sounding or not and how they change pitch in response to chord changes.

STOP	The notes stop sounding.
PITCH SHIFT	The pitch of the note will bend without a new attack to match the type of the new chord.
PITCH SHIFT TO ROOT	The pitch of the note will bend without a new attack to match the root of the new chord.
RETRIGGER	The note is retriggered with a new attack at a new pitch corresponding to the next chord.
RETRIGGER TO ROOT	The note is retriggered with a new attack at the root note of the next chord. However, the octave of the new note remains the same.

Custom Style Recording via an External Sequence Recorder

If you have a favorite sequencer or sequence software, you can use that to create custom styles, instead of using the Style Creator on the TYROS.

■ **Connections**.....

- Connect the TYROS MIDI OUT to the sequencer MIDI IN, and the sequencer MIDI OUT to the TYROS MIDI IN.
- Make sure that the sequencer “ECHO” function is ON, and the TYROS LOCAL ON/OFF (page 146) is turned OFF.

■ **Creating the Data**.....

- Record all sections and parts (channels) using a CM7 (C major seventh) chord.
- Record the parts on the MIDI channels listed at right, using the TYROS’ internal tone generator. If the TYROS is not used during recording, make sure to use XG- and SFF- (Style File Format) compatible tone generator for optimum results.
- Record the sections in the order listed below, with a Marker Meta-event at the top of each section. Enter the Marker Meta-events exactly as indicated in the chart on the next page (including upper/ lower case characters and spaces).
- Also include an “SFF1” Marker Meta-event, “SInt” Marker Meta-event and style name Meta-event at 1111000 (the top of the sequence track), and the GM on Sys/Ex message (F0, 7E, 7F, 09, 01, F7). (“Timing” in the chart is based on 480 clocks per quarter note. “1111000” is clock “0” of the first beat of the first measure).
- The data from 1111000 through 1141479 is the “Initial Setup;” and 2111000 through the end of Ending B is the “Source Pattern.”
- The timing of Fill In AA and subsequent Marker Meta-events will depend on the length of each section.

Part	MIDI Ch.
Rhythm1	9
Rhythm2	10
Bass	11
Chord1	12
Chord2	13
Pad	14
Phrase1	15
Phrase2	16

NOTE

• Explanations here assume a sequencer resolution of 480 clocks per quarter note. The actual clock values here may differ depending on your sequencer.

- The Initial Setup area from 1|2|000 through 1|4|479 is used for voice and effect settings. Do not include note event data.
- The Main A data begins at 2|1|000. Any number of measures from 1 to 255 can be used.
- Fill In AA begins from the top of the measure following the last measure of the Main A pattern. In the chart this is 4|1|00, but this is only an example and the actual timing will depend on the length of Main A. Please note that all Fill Ins can be only 1 measure in length (refer to the Section/Length chart below).

Section	Length
Intro	255 measures max.
Main	255 measures max.
Fill In	1 measure
Ending	255 measures max.

The following charts indicate the valid MIDI events for both the Initial Setup data and the Pattern data. Make sure to NOT enter any events marked with a dash (—), nor any other events not listed here.

Channel Message

Event	Initial Setup	Source Pattern
Note Off	—	OK
Note On	—	OK
Program Change	OK	OK
Pitch Bend	OK	OK
Control #0 (Bank Select MSB)	OK	OK
Control #1 (Modulation)	OK	OK
Control #6 (Data Entry MSB)	OK	—
Control #7 (Master Volume)	OK	OK
Control #10 (Pan)	OK	OK
Control #11 (Expression)	OK	OK
Control #32 (Bank Select LSB)	OK	OK
Control #38 (Data Entry LSB)	OK	—
Control #71 (Harmonic Content)	OK	OK
Control #72 (Release Time)	OK	—
Control #73 (Attack Time)	OK	—
Control #74 (Brightness)	OK	OK
Control #84 (Portamento Control)	—	OK
Control #91 (Reverb Send Level)	OK	OK
Control #93 (Chorus Send Level)	OK	OK
Control #94 (Variation Send Level)	OK	OK
Control #98 (NRPN LSB)	OK	—
Control #99 (NRPN MSB)	OK	—
Control #100 (RPN LSB)	OK	—
Control #101 (RPN MSB)	OK	—

RPN & NRPN

Event	Initial Setup	Source Pattern
RPN (Pitch Bend Sensitivity)	OK	—
RPN (Fine Tuning)	OK	—
RPN (Coarse Tuning)	OK	—
RPN (Null)	OK	—
NRPN (Vibrato Rate)	OK	—
NRPN (Vibrato Delay)	OK	—
NRPN (EG Decay Time)	OK	—
NRPN (Drum Filter Cutoff Frequency)	OK	—
NRPN (Drum Filter Resonance)	OK	—
NRPN (Drum EG Attack Time)	OK	—
NRPN (Drum EG Decay Time)	OK	—
NRPN (Drum Instrument Pitch Coarse)	OK	—
NRPN (Drum Instrument Pitch Fine)	OK	—
NRPN (Drum Instrument Level)	OK	—
NRPN (Drum Instrument Pan)	OK	—
NRPN (Drum Instrument Reverb Send Level)	OK	—
NRPN (Drum Instrument Chorus Send Level)	OK	—
NRPN (Drum Instrument Variation Send Level)	OK	—

● Style Data Format

Timing	Marker Meta-Event	Contents	Comments	
1 1 000 1 1 000	SFF1	Style Name (Sequence/Track Name Meta-Event)	Initial Setup	
1 1 000 1 1 000 1 2 000 ⋮ 1 4 479	SInt	GM on Sys/Ex Initial Setup Events		
2 1 000 ⋮ 3 4 479	Main A	2 bars Main Pattern (up to 255 bars)		Source Pattern
4 1 000 ⋮ 4 4 479	Fill In AA	1 bar Fill In Pattern		
5 1 000 ⋮ 6 4 479	Intro A	2 bars Intro Pattern (up to 255 bars)		
7 1 000 ⋮ 8 4 479	Ending A	2 bars Intro Pattern (up to 255 bars)		
9 1 000 ⋮ 10 4 479	Main B	2 bars Intro Pattern (up to 255 bars)		
11 1 000 ⋮ 11 4 479	Fill In BA	1 bar Fill In Pattern		
12 1 000 ⋮ 12 4 479	Fill In BB	1 bar Fill In Pattern		
13 1 000 ⋮ 14 4 479	Intro B	2 bars Intro Pattern (up to 255 bars)		
15 1 000 ⋮ 16 4 479	Ending B	2 bars Intro Pattern (up to 255 bars)		
17 1 000 ⋮ 18 4 479	Main C	2 bars Main Pattern (up to 255 bars)		
19 1 000 ⋮ 19 4 479	Fill In CC	1 bar Fill In Pattern		
20 1 000 ⋮ 21 4 479	Intro C	2 bars Intro Pattern (up to 255 bars)		
22 1 000 ⋮ 23 4 479	Ending C	2 bars Intro Pattern (up to 255 bars)		
24 1 000 ⋮ 25 4 479	Main D	2 bars Main Pattern (up to 255 bars)		
26 1 000 ⋮ 26 4 479	Fill In DD	1 bar Fill In Pattern		

System Exclusive

Event	Initial Setup	Source Pattern
Sys/Ex GM on	OK	—
Sys/Ex XG on	OK	—
Sys Ex XG Parameter Change (Effect1)	OK	—
Sys Ex XG Parameter Change (Multi Part)	—	—
DRY LEVEL	OK	OK
Sys Ex XG Parameter Change (Drum Setup)	—	—
PITCH COARSE	OK	—
PITCH FINE	OK	—
LEVEL	OK	—
PAN	OK	—
REVERB SEND	OK	—
CHORUS SEND	OK	—
VARIATION SEND	OK	—
FILTER CUTOFF FREQUENCY	OK	—
FILTER RESONANCE	OK	—
EG ATTACK	OK	—
EG DECAY1	OK	—
EG DECAY2	OK	—

The Multi Pads

Quick Guide on page 38 ➔

Basic information about how to play the Multi Pads is explained in the “Quick Guide.” This section covers how the Multi Pad data is managed on the Open/Save display and how to create (record) Multi Pad data.

Multi Pad Editing using the Open/Save display

Multi Pads are grouped in Banks or four each and handled as files from the Open/Save display.

You can call up the Open/Save display for Multi Pad Banks from the Main display by pressing the LCD [E] button.

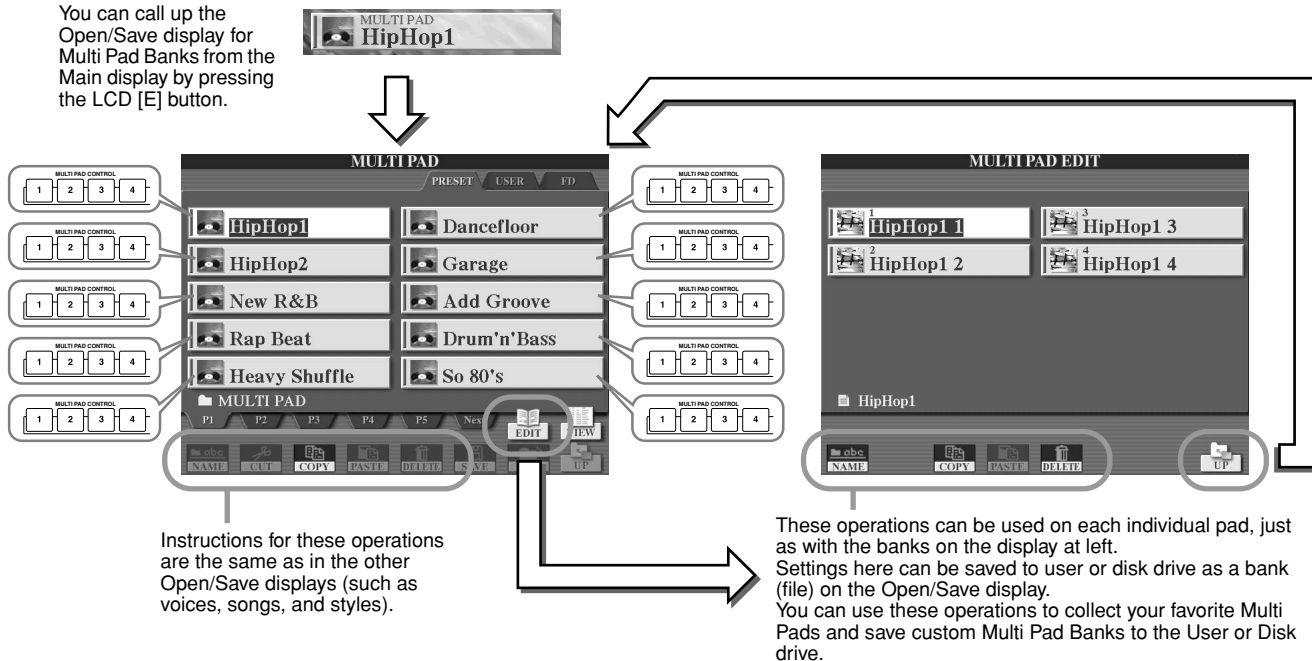

Multi Pad Creating/Editing (Digital Recording)

The Multi Pad Creator lets you create your original Multi Pad phrases.

Basic Procedure (Multi Pad Creator)

- 1 Select a Multi Pad Bank to be edited or created from the Open/Save display.
- 2 Press the [DIGITAL RECORDING] button.
- 3 Select “MULTI PAD CREATOR.”

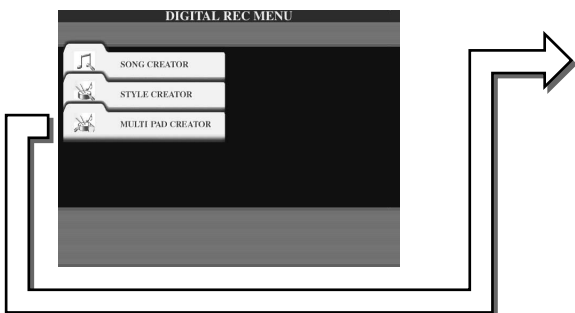

- 4 Create the Multi Pad data.

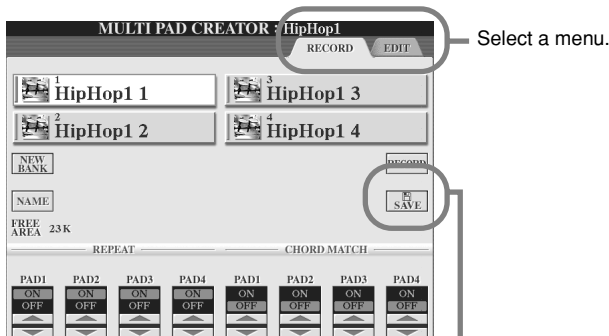

CAUTION

After you've finished creating/editing a Multi Pad, make sure to execute the Save operation. The recorded Multi Pad will be lost if you change to another bank or you turn the power off without executing the save operation (page 69).

■ Multi Pad Realtime Recording

The explanations here apply when you call up the RECORD page in step #4 of the Basic Procedure on page 124.

- ▶ **1** Select a particular Multi Pad for recording. If you want to create the Multi Pad data from scratch, press the [NEW BANK] LCD button to call up an empty bank.

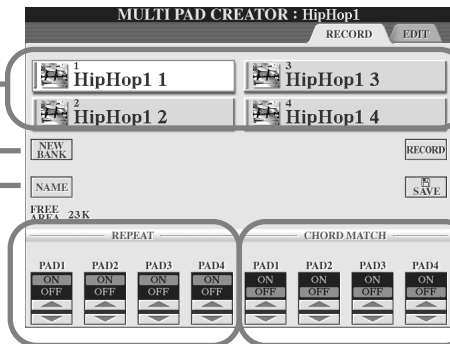

- ▶ **2** Execute the Realtime Recording.

- ▶ **6** After you've finished creating/editing a Multi Pad, make sure to execute the Save operation (page 69).

- ▶ **3** Turn Repeat of each pad On or Off.

- ▶ **4** Turn Chord Match of each pad On or Off.

- ▶ **5** Enter a name for each Multi Pad, as desired.

● Start recording

Press the [REC] LCD button to enable Synchro Start. Recording begins automatically as soon as you play on the keyboard.

You can also start recording by pressing the STYLE CONTROL [START/STOP] button. This lets you record as much silence as you want before the start of the Multi Pad phrase.

If Chord Match is set to on for the Multi Pad to be recorded, you should record using the notes of the C major seventh scale (C, D, E, G, A and B).



C = Chord note
C, R = Recommended note

● Stop recording

Press the [STOP] LCD button or the panel MULTI PAD [STOP] button to stop recording when you've finished playing the phrase.

● Repeat On/Off

If the Repeat parameter is on for the selected pad, playback of the corresponding pad will continue until the MULTI PAD [STOP] button is pressed. When you press the Multi Pads of which the Repeat is turned on during song or style playback, playback will start and repeat in sync with the beat.

If the Repeat parameter is off for the selected pad, playback will end automatically as soon as the end of the phrase is reached.

● Chord Match On/Off

If the Chord Match parameter is on for the selected pad, the corresponding pad is played back according to the chord specified in the chord section of the keyboard generated by turning [ACMP] on, or specified in the LEFT voice section of the keyboard generated by turning [LEFT] on (when turning the [ACMP] off).

■ Multi Pad Step Recording using the Event List

The explanations here apply to when you call up the EDIT page in step #4 of the Basic Procedure on page 124. The EDIT page indicates the Event list that lets you record notes with absolutely precise timing. This Step Recording procedure is essentially the same as that for Song Recording (pages 100 - 105), with the exception of the points listed below:

- There is no LCD button for switching channels, since Multi Pads contain data for only a single channel.
- In the Multi Pad Creator, only the channel events and System Exclusive messages can be entered. Chord and Lyrics events are not available. You can switch between the two types of Event Lists by pressing the LCD [F] button.

Music Finder

Quick Guide on page 40 ➔

This section briefly shows how to create and edit Music Finder records, and gives information about the structure and organization of Music Finder data. For basic instructions on using Music Finder, see the “Quick Guide.”

Music Finder Record Editing

From the [MUSIC FINDER] → RECORD EDIT display, you can call up existing records and edit them to suit your preferences. You can even use this to create your own Music Finder records which are saved to internal Flash ROM automatically.

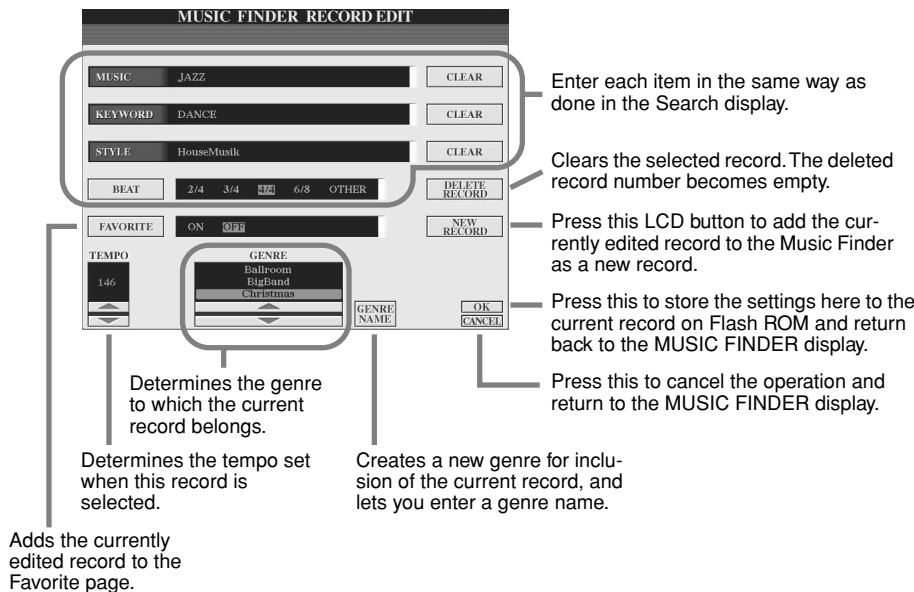

- NOTE**
- You can also change a preset record to create a new one. If you want to keep the original preset, make sure to name and register the edited record as a new record. Preset records can also be cleared.
 - Keep in mind that the Beat setting made here is only for the Music Finder search function; this does not affect the actual Beat setting of the style itself.
 - The maximum number of records is 2500, including preset records.

Saving Music Finder Records as a single file

All Music Finder records created and stored on the internal Flash ROM can be handled together as a single file. Keep in mind that individual records (panel setups) cannot be handled as separate files.

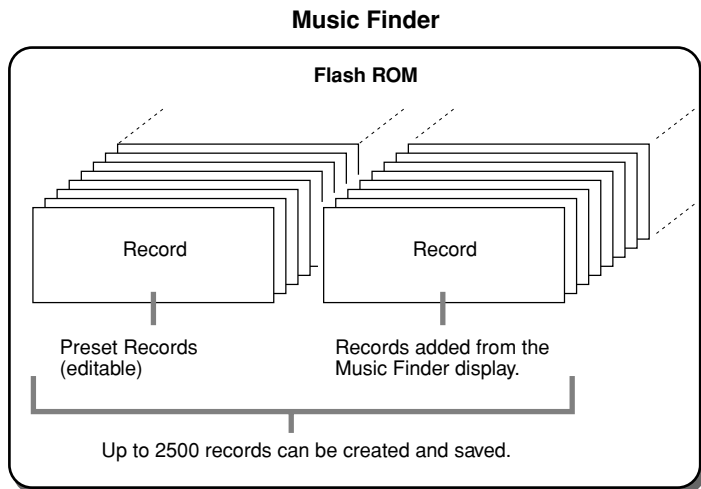

The Open/Save display for the Music Finder called up via [FUNCTION] → UTILITY → SYSTEM RESET → MUSIC FINDER lets you save the Music Finder file to the User or Disk drive. **All records can be saved together as a single file.**

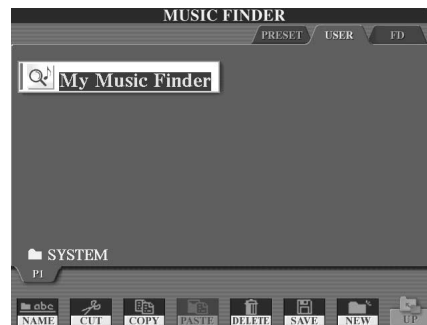

■ Restoring the Factory-programmed Music Finder.....

The operation below lets you restore the TYROS' Music Finder to its original factory settings.

▶ **1**

Press the [FUNCTION] button.

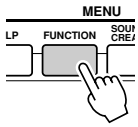

▶ **2** Select "UTILITY:"

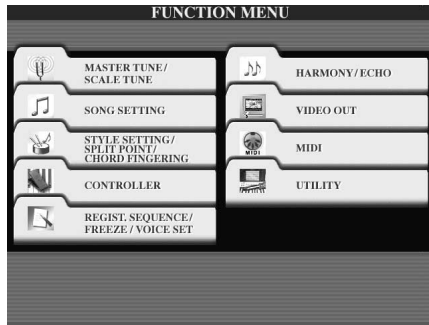

▶ **3** Checkmark the MUSIC FINDER box.

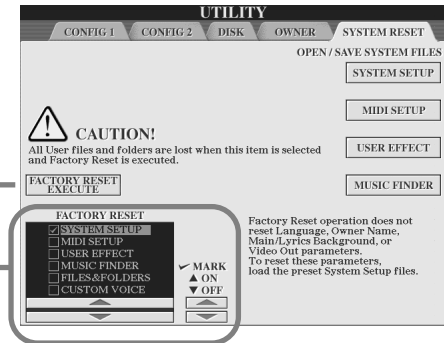

▶ **4** Executes the Factory Reset operation for the Music Finder.

CAUTION

This operation automatically deletes all your original records from internal memory and replaces them with the factory Music Finder data.

■ Calling up Music Finder files saved to User or Disk drive

You can call up Music Finder data saved to any of the installed drives by the following procedure.

Call up the Open/Save display for the Music Finder via [FUNCTION] → UTILITY → SYSTEM RESET → MUSIC FINDER.



Select the desired Music Finder file from the User or Disk drive.



All Music Finder records can be stored together as a single file. When selecting a stored file, a message appears prompting you to replace or append the records as desired.

REPLACE
All Music Finder records currently in the instrument are deleted and replaced with the records of the selected file.

APPEND
The records called up are added to the vacant record numbers.

Select one of the settings above to call up the Music Finder file. Select "CANCEL" to abort this operation.

You can select a Music Finder file from the Preset drive. This file is the factory-programmed Music Finder.

CAUTION

Selecting "REPLACE" automatically deletes all your original records from internal memory and replaces them with the factory Music Finder data.

Registration Memory

Quick Guide on page 51 ➔

Basic instructions on using the Registration Memory are explained in the “Quick Guide.” This section gives detailed information on the Freeze and Registration Sequence functions not covered in the “Quick Guide.”

■ About User Voices and Registration Memory

When you memorize a panel setup to Registration Memory that uses a User voice (on the User or Disk drive), keep in mind that the actual User voice is not memorized to Registration Memory — only its settings are.

Registration Memory saves and recognizes a User voice as:

- The preset voice on which the User voice is based
- The parameter settings made in Sound Creator

Selecting a Registration Memory number with User voice calls up the two above, and not the User voice on the drive. This means that the actual User voice could be changed or even deleted from the drive, and yet still be available in Registration Memory.

Freeze

Quick Guide on page 53 ➔

This section briefly covers details on the Freeze function. For basic instructions on Freeze, refer to the “Quick Guide.”

- ▶ **1** Call up the Registration Freeze display via [FUNCTION] → FREEZE and select the parameter group to be “frozen” or unchanged.

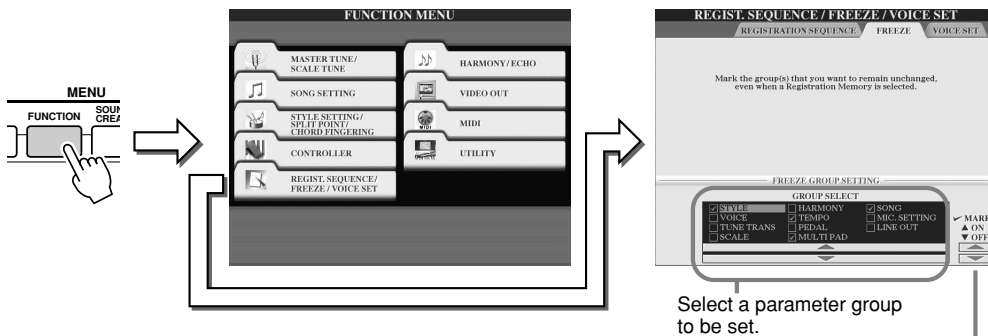

CAUTION
Settings in the Registration Freeze display are automatically saved to Flash ROM when you exit from the display. However, if you turn the power off without exiting from this display, the settings will be lost.

NOTE
• The settings on the Registration Freeze display can be saved to the User or Disk drive on the [FUNCTION] → UTILITY → SYSTEM SETUP display as a System Setup file (page 65).

- ▶ **2** Turn the [FREEZE] button on.
▶ **3** You can check whether your Freeze settings are correct or not by changing the Registration Memory number.



Registration Sequence

As convenient as the Registration Memory buttons are, there may be times during a performance when you want to quickly switch between settings — without having to take your hands from the keyboard. The convenient Registration Sequence function lets you call up the presets in any order you specify, by simply using the [BACK]/[NEXT] buttons or the pedal as you play.

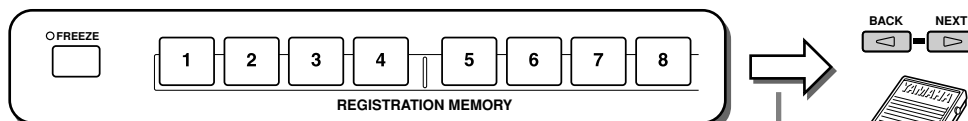

Two functions – changing a Bank according to the order listed on the Open/Save display and changing the Memory number according to the order determined from the Registration Sequence display – can be assigned to the [BACK]/[NEXT] button and the foot pedal connected to the TYROS.

- ▶ **1** Select a Registration Memory bank of which the sequence is programmed.
▶ **2** Call up the Registration Sequence display via [FUNCTION] → REGISTRATION SEQUENCE.

3 Program the Registration Sequence.

Determines which pedal is used to reverse (decrement) through the sequence.

Determines which pedal is used to advance (increment) through the sequence.

Indicates the file name of the selected Registration Memory bank.

Turns the Registration Sequence function on/off. When this is set to "ON," the programmed Registration Sequence is shown at the top right of the Main display, and you can step through the sequence in this display by using the [BACK]/[NEXT] buttons or the pedal.

Indicates the Registration Memory preset numbers, in the order of the current Registration Sequence.

Deletes all Registration Memory numbers in the sequence.

Deletes the number at the cursor position.

Inserts the number of the currently selected Registration Memory preset immediately before the cursor position.

Replaces the number at the cursor position with the currently selected Registration Memory number.

These move the cursor position in the sequence.

The controls in this section are used for specifying the order for calling up Registration Memory number as a Registration Sequence.

NOTE

- When both "Regist (+) Pedal" and "Regist (-) Pedal" are set to "OFF," the pedals cannot be used to step through the Registration Sequence; only the [BACK]/[NEXT] buttons can be used in the MAIN display.

CAUTION

Registration Sequence data is included as part of the Registration Memory bank file. To store your newly programmed Registration Sequence, save the current Registration Memory bank file (in step #5 below). Any Registration Sequence data is lost when changing Registration Memory banks or when turning the power off, unless you've saved it with the Registration Memory bank file.

Determines how Registration Sequence behaves when reaching the end of the sequence.

- STOP** Pressing the [NEXT] button or the "advance" pedal has no effect. The sequence is "stopped."
- TOP** The sequence starts again at the beginning.
- NEXTBANK** The sequence automatically moves to the beginning of the next Registration Memory bank in the same folder.

4 After setting the REGISTRATION SEQUENCE ENABLE to on, press the [EXIT] button to return to the Main display and confirm whether the Registration Memory numbers are called up according to the sequence programmed above.

- Use the [NEXT] button to call up the Registration Memory numbers in the order of the sequence, or use the [BACK] button to call them up in reverse order. The [BACK]/[NEXT] buttons can only be used for Registration Sequence when the Main display is called up.
- Use a connected foot pedal to select the Registration Memory numbers in order. The foot pedal can be used for Registration Sequence no matter which display is called up (except for the display in step #3 above).

The Registration Sequence is indicated at the top of the Main display, letting you confirm the currently selected number.

When the SEQUENCE END is set to "NEXT BANK," the sequence automatically moves to the beginning of the next Registration Memory bank in the same folder.

NOTE

- You can easily reset the Registration Sequence and go back to the first entry by holding down the pedal for a few seconds (the red box indicator at the top right goes out). Press and release the foot pedal to re-select the first entry in the sequence.

5 Call up the Open/Save display for the Registration Memory Bank and save the Registration Sequence setting as a Registration Memory Bank file.

Using a Microphone

Quick Guide on page 46 ➔

Connect a microphone to the TYROS and take advantage of the following features:

- **Song Score and Lyrics display (pages 88, 90)** — for ease in following along with a song.
- **Guide (page 48)** — for practicing your singing and learning the proper pitches.
- **Vocal Harmony (page 47)** — for automatically adding harmony vocals to your voice.
- **Talk (page 132)** — for instantly changing the microphone settings, for making announcements between songs.

You can also apply DSP effects to your voice or make other microphone-related settings from the Mixing Console display (page 134).

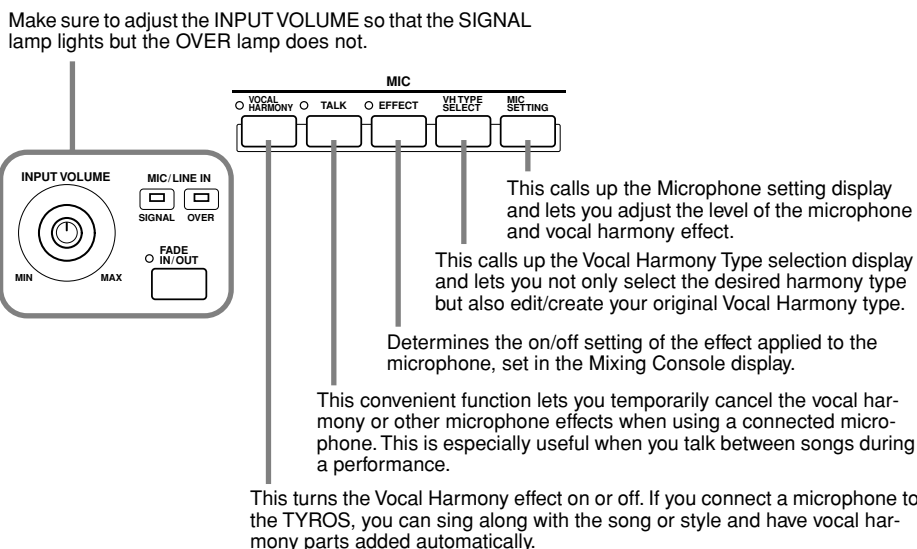

Vocal Harmony Edit

This section explains briefly how to create your own Vocal Harmony types, and lists the detailed parameters for editing. Up to ten Vocal Harmony types can be created and saved. For basic instructions on using Vocal Harmony, refer to the “Quick Guide.”

▶ **1**

Press the [VH TYPE SELECT] button.

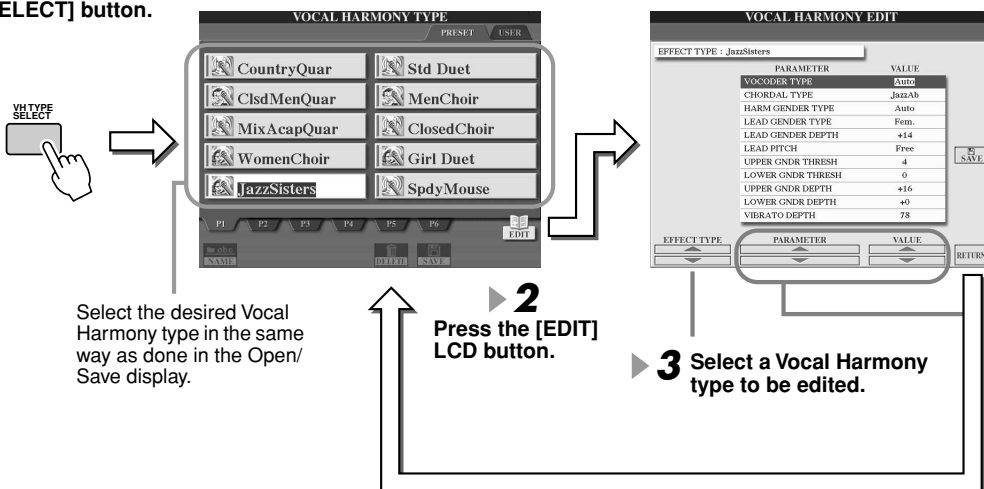

⚠ CAUTION

The settings here will be lost if you change to another Vocal Harmony type or you turn the power off without executing the save operation.

▶ **5**

Save the edited Vocal Harmony type to the User drive.

Vocal Harmony Edit parameters

VOCODER TYPE	Determines how the harmony notes are applied to the microphone sound when the Harmony mode (page 133) is set to “VOCODER.”
CHORDAL TYPE	Determines how the harmony notes are applied to the microphone sound when the Harmony mode (page 133) is set to “CHORDAL.”

HARMONY GENDER TYPE	Determines whether the gender of the harmony sound is changed or not. Off The gender of the harmony sound is not changed. Auto The gender of the harmony sound is changed automatically.
LEAD GENDER TYPE	Determines whether and how the gender of the lead vocal sound (i.e., the direct microphone sound) will be changed. Please note that the number of harmony notes differs depending on the selected type. When set to Off, three harmony notes are produced. Other settings produce two harmony notes. Off No gender change occurs. Unison No gender change occurs. You can adjust the LEAD GENDER DEPTH below. Male The corresponding gender change is applied to the lead vocal. Female The corresponding gender change is applied to the lead vocal.
LEAD GENDER DEPTH	Adjusts the degree of lead vocal gender change. This is available when the LEAD GENDER TYPE above is set to other than Off. The higher the value, the more “feminine” the harmony voice becomes. The lower the value, the more “masculine” the voice.
LEAD PITCH CORRECTION	When “Correct” is selected the pitch of the lead vocal is shifted in precise semitone steps. This parameter is only effective when the LEAD GENDER TYPE above is set to other than Off.
UPPER GENDER THRESHOLD	Gender change will occur when the harmony pitch reaches or exceeds the specified number of semitones above the lead vocal pitch.
LOWER GENDER THRESHOLD	Gender change will occur when the harmony pitch reaches or exceeds the specified number of semitones below the lead vocal pitch.
UPPER GENDER DEPTH	Adjusts the degree of gender change applied to harmony notes higher than the UPPER GENDER THRESHOLD. The higher the value, the more “feminine” the harmony voice becomes. The lower the value, the more “masculine” the voice.
LOWER GENDER DEPTH	Adjusts the degree of gender change applied to harmony notes lower than the LOWER GENDER THRESHOLD. The higher the value, the more “feminine” the harmony voice becomes. The lower the value, the more “masculine” the voice.
VIBRATO DEPTH	Sets the depth of vibrato applied to the harmony sound. Also affects the lead vocal sound when the LEAD GENDER TYPE above is set to other than Off.
VIBRATO RATE	Sets the speed of the vibrato effect. Also affects the lead vocal sound when the LEAD GENDER TYPE above is set to other than Off.
VIBRATO DELAY	Specifies the length of the delay before the vibrato effect begins when a note is produced. Higher values result in a longer delay.
HARMONY1/2/3 VOLUME	Sets the volume of the first/second/third harmony note.
HARMONY1/2/3 PAN	Specifies the stereo (pan) position of the first/second/third harmony note. Random The stereo position of the sound will change randomly whenever the keyboard is played. -63 – 0 – +63 A setting of -63 pans the sound hard left, while 0 is at center, and +63 is at hard right.
HARMONY1/2/3 DETUNE	Detunes the first/second/third harmony note by the specified number of cents.
PITCH TO NOTE	When this is set to “ON,” you can “play” the voices of the TYROS with your voice. (The TYROS tracks the pitch of your voice and converts it to note data for the tone generator. Keep in mind, however, that dynamic changes in your voice do not affect the volume of the tone generator.)
PITCH TO NOTE PART	Determines which of the TYROS parts will be controlled by the lead vocal when the Pitch to Note parameter is “ON.”

Talk Setting

This function is ideal for making announcements between your singing performances. When singing a song, several effects such as reverb, delay and vocal harmony are usually assigned to the MIC Setup. When speaking to your audience, however, these effects may sound disturbing or unnatural. Whenever the [TALK] button is turned on, Delay and Vocal Harmony effects turn off and the amount of reverb lowers automatically. Talk settings can be customized as well, allowing you to add any desired effects to your voice as you speak to your audience. Turning the [TALK] button off automatically recalls the MIC Setup for singing again.

Select a menu.

Press the [MIC SETTING] button.

If necessary, use the [BACK]/[NEXT] buttons to call up the Talk Setting display.

CAUTION

Settings in the Talk Settings display are automatically saved to Flash ROM when you exit from the display. However, if you turn the power off without exiting from this display, the settings will be lost.

NOTE

- The settings on the Talk Setting display can be saved to the User or Disk drive on the [FUNCTION] → UTILITY → SYSTEM SETUP display as a System Setup file (page 65)

For singing

MIC

● VOCAL HARMONY ○ TALK ● EFFECT

For talking

MIC

○ VOCAL HARMONY ● TALK ○ EFFECT

Talk Setting Parameters

VOLUME	This determines the output volume of the microphone sound.
PAN	This sets the stereo pan position of the microphone sound.
REVERB DEPTH	These set the depth of the reverb effects applied to the microphone sound.
CHORUS DEPTH	These set the depth of the chorus effects applied to the microphone sound.
TOTAL VOLUME ATTENUATOR	This determines the amount of attenuation to be applied to the overall sound (excepting the microphone input) — allowing you to effectively adjust the balance between your voice and the overall instrument sound.
DSP MIC ON/OFF	This turns the DSP effect applied to the microphone sound ON or OFF.
DSP MIC TYPE	This selects the type of DSP effect to be applied to the microphone sound.
DSP MIC DEPTH	This sets the depth of the DSP effect applied to the microphone sound.

Microphone Overall Settings

Press the [MIC SETTING] button.

If necessary, press the [BACK]/[NEXT] button to call up the Microphone Overall Settings display.

CAUTION

Settings in the Microphone Overall Settings display are automatically saved to Flash ROM when you exit from the display. However, if you turn the power off without exiting from this display, the settings will be lost.

Select the row at which the desired parameters are located by pressing the corresponding LCD button.

Set each parameter.

3BAND EQ

EQ (Equalizer) is a processor that divides the frequency spectrum into multiple bands which can be boosted or cut as required to tailor the overall frequency response. The TYROS features a high grade three-band digital equalizer function for the microphone sound.

- **Hz** Adjusts the center frequency of the corresponding band.
- **dB** Boosts or cuts the level of the corresponding band by up to 12 dB.

■ NOISE GATE

This effect mutes the input signal when the input from the microphone falls below a specified level. This effectively cuts off extraneous noise, allowing the desired signal (vocal, etc.) to pass.

- **SW (Switch)** This turns Noise Gate on or off.
- **TH. (Threshold)** This adjusts the input level at which the gate begins to open.

■ COMPRESSOR

This effect holds down the output when the input signal from the microphone exceeds a specified level. This is especially useful for smoothing out vocals that have widely varying dynamics. It effectively “compresses” the signal, making soft parts louder and loud parts softer.

- **SW (Switch)** This turns Compressor on or off.
- **TH. (Threshold)** This adjusts the input level at which compression begins to be applied.
- **RATIO** This adjusts the compression ratio.
- **OUT** Adjusts the final output level.

■ VOCAL HARMONY CONTROL

The following parameters determine how the harmony is controlled.

● VOCODER CONTROL

The Vocal Harmony effect is controlled by note data — the notes you play on the keyboard and/or the notes of the song data. This parameter lets you determine which notes are used to control the harmony.

SONG CHANNEL	<p>MUTE/PLAY When set to “MUTE,” the channel selected below is muted (turned off) during keyboard performance or song playback.</p> <p>OFF/1 - 16 When set to “OFF,” song data control over harmony is turned off. When set to one of the values 1 - 16, note data (played from a song on disk or external MIDI sequencer) contained on the corresponding channel is used to control the harmony.</p>
KEYBOARD	<p>OFF Keyboard control over harmony is turned off.</p> <p>UPPER Notes played to the right of the split point (page 112) control the harmony.</p> <p>LOWER Notes played to the left of the split point (page 112) control the harmony.</p>

● BAL (Balance)

This lets you set the balance between the lead vocal (your own voice) and Vocal Harmony. Raising this value increases the volume of the Vocal Harmony and decreases that of the lead vocal. When this is set to L<H63 (L: Lead Vocal, H: Vocal Harmony), only the Vocal Harmony is output; when it is set to L63>H, only the lead vocal is output.

● MODE (Vocal Harmony mode)

All of the Vocal Harmony types fall into one of three modes which produce harmony in different ways. The harmony effect is dependent on the selected Vocal Harmony mode, and this parameter determines how the harmony is applied to your voice. The three modes are described below.

VOCODER	The harmony notes are determined by the notes you play on the keyboard and/ or song data.
CHORDAL	The harmony notes are determined by the following three types of chord: chords played in the chord section of the keyboard (with the [ACMP] turned on), chords played in the LEFT voice section of the keyboard (with the [ACMP] turned off and the [LEFT] turned on), and chords contained in song data for controlling the harmony. (Not available if the song does not contain any chord data.)
AUTO	When the [ACMP] or [LEFT] is set to ON and if chord data exists in the song, the mode is automatically set to CHORDAL. In all other cases, the mode is set to VOCODER.

● CHORD

The following parameters determine which data in a recorded song is used for chord detection.

OFF	Chords are not detected from the song data.
XF	Chords of XF format are used for the Vocal Harmony.
1 - 16	Chords are detected from note data in the specified song channel.

■ MIC (Microphone)

The following parameters determine how the microphone sound is controlled.

MUTE	When set to OFF, the microphone sound is turned off.
VOLUME	Adjusts the output volume of the microphone sound.

Mixing Console

There are many components that make up the overall sound of the TYROS. These include MIDI sequence data from the songs, styles, and Multi Pads, and audio input from a microphone, as well as the various parts of your keyboard performance. The Mixing Console gives you control over the volume and pan settings of each of these components — and some other settings as well — letting you fine-tune the overall sound of the TYROS.

Parts making up the TYROS sound

● **Keyboard parts**

Consists of RIGHT1, RIGHT2, RIGHT3, LEFT.

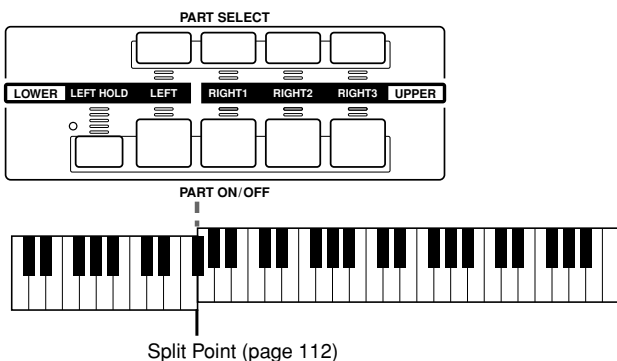

● **Multi Pad parts**

Consists of Multi Pads 1, 2, 3, and 4



● **Microphone sound part**



● **Song parts**

Consists of 1 - 16 channels.

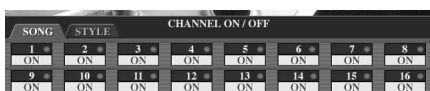

● **Style parts**

Consists of Rhythm 1, 2, Bass, Chord1, 2, Pad, Phrase 1, 2



Basic Procedure (Mixing Console)

- 1** Press the [MIXING CONSOLE] button to call up the Mixing Console display.
- 2** Use the [BACK]/[NEXT] buttons to call up the desired page.
- 3** Press the [MIXING CONSOLE] button several times until the desired parts are displayed. Pressing the [MIXING CONSOLE] button alternates among the displays as listed below.
- 4** Select the row at which the desired parameters are located by pressing the corresponding LCD button.
- 5** Set each parameter.
- 6** If necessary, store the settings from the Mixing Console display.

The diagram shows the Mixing Console (PANEL PART) with various controls and buttons. A flowchart for step 3 shows the sequence of displays: All parts, Style channels, Song channels 1-8, and Song channels 9-16.

Basic instructions on saving the settings are given below, and brief explanations of the parameters are on the next page. For details on the parameters, refer to the separate Data List booklet.

- The settings of the keyboard parts, Style part, Multi Pad part, and Microphone sound part can be memorized to the Registration Memory (page 51).
- The settings of the Song part can be saved as a song to the User or Disk drive. After setting, call up the CHANNEL display of the Song Creator, press the [EXECUTE] LCD button on this display to reflect the settings to the song data on RAM, then save the song to the User or Disk drive (page 55).

Part Settings

The explanations here apply to step #5 of the Basic Procedure on page 134. The parameters explained below can be set on the display pages called up in step #2 of the Basic Procedure on page 134.

VOL/VOICE page parameters

SONG AUTO REVOICE	See page 136.
VOICE	Calls up the VOICE display, from which you can select the desired voice for each part. When the Style channels are called up in step #3 of the Basic Procedure on page 134, neither Organ Flutes voices nor User voices can be selected. When the Song channels are called up in step #3 of the Basic Procedure on page 134, User voices cannot be selected. Please note that the voice of the Multi Pad cannot be changed via the Mixing Console.
PANPOT	Determines the stereo position of the selected part (channel). A setting of 0 pans the sound hard left, while 64 is at center, and 127 is at hard right.
VOLUME	Determines the level of each part or channel, giving you fine control over the balance of all the parts.

NOTE

- The RHY1 channel in the STYLE PART display can be assigned to any voice except the Organ Flute voice.
- When playing GM song data, channel 10 (in the SONG CH 9 - 16 page) can only be used for a Drum Kit voice.
- When changing the rhythm/percussion voices (drum kits, etc.) of the style and song from the VOICE parameter, the detailed settings related to the drum voice are reset, and in some cases you may be unable to restore the original sound. In the case of song playback, you can restore the original sound by returning to the beginning of the song and playing back from that point. In the case of style play, you can restore the original sound by selecting the same style again.

FILTER page parameters

HARMONIC CONTENT	Allows you to adjust the resonance effect (page 87) for each part.
BRIGHTNESS	Determines the brightness of the sound for each part by adjusting the cutoff frequency (page 87).

TUNE page parameters

PORTAMENTO TIME	Portamento is a function that creates a smooth transition in pitch from the first note played on the keyboard to the next. The Portamento Time determines the pitch transition time. Higher values result in a longer pitch change time. Setting this to "0" results in no effect. This parameter is available when the selected keyboard part is set to Mono (page 81).
PITCH BEND RANGE	Determines the range of the PITCH BEND wheel for each keyboard part. The range is from "0" to "12" with each step corresponding to one semitone.
OCTAVE	Determines the range of the pitch change in octaves, over two octaves up or down for each keyboard part. The value set here is added to the setting via the [OCTAVE] button.
TUNING	Determines the pitch of each keyboard part.
TRANSPOSE	Allows the pitch to be transposed up or down in semitone increments. Setting this to "MASTER" transposes the overall sound of the instrument, while "SONG" transposes song playback, and "KEYBOARD" transposes the keyboard pitch, as well as that of style playback and the Multi Pads (since these are also affected by keyboard play in the left-hand section).

NOTE

- As described at left, in addition to the Master Transpose setting, there are two other transpose controls: Keyboard Transpose and Song Transpose. These can be used to match both the song and your keyboard performance to a certain key. For example, let's say you wish to both play and sing along with a certain recorded song. The song data is in F, but you feel most comfortable singing in D, and you are accustomed to playing the keyboard part in C. To match up the keys, set the Master Transpose to "0," the Keyboard Transpose to "2," and the Song Transpose to "-3." This brings the keyboard part up and the song data down to your comfortable singing key.

EFFECT page parameters

TYPE	Page 138
REVERB	Adjusts the Reverb Send Level (page 137) for each part or channel.
CHORUS	Adjusts the Chorus Send Level (page 137) for each part or channel.
DSP	Adjusts the DSP Effect Dry/Wet Level for each part or channel.

EQ page parameters

TYPE	Page 139
EDIT	Page 139
EQ HIGH	Determines the center frequency of the high EQ band that is attenuated/boosted for each part.
EQ LOW	Determines the center frequency of the low EQ band that is attenuated/boosted for each part.

Song Auto Revoice

This feature lets you use the stunning sound of the TYROS to full advantage with XG-compatible song data. When you play back any commercially available XG song data or that created on other instruments, you can use Auto Revoice to automatically assign the specially created voices of the TYROS (Natural!, Live!, Cool!, etc.) instead of the conventional XG voices of the same type. To do this, simply turn on Song Auto Revoice (from the VOL/VOICE display page), and the TYROS uses its unique, superior sound set instead of the normal XG counterparts. You can even specify your own favorite voices for this function and make other detailed settings via the [SETUP] LCD button.

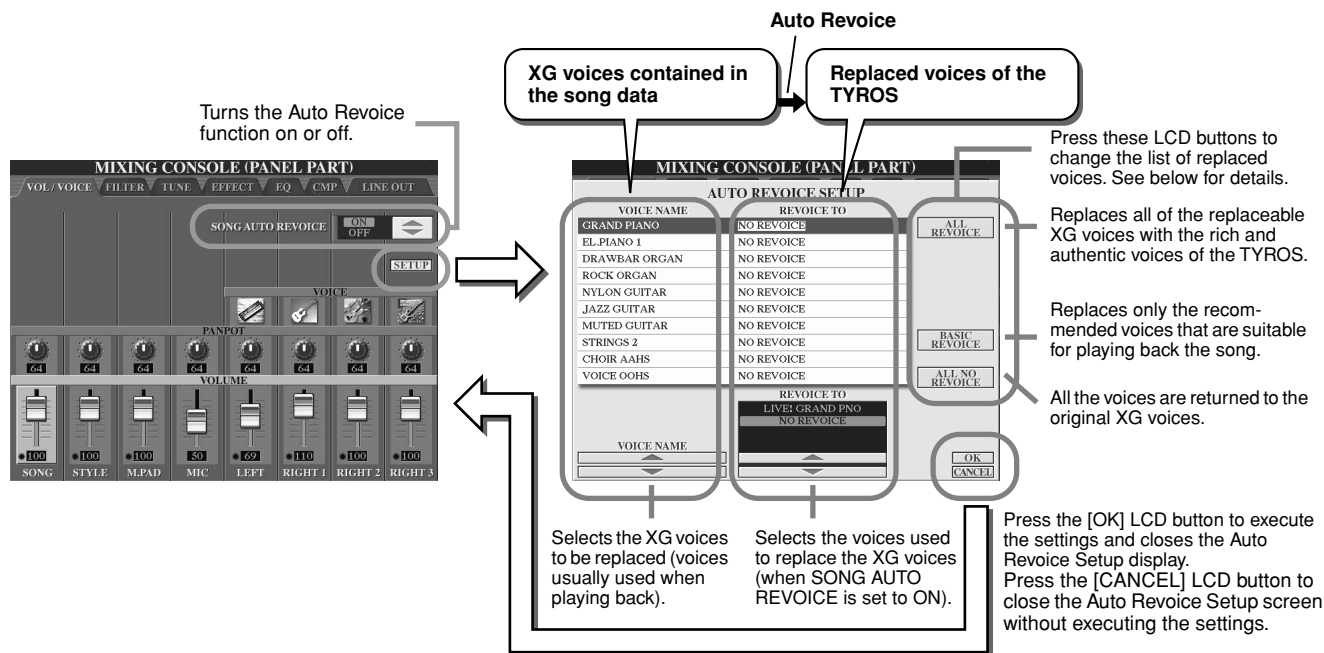

Effects

The TYROS has a wide variety of high-quality effects — including Reverb, Chorus, and a diverse selection of DSP (Digital Signal Processor) effects — that can be used to independently enhance or change the sound of the various parts (keyboard, style, song, Multi Pads, and microphone sound).

■ Effect Block

	Parts to which the effects are applied	Characteristics	Effect Connection	Number of User Effect
Reverb	All parts	Reproduces the warm ambience of playing in a concert hall or jazz club.	System	3
Chorus	All parts	Produces a rich “fat” sound as if several parts are being played simultaneously.	System	3
DSP1	Style part (all channels) + Song part (all channels)	In addition to the Reverb and Chorus types, the TYROS has special DSP effects, that include additional effects usually used for a specific part, such as distortion and tremolo.	System/ Insertion	3
DSP2 DSP3 DSP4 DSP5	RIGHT1, RIGHT2, RIGHT3, LEFT, Song part (all channels)	Any unused DSP blocks are automatically assigned to the appropriate parts (channels) as needed.	Insertion	10
DSP6	Microphone sound	Dedicated for use only with the microphone sound.	Insertion	10
Vocal Harmony	Microphone sound	Page 130	Insertion	10
Master EQ	All parts	Page 139	System	2
Part EQ	Style part (all channels), Multi Pad part, Song part (all channels), RIGHT1, RIGHT2, RIGHT3, LEFT	Page 135	—	0
Master Compressor	All parts	Page 140	System	5

■ System Effects and Insertion Effects

All the effect blocks are connected or routed in one of two ways: System or Insertion. System applies the selected effect to all parts, while Insertion applies the selected effect to one specific part.

The DSP 1 effect can be configured for either System or Insertion routing via the Effect Parameter settings (page 138).

■ Effect Signal Flow Chart

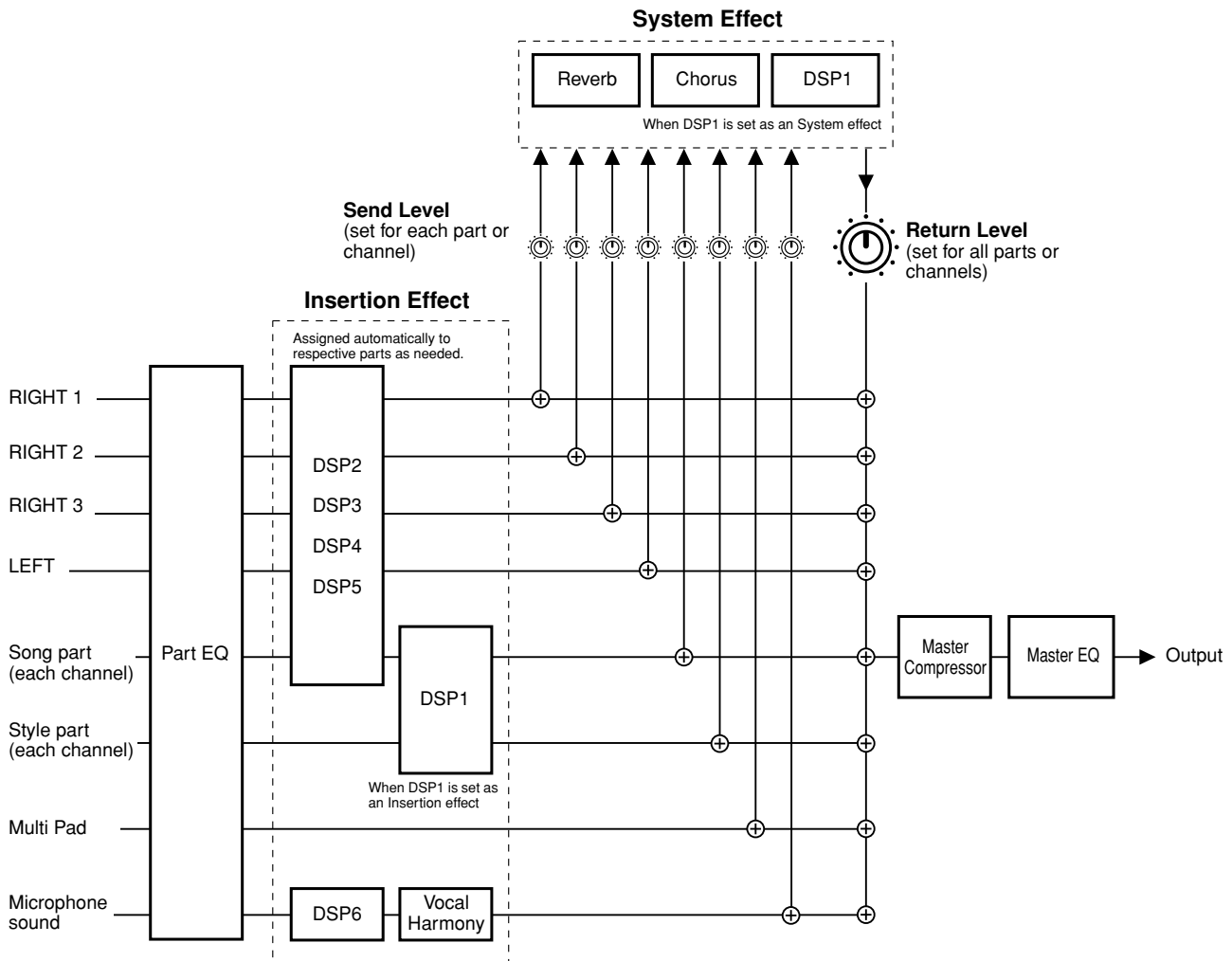

NOTE

• About DSP 1

In most cases, the DSP 1 effect block is available for either the song or style part. For songs and styles, the effect block is applied to only the last selected or played part. For example, when selecting or starting a song during style playback, the DSP 1 effect applied to the style part is cancelled and is applied instead to the song part. Particularly if the style data originally is processed with a distortion effect of DSP 1, this operation may result in disrupting the overall volume balance among the style parts (channels). Note that the same problem may occur when starting or selecting a style during song playback.

• About DSP 2 - 5

The effect blocks DSP 2 through 5 are available independently for the keyboard parts and song parts. Only that part which has been assigned to an effect block can use that effect. For example, if you select or start a song, the DSP effect applied to the keyboard part is cancelled and is applied instead to the song. Pressing the [DSP] button on the panel restores the corresponding effect block to the current keyboard part (from the song).

■ Selecting an Effect type and creating a User Effect

Various types of Effects are provided for each Effect Block listed on page 137. Each Effect type can be edited with the parameters (see the Effect Type Edit display below) and saved as a User Effect Type.



● Effect Type Selection display for each block

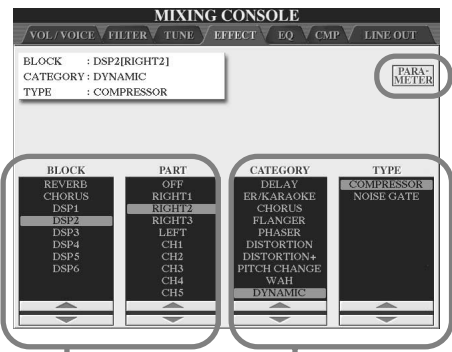

Select an Effect Block and a part to which the corresponding effect is applied. Please note that a part cannot be selected if the selected block is used as a System Effect. See the Effect Block list on page 136.

Select an Effect type after selecting a category.

● Effect Type Edit

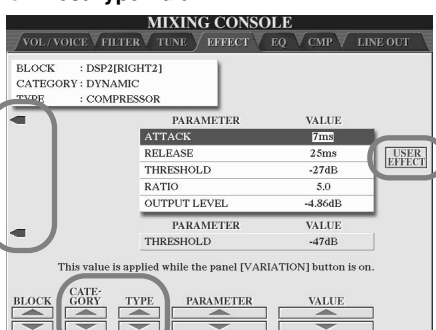

Select a block to which the desired effect type belongs.

When the edited effect block is a System Effect, the Effect Return Level parameter (page 137) can be adjusted here.

Select a parameter to be edited. Parameters displayed differ depending on the selected Effect type. Refer to the separate Data List booklet for details.

Select an Effect category/type to be edited.

The value of the parameters when turning the [VARIATION] on can be set as for the DSP2 - 5 blocks. Use these LCD buttons to switch between the upper/lower parameters. For the lower parameter, the depth can be changed when the [VARIATION] button is on.

● User Effect Type Save



Changes the name of the Effect type selected at left.

Pressing the [SAVE] LCD button calls up the pop-up window for entering the name of the edited Effect type. Enter the desired name and press the [OK] LCD button to save the edited effect to the location specified at left.

Select the destination to which the effect is to be stored. The number of memory spaces available for the destination differs for each block (page 136).

NOTE

- Keep in mind that in some cases noise may result if you adjust the effect parameters while playing the instrument.

Equalizer (EQ)

Equalizer (also called “EQ”) is a sound processor that divides the frequency spectrum into multiple bands which can be boosted or cut as required to tailor the overall frequency response.

Usually an equalizer is used to correct the sound from speakers to match the special character of the room. The sound is divided into several frequency bands, allowing you to correct the sound by raising or lowering the level for each band. EQ allows you to adjust the tone or timbre of the sound to match the performance space, or to compensate for certain acoustic characteristics in your room. For example, you can cut some of the low range frequencies when playing in large spaces where the sound is too “boomy,” or boost the high frequencies in rooms and close spaces where the sound is relatively “dead” and free of echoes.

The TYROS possesses a high grade five-band digital EQ. With this function, a final effect—tone control—can be added to the output of your instrument. You can even create your own custom EQ settings by adjusting the frequency bands, and save the settings to one of two User Master EQ types. Along with the five Preset EQ settings, these can be called up as needed from the [MIXING CONSOLE] → EQ display.

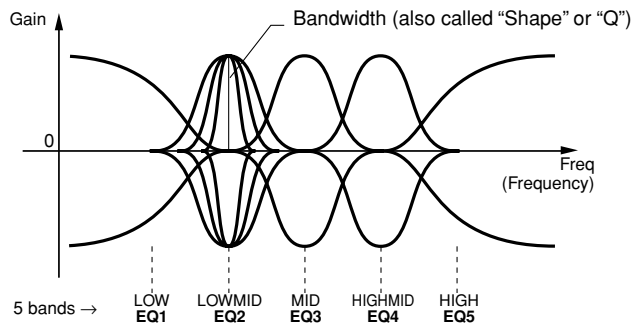

● Master EQ type selection and Part EQ adjusting



Select a Master EQ type.

● Master EQ type editing

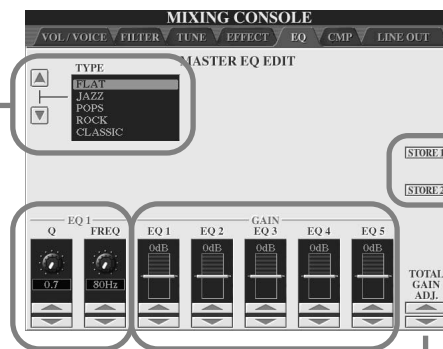

Selecting a Master EQ type automatically set the parameters displayed at the bottom of this display.

The PRESET and USER curves can be edited as required via the corresponding buttons. Each of the five bands can be boosted or cut by up to 12 dB.

Use the [STORE] LCD buttons to call up the pop-up window for entering the name of the edited Master EQ type. Enter the desired name and press [OK] to save. Up to two types of EQ can be created and saved.

Adjusts the overall gain of all EQ bands simultaneously.

Whenever an EQ band is edited, the corresponding EQ value is highlighted and the number of the edited band appears above the Q and FREQ controls. The Q and FREQ controls can then be used to adjust the Q (bandwidth) and the FREQ (center frequency) of the selected band. The higher the “Q”, the narrower the bandwidth. The available FREQ range is different for each band.

Master Compressor

Compressor is an effect commonly used to limit and compress the dynamics (softness/loudness) of an audio signal. For signals that vary widely in dynamics, such as vocals and guitar parts, it “squeezes” the dynamic range, effectively making soft sounds louder and loud sounds softer. When used with gain to boost the overall level, this creates a more powerful, more consistently high-level sound. Compression can be used to increase sustain for electric guitar, smooth out the volume of a vocal, or bring a drum kit or rhythm pattern further up-front in the mix.

The TYROS has a sophisticated multi-band compressor that allows you to adjust the compression effect for individual frequency bands — giving you detailed sonic control. You edit and save your own custom Compressor types, or conveniently select from one of the presets by calling up the [MIXING CONSOLE] → CMP display.

● Master Compressor type selection and editing

Selecting a Master Compressor type automatically sets the parameters (at the bottom of the display) to the optimum values for the type.

Turns the Master Compressor effect on or off.

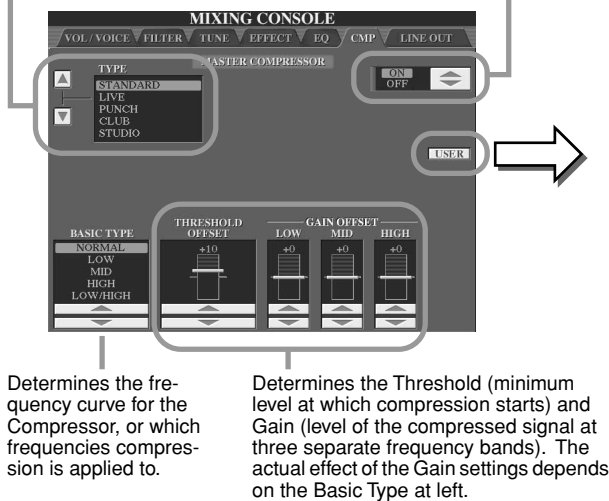

● Master Compressor saving

The following display lets you save the Master Compressor settings from the display shown at left as a User Compressor type.

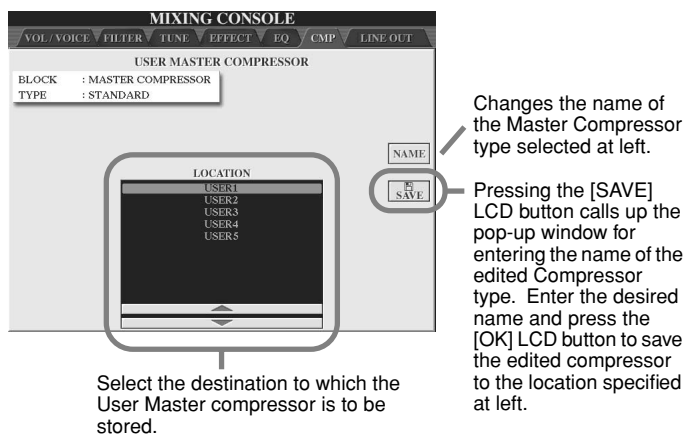

Line Out Settings

The [MIXING CONSOLE] → LINE OUT display allows you to send the output of a selected Part or Parts to the LINE OUT jacks. For Drum Parts, you can even select specific drum sounds to be output through these jacks.

In general, the extensive built-in effects and other Part controls of the TYROS provide all you need for processing and mixing complex multi-Part songs. However, there may be times when you want to “sweeten” or process a certain Voice or sound with a favorite outboard effect unit, or record a Part to a separate track of a tape recorder. The Line Out settings are designed just for these kinds of applications.

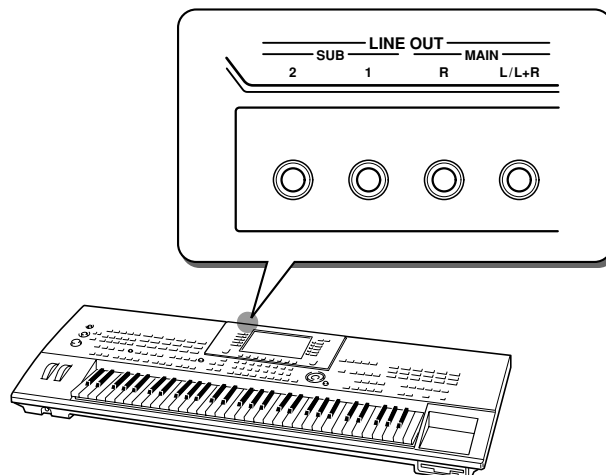

● Line Out settings for each part or channel

MIXING CONSOLE						
VOL/VOICE	FILTER	TUNE	EFFECT	EQ	CMP	LINE OUT
PANEL						
PART	MAIN	SUB1	SUB2	SUB1&2	DRUM	
RIGHT1	<input checked="" type="checkbox"/>					
RIGHT2	<input checked="" type="checkbox"/>					
RIGHT3	<input checked="" type="checkbox"/>					
LEFT						
MIC		<input checked="" type="checkbox"/>				
MULTI PAD 1			<input checked="" type="checkbox"/>			
MULTI PAD 2			<input checked="" type="checkbox"/>			
MULTI PAD 3			<input checked="" type="checkbox"/>			
MULTI PAD 4			<input checked="" type="checkbox"/>			
RHYTHM 1	<input checked="" type="checkbox"/>					
RHYTHM 2	<input checked="" type="checkbox"/>					
BASS	<input checked="" type="checkbox"/>					
PART	MAIN	SUB1	SUB2	SUB1&2	MARK	
	<input checked="" type="checkbox"/>	<input checked="" type="checkbox"/>	<input checked="" type="checkbox"/>	<input checked="" type="checkbox"/>	<input checked="" type="checkbox"/>	

Set the output configuration for the selected part by checkmarking or un-checkmarking the appropriate column (jack).

Select the desired part.

● Line Out settings for each instrument (key)

MIXING CONSOLE						
VOL/VOICE	FILTER	TUNE	EFFECT	EQ	CMP	LINE OUT
PERCUSSION						
DRUM	DEPENDS ON PART	MAIN	SUB1	SUB2	SUB1&2	PANEL
BASS DRUM	<input checked="" type="checkbox"/>					
SNARE DRUM		<input checked="" type="checkbox"/>				
HI HAT						
TOM				<input checked="" type="checkbox"/>		<input checked="" type="checkbox"/>
CRASH CYMBAL		<input checked="" type="checkbox"/>				
RIDE CYMBAL		<input checked="" type="checkbox"/>				
CYMBAL						
LATIN PERCUSSION	<input checked="" type="checkbox"/>					
LATIN HIGH PITCH	<input checked="" type="checkbox"/>					
OTHERS	<input checked="" type="checkbox"/>					
DRUM	DEPENDS ON PART	MAIN	SUB1	SUB2	SUB1&2	MARK
	<input checked="" type="checkbox"/>	<input checked="" type="checkbox"/>	<input checked="" type="checkbox"/>	<input checked="" type="checkbox"/>	<input checked="" type="checkbox"/>	<input checked="" type="checkbox"/>

Set the output configuration for the selected drum sound by checkmarking or un-checkmarking the appropriate column (jack).

• **When checkmarking the box of "DEPEND ON PART":**
The selected drum sound will be output via the jacks set from the PANEL page at left.

• **When checkmarking the box of one of a column other than "DEPEND ON PART":**
An individual percussion setting overrides the Part settings made from the PANEL page at left.

Select the desired drum instrument.

■ MAIN jacks

The part, channel or percussion sound of which the MAIN box is checkmarked will be output from the following jacks. This output sound includes the effect settings.

- MAIN jacks on the rear panel
- PHONES jack
- LOOP SEND jack
- Optional Speaker

■ SUB jacks

The part, channel, or percussion sound of which the SUB1, SUB2, or SUB1&2 box is checkmarked will be output from the jacks as described below.

- When any of the SUB1/SUB2/SUB1&2 boxes are checkmarked, the part (channel) or percussion sound will be output via the corresponding jacks. In this case, only Insertion effects can be applied; System effects and other effects will not be applied to the output sound.
- When any of the SUB1/SUB2/SUB1&2 boxes are checkmarked, the part (channel) or percussion sound will not be output through the PHONES jack.
- When the SUB1&2 box is checkmarked, the part (channel) or percussion sound will be output in stereo (1: left, 2: right).
- When the SUB1/SUB2 box is checkmarked, the part (channel) or percussion sound will be output in mono, respectively.

NOTE

- When using one of the SUB Line Out settings, make sure that you've connected cables to the appropriate LINE OUT SUB jacks on the rear panel. If cables are only connected to the MAIN jacks, the sound of the Part will be output through the MAIN jacks, even if one of the SUB1/SUB2/SUB1&2 is checkmarked.

MIDI

Built into the rear panel of the TYROS are two sets of MIDI terminals (MIDI IN A/B, MIDI OUT A/B), and a USB terminal. The MIDI Functions give you a comprehensive, powerful set of tools for expanding your music recording and performance possibilities. This section explains what MIDI is, and what it can do, as well as how you can use MIDI on your TYROS.

What's MIDI

No doubt you have heard the terms “acoustic instrument” and “digital instrument.” In the world today, these are the two main categories of instruments. Let's consider an acoustic piano and a classical guitar as representative acoustic instruments. They are easy to understand. With the piano, you strike a key, and a hammer inside hits some strings and plays a note. With the guitar, you directly pluck a string and the note sounds. But how does a digital instrument go about playing a note?

● Acoustic guitar note production

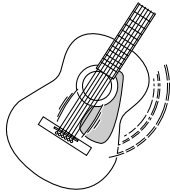

Pluck a string and the body resonates the sound.

● Digital instrument note production

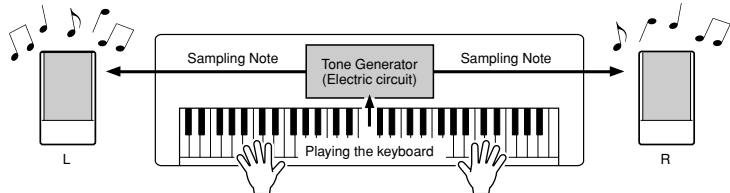

Based on playing information from the keyboard, a sampling note stored in the tone generator is played through the speakers.

As shown in the illustration above, in an electronic instrument the sampling note (previously recorded note) stored in the tone generator section (electronic circuit) is played based on information received from the keyboard. So then what is the information from the keyboard that becomes the basis for note production?

For example, let's say you play a “C” quarter note using the grand piano sound on the TYROS keyboard. Unlike an acoustic instrument that puts out a resonated note, the electronic instrument puts out information from the keyboard such as “with what voice,” “with which key,” “about how strong,” “when was it pressed” and “when was it released.” Then each piece of information is changed into a number value and sent to the tone generator. Using these numbers as a basis, the tone generator plays the stored sampling note.

● Example of Keyboard Information

Voice number (with what voice)	01 (grand piano)
Note number (with which key)	60 (C3)
Note on (when was it pressed) and note off (when was it released)	Timing expressed numerically (quarter note)
Velocity (about how strong)	120 (strong)

As described above, your keyboard performance and panel operations such as voice selection are handled as MIDI events. All the data of Style, Song, and Multi Pad played back or recorded consist of MIDI messages.

MIDI (Musical Instrument Digital Interface) allows electronic musical instruments to communicate with each other, by sending and receiving compatible Note, Control Change, Program Change and various other types of MIDI data, or messages. The TYROS can control a MIDI device by transmitting note related data and various types of controller data. The TYROS can be controlled by the incoming MIDI messages which automatically determine tone generator mode, select MIDI channels, voices and effects, change parameter values and of course play the voices specified for the various parts. MIDI messages can be divided into two groups: Channel messages and System messages.

Below is an explanation of the various types of MIDI messages which the TYROS can receive/transmit.

● Channel Messages

The TYROS is an electronic instrument that can handle 32 channels (16 channels x 2 ports). This is usually expressed as “it can play 32 instruments at the same time.” Channel messages transmit information such as Note ON/OFF, Program Change, for each of the 32 channels.

Message Name	TYROS Operation/Panel Setting
Note ON/OFF	Messages which are generated when the keyboard is played. Each message includes a specific note number which corresponds to the key which is pressed, plus a velocity value based on how hard the key is played.
Program Change	Voice selecting
Control Change	Volume, panpot (Mixing Console), etc.
Pitch Bend	Pitch Bend Wheel operation

● System Messages

This is data that is used in common by the entire MIDI system. System messages include messages like System Exclusive Messages that transmit data unique to each instrument manufacturer and Realtime Messages that control the MIDI device.

Message Name	TYROS Operation/Panel Setting
System Exclusive Message	Effect type settings (Mixing Console), etc.
Realtime Messages	Clock setting, Start/stop operation

MIDI channels

MIDI performance data is assigned to one of sixteen MIDI channels. Using these channels, 1 - 16, the performance data for sixteen different instrument parts can be simultaneously sent over one MIDI cable.

Think of the MIDI channels as TV channels. Each TV station transmits its broadcasts over a specific channel. Your home TV set receives many different programs simultaneously from several TV stations and you select the appropriate channel to watch the desired program.

MIDI operates on the same basic principle. The transmitting instrument sends MIDI data on a specific MIDI channel (MIDI Transmit Channel) via a single MIDI cable to the receiving instrument. If the receiving instrument's MIDI channel (MIDI Receive Channel) matches the Transmit Channel, the receiving instrument will sound according to the data sent by the transmitting instrument.

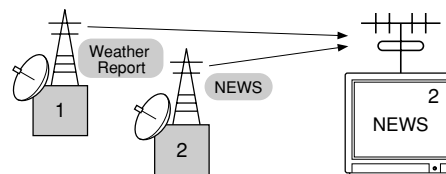

For example, several parts or channels can be transmitted simultaneously, including the style data (as shown at right).

As you can see, it is essential to determine which data is to be sent over which MIDI channel when transmitting MIDI data (page 146). The TYROS also allows you to determine how the received data is played back (page 147).

Though MIDI is designed to handle up to sixteen channels, the use of separate MIDI "ports" allows for even more. The TYROS has two MIDI ports, allowing simultaneous use of thirty-two channels.

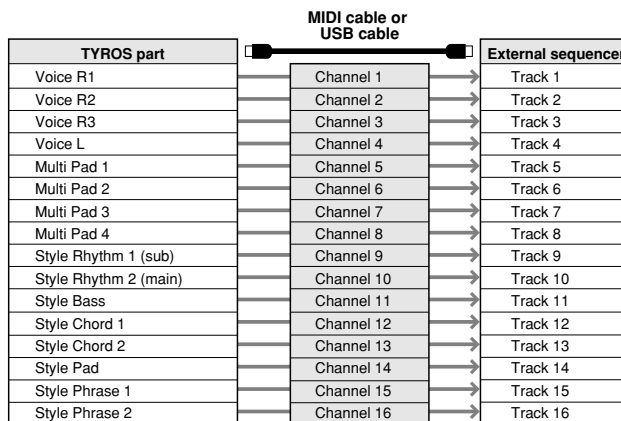

MIDI connection between the TYROS and other MIDI instruments

MIDI messages (events) described above are transmitted or received via two sets of MIDI terminals (MIDI A IN/OUT, MIDI B IN/OUT) or the USB connector.

- **MIDI IN** Receives MIDI data from another MIDI device. Two ports (A, B) are provided and each can receive MIDI messages of 16 channels.
- **MIDI OUT** Transmits the TYROS' keyboard information as MIDI data to another MIDI device. Two ports (A, B) are provided and each can transmit MIDI messages of 16 channels.
- **USB** Transmits and receives MIDI data to and from a computer. Both MIDI ports are accessible over USB.

To transmit/receive MIDI data between two devices, a proper cable connection is needed. You can connect the TYROS to another device by MIDI cables (using the MIDI terminals) or by a USB cable (using the USB connectors). (See page 58.)

MIDI connection via MIDI cable

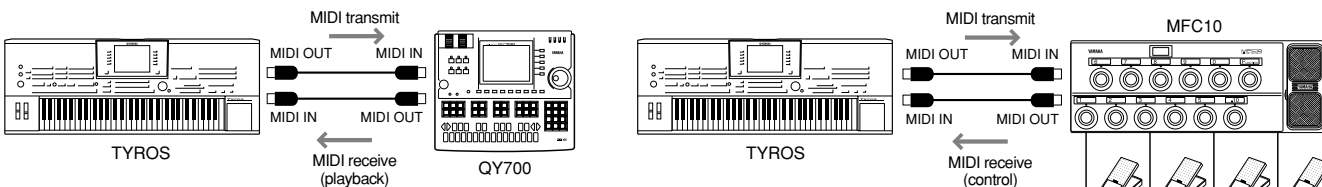

MIDI connection via USB cable

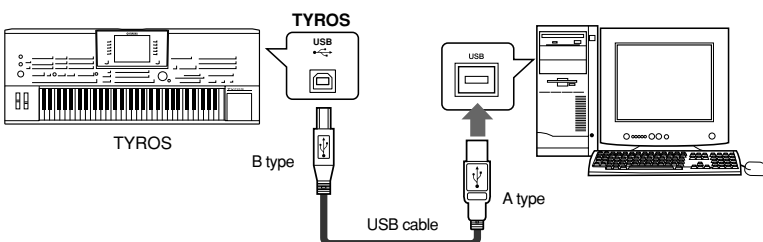

MIDI Data Compatibility

This section covers basic information on data compatibility: whether or not other MIDI devices can playback the data recorded by TYROS, and whether or not the TYROS can playback commercially available song data or song data created for other instruments or on a computer. Depending on the MIDI device or data characteristics, you may be able to play back the data without any problem, or you may have to perform some special operations before the data can be played back. If you run into problems playing back data, please refer to the information below.

Sequence format

“Sequence format” refers to the way in which MIDI data (for playback, such as songs and styles) is stored to disk. A number of popular sequence formats described below are compatible with the TYROS. Playback is only possible when the sequence format of the disk matches that of the MIDI device.

● SMF (Standard MIDI File)

This is the most common sequence format. Standard MIDI Files are generally available as one of two types: Format 0 or Format 1. Many MIDI devices are compatible with Format 0, and most commercially available software is recorded as Format 0. The TYROS is compatible with both Format 0 and Format 1. Song data recorded on the TYROS is automatically recorded as SMF Format 0.

● ESEQ

This sequence format is compatible with many of Yamaha’s MIDI devices, including the Clavinova series instruments. This is a common format used with various Yamaha software. The TYROS is compatible with ESEQ.

● XF..... See page 8.

● STYLE FILE..... See page 8.

Voice allocation format

With MIDI, voices are assigned to specific numbers, called “program numbers.” The numbering standard (order of voice allocation) is referred to as the “voice allocation format.” Voices may not play back as expected unless the voice allocation format of the song data matches that of the compatible MIDI device used for playback.

● GM System Level 1..... See page 8.

● GM System Level 2..... See page 8.

● XG..... See page 8.

● DOC..... See page 8.

Preset MIDI settings (templates)

The TYROS gives you a set of comprehensive, flexible MIDI controls. It also gives you a set of ten pre-programmed templates that let you instantly and easily reconfigure the instrument to match your particular MIDI application or external device. Call up these templates from the [FUNCTION] → MIDI display (next page).

Template name	Descriptions
ALL PARTS	Transmits all parts including the keyboard parts (RIGHT1, 2, 3, LEFT).
KBD & STYLE	Basically the same as “ALL PARTS” with the exception of how keyboard parts are managed. The right-hand parts are handled as a “UPPER” instead of RIGHT1 - 3 and the left-hand part is handled as a “LOWER.”
Master KBD1	In this setting, the TYROS functions as a “master” keyboard, playing and controlling one or more connected tone generators or other devices (such as a computer/sequencer).
Master KBD2	Basically the same as “Master KBD1” above, with the exception that Aftertouch messages are not transmitted.
Clock Ext.A	Playback or recording (Song, Style, Multi Pad, etc.) synchronizes with an external MIDI clock instead of the TYROS’ internal clock. This template is called up when you wish to set the tempo on the MIDI device connected to the TYROS. Playback or Recording of the TYROS synchronizes with an external clock received via MIDI A.
MIDI Accord1	MIDI accordions allow you to transmit MIDI data and play connected tone generators from the keyboard and bass/chord buttons of the accordion. This template lets you play melodies from the keyboard and control style playback on the TYROS with the left-hand buttons.
MIDI Accord2	Basically the same as “MIDI Accord1” above, with the exception that the chord/bass notes you play with your left hand on the MIDI Accordion are recognized also as MIDI note events.
MIDI Pedal1	MIDI pedal units allow you play connected tone generators with your feet (especially convenient for playing single note bass parts). This template lets you play/control the chord root in style playback with a MIDI pedal unit (connected to MIDI B only).
MIDI Pedal2	This template lets you play the bass part for style playback by using a MIDI pedal unit (connected to MIDI B only).
MIDI OFF	No MIDI signals are sent or received.

Basic Procedure (Function MIDI)

1 Press the [FUNCTION] button.

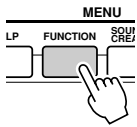

2 Select "MIDI."

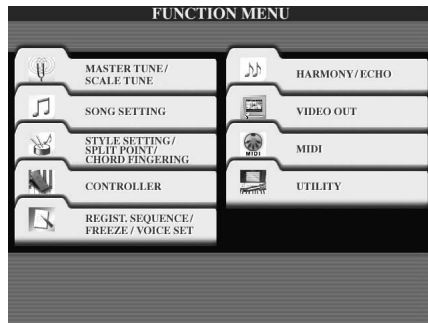

3 Select a MIDI template (page 144).



6 Press the [EXIT] button to return to the MIDI template display.



7 Save the MIDI settings on the displays in step #5 to the USER page as a MIDI template.

5 As desired, set the MIDI parameters.

- MIDI System Settings (page 146)
- MIDI Transmit Settings (page 146)
- MIDI Receive Settings (page 147)
- Setting the Chord Root for Style Playback via MIDI receive (page 148)
- Setting the Chord Type for Style Playback via MIDI receive (page 148)
- Settings for a connected MFC10 MIDI Foot Controller (page 148)

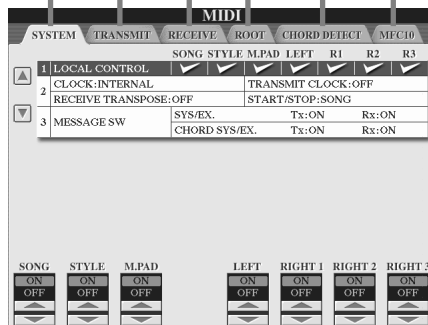

4 Press the [EDIT] LCD button to call up the display for setting the MIDI parameters. Here you can see and edit the detailed settings that correspond to the MIDI template selected in step #3.

MIDI System Settings

The explanations here apply when you call up the SYSTEM page in step #5 of the Basic Procedure on page 145.

Local Control

Turns the Local Control for each part on or off. When Local Control is set to “ON,” the keyboard of the TYROS controls its own (local) internal tone generator, allowing the internal voices to be played directly from the keyboard. If you set Local to “OFF,” the keyboard and controllers are internally disconnected from the TYROS’ tone generator section so that no sound is output when you play the keyboard or use the controllers. For example, this allows you to use an external MIDI sequencer to play the TYROS’ internal voices, and use the TYROS keyboard to record notes to the external sequencer and/or play an external tone generator.

Clock setting, etc.

CLOCK

Determines whether the TYROS is controlled by its own internal clock or a MIDI clock signal received from an external device. INTERNAL is the normal Clock setting when the TYROS is being used alone. If you are using the TYROS with an external sequencer, MIDI computer, or other MIDI device, and you want to synchronize it to that device, set this parameter to the appropriate setting: MIDI A, MIDI B, USB 1, or USB 2. Make sure that the external device is connected properly (e.g., to the TYROS’ MIDI IN terminal), and that it is properly transmitting a MIDI clock signal.

TRANSMIT CLOCK

Turns MIDI clock transmission on or off. When set to OFF, no MIDI clock or START/STOP data is transmitted even if song or style is played back.

RECEIVE TRANSPOSE

Determines whether the TYROS’ transpose setting (page 82) is applied to the note events the TYROS received via MIDI or not.

START/STOP

Determines whether incoming FA (start) and FC (stop) messages affect song or style playback.

Message Switch

SYS/EX.

The “Tx” setting turns MIDI transmission of MIDI system exclusive messages on or off.
The “Rx” setting turns MIDI reception and recognition of MIDI system exclusive messages generated by external equipment on or off.

CHORD SYS/EX.

The “Tx” setting turns MIDI transmission of MIDI chord exclusive data (chord detect — root and type) on or off.
The “Rx” setting turns MIDI reception and recognition of MIDI chord exclusive data generated by external equipment on or off.

MIDI Transmit Settings

The explanations here apply to when you call up the TRANSMIT page in step #5 of the Basic Procedure on page 145. This determines which parts will send MIDI data and over which MIDI channel the data will be sent.

Select the part for changing transmit settings. With the exception of the two parts below, see page 134 for details about the parts.

UPPER

A keyboard part played on the right side of the keyboard from the split point for the voices instead of RIGHT1, 2, and 3.

LOWER

A keyboard part played on the left side of the keyboard from the split point for the voices instead of LEFT. This part is not affected by the on/off status of the [ACMP] button.

MIDI							
SYSTEM		TRANSMIT	RECEIVE	ROOT	CHORD DETECT	MFC10	
PART	TRANSMIT CHANNEL	NOTE	CC	PC	PB	AT	
RI HT1	MIDI A/USB CH1	✓	✓	✓	✓	✓	✓
RI HT2	MIDI A/USB CH2	✓	✓	✓	✓	✓	✓
RI HT3	MIDI A/USB CH3	✓	✓	✓	✓	✓	✓
LEFT	MIDI A/USB CH4	✓	✓	✓	✓	✓	✓
UPPER	OFF	—	—	—	—	—	—
LOWER	OFF	—	—	—	—	—	—
MULTI PAD1	MIDI A/USB CH5	✓	✓	✓	✓	✓	✓
MULTI PAD2	MIDI A/USB CH6	✓	✓	✓	✓	✓	✓

TX MONITOR
MIDI A/USB
MIDI B

1 2 3 4 5 6 7 8 9 10 11 12 13 14 15 16

NOTE
• If the same transmit channel is assigned to several different parts, the transmitted MIDI messages are merged to a single channel — resulting in unexpected sounds and possible glitches in the the connected MIDI device.

PART TRANSMIT CHANNEL NOTE CHANGE CHANGE MARK

CONTROL PROGRAM PITCH ALTER

MARK BEND TOUCH

The dots corresponding to each channel (1-16) flash briefly whenever any data is transmitted on the channel(s).

Turns transmission of the specified data type (MIDI message) on or off. See below and page 105 for details.

Select a channel via which the selected part will be transmitted.

■ MIDI messages which can be transmitted or received (recognized)

The following MIDI messages can be set on the TRANSMIT/RECEIVE display.

- NOTE.....page 105
- CC (Control Change).....page 105
- PC (Program Change).....page 105
- PB (Pitch Bend).....page 105
- AT (Aftertouch).....page 105

MIDI Receive Settings

The explanations here apply when you call up the RECEIVE page in step #5 of the Basic Procedure on page 145. This determines which parts will receive MIDI data and over which MIDI channels the data will be received.

Select a channel. The TYROS can receive MIDI messages over 32 channels (16 channels x 2 ports).

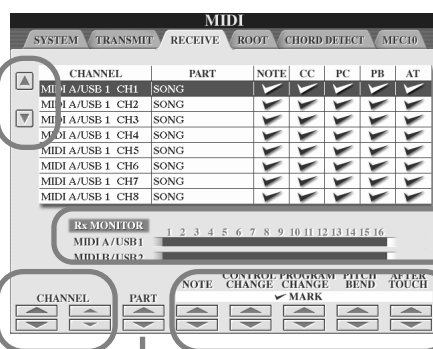

The dots corresponding to each channel (1 - 16) flash briefly whenever any data is received on the channel(s).

Turns reception of the specified data type of the selected channel on or off.

Determines the part to which the received MIDI messages of the selected channel are assigned. With the exception of the two parts below, see page 134 for details about the parts.

• KEYBOARD

The received note messages control the TYROS' keyboard performance.

• EXTRA PART1 - 4

There are four parts specially reserved for receiving and playing MIDI data. Normally, these parts are not used by the instrument itself. The TYROS can be used as a 32-channel multi-timbral tone generator by using these four parts in addition to the parts (except for the microphone sound) described on page 134.

■ MIDI transmission/reception via the USB terminal and MIDI terminals

The relationship between the MIDI terminals and the USB terminal which can be used for transmitting/receiving 32 channels (16 channels x 2 ports) of the MIDI messages is as follows:

● MIDI reception

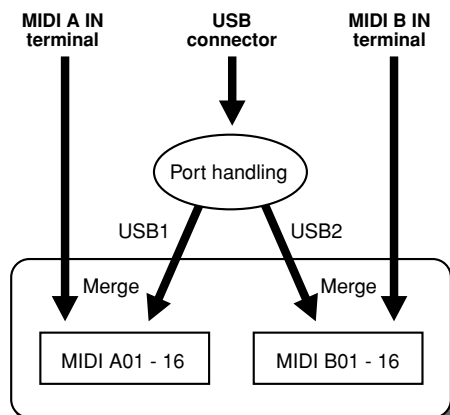

● MIDI transmission

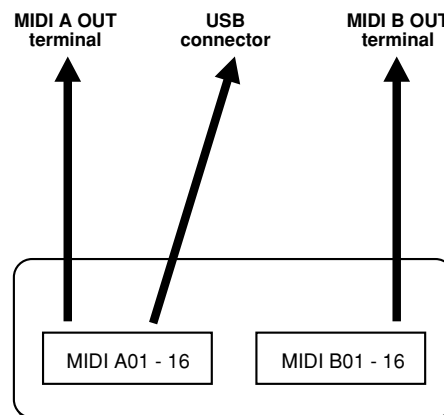

Setting the Chord Root for Style Playback via MIDI receive

The explanations here apply when you call up the ROOT page in step #5 of the Basic Procedure on page 145. These settings let you determine the chord root for style playback, based on the note messages received via MIDI.

The note on/off messages received at the channel(s) set to “ON” are recognized as the root notes in the chord section. The root notes will be detected regardless of the [ACMP] on/off and split point settings. When several channels are simultaneously set to “ON,” the root note is detected from merged MIDI data received over the channels.

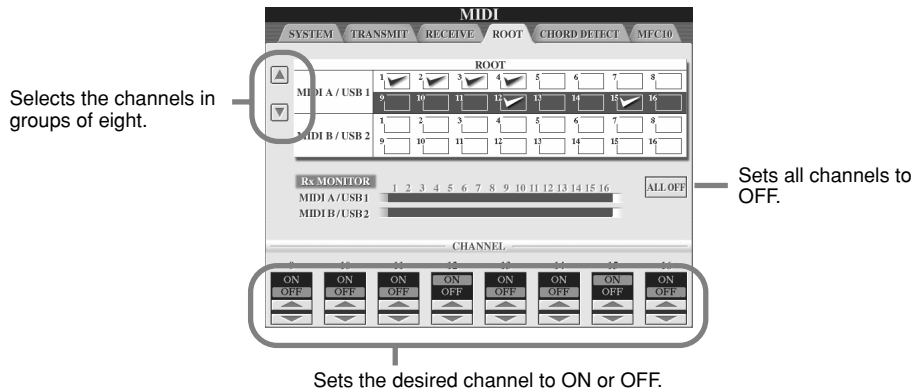

Setting the Chord Type for Style Playback via MIDI receive

The explanations here apply when you call up the CHORD DETECT page in step #5 of the Basic Procedure on page 145. These settings let you determine the chord type for style playback, based on the note messages received via MIDI.

The note on/off messages received at the channel(s) set to “ON” are recognized as the chord notes in the chord section. The chords to be detected depend on the fingering type. The chord types will be detected regardless of the [ACMP] on/off and split point settings. When several channels are simultaneously set to “ON,” the chord type is detected from merged MIDI data received over the channels.

The operation procedure is basically the same as that of the ROOT display above.

MFC10 Settings

The explanations here apply when you call up the MFC10 page in step #5 of the Basic Procedure on page 145.

By connecting an optional MFC10 MIDI Foot Controller to the TYROS, you can conveniently control a wide range of operations and functions by using your feet — perfect for changing settings and controlling the sound while you perform live. Different functions can be assigned to each of the footswitches and up to five foot controllers (optional) can be connected to the MFC10, for additional sound-shaping possibilities.

To assign the desired functions to the appropriate footswitches/foot controllers on the TYROS, select [FUNCTION] → MIDI → EDIT → MFC10. Two settings (below) can be made from this display.

- Each footswitch (F00 - F29) on the MFC10 sends a note number to the TYROS, and the TYROS determines how it responds to (which function is executed by) that note number.
- Each foot controller on the MFC10 sends control change messages over a specific control change number to the TYROS, and the TYROS determines how it responds to (which parameter is changed by) that control change number.

- ▶ **1** Connect the MIDI IN terminal of the MFC10 to one of the MIDI OUT terminals of the TYROS by using a MIDI cable.

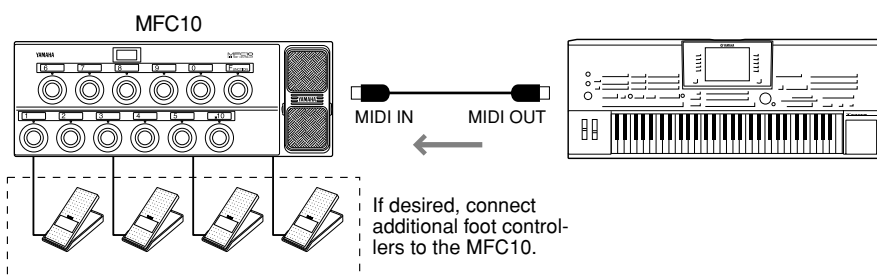

NOTE

- Do not connect the MIDI OUT terminal of the MFC10 to the MIDI IN of the TYROS in this step.

- ▶ **2** Set the MFC10 to the normal mode and turn the [FUNCTION] lamp of the MFC10 on.
- ▶ **3** Perform steps #1 through #5 of the Basic Procedure on page 145 to call up the MFC10 display.
- ▶ **4** Set the parameters on this display as desired and press the [SEND MFC10 SETUP] LCD button to send the settings here to the MFC10.

Select "FOOT SWITCH" or "FOOT CONTROLLER."

SWITCH NO.	NOTE	FUNCTION
0	C#-1	SUSTAIN
1	D-1	SOSTENUTO
2	E-1	SOFT
3	E-1	PORTAMENTO
4	F-1	DSP RIGHT1
5	F#-1	DSP RIGHT1 VARIATION
6	G-1	DSP RIGHT2

CONTROLLER NO.	CC	FUNCTION	PART
1	7	MODULATION	RIGHT1
2	1	BREATH CONTROL*	RIGHT2
3	2	FOOT CONTROL*	RIGHT3

*Except for style parts

Determines the MIDI port which is to be used when communicating with the MFC10. Here, the USB port (USB1, USB2) can be selected even though the MFC10 does not have the USB connector. This is because the computer can be used instead of the MFC10. (The computer can transmit the data equivalent to the data the MFC10 transmits to the TYROS. For details, see the bottom of this page.)

Determines the MIDI channel which is to be used when communicating with the MFC10.

Transmit the settings on this display to the MFC10.

NOTE

- Actually the pairs of the footswitch number and the note number, the pairs of the foot controller number and the control change number, and the MIDI channel for communication set above are transmitted to the MFC10.

Select a footswitch number (F00 - F29) or a foot controller number (1 - 5) to which the function is assigned. Please note that a note number is assigned to each footswitch and a control change number is assigned to each foot controller beforehand and you cannot change the settings.

Determines the function assigned to the footswitch (actually the note number), or the function assigned to the foot controller (actually the control change number).

Determines the part to which the function assigned to the foot controller in the row is applied.

NOTE

- See page 152 for details about the functions which can be assigned to the footswitch or foot controller.

- ▶ **5** Disconnect the MIDI cable from the TYROS and the MFC10, and connect the MIDI OUT terminal of the MFC10 to the MIDI IN terminal of the TYROS according to the setting above by using the MIDI cable.

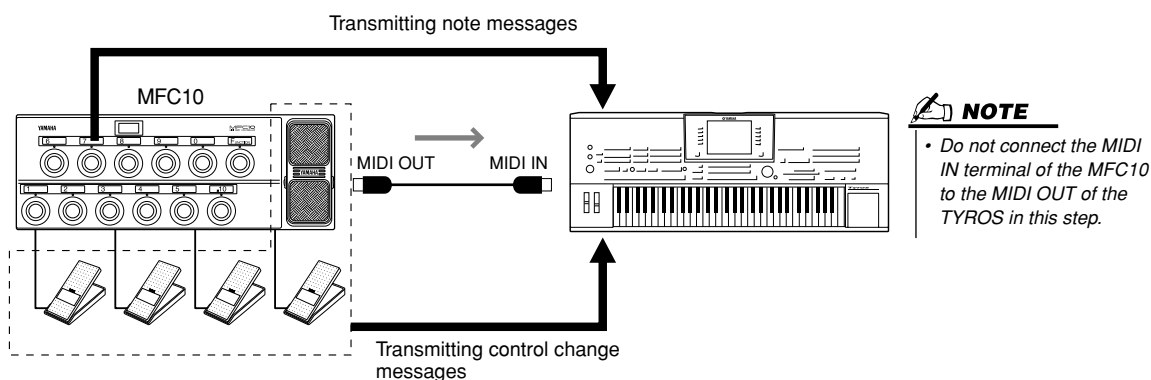

- ▶ **6** Operate the MFC10 to confirm whether you can properly control the TYROS from the MFC10 as set in step #4.
- ▶ **7** Go back to the MIDI template selection display and save the settings above to the User drive if necessary.

■ Using a computer or another MIDI instrument instead of the MFC10

The following two settings on the [FUNCTION] → MIDI → EDIT → MFC10 display can be saved not to the MFC10 but to internal memory (flash ROM) in the TYROS as a MIDI template.

- Note number/TYROS function assignment pairs
- Control change number/TYROS parameter change assignment pairs

If you are not using an MFC10, you can have note numbers and control change messages from any other appropriate MIDI device (such as a computer, sequencer or master keyboard) control the TYROS. Make sure to set the appropriate channel in this display for control by the external device.

Making Global and Other Important Settings – Function

The Function menu called up by pressing the [FUNCTION] button gives you access to various advanced functions related to the instrument as a whole. These sophisticated functions let you customize the TYROS to your own musical needs and preferences.

Basic Procedure (Function)

1

Press the [FUNCTION] button.

2 Select the desired menu by pressing the corresponding LCD button.

Page Reference	Function Name	Page Reference
Page 150	MASTER TUNE/SCALE TUNE	Page 154
Page 92	SONG SETTING	Page 151
Pages 108 and 112	STYLE SETTING/ SPLIT POINT/ CHORD FINGERING	Page 145
Page 152	CONTROLLER	Page 156
Pages 128 and 151	REGIST. SEQUENCE/ FREEZE / VOICE SET	
	HARMONY/ECHO	
	VIDEO OUT	
	MIDI	
	UTILITY	

Some of the functions are explained in other sections of the manual, and are indicated by the page references above.

NOTE

• How to save the settings differs depending on the menu. For details, see the page of each menu and refer to the Parameter Chart in the separate Data List booklet.

3 Set the desired parameters on each display.

Tuning

Parameters set on the display called up by selecting “MASTER TUNE/SCALE TUNE” in step #2 of the Basic Procedure above are explained below.

■ MASTER TUNE

The [FUNCTION] → MASTER TUNE/SCALE TUNE → MASTER TUNE display allows you to make fine adjustments to the overall pitch of the instrument, from 414.8 - 466.8 Hz by using the corresponding the lower and upper LCD buttons — letting you accurately match the tuning with that of other instruments. Press the corresponding lower and upper buttons simultaneously to instantly reset the value to the factory setting of 440.0 Hz.

Please note that the Tune function does not affect the Drum Kit or SFX Kit voices.

■ SCALE TUNE

The [FUNCTION] → MASTER TUNE/SCALE TUNE → SCALE TUNE display determines the particular tuning system (or temperament) for the instrument. This function allows each individual note of the octave to be tuned in cents (1 cent = 1/100th of a semitone) for each part – especially useful for playing period pieces, to match the tuning system used during specific musical eras.

Select a scale type to instantly call up one of the pre-programmed Scale Tune settings.

Determines the base note for each scale. When the base note is changed, the pitch of the keyboard is transposed, yet maintains the original pitch relationship between the notes.

Select the desired note and tune it.

The current tuning of each note is shown in the corresponding key.

Select the part to which the Scale Tune setting here is applied by checkmarking the box.

NOTE

• The Scale Tune settings here can be memorized to the Registration Memory.

Preset Scale type

Scale name	Description
EQUAL TEMPERAMENT	The pitch range of each octave is divided equally into twelve parts, with each half-step evenly spaced in pitch. This is the most commonly used tuning in music today.
PURE MAJOR PURE MINOR	These tunings preserve the pure mathematical intervals of each scale, especially for triad chords (root, third, fifth). You can hear this best in actual vocal harmonies – such as choirs and acapella singing.
PYTHAGOREAN	This scale was devised by the famous Greek philosopher and is created from a series of perfect fifths, which are collapsed into a single octave. The 3rd in this tuning are slightly unstable, but the 4th and 5th are beautiful and suitable for some leads.
MEAN-TONE	This scale was created as an improvement on the Pythagorean scale, by making the major third interval more “in tune.” It was especially popular from the 16th century to the 18th century. Handel, among others, used this scale.
WERCKMEISTER KIRNBERGER	This composite scale combines the Werckmeister and Kirnberger systems, which were themselves improvements on the mean-tone and Pythagorean scales. The main feature of this scale is that each key has its own unique character. The scale was used extensively during the time of Bach and Beethoven, and even now it is often used when performing period music on the harpsichord.
ARABIC1, 2	Use these tunings when playing Arabic music.

Voice Set

Parameters set on the VOICE SET display called up via the [FUNCTION] → REGISTRATION MEMORY/FREEZE/VOICE SET → VOICE SET are explained here.

When changing voices (selecting a voice file), the settings best matching the voice — the same as those set in the Sound Creator — are always and automatically called up. From this page, you can set the on/off status for each part. Normally, it is recommended that these are set to “ON.”

Use these to select the desired part.

REGIST. SEQUENCE / FREEZE / VOICE SET			
REGISTRATION SEQUENCE		FREEZE	VOICE SET
		VOICE EFFECT	EQ HARMO.
1	RIGHT1	ON	ON
2	RIGHT2	ON	ON
3	RIGHT3	ON	ON
4	LEFT	ON	ON

These determine whether the corresponding voice-related settings are automatically called up or not when you select a voice. These settings can be turned on or off independently for each part.

VOICE	EFFECT	EQ	HARMONY/ECHO
ON	ON	ON	ON
OFF	OFF	OFF	OFF

Video Out Settings

Parameters set on the display called up by selecting “VIDEO OUT” in step #2 of the Basic Procedure on page 150 are explained below. You can connect the TYROS to a television or video monitor to display the lyrics and chords in your song data on a larger screen.

VIDEO OUT
NTSC/PAL

Select the desired video standard: NTSC or PAL.
This determines the output from the video port without affecting the display of the instrument itself.

VIDEO IN

Television

Set this to correspond to the standard (NTSC or PAL) used by your video equipment. The default setting is “PAL.” If the standard used by your television or video monitor is not PAL (for example, NTSC is generally used in North America), change the setting to “NTSC.”

Determines the contents of the Video Out signal, or which data is sent to the video monitor.

- **LYRICS**
Only the lyrics of the song are output via VIDEO OUT, regardless of the display that is called up on the instrument itself. This lets you select other displays and still have the lyrics shown on the monitor.
- **LCD**
The currently selected display is output via VIDEO OUT.

NOTE

- Occasionally some flashing parallel lines may appear in the television or video monitor. This does not necessarily indicate that the monitor is malfunctioning. You may be able to remedy the situation by changing the Character Color or Background Color parameters. For optimum results, also try adjusting the color settings on the monitor itself.
- Avoid looking at the television or video monitor for prolonged periods of time since doing so could damage your eyesight. Take frequent breaks and focus your eyes on distant objects to avoid eyestrain.
- Keep in mind that even after adjusting all settings as recommended here, the monitor you are using may not show the TYROS' display contents as expected (e.g., the display contents may not fit on the screen, the characters may not be completely clear, or the colors may be incorrect).

See page 18.

Controller

Parameters set on the display called up by selecting “CONTROLLER” in step #2 of the Basic Procedure on page 150 are explained below. This display lets you make settings for controllers with which the TYROS is equipped (including the keyboard, modulation wheel, pitch bend wheel) and which are connected to the TYROS (including the footswitch and foot controller).

■ FOOT PEDAL

From the [FUNCTION] → CONTROLLER → FOOT PEDAL display, you can assign one of various functions to each foot pedal (footswitch or foot controller) connected to the TYROS.

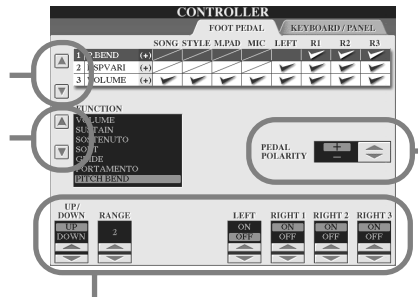
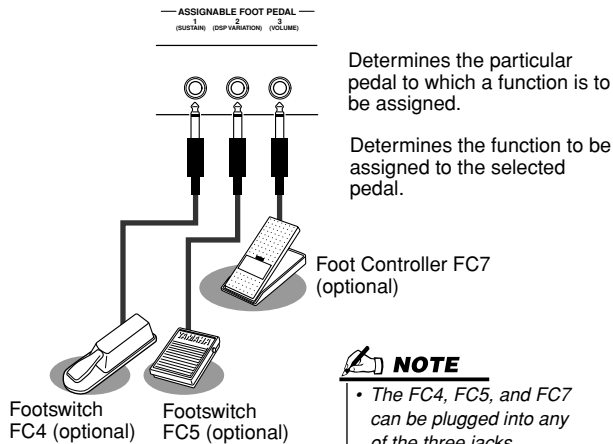



Pedal on/off operation may differ depending on the particular pedal you've connected to the TYROS. For example, pressing down on one pedal may turn the selected function on, while pressing a different make/brand of pedal may turn the function off. If necessary, use this setting to reverse the operation.

NOTE
• The FC4, FC5, and FC7 can be plugged into any of the three jacks.

If necessary, set the parameters related to the selected function. Displayed parameters differ depending on the selected function.

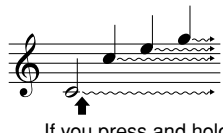
Functions that can be assigned to the foot pedal (footswitch, foot controller)

VOLUME*	Allows you to use a foot controller to control the volume. You can turn this pedal function on or off for each part on this display.
SUSTAIN	When the pedal is pressed notes played have a long sustain. Releasing the pedal immediately stops (damps) any sustained notes. You can turn this pedal function on or off for each keyboard part on this display. 
SOSTENUTO	If you press and hold the pedal here, only the first note will be sustained (the note that you played and held when pressing the pedal). This makes it possible to sustain a chord, for example, while other notes are played staccato. You can turn this pedal function on or off for each keyboard part on this display. 
SOFT	When you press the foot switch, the soft effect is applied to the keyboard notes. You can turn this pedal function on or off for each keyboard part on this display.
GLIDE	When the pedal is pressed, the pitch changes, and then returns to normal pitch when the pedal is released. The following parameters can be set for this function on this display. • UP/DOWN – determines whether the pitch change goes up (is raised) or down (is lowered) • RANGE – determines the range of the pitch change, in semitones • ON SPEED – determines the speed of the pitch change when the pedal is pressed • OFF SPEED – determines the speed of the pitch change when the pedal is released • LEFT, RIGHT1, 2, 3 – turns this pedal function on or off for each keyboard part
PORTAMENTO	The portamento effect (a smooth slide between notes) can be produced while the pedal is pressed. Portamento is produced when notes are played legato style (i.e., a note is played while the preceding note is still held). The portamento time can be set via the Mixing Console display. You can turn this pedal function on or off for each keyboard part on this display.

PITCHBEND*	Bend notes up or down while pedal is pressed. The following parameters can be set for this function on this display. <ul style="list-style-type: none"> • UP/DOWN – determines whether the pitch change goes up (is raised) or down (is lowered) • RANGE – determines the range of the pitch change, in semitones • LEFT, RIGHT1, 2, 3 – turns this pedal function on or off for each keyboard part
MODULATION*	Applies a vibrato effect to notes played on the keyboard.
DSP VARIATION	Same as the [DSP VARIATION] button on the panel. You can turn this pedal function on or off for each keyboard part on this display. This allows you to use the foot pedal to control [DSP VARIATION] for only the current keyboard part, or for multiple keyboard parts simultaneously.
HARMONY/ECHO	Same as the [HARMONY/ECHO] button.
VOCAL HARMONY	Same as the [VOCAL HARMONY] button.
TALK	Same as the [TALK] button.
SCORE PAGE +	While the song is stopped, you can turn to the next score page (one page only).
SCORE PAGE -	While the song is stopped, you can turn to the previous score page (one page only).
SONG START/STOP	Same as the SONG [START/STOP] button.
STYLE START/STOP	Same as the STYLE [START/STOP] button.
TAP TEMPO	Same as the [TAP TEMPO] button.
SYNC START	Same as the [SYNC. START] button.
SYNC STOP	Same as the [SYNC. STOP] button.
INTRO 1	Same as the [INTRO I] button.
INTRO 2	Same as the [INTRO II] button.
INTRO 3	Same as the [INTRO III] button.
MAIN A	Same as the MAIN [A] button.
MAIN B	Same as the MAIN [B] button.
MAIN C	Same as the MAIN [C] button.
MAIN D	Same as the MAIN [D] button.
FILL DOWN	A fill-in plays, automatically followed by the Main section of the button on the immediate left.
FILL SELF	A fill-in plays, automatically followed by the previously played Main section.
FILL BREAK	A break plays, automatically followed by the previously played Main section.
FILL UP	A fill-in plays, automatically followed by the Main section of the button on the immediate right.
ENDING1	Same as the [ENDING/rit. I] button.
ENDING2	Same as the [ENDING/rit. II] button.
ENDING3	Same as the [ENDING/rit. III] button.
FADE IN/OUT	Same as the [FADE IN/OUT] button.
FING/ON BASS	The pedal alternately switches between two Chord Fingering types: Fingered and On Bass (page 108).
BASS HOLD	While the pedal is pressed, the Style bass note will be held even if the chord is changed. If the fingering is set to "FULL KEYBOARD," the function does not work.
PERCUSSION	Footswitch plays a percussion instrument selected by the [ASSIGN] LCD buttons.
RIGHT1 ON/OFF	Same as the PART ON/OFF [RIGHT1] button.
RIGHT2 ON/OFF	Same as the PART ON/OFF [RIGHT2] button.
RIGHT3 ON/OFF	Same as the PART ON/OFF [RIGHT3] button.
LEFT ON/OFF	Same as the PART ON/OFF [LEFT] button.
OTS+	Recalls next higher One Touch Setting.
OTS-	Recalls next lower One Touch Setting.

* For best results, use an optional Yamaha FC7 Foot Controller.

 **NOTE**

- The Sostenuato and Portamento functions will not affect the Organ Flutes Voices, even they have been assigned to the Foot Pedals.

■ **KEYBOARD/PANEL**.....

The [FUNCTION] → CONTROLLER → KEYBOARD/PANEL display lets you set the parameters related to the keyboard and modulation wheel.

● **INITIAL TOUCH** page 81

You can turn Initial Touch on or off for each keyboard part and set the following parameters.

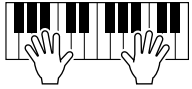
	TOUCH	Determines the Touch sensitivity setting.
	HARD 2	Requires strong playing to produce high volume. Best for players with a heavy touch.
	HARD 1	Requires moderately strong playing for higher volume.
	NORMAL	Standard touch response.
	SOFT 1	Produces high volume with moderate playing strength.
	SOFT 2	Produces relatively high volume even with light playing strength. Best for players with a light touch.
	TOUCH OFF LEVEL	Determines the fixed volume level when Touch is set to “OFF.”

● **AFTER TOUCH** page 81

You can turn Aftertouch on or off for each keyboard part and set the following parameters.

	TOUCH	Determines the Touch sensitivity setting.
	HARD	Relatively strong aftertouch pressure is needed to produce changes.
	NORMAL	Produces a fairly standard aftertouch response.
	SOFT	Allows you to produce relatively large changes with very light aftertouch pressure.

● **MODULATION WHEEL** page 82

You can determine whether the modulation wheel operation is applied or not to the notes for each part.



● **TRANPOSE ASSIGN** page 82

You can determine to which parts the [TRANPOSE] button is applied.

KEYBOARD	When this is selected, the [TRANPOSE] button affects the pitch of the keyboard-played voices, style playback (controlled by the performance in the chord section of the keyboard), and Multi Pad playback (when Chord Match is on, and left-hand chords are indicated).
SONG	When this is selected, the [TRANPOSE] button affects only the pitch of the songs.
MASTER	When this is selected, the [TRANPOSE] button affects the pitch of the entire instrument (keyboard voices, styles, and songs).

You can confirm the setting here by viewing the pop-up window called up via the [TRANPOSE] button.

Please note that the transpose function does not affect the Drum Kit or SFX Kit voices.

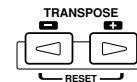

Harmony/Echo

Quick Guide on page 39 ➔

Parameters set on the display called up by selecting “HARMONY/ECHO” in step #2 of the Basic Procedure on page 150 are explained below. This display lets you set the parameters related to the Harmony/Echo effect applied to the keyboard performance when the [HARMONY/ECHO] button is turned on.

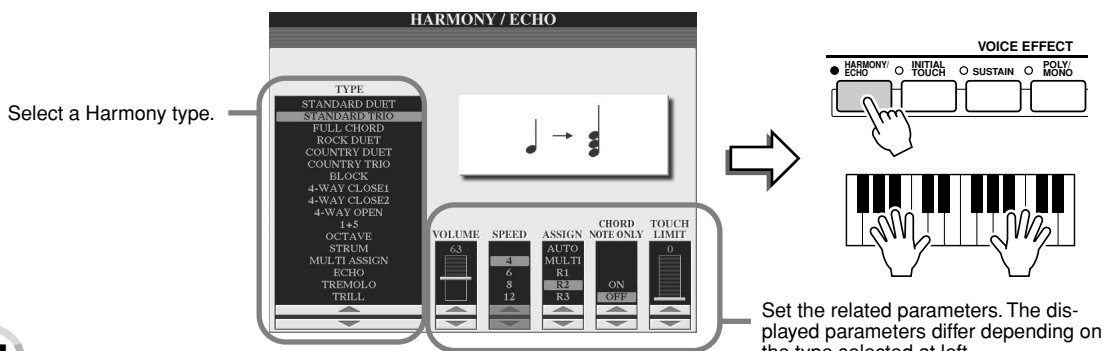

Select a Harmony type.

Set the related parameters. The displayed parameters differ depending on the type selected at left.

TYPE

The Harmony/Echo types are divided into the following groups, depending on the particular effect applied.

Harmony Types

These types apply the harmony effect to the note in the right-hand section of the keyboard according to the chord specified in the left-hand section of the keyboard. (Please note that “1+5” and “Octave” settings are not affected by the chord.)

Multi Assign

This type apply the special effect to the chord played in the right-hand section of the keyboard.



Echo Types

These types apply the echo effect to the note in the right-hand section of the keyboard in time with the currently set tempo.

● Harmony Types

When any of the Harmony Types is selected, the Harmony effect is applied to the note played in the right-hand section of the keyboard according to the type selected above and the chord specified in the chord section of the keyboard shown below.

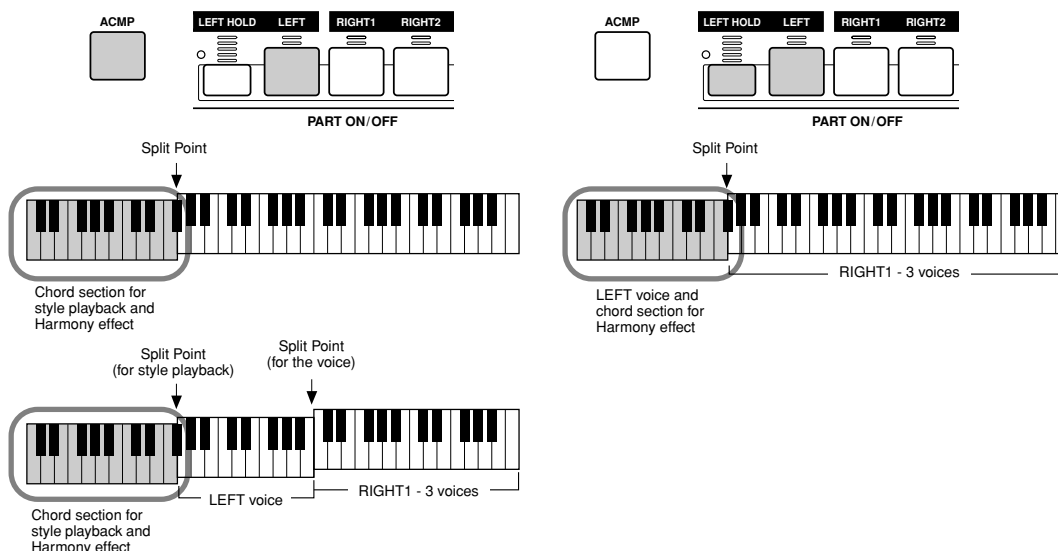

● Echo Types

When any of the Echo Types is selected, the corresponding effect (echo, tremolo, trill) is applied to the note played in the right-hand section of the keyboard in time with the currently set tempo, regardless of the [ACMP] and the LEFT part on/off status. Please note that two notes held on the keyboard are played alternately when Trill is selected.

● Multi Assign Type

Multi Assign automatically assigns notes played simultaneously on the right-hand section of the keyboard to separate parts (voices). For example, if you play three consecutive notes, the first is played by the RIGHT1 voice, the second by the RIGHT2 voice, and the third by the RIGHT3 voice. The Multi Assign effect is not affected by the [ACMP] and LEFT part on/off status.



■ Related parameters

- **VOLUME** Determines the level of the harmony/echo notes generated by the Harmony/Echo effect. This parameter is available for all types with the exception of “Multi Assign.”
- **SPEED** Determines the speed of the Echo, Tremolo, and Trill effects. This parameter is only available when Echo, Tremolo, or Trill is selected in Type above.
- **ASSIGN** This lets you determine the keyboard part via which the harmony/echo notes will be sounded. This parameter is available for all types with the exception of “Multi Assign.”
- **CHORD NOTE ONLY** When this is set to “ON,” the Harmony effect is applied only to the note that belongs to a chord played in the chord section of the keyboard. This parameter is not available only for the Harmony type above.
- **TOUCH LIMIT** Determines the lowest velocity value at which the harmony note will sound. This allows you to selectively apply the harmony by your playing strength, letting you create harmony accents in the melody. The harmony effect is applied when you play the key strongly (above the set value). This parameter is available for all types with the exception of “Multi Assign.”

Other Settings (Utility)

Parameters set on the display called up by selecting “UTILITY” in step #2 of the Basic Procedure on page 150 are explained below.

■ CONFIG1.....

The following parameters can be set from the [FUNCTION] → UTILITY → CONFIG1 display.

● Parameters related to the Fade In/Out (page 109)

FADE IN TIME	Determines the time it takes for the volume to fade in, or go from minimum to maximum (range of 0 - 20.0 seconds).
FADE OUT TIME	Determines the time it takes for the volume to fade out, or go from maximum to minimum (range of 0 - 20.0 seconds).
FADE OUT HOLD TIME	Determines the time the volume is held at 0 following the fade out (range of 0 - 5.0 seconds).

● Parameters related to the Metronome

The metronome provides a click sound, giving you an accurate tempo guide when you practice, or letting you hear and check how a specific tempo sounds. The metronome starts by pressing the METRONOME [START/STOP] button. Adjust the tempo by using the [TEMPO] buttons (page 109). To stop the metronome, press the [START/STOP] button again.



VOLUME	Determines the level of the metronome sound.
SOUND	Determines whether a bell accent will be sounded or not at the first beat of each measure.
TIME SIGNATURE	Determines the time signature of the metronome sound. Normally, the value matching to the selected style or song is set.

● Parameter Lock

This function is used to “lock” the specified parameters so that they can only be changed directly via the panel controls — in other words, instead of being changed via Registration Memory, One Touch Setting, Music Finder, or song and sequence data.

When the Split Point parameter is locked, for example, the Split Point settings will not be changed via the Registration Memory, One Touch Setting, Music Finder. However, you can change the Split Point settings directly from the [FUNCTION] → SPLIT POINT display.

● Parameters related to the Tap (page 109)

This allows you to set the drum voice and the velocity which will sound when the Tap function is used.

■ CONFIG2.....

The following parameters can be set from the [FUNCTION]→UTILITY→CONFIG2 display.

● Display Voice Number

Determines whether or not the voice bank and number are shown in the Voice selection display (Open/Save display).

This is useful when you want to check the proper bank select MSB/LSB values and program number to specify when selecting the voice from an external MIDI device.

● Speaker

Determines whether or not the optionally installed speaker will sound.

HEADPHONE SW	Speaker sounds normally, but is cut off when headphones are inserted to the PHONES jack.
ON	Speaker sound is always on.
OFF	Speaker sound is off.

■ DISK.....

From the [FUNCTION] → UTILITY → DISK display, you can set or execute important disk-related operations (below) for the TYROS.

Compatible disk types

● Floppy disk

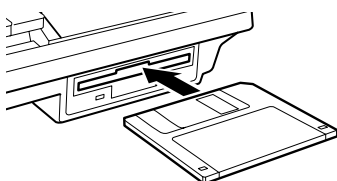

IMPORTANT

- Make sure to read the section “Using the Floppy Disk Drive (FDD) and Floppy Disks” on page 6.

● Internal hard disk drive (optionally installed)

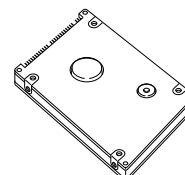

See page 162 for details on hard disk installation.

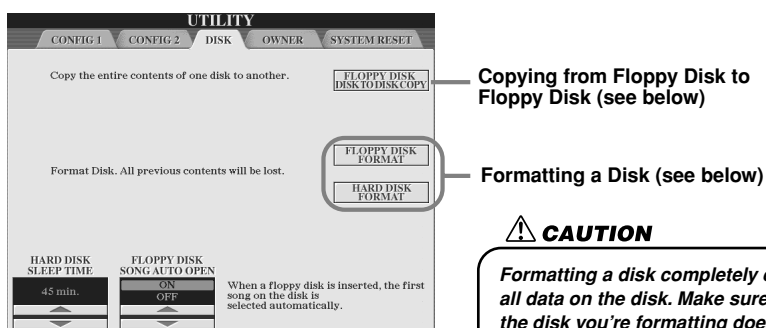

Copying from Floppy Disk to Floppy Disk (see below)

Formatting a Disk (see below)

CAUTION

Formatting a disk completely erases all data on the disk. Make sure that the disk you're formatting does not contain important data!

Turns the Song Auto Open function on or off. When this is set to "ON," the TYROS automatically calls up the first disk song when a floppy disk is inserted to the floppy disk drive.

The optionally installed hard disk unit will go into a "sleep" mode after a specified time of inactivity, both to maximize the lifetime of the hard disk and to minimize unnecessary mechanical noise. This parameter determines the sleep time.

NOTE

- Copying cannot be done between a 2DD disk and 2HD disk. When copying, make sure both disks are of the same type.
- Commercially available music data is subject to protection by copyright laws. Copying commercially available data is strictly prohibited, except for your own personal use. Some music software is purposely copy-protected and cannot be copied.

● Copying from Floppy Disk to Floppy Disk (FLOPPY DISK TO DISK COPY)

This function copies all the data from one disk to another, letting you back up all your important data before editing. Because only one floppy disk can be inserted to the floppy disk drive, this operation copies the contents of the source disk to internal memory of the TYROS, then copies it to the destination disk, as shown below.

- 1 Prepare the backup disk (destination disk), and insert the floppy disk to be backed up (source disk) into the floppy disk drive.
- 2 Press the [FLOPPY DISK TO DISK COPY] LCD button on the [FUNCTION] → UTILITY → DISK display.

The copy operation from the source disk to internal memory is started. When completed, the display prompts you to change disks.

- 3 Remove the source disk from the floppy disk drive and insert the destination disk to the drive.

The copy operation from internal memory to the destination disk continues. Please note that it may be necessary for the disk data to be copied in parts if the quantity of data is large. In this case, you may need repeat the disk exchange several times by following the on-screen messages. When the operation is finished, a message appears to indicate all data has been properly copied.

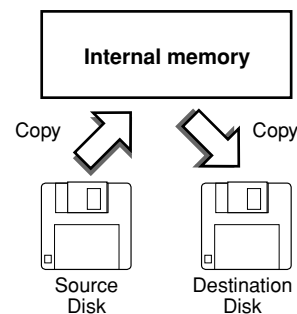

● Formatting a disk (FLOPPY DISK FORMAT, HARD DISK FORMAT)

Setting up commercially available blank floppy disks (3.5 inch, 2HD/2DD type) or an optionally installed hard disk unit (page 162) for use with the TYROS is called formatting. This function is also useful for quickly deleting unnecessary files from an already formatted disk. Be careful when using this operation, since it automatically deletes all data on the disk. After formatting, the capacity of a 2HD disk is 1.44 MB, and that of a 2DD disk is 720 KB.

When you wish to format a floppy disk, press the [FLOPPY DISK FORMAT] LCD button on the [FUNCTION] → UTILITY → DISK display after inserting a floppy disk into the floppy disk drive, then follow the on-screen instructions.

When you wish to format a hard disk, press the [HARD DISK FORMAT] LCD button on the [FUNCTION] → UTILITY → DISK display after installing a hard disk drive, then follow the on-screen instructions.

NOTE

- The TYROS is capable of formatting an installed hard disk, creating a single partition only; multiple partitions cannot be created. However, if the installed hard disk has been pre-formatted into several partitions on another instrument such as the PSR-9000 or 9000Pro, the TYROS can access up to four partitions of the hard disk.

■ Other customizing features — OWNER display.....

From the [FUNCTION] → UTILITY → OWNER display, you can make other custom settings for the instrument — such as registering your name and importing favorite background pictures.

● OWNER NAME

Press the [OWNER NAME] LCD button to enter an Owner name. For instructions on naming, see page 70. This name is automatically shown when you turn the power on.

After entering the name, press the [EXIT] button to exit from the UTILITY display, turn the power off, and then on again. You can see the entered name at the bottom of the opening display.



● LANGUAGE

Determines the language used for the display messages. Once you change this setting, all messages will be shown in the selected language.

When “JAPANESE” is selected for the Language parameter, and you change this to one of the western languages, the kanji and kana characters of the file name stored in the disk drive are changed to western characters.

● MAIN PICTURE

This function lets you select your favorite picture to be used as background for the Main display. Press the [MAIN PICTURE] LCD button on the [FUNCTION] → UTILITY → OWNER display to call up the Open/Save displays for main pictures. You can select a picture from among various pictures provided on the Preset drive. After selecting, press the [EXIT] button to return to the Main display. The newly selected picture is shown as the background of the Main display.

Using your own pictures

Even though a variety of pictures are available on the preset drive, you can load your own favorite picture data to the TYROS for use as background. Keep in mind the following points and limitations when using your own picture data.

- Only bitmap files (.BMP) can be used for the background of the MAIN display.
- Make sure to use images no larger than 640 x 480 pixels. Smaller images are automatically copied and tiled in the display.
- If you select a picture file on the FD drive, the background may take some time to appear. If you want to reduce this time, save the background from the FD drive to the USER drive of the Open/Save display for pictures.
- If you select a picture file on the FD drive, the selected background will not be displayed when the power is turned on again unless the same disk containing the data has been inserted into the drive.

NOTE

- The explanation about picture compatibility at left applies also to the background of the Song Lyric display.

■ **System Reset**

The explanations here apply to the [FUNCTION] → UTILITY → SYSTEM RESET display.

The screenshot shows the 'UTILITY' menu with 'SYSTEM RESET' selected. Below it, there are buttons for 'SYSTEM SETUP', 'MIDI SETUP', 'USER EFFECT', and 'MUSIC FINDER'. A 'FACTORY RESET EXECUTE' button is also visible. A callout box on the left explains the 'Factory Reset (factory programmed settings)' process, and a callout box on the right explains the 'Custom Reset (your own custom settings)' process.

● **Factory Reset — Restoring the factory programmed settings**

This function lets you restore the status of the TYROS to the original factory settings. You can set whether or not each of the following six items is to be restored to its original factory settings before executing the operation.

SYSTEM SETUP	Restores the System Setup parameters to the original factory settings. You can also restore only the System Setup settings by simultaneously holding down the highest key on the keyboard (C7) and turning on the power. Refer to the separate Data List booklet for details about which parameters belong to the System Setup.
MIDI SETUP	Restores the MIDI settings including the MIDI templates on the User drive to the original factory status.
USER EFFECT	Restores the User Effect settings including the user effect types, user master EQ types, user compressor types, and user vocal harmony types created via the Mixing Console display to the original factory settings.
MUSIC FINDER	Restores the Music Finder data (all records) to the original factory settings (page 127).
FILES & FOLDERS	Deletes all files and folders stored in the User drive.
CUSTOM VOICE	Deletes all Custom Voices (page 79) on the Preset drive.

● **Custom Reset — Recalling your own custom settings**

The four categories of settings below allow you to call up your own custom reset settings from files saved to the User of Disk drive.

SYSTEM SETUP	Parameters set on the various displays such as the [FUNCTION] → UTILITY and microphone setting display are handled as a single System Setup file. Refer to the separate Data List booklet for details about which parameters belong to the System Setup.
MIDI SETUP	The MIDI settings including the MIDI templates on the User drive are handled as a single file.
USER EFFECT	The User Effect settings including the user effect types, user master EQ types, user compressor types, and user vocal harmony types created via the Mixing Console displays are managed as a single file (page 65).
MUSIC FINDER	All the preset and created records of the Music Finder are handled as a single file (page 127).

Appendix

Installing the Optional Speakers

Make sure that you have all of the parts below, included in the TRS-MS01 speaker package, as well as a Phillips screwdriver to assemble the system.

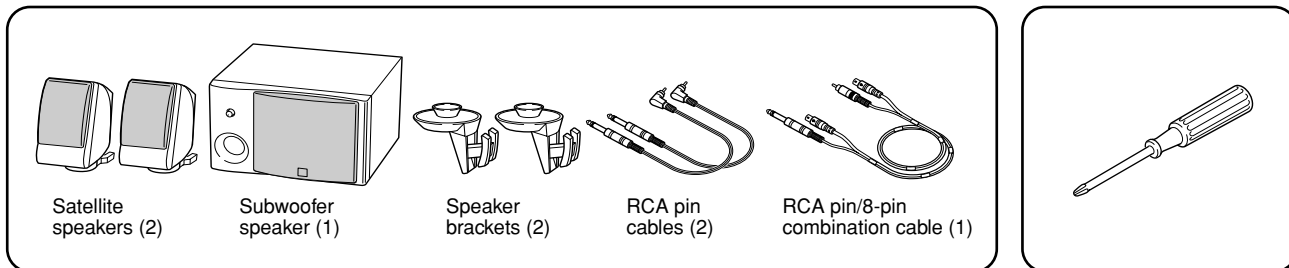

- ▶ **1** Turn the TYROS' power off, and disconnect the AC power cord. Also, make sure to disconnect the keyboard from any other external devices.
- ▶ **2** Remove the four screws from the rear panel of the TYROS.

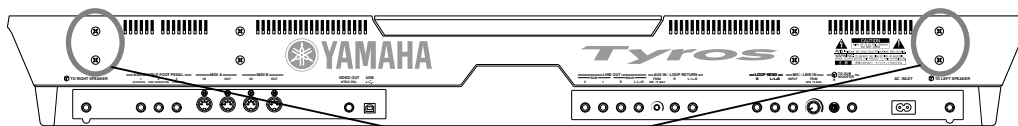

Installation screws for speaker brackets

- ▶ **3** Using the screws you removed in step #2 above, fasten the two speaker brackets to the rear panel of the TYROS.

NOTE

- Either bracket can be fastened to either location.

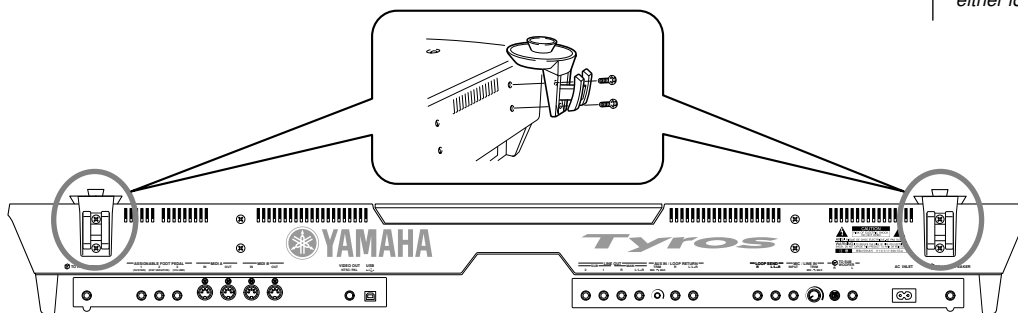

- ▶ **4** Fasten the satellite speakers to the left and right brackets.

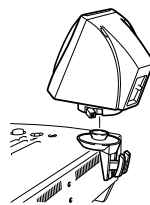

Place the speaker on the bracket.

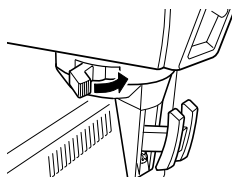

Adjust the direction of the speaker as desired, then fasten it securely to the bracket.

NOTE

- Either speaker can be placed on either bracket.
- If you want to change the direction of the satellite speaker, unfasten it from the bracket by rotating the lever, then adjust the speaker position as desired, and fasten it to the bracket again.

- ▶ **5** Use the RCA pin cables to connect the speakers to the respective outputs on the TYROS.

NOTE

- Either cable can be used for either location.

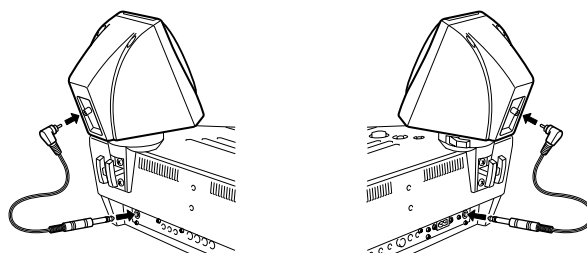

- ▶ **6** Use the RCA pin/8-pin combination cable to connect the subwoofer speaker to the respective outputs on the TYROS.

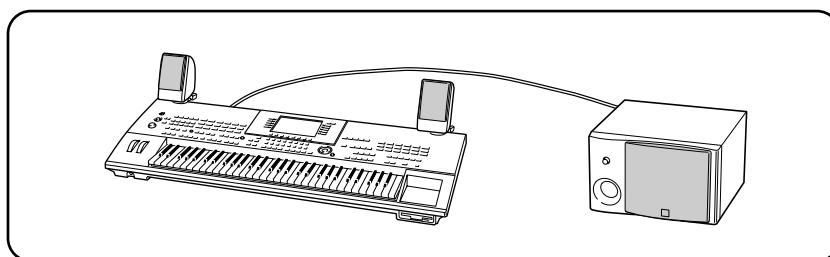
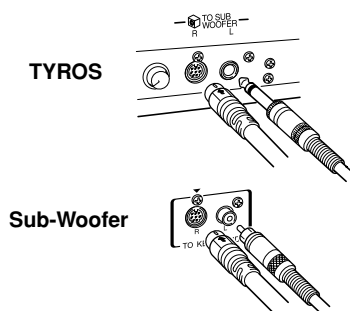

- ▶ **7** Connect the power plugs of the TYROS and the subwoofer to an appropriate AC outlet.
- ▶ **8** First, set the volume controls (**MASTER VOLUME** on the TYROS and **BASS** on the subwoofer) to minimum. Finally, turn on the power of the subwoofer, then the TYROS.

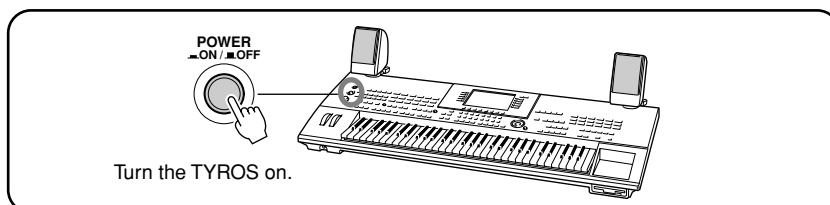
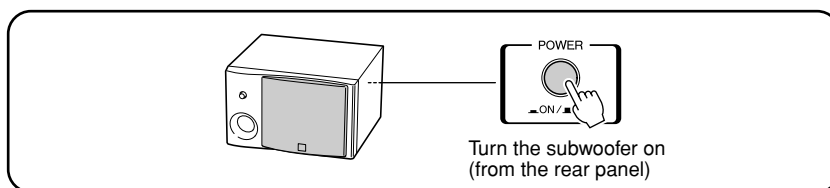
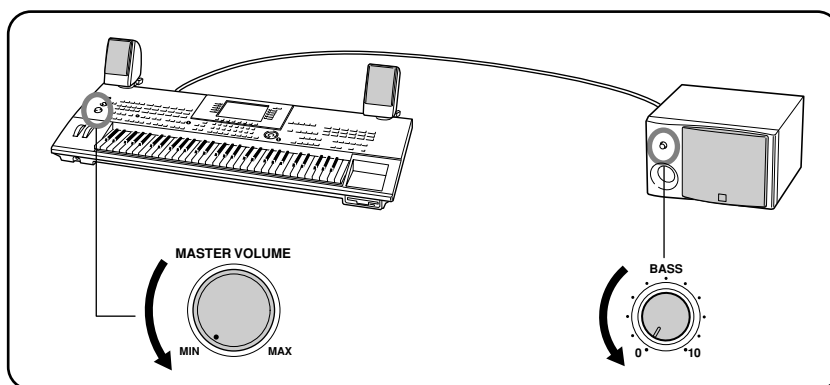

- ▶ **9** Adjust the volume controls (**MASTER VOLUME** on the TYROS and **BASS** on the subwoofer) to appropriate levels.

Installing an Optional Hard Disk

By installing an optional hard disk drive to the TYROS, you can vastly expand the data storage capacity — letting you create a large library of your important data, without having to worry about a lack of memory space. The hard disk used must be a 2.5-inch IDE-compatible; however, not all such drives may be installable.

⚠ WARNING

- Before beginning installation, switch off the power to the TYROS and connected peripherals, and unplug them from the power outlet. Then remove all cables connecting the TYROS to other devices. (Leaving the power cord connected while working can result in electric shock. Leaving other cables connected can interfere with work.)
- Be careful not to drop any screws inside the instrument during installation (this can be prevented by keeping the optional units and cover away from the instrument while attaching). If this does happen, be sure to remove the screw(s) from inside the unit before turning the power on. Loose screws inside the instrument can cause improper operation or serious damage. If you are unable to retrieve a dropped screw, consult your Yamaha dealer for advice.
- Install the optional units carefully as described in the procedure below. Improper installation can cause shorts which may result in irreparable damage and pose a fire hazard.
- Do not disassemble, modify, or apply excessive force to board areas and connectors on optional hard disk units. Bending or tampering with boards and connectors may lead to electric shock, fire, or equipment failures.

⚠ CAUTION

- It is recommended that you wear gloves to protect your hands from metallic projections on optional units and other components. Touching leads or connectors with bare hands may cause finger cuts, and may also result in poor electrical contact or electrostatic damage.
- Handle the optional hard disk unit with care. Dropping or subjecting them to any kind of shock may cause damage or result in a malfunction.
- Be careful of static electricity. Static electricity discharge can damage the IC chips on the hard disk. Before you handle the optional hard disk, to reduce the possibility of static electricity, touch the metal parts other than the painted area or a ground wire on the devices that are grounded.
- Do not touch the exposed metal parts in the circuit board. Touching these parts may result in a faulty contact.
- Be careful not to misplace any of the screws since all of them are used.
- Do not use any screws other than what are installed on the instrument.

🔧 NOTE

- Hard disk drives wider than 12.7 mm cannot be installed to the TYROS.
- For information on the hard disk recommendations, ask your nearest Yamaha representative or an authorized distributor listed at the end of this owner's manual. Install a hard disk at your own risk. Yamaha will not be held responsible for any damage or injury resulting from improper installation or the use of a hard disk other than one of the types recommended by Yamaha.

Before following the steps below, make sure you have an appropriate hard disk drive and a Phillips screwdriver.

- ▶ **1** Turn the TYROS' power off, and disconnect the AC power cord. Also, make sure to disconnect the keyboard from any other external devices.
- ▶ **2** Turn the TYROS face down on a blanket or some soft surface, giving you direct access to the bottom of the instrument.

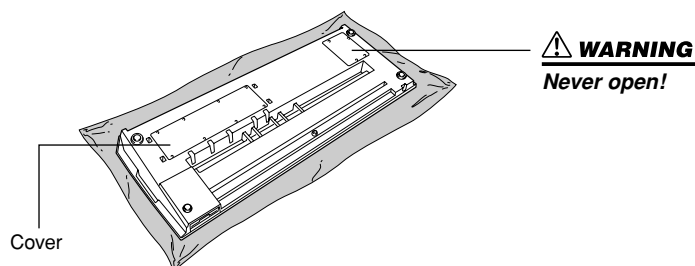

- ▶ **3** Remove the eight screws from the cover. Do not remove the other screws.

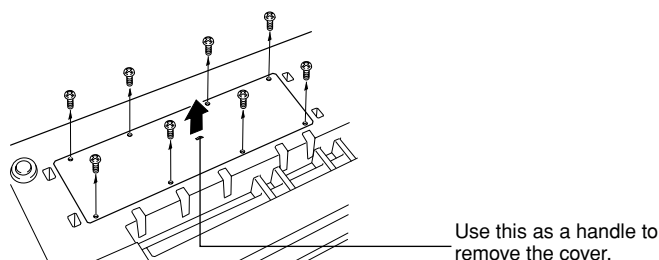

- ▶ **4** Remove the four screws from the hard disk cover inside.

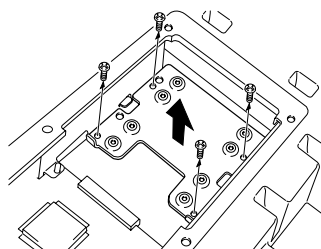

- ▶ **5** Remove the hard disk cover, turn it face down and remove the four screws from the center.

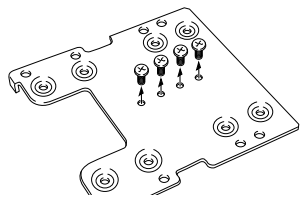

- ▶ **6** Attach the hard disk unit to the hard disk cover using the screws you removed in step #5.

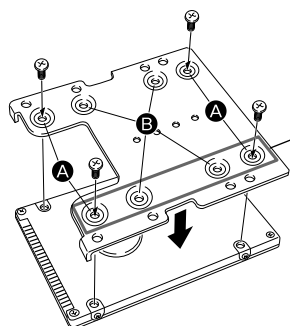

You should tighten these two screws first.

Make sure the bottom of the hard disk is facing up. Depending on the type of hard disk drive you plan to install, select holes (A) or holes (B) to attach the hard disk drive.

* Holes (A) are used in this illustration.

- ▶ **7** Replace the hard disk drive and cover (included with the hard disk) by fitting it into the TYROS as shown in the illustration.

Make sure not to bend the pins.

In the middle of the hard disk connector is a "missing" pin. Make sure to align the cable connector (which has a corresponding "missing" hole) to the hard disk as shown.

These four pins are unused.

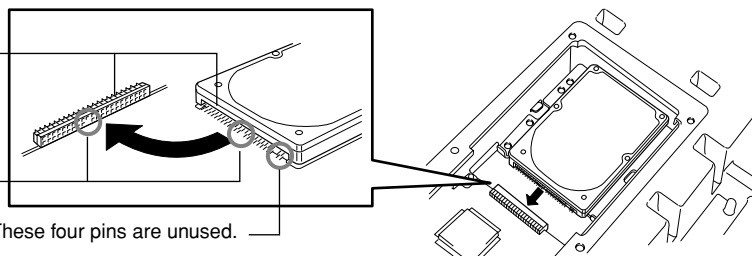

- ▶ **8** Replace the hard disk cover, and attach it with the four screws removed in step #4.

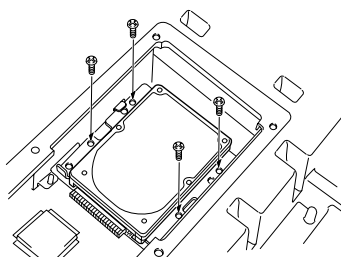

- ▶ **9** Replace the cover and attach it with the six screws removed in step #3.

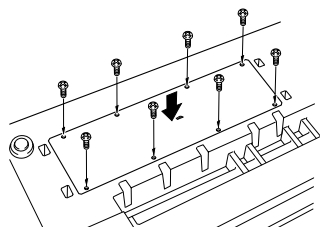

- ▶ **10** Check that the installed hard disk is functioning properly.

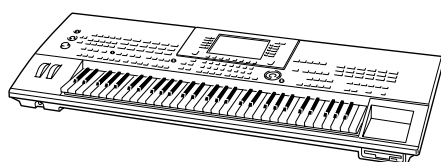

Turn on the power, go to the [FUNCTION] → UTILITY → DISK display, and execute the HD Format function (page 157). If the format is completed with no trouble and the HD drive tab appears on the Open/Save display, the hard disk is OK.

NOTE

- If you have installed a hard disk that was once used for the PSR-8000 and turn the TYROS' power on, a message appears prompting you to convert the data on the hard disk for use with the TYROS. If you select "YES," the files on the hard disk will be converted so that they can be viewed on the TYROS' LCD display — however, they will not be accessible. To actually use the files on the TYROS, you will need to convert the PSR-8000 data using a computer and the File Converter software (contained in the included CD-ROM).

NOTE

- If you have installed the hard disk that was once used for the PSR-9000/9000Pro and turn the TYROS' power on, you can immediately view the files on the hard disk and use the song files from the PSR-9000/9000Pro. However, to properly use the style, Multi Pad, and Registration Memory files from the PSR-9000/9000Pro, you will need to convert the data using a computer and the File Converter software (contained in the included CD-ROM).

Troubleshooting

PROBLEM	POSSIBLE CAUSE/SOLUTION
When using a mobile phone, noise is produced.	Using a mobile phone in close proximity to the TYROS may produce interference. To prevent this, turn off the mobile phone or use it further away from the TYROS.
No sound results.	<ul style="list-style-type: none"> • The RIGHT1/RIGHT2/RIGHT3/LEFT voice volume settings on the BALANCE pop-up window could be set too low. Make sure the voice volumes are set at appropriate levels (page 36). • The Local Control function could be turned off. Make sure Local Control is turned on (page 146). • The [MASTER VOLUME] controls or foot volume are turned all the way down. Set the [MASTER VOLUME] controls and foot volume to a reasonable listening level. • Are the desired keyboard parts turned on? ([PART ON/OFF] button — page 74) • Are the desired parts or channels turned on? ([CHANNEL ON/OFF] button — page 37) • A pair of headphones is plugged into the PHONES jack. Unplug the headphones. • A plug is inserted in the LOOP SEND jacks. Unplug the LOOP SEND jacks. • Is the Footswitch connected to the appropriate connector (page 18)? • The [FADE IN/OUT] button (page 109) is on and has reached the end of its duration, muting the sound. Press the [FADE IN/OUT] button so that its indicator goes out. • Check whether the external speaker is connected properly.
The voice selected from the Open/Save display will not be sounded.	Check whether or not the selected part is turned on (page 74).
Not all simultaneously-played notes sound.	You are probably exceeding the maximum polyphony of the TYROS. The TYROS can play up to 128 notes at the same time — including voice RIGHT2, voice RIGHT3, voice LEFT, style, song, and multi pad notes. When the maximum polyphony is exceeded, the earliest played notes will stop sounding, letting the latest played notes sound. This is referred to as “lastnote priority.”
Style playback seems to “skip” when the keyboard is played.	
The style or song does not play back even when pressing the [START/STOP] button.	Make sure the MIDI clock is set to “INTERNAL” (page 146).
The Multi Pads do not play back, even when one of the MULTI PAD buttons is pressed.	
The style does not start, even when Synchro Start is in standby condition and a key is pressed.	You may be trying to start style by playing a key in the righthand range of the keyboard. To start the style with Synchro Start, make sure to play a key in the left-hand (chord) range of the keyboard.
Only the rhythm channel of style plays.	Make sure the [ACMP] is turned on.
Certain notes sound at the wrong pitch.	Make sure that the scale tuning value for those notes is set to “0” (page 150).
Style chords are recognized regardless of the split point or where chords are played on the keyboard.	Check whether the fingering mode is set to “Full Keyboard” or not. If the Full Keyboard fingering mode is selected, chords are recognized over the entire range of the keyboard, irrespective of the split point setting.

PROBLEM	POSSIBLE CAUSE/SOLUTION
The Vocal Harmony effect sounds distorted or out-of-tune.	Your vocal microphone may be picking up extraneous sounds, such as the style sound from the TYROS. In particular, bass sounds can cause mistracking of the Vocal Harmony. To remedy this: <ul style="list-style-type: none"> • Sing as closely to the microphone as possible. • Use a directional microphone. • Turn down the MASTER VOLUME, style volume, or song volume control. • Separate the microphone from the external speakers as much as possible. • Cut the Low band via the 3 Band EQ function in the MIC SETUP display (page 132).
The microphone input signal and Vocal Harmony sound cannot be recorded.	This is normal; recording the audio input of the microphone is not possible.
When a voice is changed, the previously selected effect is changed.	This is normal, each voice has its own suitable preset values which are automatically recalled when the corresponding Voice Set parameters are turned on (page 151).
There is a slight difference in sound quality between notes played on the keyboard.	This is normal and is a result of the TYROS' sampling system.
Some voices have a looping sound.	
Some noise or vibrato is noticeable at higher pitches, depending upon the voice.	
Some voices jump an octave in pitch when played in the upper or lower registers.	Some voices have a pitch limit which, when reached, causes this type of pitch shift. This is normal.
The style chord does not change even when a different chord is played or the chord is not recognized.	<ul style="list-style-type: none"> • Are you sure you're playing on the left-hand section of the keyboard? • You may be using single-finger type fingering (page 108).
The displayed disk free area value does not coincide with the actual value.	The displayed value is an approximate value.
Appropriate harmony notes are not produced by the Vocal Harmony feature.	Make sure you are using the appropriate method to specify the harmony notes for the current Vocal Harmony mode. See page 133.
The voice produces excessive noise.	Certain voices may produce noise, depending on the Filter (Harmonic Content/Brightness) or EQ settings of the Mixing Console Filter. This is unavoidable due to the sound generation and processing system of the TYROS. To avoid noise, change the above mentioned settings.
The sound is distorted or noisy.	<ul style="list-style-type: none"> • The MASTER VOLUME control may be turned up too high. • This may be caused by the effects. Try cancelling all unnecessary effects, especially distortion-type effects. • Some filter resonance settings in the Sound Creator display can result in distorted sound. • Is the gain of the Low band set too high in the Master EQ display (Mixing Console — page 139)?
A strange “flanging” or “doubling” sound occurs.	<ul style="list-style-type: none"> • Are the RIGHT1 and RIGHT2 parts set to “ON”, for example, and both parts set to play the same voice? • If you are routing the MIDI OUT on the TYROS to a sequencer and back to the MIDI IN, you may want to set Local Control (page 146) to “off” to avoid MIDI “feedback.”
The sound is slightly different each time the keys are played.	
The Main display does not appear even when turning the power on.	This may occur if a hard disk has been installed to the TYROS. Installation of some hard disk units may result a long interval between turning the power on and appearance of the Main display.

Glossary

A

Auto Accompaniment (Style playback)

A function that generates pre-programmed rhythm, bass and chord backing in response to specific notes/chords played (or received via MIDI).

C

Chorus

One of the Effect types.

Depending on the particular chorus type and parameters, this can make a voice sound “larger,” as if several identical instruments were playing in unison, or it can give a voice greater warmth and depth.

Clock

[1]

A unit of note resolution for MIDI Sequence data.

The sequencer determines the playback position of the Song or Pattern (MIDI sequence data) by using the following three parameters: Measure, Beat, and Clock.

[2]

Also referred to as “MIDI Clock,” defined as System Real-time Message in MIDI. This message is transmitted with a fixed interval (24 times per 1/4 note) to synchronize connected MIDI instruments.

On MIDI Sequencers, you can select whether the instrument’s internal clock will be used as the Timing Clock, or external Timing Clock messages received via MIDI IN will be used.

Control Change

A set of MIDI Channel messages that allow for control of a wide variety of sound parameters, including modulation, pan, volume, expression, brightness, effect depth, and others.

These can be adjusted using physical controllers, such as the Modulation Wheel and the Foot Controller.

D

Depth

Refers to the amount or degree to which a parameter setting changes the original sound.

E

Effect

On the TYROS, an “Effect” is a processing block that alters the sound output from the tone generator block of the instrument, using DSP (Digital Signal Processing) circuitry to change the sound in various ways. The TYROS provides two types of effects: the DSP effects described above (such as Reverb, Chorus, DSP and DSP variation) and other effects (such as Harmony/Echo, Initial Touch, Sustain, and Poly/Mono).

Event List

A useful Song/Style/Multi Pad Creator tool that arranges all events in a song in chronological order (in measures, beats, clocks), and allows you to make detailed changes to those events.

F

Factory Reset

Refers to the original, factory-programmed settings of User drive memory, loaded to the instrument before it is shipped.

Flash ROM

ROM that can be overwritten allowing you to store your own original data, unlike conventional ROM.

G

Gate Time

In sequence recording, this determines the actual length of time a note sounds.

When entering the note events in Step Recording of the MIDI sequencer, Gate time is determined as a percent value of the step time. A setting of approximately 50% produces a staccato sound, values between about 80% and 90% produce normal note length, and a value of 100% will produce a slur.

L

Left-hand section of the keyboard

The section of keys to the left of the split point. Besides being used to play the LEFT voice, they can also be used to indicate/play chords for style playback as well as the Harmony and Vocal Harmony effects.

LFO

An abbreviation for low frequency oscillator, which generates a low frequency signal on the tone generator block. The signal from the LFO can be used to modulate the pitch, filter, and amplitude. Modulating the pitch produces a vibrato effect, modulating the filter produces a wah effect, and modulating the amplitude produces a tremolo effect.

Lower

A keyboard part played on the left side of the keyboard from the split point for the voices instead of LEFT. This part is not affected by the on/off status of the [ACMP] button.

N

Note On/Off

MIDI messages which represent notes played on a keyboard or other instrument. Pressing a key produces a Note On message, and a Note Off message is produced when the key is released.

Note On message includes a specific note number which corresponds to the key which is pressed, plus a velocity value based on how hard the key is struck.

P**Path**

Refers to the location of the folders and files currently indicated on the LCD display.

Pop-up window

A “small” window that appears on the LCD display temporarily.

Program Change

A MIDI channel message that determines the voice number by specifying the program number. Combining this with Bank Select messages allows you to select any of the voices via MIDI.

Preset

Preset Data supplied with the internal memory of the TYROS shipped from the factory. There are various types of Preset data, such as Preset voices, Preset songs, Preset waves — as opposed to User data, which is your own originally created data.

R**RAM**

An acronym for Random Access Memory that allows both reading and writing of data. This can be used for the Edit Buffer and the data created by editing or recording.

Reverb

Also called “reverberation,” this refers to the sound energy remaining in a room or closed space after the original sound stops. Similar to yet different from echo, reverb is the indirect, diffuse sound of reflections from the walls and ceiling that accompany the direct sound. The characteristics of this indirect sound depends on the size of the room or space and the materials and furnishings in the room. Reverb Effect types use digital signal processing to simulate these characteristics.

Right-hand section of the keyboard

The section of keys to the right of the split point, used to play the RIGHT 1 - 3 voices.

Revoice

A function that changes the voice for each part or channel of the selected style or song to one of the specially created voices of the TYROS.

ROM

An acronym for “Read Only Memory.”

This type of memory can be read from but not written to or erased. All preset data supplied with the instrument is contained on ROM.

S**Song Position**

Refers to the place within song data at which playback is started, being done, or where notes are input in step recording. This is indicated in units of Measure (Bar), Beat, Clock.

U**Upper**

A keyboard part played on the right side of the keyboard from the split point for the voices instead of RIGHT1, 2, and 3.

User

Refers to the data you create via various functions of the TYROS.

There are various types of User data, such as User voices, User songs, User waves — as opposed to Preset data, which is factory-programmed data built into the TYROS.

V**Velocity**

A parameter within the MIDI Note On message that conveys the force of the note.

Vibrato

A quavering, vibrating sound that is produced by regularly modulating the pitch of the voice.

Specifications

Sound Source:	AWM	
Keyboard:		
Keys	61 Keys (C1 ~ C6)	
Touch Response	Initial Touch/Aftertouch	
Polyphony:	128 Notes max	
Voices:		
Preset Voices	1185	403 voices (Normal: 393 + Mega: 10) + 10 Organ Flutes voices + 480 XG voices + 256 GM2 voices + 31 drum kits (XG and Panel: 22 + GM2: 9) + 5 SFX kits
User Voices (created with Sound Creator function)	Maximum number is unlimited; depends solely on the capacity of the USER/FD/HD drives. *	Created data can be saved to the USER/FD/HD drive.
Custom Voices (created with Voice Editor software)	Normal Voice: 128 max	Maximum number varies according to the type of voice created and the way in which it was created or edited. For example, if only Live! GrandPiano voices are saved as Custom voices, up to 94 voices can be saved.
	Drum Voice: 10 max	Maximum number varies according to the type of voice created and the way in which it was created or edited. For example, if only Live! StandardKit voices are saved as Custom voices, up to 10 voices can be saved.
Organ Flutes	10 Preset	Created data can be saved to USER/FD/HD drive.
Orchestration:		
Upper	3 parts	RIGHT1, RIGHT2, RIGHT3
Lower	1 parts	Includes LEFT HOLD function.
Split Point (Left)	F#2	Can be set and memorized.
Split Point (Style)	F#2	Can be set and memorized.
Effects:		
Reverb	34 Preset + 3 User	1 block; parameters including depth can be edited.
Chorus	26 Preset + 3 User	1 block; parameters including depth can be edited.
DSP Effect	183 Preset + 3 User	1 block for style and song; parameters including depth can be edited.
DSP Effects	183 Preset + 10 User	4 blocks for RIGHT1, 2, 3, and LEFT; parameters including depth can be edited.
DSP Effect	183 Preset + 10 User	1 block for microphone; parameters including depth can be edited.
DSP Variation	(Available)	4 blocks for RIGHT1, 2, 3, and LEFT
Poly/Mono	(Available)	When set to MONO, the Portamento Time can be set.
Vocal Harmony	60 Preset + 10 User	3 notes polyphony; parameters including balance can be edited.
Microphone Effect	Noise Gate x 1, Compressor x 1, 3 Band EQ x 1	
Harmony/Echo	17 Preset	
Master EQ	5 Preset + 2 User	5 Band
Part EQ	29 parts	2 Band, 29 parts (RIGHT1, RIGHT2, RIGHT3, LEFT, STYLE x 8, SONG x 16, M.PAD)
Master Compressor	5 Preset + 5 User	3 Band. Type, Threshold, and Gain (3 Band) can be set.
Touch Response	5 Preset	
Tempo	5 ~ 500	
Transpose	-12 ~ 0 ~ 12	Can be set independently for Keyboard, Song, and Master.
Tune	414.8 ~ 440 ~ 466.8Hz	Set in 0.2Hz units. A3 is set to 440Hz as default.
Upper Octave	-1, 0, +1	
Part Octave	-2, -1, 0, +1, +2	
Pitch Bend Wheel	(Available)	
Modulation Wheel	(Available)	
Style:		
Preset Styles	300	Assigned to 10 category buttons
User Styles	Maximum number is unlimited; depends solely on the capacity of the USER/FD/HD drives. *	Created data can be saved to the USER/FD/HD drive.
Style selection	Can be switched between PRESET and USER/DISK	When USER/DISK is turned ON, the path can be set to each of 10 category buttons.
Data Format	Style File Format	Up to 120 Kbytes per style
Controls	INTRO x 3	
	FILL IN x 4	
	BREAK x 1	
	MAIN x 4	
	ENDING x 3	Includes ritardando (rit.) function
	FADE IN/OUT	
	TAP TEMPO	
Fingered Mode		Single Finger, Multi Finger, Fingered, On Bass, Full Keyboard, AI Fingered, AI Full Keyboard

One Touch Setting:	4 setups per style	Programmable
Music Finder:	1446 Records	Programmable up to 2500 Records.
Multi Pad:		
Control	PAD 1/2/3/4, STOP	
Bank	Maximum number is unlimited; depends solely on the capacity of the USER/FD/HD drives. *	Created data can be saved to the USER/FD/HD drive.
Song:		
Playback method	Disk Direct playback	Includes Quick Start function
Selection controls	I/II/III/IV/V/VI	Includes Chain playback, Random playback, and the reservation of next song (NEXT/CANCEL) function.
Playback controls	SP1/SP2/SP3/SP4/LOOP	Up to 4 song positions can be set and used for Jump/Loop playback.
Maximum number of songs	Maximum number is unlimited; depends solely on the capacity of the USER/FD/HD drives. *	Created data can be saved to the USER/FD/HD drive.
Channels	16	
Recording capacity	Approximately 35,000 notes max.	Recording methods: Quick Record, Multi Track Record, Step Record, Chord Step
Registration Memory:	8 buttons	Includes Freeze function. Created data can be saved to the USER/FD/HD drive.
Language:	6 languages	English, German, French, Spanish, Italian, Japanese
Display:		
	Backlit Graphic LCD	7.8 inch, 640 x 480 dot
Lyrics	(Available)	XF, TUNE1000
Lyrics (others)	(Available)	KAR, M-Live
Score	(Available)	SMF
File Selection type	Direct Selection/Number Input	Voices, styles, songs, Multi Pad banks, Registration Memory banks can be selected.
Disk:		
Compatible format	XG, XF, GM, GM Level2, SMF, DOC, Piano Player (ESEQ), Style File Format (SFF)	
User drive	3.3 MB	Up to 250 files/folders can be created in one folder.
Floppy disk	3.5" 2HD/2DD	Up to 250 files/folders can be created in one folder. Floppy disk capacity (root directory): up to 224 files/folders for 2HD, up to 112 files/folders for 2DD.
Hard disk	2.5-inch HD (optional)	Up to 250 files/folders can be created in one folder.
Demonstrations:	6 languages	English, German, French, Spanish, Italian, Japanese
Help:	6 languages	English, German, French, Spanish, Italian, Japanese
Connectors:		
MIDI	MIDI A (IN/OUT)	
	MIDI B (IN/OUT)	
Controls	FOOT PEDAL 1/2/3	Assignable; default settings are 1: Sustain, 2: DSP Variation, 3: Volume.
USB	USB Slave x 1	USB Ver. 1.1
Video Out	NTSC/PAL Composite Signal	The current LCD contents or the Lyrics of the current song can be displayed on an external video monitor.
Audio (Analog)	PHONES	
	LOOP SEND (L/L+R, R)	
	LINE OUT MAIN (L/L+R, R), SUB (1/2)	
	AUX IN/LOOP RETURN (L/L+R, R), TRIM VOL	
	TO SUB WOOFER L/R	
	TO LEFT/RIGHT SPEAKER	
	MIC/LINE IN	Includes TRIM and INPUT VOLUME controls, and SIGNAL/OVER indicator. A standard dynamic microphone with an impedance of about 250 ohms is recommended.
Power Supply	AC Inlet	
Dimensions:	1140 (L) x 428 (D) x 137 (H) mm	Not including the music rest, speakers and brackets.
Weight:	12.4 kg	
Optional Accessories:		
Speaker	TRS-MS01	
Foot Switch	FC4/5	
Foot Controller	FC7	
Headphones	HPE-150/HPE-160	
Keyboard Stand	L-7/L-7S	
Bench	BC-6	
Hard Disk	2.5-inch IDE	Height 12.7 mm max., 40 GB max. (current availability; support for up to 137 GB)

* Up to 250 files/folders can be created in one folder of the User/FD/HD drive.

* Specifications and descriptions in this owner's manual are for information purposes only. Yamaha Corp. reserves the right to change or modify products or specifications at any time without prior notice. Since specifications, equipment or options may not be the same in every locale, please check with your Yamaha dealer.

Index

3

3BAND EQ 132

A

Accent Type..... 119

Accompaniment 32

ACMP 32, 75

Aftertouch 81, 154

AI Fingered 109

AI Full Keyboard..... 109

Amplitude 86

Any Key 48

APPEND 127

ARABIC..... 151

Assembling 114, 118

ASSEMBLY 77

Assembly 118

ASSIGN 155

AT 147

Attack 87

AUTO FILL IN 34, 75

B

BACK 61

BALANCE..... 16, 36, 76

Bank 52

Bar..... 24

Bar Clear 120

Bar Copy 120

BASIC..... 77

Basic Operations 60

BASS HOLD 153

Beat 98, 100

Beat Converter 119

BREAK 34, 75

Brightness 87, 135

C

CC..... 147

CD-ROM 7

CHANNEL 77

Channel message 142

CHANNEL ON/OFF..... 16, 45, 76

Channel Transpose..... 97

CHD 77

CHORD..... 121

Chord..... 108

CHORD DETECT 76

CHORD FINGERING 76

Chord Fingerings 108

Chord Match..... 38, 125

CHORD NOTE ONLY 155

Chord Tutor 108

Chordal 133

Chorus..... 136

Clock 98, 100, 146

CMP 76

COMMON..... 77

Compressor 133

Computer 58

CONFIG 76, 156

Control Change 105, 142

CONTROLLER 76, 77

Copy 68

Current 93

Cursor 73

Custom Voice..... 79, 85, 159

Cut 68

Cutoff Frequency..... 87

D

DATA ENTRY 60

Decay..... 87

Delay 87

Delete..... 69, 96

DEMO 17, 76

Demo 24

Depth 87

Destination..... 97

DIGITAL RECORDING..... 17, 77

Digital Recording 94, 114, 124

Direct Access..... 62

DISK 76, 156

Disk 6

Disk drive 64, 65

Display Message 62

Display Voice Number 156

DOC 8

DORIAN 121

Drum Kit 79

DSP 39, 77, 81

DSP Type..... 84

DSP VARIATION..... 153

DSP Variation 39, 81

DSP1-6..... 136

Dynamics..... 118

E

Echo Types..... 155

EDIT..... 77

EFFECT 75, 76

Effect 136

EFFECT/EQ..... 76

EG..... 87

ENDING 34, 75, 153

ENTER 60

Envelope Generator..... 87

EQ..... 76, 139

EQUAL TEMPERAMENT 151

Equalizer 139

ESEQ..... 144

Event List 94, 98, 100, 117, 125

Exclusive messages..... 142

EXIT..... 61

F

Factory Reset..... 159

FADE IN TIME 156

FADE IN/OUT..... 16, 75, 153

Fade In/Out 35, 109, 156

FADE OUT HOLD TIME 156

FADE OUT TIME 156

FD drive 30, 63

FF (Fast Forward)..... 75

File 63

File Utility 59, 64

FILL BREAK 153

FILL DOWN 153

FILL IN..... 34

FILL SELF 153

- FILL UP 153
 FILTER 76
 Filter 86, 87
 Fine 119
 FING/ON BASS 153
 Fingered 108
 Fingered On Bass 108
 Fingering 108
 Flash ROM 64, 65
 Floppy disk 6
 Floppy Disk Drive 6, 17
 Folder 63
 Follow Lights 48, 49
 FOOT PEDAL 76, 152
 Foot Volume 152
 Footage 83
 Footswitch 152
 FREEZE 76
 Freeze 53, 128
 Full Keyboard 109
 FUNCTION 17, 76
 Function Tree 75
- G**
 GLIDE 152
 GM 8, 79
 GM System Level 1 8
 GM System Level 2 8
 GM2 8, 79
 GROOVE 77
 Groove 118
 GUIDE 17, 77
 Guide 48
- H**
 Harmonic Content 87, 135
 HARMONIC MINOR 121
 HARMONY 77
 Harmony mode 47
 Harmony Types 155
 HARMONY/ECHO 77, 153
 Harmony/Echo 39, 154
 HD drive 63
 HELP 17, 76
 Help 61
- HIGH KEY 115, 122
- I**
 INITIAL TOUCH 77
 Initial Touch 39, 81
 INPUT VOLUME 46, 75, 130
 Insertion Effect 137
 INTRO 34, 75
- J**
 Jump 44
 Jump Marker 91
- K**
 Karao-key 48
 Kbd. Vel (Keyboard Velocity) 101
 Key Signature 89, 106
 Keyboard 16, 74, 81
 Keyboard part 78, 134
 Keyboard Transpose 82
 Keyword 41
- L**
 Language 61, 93, 158
 LCD 17, 60, 151
 LCD buttons 60
 LCD contrast 23
 LEFT 28, 74, 153
 Left Hold 78
 Length 84
 LFO 86
 LINE OUT 76
 Line Out Settings 140
 Local Control 146
 LOOP 75
 Loop 43, 44
 Loop End Marker 91
 Loop Recording 115
 Lower 146
 LYRICS 77, 151
 Lyrics 90
 Lyrics Background Picture 63, 90
- M**
 MAIN 153
 Main display 24
 MAIN jacks 141
 Main picture 63, 158
 MAIN VARIATION 75
 Marker 44, 106
 Master Compressor 136, 140
 Master EQ 136, 139
 Master Transpose 82
 MASTER TUNE 76, 150
 MASTER VOLUME 16, 22, 75
 Maximum Polyphony 80
 MEAN-TONE 151
 Measure 98, 100
 Mega Voice 80
 MELODIC MINOR 121
 MEMORY 76
 Memory Drive 62
 Message Switch 146
 Meta Event 106
 METRONOME 16, 75
 Metronome 156
 MFC10 18, 76, 148
 MIC 16, 75, 130
 MIC SETTING 75
 MIC/LINE IN 19, 46
 Microphone 46, 130
 MIDI 76, 142
 MIDI channel 143
 MIDI Setup 63, 159
 MIDI Template 63, 145
 Mix 97
 MIXING CONSOLE 16, 76
 Mixing Console 134
 Mode 84
 MODULATION 153
 Modulation 86
 MODULATION
 wheel 17, 77, 82, 154
 Mono 39, 81, 86
 Multi Assign 155
 Multi Finger 108
 Multi Pad 38, 63, 124
 Multi Pad Bank 63
 MULTI PAD CONTROL 16, 75

- Multi Recording 56
 Music Finder 40, 63, 126, 159
 Music Rest 7, 16, 21
- N**
 Name 70
 NATURAL MINOR 121
 New Song 54, 56
 NEXT 61
 Next/Cancel 92
 Noise Gate 133
 Note 105
 Note Limit 115, 122
 Note name 78, 89
 Note number 142
 Note off 142
 Note on 142
 Note Transposition 115
 NTR 115, 121
 NTT 115, 121
- O**
 Octave 28, 86, 135
 One Touch Setting 36, 110
 Open/Save display 30, 66, 71
 Organ Flutes 29, 79, 83
 Organ Type 83
 OTS 110, 153
 OTS LINK 75
 OTS Link 110
 OTS Link Timing 112
 OVER 46, 130
 Overdub Recording 115
 OWNER 76, 158
 Owner name 158
- P**
 Panel logos 8
 Panpot 135
 PARAMETER 77
 Parameter Lock 156
 Part 134
 Part EQ 136
 PART ON/OFF 17, 77
 PART SELECT 17, 77
- Part Settings 135
 Paste 68
 Path 72
 PB 147
 PC 147
 PEDAL PUNCH IN/OUT 95
 PERCUSSION 153
 Phrase Mark 91, 93
 PITCH BEND 153
 Pitch Bend 142
 Pitch Bend Range 135
 PITCH BEND wheel 17, 77, 82
 Poly 39, 81, 86
 POLY/MONO 77
 Poly/Mono 39, 81
 PORTAMENTO 152
 Portamento 81
 Portamento Time 86, 135
 POWER ON/OFF 22, 24, 75
 PRESET 75
 Preset drive 31, 63, 64, 65
 Program Change 105, 142
 PROGRAMMABLE
 MUSIC FINDER 17, 77
 PROGRAMMABLE
 ONE TOUCH SETTING 17, 77
 Property 71
 PUNCH IN AT 95
 Punch In/Out 94
 PUNCH OUT AT 95
 PURE MAJOR 151
 PURE MINOR 151
 PYTHAGORIAN 151
- Q**
 Quantize 96
 Quick Recording 54
 Quick Start 93
- R**
 RAM 65
 Random 93
 Realtime Message 142
 Realtime Recording 94
 REC 75
 REC END 95
 REC MODE 77
 REC START 95
 RECEIVE 76
 Receive Transpose 146
 RECORD 77
 Record (Music Finder) 40, 126
 Recording 54
 REGIST BANK 76
 REGISTRATION BANK 76
 REGISTRATION MEMORY 16, 76
 Registration Memory 51, 128
 Registration Memory Bank 63
 REGISTRATION MEMORY
 CONTENTS 76
 Registration Sequence 53, 128
 Release 87
 Repeat 93, 125
 Repeat Folder 93
 REPLACE 127
 REPLACE ALL 95
 Resonance 87
 Response 84
 Reverb 136
 REW (Rewind) 75
 RIGHT1 26, 74, 153
 RIGHT2 27, 74, 153
 RIGHT3 74, 153
 rit. 34
 ROOT 76
 ROOT FIXED 121
 ROOT TRANS 121
 Rotary Speaker Speed 83
 RTR 115, 122
- S**
 Save 69
 SCALE TUNE 76, 150
 Score 88
 SCORE PAGE - 153
 SCORE PAGE + 153
 Search 41
 Section 34
 Section Set 113
 Sequence format 144

- Setup 97
- SIGNAL 46, 130
- Single Finger 108
- Sleep Time 157
- SMF 144
- SOFT 152
- SONG 16, 75
- Song 43, 63, 88
- Song Auto Open 157
- Song Auto Revoice 136
- SONG CONTROL 16, 43
- SONG CREATOR 77
- Song Creator 94
- Song Position 91
- Song Position Marker 91, 106
- SONG SETTING 76
- Song Transpose 82
- SOSTENUTO 152
- SOUND 77
- SOUND CREATOR 17, 77
- Sound Creator 83, 85
- Source 97
- Source Chord 115, 121
- Source Pattern 115
- Source Root 115, 121
- SP (Song Position) 43, 75
- Speaker 20, 156, 160
- SPEED 155
- SPLIT POINT 76
- Split Point 32, 74, 112
- START/STOP 75, 146
- Step Recording 94
- STOP 75
- Stop Accompaniment 33, 112
- STRENGTH 96
- STYLE 16, 75
- Style 32, 63, 108
- STYLE CONTROL 16, 75
- STYLE CREATOR 77
- Style Creator 114
- Style File 8
- STYLE SETTING 76
- Style Touch 113
- SUB jacks 141
- SUSTAIN 77, 152
- Sustain 39, 81
- Swing 119
- SYNC START 32, 74, 75, 110, 153
- SYNC STOP 35, 75, 110, 153
- Synchro Start 32, 74, 110
- Synchro Stop 35, 110
- Synchro Stop Window 112
- SYS/EX 77, 146
- SYSTEM 76
- System 146
- System Effect 137
- System Exclusive Message 142
- System Message 142
- SYSTEM RESET 76
- System Reset 159
- System Setup 63, 159
- T**
- TALK 75, 153
- Talk Setting 132
- Tap 35, 109
- TAP TEMPO 16, 75, 153
- TEMPO 16, 75
- Tempo 106, 109
- Time Signature 106
- TOP 75
- TOUCH LIMIT 155
- Touch Sense 86
- TRANSMIT 76
- Transmit 146
- TRANSMIT CLOCK 146
- TRANSPOSE 16, 75
- Transpose 82, 135
- TRANSPOSE ASSIGN 154
- TUNE 76
- Tuning 135, 150
- TV monitor 90
- U**
- Upper 146
- UPPER OCTAVE 17, 77
- Upper Octave 28, 82
- USB 18, 58
- USB cable 7
- User drive 30, 63, 64, 65
- User Effect 63, 138, 159
- User Master Compressor 63, 140
- User Master EQ 63, 139
- User Voice 85
- USER/DISK 75
- UTILITY 76
- Utility 156
- V**
- Velocity 142
- VH TYPE SELECT 75
- Vibrato 87
- Vibrato depth 83
- Vibrato on/off 83
- Vibrato Speed 84
- VIDEO OUT 76, 151
- VIEW 71
- Vocal Cue Time 48, 50
- VOCAL HARMONY 75, 153
- Vocal Harmony 8, 47, 136
- Vocal Harmony mode 133
- Vocal Harmony Type 47
- Vocoder 133
- VOICE 17, 77
- Voice 26, 63, 78
- Voice Allocation Format 144
- Voice Editor 59, 64
- VOICE EFFECT 17, 77
- Voice Effect 39, 81
- VOICE SET 76
- Voice Set 151
- VOL/VOICE 76
- VOLUME 152, 155
- Volume 84, 86
- X**
- XF 8
- XG 8, 79

FCC INFORMATION (U.S.A.)

1. IMPORTANT NOTICE: DO NOT MODIFY THIS UNIT!

This product, when installed as indicated in the instructions contained in this manual, meets FCC requirements. Modifications not expressly approved by Yamaha may void your authority, granted by the FCC, to use the product.

2. IMPORTANT: When connecting this product to accessories and/or another product use only high quality shielded cables. Cable/s supplied with this product MUST be used. Follow all installation instructions. Failure to follow instructions could void your FCC authorization to use this product in the USA.

3. NOTE: This product has been tested and found to comply with the requirements listed in FCC Regulations, Part 15 for Class "B" digital devices. Compliance with these requirements provides a reasonable level of assurance that your use of this product in a residential environment will not result in harmful interference with other electronic devices. This equipment generates/uses radio frequencies and, if not installed and used according to the instructions found in the users manual, may cause interference harmful to the operation of other electronic devices. Compliance with FCC regulations does

not guarantee that interference will not occur in all installations. If this product is found to be the source of interference, which can be determined by turning the unit "OFF" and "ON", please try to eliminate the problem by using one of the following measures:

Relocate either this product or the device that is being affected by the interference.

Utilize power outlets that are on different branch (circuit breaker or fuse) circuits or install AC line filter/s.

In the case of radio or TV interference, relocate/reorient the antenna. If the antenna lead-in is 300 ohm ribbon lead, change the lead-in to co-axial type cable.

If these corrective measures do not produce satisfactory results, please contact the local retailer authorized to distribute this type of product. If you can not locate the appropriate retailer, please contact Yamaha Corporation of America, Electronic Service Division, 6600 Orangethorpe Ave, Buena Park, CA90620

The above statements apply ONLY to those products distributed by Yamaha Corporation of America or its subsidiaries.

* This applies only to products distributed by YAMAHA CORPORATION OF AMERICA.

(class B)

IMPORTANT NOTICE FOR THE UNITED KINGDOM Connecting the Plug and Cord

IMPORTANT. The wires in this mains lead are coloured in accordance with the following code:

BLUE : NEUTRAL
BROWN : LIVE

As the colours of the wires in the mains lead of this apparatus may not correspond with the coloured markings identifying the terminals in your plug proceed as follows:

The wire which is coloured BLUE must be connected to the terminal which is marked with the letter N or coloured BLACK.

The wire which is coloured BROWN must be connected to the terminal which is marked with the letter L or coloured RED.

Making sure that neither core is connected to the earth terminal of the three pin plug.

* This applies only to products distributed by Yamaha-Kemble Music (U.K.) Ltd. (2 wires)

CAUTION: TO PREVENT ELECTRIC SHOCK, MATCH WIDE BLADE OF PLUG TO WIDE SLOT, FULLY INSERT.

ATTENTION: POUR ÉVITER LES CHOCs ÉLECTRIQUES, INTRODUIRE LA LAME LA PLUS LARGE DE LA FICHE DANS LA BORNE CORRESPONDANTE DE LA PRISE ET POUSSER JUSQU'AU FOND.

* This applies only to products distributed by Yamaha Canada Music Ltd. (polarity)
* Ceci ne s'applique qu'aux produits distribués par Yamaha Canada Musique Ltée.

For details of products, please contact your nearest Yamaha or the authorized distributor listed below.

Pour plus de détails sur les produits, veuillez-vous adresser à Yamaha ou au distributeur le plus proche de vous figurant dans la liste suivante.

Die Einzelheiten zu Produkten sind bei Ihrer unten aufgeführten Niederlassung und bei Yamaha Vertragshändlern in den jeweiligen Bestimmungsländern erhältlich.

Para detalles sobre productos, contacte su tienda Yamaha más cercana o el distribuidor autorizado que se lista debajo.

NORTH AMERICA

CANADA

Yamaha Canada Music Ltd.
135 Milner Avenue, Scarborough, Ontario,
M1S 3R1, Canada
Tel: 416-298-1311

U.S.A.

Yamaha Corporation of America
6600 Orangethorpe Ave., Buena Park, Calif. 90620,
U.S.A.
Tel: 714-522-9011

CENTRAL & SOUTH AMERICA

MEXICO

**Yamaha de Mexico S.A. De C.V.,
Departamento de ventas**
Javier Rojo Gomez No.1149, Col. Gpe Del
Moral, Deleg. Iztapalapa, 09300 Mexico, D.F.
Tel: 686-00-33

BRAZIL

Yamaha Musical do Brasil LTDA.
Av. Rebouças 2636, São Paulo, Brasil
Tel: 011-853-1377

ARGENTINA

Yamaha de Panamá S.A. Sucursal de Argentina
Viamonte 1145 Piso2-B 1053,
Buenos Aires, Argentina
Tel: 1-4371-7021

PANAMA AND OTHER LATIN AMERICAN COUNTRIES/ CARIBBEAN COUNTRIES

Yamaha de Panamá S.A.
Torre Banco General, Piso 7, Urbanización Marbella,
Calle 47 y Aquilino de la Guardia,
Ciudad de Panamá, Panamá
Tel: 507-269-5311

EUROPE

THE UNITED KINGDOM

Yamaha-Kemble Music (U.K.) Ltd.
Sherbourne Drive, Tilbrook, Milton Keynes,
MK7 8BL, England
Tel: 01908-366700

IRELAND

Danfay Ltd.
61D, Sallynoggin Road, Dun Laoghaire, Co. Dublin
Tel: 01-2859177

GERMANY

Yamaha Europa GmbH.
Siemensstraße 22-34, 25462 Rellingen, Germany
Tel: 04101-3030

SWITZERLAND

Yamaha Europa GmbH. Zweigniederlassung Zürich
Seefeldstrasse 94, 8008 Zürich, Switzerland
Tel: 01-383 3990

AUSTRIA

Yamaha Europa GmbH. Zweigniederlassung Wien
Schleiergasse 20, A-1100 Wien, Austria
Tel: 01-60203900

THE NETHERLANDS

Yamaha Music Nederland
Clarissenhof 5-b, 4133 AB Vianen, The Netherlands
Tel: 0347-358 040

BELGIUM

Yamaha Music Belgium
Rue de Geneve (Genevestraat) 10, 1140 - Brussels,
Belgium
Tel: 02-726 6032

FRANCE

**Yamaha Musique France,
Division Professionnelle**
BP 70-77312 Marne-la-Vallée Cedex 2, France
Tel: 01-64-61-4000

ITALY

**Yamaha Musica Italia S.P.A.,
Combo Division**
Viale Italia 88, 20020 Lainate (Milano), Italy
Tel: 02-935-771

SPAIN/PORTUGAL

Yamaha-Hazen Música, S.A.
Ctra. de la Coruna km. 17, 200, 28230
Las Rozas (Madrid) Spain
Tel: 91-201-0700

GREECE

Philippe Nakas S.A.
Navarinou Street 13, P.Code 10680, Athens, Greece
Tel: 01-364-7111

SWEDEN

Yamaha Scandinavia AB
J. A. Wettergrens Gata 1
Box 30053
S-400 43 Göteborg, Sweden
Tel: 031 89 34 00

DENMARK

YS Copenhagen Liaison Office
Generatorvej 8B
DK-2730 Herlev, Denmark
Tel: 44 92 49 00

FINLAND

F-Musiikki Oy
Kluuvikatu 6, P.O. Box 260,
SF-00101 Helsinki, Finland
Tel: 09 618511

NORWAY

Norsk filial av Yamaha Scandinavia AB
Grini Næringspark 1
N-1345 Østerås, Norway
Tel: 67 16 77 70

ICELAND

Skifan HF
Skeifan 17 P.O. Box 8120
IS-128 Reykjavik, Iceland
Tel: 525 5000

OTHER EUROPEAN COUNTRIES

Yamaha Europa GmbH.
Siemensstraße 22-34, 25462 Rellingen, Germany
Tel: 04101-3030

AFRICA

**Yamaha Corporation,
Asia-Pacific Music Marketing Group**
Nakazawa-cho 10-1, Hamamatsu, Japan 430-8650
Tel: 053-460-2312

MIDDLE EAST

TURKEY/CYPRUS

Yamaha Europa GmbH.
Siemensstraße 22-34, 25462 Rellingen, Germany
Tel: 04101-3030

OTHER COUNTRIES

Yamaha Music Gulf FZE
LB21-128 Jebel Ali Freezone
P.O.Box 17328, Dubai, U.A.E.
Tel: 971-4-881-5868

ASIA

HONG KONG

Tom Lee Music Co., Ltd.
11/F., Silvercord Tower 1, 30 Canton Road,
Tsimshatsui, Kowloon, Hong Kong
Tel: 2737-7688

INDONESIA

**PT. Yamaha Music Indonesia (Distributor)
PT. Nusantara**
Gedung Yamaha Music Center, Jalan Jend. Gatot
Subroto Kav. 4, Jakarta 12930, Indonesia
Tel: 21-520-2577

KOREA

Yamaha Music Korea Ltd.
Tong-Yang Securities Bldg. 16F 23-8 Yoido-dong,
Youngdungpo-ku, Seoul, Korea
Tel: 02-3770-0661

MALAYSIA

Yamaha Music Malaysia, Sdn., Bhd.
Lot 8, Jalan Perbandaran, 47301 Kelana Jaya,
Petaling Jaya, Selangor, Malaysia
Tel: 3-703-0900

PHILIPPINES

Yupangco Music Corporation
339 Gil J. Puyat Avenue, P.O. Box 885 MCPO,
Makati, Metro Manila, Philippines
Tel: 819-7551

SINGAPORE

Yamaha Music Asia Pte., Ltd.
11 Ubi Road #06-00, Meiban Industrial Building,
Singapore
Tel: 65-747-4374

TAIWAN

Yamaha KHS Music Co., Ltd.
10F, 150, Tun-Hwa Northroad,
Taipei, Taiwan, R.O.C.
Tel: 02-2713-8999

THAILAND

Siam Music Yamaha Co., Ltd.
121/60-61 RS Tower 17th Floor,
Ratchadaphisek RD., Dindaeng,
Bangkok 10320, Thailand
Tel: 02-641-2951

THE PEOPLE'S REPUBLIC OF CHINA AND OTHER ASIAN COUNTRIES

**Yamaha Corporation,
Asia-Pacific Music Marketing Group**
Nakazawa-cho 10-1, Hamamatsu, Japan 430-8650
Tel: 053-460-2317

OCEANIA

AUSTRALIA

Yamaha Music Australia Pty. Ltd.
Level 1, 99 Queensbridge Street, Southbank, Victoria
3006, Australia
Tel: 3-9693-5111

NEW ZEALAND

Music Houses of N.Z. Ltd.
146/148 Captain Springs Road, Te Papapa,
Auckland, New Zealand
Tel: 9-634-0099

COUNTRIES AND TRUST TERRITORIES IN PACIFIC OCEAN

**Yamaha Corporation,
Asia-Pacific Music Marketing Group**
Nakazawa-cho 10-1, Hamamatsu, Japan 430-8650
Tel: 053-460-2312

HEAD OFFICE Yamaha Corporation, Pro Audio & Digital Musical Instrument Division
Nakazawa-cho 10-1, Hamamatsu, Japan 430-8650
Tel: 053-460-3273



Yamaha PK CLUB (Portable Keyboard Home Page, English only)

<http://www.yamahaPKclub.com/>

Yamaha Manual Library

<http://www2.yamaha.co.jp/manual/english/>

M.D.G., Pro Audio & Digital Musical Instrument Division, Yamaha Corporation
© 2002 Yamaha Corporation

V922620 ???PO???.?-02B0 Printed in China

