

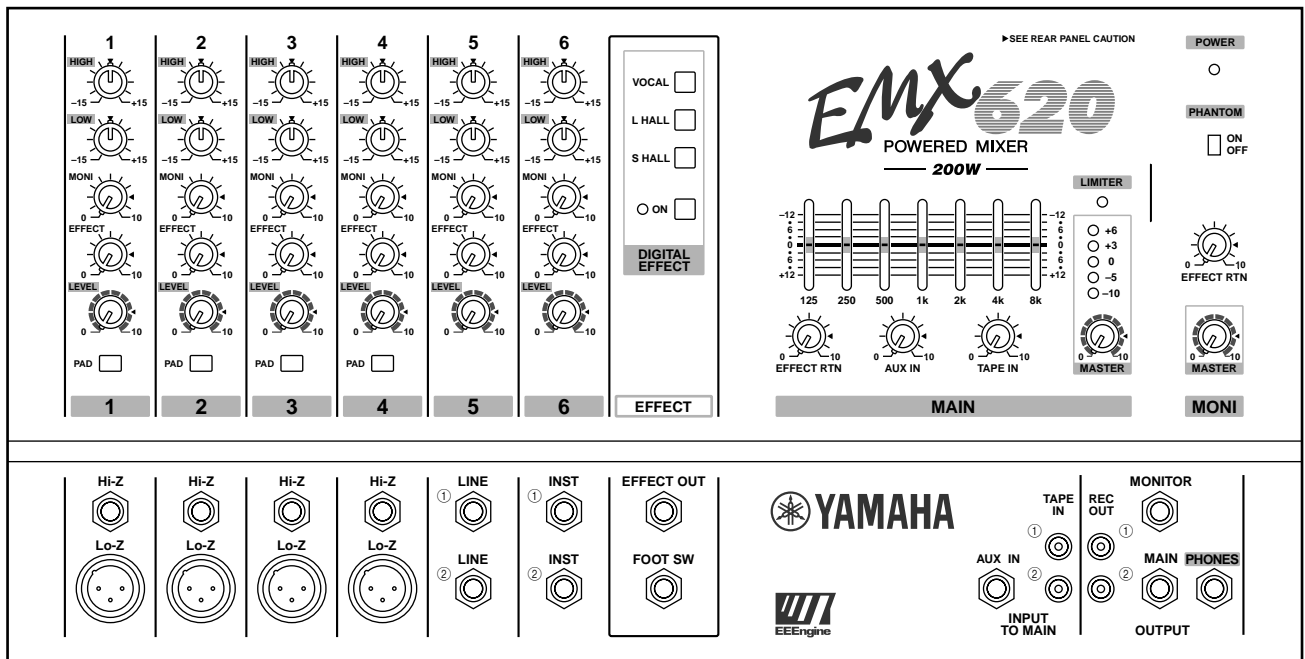

EMX620

POWERED MIXER

Owner's Manual



Keep This Manual For Future Reference.



FCC INFORMATION (U.S.A.)

1. **IMPORTANT NOTICE: DO NOT MODIFY THIS UNIT!** This product, when installed as indicated in the instructions contained in this manual, meets FCC requirements. Modifications not expressly approved by Yamaha may void your authority, granted by the FCC, to use the product.
2. **IMPORTANT:** When connecting this product to accessories and/or another product use only high quality shielded cables. Cable/s supplied with this product **MUST** be used. Follow all installation instructions. Failure to follow instructions could void your FCC authorization to use this product in the USA.
3. **NOTE:** This product has been tested and found to comply with the requirements listed in FCC Regulations, Part 15 for Class "B" digital devices. Compliance with these requirements provides a reasonable level of assurance that your use of this product in a residential environment will not result in harmful interference with other electronic devices. This equipment generates/uses radio frequencies and, if not installed and used according to the instructions found in the users manual, may cause interference harmful to the operation of other electronic devices. Compliance with FCC regulations does not guarantee that interference will not occur in all installations. If this product is found to be the source of interference, which can be determined by turning the unit "OFF" and "ON", please try to eliminate the problem by using one of the following measures: Relocate either this product or the device that is being affected by the interference. Utilize power outlets that are on different branch (circuit breaker or fuse) circuits or install AC line filter/s. In the case of radio or TV interference, relocate/reorient the antenna. If the antenna lead-in is 300 ohm ribbon lead, change the lead-in to coaxial type cable. If these corrective measures do not produce satisfactory results, please contact the local retailer authorized to distribute this type of product. If you can not locate the appropriate retailer, please contact Yamaha Corporation of America, Electronic Service Division, 6600 Orangethorpe Ave, Buena Park, CA 90620

The above statements apply **ONLY** to those products distributed by Yamaha Corporation of America or its subsidiaries.

WARNING: THIS APPARATUS MUST BE EARTHED

IMPORTANT

THE WIRES IN THIS MAINS LEAD ARE COLOURED IN ACCORDANCE WITH THE FOLLOWING CODE:

GREEN-AND-YELLOW :	EARTH
BLUE :	NEUTRAL
BROWN :	LIVE

As the colours of the wires in the mains lead of this apparatus may not correspond with the coloured markings identifying the terminals in your plug, proceed as follows:

The wire which is coloured GREEN and YELLOW must be connected to the terminal in the plug which is marked by the letter E or by the safety earth symbol  or coloured GREEN and YELLOW.

The wire which is coloured BLUE must be connected to the terminal which is marked with the letter N or coloured BLACK.

The wire which is coloured BROWN must be connected to the terminal which is marked with the letter L or coloured RED.

* This applies only to products distributed by YAMAHA KEMBLE MUSIC (U.K.) LTD.

Important

Read the following before operating the EMX620

Warnings

- Do not allow water to enter this unit or allow the unit to become wet. Fire or electrical shock may result.
- Connect this unit's power cord only to an AC outlet of the type stated in this Owner's Manual or as marked on the unit. Failure to do so is a fire and electrical shock hazard.
- Do not scratch, bend, twist, pull, or heat the power cord. A damaged power cord is a fire and electrical shock hazard.
- Do not place heavy objects, including this unit, on top of the power cord. A damaged power cord is a fire and electrical shock hazard. In particular, be careful not to place heavy objects on a power cord covered by a carpet.
- If you notice any abnormality, such as smoke, odor, or noise, or if a foreign object or liquid gets inside the unit, turn it off immediately. Remove the power cord from the AC outlet. Consult your dealer for repair. Using the unit in this condition is a fire and electrical shock hazard.
- Should this unit be dropped or the cabinet be damaged, turn the power switch off, remove the power plug from the AC outlet, and contact your dealer. If you continue using the unit without heeding this instruction, fire or electrical shock may result.
- If the power cord is damaged (i.e., cut or a bare wire is exposed), ask your dealer for a replacement. Using the unit with a damaged power cord is a fire and electrical shock hazard.
- Do not remove the unit's cover. You could receive an electrical shock. If you think internal inspection, maintenance, or repair is necessary, contact your dealer.
- Do not modify the unit. Doing so is a fire and electrical shock hazard.

Cautions

- Allow enough free space around the unit for normal ventilation. This should be: 30 cm at the sides, 30 cm behind, and 40 cm above.
These distances should also be adopted when rack-mounting the unit. For normal ventilation during use, remove the rear of the rack or open a ventilation hole.
If the airflow is not adequate, the unit will heat up inside and may cause a fire.
- This unit has ventilation holes at the front, rear and sides to prevent the internal temperature rising too high. Do not block them. Blocked ventilation holes are a fire hazard.
- Clean phone plugs before plugging them into the speaker jacks of this unit. Dirty contacts may generate heat.
- Use only designated speaker cables to connect speakers to the amplifier outputs. Using other types of cable is a fire hazard.
- Hold the power cord plug when disconnecting it from an AC outlet. Never pull the cord. A damaged power cord is a potential fire and electrical shock hazard.
- Do not touch the power plug with wet hands. Doing so is a potential electrical shock hazard.

Operating Notes

- Using a mobile telephone near this unit may induce noise. If noise occurs, use the telephone away from the unit.
- XLR-type connectors are wired as follows:
pin 1: ground, pin 2: hot (+), and pin 3: cold (-).
- Do not set all equalizer controls and faders to maximum. Doing so may cause oscillation depending on the condition of the connected unit and speakers, and may damage the speakers.
- The performance of components with moving contacts, such switches, rotary controls, faders, and connectors, deteriorates over time. The rate of deterioration depends on the operating environment and is unavoidable. Consult your dealer about replacing defective components.

Introduction

Thank you for purchasing the Yamaha EMX620 Powered Mixer. In order to take full advantage of the EMX620 and enjoy long and trouble-free operation, read this owner's manual carefully, and keep it in a safe place for future reference.

Features

- The EMX620's six input channels support a wide range of audio sources, including microphones, instruments, and line-level devices. Input channels 1 through 4 feature lo- and hi-impedance balanced inputs, with +15 V phantom powering for use with condenser-type microphones on the lo inputs, input channel 5 features two line-level inputs, while input channel 6 features two hi-impedance inputs for connecting instruments such as electric-acoustic guitar and electric bass directly.
- The built-in power amplifier offers a maximum output of 200 W with a 4 Ω speaker system, 135 W with an 8 Ω speaker system, and a limiter circuit prevents sounds distortion and speaker damage.
- The 7-band graphic equalizer on the main output allows you to tailor the sound for each particular venue and reduce the risk of feedback by attenuating troublesome frequencies.
- Also built-in is a digital effects processor, offering three different programs for adding reverberation or ambiance to vocal or instrument sounds, and remote on/off control using an optional footswitch.
- External effects can be patched into the system via the EFFECT OUT and AUX IN jacks, with effects return level control.
- Separate outputs are provided for connecting powered monitor speakers, headphones, or a stereo recorder (cassette, DAT, or MD).

Contents

Front & Rear Panels.....	6
Control Panel	6
Input/Output Panel	9
Rear Panel	11
Hookup Example.....	12
Basic Operation.....	13
Connecting Sources	13
Monitoring.....	13
Using the Built-in Effects.....	13
Troubleshooting.....	14
Specifications	15
General Specifications	15
Input Specifications	16
Output Specifications	16
Dimensions	16
Block & Level Diagrams.....	17

Front & Rear Panels

Control Panel

■ Channel Section

The channel controls are used to set the EQ, MONI and EFFECT send levels, channel LEVEL, and PAD for each channel.

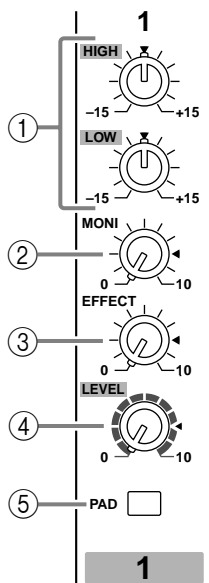

① HIGH & LOW EQ controls

The 2-band equalizer allows you to boost or cut the low or high frequency range for each channel. The frequency response is flat when the controls are in the center (▼) position. Rotating clockwise boosts frequencies, rotating counterclockwise cuts them.

The center frequencies are as follows:

HIGH: 10 kHz ±15 dB shelving type

LOW: 100 Hz ±15 dB shelving type

② MONI control

The MONI control determines the level of the input signal that is fed to the MONI bus and subsequently the MONITOR OUTPUT jack.

The MONI control is not affected by the channel's LEVEL control, since the MONI signal is sourced before that control.

③ EFFECT control

The EFFECT control determines the level of the input signal that is fed to the EFFECT bus and subsequently the onboard effects processor and EFFECT OUT jack.

EFFECT bus signals are fed simultaneously to the onboard effects processor and the EFFECT OUT jack for use with external effects processors.

The EFFECT control is affected by the channel's LEVEL control, since the EFFECT signal is sourced after that control. To send a channel signal to the EFFECT bus, both the EFFECT and LEVEL controls must be turned up.

④ LEVEL control

The LEVEL control determines the level of the input signal that is fed to the MAIN bus, MAIN output section, and internal power amplifier.

⑤ PAD switch (1–4 only)

The PAD switch attenuates the input signal by 30 dB. When connecting a line-level source to inputs 1 through 4, or if a microphone signal is distorted, use the PAD switch to attenuate the input signal.

■ DIGITAL EFFECT Section

The DIGITAL EFFECT section is used to turn the built-in digital effects processor on and off and select effects programs.

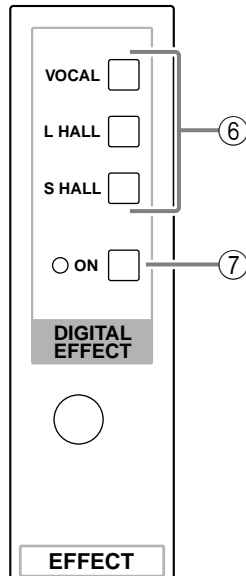

⑥ VOCAL, L. HALL, S. HALL switches

These switches are used to select the effects programs: VOCAL, L. HALL (large hall), S. HALL (small hall).

⑦ DIGITAL EFFECT ON switch & indicator

The DIGITAL EFFECT ON switch is used to turn the built-in digital effects processor on and off. The indicator lights up when the processor is on. When the processor is on, its output is fed to the MAIN and MONI buses via the MAIN EFFECT RTN and MONI EFFECT RTN controls respectively.

The effects processor can also be turned on and off remotely by connecting an optional foot-switch to the FOOT SW jack.

■ MAIN Section

The MAIN section is used to set the MAIN MASTER level, 7-band graphic equalizer, AUX IN and TAPE IN levels, and MAIN EFFECT RTN level. It also contains the LIMITER indicator and main output level meter.

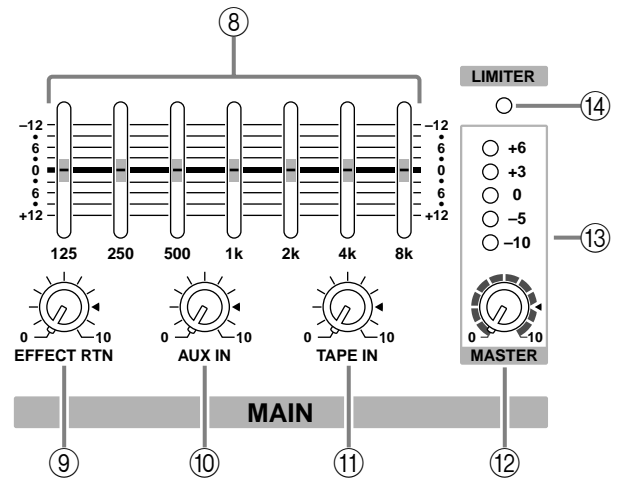

⑧ Graphic equalizer

The 7-band graphic equalizer is used to boost or cut certain frequencies of the MAIN output signal by up to ± 12 dB. It affects the MAIN OUTPUT signal, the speaker outputs, and the PHONES.

⑨ EFFECT RTN control

The MAIN EFFECT RTN control determines the level of the signal from the built-in digital effects processor that is fed to the MAIN bus and subsequently the MAIN outputs.

⑩ AUX IN control

The AUX IN control determines the level of the AUX IN signal that is fed to the MAIN bus and subsequently the MAIN outputs.

⑪ TAPE IN

The TAPE IN control determines the level of the TAPE IN signal that is fed to the MAIN bus and subsequently the MAIN outputs.

⑫ MASTER control

The MAIN MASTER control determines the output level of the MAIN OUT, speaker outputs, and PHONES.

⑬ Level meter

The 5-LED meter displays the level of the MAIN output signal.

⑭ LIMITER indicator

The LIMITER indicator lights up when the limiter circuit, which is designed to protect the internal power amplifier against excessive input signals and load mismatches, activates.

If the LIMITER indicator lights up, back off the MAIN MASTER level control, or the appropriate channel LEVEL control a little. If the indicator remains lit, make sure that the impedance of the connected speaker system is correct.

■ MONI Section

The MONI section is used to set the MONI MASTER level and MONI EFFECT RTN level.

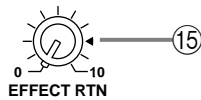
**MONI****⑮ EFFECT RTN**

The MONI EFFECT RTN control determines the level of the signal from the built-in digital effects processor that is fed to the MONI bus and subsequently the MONITOR OUTPUT.

⑯ MASTER control

The MONI MASTER control determines the output level of the MONITOR OUTPUT.

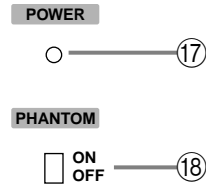
■ POWER Indicator, PHANTOM Switch & Indicator**⑰ POWER indicator**

The POWER indicator lights up when the EMX620 is powered up ready for use.

⑱ PHANTOM switch

The PHANTOM switch is used to turn on and off the +15 V phantom power for the Lo-Z XLR-type inputs on input channels 1 through 4.

Input/Output Panel

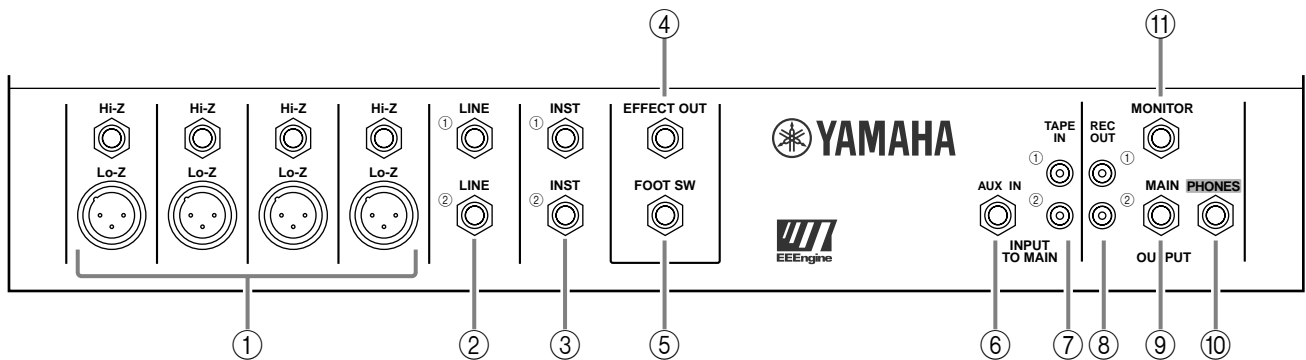

① Hi-Z, Lo-Z (inputs 1–4)

These are the input connectors for input channels 1 through 4. Both the Hi-Z and Lo-Z input can be used with microphones and, by using the PAD switch, can also be used with line-level sources, such as synthesizers and drum machines. Switchable +15 V phantom power is available to the Lo-Z XLR-type input for use with condenser-type microphones.

Both the Hi-Z and Lo-Z inputs are balanced.

Pin connections are as follows.

Lo-Z (XLR-type)	Hi-Z (TRS phone jack)
Pin 1: ground	Sleeve: ground
Pin 2: hot (+)	Ring: cold (-)
Pin 3: cold (-)	Tip: hot (+)

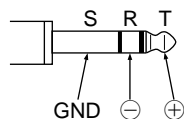

Note: The Lo-Z and Hi-Z input of each channel cannot be used simultaneously. Use the input appropriate for the source.

Note: Since phantom power is turned on and off for inputs channels 1 through 4 simultaneously, input devices that do not require it should be connected to the Hi-Z input when phantom power is used.

② LINE 1 & 2 (input 5)

These two phone jacks are the input connectors for input channel 5. They are unbalanced, can be used simultaneously, and are appropriate for use with line-level sources, such as synthesizers and drum machines.

③ INST 1 & 2 (input 6)

These two phone jacks are the input connectors for input channel 6. They are unbalanced, can be used simultaneously, and their high input impedance makes them ideal for use with instruments such as electric-acoustic guitar and electric bass. They can also be used with line-level sources, such as synthesizers and drum machines.

④ EFFECT OUT jack

The EFFECT OUT phone jack outputs the signal from the EFFECT bus and can be connected to the input of an external effects processor.

⑤ FOOT SW jack

The FOOT SW jack is used to connect an optional footswitch, such as the Yamaha FC5, which can be used to turn the built-in digital effects processor on and off. The DIGITAL EFFECT ON switch must be in the ON position in order to use the footswitch.

⑥ AUX IN—INPUT TO MAIN jack

The AUX IN—INPUT TO MAIN phone jack is used to feed signals from an external source to the MAIN bus and can be connected to the output of an external effects processor, for example.

⑦ TAPE IN—INPUT TO MAIN jacks

The TAPE IN—INPUT TO MAIN phono jacks are used to feed signals from an external source to the MAIN bus and can be connected to the stereo outputs of a cassette, DAT, or MD deck.

⑧ REC OUT—OUTPUT jacks

The REC OUT—OUTPUT phono jacks output the MAIN bus signal prior to the 7-band graphic equalizer and MASTER level control, and can be connected to the stereo inputs of a cassette, DAT, or MD deck for recording.

⑨ MAIN—OUTPUT jack

The MAIN—OUTPUT jack outputs the MAIN bus signal after the 7-band graphic equalizer and MASTER level control, and can be connected to the input of a larger mixer, or a more powerful amplifier, for example.

⑩ PHONES—OUTPUT jack

The PHONES—OUTPUT jack outputs the MAIN bus signal after the 7-band graphic equalizer and MASTER level control, and can be connected to a pair of stereo headphones for personal monitoring.

⑪ MONITOR—OUTPUT

The MONITOR—OUTPUT phone jack outputs the MONI bus signal after the MONI MASTER control, and can be connected to the input of a powered monitor speaker.

Rear Panel

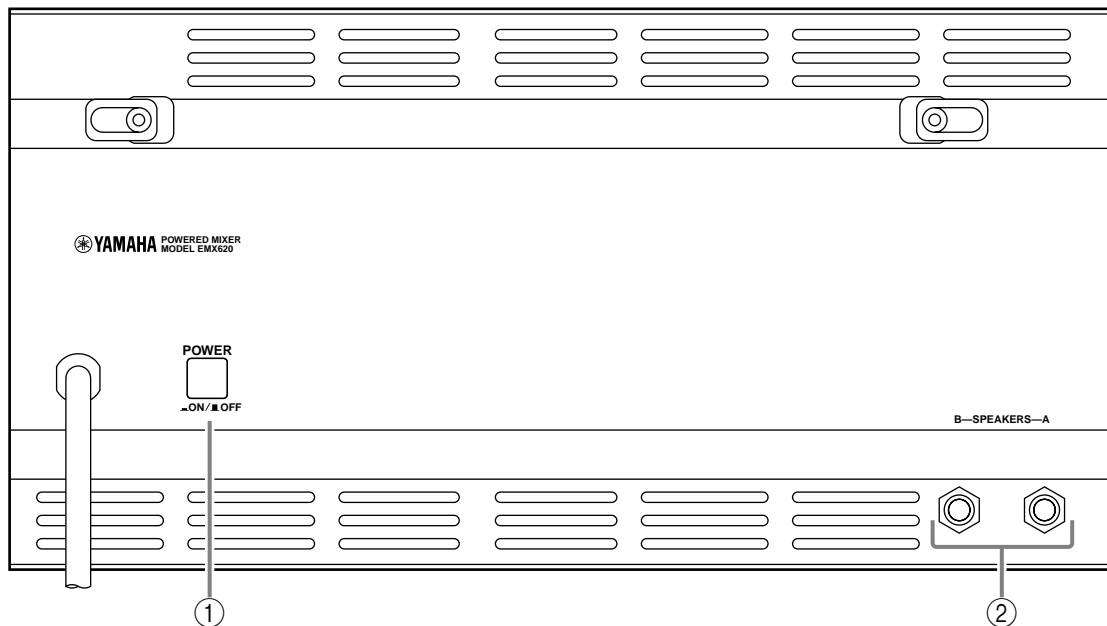

① POWER switch

The POWER switch is used to turn on and off the power to the EMX620.

Note: Before turning on or off the EMX620, it's a good idea to turn down the MAIN MASTER and MONI MASTER controls.

② SPEAKERS A & B jacks

The SPEAKER A & B phone jacks output the main signal from the internal power amplifier and are used to connect speakers. They are internally connected in parallel and output the same signal. The total impedance of the connected speaker system must be between 4 and 8 ohms. This means that you can connect one speaker system with an impedance of between 4 and 8 ohms to one SPEAKER jack, or two speaker systems each with an impedance of between 8 and 16 ohms to each SPEAKER jack, as shown below.

Connecting one speaker

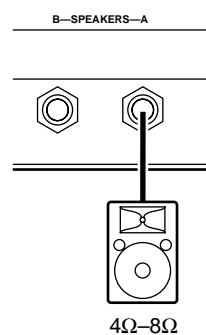

Connecting two speakers

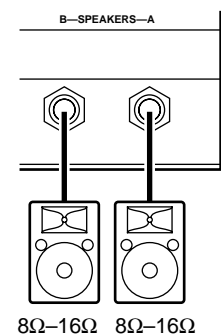

Note: Do not connect anything other than speakers to these jacks.

Hookup Example

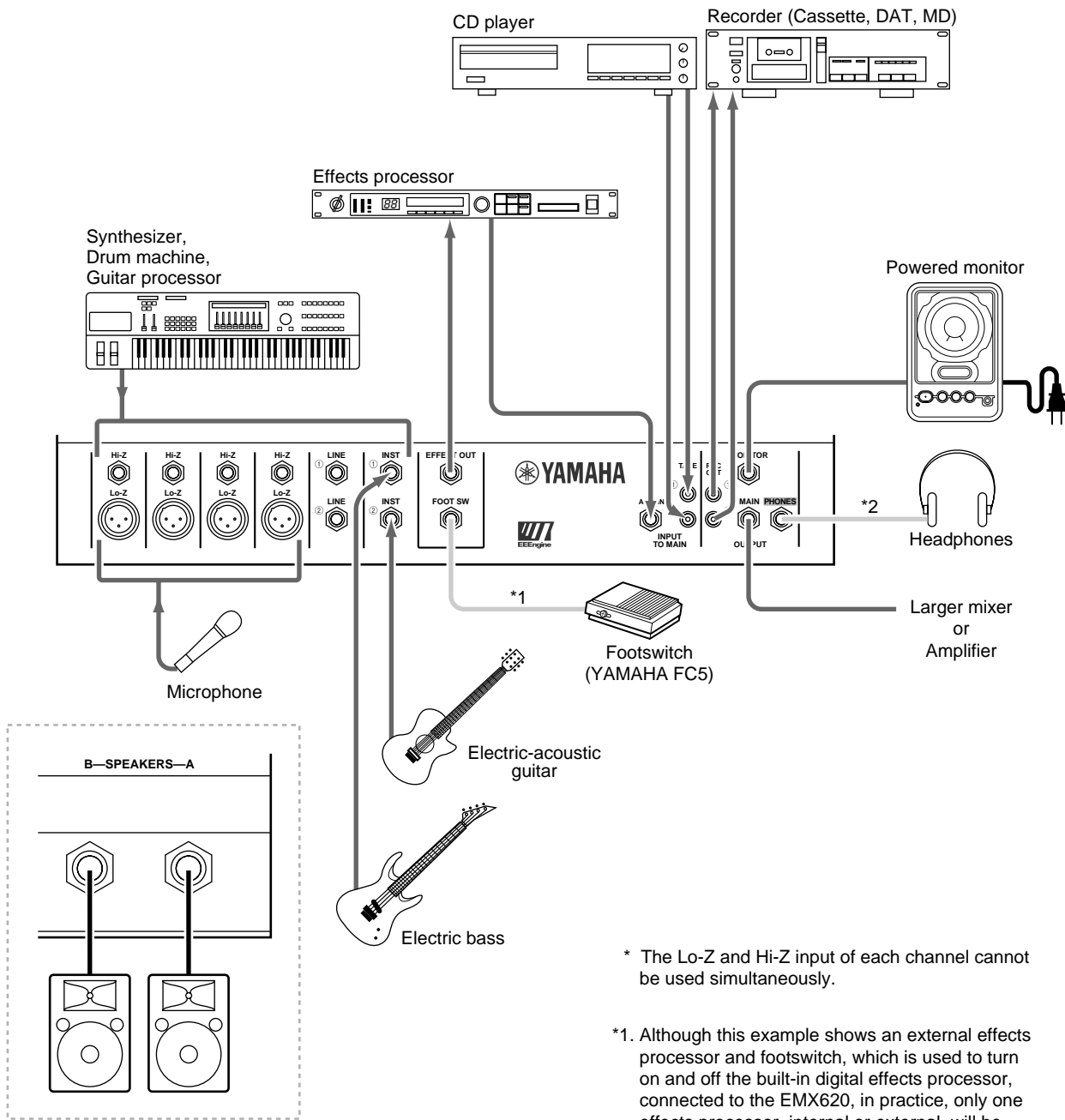

* The Lo-Z and Hi-Z input of each channel cannot be used simultaneously.

*1. Although this example shows an external effects processor and footswitch, which is used to turn on and off the built-in digital effects processor, connected to the EMX620, in practice, only one effects processor, internal or external, will be used at a time, so the footswitch is not required when using external effects.

*2. This example shows both headphones and a powered monitor being used for monitoring. In practice, however only one method is required.

Basic Operation

Connecting Sources

Before connecting any microphones or instruments, make sure that the EMX620 and any other applicable equipment is turned off. Also make sure that the LEVEL control on each EMX620 input channel, and the MAIN MASTER and MONI MASTER controls are turned down.

- ① **Connect cables to your mics and instruments, and insert the other end of the cables firmly into the appropriate Lo-Z or Hi-Z jack (channels 1–4), LINE jack (channel 5), or INST jack (channel 6).**

Note: When connecting line-level sources to input channels 1 through 4, turn on the corresponding PAD switch.

Note: The Lo-Z and Hi-Z jacks on input channels 1 through 4 cannot be used simultaneously.

- ② **Turn on the power, starting with the sound sources and finishing with the EMX620.**
Reverse this order when turning off the power.
- ③ **Set the MAIN MASTER control to the ◀ position.**
- ④ **While speaking into a connected mic, or playing a connected instrument, adjust the input channel LEVEL control so that the 0 LED of the MAIN section level meter lights occasionally.**
Repeat this procedure for each channel.
- ⑤ **Use the EQ controls on each input channel to adjust the tonal characteristics of each source.**
- ⑥ **Use the 7-band graphic equalizer to adjust the tonal characteristics of the main output.**
- ⑦ **Use the MAIN MASTER control to set the overall volume level of the main mix.**

Monitoring

By connecting a powered monitor speaker to the MONITOR OUTPUT, you can create a monitor mix independent of the MAIN mix, since the input channel MONI controls are not affected by the LEVEL controls.

- ① **Set the MONI MASTER control to the ◀ position.**
- ② **While speaking into a connected mic, or playing a connected instrument, adjust the MONI control of the input channel that you want to monitor.**
Repeat this procedure for each channel.
- ③ **Use the MONI MASTER control to set the overall level of the monitor mix.**

Using the Built-in Effects

The EMX620 features a built-in digital effects processor, allowing reverberation or ambiance to be added to vocals or instrument sounds.

- ① **Turn on the digital effects processor by pressing the DIGITAL EFFECT ON switch.**
The DIGITAL EFFECT indicator lights up.
- ② **Use the DIGITAL EFFECT switches to select an effects program.**
VOCAL Reverb suitable for vocals.
L. HALL..... Reverb typical of a large hall.
S. HALL..... Reverb typical of a small hall.
- ③ **Set the MAIN EFFECT RTN control to the ◀ position.**
- ④ **While speaking into a connected mic, or playing a connected instrument, adjust the EFFECT control of the input channel that you want to process.**
- ⑤ **Use the MAIN EFFECT RTN control to adjust the overall level of the processed sound.**
- ⑥ **Use the MONI EFFECT RTN control to feed the processed signal to the MONI bus and subsequently MONITOR OUTPUT.**

Note: If the processed sound is distorted even with an EFFECT RTN control turned down, turn down the EFFECT control on each channel.

Troubleshooting

The following table describes the possible malfunctions of this device, and the appropriate actions to be taken in each case.

Problem		Cause	Action
Sound is no longer output from the speakers.	The POWER indicator is lit.	The load on the amplifier of this device was too great, and the protection circuit for the amplifier has operated. Possible reasons for the excessive load are an excessive level setting in the channel control section or main section, insufficient ventilation, or insufficient load impedance of the connected speakers.	<p>Please wait. When the device cools off, normal operation will resume automatically. However, please check the following three points to prevent the problem from recurring.</p> <p>If the level setting is excessive, lower it to the nominal level. You can refer to the peak level indicators of the main section when doing so.</p> <p>If the device is not ventilated sufficiently, refer to the cautions given at the beginning of this manual and take appropriate measures to insure adequate ventilation.</p> <p>If the load impedance (including a short) is too low, refer to the chapter on rear panel (page 11) and change the connections so that the impedance is correct.</p>
	Other	Connections between devices have come loose.	Inspect the connections, and correct any faulty connections.
		Other	The device may have malfunctioned. Please contact your dealer.

Specifications

■ General Specifications

Maximum output power	135 W/8Ω @0.5% THD at 1 kHz (SPEAKERS OUT) 200 W/4Ω @0.5% THD at 1 kHz (SPEAKERS OUT) 175 mW/40Ω @0.5% THD at 1 kHz (PHONES OUT)	
Frequency response	20 Hz–20 kHz +1 dB, –3 dB @ 1 W output into 8Ω (SPEAKERS OUT) 20 Hz–20 kHz +1 dB, –3 dB @+4 dB output into 10 kΩ (MAIN OUT, MONITOR OUT, EFFECT OUT)	
Total harmonic distortion	Less than 0.5% @20 Hz–20 kHz, 100 W output into 4Ω (SPEAKERS OUT) Less than 0.3% @20 Hz–20 kHz, +14 dB output into 10 kΩ (MAIN OUT, MONITOR OUT, EFFECT OUT)	
Hum & noise (Average, Rs=150Ω) (with 20 Hz–20 kHz BPF)	–124 dB equivalent input noise, –68 dB residual output noise (SPEAKERS OUT)	
	–88 dB residual output noise (MAIN OUT, MONITOR OUT)	
	–79dB (83 dB S/N) (MAIN OUT, MONITOR OUT)	Master level control: nominal level Channel level controls: minimum
	–69 dB (73 dB S/N) (MAIN OUT, MONITOR OUT)	Master level control: nominal level 1 channel level control: nominal level
	–75 dB (79 dB S/N) (EFFECT OUT)	All channel level controls: minimum
Maximum voltage gain (PAD: OFF)	–69 dB (73 dB S/N) (EFFECT OUT)	
	1 channel level control: nominal level	
	86 dB CH IN (Lo-Z) to SPEAKERS OUT (CH1–4) 66 dB CH IN (Lo-Z) to MAIN OUT, MONITOR OUT (CH1–4) 66 dB CH IN (Lo-Z) to EFFECT OUT (CH1–4) 48 dB CH IN (Lo-Z) to REC OUT (CH1–4) 56 dB CH IN (Hi-Z) to MAIN OUT, MONITOR OUT (CH1–4) 26 dB LINE IN to MAIN OUT 26 dB AUX IN to MAIN OUT 22 dB TAPE IN to MAIN OUT 46 dB INST IN to MAIN OUT	
	Crosstalk at 1 kHz	
	–65 dB adjacent input, –65 dB input to output	
Input channel equalization	±15 dB Maximum HIGH 10 kHz shelving * LOW 100 Hz shelving * * Turn over/roll-off frequency of shelving: 3 dB below maximum variable level.	
Meters	5 points LED Meter (–10, –5, 0, +3, +6 dB) MAIN OUT	
Graphic equalizer	7 bands (125, 250, 500, 1k, 2k, 4k, 8k Hz) MAIN OUT ±12 dB Maximum	
Internal digital effect	3 types (Vocal, L Hall, S Hall)	
Phantom power	+15 V is supplied to electrically balanced inputs for powering condenser microphones via 2.4 kΩ current limiting/isolation resistors.	
Limiter	Comp. : THD≥0.5% (SPEAKERS)	
LIMIT indicator	Turn on. : THD≥0.5% (SPEAKERS)	
Protection circuit (Power amp)	POWER switch on/off mute DC detection Temp (Heatsink Temp≥90°C)	
Foot switch	DIGITAL EFFECT MUTE : on/off	
Power requirement	USA and Canada: 120 V AC 60 Hz Europe: 230 V AC 50 Hz Other: 240 V AC 50 Hz	
Power consumption	110 W	
Dimensions (WxHxD)	497×275×275 mm	
Weight	13 kg	

For European Model

Purchaser/User Information specified in EN55103-1 and EN55103-2.

Inrush Current: 23A

Conformed Environment: E1, E2, E3 and E4

Input Specifications

Input connectors	PAD	Actual load impedance	Nominal impedance	Input level			Connector type
				Sensitivity* ¹	Nominal level	Max. before clipping	
CH INPUT (Lo-Z) (CH1-4)	OFF	3 kΩ	50-600Ω Mics	-62 dB (0.616 mV)	-50 dB (2.45 mV)	-20 dB (77.5 mV)	XLR-3-31 type ²
	ON		600Ω Lines	-32 dB (19.5 mV)	-20 dB (77.5 mV)	+10 dB (2.45 V)	
CH INPUT (Hi-Z) (CH1-4)	OFF	10 kΩ	50-600Ω Mics	-52 dB (1.95 mV)	-40 dB (7.75 mV)	-10 dB (245 mV)	Phone jack (TRS) ²
	ON		600Ω Lines	-22 dB (61.6 mV)	-10 dB (245 mV)	+20 dB (7.75 V)	
LINE IN (CH5) (1-2)		10 kΩ	600Ω Line	-22 dB (61.6 mV)	-10 dB (245 mV)	+20 dB (7.75 V)	Phone jack ³
INST IN (CH6) (1-2)		470 kΩ	1kΩ	-42 dB (6.16 mV)	-30 dB (24.5 mV)	0 dB (0.775 V)	Phone jack ³
AUX IN		10 kΩ	600Ω Line	-22 dB (61.6 mV)	-10 dB (245 mV)	+20 dB (7.75 V)	Phone jack ³
TAPE IN (1-2)		10 kΩ	600Ω Line	-22 dBV (79.4 mV)	-10 dBV (316 mV)	+17.8 dBV (7.76 V)	Phono jack

*1. Sensitivity is the lowest level that can produce an output of +4 dB (1.23 V) or the nominal output level when the unit is set at maximum gain.

(All level controls are at maximum position.)

*2. Balanced. (T= HOT, R= COLD, S= GND)

*3. Unbalanced.

- 0 dB= 0.775 Vrms, 0 dBV= 1 Vrms.

Output Specifications

Output connectors	Actual source impedance	Nominal impedance	Output level		Connector type
			Nominal	Max. before clipping	
SPEAKERS OUT (A, B)	0.1Ω	4/8Ω Speaker	37.7 W/4Ω	200 W/4Ω	Phone jack
MAIN OUT	600Ω	10 kΩ Lines	+4 dB (1.23 V)	+20 dB (7.75 V)	Phone jack
MONITOR OUT	600Ω	10 kΩ Lines	+4 dB (1.23 V)	+20 dB (7.75 V)	Phone jack
EFFECT OUT	600Ω	10 kΩ Lines	+4 dB (1.23 V)	+20 dB (7.75 V)	Phone jack
PHONES OUT	35Ω	40 Ω Phones	33 mW	175 mW	Phone jack
REC OUT (1, 2)	600Ω	10 kΩ Lines	-10 dBV (316 mV)	+10 dBV (3.16 V)	Phono jack

- PHONE JACKS are unbalanced.
- 0 dB= 0.775 Vrms, 0 dBV= 1 Vrms.

Dimensions

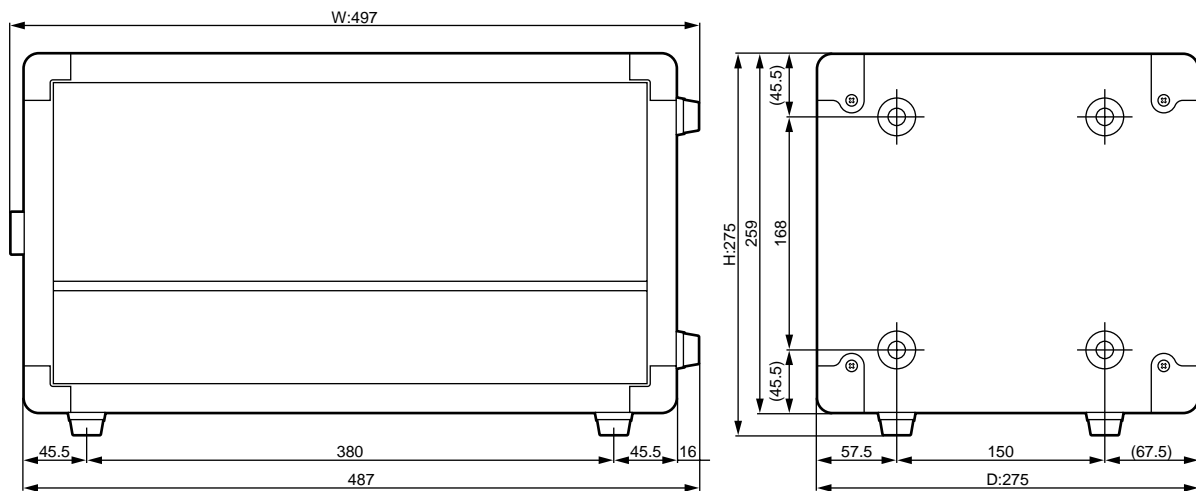

Unit: mm

Specifications are subject to change without prior notice.

