



HOME THEATER SOUND SYSTEM

# TSS-1



**OWNER'S MANUAL  
MODE D'EMPLOI  
BEDIENUNGSANLEITUNG  
BRUKSANVISNING  
MANUALE DI ISTRUZIONI  
MANUAL DE INSTRUCCIONES  
GEBRUIKSAANWIJZING**

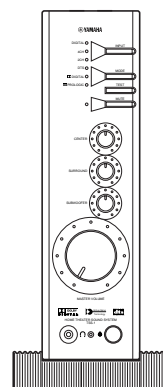
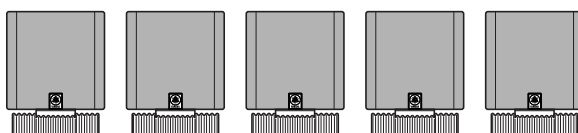
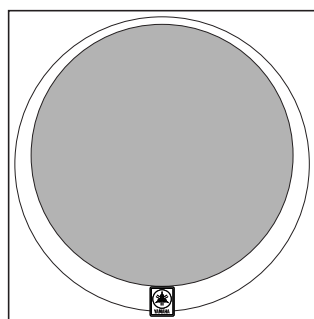

1

A

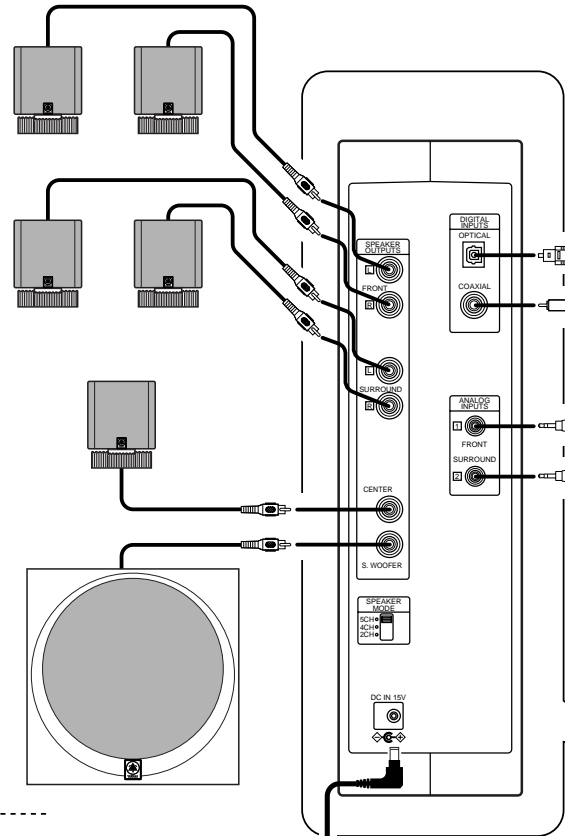

B

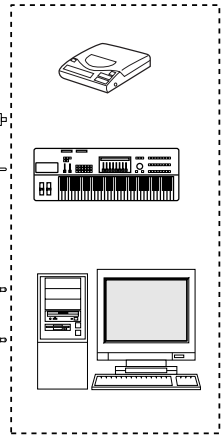

To AC receptacle  
Vers une prise du réceptacle CA  
In die Netzsteckdose  
Till ett eluttag  
Alla presa CA  
A la tomacorriente de CA  
Naar netaansluiting

PA-SR601:  
AC adaptor  
Adaptateur CA  
Netzteil  
Nätadapter  
Trasformatore CA  
Adaptador de CA  
Netadapter

Rear panel  
Panneau arrière  
Rückseite  
Bakpanel  
Pannello posteriore  
Panel trasero  
Achterpaneel

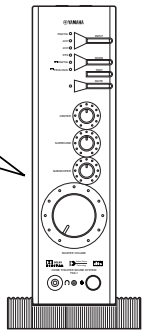

Amplifier unit  
Amplifier unit  
Amplifier unit  
Amplifier unit  
Amplifier unit  
Amplifier unit

2

Front panel  
Front panel  
Front panel  
Front panel  
Front panel  
Front panel  
Front panel

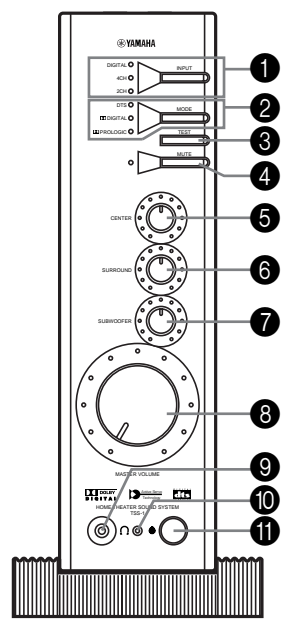

12  
13  
14

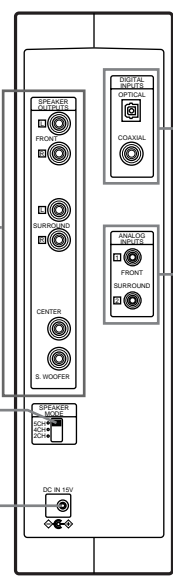

Rear panel  
Panneau arrière  
Rückseite  
Bakpanel  
Pannello posteriore  
Panel trasero  
Achterpaneel

## Cautions

Please read the following operating precautions before use. YAMAHA will not be held responsible for any damage and/or injury caused by not following the cautions below.

- When you disconnect the AC adaptor from the AC receptacle, hold the plug itself and not the cord.
- If you plan not to use this system for a while, disconnect the AC adaptor from the AC receptacle.
- Always disconnect the AC adaptor from the AC receptacle before making any connections.
- This system does not contain any user serviceable parts. Refer all servicing to your Yamaha dealer.
- **Never open the cabinet.** If a foreign object drops into the set, contact your dealer and stop using this system. Otherwise, you may cause a fire.
- Do not expose this system to extreme temperatures, direct sunlight, excessive dust, humidity, or vibration.
- Position this system on a level, stable surface. Do not drop, apply excessive force to their controls, or put heavy items on top of them.
- Do not place small metallic objects on this system. Otherwise, the object may fall, possibly causing an injury.
- Since the amplifier unit has a built-in power amplifier, heat will radiate from the ventilation slits. Place the amplifier unit apart from the walls, allowing a space of at least 20 cm (7-7/8") above, 10 cm (3-15/16") behind and on both sides of the amplifier unit.  
Also, do not position with the rear panel facing down on the floor or other surfaces and do not cover the amplifier unit with a newspaper, a tablecloth, a curtain, etc. in order not to obstruct heat radiation.  
If the temperature inside the amplifier unit rises, it may cause fire, damage to the amplifier unit and/or personal injury.
- Do not place the following objects on this system:
  - If glass etc. falls by vibrations and breaks, it may cause personal injury.
  - A burning candle etc.  
If the candle falls by vibrations, it may cause fire and personal injury.
  - A vessel with water in it  
If the vessel falls by vibrations and water spills, it may cause damage to this system, and/or you may get an electric shock.
- To protect this system, avoid microphone feedback, continuous and excessive output from electronic musical instruments, and excessive signal distortion.
- If this system is located close to a monitor, or fluorescent or neon lights, a slight hum may be heard. In this case, relocate this system away from the light.
- Although this system is magnetically shielded, keep floppy disks and tapes away from it.
- Avoid sources of hum (transformers, motors). To prevent fire or electrical shock, do not expose to rain or water.
- Do not use force on switches, knobs, or cables. When you move this system, first turn off the power, then disconnect the AC adaptor from the AC receptacle and the cables from the connected devices.
- Always set the MASTER VOLUME control fully to the left before starting to play the audio source: turn the control gradually after the play has started.
- **Be sure to use the AC adaptor (PA-SR601) supplied with this system. Otherwise, you might cause a fire or damage to this system.**

### Standby mode

When this system is turned off by pressing the power switch, this system consumes a small amount of power. This state is called the standby mode. The power supply is completely cut off from the AC line only when the AC adaptor is disconnected.

This system features a magnetically shielded design, but there is still a chance that placing it too close to a TV or a computer monitor might impair picture color. Should this happen, move this system away from the TV or the computer monitor.

### For U.K. customers

If the socket outlets in the home are not suitable for the plug supplied with this appliance, it should be cut off and an appropriate 3 pin plug fitted. For details, refer to the instructions described below.

**Note:** The plug severed from the mains lead must be destroyed, as a plug with bared flexible cord is hazardous if engaged in a live socket outlet.

### SPECIAL INSTRUCTIONS FOR U.K. MODEL

#### IMPORTANT:

THE WIRES IN MAINS LEAD ARE COLOURED IN ACCORDANCE WITH THE FOLLOWING CODE:

Blue: NEUTRAL

Brown: LIVE

As the colours of the wires in the mains lead of this apparatus may not correspond with the coloured markings identifying the terminals in your plug, proceed as follows: The wire which is coloured BLUE must be connected to the terminal which is marked with the letter N or coloured BLACK. The wire which is coloured BROWN must be connected to the terminal which is marked with the letter L or coloured RED. Making sure that neither core is connected to the earth terminal of the three pin plug.

# Contents

---

<b>Cautions</b> .....	1	<b>Controls &amp; connectors</b> .....	6
<b>Unpacking</b> .....	2	<b>Adjusting speaker balance</b> .....	8
<b>Features</b> .....	2	<b>Playing a source</b> .....	8
<b>Setting up the speakers</b> .....	4	<b>Troubleshooting</b> .....	9
<b>Connections</b> .....	6	<b>Specifications</b> .....	10

## Unpacking

After unpacking, check that the following parts are contained.

- **Amplifier unit**
- **Satellite speaker x 5**
  - Satellite speaker with a 3 m cord x 3
  - Satellite speaker with a 7 m cord x 2
- **Subwoofer**
- **Accessories**
  - Mini plug cable x 2
  - Optical fiber cable x 1
  - Coaxial cable x 1
  - Stand for the amplifier unit x 1
  - Screw x 2
  - Pad x 16
  - Fastener x 1

## Features

### **Multi-Channel Surround System for Home Theater, Game Amusement and PC DVD.**

- **Combination of Amplifier Unit, Five Satellite Speakers and Subwoofer**
- **Dolby Digital and DTS decoder**  
(Refer to the next page.)
- **5.1-Channel Full-Scale System for DVD Movie Entertainment**
- **5.1-Ch Full-Scale, 4.1-Ch (Game Surround) and Stereo (Virtual Surround) Speaker Modes**
- **Yamaha's Exclusive Active Servo Technology for Powerfull Bass Response**
- **1 Optical and 1 Coaxial Digital Input Terminals**
- **Two Analog Input Terminals (front/rear channel)**
- **Test Tone Generator for Accurate Speaker Settings**

## Welcome to the exciting world of digital home entertainment.

The TSS-1 is a compact, but complete and advanced home theater sound system that takes you to the exciting world of digital surround sound entertainment. Though some of the advanced features of this system may not be familiar to you, they are easy to use. Incorporated state-of-art technology such as Dolby Digital and DTS can bring the same audio experience to your home as they have brought to feature films in quality theaters around the world. Take some time now to read more about these features and enjoy the new experiences this system brings to your home theater.

### ■ Dolby Surround

Dolby Surround uses four discrete channels and five speakers to reproduce realistic and dynamic sound effects: two main channels (left and right), a center channel for dialog, and a rear channel for special sound effects. The rear channel reproduces sound within a narrow frequency range.

Most video tapes and laser discs include Dolby Surround encoding, as do many TV and cable broadcasts. The Dolby Pro Logic decoder built into this unit employs a digital signal processing system that stabilizes each channel for even more accurate sound positioning than is available with standard analog processors.

### ■ Dolby Digital \*

Dolby Digital is a digital surround sound system that provides completely independent multi-channel audio to you. Dolby Digital provides five full-range channels in what is sometimes referred to as a "3/2" configuration: three front channels (left, center and right), and two surround channels. A sixth bass-only effect channel is also provided for output of LFE (low frequency effect), or low bass effects that are independent of other channels. (This is called the "LFE channel".) This channel is counted as 0.1, thus giving rise to the term 5.1 channels in total.

The wide dynamic range of sound reproduced by the five full-range channels and precise sound orientation by digital sound processing provides listeners with excitement and realism that have never been experienced before.

### ■ DTS (Digital Theater System) Digital Surround \*\*

DTS was developed to replace the analog soundtracks of movies with six discrete channels of digital soundtracks, and it is now installed in many theaters around the world. The DTS digital playback system changed the way we experienced movies in theaters with six discrete channels of superb digital audio.

DTS technology, through intense research and development has made it possible to deliver similar encode/decode discrete technology to home audio surround-sound entertainment.

DTS Digital Surround is an encode/decode system which delivers six channels of master-quality, 20-bit audio; technically, it is 5.1 channels, which means 5 full-range (left, center, right and two surround) channels, plus a subwoofer (LFE) channel (as "0.1"). It is compatible with the 5.1 speaker configurations that are currently available for home theater systems.

#### Notes

- When playing an ordinary CD on this system following playback of a CD or an LD encoded with DTS, some operations, such as resetting input modes, may be required.
- Even if connected to this system with a digital connection, some CD, LD, and DVD players may make this system fail to decode DTS or produce noise. This is because certain digital output data processing by such a player results in DTS-encoded data errors that cause playback failure although the same data processing may cause only a slight change in volume or in frequency response in normal digital sound.
- When an error occurs in the player's digital output data during playback of an LD or CD encoded with DTS, playback may be disrupted. If this occurs, stop playback and repower the player.
- When digital sound signals from the computer are played, errors in WAVE signals, etc. may occur resulting in noise or a playback failure.



Manufactured under license from Dolby Laboratories. "Dolby", "Pro Logic" and the double-D symbol are trademarks of Dolby Laboratories. Confidential Unpublished Works. ©1992–1997 Dolby Laboratories, Inc. All rights reserved.



Manufactured under license from Digital Theater Systems, Inc. US Pat. No. 5,451,942 and other worldwide patents issued and pending. "DTS", "DTS Digital Surround", are trademarks of Digital Theater Systems, Inc. Copyright 1996 Digital Theater Systems, Inc. All Rights Reserved.

## Setting up the system

### System configuration

This system includes an amplifier unit, five satellite speakers and a subwoofer.

The three satellite speakers with a 3 m cord are used for front speakers and a center speaker.

The two satellite speakers with a 7 m cord are used for surround speakers.

### The roll of respective speakers

The front speakers are used for outputting main channel sound. The surround speakers are used for effect sounds, and the center speaker is for center channel sound (dialog etc.).

The subwoofer is used for outputting sounds of low frequencies from the front, center and surround channels.

The subwoofer also outputs sounds of the subwoofer channel when a source is played with DTS or Dolby Digital decoded.

### Recommended speaker placement

Before making connections, place all speakers in their respective positions. The positioning of the speakers is important because it controls the whole sound quality of this system.

Place the speakers depending on your listening position by following the instructions below.

\* The satellite speakers can be mounted on a wall.

**Front speakers:** On both sides of and at approximately the same height as the TV (or computer monitor).

**Surround speakers:** Behind your listening position or on both sides of the listening room.

**Center speaker:** Precisely between the front speakers.  
\* Though the center speaker can be mounted on the monitor as shown on the next page, it is not so recommended for safety.

**Subwoofer:** On the floor. The position of the subwoofer is not so critical because low bass tones are not highly directional. It is recommended to place the subwoofer obliquely facing the wall.

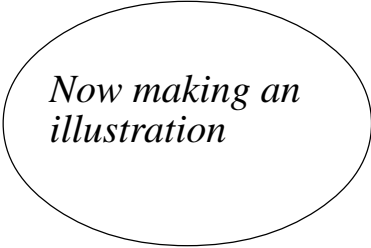

*Now making an  
illustration*

## ■ Adjusting the front angle of the satellite speakers

The front angle of the satellite speakers can be adjusted as shown below.

- 1 Loosen the screw on the bottom of the speaker stand.
  - \* Put the supplied nonskid pads at the four corners on the bottom of the stand to obtain more stability.

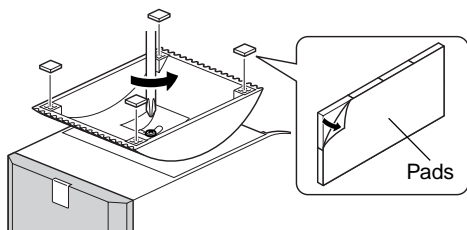

- 2 Slide the speaker on the stand as you prefer, and then tighten the screw.

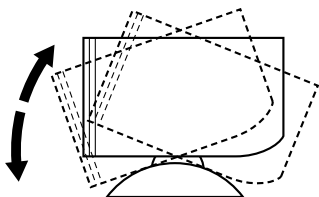

## ■ Mounting satellite speakers on a wall

The satellite speakers can also be hung on the wall.

Fasten screws into a firm wall or wall support as shown in the figure, and hang the slits on the rear of the speaker on the protruding screws.

- \* Make sure that the screws are securely caught by the slits.

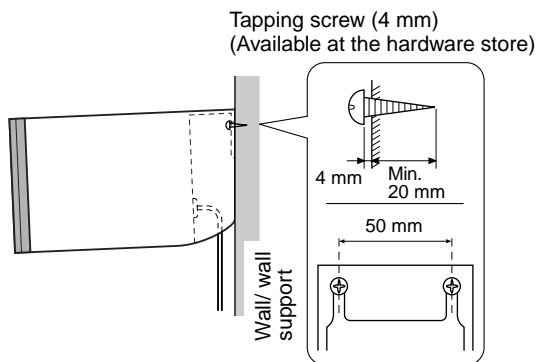

### Warning

- Each speaker weighs 0.4 kg (0.9 lbs.). Do not mount them on thin plywood or a wall with soft surface material. If mounted, the screws may come out of the flimsy surface and the speakers may fall. This damages the speakers or causes personal injury.
- Do not install the speakers to a wall with nails, adhesives, or any other unstable hardware. Long-term use and vibrations may cause them to fall.
- To avoid accidents resulting from tripping over loose speaker cords, fix them to the wall.

## ■ Mounting a center speaker on top of the monitor

When placing the center speaker on top of the monitor, remove the stand from the speaker, and put the provided fastener at the bottom of the speaker and on top of the monitor to prevent the speaker from falling.

- \* Do not mount the speaker on top of the monitor with an inclination to a level surface of more than 10 degrees.

*Now making an illustration*

### Note

Though this speaker is a magnetically shielded type, there may be some influence on a monitor picture depending on the type of monitor or the placement of the speaker. In such a case, place the speaker apart from the monitor so that there is no influence on the monitor picture.

## ■ Mounting the amplifier unit on the supplied stand

To obtain stability, it is recommended to mount the amplifier unit to the supplied stand with the supplied screws as shown below.

- \* Put the supplied nonskid pads at the four corners on the bottom of the stand to obtain more stability.

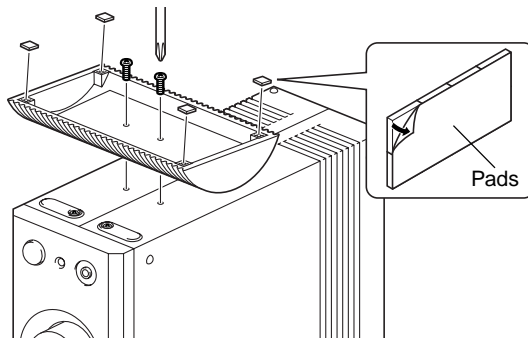

# Connections

(See figure 1 on inside of the front cover.)

**Caution: Plug in the amplifier unit and other equipment after all connections are completed.**

- A**: Connect three satellite speakers with a 3 m cord to the **FRONT L, R** and **CENTER** terminals. Connect two satellite speakers with a 7 m cord to the **SURROUND L** and **R** terminals. Connect the subwoofer to the **SUBWOOFER** terminal.
- B**: Connect external audio/video units (a personal computer, a video game player, a portable DVD/CD player, a video cassette player, etc. which send playback signals to this system) to these terminals.

## Cautions

- When placing the provided AC adapter on the desk, etc., be sure to fix the adapter on the desk, etc. to prevent it from falling. If the adapter falls, it may cause personal injury or damage to the adapter and/or other equipment.
- The **SPEAKER OUTPUT** terminals on the rear of the amplifier unit are special for connecting with the supplied speakers. Never connect these terminals to an AV amplifier or a power amplifier, otherwise it may cause not only a misoperation of this system, but also damage to this system.

# Controls & connectors

(See figure 2 on inside of the front cover.)

## 1 INPUT selector button and indicators

Press this button repeatedly to select an input mode between **DIGITAL**, **4CH** and **2CH**. The current mode is shown by the lighting of the corresponding indicator.

### DIGITAL:

Select this mode to reproduce signals received at the **OPTICAL** or the **COAXIAL** terminal on the rear panel. When both **OPTICAL** and **COAXIAL** terminals receive signals, the signals at the **OPTICAL** terminal are selected.

### 4CH:

Select this mode to reproduce signals received at the **FRONT** and **SURROUND** terminals on the rear panel in a 4 channel surround sound mode. (The center speaker is not used in this mode.)

### 2CH:

Select this mode to reproduce signals received at the **FRONT** terminals on the rear panel in a 2-channel stereo mode.

## 2 MODE selector button and indicators

Press this button repeatedly to select the desired surround mode between **DTS**, **DIGITAL**, **PROLOGIC** and **off**. The current mode is shown by the lighting of the corresponding indicator. When no mode is selected, no indicator lights up.

### DTS:

Select this mode to reproduce an input source with DTS decoded.

This mode can be selected only when the input signal is encoded with DTS and the input mode is set to **DIGITAL**.

### DIGITAL:

Select this mode to reproduce an input source with Dolby Digital decoded.

This mode can be selected only when the input signal is encoded with Dolby Digital and the input mode is set to **DIGITAL**.

### PROLOGIC:

Select this mode to reproduce an input source with Dolby Prologic decoded.

This mode can be selected only when input signal is encoded with Dolby Prologic. This mode cannot be selected when the input mode is set to **4CH**.

\* If a signal encoded with DTS or Dolby Digital is inputted with no surround mode selected, the corresponding indicator lights up dimly.

## 3 TEST key

Press this button to output a test tone from the speakers. A test tone is outputted from the front, center, surround and subwoofer in turn. The test tone is used for adjusting volume balance among all the speakers.

\* Not all of the speakers output the test tone depending on the setting of the **SPEAKER MODE** switch (13).

## 4 MUTE button and indicator

Press this button to cut off sound output temporarily. When this function is active, the indicator lights up. Press this button again to restore sound output.

\* Sound output will also be restored by changing the status of this system between standby and power-on modes, and changing the input mode or the surround mode.

## 5 CENTER level control

This control is used for adjusting the level of sound outputted from the center speaker. Turn this control clockwise to increase the level, and counterclockwise to decrease the level.

## 6 SURROUND level control

This control is used for adjusting the level of sound outputted from the surround speakers. Turn this control clockwise to increase the level, and counterclockwise to decrease the level.



**7 SUBWOOFER level control**

This control is used for adjusting the level of sound outputted from the subwoofer. Turn this control clockwise to increase the level, and counterclockwise to decrease the level.

**8 MASTER VOLUME control**

This control is used for adjusting the whole volume level of this system. Turn this control clockwise to increase the level, and counterclockwise to decrease the level.

**9 Headphone jack**

Stereo headphones can be connected to this mini-jack for private listening. Sound output from the speakers are cut off when headphones are connected to this jack.

Sounds of all channels are mixed into 2-channels and outputted from the headphones.

**10 Power indicator**

Lights up when the power of this system is on.

**11 Power switch**

Each press of this switch changes the status of this system between standby mode and power on. When the power is on, the power indicator (10) lights up.

\* Note that this system uses a small amount of power in the standby mode.

**12 SPEAKER OUTPUTS****FRONT:**

Connect one satellite speaker with a 3 m cord to the L terminal and another to the R terminal. They are used as the front speakers.

**SURROUND:**

Connect one satellite speaker with a 7 m cord to the L terminal and the other to the R terminal. They are used as the surround speakers.

**CENTER:**

Connect one satellite speaker with a 3 m cord to this terminal. It is used as the center speaker.

**13 SPEAKER MODE switch**

Normally, set this switch to **5CH**. According to your preference, set this switch to another position.

**5CH:**

All speakers are used in this mode.

**4CH:**

Select this position when you will not use the center speaker. In this mode, center sound is outputted from the front L and R speakers.

**2CH:**

Select this position when you wish to output sounds in 2-channels only. In this mode, sounds of all channels are mixed and outputted from the front L and R speakers. The surround speakers output the same sounds as the front speakers.

**14 DC IN connector**

Connect the supplied AC adaptor to this connector.

**15 DIGITAL INPUTS**

External units which has digital signal output terminals can be connected to these terminals.

Input signals received at the **OPTICAL** terminal have priority over the signals at the **COAXIAL** terminal.

When both terminals receive signals, the signals at the **OPTICAL** terminal are reproduced with this system.

**OPTICAL:**

Connect an external unit (a DVD/CD player, an MD recorder, a video game player, etc.) which has an optical digital signal output terminal to this terminal by using the supplied optical cable.

**COAXIAL:**

Connect an external unit (a DVD/CD player, an MD recorder, a video game player, etc.) which has an coaxial digital signal output terminal to this terminal by using the supplied coaxial cable.

**16 ANALOG INPUTS**

Connect analog signal output terminals of an external unit to these mini-jack terminals by using the supplied mini plug cables or commercially available pin-to-mini plug cables.

**FRONT:**

Connect an analog (stereo) signal output terminal of an external unit to this terminal by using a supplied mini plug cable. When you connect a sound board on a computer which has four channel output terminals, connect the front channel output terminal of the sound board to this terminal.

**SURROUND:**

When you connect a sound board on a computer which has four channel output terminals, connect the rear channel output terminal of the sound board to this terminal.

## Adjusting speaker balance

This procedure lets you adjust the sound output level balance between the front, center, surround speakers and the subwoofer by using the built-in test tone generator. Make this adjustment so that each speaker output level becomes almost the same when heard at the listening position. This is important for high performance of the built-in DTS decoder and Dolby Digital decoder.

\* Once you have completed this adjustment, you can adjust the overall volume level of this system only by using the **MASTER VOLUME** control.

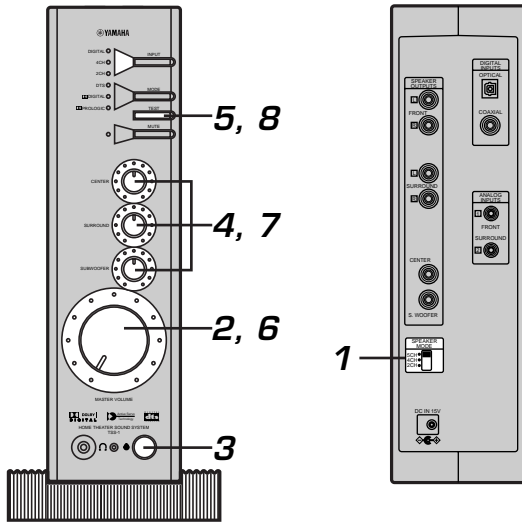

**1** Set the **SPEAKER MODE** switch to “5CH” if it is set to another position.

**2** Turn the **MASTER VOLUME** control fully counterclockwise to decrease the volume to minimum.

**3** Turn on this system.

**4** Set the **CENTER**, **SURROUND** and **SUBWOOFER** level controls at the center position.

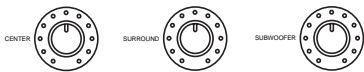

**5** Press the **TEST** button.

**6** Adjust the master volume to the desired level.

\* You will hear a test tone (like pink noise) from respective speakers for about two seconds in the following order: front speakers, center speaker, surround speakers and subwoofer.

**7** Adjust the **CENTER**, **SURROUND** and **SUBWOOFER** level controls while listening a series of test tones so that their levels become almost the same with the front speakers' level.

**8** When the adjustment is completed, press the **TEST** button.

\* The test tone stops.

## Playing a source

This section explains how to turn on this system and select input sources. Before turning on this system, turn on the external audio unit to be used.

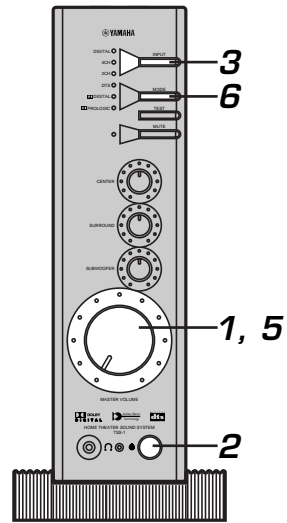

**1** Turn the **MASTER VOLUME** control fully counterclockwise to decrease the volume to minimum.

**2** Turn on this system.

**3** Select the appropriate input mode by pressing the **INPUT** selector button.

\* The indicator for the selected input mode lights up.

\* Refer to the “**Controls & connectors**” on page 4 for details about the input modes.

**4** Play s source on the external unit.

**5** Adjust the volume to the desired level.

**6** As you prefer, select a surround mode.

\* Refer to the “**Controls & connectors**” on page 4 for details about the surround modes.

## Troubleshooting

Refer to the chart below when the speakers do not function properly. If the problem you are experiencing is not listed below or if the instructions given below do not help, disconnect the AC adaptor and contact your authorized YAMAHA dealer or service center.

Problem	Cause	What to Do
<b>No sound comes from the speakers or subwoofer.</b>	The AC adaptor is not properly plugged into the AC receptacle.	Insert the AC adaptor firmly into the AC receptacle.
	The power of this system is set to off.	Turn on the power by pressing the power switch. (The power indicator lights up.)
	Connections are faulty or incomplete.	Make the connections again.
	Appropriate input mode is not selected.	Select the appropriate input mode by pressing the INPUT selector button.
	The volume setting is low.	Turn the MASTER VOLUME control clockwise to increase the volume.
	The MUTE function is active. (The indicator on the left side of the MUTE button is illuminated.)	Press the MUTE button to cancel this function. (Some other operations also cancel this function.)
<b>No sound from the surround speakers</b>	The SURROUND level control is set to minimum.	Turn the SURROUND level control clockwise to increase the level.
	No surround mode is selected.	Select the appropriate surround mode by pressing the MODE button. If no mode can be selected, change the input source to another which is encoded with DTS, Dolby Digital or Dolby Prologic.
<b>No sound from the center speaker</b>	The CENTER level control is set to minimum.	Turn the CENTER level control clockwise to increase the level.
	The SPEAKER MODE switch on the rear panel of the amplifier unit is set to "2CH" or "4CH".	Set the SPEAKER MODE switch to "5CH".
	No surround mode is selected.	Select the appropriate surround mode by pressing the MODE button. If no mode can be selected, change the input source to another which is encoded with DTS, Dolby Digital or Dolby Prologic.
<b>No sound from the center and surround speakers though the DTS or DIGITAL mode indicator is illuminated.</b>	Dim illumination of an indicator means that signals encoded with the corresponding format (DTS or Dolby Digital) is inputted to this system. In this case, the signals are mixed into 2-channels and outputted from the front speakers only.	Press the MODE button for the appropriate surround format. The indicator turns bright, and the center and surround speakers output sounds since the surround format is decoded.
<b>The DIGITAL mode indicator is dimly illuminated and the PROLOGIC mode indicator is brightly illuminated.</b>	The input source encoded with Dolby Digital may be originally in 2-channel mode.	Check the setting of the digital output on the player which is sending input signals to this system. If the input source is originally in 2-channel mode, use the PROLOGIC mode to enjoy the source in a multi-channel mode.
<b>Sound is distorted.</b>	The level of the signal being inputted is too low.	Turn up the volume on the connected component.
<b>Noise.</b>	The level of the signal being inputted is too high.	Turn down the volume on the connected component.
	Connections are faulty or incomplete.	Make the connections again.
	The amplifier unit is near the monitor.	Place the amplifier away from the monitor.

# Specifications

## Control unit

**Minimum RMS Output Power per Channel**  
..... 20W + 20W (20 Hz–20 kHz, 6Ω, 0.4% THD)

**Maximum Power** ..... 26W + 26W (1 kHz, 6Ω, 10% THD)

**Input Sensitivity/Input Impedance**  
**PC IN, AUX1 IN, AUX2 IN (ANALOG)** ..... 150 mV/35 kΩ

**Maximum Input Signal**  
**PC, AUX1, AUX2** ..... 2.1V or more (1 kHz)

**Output Level/Output Impedance**  
**REC OUT** ..... 150 mV/2.0 kΩ  
**SUBWOOFER OUTPUT** ..... 2.0V/1.7 kΩ (50 Hz)

**Headphone Jack Output Level/Output Impedance**  
**ANALOG PC IN, etc.** ..... 320 mV/61Ω (1 kHz, 150 mV)

**Frequency Response**  
**USB, DIGITAL IN (PC, AUX1) to SP Output**  
..... 20 Hz–20 kHz (±1.0 dB)

**Total Harmonic Distortion (1 kHz, 20 kLPF)**  
**USB, DIGITAL IN (PC, AUX1) to SP Output**  
..... 0.06% or less (4V/6Ω)

**Signal to Noise Ratio**  
**USB to SP Output** ..... 85 dB or more (11V/6Ω)  
**PC IN, AUX1 IN (DIGITAL) to SP Output**  
..... 90 dB or more (11V/6Ω)

**Residual Noise (IHF-A Network)**  
..... –68 dB or less (SP Output, L/R)

**Power Supply**  
**[U.S.A. and Canada models]** ..... AC 120V, 60 Hz  
**[Europe and U.K. models]** ..... AC 230V, 50 Hz  
**[Australia model]** ..... AC 240V, 50 Hz

**Power Consumption**  
**[U.S.A. and Canada models]** ..... 60W  
**[Europe, U.K. and Australia models]** ..... 55W

**Dimensions (W × H × D)** ..... 120 × 294 × 355 mm  
(4-3/4" × 11-9/16" × 14")

**Weight** ..... 5.5 kg (12 lbs. 2 oz.)

## Satellite speaker

**Type** ..... 2-way 2-speaker bass-reflex speaker system  
Magnetically shielded type

**Driver**  
**Woofers** ..... 9 cm (3-9/16") cone type  
**Tweeter** ..... 2.5 cm (1") balanced dome type

**Nominal Input Power** ..... 40W

**Maximum Input Power** ..... 100W

**Impedance** ..... 6Ω

**Frequency Response** ..... 75 Hz – 33 kHz

**Sensitivity** ..... 88 dB/2.83V/m

**Crossover Frequency** ..... 7 kHz

**Dimensions (W x H x D)** ..... 107 mm x 191 mm x 141 mm  
(4-3/16" x 7-1/2" x 5-9/16")

**Weight** ..... 1.5 kg (3 lbs. 5 oz.) x 4

## Subwoofer

**Type** ..... Active Servo Processing Subwoofer System

**Driver** ..... 20 cm (8") cone woofer (JA2162)  
Magnetically shielded type

**Amplifier Output** ..... 70W/5Ω

**High-Cut Filter** ..... 50 Hz – 150 Hz (–24 dB/oct.)

**Frequency Response** ..... 30 Hz – 200 Hz (–10 dB)

**Dimensions (W x H x D)** ..... 235 mm x 365 mm x 318 mm  
(9-5/16" x 14-7/20" x 12-1/2")

**Weight** ..... 9 kg (19 lbs. 13 oz.)

## Accessories

Mini plug cable x 2  
Optical fiber cable x 1  
Coaxial cable x 1  
Stand for the amplifier unit x 1  
Screw x 2  
Pad x 16

\* Please note that all specifications are subject to change without notice.