



UBTK

YSP-1

Digital Sound Projector

OWNER'S MANUAL

IMPORTANT SAFETY INSTRUCTIONS

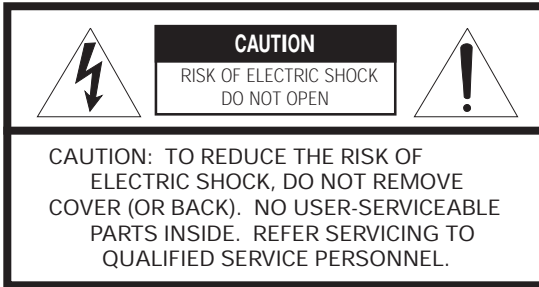

* Explanation of Graphical Symbols

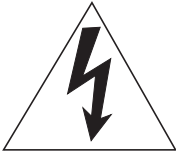

The lightning flash with arrowhead symbol, within an equilateral triangle, is intended to alert you to the presence of uninsulated “dangerous voltage” within the product’s enclosure that may be of sufficient magnitude to constitute a risk of electric shock to persons.



The exclamation point within an equilateral triangle is intended to alert you to the presence of important operating and maintenance (servicing) instructions in the literature accompanying the appliance.

- 1 Read these instructions.
- 2 Keep these instructions.
- 3 Heed all warnings.
- 4 Follow all instructions.
- 5 Do not use this apparatus near water.
- 6 Clean only with dry cloth.
- 7 Do not block any ventilation openings. Install in accordance with the manufacturer’s instructions.
- 8 Do not install near any heat sources such as radiators, heat registers, stoves, or other apparatus (including amplifiers) that produce heat.
- 9 Do not defeat the safety purpose of the polarized or grounding-type plug. A polarized plug has two blades with one wider than the other. A grounding type plug has two blades and a third grounding prong. The wide blade or the third prong are provided for your safety. If the provided plug does not fit into your outlet, consult an electrician for replacement of the obsolete outlet.
- 10 Protect the power cable from being walked on or pinched particularly at plugs, convenience receptacles, and the point where they exit from the apparatus.
- 11 Only use attachments/accessories specified by the manufacturer.
- 12 Use only with the cart, stand, tripod, bracket, or table specified by the manufacturer, or sold with the apparatus. When a cart is used, use caution when moving the cart/apparatus combination to avoid injury from tip-over.
- 13 Unplug this apparatus during lightning storms or when unused for long periods of time.
- 14 Refer all servicing to qualified service personnel. Servicing is required when the apparatus has been damaged in any way, such as power-supply cord or plug is damaged, liquid has been spilled or objects have fallen into the apparatus, the apparatus has been exposed to rain or moisture, does not operate normally, or has been dropped.



FCC INFORMATION (for US customers)

1. IMPORTANT NOTICE : DO NOT MODIFY THIS UNIT!

This product, when installed as indicated in the instructions contained in this manual, meets FCC requirements. Modifications not expressly approved by Yamaha may void your authority, granted by the FCC, to use the product.

2. IMPORTANT :

When connecting this product to accessories and/or another product use only high quality shielded cables. Cable/s supplied with this product **MUST** be used. Follow all installation instructions. Failure to follow instructions could void your FCC authorization to use this product in the USA.

3. NOTE :

This product has been tested and found to comply with the requirements listed in FCC Regulations, Part 15 for Class "B" digital devices. Compliance with these requirements provides a reasonable level of assurance that your use of this product in a residential environment will not result in harmful interference with other electronic devices.

This equipment generates/uses radio frequencies and, if not installed and used according to the instructions found in the users manual, may cause interference harmful to the operation of other electronic devices.

Compliance with FCC regulations does not guarantee that interference will not occur in all installations. If this product is found to be the source of interference, which can be determined by turning the unit "OFF" and "ON", please try to eliminate the problem by using one of the following measures:

Relocate either this product or the device that is being affected by the interference.

Utilize power outlets that are on different branch (circuit breaker or fuse) circuits or install AC line filter/s.

In the case of radio or TV interference, relocate/reorient the antenna. If the antenna lead-in is 300 ohm ribbon lead, change the lead-in to coaxial type cable.

If these corrective measures do not produce satisfactory results, please contact the local retailer authorized to distribute this type of product. If you can not locate the appropriate retailer, please contact Yamaha Electronics Corp., U.S.A. 6660 Orangethorpe Ave, Buena Park, CA 90620.

The above statements apply **ONLY** to those products distributed by Yamaha Corporation of America or its subsidiaries.

We Want You Listening For A Lifetime

YAMAHA and the Electronic Industries Association's Consumer Electronics Group want you to get the most out of your equipment by playing it at a safe level. One that lets the sound come through loud and clear without annoying blaring or distortion – and, most importantly, without affecting your sensitive hearing.

Since hearing damage from loud sounds is often undetectable until it is too late, YAMAHA and the Electronic Industries Association's Consumer Electronics Group recommend you to avoid prolonged exposure from excessive volume levels.



CAUTION: READ THIS BEFORE OPERATING YOUR UNIT.

- 1 To assure the finest performance, please read this manual carefully. Keep it in a safe place for future reference.
- 2 Install this sound system in a well ventilated, cool, dry, clean place with at least 5 cm of space above (or below) YSP-1 – away from direct sunlight, heat sources, vibration, dust, moisture, and/or cold.
- 3 Locate this unit away from other electrical appliances, motors, or transformers to avoid humming sounds.
- 4 Do not expose this unit to sudden temperature changes from cold to hot, and do not locate this unit in an environment with high humidity (i.e. a room with a humidifier) to prevent condensation inside this unit, which may cause an electrical shock, fire, damage to this unit, and/or personal injury.
- 5 Avoid installing this unit where foreign object may fall onto this unit and/or this unit may be exposed to liquid dripping or splashing. On the top of this unit, do not place:
 - Other components, as they may cause damage and/or discoloration on the surface of this unit.
 - Burning objects (i.e. candles), as they may cause fire, damage to this unit, and/or personal injury.
 - Containers with liquid in them, as they may fall and liquid may cause electrical shock to the user and/or damage to this unit.
- 6 Do not cover this unit with a newspaper, tablecloth, curtain, etc. in order not to obstruct heat radiation. If the temperature inside this unit rises, it may cause fire, damage to this unit, and/or personal injury.
- 7 Do not plug in this unit to a wall outlet until all connections are complete.
- 8 Do not operate this unit upside-down. It may overheat, possibly causing damage.
- 9 Do not use force on switches, knobs and/or cords.
- 10 When disconnecting the power cable from the wall outlet, grasp the plug; do not pull the cable.
- 11 Do not clean this unit with chemical solvents; this might damage the finish. Use a clean, dry cloth.
- 12 Only voltage specified on this unit must be used. Using this unit with a higher voltage than specified is dangerous and may cause fire, damage to this unit, and/or personal injury. YAMAHA will not be held responsible for any damage resulting from use of this unit with a voltage other than specified.
- 13 To prevent damage by lightning, disconnect the power cable from the wall outlet during an electrical storm.
- 14 Do not attempt to modify or fix this unit. Contact qualified YAMAHA service personnel when any service is needed. The cabinet should never be opened for any reasons.
- 15 When not planning to use this unit for long periods of time (i.e. vacation), disconnect the AC power plug from the wall outlet.
- 16 Be sure to read the “TROUBLESHOOTING” section on common operating errors before concluding that this unit is faulty.
- 17 Before moving this unit, press STANDBY/ON to set this unit in standby mode, and disconnect the AC power plug from the wall outlet.
- 18 Condensation will form when the surrounding temperature changes suddenly. Disconnect the power cable from the outlet, then leave the unit alone.
- 19 When using the unit for a long time, the unit may become warm. Turn the power off, then leave the unit alone for cooling.

WARNING

TO REDUCE THE RISK OF FIRE OR ELECTRIC SHOCK, DO NOT EXPOSE THIS APPLIANCE TO RAIN OR MOISTURE.

This unit is not disconnected from the AC power source as long as it is connected to the wall outlet, even if this unit itself is turned off. This state is called the standby mode. In this state, this unit is designed to consume a very small quantity of power.

FOR CANADIAN CUSTOMERS

To prevent electric shock, match wide blade of plug to wide slot and fully insert.
This Class B digital apparatus complies with Canadian ICES-003.

IMPORTANT

Please record the serial number of this unit in the space below.

MODEL:

Serial No.:

The serial number is located on the rear or the bottom of this unit.

Retain this Owner's Manual in a safe place for future reference.

■ For U.K. customers

If the socket outlets in the home are not suitable for the plug supplied with this appliance, it should be cut off and an appropriate 3 pin plug fitted. For details, refer to the instructions described below.

Note

The plug severed from the mains lead must be destroyed, as a plug with bared flexible cord is hazardous if engaged in a live socket outlet.

■ Special instructions for U.K. model

IMPORTANT

THE WIRES IN MAINS LEAD ARE COLOURED IN ACCORDANCE WITH THE FOLLOWING CODE:

Blue: NEUTRAL

Brown: LIVE

As the colours of the wires in the mains lead of this apparatus may not correspond with the coloured markings identifying the terminals in your plug, proceed as follows:
The wire which is coloured BLUE must be connected to the terminal which is marked with the letter N or coloured BLACK. The wire which is coloured BROWN must be connected to the terminal which is marked with the letter L or coloured RED.

Making sure that neither core is connected to the earth terminal of the three pin plug.

CAUTION

Danger of explosion if battery is incorrectly replaced.
Replace only with the same or equivalent type.

CAUTION

Use of controls or adjustments or performance of procedures
other than those specified herein may result in hazardous
radiation exposure.

HOW TO USE THIS MANUAL

Check that you have received all of the supplied accessories.

(See “Supplied accessories” on page 4.)



Install this unit in your listening room.

(See “INSTALLING THIS UNIT IN YOUR LISTENING ROOM” on page 9.)



Connect this unit to your TV and other external components.

(See “CONNECTIONS” on page 11.)



Prepare the remote control and turn on this unit.

(See “PREPARING THE REMOTE CONTROL” on page 18 and “BASIC OPERATION” on page 19.)



Follow the steps to enjoying surround sound or make EASY SETUP settings.

(See “STEPS TO ENJOYING SURROUND SOUND” on page 20 or “EASY SETUP” on page 24.)



Play back a source and adjust the beam mode settings.

(See “PLAYBACK” on page 31 and “ADJUSTING BEAM MODE SETTINGS” on page 34.)

To make additional settings and adjustments:



Make MANUAL SETUP settings and set remote control codes.

(See “MANUAL SETUP” on page 36 and “REMOTE CONTROL FEATURES” on page 51.)

CONTENTS

INTRODUCTION

OVERVIEW	2
Selecting a listening room	4
About this manual.....	4
Supplied accessories	4
CONTROLS AND FUNCTIONS	5
Front panel.....	5
Front panel display	6
Bottom panel.....	7
Remote control.....	8

PREPARATION

INSTALLING THIS UNIT IN YOUR	
LISTENING ROOM	9
Choosing an installation location.....	9
Using a metal wall bracket	10
Using a stand.....	10
Using a rack	10
Affixing this unit.....	10
CONNECTIONS	11
Connecting a TV.....	12
Connecting a DVD player/recorder	13
Connecting a VCR.....	14
Connecting other external components	15
Connecting a subwoofer	16
Connecting the power supply cable.....	17
About the RS-232C terminal	17

BASIC OPERATION

PREPARING THE REMOTE CONTROL	18
Installing batteries in the remote control	18
BASIC OPERATION	19
Using the remote control	19
Turning the power on/to standby mode	19
STEPS TO ENJOYING SURROUND	
SOUND	20
Displaying the on-screen display (OSD)	20
Selecting a preset listening environment	21
Enjoying TV in surround sound	22
EASY SETUP.....	24
Using EASY SETUP.....	24
VOLUME CONTROLS.....	30
Adjusting the volume.....	30
Muting the sound	30
PLAYBACK.....	31
Selecting an input source.....	31
Playing back sources.....	31
SELECTING A SURROUND MODE.....	32
Playback sources and their available surround modes.....	32
Enjoying 2-channel sources with multi channels ...	32
Surround mode parameters	33
ADDITIONAL PLAYBACK MODES	33
Night listening modes	33
ADJUSTING BEAM MODE SETTINGS.....	34
Stereo mode	34
3 beam mode.....	34
5 beam mode.....	34
ST(STEREO)+3 beam mode	35

ADVANCED OPERATION

MANUAL SETUP.....	36
Using SET MENU.....	37
SOUND MENU.....	38
BEAM MENU	40
INPUT MENU.....	44
OPTION MENU	45
SELECTING AN INPUT MODE.....	47
MANUALLY ADJUSTING OUTPUT	
LEVELS	48
Using the test tone	48
Adjusting output levels during playback	49
USING THE SLEEP TIMER	50

ADDITIONAL INFORMATION

REMOTE CONTROL FEATURES	51
Setting remote control codes	51
Controlling other components	52
TROUBLESHOOTING	54
RESETTING THE FACTORY PRESETS	57
FRONT PANEL DISPLAY ITEMS	58
GLOSSARY.....	59
Audio formats	59
Audio information	59
INDEX.....	60
SPECIFICATIONS.....	61

INTRODUCTION

PREPARATION

BASIC
OPERATION

ADVANCED
OPERATION

ADDITIONAL
INFORMATION

OVERVIEW

It is generally accepted that in order to fully enjoy the benefits of surround sound at home, you must endure the agony of wiring and installing a great number of speakers in the hope that your listening room will give you the same kind of surround sound experience as your local movie theater.

YAMAHA's YSP-1 Digital Sound Projector challenges this preconception that complicated speaker set up and troublesome wiring go hand-in-hand with the enjoyment of multi-channel surround sound.

Sound Beam Diagram

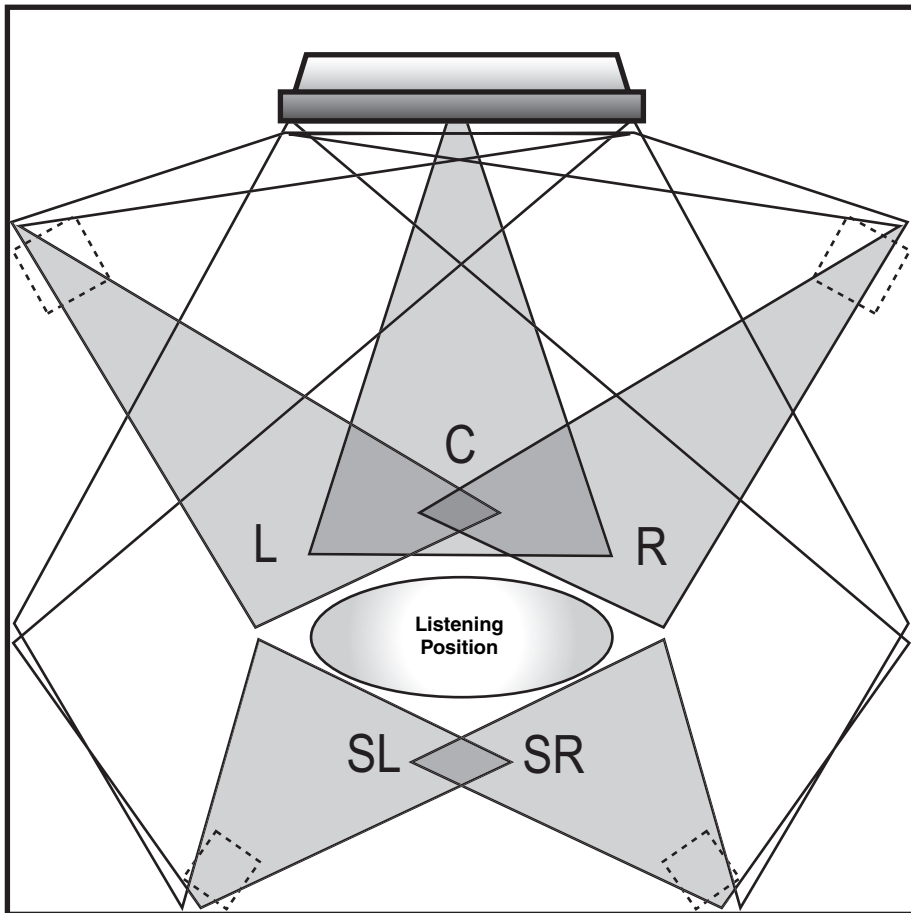

 Imaginary front speaker position

 Imaginary surround speaker position

This slimline unit does away with the need for complicated wiring and installation worries, leaving you with a unit that is not only easy to set up, but which is also capable of reproducing the kind of powerful surround sound you have been waiting for from its built-in subwoofers (2) and individual speakers (40).

You can use this unit's parameters to fine tune the delay time for separate sound beams, resulting in highly directional sound that comes in on the listening position from all directions.

The YSP-1 projects sound beams containing surround sound information for the front right (R), front left (L), surround right (SR) and surround left (SL) speaker positions, which are reflected off the walls of your listening room before reaching the actual listening position. With the addition of center (C) sound beams, this Digital Sound Projector creates true-to-life 5.1 channel surround sound that makes you feel as if there are actual speakers around the room.

Further, you can change the way in which these beams are projected at your walls (the beam mode) to match the contents of the program you are watching or your listening environment, giving you a virtual surround sound experience for both stereo and 5.1-channel playback.

This unit's SET MENU can be displayed on your TV screen, allowing you to customize this unit to suit your listening environment. Set up is straight forward using the MEMORY or EASY SETUP menus. MEMORY allows you to load preset listening environment parameters for quick setup. EASY SETUP is an easy-to-follow setup method for first-time users. In addition, the MANUAL SETUP menu offers advanced parameters for the surround sound enthusiast who wants to make individual adjustments for each speaker position.

This highly-advanced projector supports a wide range of sound technology, including Dolby Digital, a basic audio format for DVDs, Dolby Pro Logic for the reproduction of true-to-life sound, and DTS for playback of the best possible sound clarity.

Equipped with two optical digital, one coaxial digital and two analog input jacks, the YSP-1 allows you to expand your system through the direct connection of external components, such as a DVD player.

Sit back and enjoy the real sound experience of this simple, yet stylish Digital Sound Projector.

Selecting a listening room

This unit creates surround sound by reflecting projected sound beams off the walls of your listening room. The surround sound effects produced by this unit may not be sufficient when the unit is installed in the following locations:

- Rooms with surfaces inadequate for reflecting sound beams
- Rooms with acoustically absorbent surfaces
- Rooms with measurements outside the range: (3 to 7 m) × (2 to 3.5 m) × (3 to 7 m) (W × H × D)
- Rooms with less than 2 m from the listening position to the speaker positions
- Rooms where objects such as furniture are likely to obstruct the path of sound beams

About this manual

- This manual describes how to connect and operate the YSP-1. For details regarding the operation of external components, refer to the supplied owner's manual for the component.
- Some operations can be performed by using either the buttons on the main unit or on the remote control. In such cases, the operation is described using remote control operation.
-  indicates a tip for your operation.
- This manual is printed prior to production. Design and specifications are subject to change in part as a result of improvements, etc. In case of differences between the manual and product, the product has priority.



Manufactured under license from Dolby Laboratories. "Dolby", "Pro Logic", and the double-D symbol are trademarks of Dolby Laboratories.



"DTS", and "Neo:6" are trademarks of Digital Theater Systems, Inc.



Manufactured under license from 1 Ltd. world-wide patents applied for.

The "1" logo and "Digital Sound Projector" are trademarks of 1 Ltd.

Supplied accessories

Please check that you received all of the following parts.

Remote control (×1)

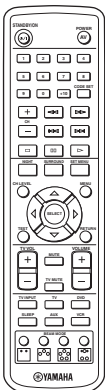

Batteries (×2)
(AA, R6, UM-3)

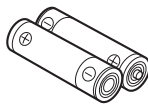

Cable Holder (×1)

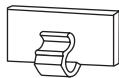

Fastener (×4)

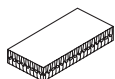

OSD Video Cable (×1)

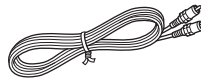

Digital Audio Pin Cable (×1)

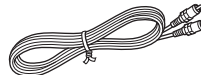

Audio Pin Cable (×1)

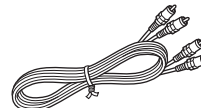

Optical Cable (×1)

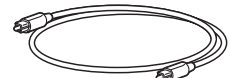

Power Cable (×1)

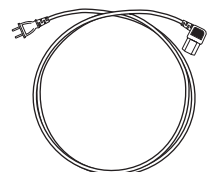

CONTROLS AND FUNCTIONS

Front panel

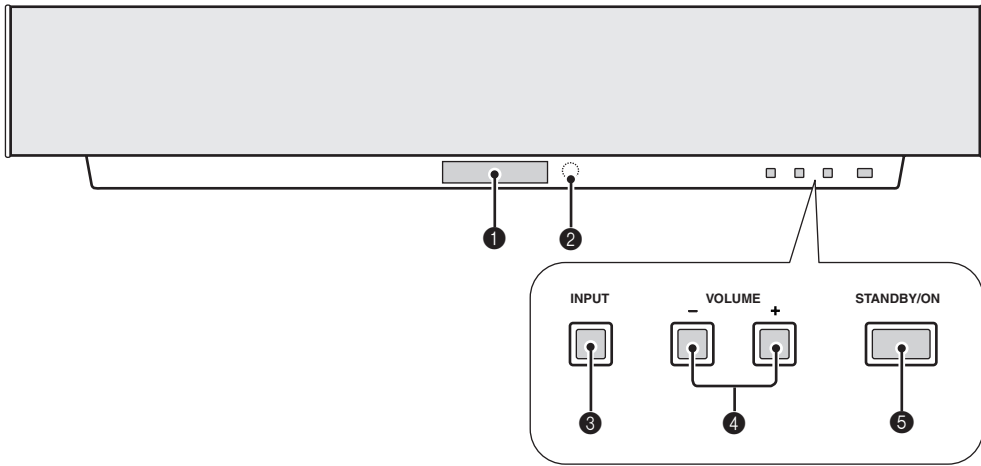

❶ Front panel display

Shows information about the operational status of this unit.

❷ Remote control sensor

Receives signals from the remote control.

❸ INPUT

Switches between the connected external audio sources.

❹ VOLUME +/-

Controls the output level of all audio channels (see page 30).

❺ STANDBY/ON

Turns on this unit or sets it in the standby mode (see page 19). When you turn on this unit, you will hear a click and there will be a 4 to 5-second delay before it can reproduce sound.

Note

In standby mode, this unit consumes a small amount of power in order to receive infrared-signals from the remote control.

Front panel display

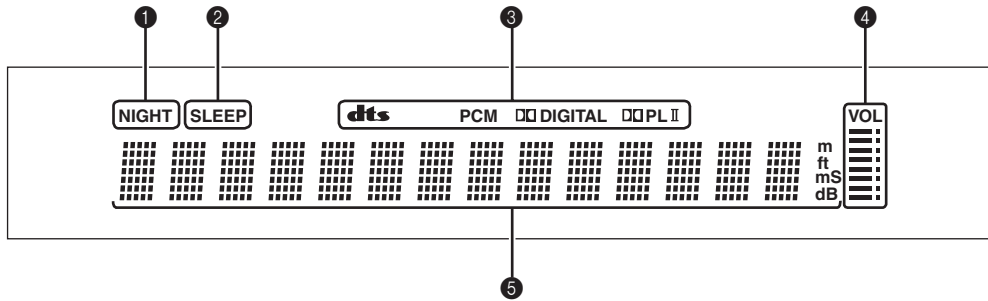

1 NIGHT indicator

Lights up when you select a night listening mode (see page 33).

2 SLEEP indicator

Lights up while the sleep timer is on (see page 50).

3 Decoder indicators

When any of this unit's decoders function, the respective indicator lights up.

4 Volume level indication

Indicates the current volume level (see page 30).

5 Multi-information display

Shows information when adjusting or changing settings.

Bottom panel

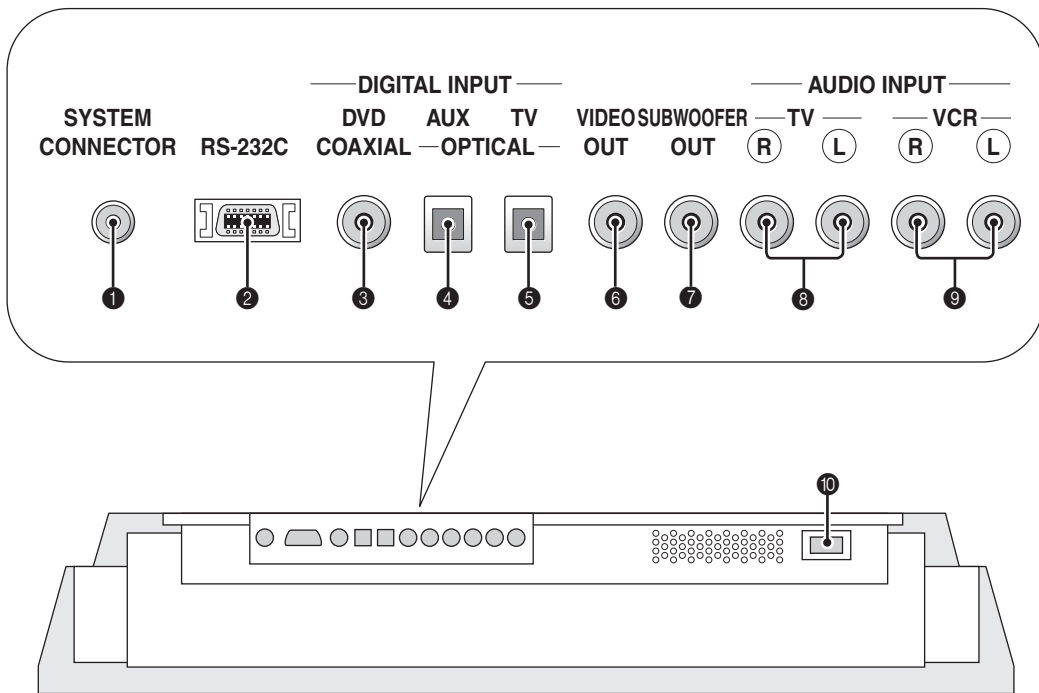

❶ SYSTEM CONNECTOR jack

Use to connect a YAMAHA subwoofer equipped with a SYSTEM CONNECTOR jack to this unit (see page 16).

❷ RS-232C terminal

This is a control expansion terminal for commercial use only (see page 17).

❸ DVD coaxial digital input jack

Use to connect a DVD player using a coaxial digital connection (see page 13).

❹ AUX optical digital input jack

Use to connect an external component using an optical digital connection (see page 15).

❺ TV optical digital input jack

Use to connect a TV using an optical digital connection (see page 12).

❻ VIDEO OUT jack

Connect to your TV's video input terminal to display this unit's OSD (see page 12).

❼ SUBWOOFER OUT jack

Use to connect a subwoofer (see page 16).

❽ TV analog audio input jacks

Use to make an analog connection to your TV (see page 12).

❾ VCR analog audio input jacks

Use to make an analog connection to your VCR (see page 14).

❿ AC IN

Connect the supplied power cable (see page 17).

Remote control

This section describes the function of each control on the remote control used to control this system. To operate other components, see “Controlling other components” on page 52.

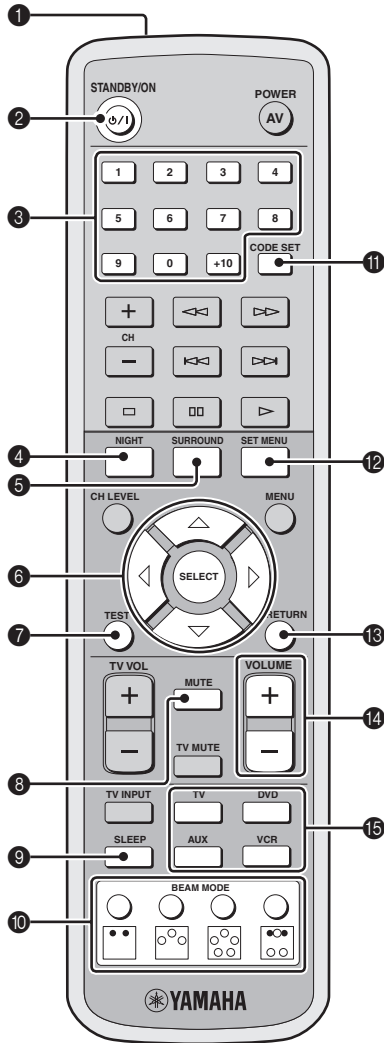

1 Infrared window

Outputs infrared control signals. Aim this window at the component you want to operate.

2 STANDBY/ON

Sets this system in the standby mode (see page 19).

3 Numeric buttons

Use to enter numbers.

4 NIGHT

Turns on or off the night listening modes (see page 33).

5 SURROUND

Selects the surround mode for playback (see page 32).

6 Cursor buttons $\triangle / \nabla / \leftarrow / \rightarrow$ SELECT

Use to select and adjust SET MENU items.

7 TEST

Outputs a test tone when adjusting the speaker levels (see page 48).

8 MUTE

Mutes the sound (see page 30). Press again to restore the audio output to the previous volume level.

9 SLEEP

Sets the sleep timer (see page 50).

10 Beam mode buttons

Change the beam mode settings (see page 34).

11 CODE SET

Use to set up remote control codes (see page 51).

12 SET MENU

Displays the SET MENU on your TV or monitor (see page 24).

13 RETURN

Use to select sleep timer settings (see page 50) or return to the previous SET MENU screen (see page 24).

14 VOLUME +/-

Increases or decreases this system's volume level (see page 30).

15 Input selector buttons

Use to select a playback source and change the control area (see page 31).

INSTALLING THIS UNIT IN YOUR LISTENING ROOM

This section describes how to choose a suitable installation location for this unit, and how to install the unit using either a metal wall bracket, rack or stand.

Note

If objects such as furniture are obstructing the path of sound beams, the desired surround sound effects may not be achieved. Make sure you install this unit where there are no objects in the path of sound beams.

Notes on installation

- When installing this unit, be sure to leave an adequate amount of ventilation space so that heat can escape. Make sure you leave at least 5 cm of space above (or below) this unit (as shown in the illustration on the right).
- We do not recommend installing this unit so that it is positioned directly on the floor of your listening room. Please install this unit using a metal wall bracket, rack or stand.
- This unit weighs 13 kg (28lbs). Be sure to install this unit where it will not fall if subject to vibrations, such as from an earthquake, and where it is out of the reach of children.
- When using a cathode-ray tube (CRT) TV, do not install this unit directly above your TV.
- This unit is shielded against magnetic rays. However, if the picture on your TV screen becomes blurred or distorted, we recommend moving the speakers away from your TV.

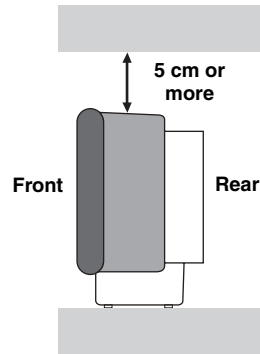

Choosing an installation location

To experience the best surround sound this unit can deliver, make sure you install this unit in a location where objects, such as furniture, are not in the direct path of the sound beams (see the illustration below).

When installing this unit parallel to the wall, try placing it so that it is in the exact center of the wall (measured from the left and right corners).

When installing this unit in the corner of your listening room, make sure the speakers are placed between 40° to 50° from the adjacent walls.

 An object, such as furniture

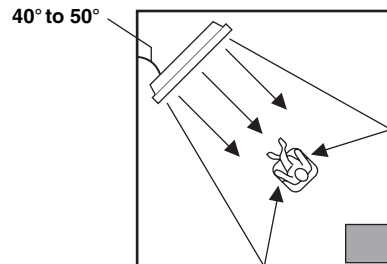
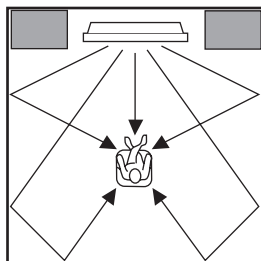

Using a metal wall bracket

You can use the optional metal wall bracket to mount this system on your listening room wall.

For details on how to attach the metal bracket to the wall or how to attach this system to the metal bracket, refer to the instructions supplied with the bracket.

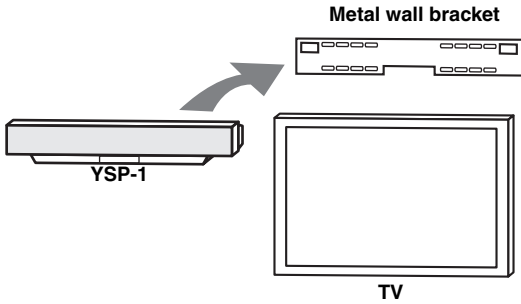

Using a stand

You can mount your TV on the stand placed on a commercially available rack to install this unit under your TV.

For details on how to attach the stand or how to attach this system to your TV, refer to the instructions supplied with the stand.

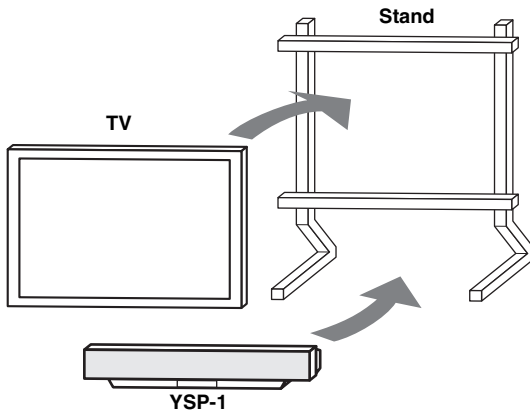

Using a rack

You can install this system either above or under your TV in a commercially available rack.

Before installing, make sure that the rack is large enough to allow adequate ventilation space around this unit, and that it is strong enough to support the weight of both this unit and your TV.

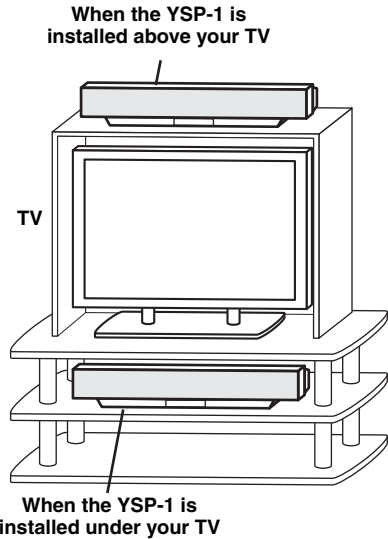

Affixing this unit

To affix this unit, remove the protection pads from the bottom of the unit, then secure the supplied fasteners (4 pieces) to the bottom four corners of this unit and the top of the rack, etc. as shown below.

Notes

- Do not install this unit on top of a slanted surface. This unit may fall over and cause injury.
- Make sure you wipe the surface of the rack, etc. before securing the fasteners. Applying the tape to a dirty or wet surface will weaken the sticking power of the tape, and this unit may fall as a result.

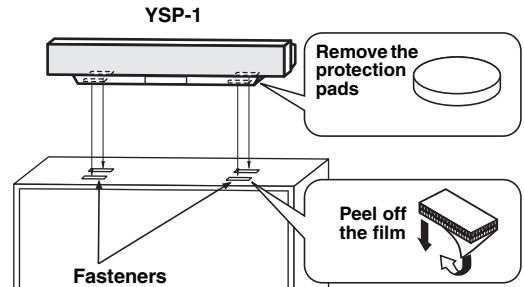

CONNECTIONS

This unit is equipped with two optical digital jacks, one coaxial digital jack and two types of analog jacks for connecting external components such as your TV, DVD player, VCR and game console. Further, by connecting a subwoofer to this unit, you can enjoy reinforced low bass sounds. For details on how to connect the various types of external components to this unit, see pages 12 to 17.

CAUTION

Do not connect this unit or other components to the mains power until all connections between components are complete.

PREPARATION

— Audio connection

— Video connection

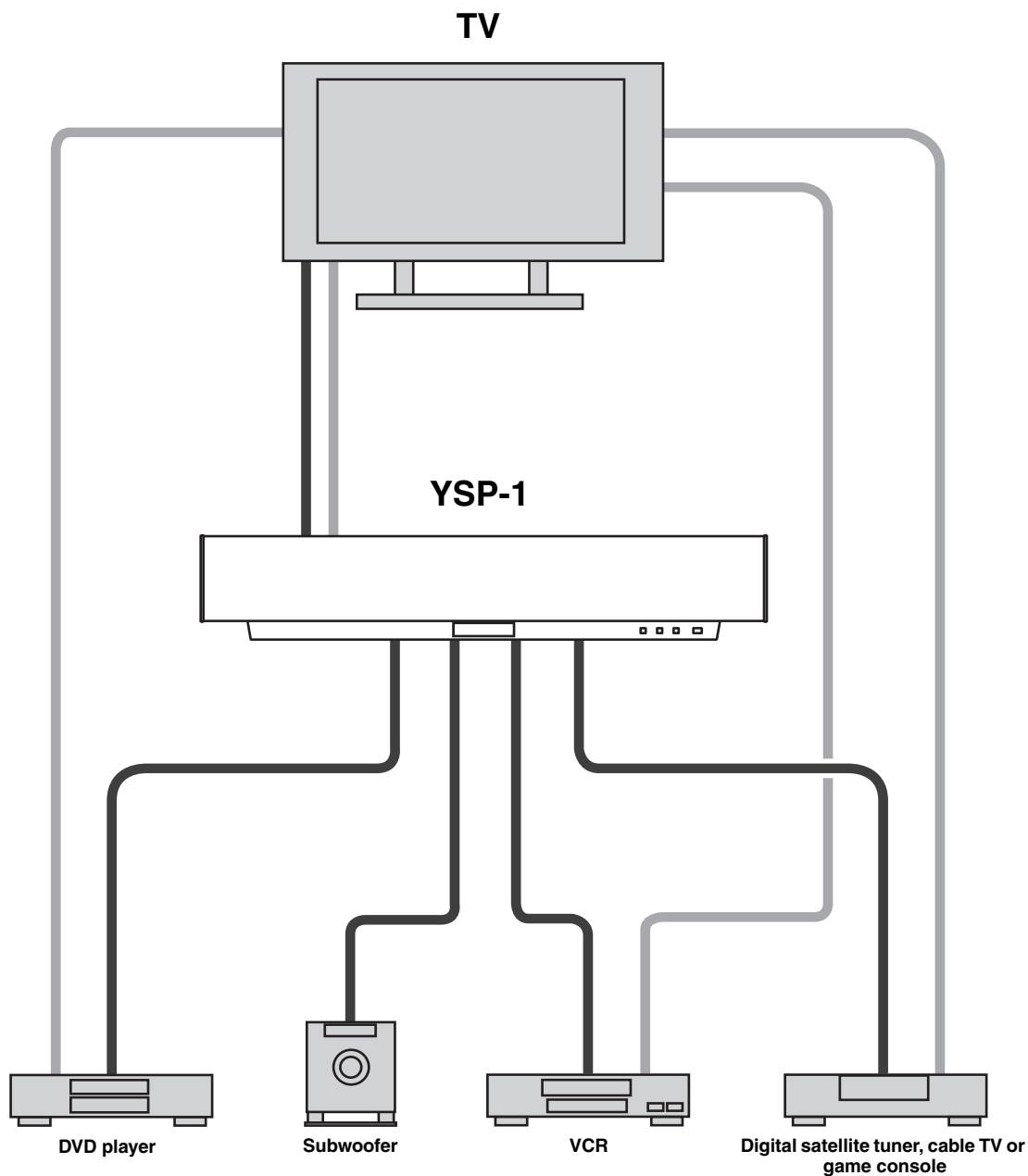

Connecting a TV

You can connect a TV to this unit and display the OSD for easy viewing (see page 20) when operating SET MENU (see page 24). When connecting the Optical Cable, use the Cable Holder at the rear panel of the YSP-1 to fix the cable (see page 15).

Cables used for connections

For digital connections

Audio Pin Cable (supplied)



Optical Cable (supplied)

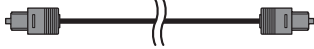

For video (OSD) connections

OSD Video Cable (supplied)

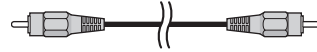

■ Digital and analog connections

YSP-1 (Bottom panel)

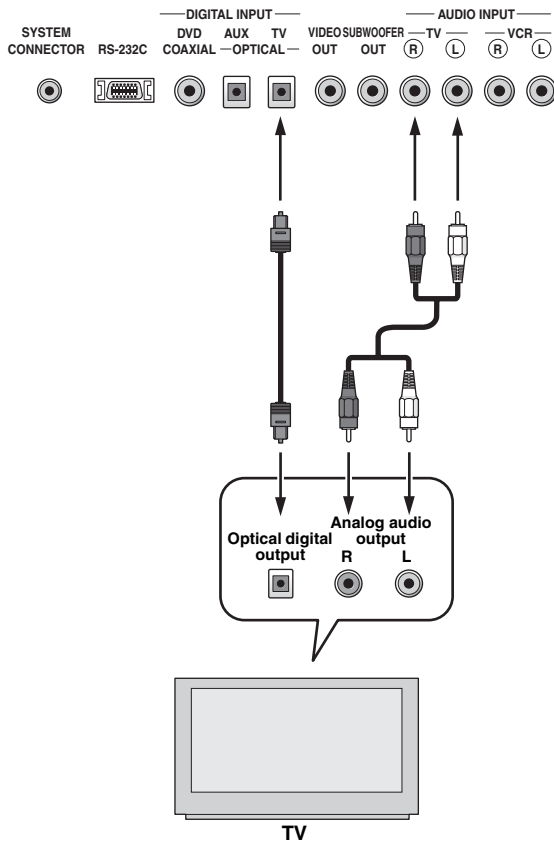

■ Video (OSD) connections

YSP-1 (Bottom panel)

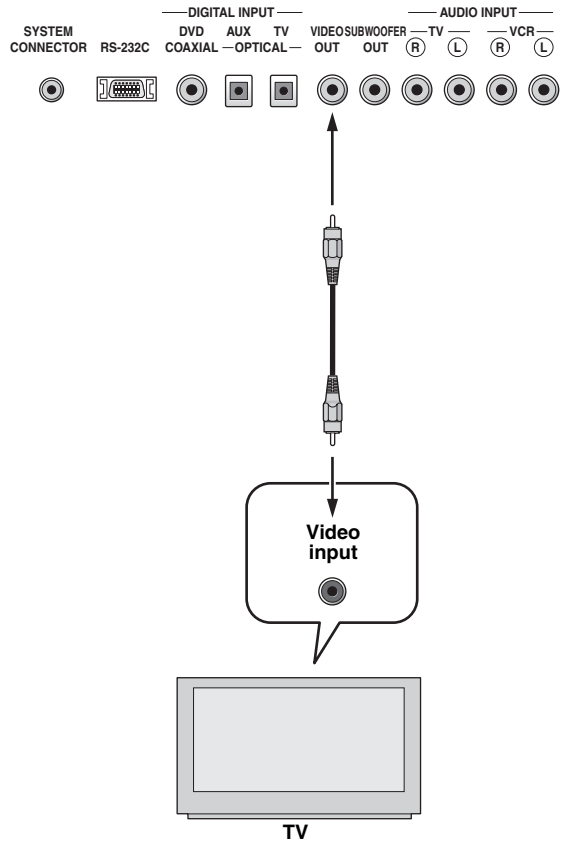

Connecting a DVD player/recorder

To connect a DVD player/recorder, connect the coaxial digital output jack on your DVD player to the coaxial digital input jack (DVD COAXIAL) on this unit.

If there is no coaxial digital output jack on your DVD player/recorder, use them with optical digital connection.

Cables used for connections

Digital Audio Pin Cable (supplied)

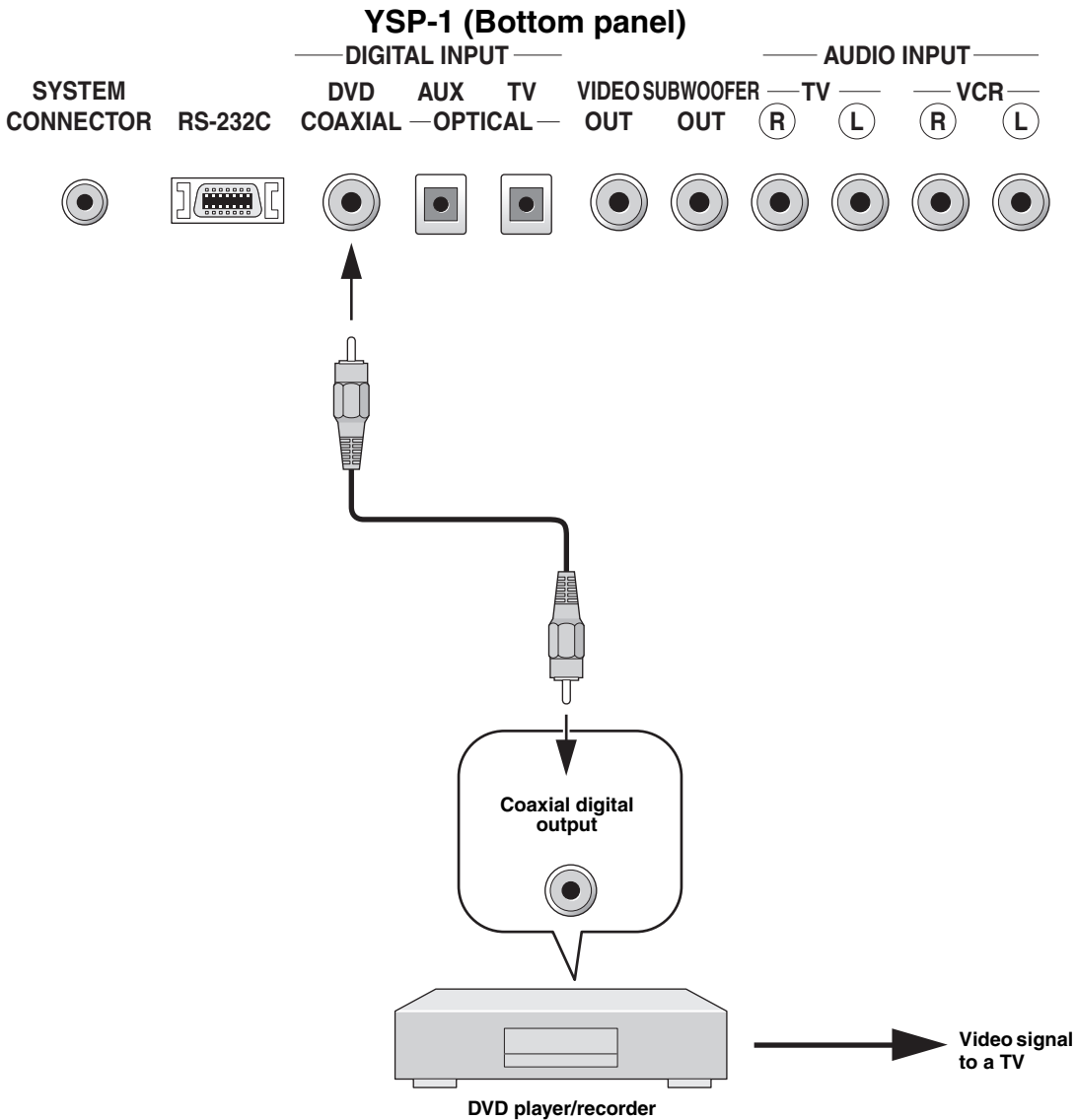
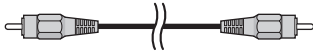

PREPARATION

Connecting a VCR

To connect a VCR, connect the analog audio output jack on your VCR to the analog audio input jack (VCR R/L) on this unit.

Connect red plugs to the right jacks and white plugs to the left jacks.

Cables used for connections

Audio Pin Cable



YSP-1 (Bottom panel)

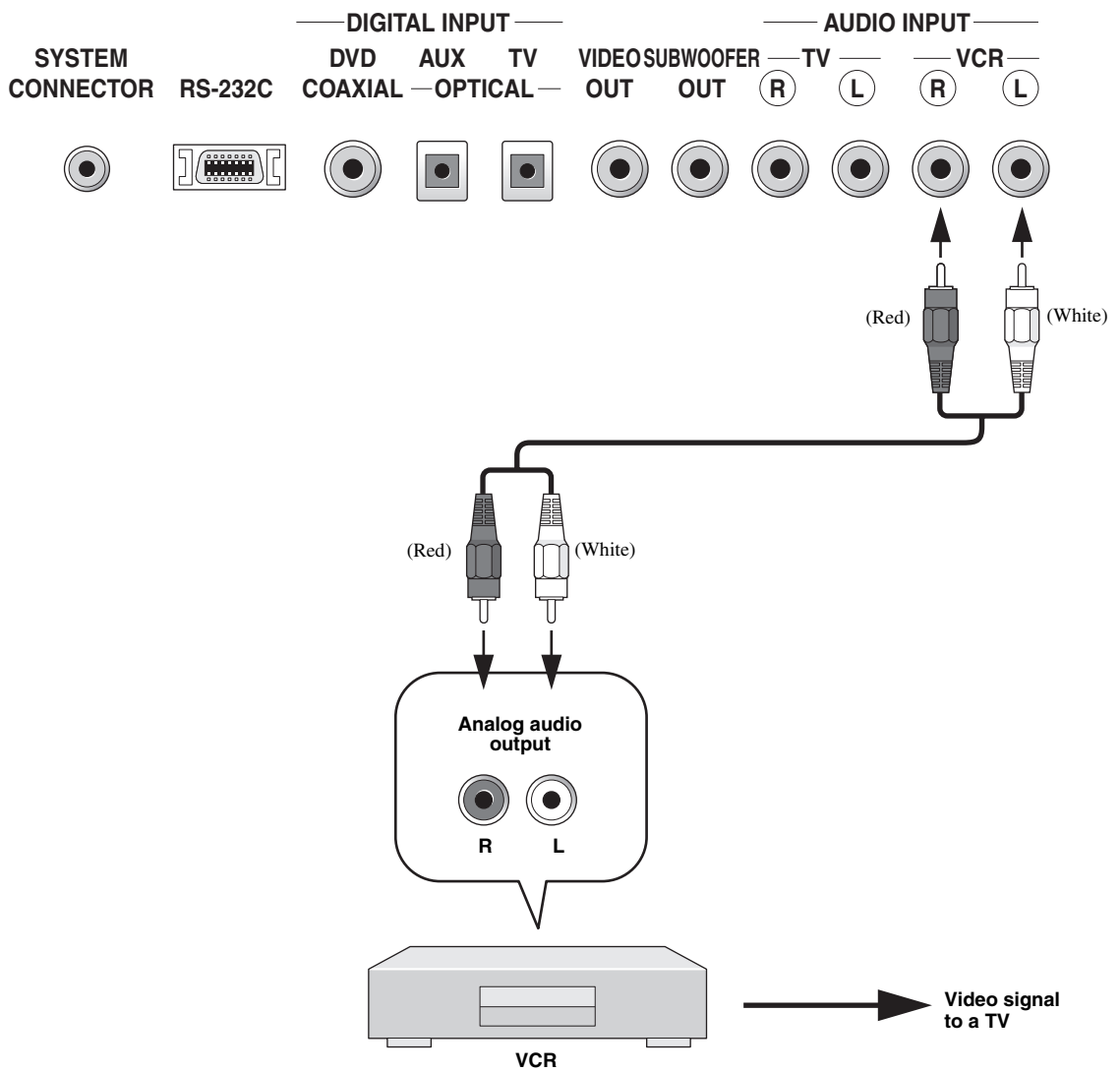

Connecting other external components

To connect other external components, connect the optical digital output jack on the component to the optical digital input jack (AUX OPTICAL) on this unit.

You can connect a DVD player/recorder or a component that supports optical digital connections.

Cables used for connections

Optical Cable

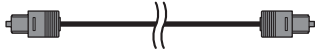

YSP-1 (Bottom panel)

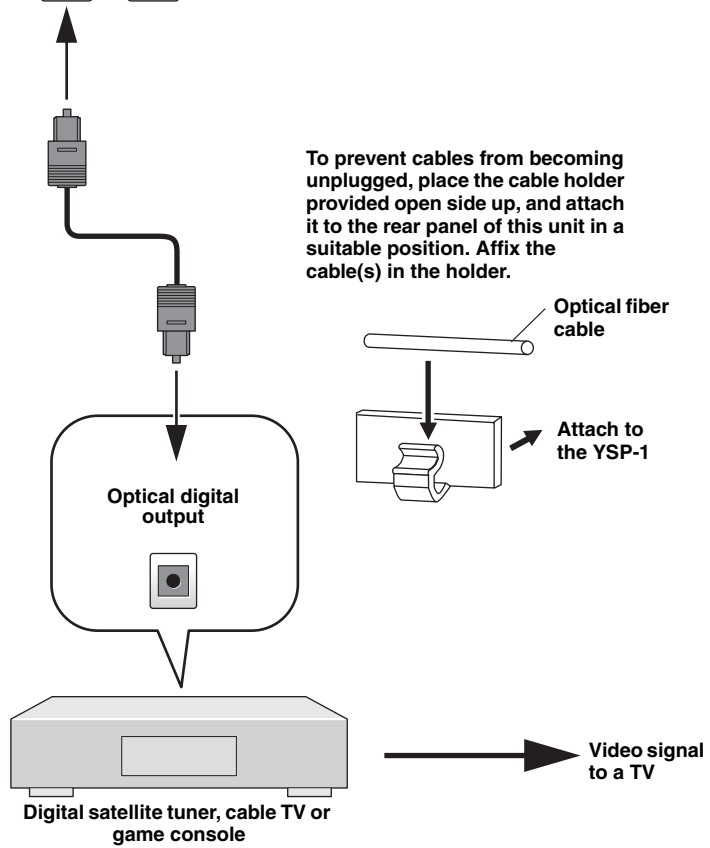
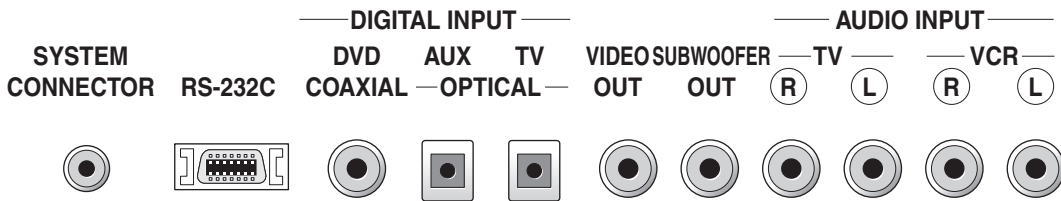

Connecting a subwoofer

To connect a subwoofer, connect the monaural input jack on your subwoofer to the monaural audio output jack (SUBWOOFER OUT) on this unit.

When connecting a YAMAHA subwoofer equipped with a SYSTEM CONNECTOR jack, connect it to the SYSTEM CONNECTOR jack on this unit. If the subwoofer is connected using a system type connection, changing the power mode of this unit controls the power mode of the subwoofer.

To adjust the settings for your subwoofer, see SUBWOOFER SET in MANUAL SETUP (page 38).

Cables used for connections

Subwoofer pin cable

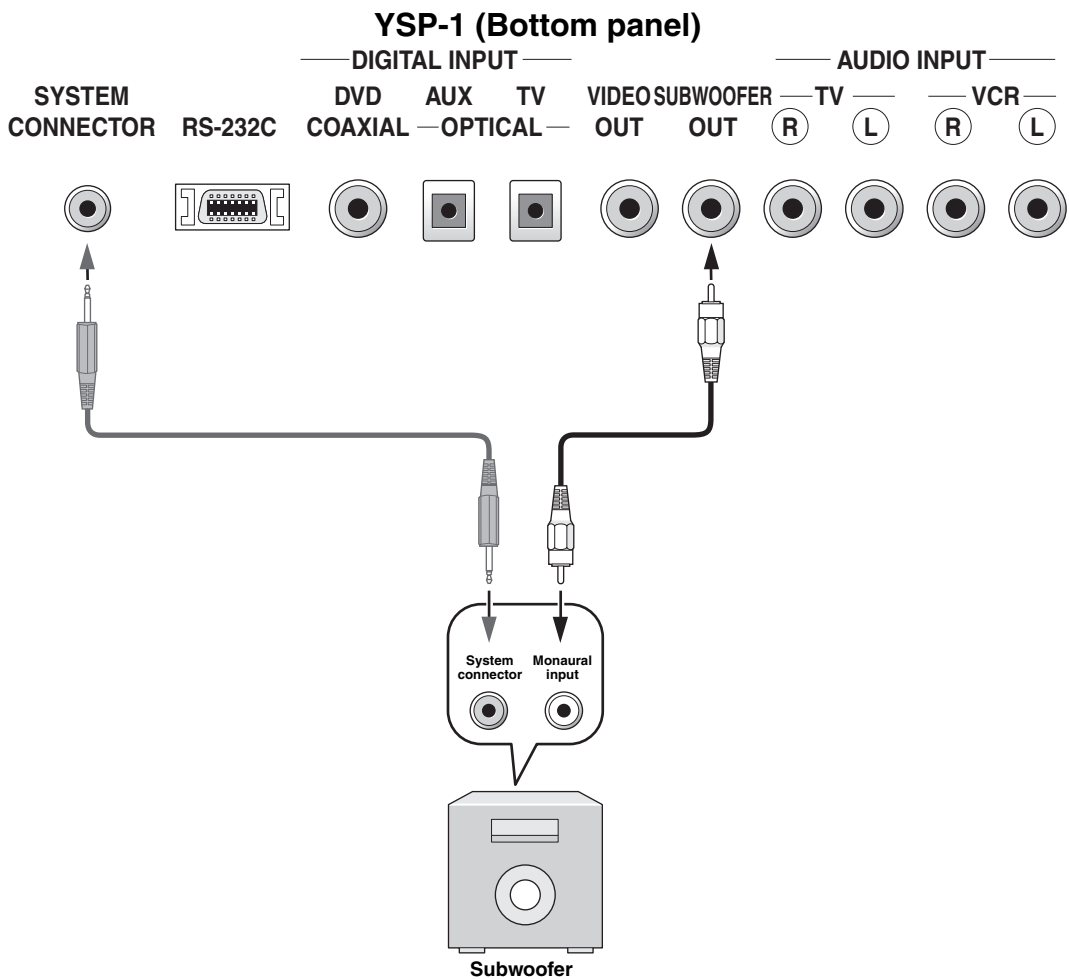

Connecting the power supply cable

■ Connecting the AC power cable

Once all other connections are complete, plug one end of the power cable into the AC IN terminal on this unit, then plug the other end into an AC wall outlet.

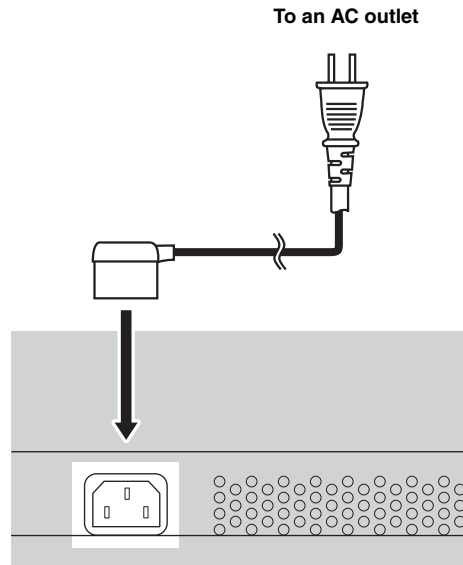

PREPARATION

About the RS-232C terminal

The RS-232C terminal on the bottom panel of this unit does not support normal external component connection. This is a control expansion terminal for commercial use only.

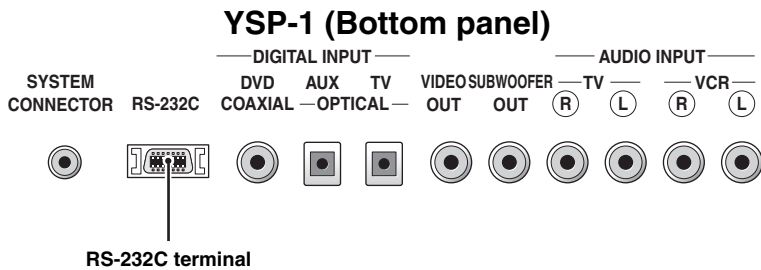

PREPARING THE REMOTE CONTROL

Installing batteries in the remote control

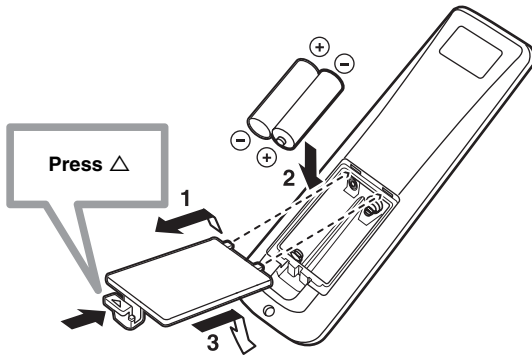

1 Press the \triangle mark on the battery cover and slide off the cover.

2 Insert the two supplied batteries (AA, R06, UM-3) into the battery compartment.

Make sure you insert the batteries according to the polarity markings (+/-).

3 Close the battery cover.

Notes on batteries

- Change all of the batteries if you notice the following conditions; the operation range of the remote control decreases, the indicator does not blink or its light becomes dim.
- Do not use old batteries together with new ones.
- Do not use different types of batteries (such as alkaline and manganese batteries) together. Read the packaging carefully as these different types of batteries may have the same shape and color.
- If the batteries have leaked, dispose of them immediately. Avoid touching the leaked material or letting it come into contact with clothing, etc. Clean the battery compartment thoroughly before installing new batteries.

If the remote control is without batteries for more than 2 minutes, or if exhausted batteries remain in the remote control, the contents of the memory may be cleared. When the memory is cleared, insert new batteries and reset the remote control codes. When changing the batteries, be careful not to press any of the buttons on the remote control. Doing so will clear the contents of the memory.

BASIC OPERATION

Using the remote control

The remote control transmits a directional infrared beam. Use the remote control within 6 m (20 feet) of this unit and point it toward the remote control sensor on the main unit during operation.

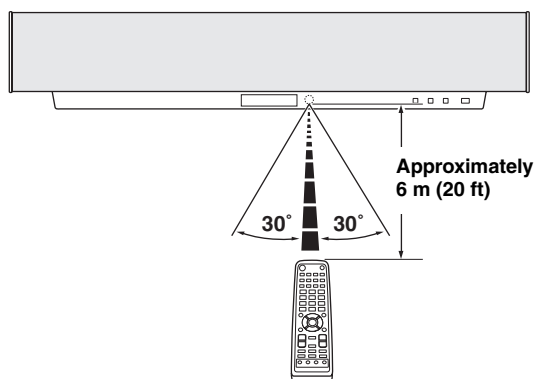

■ Handling the remote control

- Do not spill water or other liquids on the remote control.
- Do not drop the remote control.
- Do not leave or store the remote control in the following types of conditions:
 - places of high humidity, such as near a bath
 - high temperatures, such as near a heater or stove
 - extremely low temperatures
 - dusty places
- Do not expose the remote control sensor on the main unit to direct sunlight or lighting (inverted fluorescent lamps).
- If the batteries grow old, the effective operation distance of the remote control decreases considerably. If this happens, replace the batteries with two new ones as soon as possible.

Turning the power on/to standby mode

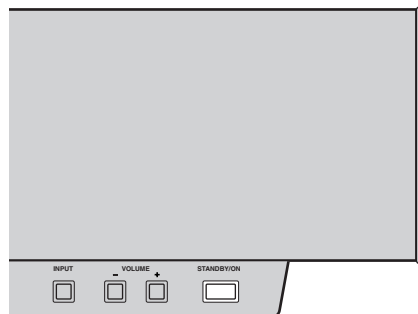

or

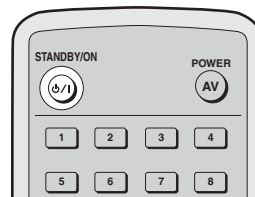

Press STANDBY/ON on the front panel or the remote control to turn this unit's power on/to standby mode.

This unit's power switches between on and standby mode each time STANDBY/ON is pressed.

STANDBY/ON



Front panel

or



Remote control

STEPS TO ENJOYING SURROUND SOUND

This section describes very simply how to display this unit's OSD on your TV screen and set the parameters for your listening room. Once this is complete, you can enjoy real surround sound while watching TV in the comfort of your own home.

Displaying the on-screen display (OSD)

Connect the video input jack on your TV to the VIDEO OUT jack on this unit to display this unit's OSD.

- 1 Press STANDBY/ON on the remote control.**
This unit's power is turned on.



- 2 Turn on the power to your TV.**

- 3 Press TV to display this unit's OSD on your TV screen.**

It may take a few seconds before this unit's OSD appears on your TV screen.

If the OSD does not appear, use the remote control provided with your TV to switch the video input until the OSD appears.

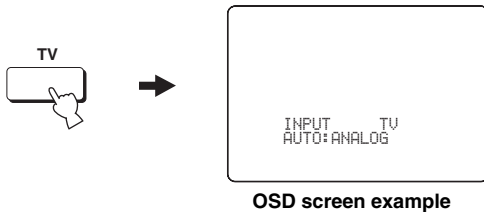

Other buttons that display the OSD

Remote control buttons that display the OSD	Page
1 NIGHT	33
2 SURROUND	32
3 CH LEVEL	49
4 Cursor buttons	-
5 TEST	48
6 MUTE	30
7 SLEEP	50
8 BEAM MODE	34
9 SET MENU	24
10 VOLUME +/-	30
11 Input selector buttons	31

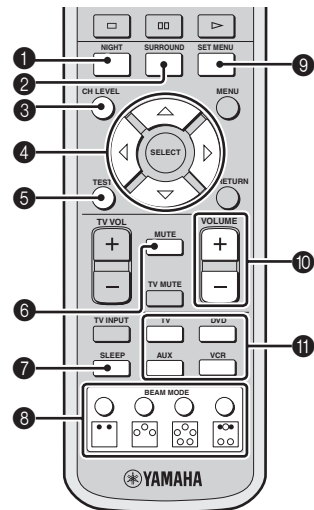

Selecting a preset listening environment

For real surround sound, select the preset listening room type (see below) that best matches your own listening environment.

If none of the selections available are suitable for your listening environment, proceed to EASY SETUP (page 24) to make your own listening environment settings.

■ Preset listening room types

USER1 (Central wall installation in a small room)

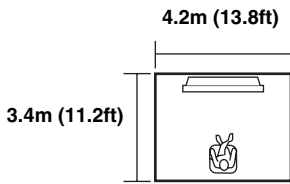

USER2 (Central wall installation in a medium-sized room)

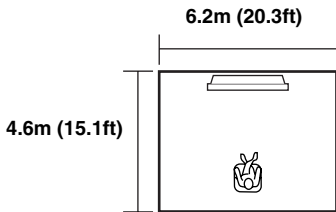

USER3 (Central wall installation in a large room)

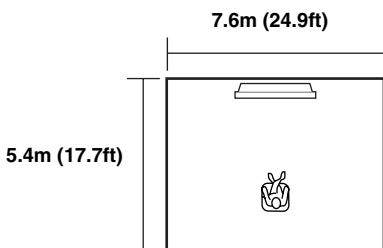

To resume cursor button operations after changing the control area by pressing an input selector button, press TEST on the remote control.



To return to the previous screen while using SET MENU, press RETURN on the remote control.



1 Press SET MENU.

The SET MENU screen appears on your TV. The operation buttons for SET MENU are displayed at the bottom of the screen.

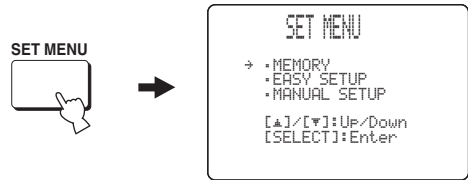

2 Press ▲ / ▼ to select MEMORY, then press SELECT.

The following screen appears on your TV.

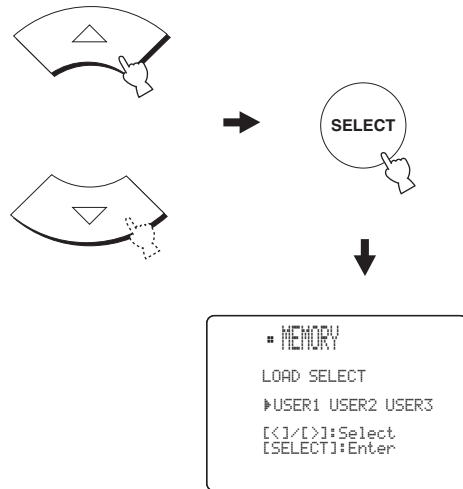

3 Press ◀ / ▶ to select the room type you want to set up, then press SELECT.

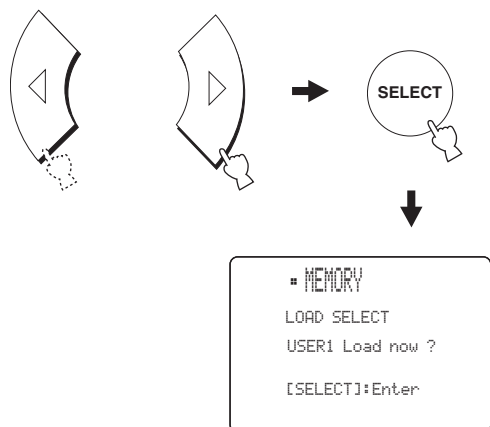

4 Press SELECT once more.

The parameters for the selected room type are loaded.



Once the parameters are loaded, the display returns to the following screen.



5 Press SET MENU.

The SET MENU screen disappears from your TV.



Enjoying TV in surround sound

You can enjoy analog audio signals output by your TV in real surround sound.



Before performing the steps below, set this unit's volume to -40 dB. If necessary, adjust the volume level in step 4 below.

1 Select the TV channel you want to watch.

To select a TV channel, use the remote control provided with your TV.

2 Press TV on this unit's remote control.

This unit outputs audio signals from your TV.



3 If you can hear sound from your TV speakers, reduce the volume level on your TV until you can no longer hear any audio being output.

To reduce the TV volume level, use the remote control provided with your TV.

4 To adjust the volume level, press VOLUME +/- on this unit's remote control.

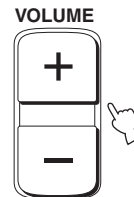

- 5 To select a surround mode, press SURROUND repeatedly (or press SURROUND, then press ◀ / ▶) on this unit's remote control.**

Signals input from 2-channel sources are played back on multiple channels.

For more information on surround modes, see page 32.

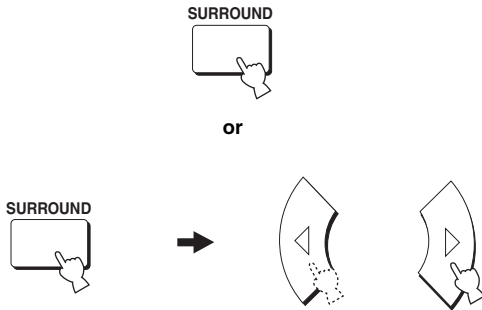

- To make more detailed listening environment settings, see page 24.
- To make advanced settings for this unit, see page 36.

EASY SETUP

If the preset listening environment settings available in “Selecting a preset listening environment” do not match the characteristics of your listening room, follow the procedure below to set each listening environment parameter individually using EASY SETUP.

ROOM TYPE > SP POSITION (Speaker position) > ROOM SIZE



- For speaker position, sound beam, digital input and display settings, see MANUAL SETUP (page 36).
- Items with a checkmark (*) appearing next to them may be displayed differently on your screen depending on your individual settings

Using EASY SETUP

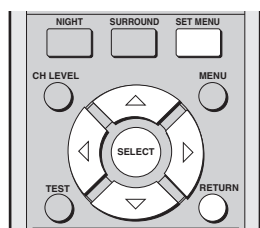

■ Displaying the SET MENU screen on your TV

You can display the SET MENU screen on your TV for easier viewing.

1 Press SET MENU.

The SET MENU screen appears on your TV.
The operation buttons for SET MENU are displayed at the bottom of the screen.



- To return to the previous screen while using SET MENU, press RETURN on the remote control.
- To resume cursor button operations after changing the control area by pressing an input selector button, press TEST on the remote control.
- To cancel the SET MENU screen, press SET MENU once more.
- You can also perform the following operation in the front panel display.
- If you press an input selector button during SET MENU operation, the cursor buttons become ineffective. In this case, press TEST once.

■ ROOM TYPE (Room type)

2 Check that the following screen is displayed on your TV.

If this screen is not displayed, press SET MENU.



3 Press ▲ / ▼ to select EASY SETUP, then press SELECT.

The following screen appears on your TV.

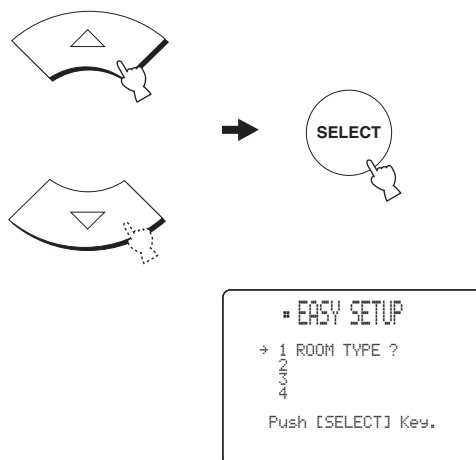

4 Press SELECT once more.

The display switches between the SQUARE and RECTANGLE selection screens.

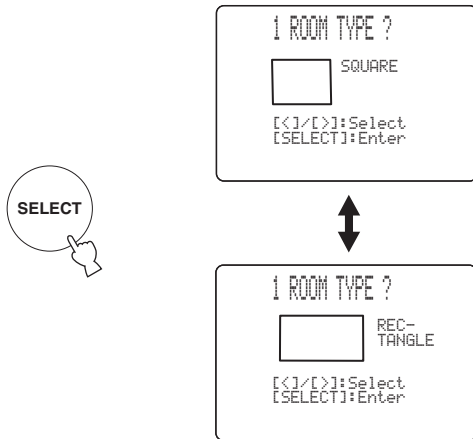
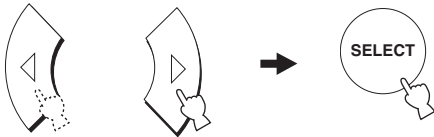
**5 Press ◀/▶ to select the desired setting, then press SELECT.**

Select the shape that best suits your listening room.

- Select SQUARE if the shape of your listening room is nearest to a square.
- Select RECTANGLE if the shape of your listening room is nearest to a rectangle.

If the shape of your listening room is irregular, select the shape that most closely resembles your room.

In Example 1, the shape that best describes the listening room is RECTANGLE. In Example 2, it is SQUARE.

Example 1:
Rectangular
room

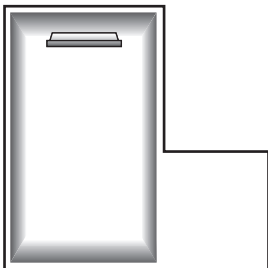

Example 2:
Square
room

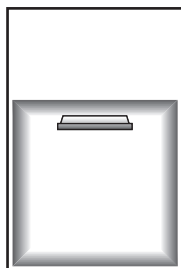

Proceed to “SP POSITION (Speaker position)”.

■ SP POSITION (Speaker position)**6 Check that the following screen is displayed on your TV.**

If this screen is not displayed, make the settings in “ROOM TYPE (Room type)”.

**7 Press SELECT.**

If you selected SQUARE for ROOM TYPE (Room type) (page 24), the four SQUARE room types are displayed as shown on page 26

If you selected RECTANGLE, eight different RECTANGLE room types are displayed

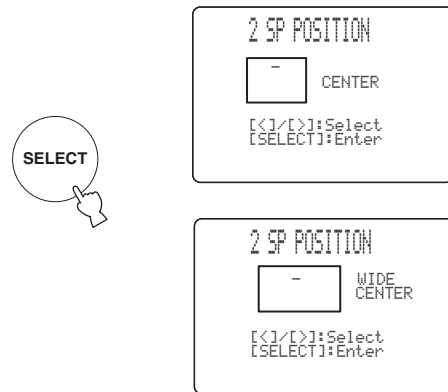
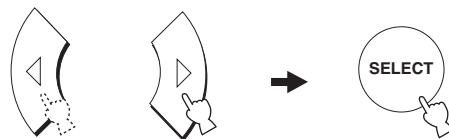
**8 Press ◀/▶ to select the position type that best suits the installation location of this unit, then press SELECT.**

Proceed to “ROOM SIZE (Room size)”.

SQUARE (Square)

If you selected SQUARE in "ROOM TYPE (Room type)" on page 24:

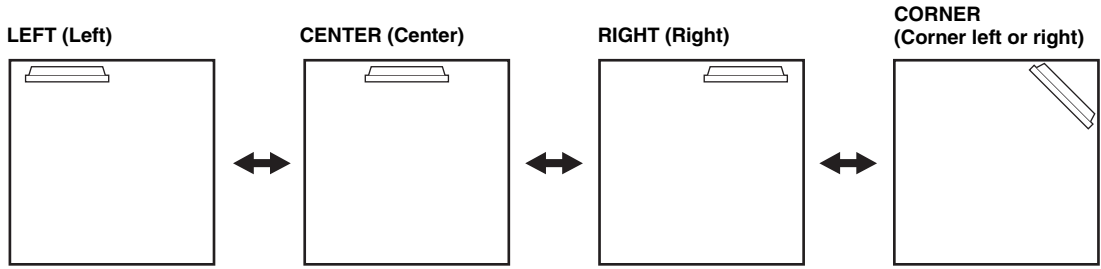

RECTANGLE (Rectangle)

If you selected RECTANGLE in "ROOM TYPE (Room type)" on page 24:

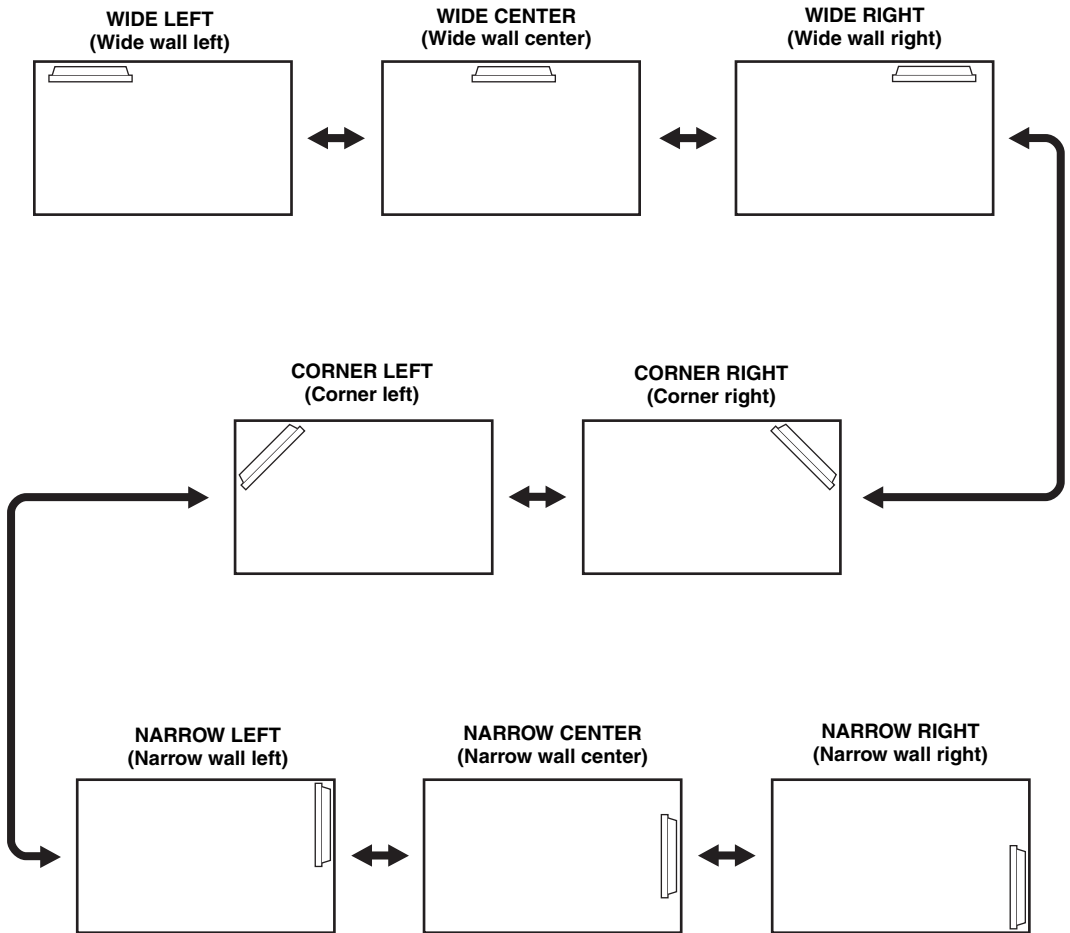

ROOM SIZE (Room size)

9 Check that the following screen is displayed on your TV.

If this screen is not displayed, make the settings in "SP POSITION (Speaker position)".



11 Press ◀/▶ to select the size that best suits your listening room, then press SELECT.

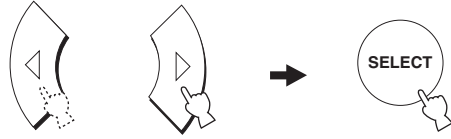

Proceed to "SETUP OK (Register settings)".

10 Press SELECT.

If you selected SQUARE in ROOM TYPE (Room type) (page 24), SMALL, MID and LARGE are displayed.

If you selected RECTANGLE, SMALL, MID and LARGE are displayed.

When SQUARE is selected



When RECTANGLE is selected

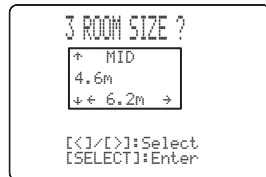

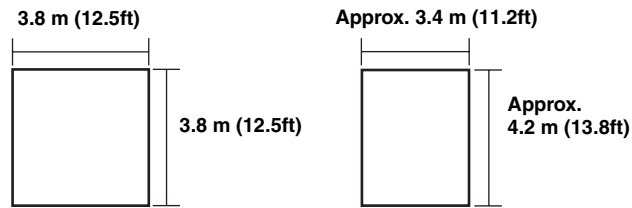
SMALL (Small listening room)

- Select SMALL if both the width (W) and depth (D) of your listening room are 3.8 m (12.5ft), or the width (W) is approximately 3.4 m (11.2ft) and the depth (D) approximately 4.2 m (13.8ft).

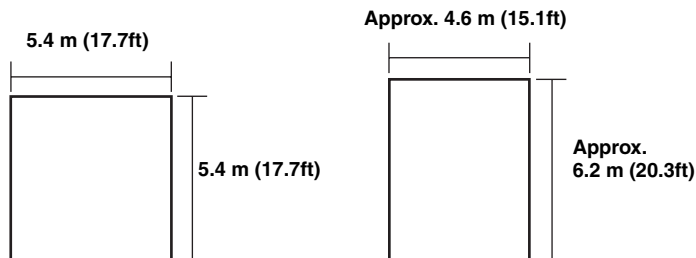
MID (Medium-sized listening room)

- Select MID if both the width (W) and depth (D) of your listening room are 5.4 m (17.7ft), or the width (W) is approximately 4.6 m (15.1ft) and the depth (D) approximately 6.2 m (20.3ft).

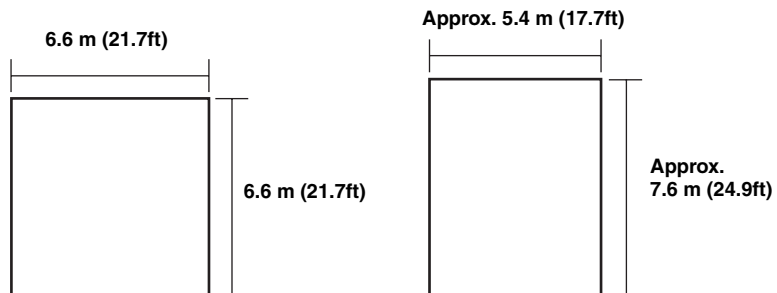
LARGE (Large listening room)

- Select LARGE if both the width (W) and depth (D) of your listening room are 6.6 m (21.7ft), or the width (W) is approximately 5.4 m (17.7ft) and the depth (D) approximately 7.6 m (24.9ft).

■ SETUP OK (Register settings)

12 Check that the following screen is displayed on your TV.

If this screen is not displayed, make the settings in "ROOM SIZE (Room size)".



13 Press SELECT.

The following screen appears.

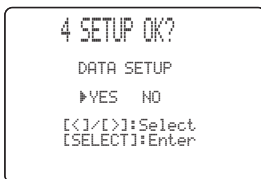

14 Press </> to select YES or NO, then press SELECT.

- YES:** To register the settings if they are satisfactory.
NO: To cancel the settings and return to the initial SET MENU screen.

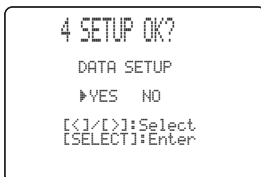

- If you select YES, the following screen appears, and your EASY SETUP settings are registered.



- If you select NO, your EASY SETUP settings are cancelled, and the display returns to the initial SET MENU screen.



- To return to the previous screen, press RETURN.

15 Press SET MENU to complete the SET MENU procedure.



The OSD disappears from your TV screen.

This completes the parameter settings for EASY SETUP. To select a playback source and enjoy surround sound on this unit, see "Selecting an input source" on page 31.

VOLUME CONTROLS

Adjusting the volume

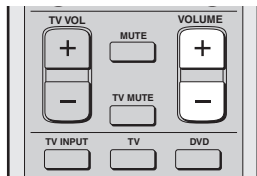
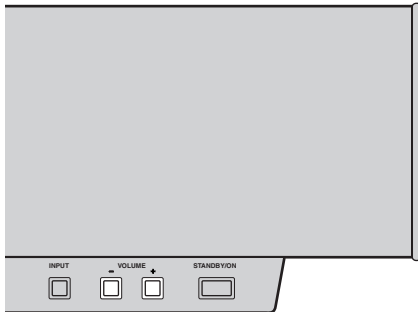

To increase the volume output level, press **VOLUME +/-**.

Adjustment range: 0.0 dB to -99.5 dB, MUTE (mute)

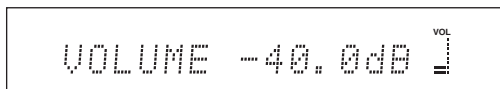
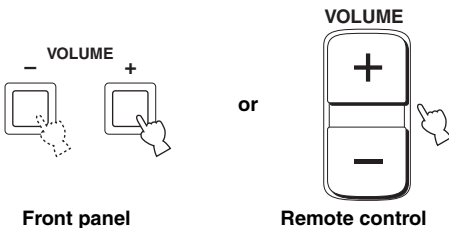

Muting the sound

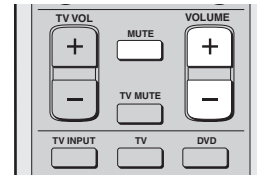

Press **MUTE**.

“AUDIO MUTE ON” appears in the front panel display, and the VOLUME indicator blinks.

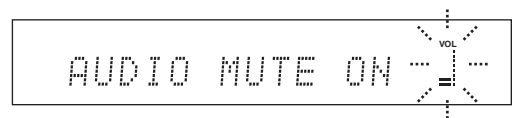
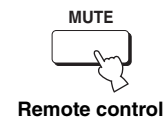

To resume the audio output, press MUTE again (or press VOLUME +/-).



You can adjust whether the output volume is muted completely or by 20 dB when you press MUTE (see page 39).

PLAYBACK

Selecting an input source

You can playback sound and/or images from the various components connected to this unit simply by pressing one of the input selector buttons (TV, DVD, VCR or AUX) on the remote control.

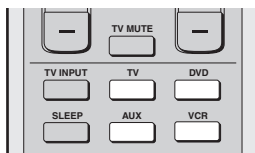

To playback a TV program

Press TV.

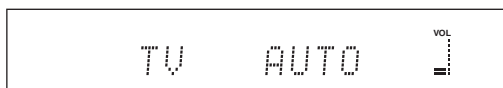

To playback a DVD

Press DVD.

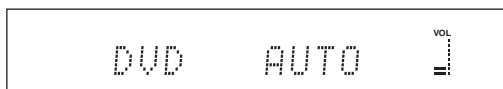

To playback a video tape

Press VCR.



To playback a component connected to the AUX jack

Press AUX.

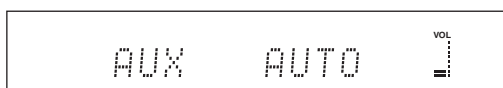

Playing back sources

This section uses a DVD player as the playback component (source).



For details on the TV and DVD player you are using, refer to the owner's manual supplied with your TV and DVD player.

- 1 Turn on the power to your DVD player using the supplied remote control.
- 2 Switch the video input on your TV using the supplied remote control until the screen for your DVD player is displayed.
- 3 If necessary, turn down the volume of your TV until you cannot hear any sound.
- 4 Press DVD on the remote control.
The playback source for this unit switches to DVD.



- 5 Playback the DVD on your DVD player using the supplied remote control.

Audio signals from your DVD player are output from this unit's speakers.



- If the output volume is too low, increase the volume on this unit to around -25 dB.
- If you have set remote control codes for your TV and DVD player, you can use this unit's remote control to operate these components. For details on how to set remote control codes, see page 51.

SELECTING A SURROUND MODE

Playback sources and their available surround modes

Depending on the playback source and selected surround mode, the indicators in the front panel display light up as follows.

During CD playback:

PCM

During DTS Digital signal input or when DTS Neo:6 is selected:

dts

During Dolby Digital signal input:

DIGITAL

When Dolby Pro Logic is selected:

PL

When Dolby Pro Logic II is selected:

PL II



You can select the type of input signal by pressing an input selector button (see page 47).

Enjoying 2-channel sources with multi channels

You can enjoy a variety of surround sound effects by switching the surround mode, including multi-channel decoding for 2-channel sources, and 5.1-channel playback

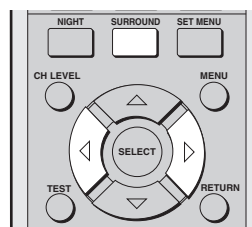

Press **SURROUND** repeatedly (or press **SURROUND**, then press **◀/▶**).



or

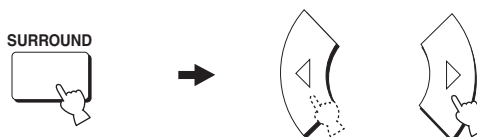

Surround Modes and Recommended Usages

Surround mode		Recommended source
Dolby Pro Logic	–	All sources
Dolby Pro Logic II	Movie Music Game	Movies Music Games
DTS Neo:6	Cinema Music	Movies Music

Surround mode parameters

You can configure the parameters for Dolby Pro Logic II Music and DTS Neo:6 Music to fine-tune the surround sound effect.

1 Press \triangle/∇ to select the parameter.

2 Press $\triangleleft/\triangleright$ to configure the parameter.

PANORAMA (when selecting PLII Music)

Gives front L/R channel sound a wraparound effect, distributed throughout the entire surround sound field, for an expansive feeling.

Choices: ON/OFF (Default: OFF)

DIMENSION (when selecting PLII Music)

Adjusts the difference in volume between front and surround channels to the volume balance you desire.

Variable range: -3 (toward the surround direction) to +3 (toward the front direction) (Default: STD)

CENTER WIDTH (when selecting PLII Music)

Distributes the center channel sound to the left and right. If set to 0, center channel sounds output only from the center speaker.

Variable range: 0 to 7 (Default: 3)

C. IMAGE (when selecting DTS Neo:6 Music)

Adjusts the center image from three speakers (front and center) to varying degrees.

Variable range: 0.0 (wider) to 0.5 (toward the center) (Default: 0.2)

ADDITIONAL PLAYBACK MODES

Night listening modes

The night listening modes are designed to improve listenability at lower volumes or at night. Choose either NIGHT:CINEMA or NIGHT:MUSIC depending on the type of material you are playing.

Press NIGHT on the remote control repeatedly to select cinema or music.

When night listening is selected, the **NIGHT** indicator in the front panel display lights up.



- Select NIGHT:CINEMA when watching films to reduce the dynamic range of film soundtracks and make dialog easier to hear at lower volumes.
- Select NIGHT:MUSIC when listening to music sources to preserve ease-of-listening for all sounds.
- Select OFF if you do not want to use this function.

Press $\triangleleft/\triangleright$ to adjust the effect level while NIGHT:CINEMA or NIGHT:MUSIC is displayed.

This adjusts the level of compression.

Effect.Lvl: MID

- Select MIN for minimum compression.
- Select MID for standard compression.
- Select MAX for maximum compression.

ADJUSTING BEAM MODE SETTINGS

You can change the beam mode to suit the input source for this unit using the beam mode buttons. You can switch between: stereo mode for 2-channel sources, 3 beam mode and 5 beam mode and ST(STEREO)+3 beam mode for 5.1-channel playback.

If you selected a wall installation type (instead of corner) for this unit in EASY SETUP – SP POSITION (page 25), or you selected wall for MANUAL SETUP – SP POSITION (page 40), all modes are available for selection.

If you selected a corner installation type (instead of wall) for this unit in EASY SETUP – SP POSITION (page 25), or you selected CORNER for MANUAL SETUP – SP POSITION (page 40), only the stereo and ST(STEREO)+3 beam modes can be selected.

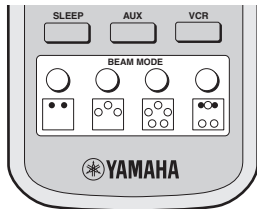

Stereo mode

Outputs audio from the front left and right speakers. This mode is ideal for playing back hi-fidelity sources, such as CDs, and should be used to replace your TV speakers. When playing multi-channel sources, all signals except those for the front left and right speakers are mixed down and output from the front left and right speakers. You can select surround mode during beam mode, but surround mode becomes disabled when stereo mode is selected.

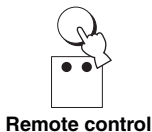

Remote control

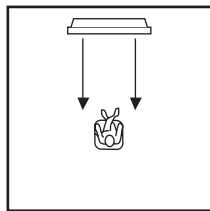

3 beam mode

Outputs audio from the front left, center and front right speakers. Because the listening position area is widened when signals are output to the front speaker positions only, you can enjoy excellent quality surround sound over a wider area. This mode is ideal when you want to enjoy movies with the whole family. When playing multi-channel sources, surround left and right signals are mixed down and output to the front left and right speaker positions.

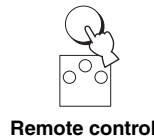

Remote control

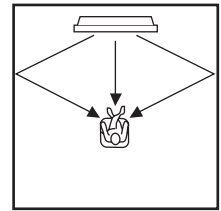

5 beam mode

Outputs audio signals from the front left and right, center, and surround left and right speakers. This mode is ideal for enjoying surround sound effects to the fullest when watching movie DVDs recorded in a multi-channel format or playing back 2-channel sources in a multi-channel format. To achieve to best surround sound effect, make sure that there are no objects placed in the path of sound beams that may prevent the beams from rebounding directly off your listening room wall. The front left and right sound beams are output towards the wall.

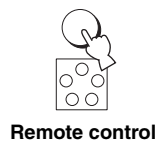

Remote control

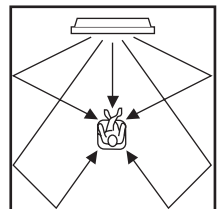

ST(STEREO)+3 beam mode

Outputs sound beams to the front left and right, center, and surround left and right speaker positions. This mode is ideal when watching live recordings on DVD.

Vocals and instrumental sounds can be heard close to the center of the listening position, while sound reflections from the venue itself can be heard to your right and left, giving you the feeling that you are sitting right in front of the stage.

The front left and right sound beams are output directly at the listening position.



Remote control

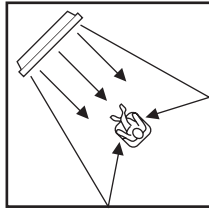
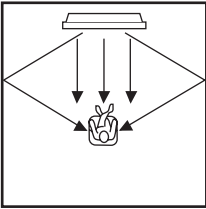

MANUAL SETUP

To achieve the best quality surround sound, you can use **MANUAL SETUP** to fine-tune the listening environment parameters, as well as make advanced settings for speaker positions, sound beams, digital input and the OSD. Change the initial settings (indicated in bold under each parameter) to reflect the needs of your own listening environment.



Most of the parameters described in **SOUND MENU** are set automatically when you perform **EASY SETUP** (see page 24). Use **SOUND MENU** to make additional adjustments.

SOUND MENU

Item	Features	Page
SUBWOOFER SET	Customizes the various subwoofer settings.	38
SPEAKER LEVEL	Adjusts the output level of each speaker.	38
DYNAMIC RANGE	Adjusts the dynamic range for Dolby Digital or DTS signals.	39
AUDIO SET	Customizes the muting level and audio delay.	39
TONE CONTROL	Adjusts the output level of high-frequency or low-frequency sound.	39

BEAM MENU

Use to manually adjust listening room parameters or alter the quality and tone of the sound output by this unit.

Item	Features	Page
PARAMETER	Customizes listening room and listening position settings.	40
BEAM ADJ	Adjusts the various beam settings.	41
ROOM EQ	Adjusts the tonal quality of the listening room.	42
BEAM TONE	Adjusts the output level of high-frequency or low-frequency sound for each speaker.	42
IMAGE LOCATION	Adjusts the position of the front left and right speakers.	43
MEMORY	Saves and calls up setting contents.	43

INPUT MENU

Use to reassign digital input/outputs and select the input mode.

Item	Features	Page
INPUT ASSIGNMENT	Assigns jacks according to the component to be used.	44
INPUT MODE	Selects the initial input of the source.	44
INPUT RENAME	Renames the displayed input source.	44

OPTION MENU

Use to adjust the optional system parameters.

Item	Features	Page
DISPLAY SET	Adjusts the brightness of the display and OSD.	45
UNIT SET	Changes the display unit of measurement.	46



BEAM MENU allows you to make surround sound effects settings normally available in the speaker settings menu.

Using SET MENU

Use the remote control to access and adjust each parameter.

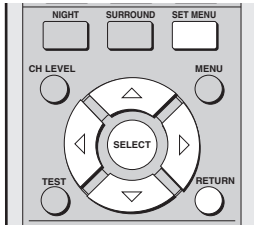

You can change SET MENU parameters while the unit is reproducing sound.

1 Press SET MENU.

The SET MENU screen appears on your TV.
The operation buttons for SET MENU are displayed at the bottom of the screen.

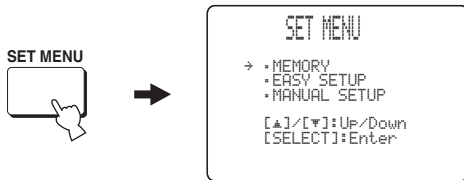

2 Press ▲ / ▼ to select MANUAL SETUP, then press SELECT.

The following screen appears on your TV.

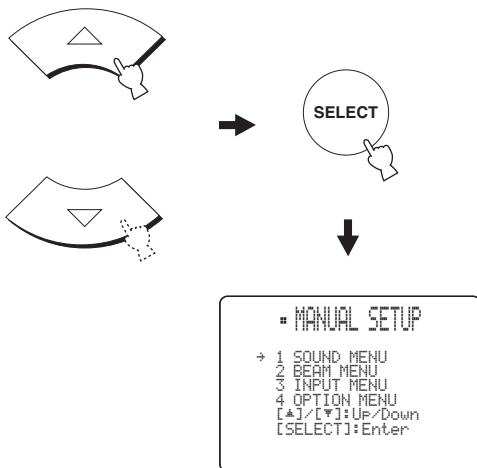

3 Press ▲ / ▼ to select a sub menu, then press SELECT.

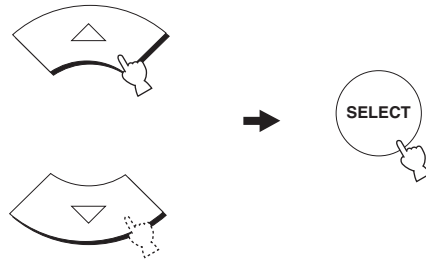

4 Use ▲ / ▼ / ◀ / ▶ and SELECT to configure each parameter.

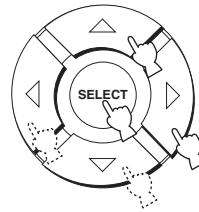

5 To exit, press SET MENU when finished.



The OSD disappears from your TV screen

SOUND MENU

Use the manually adjust any speaker setting or compensate for video signal processing delays.

(SET MENU → MANUAL SETUP → SOUND MENU)

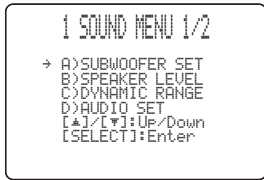

■ SUBWOOFER SET (Subwoofer set)

Use to manually adjust subwoofer settings.

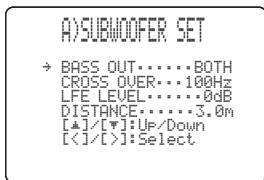

BASS OUT (Bass out)

Low-frequency (bass) signals can be directed to the subwoofer and/or the front left and right speaker positions. This setting also determines the routing of LFE (low-frequency effect) signals found in Dolby Digital or DTS sources.

Choices: SWFR (subwoofer), FRONT, **BOTH**

Initial setting: BOTH

- Select SWFR if you connect a subwoofer. LFE and low-frequency signals from other channels are directed to the subwoofer according to the speaker settings.
- Select FRONT if you do not use a subwoofer. LFE and low-frequency signals from other channels are directed to the front speakers according to the speaker settings (even if you have previously set the front speakers to SMALL).
- Select BOTH if you connect a subwoofer and you want to output low-frequency signals from front channels to both the front speakers and subwoofer. LFE and low-frequency signals from other channels are also directed to the subwoofer according to the speaker settings. Use this function to reinforce low-frequency signals using the subwoofer when playing back sources such as CDs.

CROSS OVER (Cross over)

When BASS OUT is set to SWFR, you can use this feature to select a cross-over (cut-off) frequency for all low-frequency signals. All frequencies below the selected frequency will be sent to the subwoofer speaker position. Choices: 80Hz, **100Hz**, 120Hz

LFE LEVEL (Low-frequency effect level)

Select to adjust the output level of the LFE (low-frequency effect) channel according to the capacity of your subwoofer. The LFE channel carries low-frequency special effects which are only added to certain scenes.

This setting is effective only when this unit decodes Dolby Digital or DTS signals.

Choices: -20 to **0** dB

DISTANCE (Distance)

Select to adjust the distance of the subwoofer from the listening position.

Choices: 0.3 to 15.0 m (1 to 50 ft)

Initial setting: 3.0 m (10 ft)

■ SPEAKER LEVEL (Speaker level)

You can manually balance the speaker levels between the front left or surround left speakers and each speaker selected.

When setting the front right, center or surround left speakers or the subwoofer, the test tone is output from the front left speakers and the selected speaker position. When setting the surround right speaker, the test tone is output alternately from the surround left and right speakers.

When PARAMETER is adjusted in EASY SETUP or MANUAL SETUP, the factory default value is automatically set for this parameter.

Depending on beam mode settings, some channels may not be available for selection.

In this case, "NONE" is displayed.

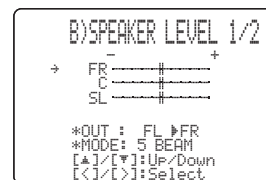

- **FR** adjusts the balance of the front left and front right speakers.
- **C** adjusts the balance of the front left and center speakers.
- **SL** adjusts the balance of the front left and surround left speakers.
- **SR** adjusts the balance of the surround left and surround right speakers.
- **SWFR** adjusts the balance of the front left speaker and subwoofer.

■ DYNAMIC RANGE (Dynamic range)

Use to select the amount of dynamic range compression to be applied to the speakers. This setting is effective only when the unit is decoding Dolby Digital and DTS signals. Dynamic range is the difference between the smallest sound that can be heard above the noise of the equipment and the biggest sound that can be heard without distortion.

Choices: MIN (minimum), STD (standard),

MAX (maximum)



Select to adjust the speaker compression.

- Select MIN for listening to sources at low volume levels.
- Select STD for general use.
- Select MAX for feature films.

■ AUDIO SET (Audio set)

Use to customize this units overall audio settings.



MUTE LEVEL (Muting level)

Use to adjust how much the mute function reduces the output volume.

Choices: **MUTE**, -20 dB

- Select MUTE to completely halt all output of sound.
- Select -20 dB to reduce the current volume by 20 dB.

AUDIO DELAY (Audio delay)

Use to delay the sound output and synchronize it with the video image. This may be necessary when using certain LCD monitors or projectors.

Choices: **0** to 160 ms

■ TONE CONTROL (Tone control)

You can adjust the tonal quality of your speakers.



TREBLE (Treble)

Use to adjust the high frequency response.

Choices: -12 dB to +12 dB

Initial setting: 0 dB

BASS (Bass)

Use to adjust the low frequency response.

Choices: -12 dB to +12 dB

Initial setting: 0 dB

BEAM MENU

Use to manually adjust settings for the beams output by this unit.

When you set the options in PARAMETER, related settings are automatically adjusted to suit your listening environment.

(SET MENU → MANUAL SETUP → BEAM MENU)

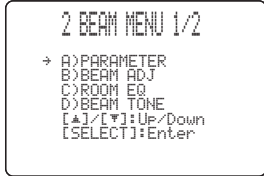

■ PARAMETER (Parameter settings)

Use to set the position of this unit in your listening room and the distance of this unit from the listening position.



SP POSITION (Speaker position)

Use to adjust the installation position of your speakers.
 Choices: **WALL** (wall), **CORNER** (corner)

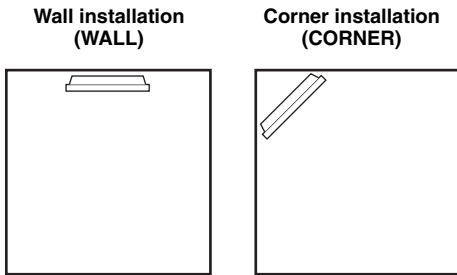

SP HEIGHT (Speaker height)

Use to adjust the height of this unit from the floor.
 Choices: 0 m to 3.0 m (0 ft to 10.0 ft)
 Initial setting: 1.0 m (3.5 ft)

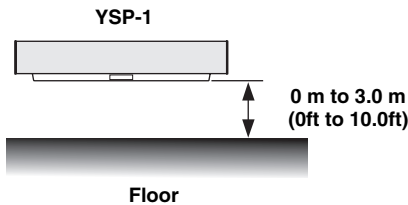

ROOM WIDTH (LEFT WALL)

(Width of listening room left wall)

If SP POSITION is set to WALL, use this to set the width of your listening room.

If SP POSITION is set to CORNER, use this to set the length of the wall in front and to the left of the listening position.

When you set the SP POSITION parameter in EASY SETUP (page 25) or MANUAL SETUP (page 40), this item is automatically set to the factory default value.
 Choices: 2.0 m to 12.0 m (6.5 ft to 40.0 ft)

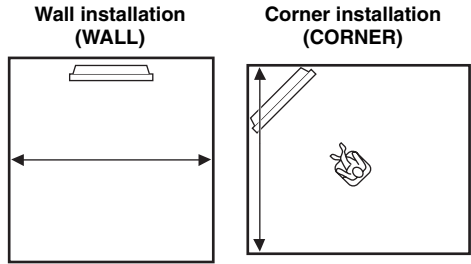

ROOM LENGTH (RIGHT WALL)

(Length of listening room right wall)

If SP POSITION is set to WALL, use this to set the distance from the speaker to the rear wall of your listening room.

If SP POSITION is set to CORNER, use this to set the length of the wall in front and to the right of the listening position.

When SP POSITION is adjusted in EASY SETUP (page 25) or MANUAL SETUP (page 40), the factory default value is automatically set for this parameter.
 Choices: 2.0 m to 12.0 m (6.5 ft to 40.0 ft)

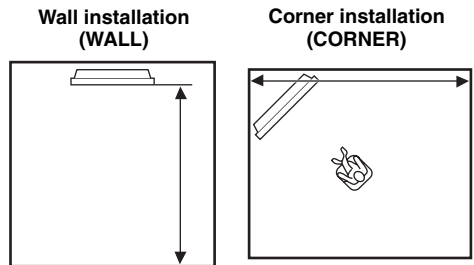

USER POSITION (User position)

Use to set the distance of the listening position from this unit.

Choices: 2.0 m to 9.0 m (6.5 ft to 30.0 ft)

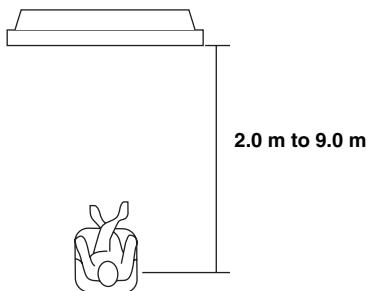

TO L WALL (Listening position to left wall)

If SP POSITION is set to WALL, use to set the distance of the center of this unit from the left wall.

Choices: 0.6 m to 11.4 m (2.0 ft to 38.0 ft)

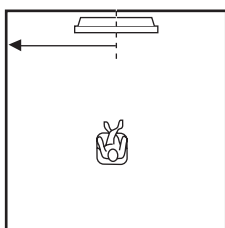

■ BEAM ADJ (Beam adjustment)

Use to manually adjust the various speaker beam angles. We recommend that you select 5 beam mode before adjusting these parameters.

When SP POSITION is adjusted in EASY SETUP (page 25) or MANUAL SETUP (page 40), the factory default value is automatically set for this parameter (except when FOCAL LENGTH is set to CENTER). Depending on the beam mode settings (page 34), some speaker positions may not be available for selection. In this case, “-” is displayed. When using ST(STEREO)+3 beam mode, set the surround left and right signals to be output from the front left and right speakers.

```

B>BEAM ADJ
→ a>HORIZ. ANGLE
   b>VERTICAL ANGLE
   c>DISTANCE
   d>FOCAL LENGTH
   [▲]/[▼]: UP/Down
   [SELECT]: Enter
    
```

HORIZ. ANGLE (Horizontal angle)

Use to adjust the horizontal angle of beams for each speaker.

Adjust towards – (minus) to move the direction of the output to the left, and adjust towards + (plus) to move it to the right.

By adjusting the horizontal angle of the beams, you can optimize the sound beam paths.

A test tone is automatically output.

Choices: -90° to +90°

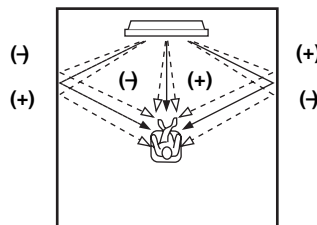

VERTICAL ANGLE (Vertical angle)

Use this to adjust the vertical angle of beams for each speaker.

Adjust towards – (minus) to move the angle downward, and adjust towards + (plus) to move the angle upward. By altering the beam path, you can optimize sound beam angles.

A test tone is automatically output.

Choices: -90° to +90°

Initial setting: 0

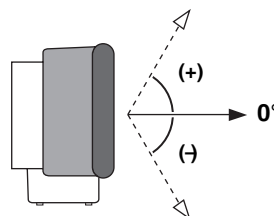

DISTANCE (Distance)

You can use this to set the distance beams travel after being output and reflected off the wall, until they arrive at the listening position for each speaker.

The lines in the illustration below indicate the distance.

Choices: 0.3 m to 24.0 m (1.0 ft to 80.0 ft)

- **FRONT L/R** adjusts the distance the front left and right speaker sound beams travel.
- **CENTER** adjusts the distance the center speaker sound beams travel.
- **SURROUND L/R** adjusts the distance the surround left and right speaker sound beams travel.

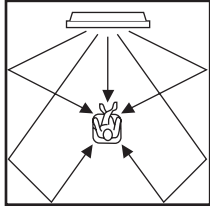

FOCAL LENGTH (Focal length)

Use this to set the distance from the front of this unit to the focal point of output for each speaker.

Adjust towards – (minus) to move the focus outward, and adjust towards + (plus) to move the focus towards the normal position.

We recommend that you use the initial setting (–0.5 m) for the center speaker.

Choices: –1.0 m to +13.0 m (–3.5 ft to +43.5 ft)

- **FRONT L/R** adjusts the focal length for the front left and right sound beams.
- **CENTER** adjusts the focal length for the center sound beams. Initial setting: –0.5 m (–1.5 ft)
- **SURROUND L/R** adjusts the focal length for the surround left and right sound beams.

Example:

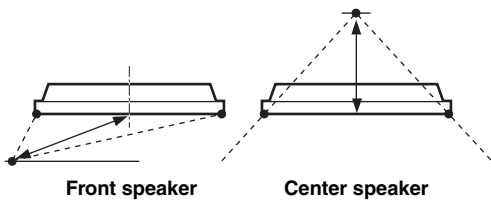

■ **ROOM EQ (Room equalizer)**

You can use this to change the tonal qualities of your listening room when the unit is mounted on the wall.

Choices: STANDARD (standard), LIVE (live), WALL MOUNT (wall mount)



STANDARD (Standard)

Select if your listening room has normal reflectivity.

LIVE (Live)

Select if your listening room has highly reflective surfaces, such as concrete walls.

WALL MOUNT (Wall mount)

Select to enhance medium to low range sounds when this unit is mounted on your listening room wall with a metal wall bracket, etc. close to the wall.

■ **BEAM TONE (Beam tone)**

You can adjust the high and low frequency levels for each speaker.

Choices: –12.0 dB to +12.0 dB

Initial setting: 0 dB



- **Front L TREBLE** adjusts the high frequency output level of the front left speaker.
- **Front L BASS** adjusts the low frequency output level of the front left speaker.
- **Front R TREBLE** adjusts the high frequency output level of the front right speaker.
- **Front R BASS** adjusts the low frequency output level of the front right speaker.
- **Center TREBLE** adjusts the high frequency output level of the center speaker.
- **Center BASS** adjusts the low frequency output level of the center speaker.
- **Surround L TREBLE** adjusts the high frequency output level of the surround left speaker.
- **Surround L BASS** adjusts the low frequency output level of the surround left speaker.
- **Surround R TREBLE** adjusts the high frequency output level of the surround right speaker.
- **Surround R BASS** adjusts the low frequency output level of the surround right speaker.

※ If the reflection point of the front left/right or surround left/right sound beams is a curtain or other acoustically absorbent surface, you can achieve more effective surround sound by increasing the treble level for those sound beams.

IMAGE LOCATION (Image location)

You can adjust the direction from which front left and right speaker sound is heard by directing these audio signals so that they are also output from the center speaker.

Use this feature to redirect audio signals if the sound coming from the left and right speakers seems unnatural, such as when your listening position is not the center of your listening room.

You can only adjust this parameter when 3 beam mode or 5 beam mode is selected.

Choices: ON, OFF

Setting range: 0% to 95%

Initial setting: 0%

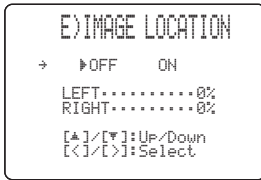

LEFT (Left)

Adjusts audio signals towards the left.

The higher the percentage, the louder the output from the center.

RIGHT (Right)

Adjusts audio signals towards the right.

The higher the percentage, the louder the output from the center.

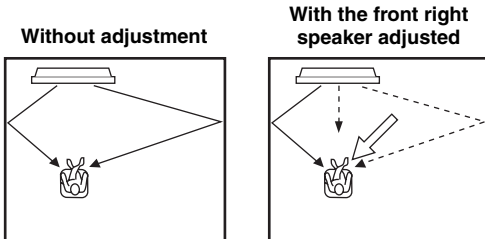

MEMORY (User memory)

Saves and loads setting contents for SET MENU.

For example, if there are curtains in the path of beams, the effectiveness of the beams will vary depending on whether the curtains are open or closed.

In this case, it is handy to save settings according to the conditions of your listening room.

Choices: USER1, USER2, USER3

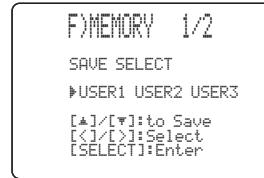

SAVE (Save)

Saves settings in this unit's memory. (The listening environments set as the factory default settings will be erased.)

LOAD (Load)

Loads memory settings. Initially, three listening environments are set as the factory default settings. For details, see page 57.

When the curtains are open

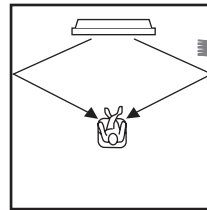

When the curtains are closed

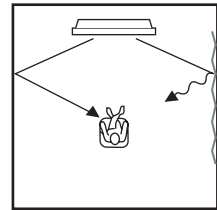

INPUT MENU

Use to reassign digital input from external components connected to this unit.

(SET MENU → MANUAL SETUP → INPUT MENU)

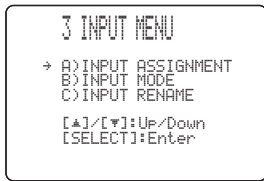

INPUT ASSIGNMENT (Input assignment)

You can assign the optical and coaxial digital input jacks of this unit to other components if this unit's initial settings do not correspond to your needs. By assigning other components to the input jacks on this unit, you can display the name of the connected component in the front panel display and OSD (see page 20), and operate the component with the input selector button of the same name. If you connect a component to this unit's input jacks and do not assign it, the default component name for that input jack is displayed in the front panel and OSD when selected.

- **OPTICAL IN(1)** assigns components to the TV OPTICAL IN jack of this unit.
Choices: **TV**, **VCR**

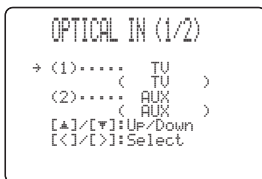

- **OPTICAL IN(2)** assigns components to the AUX OPTICAL IN jack of this unit.
Choices: **AUX**, **DVD**
- **COAXIAL IN(3)** assigns components to the COAXIAL IN jack of this unit.
Choices: **DVD**, **AUX**

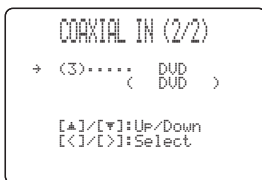

INPUT MODE (Input mode)

Use this feature to designate the input mode for sources connected to the DIGITAL INPUT jacks when you turn on this unit. For information on the types of audio signals that can be output by this unit, see "Surround Modes and Recommended Usages" on page 32.

Choices: **AUTO**, **LAST**



- Select **AUTO** to allow this unit to automatically detect the type of input signal and select the appropriate input mode.
- Select **LAST** to set this unit to automatically select the last input mode used for that source. If the type of input signal is different from the setting, no sounds will be produced.)

INPUT RENAME (Input rename)

Use this feature to change the name of the inputs on the OSD and front panel display. Press an input selector button (TV, DVD, VCR, or AUX) to select the component you want to change the name for, then perform the following procedure.



1 Press TEST.



2 Press ◀/▶ to place the _ (underbar) under the space or the character you want to edit.

The _ (underbar) blinks.

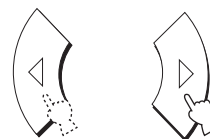

3 Press \triangle / ∇ to select the character you want.

- You can use up to 8 characters for each input.
- Press ∇ to change the character in the following order, or press \triangle to go in the reverse order:
A to Z, a space, 0 to 9, a space, a to z, a space, #, *, +, etc.

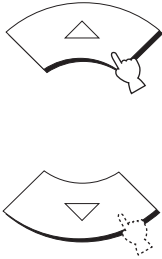

4 Repeat steps 1 and 2 to rename each input.

5 To exit, press SELECT when finished.

The new name(s) are registered, and the display returns to the previous screen.



OPTION MENU

You can use this menu to adjust the optional system parameter, such as OSD settings and the display unit of measurement.

(SET MENU → MANUAL SETUP → OPTION MENU)



■ DISPLAY SET (Display settings)

Use to adjust the brightness of the front panel display.



STANDARD DIMMER (Standard dimmer)

Use to adjust the brightness of the front panel display when this unit is operated via the front panel or remote control.

Choices: -2, -1, **OFF**

AUTO DIMMER (Auto dimmer)

If no operation is performed for a specified period, the front panel display dims. Use to adjust the brightness of the front panel display in this case.

Choices: DISPLAY OFF, -3 to -1 (based on the STANDARD DIMMER setting), **OFF**

OSD SHIFT (OSD shift)

Use to adjust the vertical position of the OSD. Adjust in the - (minus) direction to raise the position of the OSD, and adjust in the + (plus) direction to lower it.

Choices: -5 to +5

Initial setting: 0

OSD BACK COLOR (OSD background color)

Use to select the background color of the OSD.

Choices: **BLUE**, GRAY

■ UNIT SET (Unit settings)

You can use this to change the display unit of measurement.

Choices: **METERS**, FEET



- Select METERS to input speaker distances in meters.
- Select FEET to input speaker distances in feet.

SELECTING AN INPUT MODE

You can select the type of input signals you want this unit to use.

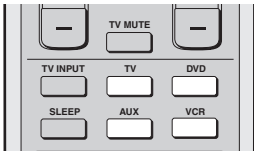
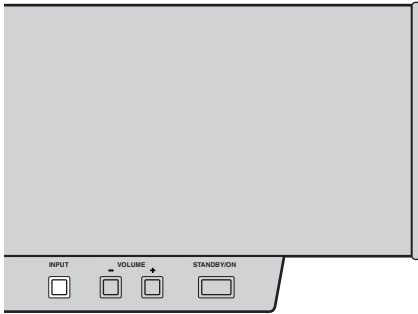

- **AUTO**

Automatically selects input signals in the following order:

- 1) Digital signals
- 2) Analog signals

Use this input mode in most cases.

- **DTS**

Selects only digital signals encoded in DTS.

Compared to AUTO, this input mode provides greater stability during playback.

Use this input mode when playing DTS-CD or DTS-LD discs

- **ANALOG**

Selects analog signals when both digital and analog signals are input simultaneously.



You can adjust the default input mode this unit selects when the power is turned on (see page 44).

Press and hold INPUT on the front panel, or an input selector button on the remote control.

When you press these buttons, you can confirm the currently selected input mode. By pressing and holding them, you can adjust input mode settings. The setting for VCR is ANALOG.

INPUT



or

TV



DVD



AUX

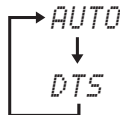
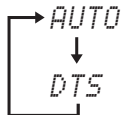
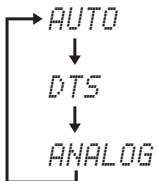

MANUALLY ADJUSTING OUTPUT LEVELS

You can adjust the output level of each speaker to achieve a more true-to-life surround sound experience. You can adjust the sound beam output levels for each beam mode.

Using the test tone

You can use the test tone feature to output a test tone from each speaker to manually balance the speaker levels. Use the test tone to set speaker levels, so that the volume from each speaker is identical when heard from your listening position.

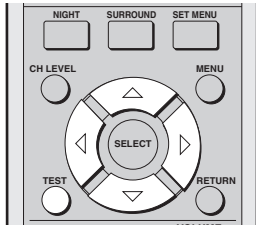

1 Press TEST.

“TEST LEFT” appears in the front panel display, and a test tone is output from the front left speaker.



2 Press \triangle / ∇ to select the speaker you want to adjust.

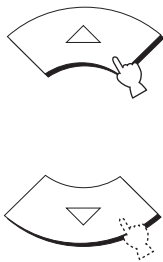

3 Press \triangle / ∇ to adjust speaker volumes.

Adjustment range: -10 dB to +10 dB

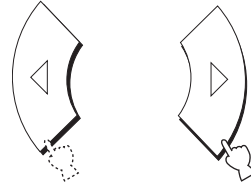

Before proceeding to the next step, adjust the volume level of this unit using VOLUME +/- on the remote control.

4 Press TEST when you have completed your adjustment.



To adjust the output level of your subwoofer, set BASS OUT to BOTH or SWFR (page 38).

Adjusting output levels during playback

You can also manually adjust the speaker levels while playing back a source, such as a DVD.

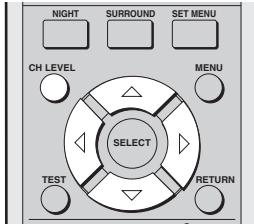

- Press CH LEVEL when you have completed your adjustment.



- Press CH LEVEL.



- Press \triangle / ∇ to select the speaker you want to adjust.



- Press \triangleleft / \triangleright to adjust speaker volumes.

Adjustment range: -10 dB to +10 dB

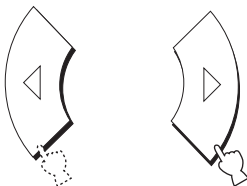

USING THE SLEEP TIMER

Use this feature to automatically set this unit in the standby mode after a specified time period. The sleep timer is useful when you are going to sleep while this unit is playing a source.

■ Setting the sleep timer

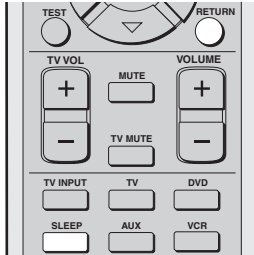

1 Select a source and start playback on the source component.

2 Press SLEEP repeatedly to set the amount of time until this unit goes into standby mode.

Each time you press SLEEP, the front panel display changes as shown below. The SLEEP indicator blinks while switching the amount of time for the sleep timer.

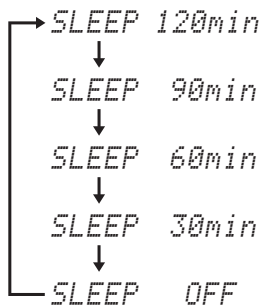
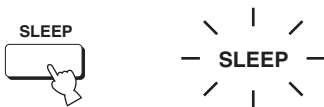

■ Canceling the sleep timer

You can deactivate the sleep timer setting as follows.

1 Press SLEEP repeatedly until "SLEEP OFF" appears in the front panel display.

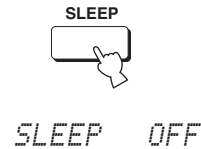

2 Press RETURN, or wait a few seconds without operating this unit.

The SLEEP indicator goes out, and the sleep timer is deactivated.

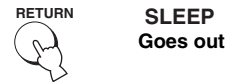

The sleep timer setting can also be deactivated by pressing STANDBY/ON, or by unplugging the power cable from the AC outlet.

3 Press RETURN, or wait a few seconds without operating this unit.

The SLEEP indicator lights up in the front panel display, indicating that the sleep timer is set.

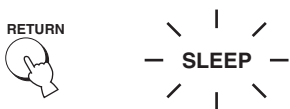

REMOTE CONTROL FEATURES

In addition to controlling this unit, the remote control can also operate other A/V components made by YAMAHA and other manufacturers. To control other components, you must set up the remote control with the appropriate remote control codes.

Note

Depending on the external AV component you are using, you may not be able to operate the component with this unit's remote control, even if a remote control code is set. In this case, operate the component using the supplied remote control.

Setting remote control codes

You can control other components by setting the appropriate remote control codes. Codes can be set up for each input area (TV, DVD, VCR and AUX).

For a complete list of available remote control codes, refer to "LIST OF REMOTE CONTROL CODES" at the end of this manual.

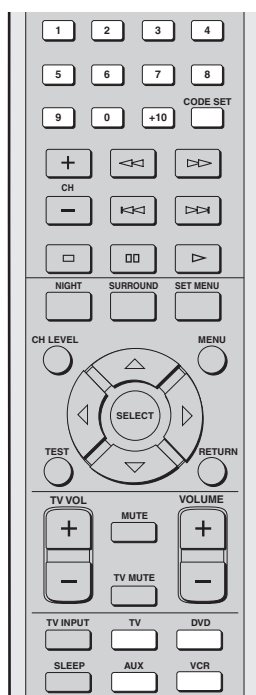

- 1 While holding down **CODE SET**, press the **input selector button for the component you want to set up**, then **without releasing CODE SET**, enter the remote control code for the external component using the **numeric buttons**.

Refer to "LIST OF REMOTE CONTROL CODES" at the end of this manual.

Setting example: YAMAHA DVD input area

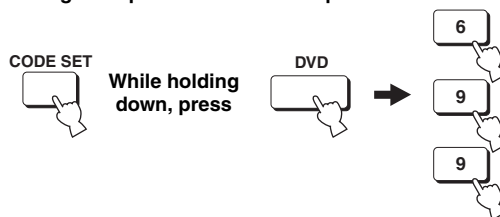

- 2 Refer to "Controlling other components" on page 52 to operate the external component using this unit's remote control.

If the external component functions correctly, remote control code setup was successful.

If the external component does not function correctly, the remote control code may be incorrect. Confirm that the remote control code is correct (see "LIST OF REMOTE CONTROL CODES" at the end of this manual) and start over from step 1.

Note

If the manufacturer of your component has more than one code, try each of them until you find the correct one.

If the remote control is without batteries for more than 2 minutes, or if exhausted batteries remain in the remote control, the contents of the memory may be cleared. When the memory is cleared, insert new batteries and reset the remote control codes. When changing the batteries, be careful not to press any of the buttons on the remote control. Doing so will clear the contents of the memory.

Controlling other components

■ Operating your TV

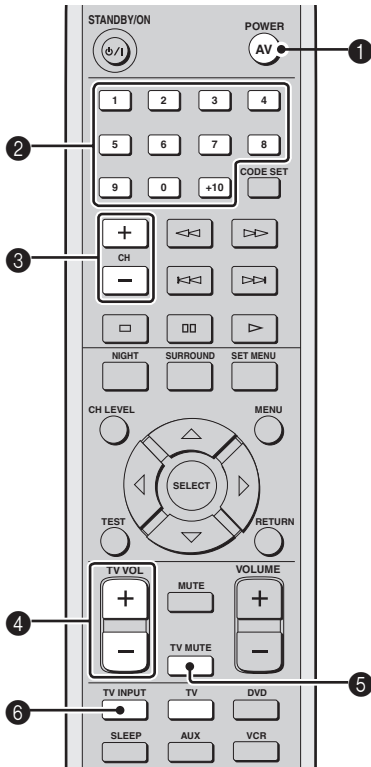

Press TV to switch the input to TV.

- 1 POWER**
Turns on/off the TV's power.
- 2 Numeric buttons**
Selects a TV channel for playback.
- 3 CH +/-**
Switches between the TV channels available.
- 4 TV VOL +/-**
Adjusts the audio output level of the TV.
- 5 TV MUTE**
Temporarily mutes audio output from the TV.
- 6 TV INPUT**
Switches the input source for the TV.

■ Operating your DVD player

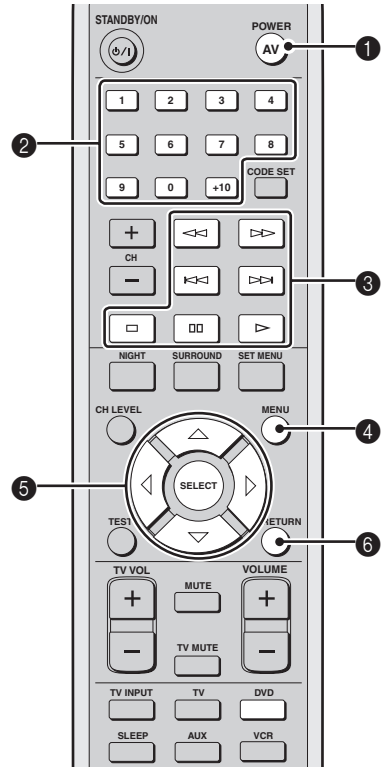

Press DVD to switch the input to DVD.

- 1 POWER**
Turns on/off the DVD player's power.
- 2 Numeric buttons**
Use to enter numeric digits.
- 3 Operation buttons for DVD and VCR players**
Use to perform DVD player operations, such as play and stop.
- 4 MENU**
Displays the DVD menu.
- 5 Cursor buttons**
Use to select DVD menu items.
- 6 RETURN**
Use to return to the previous DVD menu screen or exit the DVD menu.

■ Operating your VCR player

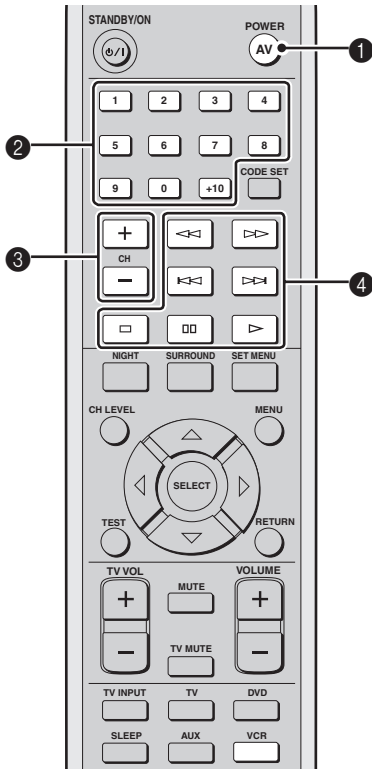

Press VCR to switch the input to VCR.

❶ **POWER**

Turns on/off the VCR player's power.

❷ **Numeric buttons**

Use to enter numeric digits.

❸ **CH +/-**

Switches between the VCR channels available.

❹ **Operation buttons for DVD and VCR players**

Use to perform VCR player operations, such as play and stop.

■ Returning to the YSP-1 operation mode

To return to the YSP-1 operation mode, press one of the following keys.

For details on each key, see page 8 or 20.

- NIGHT**
- SURROUND**
- SET MENU**
- CH LEVEL**
- TEST**

TROUBLESHOOTING

Refer to the chart below when this unit does not function properly. If the problem you are experiencing is not listed below or if the instruction below does not help, set this unit to the standby mode, disconnect the power cord, and contact the nearest authorized YAMAHA dealer or service center.

■ General

Problem	Cause	Remedy	Refer to page
This unit fails to turn on when STANDBY/ON is pressed, or enters the standby mode soon after the power has been turned on.	The power cable is not connected or the plug is not completely inserted.	Connect the power cable firmly.	17
	This unit has been exposed to a strong external electric shock (such as lightning and strong static electricity).	Set this unit in the standby mode, disconnect the power cable, plug it back in after 30 seconds, then use it normally.	—
This unit suddenly enters the standby mode.	The internal temperature becomes too high and the overheat protection circuitry has been activated.	Wait about 1 hour for this unit to cool down and then turn it back on.	—
	The sleep timer has turned the unit off.	Turn on the power, and play the source again.	—
No sound	Incorrect input or output cable connections.	Connect the cables properly. If the problem persists, the cables may be defective.	11
	No appropriate input source has been selected.	Select an appropriate input source with INPUT or the input selector buttons.	31
	The volume is turned down.	Turn up the volume.	30
	The sound is muted.	Press MUTE or VOLUME +/- on the remote control to resume audio output, then adjust the volume.	30
	Signals this unit cannot reproduce are being received from a source component, such as a CD-ROM.	Play a source whose signals can be reproduced by this unit.	—
The sound suddenly goes off.	The sleep timer has turned the unit off.	Turn on the power, and play the source again.	—
	The sound is muted.	Press MUTE or VOLUME +/- on the remote control to resume audio output, then adjust the volume.	30
No sound from the effect speakers.	You are playing back the source or program in stereo mode.	Press one of the beam mode buttons on the remote control to select a multi-channel playback mode, then try to playback the source or program once more.	34
No sound from the center speaker.	The output level of the center speaker is set to minimum.	Raise the level of the center speaker.	48
No sound from the surround speakers.	The output level of the surround speakers is set to minimum.	Raise the output level of the surround speakers.	48
No sound from the subwoofer.	BASS OUT in SUBWOOFER SET is set to FRONT when a Dolby Digital or DTS signal is being played.	Select SWFR or BOTH.	38
	The source does not contain low bass signals.		

Problem	Cause	Remedy	Refer to page
Surround sound effects are insubstantial.	The listening room is not a regular shape.	Install this unit in a square or rectangular shaped room.	—
	There is no wall in the path of the beam.	Place a flat object, such as a board, in the path of the beam.	—
Dolby Digital or DTS sources cannot be played. (Dolby Digital or DTS indicator in the front panel display does not light up.)	The connected component is not set to output Dolby Digital or DTS digital signals.	Make an appropriate setting following the operating instructions for your component.	—
	The input mode is set to ANALOG.	Set the input mode to AUTO.	47
Low frequency sounds are distorted.	CROSS OVER in SUBWOOFER SET is set incorrectly.	Set CROSS OVER correctly.	38
On-screen display does not appear.	The OSD video cable is not connected properly.	Connect the cable properly.	12
	TV is not selected as the input source.	Select TV as the input source.	31
No picture is displayed for external components, such as a DVD player.	The video cable is not connected properly.	Connect the cable properly.	11
	TV is not selected as the input source.	Select TV as the input source.	31
This unit does not operate properly.	The internal microcomputer has been frozen by an external electric shock (such as lightning or excessive static electricity) or by a power supply with low voltage.	Disconnect the AC power cable from the outlet and then plug it in again after about 30 seconds.	—
There is noise interference from digital or high-frequency equipment.	This unit is too close to the digital or high-frequency equipment.	Move this unit further away from such equipment.	—
This unit does not output effect sounds properly.	The original source includes surround effects.	Disable surround effect settings on this unit.	—

■ Remote control

Problem	Cause	Remedy	Refer to page
The remote control does not work and/or function properly.	Wrong distance or angle.	The remote control will function within a maximum range of 6 m (20 ft) and no more than 30 degrees off-axis from the front panel.	19
	Direct sunlight or lighting (from an inverter type of fluorescent lamp, etc.) is striking the remote control sensor of this unit.	Reposition this unit.	—
	The batteries are weak.	Replace all batteries.	18
You cannot operate external components with this unit's remote control.	The external component you want to operate is not selected as the input source.	Press INPUT or the input selector buttons to select the external component you want to operate.	31
	The remote control code was not correctly set.	Set the remote control code correctly or try another code for the same manufacturer using the "LIST OF REMOTE CONTROL CODES" at the end of this manual.	51
	Even if the remote control code is correctly set, there are some models that do not respond to the remote control.	Use the remote control supplied with the external component.	—
The cursor buttons do not work during SET MENU operation.	You pressed an input selector button.	Press TEST once.	24

RESETTING THE FACTORY PRESETS

If you want to reset all of your unit's parameters for any reason, do the following. This procedure completely resets ALL the parameters in SET MENU.

Note

After performing the following procedure you must reset the ROOM TYPE, SP POSITION and ROOM SIZE parameters to match your surround sound environment.

Be sure this unit is in standby mode.

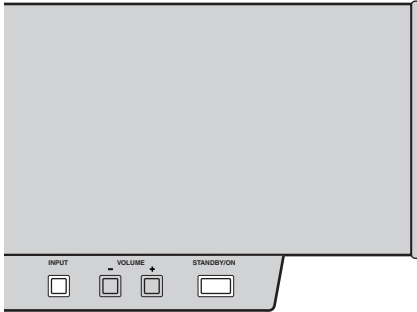

1 Hold down INPUT on the front panel and press STANDBY/ON.

"FACTORY PRESET" appears in the front panel display.

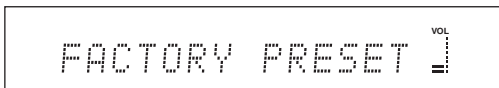

To cancel the initialization procedure without making any changes, press STANDBY/ON.

2 Release INPUT.

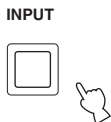

3 Press INPUT once more.

"RESET" appears in the front panel display.

To cancel without making any changes, press INPUT again to display "Cancel".



4 Press STANDBY/ON to confirm your selection.

If you selected "Reset", the unit is reset to its factory presets and switches to standby mode.

If you selected "Cancel", the unit switches to standby mode and nothing is reset.

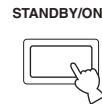

FRONT PANEL DISPLAY ITEMS

■ POWER STANDBY/ON

VOLUME -40.0dB

■ EASY SETUP

ROOM TYPE

1 ROOM TYPE?

SP POSITION

2 SP POSITION?

ROOM SIZE

3 ROOM SIZE?

SETUP OK

4 SETUP OK?

■ MANUAL SETUP

SOUND MENU

1 SOUND MENU

BEAM MENU

2 BEAM MENU

INPUT MENU

3 INPUT MENU

OPTION MENU

4 OPTION MENU

■ SWITCHING BETWEEN EXTERNAL COMPONENTS

When TV is selected as the source

TV AUTO

When DVD is selected as the source

DVD AUTO

When VCR is selected as the source

VCR

When AUX is selected as the source

AUX AUTO

■ SURROUND MODE

When PLO LOGIC is selected

PLO LOGIC

When PLII Movie is selected

PLII Movie

When PLII Music is selected

PLII Music

When PLII Game is selected

PLII Game

When Neo:6 Cinema is selected

Neo:6 Cinema

When Neo:6 Music is selected

Neo:6 Music

■ NIGHT LISTENING MODE

When CINEMA is selected

NIGHT:CINEMA

When MUSIC is selected

NIGHT:MUSIC

When OFF is selected

NIGHT OFF

■ BEAM MODES

When stereo mode is selected

STEREO MODE

When 3 beam mode is selected

3 BEAM MODE

When 5 beam mode is selected

5 BEAM MODE

When ST(STEREO)+3 beam mode is selected

ST+3 BEAM MODE

■ SOUND

When adjusting the volume

VOLUME -40.0dB

When the sound is muted

AUDIO MUTE ON

When the mute function is released

AUDIO MUTE OFF

While a test tone is being output

TEST LEFT

GLOSSARY

Audio formats

■ Dolby Digital

Dolby Digital is a digital surround sound system that gives you completely independent multi-channel audio. With 3 front channels (left, center, and right), and 2 surround stereo channels, Dolby Digital provides 5 full-range audio channels. With an additional channel especially for bass effects, called LFE (low frequency effect), the system has a total of 5.1-channels (LFE is counted as 0.1 channel). By using 2-channel stereo for the surround speakers, more accurate moving sound effects and surround sound environment are possible than with Dolby Surround. The wide dynamic range (from maximum to minimum volume) reproduced by the 5 full-range channels and the precise sound orientation generated using digital sound processing provide listeners with previously unheard of excitement and realism.

With this unit, any sound environment from monaural up to a 5.1-channel configuration can be freely selected for your enjoyment.

■ Dolby Pro Logic II

Dolby Pro Logic II is an improved technique used to decode vast numbers of existing Dolby Surround software. This new technology enables a discrete 5-channel playback with 2 front left and right channels, 1 center channel, and 2 surround left and right channels (instead of only 1 surround channel for conventional Pro Logic technology). Music and Game modes are also available for 2-channel sources in addition to the Movie mode.

■ Dolby Surround

Dolby Surround uses a 4 channel analog recording system to reproduce realistic and dynamic sound effects: 2 front left and right channels (stereo), a center channel for dialog (monaural), and a surround channel for special sound effects (monaural). The surround channel reproduces sound within a narrow frequency range.

Dolby Surround is widely used with nearly all video tapes and laser discs, and in many TV and cable broadcasts as well. The Dolby Pro Logic decoder built into this unit employs a digital signal processing system that automatically stabilizes the volume on each channel to enhance moving sound effects and directionality.

■ DTS (Digital Theater Systems) Digital Surround

DTS digital surround was developed to replace the analog soundtracks of movies with a 6-channel digital sound track, and is now rapidly gaining popularity in movie theaters around the world. Digital Theater Systems Inc. has developed a home theater system so that you can enjoy the depth of sound and natural spatial representation of DTS digital surround in your home. This system produces practically distortion-free 6-channel sound (technically, a left, right and center channels, 2 surround channels, plus an LFE 0.1 channel as a subwoofer, for a total of 5.1-channels). The unit incorporates a DTS-ES decoder that enables 6.1-channel reproduction by adding the surround back channel to existing 5.1-channel format.

■ Neo:6

Neo:6 decodes the conventional 2-channel sources for 6 channel playback by the specific decoder. It enables playback with the full-range channels with higher separation just like digital discrete signal playback. Two modes are available; "Music mode" for playing music sources and "Cinema mode" for movies.

■ PCM (Linear PCM)

Linear PCM is a signal format under which an analog audio signal is digitized, recorded and transmitted without using any compression. This is used as a method of recording CDs and DVD audio. The PCM system uses a technique for sampling the size of the analog signal per very small unit of time. Standing for "pulse code modulation", the analog signal is encoded as pulses and then modulated for recording.

Audio information

■ LFE 0.1 channel

This channel is for the reproduction of low bass signals. The frequency range for this channel is 20 Hz to 120 Hz. This channel is counted as 0.1 because it only enforces a low frequency range compared to the full-range reproduced by the other 5/6 channels in Dolby Digital or DTS 5.1/6.1-channel systems.

INDEX

A

Audio Pin Cable 12

B

Beam modes 34

C

Coaxial digital output jack 13

Coaxial digital input jack 13

D

Digital Audio Pin Cable 13

Display 6, 20

Dolby Digital 32

Dolby Pro Logic 32

Dolby Pro Logic II 32

DTS 32

Dynamic range 39

E

EASY SETUP 24

L

LFE 0.1 channel 59

M

MANUAL SETUP 36

MEMORY 21, 43

N

Night listening modes 33

O

On-screen display (OSD) 20

OSD video cable 12

Optical cable 12, 15

P

PCM 32

Power cable 17

R

Remote control 8, 18

Remote control code 51

S

Surround mode 32

Sleep timer 50

SET MENU 24, 37

T

Test tone 48

SPECIFICATIONS

AMP SECTION

- Maximum Output Power (EIAJ)
..... 2 W (1 kHz, 10% THD, 10 Ω) × 40
..... 20 W (100 Hz, 10% THD, 4 Ω) × 2

SPEAKER SECTION

- Small dia. speakers
..... 4 cm (1.5")-cone magnetic shielding type × 40
Woofers 11 cm (4.5")-cone magnetic shielding type × 2
- Input Jacks
AUDIO VCR, TV (Analog) (1 V, 32 kΩ) 2 pairs (Analog)
AUDIO AUX, TV (Optical) 2 (Digital)
AUDIO DVD (Coaxial) 1 (Digital)
- Output Jacks
SW PRE OUT (1 V, less than 120 Hz) 1 (Subwoofer)
VIDEO OUT OSD (1 Vp-p, 75 Ω) 1 (OSD)
- System Connector Jacks
SYSTEM CONNECTOR 1 (System control)
RS-232C 1 (System setting)

GENERAL

- Power Supply
[U.S.A. and Canada models] AC 120 V, 60 Hz
[Australia model] AC 240 V, 50 Hz
[U.K. and Europe models] AC 230 V, 50 Hz
[China model] AC 220 V, 50 Hz
[Korea model] AC 220 V, 60 Hz
[General model] AC 110–120 V, 50 Hz
[Asia model] AC 220–240 V, 50 Hz
- Power Consumption 50 W
- Standby Power Consumption 0.5 W or less
- Dimensions (W x H x D) 1030 × 194 × 118 mm
(40–9/16" × 7–11/16" × 4–5/8")
- Weight 13 kg (28 lbs 10 oz)

* Specifications are subject to change without notice.

LIST OF REMOTE CONTROL CODES

TV		PROTON	297, 250, 260, 270	VCR		PHILLIPS	325, 326, 328, 337, 356, 357
ADMIRAL	292, 293, 216	QUASAR	234, 235	ADMIRAL	395	PHONOLA	337
AIWA	294, 276, 283, 284	RADIO SHACK	299, 293, 297	AIWA	396, 397, 398, 329	PILOT	396
AKAI	295, 296	RCA	293, 297, 234, 256, 257, 258, 221	AKAI	322, 323, 324	PIONEER	325
ALBA	296	RUNCO	220, 230, 271	AUDIO DYNAMIC		QUASAR	325, 328
AOC	297	SABA	223, 269, 265, 266		392, 394	RCA/PROSCAN	
BELL & HOWELL	292	SAMPO	281, 297, 280	BELL & HOWELL			325, 326, 328, 333, 335, 349, 358, 369, 363, 397
BESTAR	298	SAMSUNG	297, 239, 248, 262, 275	BLAUPUNKT	325, 326	REALISTIC	393, 397, 328, 336, 359, 362, 396, 363
BLAUPUNKT	229, 222	SANYO	295, 233, 279, 272, 273, 274, 212	BROCC SONIC	327		
BLUE SKY	298	SCHNEIDER	296	BUSH	322	SAMSUNG	354, 358, 363, 364, 365, 366
BRANDT	223	SCOTT	297	CANON	325, 328	SANSUI	394
BROC SONIC	297	SHARP	292, 239, 232, 213	CGM	396, 332	SANYO	393, 336, 367
BUSH	296	SIEMENS	229	CITIZEN	396	SCHNEIDER	337
CLATRONIC	298	SIGNATURE	216	CRAIG	396, 363	SCOTT	399, 335, 336, 348, 359, 352, 354, 358
CRAIG	224	SIGNATURE	292	CURTHIS MATHIS		SELECO	322
CROSLEX	225	SONY	263, 214		397, 328, 333	SHARP	395, 362, 382
CURTIS MATHIS		SYLVANIA	297, 225	DAEWOO	328, 334, 335	SIEMENS	393
	297, 226	SYMPHONIC	217, 218, 219	DBX	392, 394	SIGNATURE 2000	
DAEWOO	297, 298, 224, 227, 228	TELEFUNKUN	269, 264, 265, 266	DIMENSIA	333		395, 397
DAYTRON	239	THOMSON	223, 266	DYNATECH	397	SONY	368, 379, 372, 373, 374, 375
DUAL	298	TOSHIBA	292, 226, 267, 215	EMERSON	327, 334, 396, 397	SYLVANIA	397, 325, 326, 328
DWIN	293, 281	VIDECH	297, 242	FISHER	393, 336	SYMPHONIC	397
EMERSON	297, 224, 239, 232	WARDS	297, 239, 232, 216	FUNAI	397	TANDBERG	334
FURGUSON	223, 265, 266	YAMAHA	299, 292, 242, 285, 287, 253	GE	328, 333, 387	TANDY	397
FIRST LINE	298	ZENITH	216, 261, 271	GO VIDEO	321, 331, 341, 351, 353, 363	TASHIRO	396
FISHER	295, 233			GOODMANS	334, 337	TATUNG	392, 394
FRABA	298			GRUNDIG	332, 338	TEAC	392, 394, 397
FUJITSU	289			HITACHI	325, 333, 349, 342, 343	TECHNICS	325, 328
FUNAI	277, 278			INSTANT REPLAY		TEKNIKA	396
GE	293, 297, 234, 235, 236	DVD PLAYER			325, 328	TELEFUNKUN	
GOODMANS	296, 298, 223	AIWA	648, 649	ITT/NOKIA	393		376, 377
GRUNDIG	229, 238, 249	APEX DIGITAL		JC PENNY	392, 393, 394, 328, 333, 349, 396, 363	THOMAS	397
HITACHI	297, 239, 242, 243, 285	DAEWOO	652, 653, 654		392, 394, 344, 345, 346, 347	THORN	393, 396
ICE	296	DENON	623, 624	JVC	392, 394, 344, 345, 346, 347	TOSHIBA	335, 369, 389
IRRADIO	296	FUNAI	625		392, 394, 344, 345, 346, 347	TOTEVISION	363, 396
ITT/NOKIA	244, 245	HARMAN/KARDON	656, 657	KENDO	396	UNITECH	363
JC PENNY	293, 297, 234, 237	HITACHI	626	KENWOOD	392, 394, 396	UNIVERSUM	396, 327, 376
JVC	296, 246, 247, 286	JVC	627	LG/GOLDSTAR		VIDEOSONIC	363
KENDO	298	KENWOOD	628		396, 388	W.WHOUSE	396
KTV	297, 239	KLH	658	LOEWE	396, 337	WARDS	395, 396, 336, 362, 397, 363
LG/GOLDSTAR		LG/GOLDSTAR		LUXOR	395	YAMAHA	399, 392, 393, 394
	297, 298, 239, 237	MARANTZ	645, 663, 664	LXI	393, 396, 397, 336, 349	ZERITH	344, 361, 368, 371, 379, 396, 397
LOEWE	298, 248	MITSUBISHI	629	MAGNAVOX	325, 326, 328		
LXI	293, 297, 225, 226, 233	ONKYO	632, 633, 634	MARANTZ	392, 394		
MAGNAVOX	297, 225, 239	PANASONIC	623, 635, 668, 672	MARTA	396		
MARANTZ	298, 210	PHILIPS	699, 647, 659	MATSUI	396		
MATSUI	295	PIONEER	636, 637, 638, 673, 674, 675	MEMOREX	328, 336, 396, 397		
MEMOREX	297, 216	RCA	639	MINOLTA	333, 349		
MITSUBISHI	299, 297, 259, 287	SAMSUNG	642	MITSUBISHI	399, 344, 348, 359, 352, 353		
NAD	226, 255	SHARP	643		363, 397		
NEC	297, 252, 282	SONY	644, 676, 677	MTC	363, 397		
NOKIA	244, 245	SYLVANIA	662	MULTITECH	397, 348, 354		
NOKIA OCEANIC		SYMPHONIC	662	NEC	392, 394, 344, 383		
	245	THOMSON	646	NOKIA	393, 395		
NORDMENDE	265, 266	TOSHIBA	634, 665, 666, 667	NOKIA OCEANIC			
ONWA	296	YAMAHA	699, 622, 623, 647		395		
PANASONIC	234, 235, 236, 253, 288, 211	ZERITH	663, 664	OKANO	323		
PHILCO	297, 225, 239			OLYMPIC	325, 328		
PHILIPS	225			ORION	327		
PIONEER	226, 235, 254, 255, 268			PANASONIC	325, 328, 339, 355, 378, 384, 385, 386		
PORTLAND	297, 256			PENTAX	333, 349		
PROSCAN	293, 221			PHILCO	325, 328, 397		
PROSCAN	231, 241, 251						

CABLE

ABC	739, 752, 753, 755, 758, 759, 762
GENERAL INSTRUMENT	722
HAMIN	723, 724, 725, 726, 727
HITACHI	722
JEROLD	722, 728, 729, 732, 733, 734, 735, 736, 737
MAGNAVOX	738
MOTOROLA	748
OAK	739, 742, 743
PANASONIC	744, 745, 746, 747
PHILLIPS	763, 764, 765, 766, 767, 768
PIONEER	748
RADIO SHACK	749
SCIENTIFIC ATLANTA	752, 753, 754
SONY	756, 757
TOCOM	755
UNIVERSAL	769, 772, 773, 774, 775
VIEWSTAR	764, 766, 776, 777, 778, 779, 782

SATELLITE TUNER

ECHOSTAR	822
GE	837, 838, 839
GENERAL INSTRUMENT	823
HITACHI	824
HUGHES	843, 844, 845, 846
JVC	822
MAGNAVOX	825
PANASONIC	826, 829
PHILLIPS	825, 843, 844, 845, 846, 847, 848, 849
PRIMESTAR	827
PROSCAN	837, 838, 839, 842
RADIO SHACK	828
RCA	837, 838, 839, 842
SONY	832, 835
TOSHIBA	833, 836
UNIDEN	825
ZENITH	834



© 2004 YAMAHA CORPORATION All rights reserved.

YAMAHA ELECTRONICS CORPORATION, USA 6660 ORANGETHORPE AVE., BUENA PARK, CALIF. 90620, U.S.A.
YAMAHA CANADA MUSIC LTD. 135 MILNER AVE., SCARBOROUGH, ONTARIO M1S 3R1, CANADA
YAMAHA ELECTRONIK EUROPA G.m.b.H. SIEMENSSTR. 22-34, 25462 RELLINGEN BEI HAMBURG, GERMANY
YAMAHA ELECTRONIQUE FRANCE S.A. RUE AMBROISE CROIZAT BP70 CROISSY-BEAUBOURG 77312 MARNE-LA-VALLÉE CEDEX02, FRANCE
YAMAHA ELECTRONICS (UK) LTD. YAMAHA HOUSE, 200 RICKMANSWORTH ROAD WATFORD, HERTS WD18 7GQ, ENGLAND
YAMAHA SCANDINAVIA A.B. J A WETTERGRENS GATA 1, BOX 30053, 400 43 VÄSTRA FRÖLUNDA, SWEDEN
YAMAHA MUSIC AUSTRALIA PTY, LTD. 17-33 MARKET ST., SOUTH MELBOURNE, 3205 VIC., AUSTRALIA

YAMAHA CORPORATION
Printed in Malaysia ◀ WE22570