

YAMAHA
ELECTRONIC PIANO

pf10

OWNER'S MANUAL

CONGRATULATIONS

Congratulations on becoming the owner of a Yamaha PF10 Electronic Piano. The PF10 is a compact, lightweight electronic piano which utilizes Yamaha's advanced FM sound source technology to produce beautiful natural-sounding music. Its keyboard contains 76 keys and covers a broad six-octave range, and there are 10 voice selectors—PIANO 1, PIANO 2, PIANO 3, ELECTRIC PIANO 1, ELECTRIC PIANO 2, ELECTRIC PIANO 3, HARPSICHORD 1, HARPSICHORD 2, VIBRAPHONE, and CLAV—to allow a wide variety of musical expression. Further, a new touch-type system is used with electric organ type keys which not only provides key response that is close to that of an acoustic piano, but easier for beginners to play.

The PF10 also features a built-in amplifier system with dual speakers to produce a rich, full sound that emanates from the entire instrument rather than just from a single tiny speaker as in comparable models. Taking full advantage of its dual speaker system, the PF10 produces a beautiful stereo chorus effect that creates a vibrant multi-instrument sound.

Please be sure to read this manual thoroughly in order to get maximum enjoyment from your Yamaha PF10 Electronic Piano.

CONTENTS

Precautions	1
Features and Functions/Connection	2
Operation/Basic Controls	4
Block Diagram	5
Specifications	6

PRECAUTIONS

LOCATION

Avoid placing your electronic piano in direct sunlight or close to a source of heat. It is also important to avoid locations in which the instrument is likely to be subjected to vibration, excessive dust, cold or moisture.

HANDLING

Avoid applying excessive force to the instruments's knobs and switches.

POWER CORD

Always grip the power plug directly when unplugging. Removing the power plug from the wall socket by pulling on the power cord can result in damage to or shorting of the power cord.

Be sure to unplug your electronic piano if you will not be using it for an extended period of time.

RELOCATION

When moving the electronic piano once it has been set up, be sure to disconnect all cords that connect to other equipment. This will help prevent accidental damage to or shorting of interconnection cables.

CONNECTION

Carefully follow the "CONNECTION" instructions given in this manual when setting up your electronic piano. Connection errors can lead to serious damage to the instrument, amplifier, and speakers.

CLEANING

Do not use solvents such as benzine or thinner to clean your electronic piano as these may cause discoloration or staining of the instrument's exterior. Use a soft, dry cloth.

SAVE THIS MANUAL

After studying this manual thoroughly, it should be stored in a safe place for future reference.

LIGHTNING

In the event of an electrical storm, the instrument's power cord should be unplugged to eliminate the possibility of serious damage.

OTHER APPLIANCES

Use your electronic piano where its digital circuitry cannot be influenced by electromagnetic radiation from appliances such as televisions, radios, etc.

FEATURES AND FUNCTIONS/CONNECTION

Since the Pf10 features a built-in amplifier and speakers, you can begin playing the instrument as soon as you plug in the power cord and turn on the power switch. In order to become familiar with the operation of the Pf10, follow the procedures outlined below.

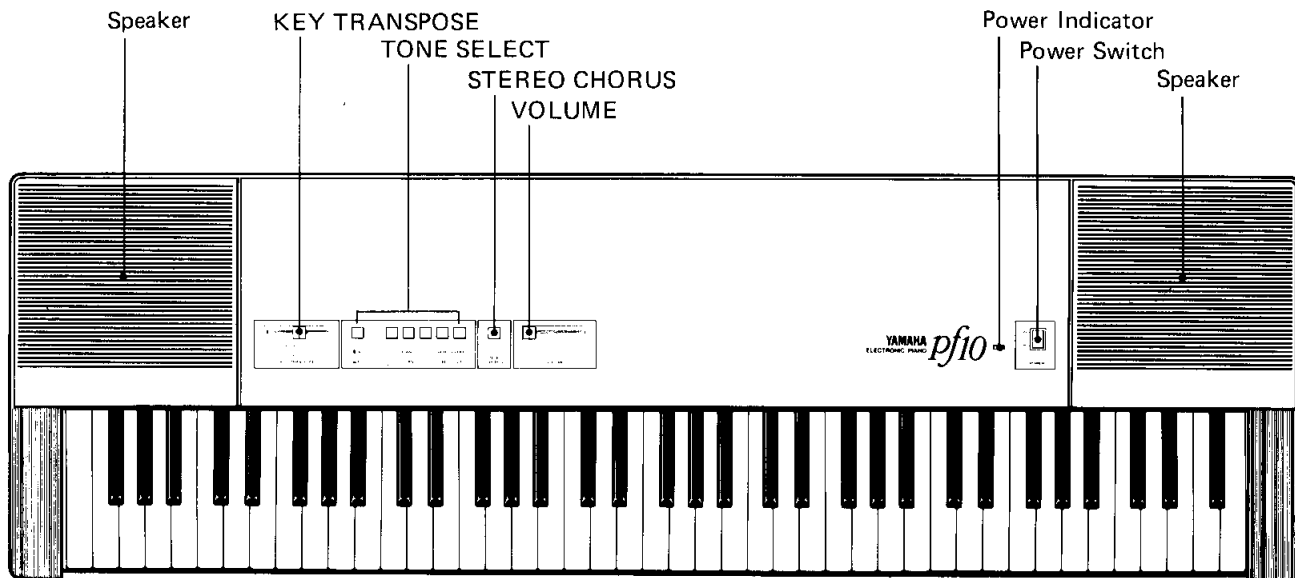

1. Power Cord

Insert the PF10 power plug into the most convenient AC wall outlet.

2. Power Switch

Push the Power switch located on the far right of the control panel to the ON position. The power indicator will light and the PF10 is ready to play.

- When turning the power off, first turn the VOLUME control all the down by sliding it to the left position. Then turn the Power switch off.
- Check whether the A/B selection switch in the TONE SELECT panel is in the A position (out). If it is in the B position (in) press the switch to set it in the A position.
- Depress the TONE SELECT PIANO I switch.
- Gradually turn the VOLUME control while pressing one of the PF10's keys and you should hear the corresponding note from the built-in speaker.
- Note loudness can be changed by applying different amounts of pressure to the key.

3. Connection to an External Speaker System

In order to use headphones or an external speaker system rather than the built-in speaker system, connect the headphones or amp/speaker to the appropriate jack (or jacks) in the rear panel.

Keyboard Range

The keyboard range is from E0 to G6 (76 keys, 6 octaves). The maximum number of notes that can be produced simultaneously is 16.

① PHONES (phone and mini)

Two headphones jacks are provided: one stereo phone jack and a stereo mini jack. Use of stereo headphones allows you to enjoy a rich stereo listening effect, while other mini headphones can be plugged into the mini jack for convenient private listening to the keyboard.

- When headphones are connected the PF10's enclosed speakers will be automatically shut off so that no sound comes out.

② OUTPUT I and OUTPUT II

Either of these jacks can be used to provide the PF10 output signal to an external power amplifier, integrated amp/speaker (such as any standard musical instrument amplifier) or mixer. A speaker with no built-in amplifier cannot be connected directly to these jacks. A power amplifier and speaker system or an integrated amp/speaker must be used.

- When connecting the PF10 to an external stereo system, connect the plug to the stereo amp's AUX terminal.

- Although the PF10's chorus effect is heard if a single amp-speaker is connected, the full stereo effect can only be obtained if the OUTPUT I and II jacks are fed to two independent amp/speaker systems, or two channels of a mixer that will be assigned to the left and right stereo program busses.
- Output Level = -10 dBm (line level)
Impedance = 600 ohms

③ KEY HOLD (FOOT SW.)

An FC-5 foot pedal (supplied) is connected to this jack. When the foot pedal is depressed, an effect is obtained similar to that obtained when the sustain pedal of an acoustic piano is used. If you depress the foot pedal while pressing a key, the note will be sustained even when you release the key. The same is true with chords. Since the sustain effect will be held as long as the foot pedal is depressed, the sound is cut off when the pedal is released.

- The above effect is not obtained if the SUSTAIN pedal is being used as Sustain has priority over KEY HOLD.
- If you want to obtain this effect for another sound, release the pedal, press the desired key(s) and depress the pedal again.
- If you depress the KEY HOLD pedal while pressing 16 keys simultaneously, all sixteen notes will be sustained, so you must release the pedal if you want to produce other sounds. If, however, you are depressing the foot pedal to hold only four keys, for example, you can play 12 other sounds simultaneously.

④ SUSTAIN (FOOT SW.)

Connect the other FC-5 foot pedal to this jack. This foot pedal permits convenient foot control of the SUSTAIN on/off function.

• Sustain Effect

By depressing the SUSTAIN foot pedal you obtain the same effect as that obtained by using the sustain foot pedal on an acoustic piano—the sound gradually decreases even after you release the key. When you release the foot pedal, the sound being sustained is immediately cancelled.

- The sustain effect is not obtained if the FC-5 foot pedal is not connected to this jack.

⑤ LINE INPUT (External Input Jack)

This jack is used to connect an external source such as a rhythm machine, cassette deck, or other keyboard to play through the PF10. Thus you can mix the sounds produced by the PF10 with these other sources to expand the range of your musical enjoyment.

- Since the volume of the external component cannot be controlled by the PF10's volume control, adjustments must be made on the external component.
- Only one LINE INPUT jack is provided. To connect a stereo source, plug in either the L or R output line. The monaural signal will be heard simultaneously from both of the PF10's built-in speakers.

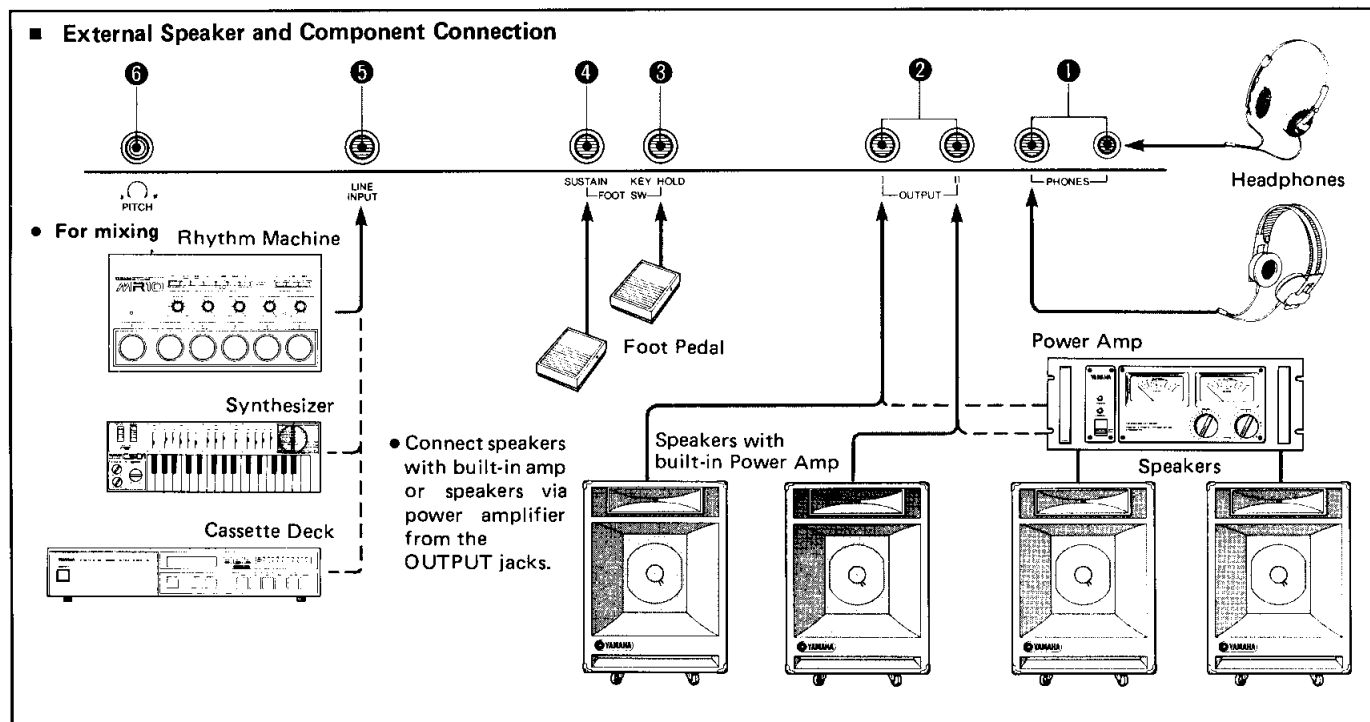

OPERATION/BASIC CONTROLS

After you have made all the necessary connections and checked out the basic operation of the instrument, experiment with the following controls while playing the keyboard.

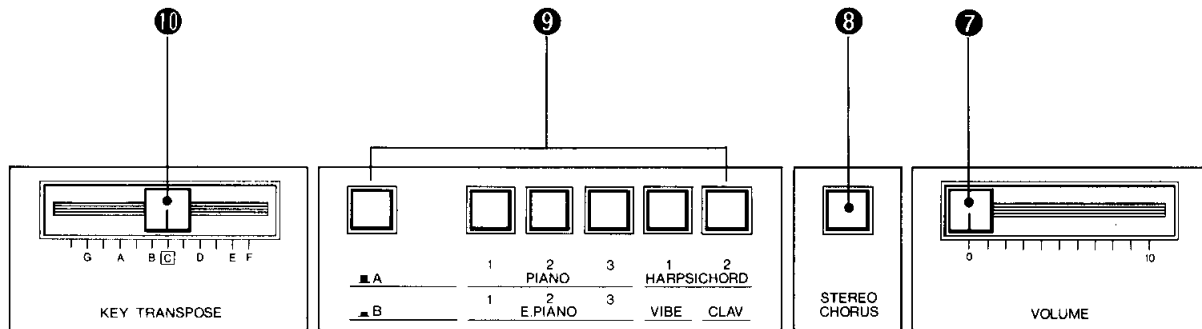

6 PITCH (Pitch Control)

Turning this control clockwise raises the instrument's overall pitch, while turning it counterclockwise lowers the overall pitch. Standard pitch of 440 Hz (A3) is obtained when the control is set slightly to the left of its center position. Control range is from 436 to 447 Hz.

7 VOLUME

Adjusts the overall volume of the PF10's sound.

- When using an external amplifier and speaker system, setting the external amplifier volume control so that the most comfortable overall volume is obtained when the PF10's VOLUME control is set to about "8" results in the best sound quality.

8 STEREO CHORUS

This switch turns the PF10's vibrant stereo chorus effect ON or OFF.

- The chorus effect is not produced on sounds coming through the PF10 from external components.

9 TONE SELECT

These switches determine the basic PF10 sound. There are 10 basic selections: PIANO 1, 2 and 3, HARPSICHORD 1 and 2, ELECTRIC PIANO 1, 2 and 3, VIBRAPHONE and CLAV. When the A/B selection switch is in the A position (■) the sounds written on the upper line are obtained for each TONE SELECT switch. When in the B position (■), the sounds written on the lower line are obtained. Choose the sound you want using the A/B selection switch and the appropriate TONE SELECT switch.

- If all the TONE SELECT switches are off, PIANO 1 is automatically selected.
- To change the sound, wait until the present sound completely disappears before pressing the next TONE SELECT switch to avoid erroneous sound selection.

- If two or more TONE SELECT switches are pressed at the same time, the switch on the right is selected automatically.

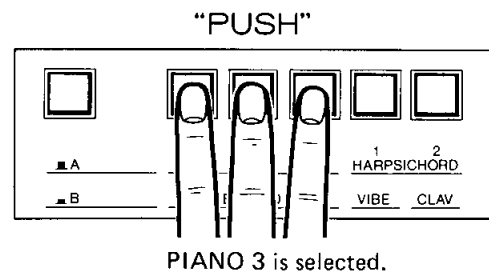

10 KEY TRANSPOSE

While the keyboard has exceptional range thanks to its 76 keys and six octave range, even further versatility is provided by the KEY TRANSPOSE function, which allows you to adjust the sounds of the keys another half-octave up and down. Thus you can have a full octave more of sound, and all sounds are adjusted accordingly.

- For normal operation, the KEY TRANSPOSE lever is set in the "C" position.

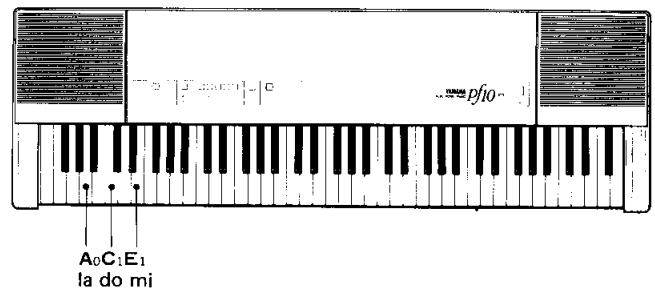

- When the KEY TRANSPOSE lever is placed in the "C" position, this key produces the sound "do".
- When the lever is in the "E" position, this key produces the sound "mi".
- When the lever is in the "A" position, this key produces the sound "la".

BLOCK DIAGRAM

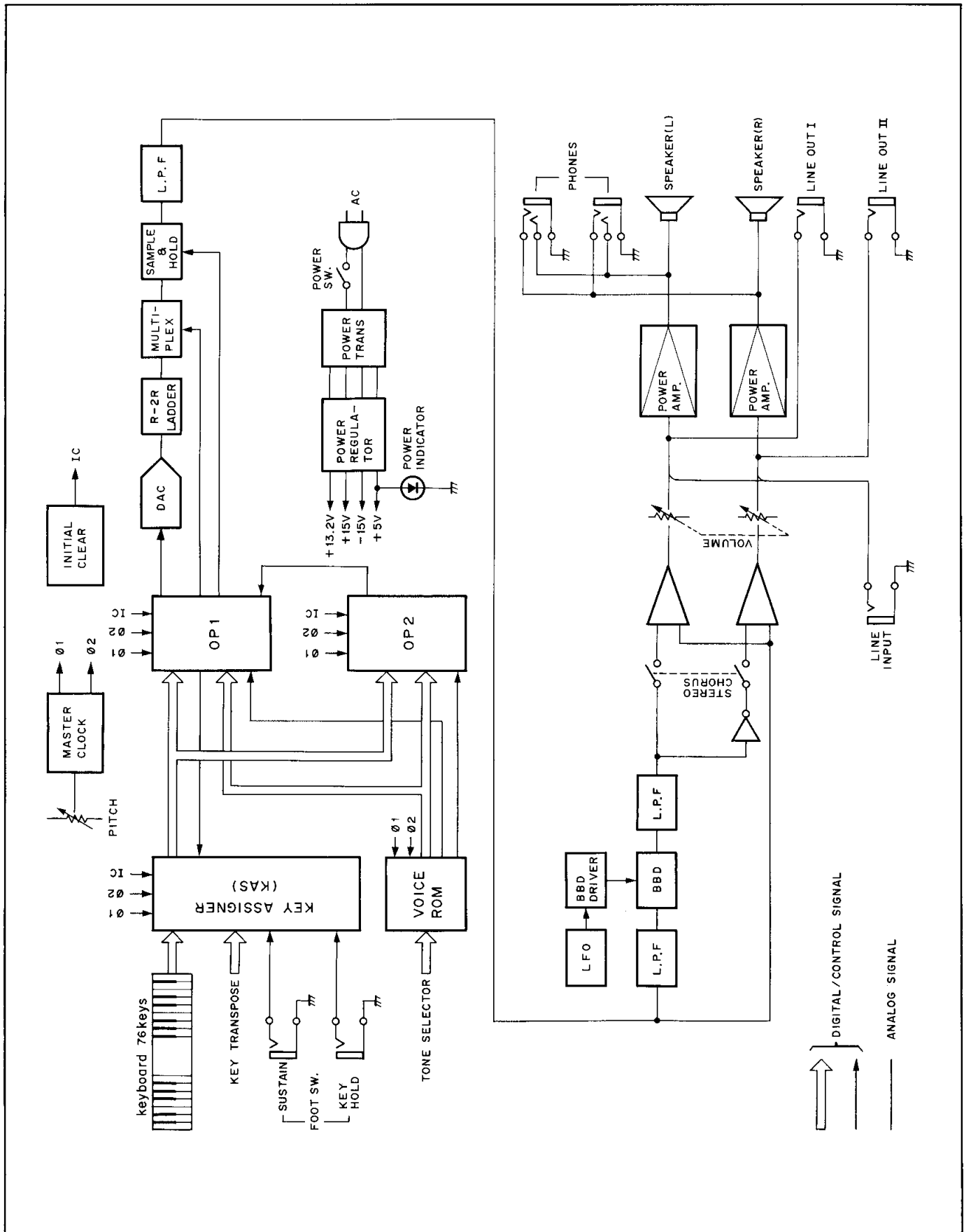

SPECIFICATIONS

Keyboard	76 keys
Range by KEY TRANSPOSE lever position	
"C" = E ₀ ~ G ₆	
"F#" = A ₋₁ # ~ C ₆ #	
"F" = A ₀ ~ C ₇	
Number of sounds produced simultaneously	up to 16
PITCH Control	436–447 Hz
SUSTAIN	ON/OFF (with foot pedal)
KEY HOLD	ON/OFF (with foot pedal)
KEY TRANSPOSE	
TONE SELECT	A/B Selection Switch
	PIANO 1, 2, 3/HARPSICHORD 1, 2/E. PIANO 1, 2, 3/VIBE/CLAV
STEREO CHORUS	ON/OFF
Speakers	12 cm x 2 (4 ohms)
Internal Amp Output	5 W x 2 (max)

Rear Panel

LINE INPUT	Std mono jack (600 ohms, -15 dBm max)
OUTPUT I, II	Std mono jack (600 ohms, -10 dBm max vol.)
HEADPHONES	Std stereo jack x 1 (8 ohms)/Stereo minijack x 1 (8 ohms)
Pedal Connection	Std mono jack x 2
Power Requirements	General Model: 110–120/220–240 V, 50/60 Hz U. S. and Canada: 120 V, 50/60 Hz
Power Consumption	General Model: 45 W U. S. Model: 30 W Canada Model: 40 W
Dimensions (W x H x D)	1,129 x 87 x 359 mm (44-1/2" x 3-3/8" x 14-1/8")
Weight	18 kg (39 lbs 10 oz)
Accessories	FC-5 foot pedal (1), Score Stand, Dust Cover

* Specifications and design are subject to change without notice for improvement.

- Where to find the Name plate
- Hire ist das Typenschild angebracht
- Placering av namnplåten
- Plassering av navneplaten

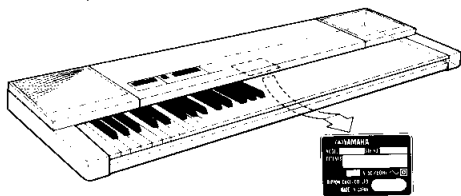

SERVICE

The PF10 is supported by Yamaha's worldwide network of factory trained and qualified dealer service personnel. In the event of a problem, contact your nearest Yamaha dealer.

FCC CERTIFICATION (USA)

While the following statements are provided to comply with FCC Regulations in the United States, the corrective measures listed are applicable worldwide.

This series of Yamaha combo Keyboards use frequencies that appear in the radio frequency range and if installed in the immediate proximity of some types of audio or video devices (within three meters), interference may occur.

This series of Yamaha Combo Keyboards has been type tested and found to comply with the specifications set for a class B computing device in accordance with those specifications listed in subpart J of part 15 of the FCC rules. These rules are designed to provide a reasonable measure of protection against such interference. However, this does not guarantee that interference will not occur. If your Combo Keyboards should be suspected of causing interference with other electronic devices, verification can be made by turning your Combo Keyboards off and on. If the interference continues when your Keyboard is off, the Keyboard is not the source of the interference. If your Keyboard does appear to be the source of the interference, you should try to correct the situation by using one or more of the following measures:

Relocate either the Keyboard or the electronic device that is being affected by the interference.

Utilize power outlets for the Combo Keyboard and the device being affected that are on different branch (circuit breaker or fuse) circuits, or install a/c line filters.

In the case of radio T.V. interference, relocate the antenna or, if the antenna lead-in is 300 ohm ribbon lead, change the lead-in to co-axial type cable.

If these corrective measures do not produce satisfactory results, please contact your franchised Yamaha Combo Keyboard dealer for suggestions and/or corrective measures. If you can not locate a franchised Yamaha Combo Keyboard dealer in your general area contact the Combo Service Department, Yamaha International, 6600 Orangethorpe Ave., Buena Park, CA 90620.

If for any reason, you should need additional information relating to radio or T.V. interference, you may find a booklet prepared by the Federal Communications Commission helpful: "How to Identify and Resolve Radio - T.V. Interference Problems". This booklet is available from the U.S. Government printing office, Washington D.C. 20402 - Stock #004-000-00345.

SINCE 1887



YAMAHA

NIPPON GAKKI CO., LTD. HAMAMATSU, JAPAN