

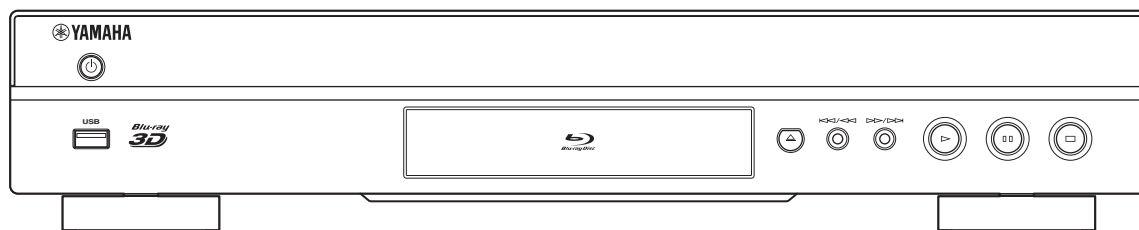

BLU-RAY DISC PLAYER

# BD-S671

*OWNER'S MANUAL*



# IMPORTANT SAFETY INSTRUCTIONS

Read these operating instructions carefully before using the unit. Follow the safety instructions on the unit and the applicable safety instructions listed below. Keep these operating instructions handy for future reference.

- 1 Read these instructions.
- 2 Keep these instructions.
- 3 Heed all warnings.
- 4 Follow all instructions.
- 5 Do not use this apparatus near water.
- 6 Clean only with dry cloth.
- 7 Do not block any ventilation openings. Install in accordance with the manufacturer's instructions.
- 8 Do not install near any heat sources such as radiators, heat registers, stoves, or other apparatus (including amplifiers) that produce heat.
- 9 Do not defeat the safety purpose of the polarized or grounding-type plug. A polarized plug has two blades with one wider than the other. A grounding-type plug has two blades and a third grounding prong. The wide blade or the third prong are provided for your safety. If the provided plug does not fit into your outlet, consult an electrician for replacement of the obsolete outlet.
- 10 Protect the power cord from being walked on or pinched particularly at plugs, convenience receptacles, and the point where they exit from the apparatus.
- 11 Only use attachments/accessories specified by the manufacturer.
- 12 Use only with the cart, stand, tripod, bracket, or table specified by the manufacturer, or sold with the apparatus. When a cart is used, use caution when moving the cart/apparatus combination to avoid injury from tip-over. 
- 13 Unplug this apparatus during lightning storms or when unused for long periods of time.
- 14 Refer all servicing to qualified service personnel. Servicing is required when the apparatus has been damaged in any way, such as power-supply cord or plug is damaged, liquid has been spilled or objects have fallen into the apparatus, the apparatus has been exposed to rain or moisture, does not operate normally, or has been dropped.

## WARNING:

**TO REDUCE THE RISK OF FIRE, ELECTRIC SHOCK OR PRODUCT DAMAGE,**

- **DO NOT EXPOSE THIS APPARATUS TO RAIN, MOISTURE, DRIPPING OR SPLASHING AND THAT NO OBJECTS FILLED WITH LIQUIDS, SUCH AS VASES, SHALL BE PLACED ON THE APPARATUS.**
- **USE ONLY THE RECOMMENDED ACCESSORIES.**
- **DO NOT REMOVE THE COVER (OR BACK); THERE ARE NO USER SERVICEABLE PARTS INSIDE. REFER SERVICING TO QUALIFIED SERVICE PERSONNEL.**

## CAUTION!

**DO NOT INSTALL OR PLACE THIS UNIT IN A BOOKCASE, BUILT-IN CABINET OR IN ANOTHER CONFINED SPACE.**

**ENSURE THE UNIT IS WELL VENTILATED. TO PREVENT RISK OF ELECTRIC SHOCK OR FIRE HAZARD DUE TO OVERHEATING, ENSURE THAT CURTAINS AND ANY OTHER MATERIALS DO NOT OBSTRUCT THE VENTILATION VENTS.**

## CAUTION!

**THIS PRODUCT UTILIZES A LASER. USE OF CONTROLS OR ADJUSTMENTS OR PERFORMANCE OF PROCEDURES OTHER THAN THOSE SPECIFIED HEREIN MAY RESULT IN HAZARDOUS RADIATION EXPOSURE. DO NOT OPEN COVERS AND DO NOT REPAIR YOURSELF. REFER SERVICING TO QUALIFIED PERSONNEL.**

## CAUTION

Danger of explosion if battery is incorrectly replaced. Replace only with the same or equivalent type.

The socket outlet shall be installed near the equipment and easily accessible. The mains plug of the power supply cord shall remain readily operable.

To completely disconnect this apparatus from the AC Mains, disconnect the power supply cord plug from AC receptacle.



## CAUTION

**RISK OF ELECTRIC SHOCK  
DO NOT OPEN**



**CAUTION: TO REDUCE THE RISK OF ELECTRIC SHOCK, DO NOT REMOVE SCREWS. NO USER-SERVICEABLE PARTS INSIDE. REFER SERVICING TO QUALIFIED SERVICE PERSONNEL.**



The lightning flash with arrowhead symbol, within an equilateral triangle, is intended to alert the user to the presence of uninsulated "dangerous voltage" within the product's enclosure that may be of sufficient magnitude to constitute a risk of electric shock to persons.



The exclamation point within an equilateral triangle is intended to alert the user to the presence of important operating and maintenance (servicing) instructions in the literature accompanying the appliance.

## FCC INFORMATION (for US customers)

### 1 **IMPORTANT NOTICE: DO NOT MODIFY THIS UNIT!**

This product, when installed as indicated in the instructions contained in this manual, meets FCC requirements. Modifications not expressly approved by Yamaha may void your authority, granted by the FCC, to use the product.

2 **IMPORTANT:** When connecting this product to accessories and/or another product use only high quality shielded cables. Cable/s supplied with this product **MUST** be used. Follow all installation instructions. Failure to follow instructions could void your FCC authorization to use this product in the USA.

3 **NOTE:** This product has been tested and found to comply with the requirements listed in FCC Regulations, Part 15 for Class "B" digital devices. Compliance with these requirements provides a reasonable level of assurance that your use of this product in a residential environment will not result in harmful interference with other electronic devices. This equipment generates/uses radio frequencies and, if not installed and used according to the instructions found in the users manual, may cause interference harmful to the operation of other electronic devices.

Compliance with FCC regulations does not guarantee that interference will not occur in all installations. If this product is found to be the source of interference, which can be determined by turning the unit "OFF" and "ON", please try to eliminate the problem by using one of the following measures:

Relocate either this product or the device that is being affected by the interference.

Utilize power outlets that are on different branch (circuit breaker or fuse) circuits or install AC line filter/s.

In the case of radio or TV interference, relocate/reorient the antenna. If the antenna lead-in is 300 ohm ribbon lead, change the lead-in to coaxial type cable.

If these corrective measures do not produce satisfactory results, please contact the local retailer authorized to distribute this type of product. If you can not locate the appropriate retailer, please contact Yamaha Electronics Corp., USA 6660 Orangethorpe Ave., Buena Park, CA 90620.

The above statements apply **ONLY** to those products distributed by Yamaha Corporation of America or its subsidiaries.

## COMPLIANCE INFORMATION STATEMENT (DECLARATION OF CONFORMITY PROCEDURE)

Responsible Party: Yamaha Electronics Corporation, USA  
Address: 6660 Orangethorpe Avenue  
Buena Park, CA 90620  
Telephone: 714-522-9105  
1-800-492-6242 (toll free)  
Fax: 714-228-3390  
Type of Equipment: Blu-ray Disc Player  
Model Name: BD-S671

- This device complies with Part 15 of the FCC Rules.
  - Operation is subject to the following conditions:
    - This device may not cause harmful interference.
    - This device must accept any interference received including interference that may cause undesired operation.
- See the "Troubleshooting" section at the end of this manual if interference to radio reception is suspected.

## We Want You Listening For A Lifetime



Yamaha and the Electronic Industries Association's Consumer Electronics Group want you to get the most out of your equipment by playing it at a safe level. One that lets the sound come through loud and clear without annoying blaring or distortion - and, most importantly, without affecting your sensitive hearing.

Since hearing damage from loud sounds is often undetectable until it is too late, Yamaha and the Electronic Industries Association's Consumer Electronics Group recommend you to avoid prolonged exposure from excessive volume levels.

### **IMPORTANT**

Please record the serial number of this unit in the space below.

MODEL:

Serial No.:

The serial number is located on the rear of the unit.

Retain this Owner's Manual in a safe place for future reference.

To obtain information about disposing unwanted, end-of-life products in USA, please visit <http://usa.yamaha.com/support/>

# CAUTION: READ THIS BEFORE OPERATING YOUR UNIT.

- 1 To assure the finest performance, please read this manual carefully. Keep it in a safe place for future reference.
- 2 Install this sound system in a well ventilated, cool, dry, clean place—away from direct sunlight, heat sources, vibration, dust, moisture, and/or cold. For proper ventilation, allow the following minimum clearances.  
Top : 10 cm (4 in)  
Rear: 10 cm (4 in)  
Side: 10 cm (4 in)
- 3 Locate this unit away from other electrical appliances, motors, or transformers to avoid humming sounds.
- 4 Do not expose this unit to sudden temperature changes from cold to hot, and do not locate this unit in an environment with high humidity (i.e. a room with a humidifier) to prevent condensation inside this unit, which may cause an electrical shock, fire, damage to this unit, and/or personal injury.
- 5 Avoid installing this unit where foreign object may fall onto this unit and/or this unit may be exposed to liquid dripping or splashing. On the top of this unit, do not place:
  - Other components, as they may cause damage and/or discoloration on the surface of this unit.
  - Burning objects (i.e. candles), as they may cause fire, damage to this unit, and/or personal injury.
  - Containers with liquid in them, as they may fall and liquid may cause electrical shock to the user and/or damage to this unit.
- 6 Do not cover this unit with a newspaper, tablecloth, curtain, etc. in order not to obstruct heat radiation. If the temperature inside this unit rises, it may cause fire, damage to this unit, and/or personal injury.
- 7 Do not plug in this unit to a wall outlet until all connections are complete.
- 8 Do not operate this unit upside-down. It may overheat, possibly causing damage.
- 9 Do not use force on switches, knobs and/or cords.
- 10 When disconnecting the power cable from the wall outlet, grasp the plug; do not pull the cable.
- 11 Do not clean this unit with chemical solvents; this might damage the finish. Use a clean, dry cloth.
- 12 Only voltage specified on this unit must be used. Using this unit with a higher voltage than specified is dangerous and may cause fire, damage to this unit, and/or personal injury. Yamaha will not be held responsible for any damage resulting from use of this unit with a voltage other than specified.
- 13 To prevent damage by lightning, keep the power cable disconnected from a wall outlet or this unit during a lightning storm.
- 14 Do not attempt to modify or fix this unit. Contact qualified Yamaha service personnel when any service is needed. The cabinet should never be opened for any reasons.
- 15 When not planning to use this unit for long periods of time (i.e. vacation), disconnect the AC power plug from the wall outlet.
- 16 Be sure to read the “TROUBLESHOOTING” section on common operating errors before concluding that this unit is faulty.
- 17 Before moving this unit, press  to set this unit to the standby mode, and disconnect the AC power plug from the wall outlet.
- 18 Condensation will form when the surrounding temperature changes suddenly. Disconnect the power cable from the outlet, then leave this unit alone.
- 19 When using this unit for a long time, this unit may become warm. Turn the power off, then leave this unit alone for cooling.
- 20 Install this unit near the AC outlet and where the AC power plug can be reached easily.
- 21 The batteries shall not be exposed to excessive heat such as sunshine, fire or the like.

This unit is not disconnected from the AC power source as long as it is connected to the wall outlet, even if this unit itself is turned off by . This state is called the standby mode. In this state, this unit is designed to consume a very small quantity of power.

**WARNING**  
TO REDUCE THE RISK OF FIRE OR ELECTRIC SHOCK, DO NOT EXPOSE THIS UNIT TO RAIN OR MOISTURE.

The laser component in this product is capable of emitting radiation exceeding the limit for Class 1.

**FOR CANADIAN CUSTOMERS**  
To prevent electric shock, match wide blade of plug to wide slot and fully insert.  
This Class B digital apparatus complies with Canadian ICES-003.

# CONTENTS

1

## 1. INTRODUCTION

<b>WHAT YOU CAN DO WITH THIS PLAYER.....</b>	<b>2</b>
<b>SUPPLIED PARTS .....</b>	<b>2</b>
<b>ABOUT DISCS AND FILES.....</b>	<b>3</b>
Types of discs/files that can be used with this player.....	3
Loading a disc.....	4
Disc precautions .....	4
Notice for watching 3D video images .....	4
<b>CONTROLS AND FUNCTIONS .....</b>	<b>5</b>
Front panel.....	5
Remote control .....	6

## 2. CONNECTION

<b>INTRODUCTION TO CONNECTIONS .....</b>	<b>10</b>
Rear panel.....	10
<b>HDMI CONNECTION.....</b>	<b>12</b>
Connecting to the HDMI terminal.....	12
Connection for the playback of Blu-ray 3D discs .....	12
<b>VIDEO CONNECTIONS .....</b>	<b>13</b>
Connecting to the component/video jack .....	13
<b>AUDIO CONNECTIONS .....</b>	<b>14</b>
Connecting to the digital audio jack/terminal.....	14
Connecting to the audio jacks.....	15
<b>NETWORK AND USB CONNECTION .....</b>	<b>16</b>
Connecting to the NETWORK terminal and USB port .....	16
<b>OTHER CONNECTIONS .....</b>	<b>17</b>
Connecting to the REMOTE CONTROL jacks .....	17
Connecting the power cable .....	17

## 3. PLAYBACK

<b>INITIAL WIZARD/EASY SETUP.....</b>	<b>18</b>
Setting with the Initial Wizard/Easy Setup.....	18
<b>HOME/MEDIA MENU .....</b>	<b>19</b>
Playing back photo/music/video.....	19
Using network content.....	21
<b>USING NETWORK SERVICES .....</b>	<b>22</b>
<b>PLAYING VIDEOS FROM YouTube™ .....</b>	<b>22</b>
<b>PLAYING VIDEOS FROM NETFLIX .....</b>	<b>23</b>
Checking the activation code.....	23
Preparing for watching video on your computer .....	23
Playing a video .....	23
<b>PLAYING VIDEOS FROM BLOCKBUSTER.....</b>	<b>24</b>
Creating your account.....	24
Activation of the account.....	24
Playing the video .....	24
Operations for watching videos .....	24
<b>PLAYING VIDEOS FROM FILM FRESH.....</b>	<b>25</b>
Creating your account.....	25
Activation of the account.....	25
Playing the video .....	25
Operations for watching videos .....	25
<b>ADVANCED PLAYBACK OPERATION.....</b>	<b>26</b>
On Screen menu.....	26
Status menu.....	27
Using Bookmark.....	28
Program play.....	28
Using search .....	28
Enjoying BONUSVIEW™ and BD-Live™.....	29
Using Picture in Picture function (secondary audio/video playback) .....	29
Using the feature of BD-Live™ .....	29

## 4. SETTINGS

<b>SETUP MENU .....</b>	<b>30</b>
Example of SETUP menu operation.....	32
General Setting.....	33
Display Setting.....	35
Audio Setting .....	37
System Information.....	37
About the audio output formats .....	38
About the video output formats .....	39
<b>SOFTWARE UPGRADE .....</b>	<b>40</b>
Upgrading the software.....	40

## 5. ADDITIONAL INFORMATION

<b>TROUBLESHOOTING .....</b>	<b>41</b>
Power .....	41
Basic operation.....	41
Disc playback.....	41
Picture .....	42
Sound .....	42
Network.....	43
Messages on the screen.....	43
<b>GLOSSARY .....</b>	<b>44</b>
<b>SPECIFICATIONS .....</b>	<b>45</b>
General .....	45
Input/output.....	45
Copyright .....	46

(at the end of this manual)

<b>Information about software .....</b>	<b>i</b>
---	----------

2

3

4

5

## About this manual

- This manual describes how to operate this Player using a remote control except when it is not available. Some of these operations are also available using the front panel buttons.
- Notes contain important information about safety and operating instructions. Hint(s) indicates a tip for your operation.
- This manual is printed prior to production. Design and specifications are subject to change in part as a result of improvements, etc. In case of differences between the manual and the product, the product has priority.

## The icons used in this manual

Icons are used to indicate available buttons/functions for a particular format.

<b>BD</b>	: BD-Video
<b>DVD</b>	: DVD-Video, DVD-VR, DVD+VR
<b>CD</b>	: Audio CD
<b>VIDEO</b>	: AVCHD, WMV, DivX
<b>MUSIC</b>	: MP3, WMA, WAV
<b>PHOTO</b>	: JPEG

English

# WHAT YOU CAN DO WITH THIS PLAYER

## Easy setting for language, resolution, screen aspect ratio → p. 18

You can perform language and TV settings.

## Play back commercially-released Blu-ray™/DVD/CD discs\* → p. 26

In addition to Blu-ray Discs™ (BD discs), this Player also supports playback of a variety of other discs.

## Play back BONUSVIEW™, BD-Live™, etc.\* → p. 29

You can enjoy additional movies on the latest BD discs.

## Play back Video, Music, Photo files on a disc\* → p. 19

This Player can play back discs you recorded.

## Play back Video, Music, Photo files on a disc/USB memory device\* → p. 19

Files recorded on discs/USB memory devices can be played back with this Player.

## Play back Video, Music, Photo files on a Home Network Server\* \*\* → p. 21

PC contents can be played back with TV or AV receiver by connecting this Player to a network server.

## Operation with the remote control of TV, AV receiver, etc. → p. 33

Connecting devices with an HDMI cable, you can control devices with a single remote control using the HDMI Control function.

## Streaming Playback contents on the Network Services\*\* → p. 22

You can instantly enjoy movies and TV programs over the internet with this Player.

\* For details on playable disc and format, see page 3.

\*\* Network setting is needed to use this function.

# SUPPLIED PARTS

Make sure the following accessories are provided with the product.

Remote control



Batteries (x2)  
(AAA, R03, UM-4)

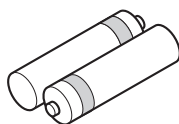

Audio/Video cable

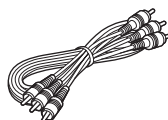



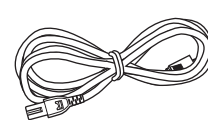



Power cable











## Types of discs/files that can be used with this player

- 12 cm (5") and 8 cm (3") discs can be played back in this Player. Do not use an 8 cm (3") to 12 cm (5") adapter.
- Use discs that conform to compatible standards as indicated by the presence of official logos on the disc label. Playback of discs not complying with these standards is not guaranteed. In addition, the image quality or sound quality is not guaranteed even if the discs can be played back.

Disc Type	Recording Format	Data Format
BD-ROM/BD-R/ BD-RE	BD-Video	--
DVD-ROM	DVD-Video	--
DVD-R/DVD-R DL/ DVD-RW	DVD-Video/DVD-VR/AVCHD/Data Disc	DivX/WMV/MP3/WAV/WMA/JPEG
DVD+R/DVD+R DL/DVD+RW	DVD-Video/DVD+VR/AVCHD/Data Disc	DivX/WMV/MP3/WAV/WMA/JPEG
CD-ROM	CDDA/HDCD	--
CD-R/CD-RW	CDDA/Data Disc	DivX/WMV/MP3/WAV/WMA/JPEG
USB	--	DivX/WMV/MP3/WAV/WMA/JPEG
Network	--	WMV/MP3/WMA/WAV/JPEG

Region management information		
Destination	BD-Video	DVD-Video
Australia	Region code "B" or "ALL" 	Region number "4" or "ALL" 
Russia	Region code "C" or "ALL" 	Region number "5" or "ALL" 
China	Region code "C" or "ALL" 	Region number "6" or "ALL" 

- BD/DVD video players and discs have region codes, which dictate the regions in which a disc can be played.
- BD/DVD Video operations and functions may be different from the explanations in this manual and some operations may be prohibited due to disc manufacturer's settings.
- If a menu screen or operating instructions are displayed during playback of a disc, follow the operating procedure displayed.

Region management information		
Destination	BD-Video	DVD-Video
U.S.A. and Canada	Region code "A" or "ALL" 	Region number "1" or "ALL" 
Asia	Region code "A" or "ALL" 	Region number "3" or "ALL" 
Central and South America	Region code "A" or "ALL" 	Region number "4" or "ALL" 
Europe	Region code "B" or "ALL" 	Region number "2" or "ALL" 

### Notes

- Playback for some of the discs in the left side column tables may not be possible depending on the disc.
- Finalize all recording media that is played back in this player.
- "Finalize" refers to a recorder processing a recorded disc so that it will play in other players/recorders as well as this Player. Only finalized discs will play back in this Player. (This Player does not have a function to finalize discs.)
- Playback of all files on the disc, USB memory device and network is not guaranteed.
- A copyright protected file cannot be played back via USB memory device and network.

### MP3/WMA audio file requirement

- Sampling frequency: within 32 - 48 kHz (MP3/WMA), LPCM 44.1 kHz/16 bit/Stereo (WAV)
- Bitrate: within 8 - 320 kbps (MP3), 32 - 192 kbps (WMA)

### WMV file requirement

- WMV9, maximum resolution is 1,920 × 1,080.

## ■ Loading a disc

- Insert the disc with the label face up.
- In case of the disc recorded on both sides, face down the side to play back.

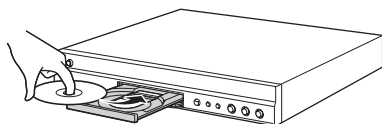

### Notes





- Playback may begin automatically, depending on the disc and setting of this Player.
- The menu may be displayed first, depending on the disc.
- The disc load time may vary depending on the disc.

## ■ Disc precautions

### Be careful of scratches and dust

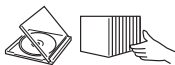
- BD, DVD and CD discs are sensitive to dust, fingerprints and especially scratches. A scratched disc may not be able to be played back. Handle discs with care and store them in a safe place.

### Proper disc storage

Place the disc in the center of the disc case and store the case and disc upright.	
Avoid storing discs in locations subject to direct sunlight, close to heating appliances or in locations of high humidity.	
Do not drop discs or subject them to strong vibrations or impacts.	
Avoid storing discs in locations where there are large amounts of dust or moisture.	

## Handling precautions



- If the surface is soiled, wipe gently with a soft, damp (water only) cloth. When wiping discs, always move the cloth from the center hole toward the outer edge.
- Do not use record cleaning sprays, benzene, thinner, static electricity prevention liquids or any other solvent.
- Do not touch the surface.
- Do not stick paper or adhesive labels to the disc.
- If the playing surface of a disc is soiled or scratched, the Player may decide that the disc is incompatible and eject the disc tray, or it may fail to play the disc correctly. Wipe any dirt off the playing surface with a soft cloth.

## Cleaning the pick up lens

- Never use commercially available cleaning discs. The use of these discs can damage the lens.
- Request the nearest service center approved by Yamaha to clean the lens.

## ■ Notice for watching 3D video images

- Some people may experience discomfort (such as eye strain, fatigue, or nausea) while watching 3D video images. We recommend that all viewers take regular breaks while watching 3D video images.
- If you experience any discomfort, stop watching the 3D video images until the discomfort subsides. Consult a doctor if you experience severe discomfort.
- Read the owner's manuals (Blu-ray disc and TV) and/or the caution messages that appear on the TV carefully.
- The vision of young children (especially those under six years old) is still under development. Consult your doctor (such as a pediatrician or eye doctor) before allowing young children to watch 3D video images.
- Adults should supervise young children to ensure they follow the recommendations described above.



## ■ Front panel

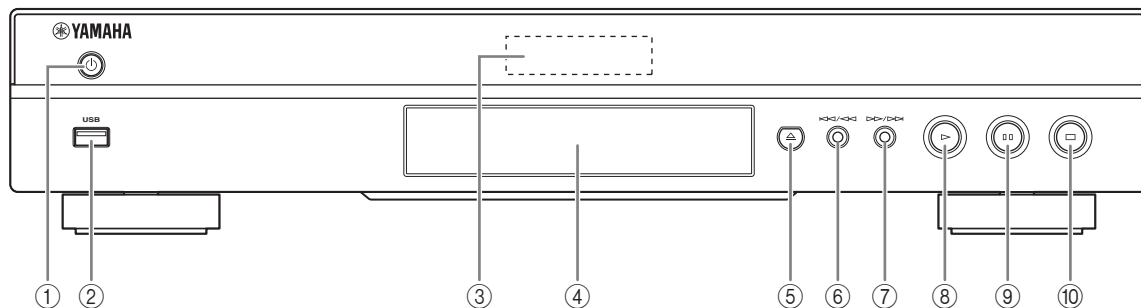



- ① (On/Standby)
- ② **USB port** (p. 16)
- ③ **Front panel display**
- ④ **Disc tray** (p. 4)
- ⑤ **(Eject)** (p. 4)
- ⑥ **(Search backward/Skip backward):**  
Press to skip backward, and press and hold to search backward.
- ⑦ **(Search forward/Skip forward):**  
Press to skip forward, and press and hold to search forward.
- ⑧ **(Play)**
- ⑨ **(Pause)**
- ⑩ **(Stop)**

## Remote control

### Note

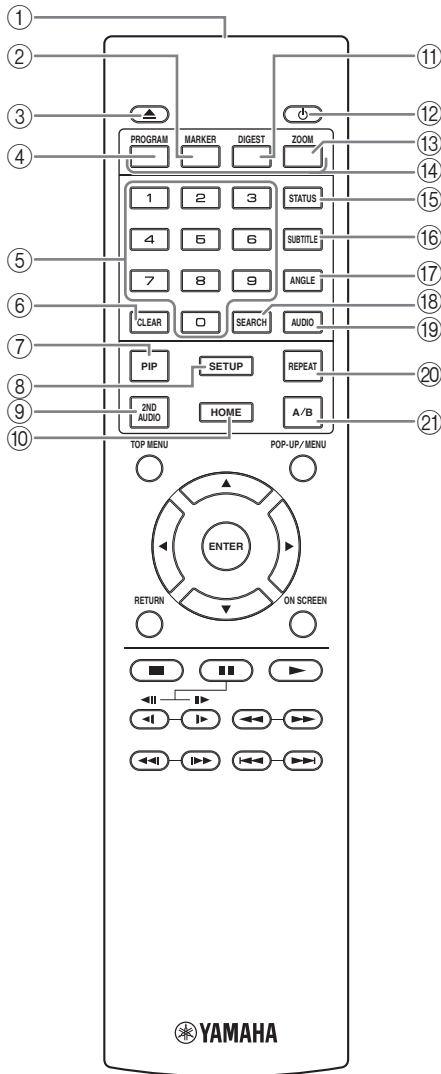
-  will appear on the top left corner of the screen when the pressed button is not available.



- ① **Infrared signal transmitter:** Outputs infrared signal. Aim this window to the remote control sensor (p. 9).
  - ② **MARKER DVD VIDEO:** Sets Bookmark (p. 28) at a specified point of a movie. After Bookmark is set, to select the set point you want to jump to, press **DIGEST**. You can set up to 12 Bookmarks.
  - ③ **▲:** Opens/closes the disc tray.
  - ④ **PROGRAM DVD CD:** Sets the order of playback (p. 28). You can set up to 15 tracks (for an audio disc) or titles/chapters (DVD-Video).
  - ⑤ **Number buttons:** Enters numbers, or during playback, jumps to the track/chapter corresponding to the number you input. These buttons may not be available depending on the disc type and playback condition.
  - ⑥ **CLEAR:** Clears entered number/set item.
  - ⑦ **PIP BD:** Turns on/off the Picture in Picture (p. 29). PIP Mark () is displayed on the screen when this function is available. You can also select this item from On Screen menu (p. 26).
- Note**
- PIP Mark is displayed only when the PIP Mark is set to on (p. 34).
- ⑧ **SETUP:** Displays SETUP menu screen (p. 30).
  - ⑨ **2ND AUDIO BD:** Selects the secondary audio of the Picture in Picture (p. 29) or audio commentaries. The Secondary Audio Mark () is displayed on the screen when this function is available (p. 37). You can also select this item from On Screen menu (p. 26).
- Note**
- Secondary Audio Mark is displayed only when Secondary Audio Mark is set to on (p. 34).
- ⑩ **HOME:** Displays the HOME menu screen (p. 19).
  - ⑪ **DIGEST PHOTO:** Shows 12 photo thumbnails. When thumbnails are displayed, you can proceed to the next/previous page with **◀◀/▶▶**.
  - DVD VIDEO:** Displays Bookmark select bar (p. 28).
  - ⑫ **⏻:** Turns this Player on or sets it to the standby mode.
  - ⑬ **ZOOM DVD VIDEO PHOTO:** Zooms in/out. The size of the screen will change each time you press the button (zoom in/out: 3 steps each).
  - ⑭ **Color buttons BD:** Use these buttons according to on-screen instructions.
  - ⑮ **STATUS:** Displays the playback information (p. 27).

- ⑩ **SUBTITLE** **BD** **DVD** **VIDEO** : Changes subtitle languages (p. 45) if available . You can also select this item from On Screen menu (p. 26).
- ⑪ **ANGLE** **BD** **DVD** : Changes the camera angle if video is recorded with multiple angles. The Angle Mark () is displayed on the screen when this function is available. You can also select this item from On Screen menu (p. 26).

**Note**

– Angle Mark is displayed only when the Angle Mark is set to on (p. 34).

- ⑫ **SEARCH** **BD** **DVD** **CD** **VIDEO** **MUSIC** : Jumps to a specified point during playback. For details on this function, refer to “Using search” (p. 28). You can also select this item from status menu (p. 27).
- ⑬ **AUDIO** **BD** **DVD** : Changes the audio language or format. You can also select this item from On Screen menu (p. 26).

- ⑭ **REPEAT** **BD** **DVD** **CD** **VIDEO** **MUSIC** **PHOTO** : Changes repeat mode. Repeat mode shown below will change each time you press the button.

: Repeats the title being played back.

: Repeats the chapter being played back.

: Repeats the folder being played back.

: Repeats all tracks/files on the disc.

: Repeats the track/file being played back.

**Shuffle All:** Plays back all the tracks/files on the disc randomly.

- ⑮ **A/B** **BD** **DVD** **CD** **VIDEO** **MUSIC** : Plays back a specific part you want to repeat.

- 1 Press **A/B** at the scene where you want to set the start point. “A-” is displayed on the screen.
- 2 Press **A/B** again at the scene where you want to set the end point. “A-B” is displayed on the screen. Repeat playback starts.
- 3 To cancel the repeat playback, press **A/B**. “A-B” disappears and the repeat playback is finished.

**Note**

– This function cannot be performed depending on the specifications of the disc.

**Continued to the next page. →**

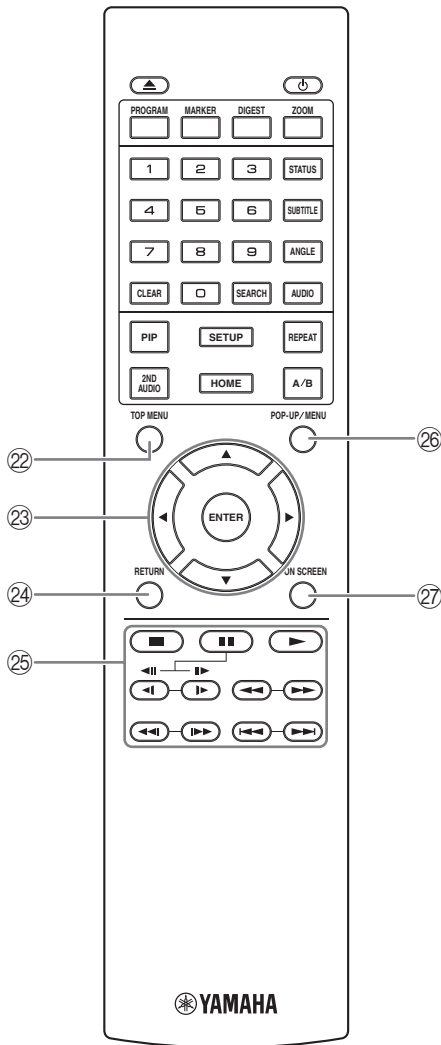

- 22 **TOP MENU** [BD] [DVD]: Displays the top menu screen (p. 45) if the disc contains a menu. Select the desired item using ▲/▼/◀/▶ and **ENTER**.

**Note**

- Specific operations may be different depending on the disc. Follow the instructions of each menu screen.

- 23 **Cursor buttons** (▲/▼/◀/▶): Moves the focus in the menu screen.

**ENTER**: Selects the focused menu/item.

- 24 **RETURN**: Returns to the previous menu or screen, etc.

25 **Control buttons**

[BD] [DVD] [CD] [VIDEO] [MUSIC] [PHOTO]

■: Stops playback. To stop playback completely, press this button twice.

■: Pauses playback.

▶: Plays back contents.

◀ (◀||) / ▶ (||▶)

[BD] [DVD]: Performs slow backward/forward. Slow playback speed will change each time you press the button (slow backward/forward: 4 steps each).

These buttons also perform frame advance/reverse playback during pause.

Press ▶ to resume normal playback.

◀◀/▶▶

[BD] [DVD] [CD] [VIDEO] [MUSIC]:

Searches backward/forward. The search speed will change each time you press the button (search backward/forward: 5 steps each). Press ▶ to resume normal playback.

[PHOTO]: Changes the speed of a slide show (slower/faster: 3 steps).

◀◀|/▶▶ [BD] [DVD] [CD] [VIDEO] [MUSIC]:

Press for instant search/replay. Instant search skips the content 30 seconds. Instant replay replays the content from 10 seconds before.

◀◀/▶▶: Skips backward/forward.

**Notes**

- Some BD/DVD discs are not compatible with frame advance/reverse playback.
- Depending on the disc, this Player resumes playback from the point that where the Player was previously stopped. To play back from the beginning, press ■ twice and then ▶.

- ②⑥ **POP-UP/MENU** [BD] [DVD]: Displays pop-up menu. The menu contents displayed vary depending on the disc. For details on how to see and operate the pop-up menu, refer to the manual for the disc. The top menu screen may be displayed by pressing **POP-UP/MENU** depending on the DVD.
- ②⑦ **ON SCREEN:** Displays On Screen menu (p. 26).

## ID function

You can change the remote control ID to prevent unwanted operation of the other Yamaha player such as DVD player. If you have changed the remote control ID, make sure that you select the same ID for the main unit. The default setting is ID1.

### 1 Remote control setting

To change the ID from ID1 to ID2, press and hold the red color button and **2** of number button simultaneously for 7 seconds. To change the ID from ID2 to ID1, press and hold the red color button and **1** of number button simultaneously for 7 seconds.

### 2 Main unit setting

Press and hold **◀◀/◀◀** and **▶▶/▶▶** on the front panel simultaneously for 2 seconds to display current ID when:

- No disc is inserted in this Player.
- The disc tray is closed.
- Playback is stopped.
- “NO DISC” is displayed on the front panel display.

Keep pressing and holding the keys for another 2 seconds to change the ID between ID1 and ID2.

### Note

- If the remote control is without batteries for a few minutes or if exhausted batteries remain in the remote control, the remote control ID is automatically set to ID1. If you want to use the remote control in ID2 setting, install new batteries and set the remote control ID again.

## Loading the batteries in the remote control

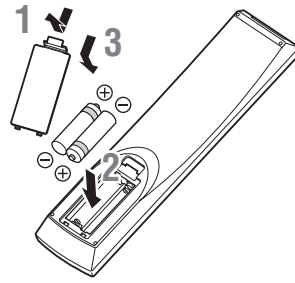

### Notes

- Do not subject the remote control unit to shock, water or excessive humidity.
- The remote control unit may not function if the Player's remote sensor is in direct sunlight or any other strong light.
- Incorrect use of batteries may cause them to leak or burst. Read the battery warnings and use the batteries properly.
- Do not mix old and new batteries, or mix different brands.
- Remove the batteries if you will not use the remote control unit for an extended period of time.
- Dispose of batteries according to your regional regulations.

## Approximate operating range of remote control

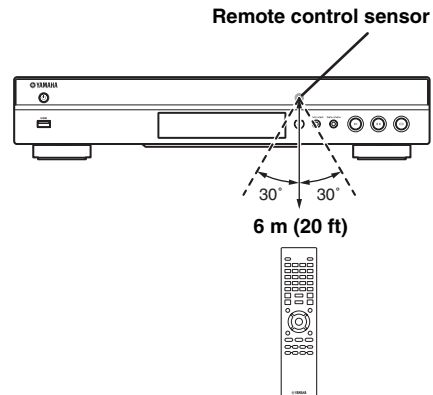

# INTRODUCTION TO CONNECTIONS

Find the corresponding connection method on your video/audio equipment. We recommend that you use the HDMI terminal which provides high quality digital audio and video on a single connection. If you use the other terminals/jacks, connect the video first. Then connect the audio.

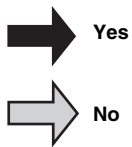
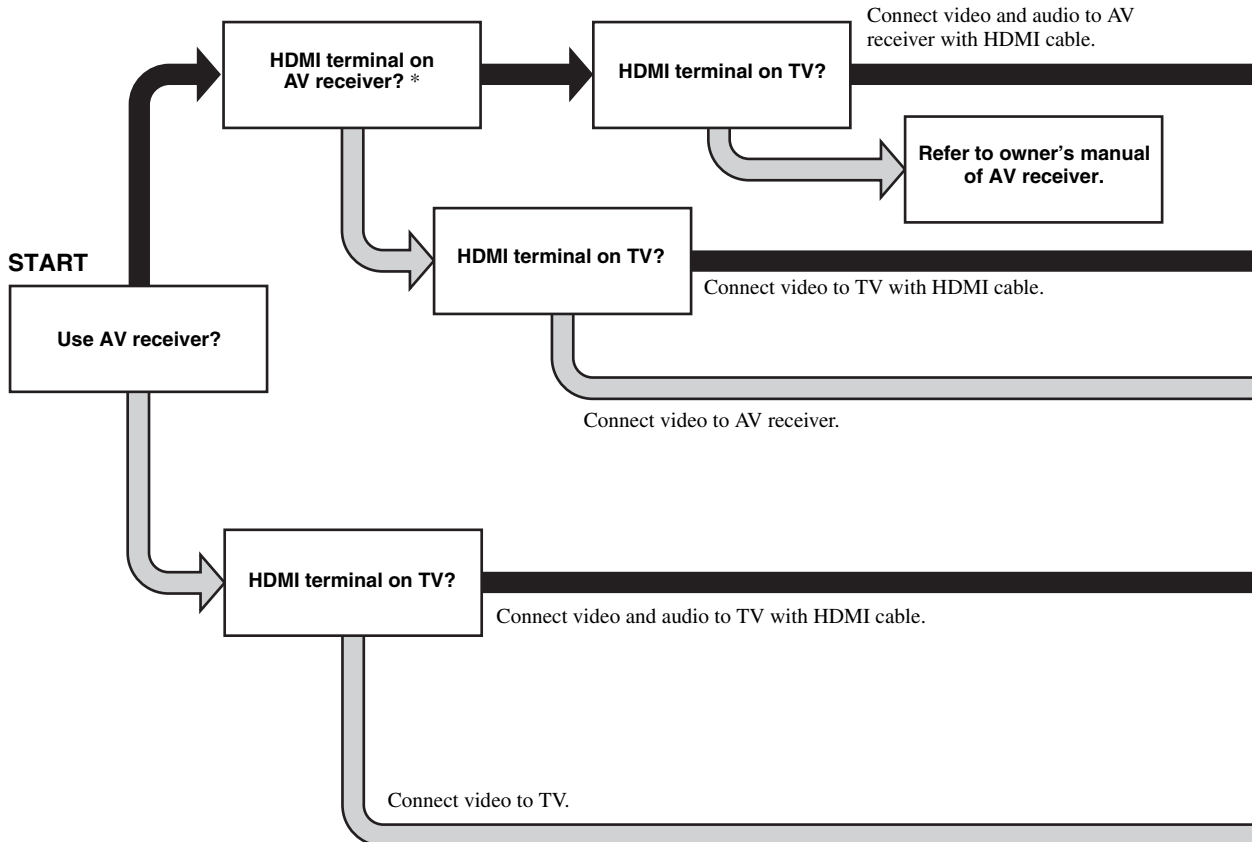

\* When you connect to an AV receiver that cannot output the sound, input via its HDMI terminal, refer to the owner's manual of your AV receiver.

## ■ Rear panel

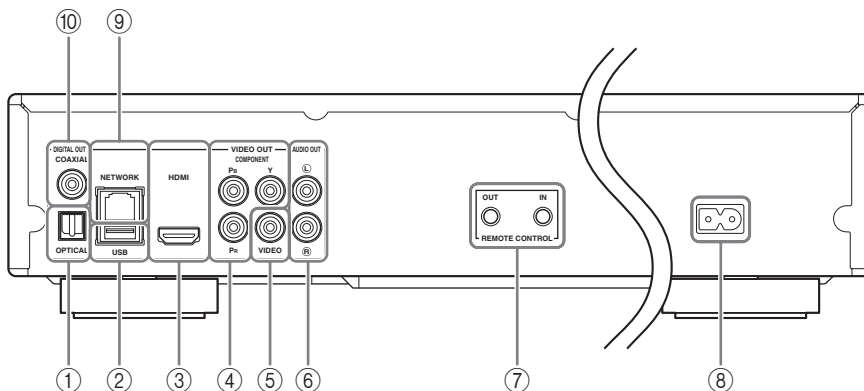

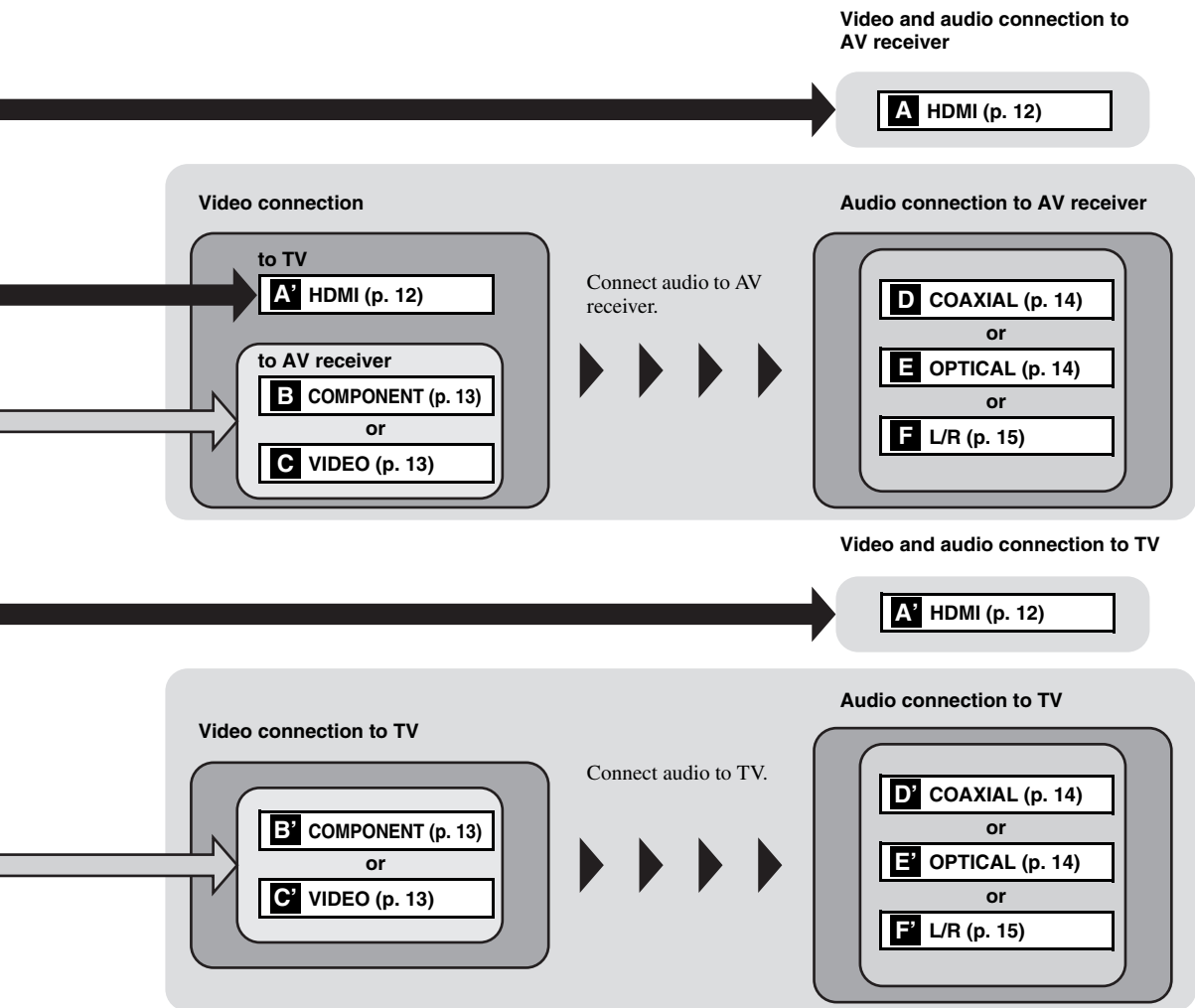

- ① OPTICAL (p. 14)
- ② USB (p. 16)
- ③ HDMI (p. 12)
- ④ COMPONENT (p. 13)
- ⑤ VIDEO (p. 13)

- ⑥ AUDIO OUT (L/R) (p. 15)
- ⑦ REMOTE CONTROL (OUT/IN) (p. 17)
- ⑧ AC IN (p. 17)
- ⑨ NETWORK (p. 16)
- ⑩ COAXIAL (p. 14)

# HDMI CONNECTION

## ■ Connecting to the HDMI terminal

- You can enjoy high quality digital picture and sound through the HDMI terminal.
- Firmly connect an HDMI cable (commercially available) to the HDMI terminals.
- See page 38 for information on the audio/video output formats.
- Use HIGH SPEED HDMI cables that have the HDMI logo (as shown on the back cover).

### Caution!

**Do not connect the power cable of this Player until all connections are completed.**

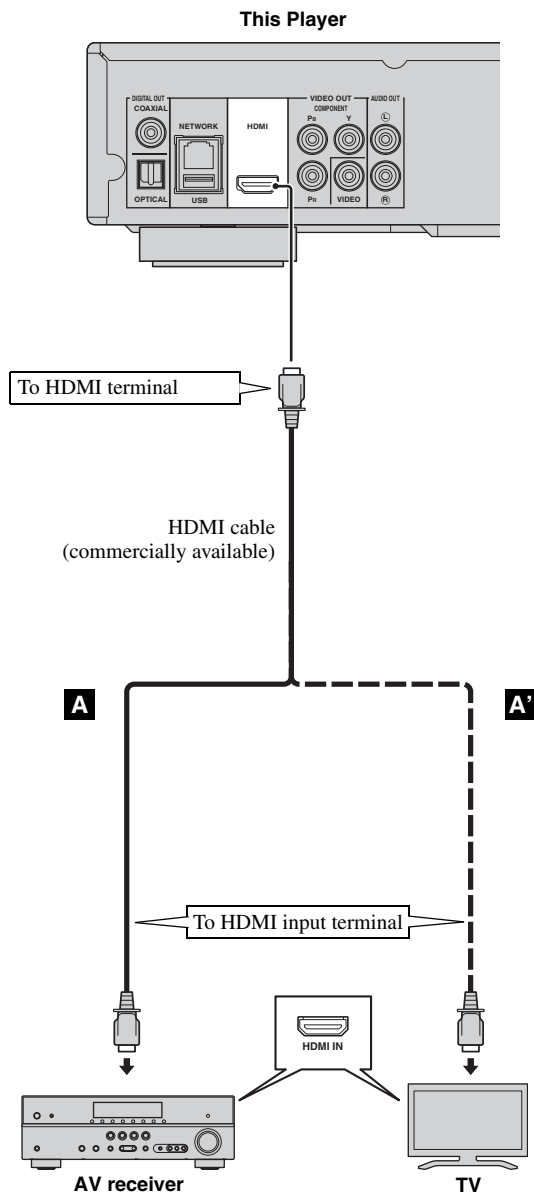

### Hints

- When you use the HDMI Control function, refer to the "HDMI Control" (p. 33).
- For information on the output mode of HDMI terminal, refer to the "HDMI" (p. 37).
- When no picture is displayed, refer to "TROUBLESHOOTING" (p. 42).

## ■ Connection for the playback of Blu-ray 3D discs

To enjoy Blu-ray 3D discs on this Player, you need the following equipments and connections:

- You need a TV and an AV Receiver (if you need) that have 3D functionality.
- All the components must be connected with HDMI cables.
- Blu-ray disc should contain 3D images.



# VIDEO CONNECTIONS

## ■ Connecting to the component/video jack

- You can enjoy accurate color reproduction and high quality images through the component jacks.
- Firmly connect a component video cable (commercially available) or a video pin cable to the COMPONENT jacks/ VIDEO jack.
- See page 39 for information on the video output formats.

### Caution!

**Do not connect the power cable of this Player until all connections are completed.**

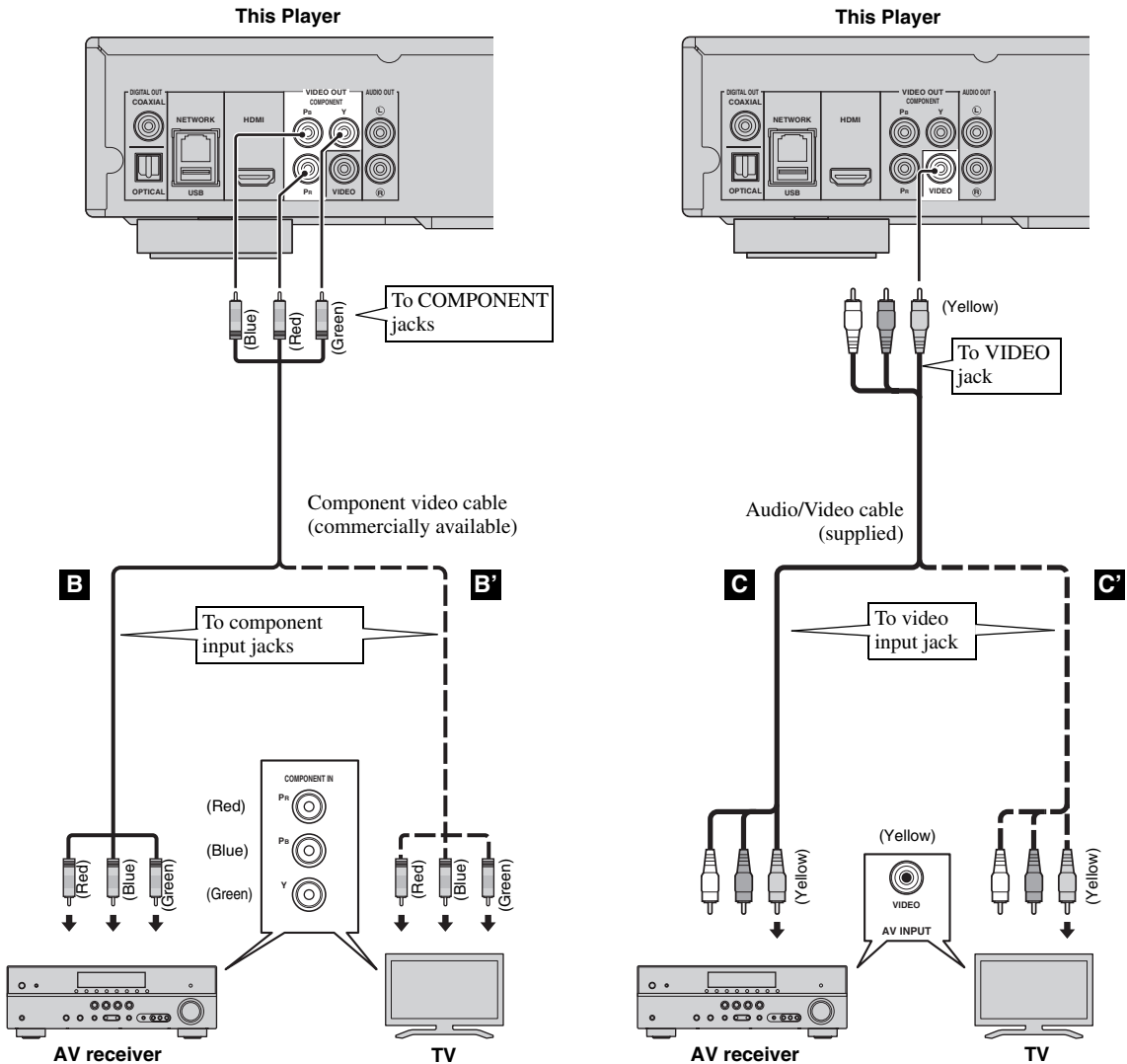

### Notes

- If you play back the image via VCR, the image may deteriorate due to the copy guard function.
- To enjoy BD-3D discs on this Player, you need to connect an AV receiver, a TV, and this Player using HDMI cables. Refer to the previous page.

# AUDIO CONNECTIONS

## ■ Connecting to the digital audio jack/terminal

- You can connect audio equipment or the TV to the COAXIAL jack/OPTICAL terminal.
- Firmly connect a Coaxial digital audio cable (commercially available) or optical cable (commercially available) to the coaxial digital audio jack or optical digital audio terminal.
- See page 38 for information on the audio output formats.

### Caution!

**Do not connect the power cable of this Player until all connections are completed.**

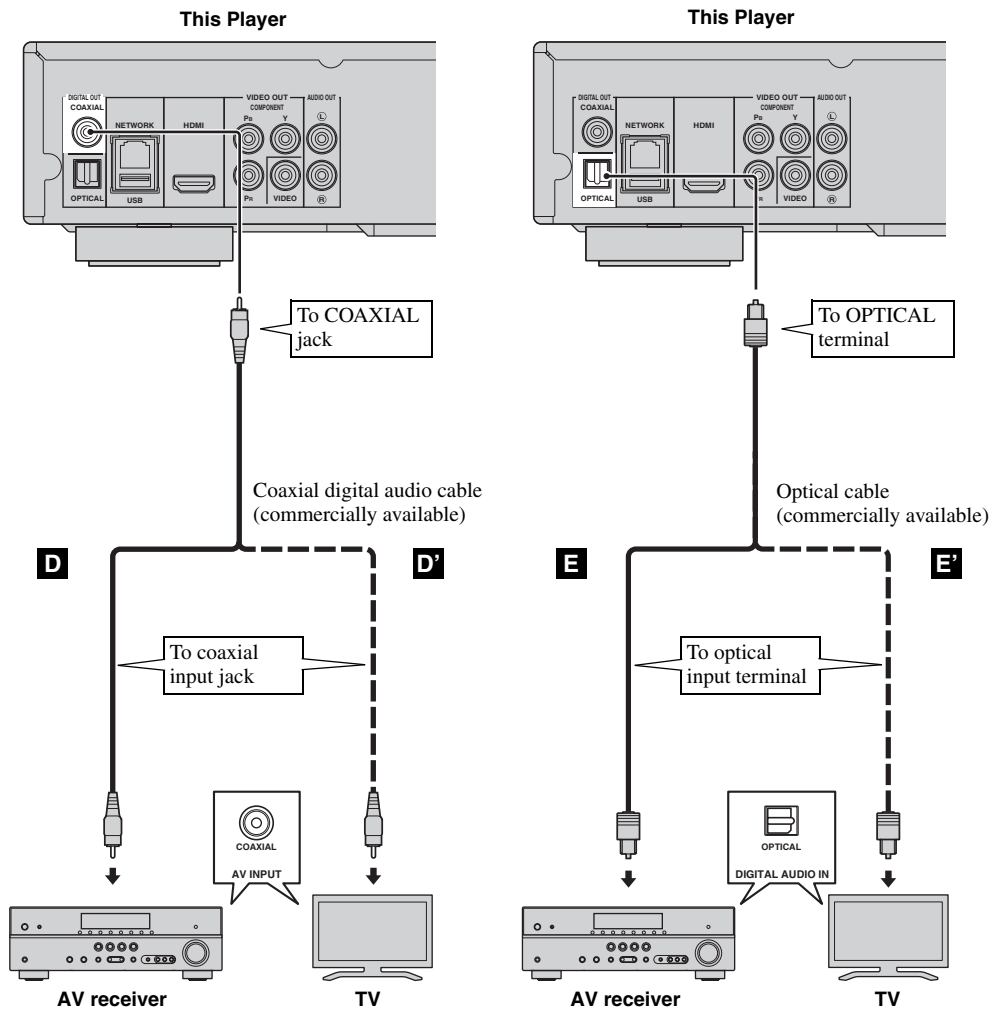

### Hint

- For information on the output mode of COAXIAL jack/OPTICAL terminal, refer to the "Coaxial/Optical" (p. 37).

## ■ Connecting to the audio jacks

- You can connect audio equipment or the TV to the AUDIO OUT L/R jacks.
- Firmly connect an Audio/Video cable (supplied) to the AUDIO OUT L/R jack.
- See page 38 for information on the audio output formats.

### Caution!

**Do not connect the power cable of this Player until all connections are completed.**

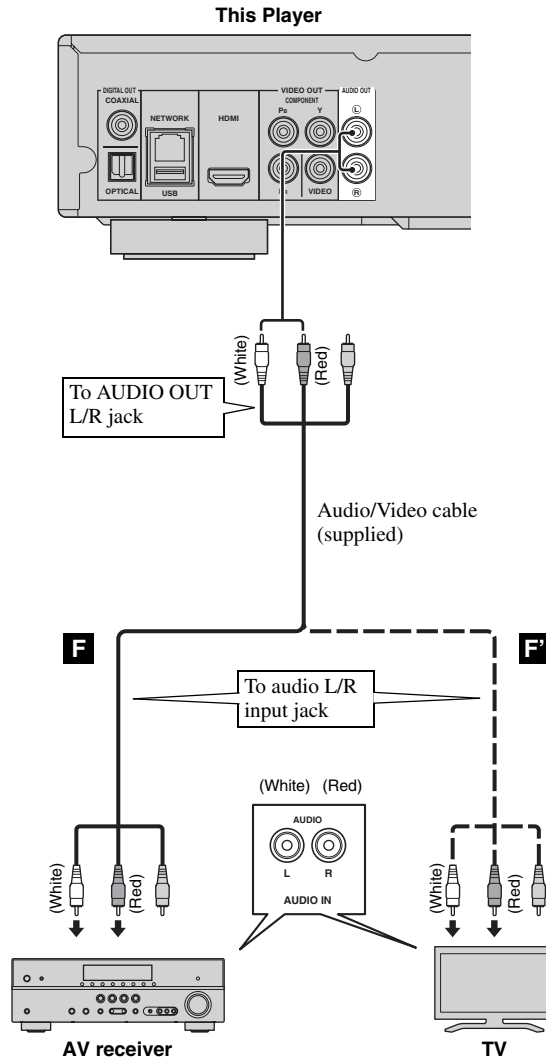

# NETWORK AND USB CONNECTION

## ■ Connecting to the NETWORK terminal and USB port

- PC contents can be played back by connecting this Player to the network.
- You can enjoy a variety of contents with interactive functions by connecting to the internet when playing BD-Live compatible discs. Refer to page 29 regarding further information on BD-Live functions.
- You can connect a USB memory device (2 GB or greater and formatted with FAT 32/16) for BD Local Storage to the USB port on the rear panel (or front panel) of the player to save the BD-Live data or to upgrade the software of this Player.
- Firmly connect a network cable (commercially available) and a USB memory device (commercially available) to the NETWORK terminal and USB port.
- Use only an STP (shielded twisted pair) network cable.
- When using the internet, a broadband internet connection as shown below is required.
- Connect the other connector of the network cable to the hub/broadband router.

## Before using the USB memory device

### CAUTION:

- Do not remove the USB memory device or unplug the power cable while the operations for BD-Live (p. 29) or software upgrade are being performed.
- Do not use a USB extension cable when connecting a USB memory device to the USB port of the Player. Using a USB extension cable may prevent the Player from performing correctly.

### Note

- Yamaha cannot guarantee that all brands' USB memory devices will operate with this Player.

### Notes

- When using a broadband internet connection, a contract with an internet service provider is required. For more details, contact your nearest internet service provider.
- Refer to the operation manual of the equipment you have as the connected equipment and connection method may differ depending on your internet environment.
- Use a network cable/router supporting 10BASE-T/100BASE-TX.

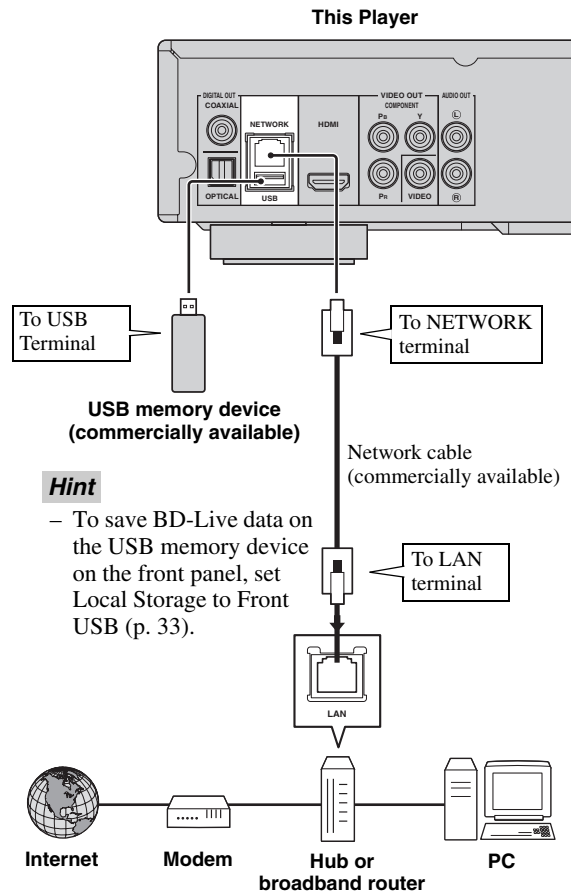

## After connecting

- When you set the Network setting manually, refer to “Network” (p. 35).
- To play back the PC contents on your network, refer to “Using network content” (p. 21).

# OTHER CONNECTIONS

## ■ Connecting to the REMOTE CONTROL jacks

- You can transmit and receive the remote control signals by connecting to the REMOTE CONTROL (OUT/IN) jacks.
- Firmly connect monaural 3.5 mm mini plug cables (commercially available) to the REMOTE CONTROL (OUT/IN) jacks.
- If your AV receiver is a Yamaha product and has the capability to transmit SCENE control signals, you can control the Player with the SCENE function.

### Caution!

**Do not connect the power cable of this Player until all connections are completed.**

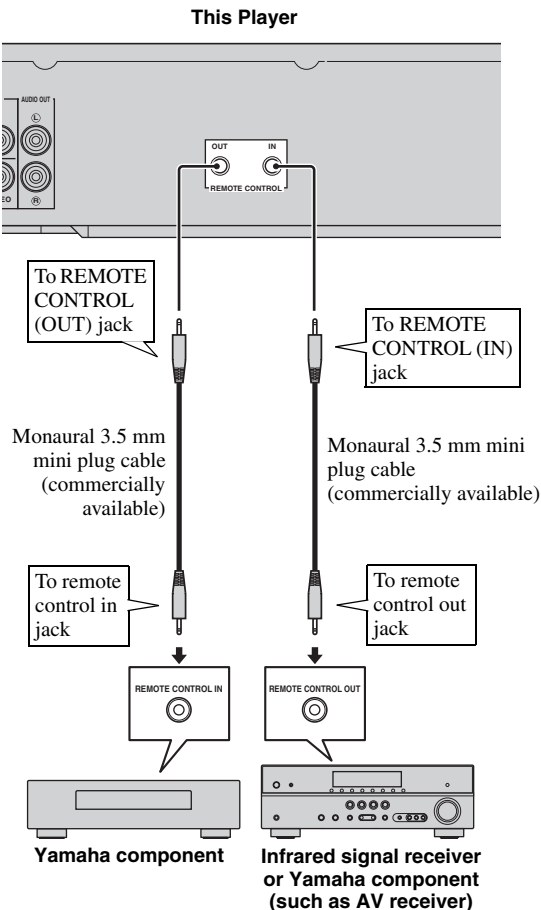

### Hints

- For details about the SCENE function, refer to the owner's manual supplied with your Yamaha AV receiver.
- You can connect a Yamaha component (such as CD player) supports the SCENE function to the REMOTE CONTROL (OUT) jack of this Player.

## ■ Connecting the power cable

- After all connections are completed, plug the supplied power cable into the AC IN on the rear of the Player. Then plug into AC outlet.

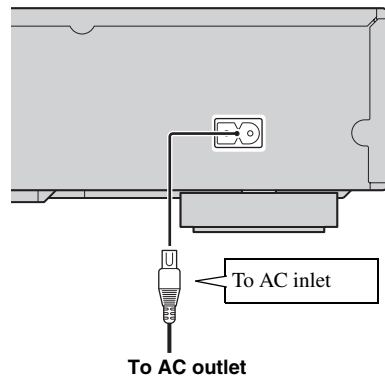

### Note

- TO PREVENT RISK OF ELECTRIC SHOCK, DO NOT TOUCH THE UN-INSULATED PARTS OF ANY CABLES WHILE THE POWER CABLE IS CONNECTED.

# INITIAL WIZARD/EASY SETUP

## ■ Setting with the Initial Wizard/ Easy Setup

Initial Wizard/Easy Setup allows you to set language, resolution, and screen aspect ratio easily. Initial Wizard screen is displayed when you turn this Player on for the first time after purchase or upgrade. Same setting can be performed from SETUP menu → System → Easy Setup.

- 1 When Easy Setup screen is displayed, Press **ENTER** to start Easy Setup.

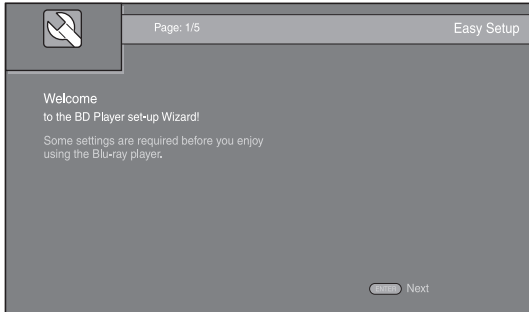

- 2 Press **▲/▼** to select the language you want to display on the screen, then press **ENTER**.

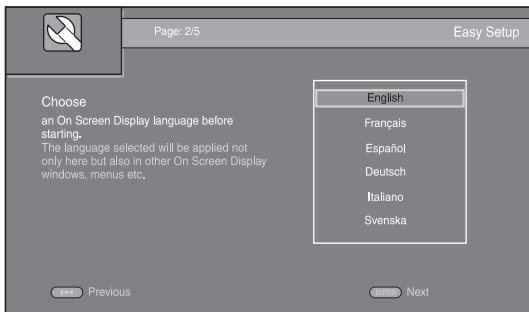

- 3 Press **▲/▼** to select the resolution, then press **ENTER**. For details on setting items, see “Resolution” (p. 36).

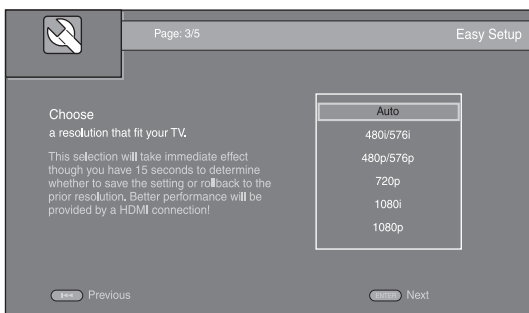

- 4 Press **▲/▼** to select the screen aspect ratio, then press **ENTER**. For details on setting items, see “TV Screen” (p. 35). Easy Setup is completed.

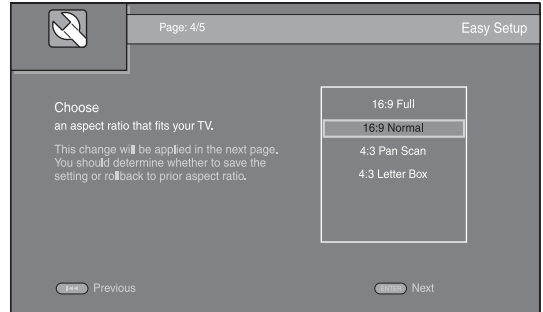

- 5 Press **ENTER** to exit Easy Setup.

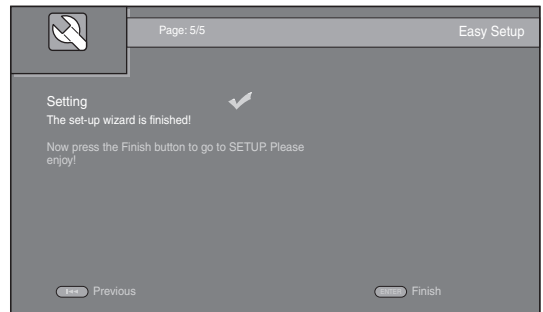

### Notes

- When no picture is displayed after Initial Wizard/ Easy Setup is completed, refer to “TROUBLESHOOTING” (p. 42).
- A warning message concerning 3D video playback appears when this Player is turned on. Press **ENTER** to dismiss the message or **CLEAR** to disable it (p. 33).

# HOME/MEDIA MENU

HOME and MEDIA menus allow you to browse and play multi-media files on data discs, USB memory devices and your network.

## Note

- For details on playable disc and format, see page 3.

## ■ Playing back photo/music/video

### Basic operation

▲/▼: Moves the focus.

◀: Returns to the parent folder.

▶: Checks/unchecks single folder/file.

HOME: Moves to/exits HOME menu screen.

ENTER: Confirms the folder/file.

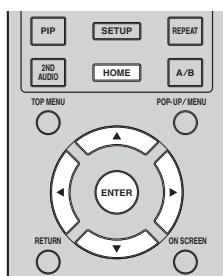

### Icons on the top of MEDIA menu

🎯: Plays back the disc on the tray, or displays contents in the data disc.

🗑️: Displays contents in the USB memory device connected to the USB port.

🔍: Searches for a DLNA (p. 21) server on the network.

🖥️: Displays contents on the connected DLNA server.

### Common operations for playing back files in a selected folder

**Example:** Selecting a movie file on a USB memory device

## Note

- Stop the playback of the video before you move to MEDIA menu screen.

- 1 Press **HOME** to move to HOME menu screen. Press **◀▶** to select MEDIA, then press **ENTER**.



- 2 MEDIA screen appears.

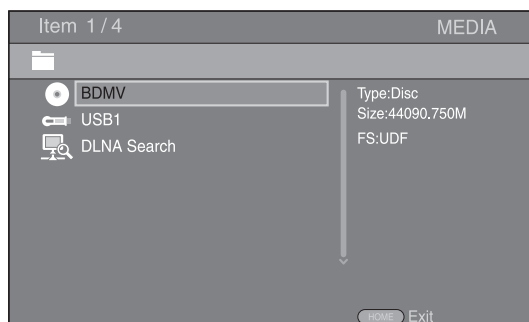

- 3 Select the item which contains the file you want to play back, then press **ENTER**.

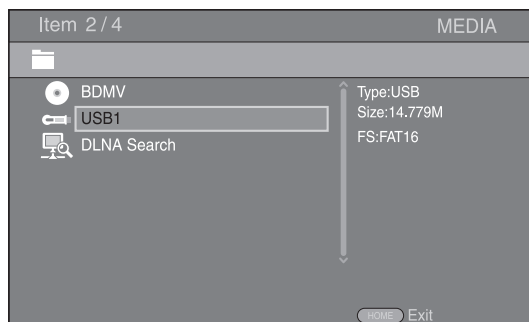

- 4 Select the Photo, Music, Video or AVCHD folder you want to play back, then press **ENTER**.

To return to the parent folder, press **◀** or select **⬆**.

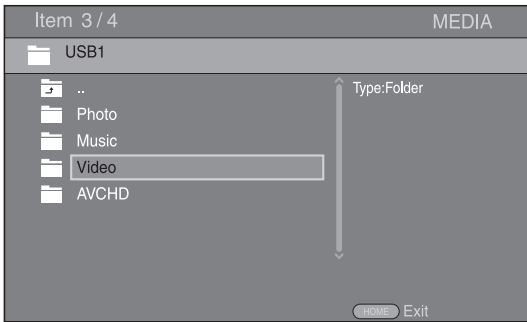

#### Note

- Note that the only the file type selected on this step will be displayed in the following step. For example, if you selected Photo folder in this step, only photo files are displayed after this step. When you play back other than photo, return to this hierarchy and select file type again.

- 5 Select the folder(s) containing the file you want to play back.

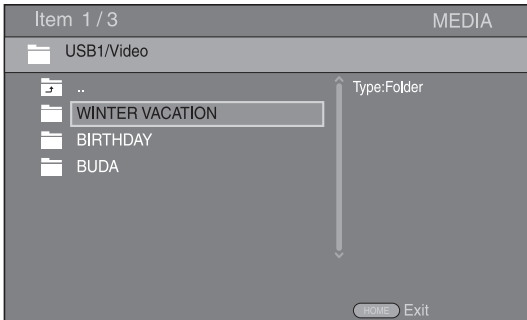

- 6 Select the file you want to play back, then press **ENTER**.

When a video file is selected, playback starts.

When a music file is selected, status screen is displayed and playback starts.

When a photo file is selected, slide show starts.

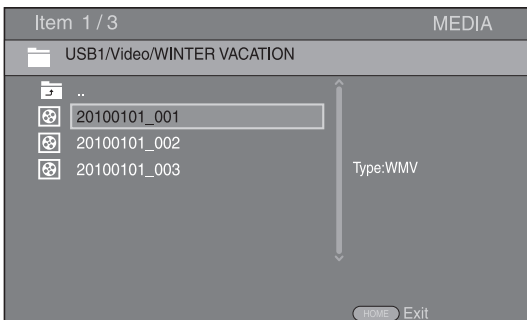

#### Hint

- To enjoy slide show with music, press **HOME** to return to the HOME menu screen while music is played back, and select photo file.

#### Note

- The displayed file may not be played back depending on the content.

### Operations for viewing photos

While viewing photos, the buttons on the remote control work as shown below.

- : Stops slide show and returns to the file browser.
- : Pauses a slide show.
- ▶: Plays a slide show.
- ▶▶: Moves to a next photo.
- ◀◀: Moves to a previous photo.
- ▶▶▶: Makes a slide show faster in 3 steps.
- ◀◀◀: Makes a slide show slower in 3 steps.
- ▲: Inverts a photo.
- ▼: Reflects a photo.
- ◀: Rotates a photo counterclockwise.
- ▶: Rotates a photo clockwise.
- ▶▶▶: Zooms in/out a photo (zoom in/out: 3 steps each).
- ▲/▼/◀/▶: Pan in zoom mode when a photo is larger than the screen.
- DIGEST:** Switches to thumbnail mode (p. 6). When thumbnails are displayed, you can proceed to the next/previous page with ◀◀◀/▶▶▶.



## ■ Using network content

This Player is a DLNA certified digital media player. You can manage photo, music and video contents stored on DLNA servers on your home network.

### About DLNA

DLNA (Digital Living Network Alliance) provides easy sharing of digital media through network in the home, and you can enjoy digital contents stored on your DLNA-server-software-installed PC or other DLNA compatible device with your TV via this Player. To connect this Player to your DLNA servers, some settings for the DLNA server or device are required. For details, refer to your DLNA server software or DLNA device.

### Playing back shared contents

- 1 To play back files on your PC, install a DLNA server software, such as Windows Media Player 12, and share files you want to play back.
- 2 Turn on the PC with DLNA server software installed or the DLNA device connected to your home network.
- 3 Press **HOME** to display HOME menu screen. Then select **MEDIA** to move to MEDIA menu. The DLNA servers connected to the network are listed on the screen.

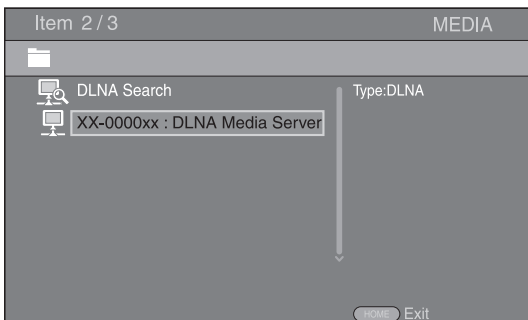

#### Notes

- If your DLNA server is not listed, select DLNA Search to find it.
  - Depending on the DLNA server, this Player may need to be permitted from the server.
  - To play the file on the DLNA server, this Player and the server must be connected to the same access point.
  - The file requirements may not always be compatible. There may be some restrictions depending on file features and DLNA sever capability.
- 4 Select the file you want to play back.

#### Notes

- The playback and operating quality may be affected by your home network condition.
- The files from removable media such as USB memory devices or DVD-drive on your media server, may not be shared properly.

## USING NETWORK SERVICES

You can instantly watch the videos that the following network services provide.

- YouTube
- Netflix (p. 23)
- Blockbuster (p. 24)
- Film Fresh (p. 25)

### Notes

- Access to content provided by third parties requires a high speed internet connection and may also require account registration and a paid subscription.
- Third party content services may be changed, suspended, interrupted, or discontinued at any time without notice, and Yamaha disclaims any liability in connection with such occurrences.
- Some content may only be available for specific countries and may be presented in specific languages.
- Yamaha does not represent or warrant that content services will continue to be provided or available for a particular period of time, and any such warranty, express or implied, is disclaimed.

## PLAYING VIDEOS FROM YouTube™

You can watch movies from YouTube over the internet using this Player.

The services may be changed without notice.

- 1 Press **HOME** to display HOME menu screen.

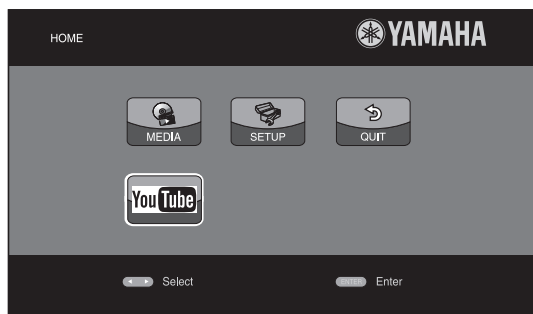

### Hint

- The HOME menu screen may differ depending on the model.

- 2 Press **▲/▼/◀/▶** to select YouTube, then press **ENTER**.

### Hint

- To return to the HOME menu screen, press **RETURN**.

# PLAYING VIDEOS FROM NETFLIX

You can instantly watch movies and TV episodes from Netflix over the internet using this Player. To become a Netflix member, visit <http://www.netflix.com>.

## ■ Checking the activation code

Before you watch videos from Netflix, you need to get an activation code displayed on your TV.

- 1 Press **HOME** to display HOME menu screen.  
Press ◀▶ to select NETFLIX, then press **ENTER**.

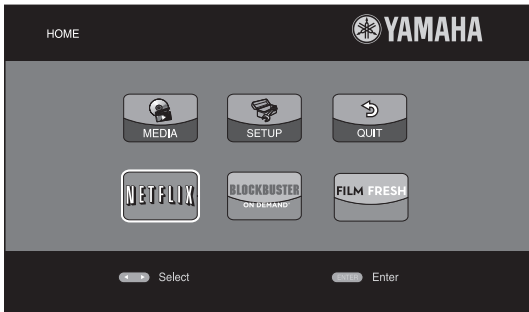

- 2 Follow the instructions on the screen to get an activation code.

### Hint

- To return to the HOME menu screen, press **RETURN**.

### Notes

- When a software upgrade is required, an update notice appears when you select Netflix. In this case, perform the software upgrade.
- For details on Netflix, refer to the Netflix website on <http://www.netflix.com>.
- To deactivate Netflix, refer to “Netflix Information” (p. 34).

## ■ Preparing for watching video on your computer

You need to complete the activation of this Player through the internet with your computer. After that procedure, you can instantly watch movies and TV episodes from Netflix. Enter the activation code displayed on your TV to complete activation of Netflix function in this Player.

For details, refer to the Netflix website on <http://www.netflix.com>.

## ■ Playing a video

- 1 Press **HOME** to display HOME menu screen.  
Press ◀▶ to select Netflix, then press **ENTER**.
- 2 According to the instructions on the screen, select the video, then start playback.

# PLAYING VIDEOS FROM BLOCKBUSTER

You can instantly watch movies from BLOCKBUSTER over the internet using this Player. For details about this feature, visit <http://www.blockbuster.com>.

## ■ Creating your account

Before using this feature, create your BLOCKBUSTER account and get the activation code for this unit with your computer.

- 1 Visit the following website.  
<http://www.blockbuster.com/yamaha>
- 2 Click “Activate” on the website.
- 3 Sign in or create a free “blockbuster.com” account according to the instruction on the screen.
- 4 According to the instructions on the screen, get a 5-digit activation code to activate this Player.

### Hint

- We recommend that you write the activation code down to bring it to this Player.

## ■ Activation of the account

- 1 Press **HOME** to display HOME menu screen.

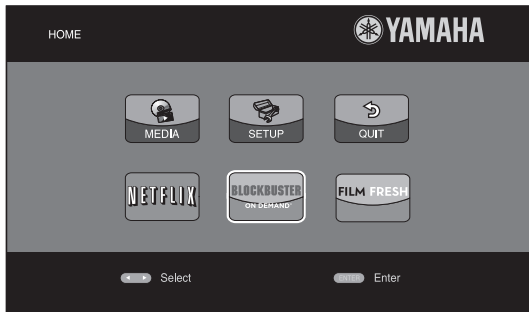

### Hint

- To return to the HOME menu screen, press **RETURN**.
- 2 Press **▲/▼/◀/▶** to select BLOCKBUSTER then press **ENTER**.
  - 3 Press **◀/▶** to select “Configure”, then press **ENTER**.

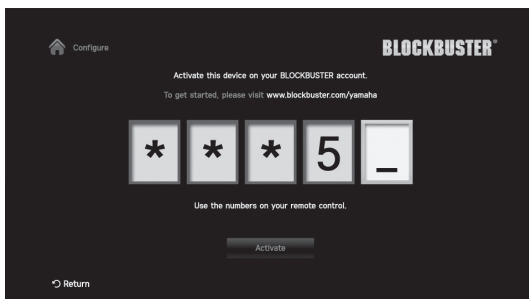

- 4 Enter the 5-digit activation code with the number buttons, then press **ENTER**.

## ■ Playing the video

- 1 Press **HOME** to display HOME menu screen.
- 2 Press **◀/▶** to select BLOCKBUSTER, then press **ENTER**.
- 3 Select “Browse”.
- 4 According to the instructions on the screen, select the desired titles, then rent or purchase them.
- 5 Select “Play Now” or “Continue Browsing”.

### Hint

- The titles you have rented or purchased will appear in “My Library”. Press **◀/▶** to select a title, then select “Play Now” or “Resume Play”.

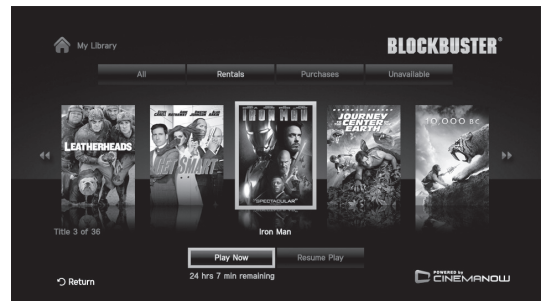

## ■ Operations for watching videos

- ▶ : Plays back the video.
- ⏸ : Pauses playback.
- ⏹ : Stops video and displays “My Library”.
- ENTER**: Pauses playback and performs frame advance/reverse playback.
- ◀/▶ : Pauses playback and performs frame advance/reverse playback.
- ◀◀/▶▶ : Pauses playback and performs search backward/forward. To play back from the desired point, press **ENTER/▶▶**.
- RETURN**: Returns to “My Library” menu.

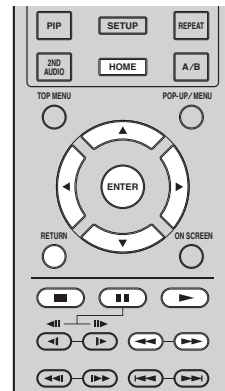

# PLAYING VIDEOS FROM FILM FRESH

You can instantly watch movies from Film Fresh over the internet using this Player. For details about this feature, visit <http://filmfresh.roxionow.com>.

## ■ Creating your account

Before using this feature, create your Film Fresh account and get an activation code for this unit with your computer.

- 1 Visit the following website:  
<http://filmfresh.roxionow.com>
- 2 Click “My Account” on the website.
- 3 Sign in or create a free “Film Fresh” account according to the instruction on the screen.
- 4 Follow the instructions on the screen to get a 5-digit activation code to activate this Player.

### Hint

- We recommend that you write the activation code down to bring it to this Player.

## ■ Activation of the account

- 1 Press **HOME** to display HOME menu screen.

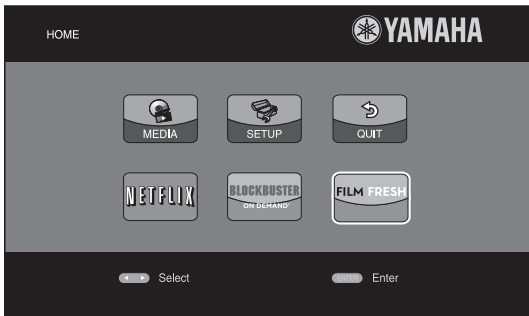

### Hint

- To return to the HOME menu screen, press **RETURN**.
- 2 Press **▲/▼/◀/▶** to select FILM FRESH then press **ENTER**.
  - 3 Press **◀/▶** to select “Configure”, then press **ENTER**.



- 4 Enter the 5-digit activation code with the number buttons, then press **ENTER**.

## ■ Playing the video

- 1 Press **HOME** to display HOME menu screen.
- 2 Press **◀/▶** to select FILM FRESH, then press **ENTER**.
- 3 Select “Movies” or “TV Shows”.
- 4 According to the instructions on the screen, select the desired titles, then rent or purchase them.
- 5 Select “Watch Now” or “Continue Browsing”.

### Hint

- The titles you have rented or purchased will appear in “My Videos”. Press **◀/▶** to select a title, then select “Watch From Start” or “Resume Play”.

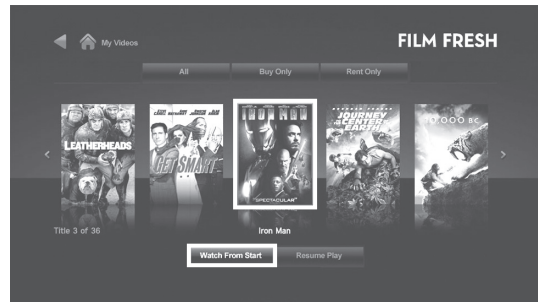

## ■ Operations for watching videos

- ▶: Plays back the video.
- : Pauses playback.
- : Stops video and displays “My Videos”.
- ◀◀/▶▶: Pauses playback and performs search backward/forward. To play back from the desired point, press **ENTER/▶▶**.
- RETURN**: Returns to “My Videos” menu.

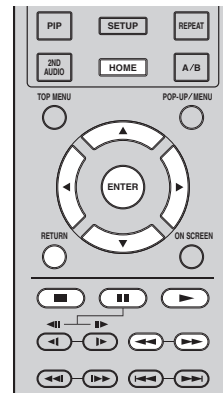

# ADVANCED PLAYBACK OPERATION

This chapter explains playback of commercially available BD and DVD discs, CDs, and recorded DVD-RW/R discs.

## Note

- For the basic playback operation, see page 6.

## ■ On Screen menu

To display On Screen menu, press **ON SCREEN**. After that, press **▲/▼/◀/▶** to select an item, then press **ENTER** to operate the desired function.

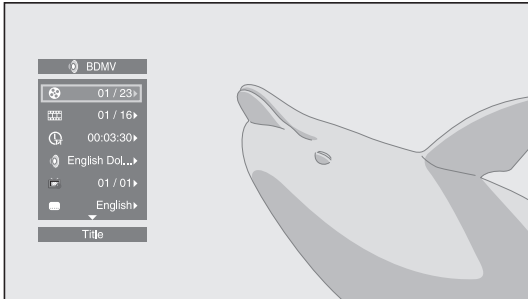

On Screen menu contains following items.

**Title** **BD** **DVD** **VIDEO**: Shows the title number being played back. You can skip to the desired title by selecting it from this item.

**Chapter** **BD** **DVD** **VIDEO**: Shows the chapter number being played back. You can skip to the desired chapter by selecting it from this item.

**Track/File** **CD** **VIDEO** **MUSIC** **PHOTO**: Shows track/file number being played back. You can skip to the desired track/file by selecting it from this item.

**Time** **BD** **DVD** **CD** **VIDEO** **MUSIC**: Shows the playback time. Select display type from the following:

- Elapsed playback time of the title, chapter, disc, track or file
- Remaining playback time of the title, chapter, disc, track or file

## Mode/Play Mode

**DVD** **CD** **VIDEO** **MUSIC** **PHOTO**: Shows current playback mode. You can select playback mode from the following:

### CD

- Normal: Normal playback.
- Shuffle: Random playback without repetition.
- Random: Random playback with repetition.

### DVD

- Normal
- Shuffle CH (chapter)
- Shuffle TT (title)
- Shuffle All
- Random CH (chapter)
- Random TT (title)
- Random All

### VIDEO MUSIC PHOTO

- Normal
- Shuffle F (folder)
- Shuffle All
- Random F (folder)
- Random All

**Audio** **BD** **DVD** **VIDEO**: Shows audio language/signal of BD/DVD disc currently selected. You can select the desired type of audio.

**Angle** **BD** **DVD**: Shows the currently-selected angle number. If the video is recorded with multiple angles, you can change the angle.

**Subtitle** **BD** **DVD** **VIDEO**: Shows the currently-selected subtitle language when the subtitle is provided.

**Subtitle Style** **BD**: Shows the currently-selected subtitle style. This function is available only for Video-file external subtitle. You can select the desired text style of subtitle.

**Bitrate** **BD** **DVD** **CD** **VIDEO** **MUSIC**: Shows bitrate of the audio/video signal.

**Second Video** **BD**: Turns the PIP on/off (p. 6).

**Second Audio** **BD**: Turns the secondary audio on/off (p. 6).

## Ins Search

**BD** **DVD** **CD** **VIDEO** **MUSIC**: Skips 30 seconds.

## Ins Replay

**BD** **DVD** **CD** **VIDEO** **MUSIC**: Replays the content from 10 seconds before.

## Slide Show **PHOTO**:

Shows slide show speed. You can select the slide show speed from Slow/Medium/Fast.

**Transition** **PHOTO**: Shows how photo appears on the screen. You can select the transition type.

**Code Page** **VIDEO**: Selects character code of subtitle you added to DivX video (p. 44).

## ■ Status menu

This shows various settings, such as subtitles, angle settings and the title/chapter/track number currently played back. To display status menu, press **STATUS**. Status menu contains following menus.

**BD DVD VIDEO**

**Example:** Icons when playing BD

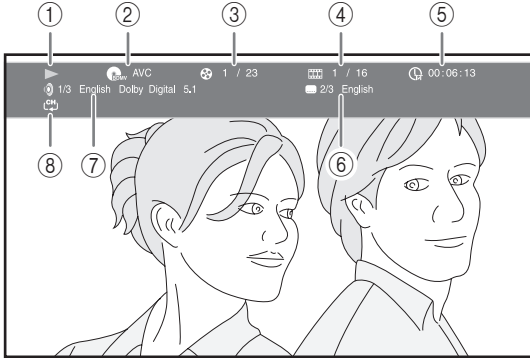

- ① **▶ (Playback status)**
- ② **BDMV (Disc type/video file icon)**
- ③ **⊗ (Title number being played):** You can jump to specified title with **SEARCH** button (p. 7).
- ④ **⊞ (Chapter number being played):** You can jump to specified chapter with **SEARCH** button (p. 7).
- ⑤ **⌚ (Elapsed playback time):** You can jump to specified point with **SEARCH** button (p. 7).
- ⑥ **⋮ (Subtitle currently selected):** You can change the subtitle language with **SUBTITLE** button.
- ⑦ **🔊 (Audio currently selected):** You can change the audio language or format with **AUDIO** button.
- ⑧ **↺ (Repeat mode):** Shows current repeat mode (p. 7).

**CD MUSIC**

**Example:** Icons when playing music file

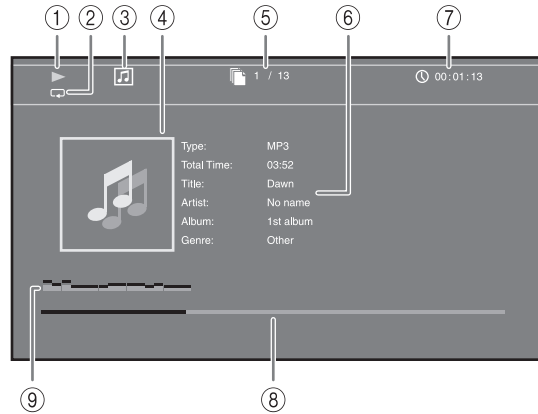

- ① **▶ (Playback status)**
- ② **↺ (Repeat mode):** Shows current repeat mode (p. 7).
- ③ **🎵 (Disc type/music file icon)**
- ④ **(Artwork) MUSIC:** Displays artwork if the file contains it.
- ⑤ **📄 (Track/file number being played):** You can jump to specified track with **SEARCH** button (p. 7).
- ⑥ **(Information) MUSIC:** Displays music information if the file contains them.
- ⑦ **⌚ (Elapsed playback time):** You can jump to specified point with **SEARCH** button (p. 7).
- ⑧ **(Progress bar) MUSIC:** Shows progress status of current song.
- ⑨ **(Audio level meter):** displays current volume level.

**PHOTO**



- ① **▶ (Playback status)**
- ② **🖼️ (Photo file icon)**
- ③ **📄 (File number being displayed)**
- ④ **↺ (Repeat mode):** Shows current repeat mode (p. 7).
- ⑤ **(Slide show speed)**

## ■ Using Bookmark DVD VIDEO

This allows you to set Bookmark at the specified point of the video. After Bookmark is set, you can move to the point you set using this function. You can set up to 12 Bookmarks.

- 1 Press **MARKER** during playing back the movie to set Bookmark. Bookmark number, and the status are displayed.



- 2 After Bookmark is set, press **DIGEST** to display Bookmark select bar.



- 3 Press **◀/▶** to select the Bookmark you want to play back, then press **ENTER**. Press **CLEAR** to delete the selected Bookmark.

### Note

- When playback is finished (e.g., ejecting the disc, pressing **■** twice), Bookmarks are automatically deleted.

## ■ Program play DVD CD

This allows you to program playback order of audio disc tracks or DVD chapters.

Press **PROGRAM** during playback to display the PROGRAM window to program playback order. You can program up to 15 tracks/chapters.

**Example:** Programming the playback order of CD tracks

- 1 Press **PROGRAM** during playback.

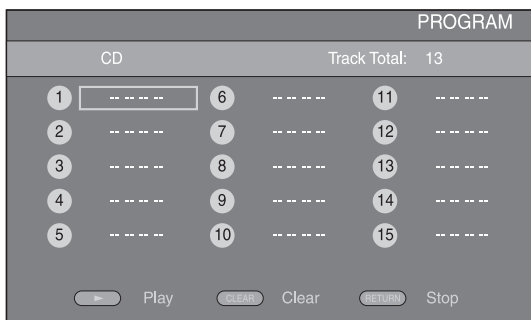

- 2 Press **ENTER** to program playback order. For audio disc, press **▲/▼** to select a desired track then press **ENTER**. For DVD-Video disc, select a desired title (shown as TT) and chapter (shown as CH) instead of a track. To clear a set track, select the track you want to clear, then press **CLEAR**. Press **RETURN** to cancel the Program play.

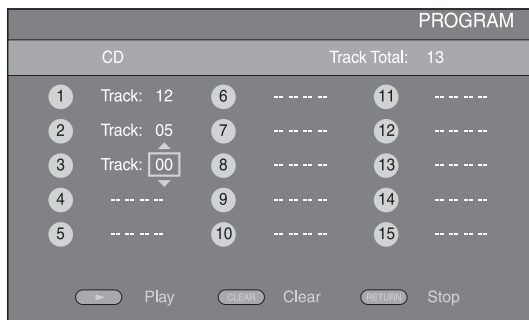

- 3 After programming is finished, press **▶** to set and start program playback.
- 4 To cancel program play, stop playback completely by pressing **■** twice.





## ■ Using search

BD DVD CD VIDEO MUSIC



This allows you to jump to the specified point during playback.

- 1 Press **SEARCH** during playback. Status bar appears.
- 2 Press **▲/▼/◀/▶** to select one of the item below, then press **ENTER**.



BD DVD :

- Title number (shown as )
- Chapter number (shown as )
- Elapsed title time (shown as )
- Elapsed chapter time (shown as )

CD :

- Track number (shown as )
- Elapsed track time (shown as )
- Elapsed disc time (shown as )

VIDEO MUSIC :

- File number (shown as )
- Elapsed file time (shown as )

- 3 Press **▲/▼** or number buttons to set/adjust the value of the focused item, and press **ENTER** to jump to the specified point.
- 4 To close the status bar, press **STATUS**.



## ■ Enjoying BONUSVIEW™ and BD-Live™

This player supports BONUSVIEW (p. 44) (BD-ROM Profile 1 Version 1.1) and BD-Live (p. 44) (BD-ROM Profile 2) playback functions.

### Note

- Functions and playback method vary depending on the disc. See the guidance on the disc or the supplied user's manual.

## ■ Using Picture in Picture function (secondary audio/video playback)

BD-Video that includes secondary audio and video compatible with Picture in Picture can be played back with secondary audio and video simultaneously as a small video in the corner.

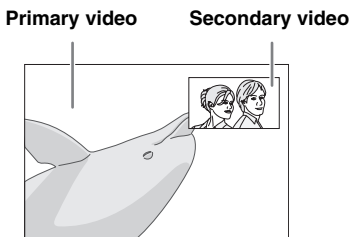

**While PIP Mark (PIP) or Secondary Audio Mark (SA) is displayed, press PIP to turn the Picture in Picture function on/off.**

### Notes

- To listen to secondary audio, make sure that the Audio Output setting (Coaxial/Optical or HDMI) is set to PCM or Reencode (p. 37).
- Depending on the disc, to listen to secondary audio, you may need to set secondary audio to on on the top menu of the disc (p. 8).
- The secondary audio and video for Picture in Picture may automatically play back and be removed depending on the content. Also, playable areas may be restricted.

## ■ Using the feature of BD-Live™

### 1. Set the Network setting (p. 35).

### 2. Connect the USB memory device to this Player (p. 16).

BD-Live data is saved in a USB memory device connected to this Player. To enjoy these functions, connect a USB memory device (2 GB or greater and formatted with FAT 32/16) supporting USB 2.0 High Speed (480 Mbit/s) to the USB port that you select on Local Storage (p. 33). The default setting is the USB port on the rear panel.

- BUDA folder is created automatically in the USB memory device when necessary.
- If there is insufficient storage space, the data will not be copied/downloaded. Delete unneeded data or use a new USB memory device.
- Some time may be required for the data to load (read/write).

### Notes

- Yamaha cannot guarantee that all brands' USB memory devices will operate with this Player.
- Do not use a USB extension cable when connecting a USB memory device to the USB port of the player. Using a USB extension cable may prevent the player from performing correctly.

### 3. Play back the disc.

### 4. Run BD-Live according to the instructions on the disc.



### Notes

- Regarding playback method of BD-Live contents, etc., perform the operations in accordance with the instructions in the BD disc manual.
- To enjoy BD-Live functions, perform the network connection (p. 16) and Network settings (p. 35).
- Refer to “BD-Live Connection” (p. 35) regarding the setup to restrict access to BD-Live contents.
- The time required to download the provided programs into the USB memory device connected to this Player varies depending on the internet connection speeds and the data volume of the programs.
- BD-Live programs provided through the internet may not be able to display the connection depending on the status (upgrading) of the provider. In such cases, take out the disc and try again.
- If the BD-Live screen does not appear for a while after you select the BD-Live function in the BD disc menu, the USB memory device may not have enough free space. In such cases, eject the disc from the player, and then erase the data in the USB memory device using the “Format” menu in the “Local Storage” (p. 33).

# SETUP MENU

The SETUP menu enables various audio/visual settings and adjustments for functions using the remote control unit.

Menu/Submenu	Item	Function	Page
 <b>General Setting</b>	<b>System</b>		
	Screen Saver	Sets screen saver on/off.	33
	Disc Auto Playback	Sets this Player to start disc playback automatically.	33
	HDMI Control	Sets this Player to receive control signal from the remote control of your TV/AV receiver.	33
	Network Control	Sets the control via Ethernet to on/off.	33
	Load Default	Resets all settings to the default setting except Security setting.	33
	Upgrade	Performs upgrade of this Player.	33
	Easy Setup	Sets language, resolution, screen aspect ratio.	33
	Local Storage	Displays status of Local Storage (p. 33), formats Local Storage and selects the front/rear USB port for Local Storage.	33
	3D Playback Message	Displays a warning message concerning 3D video playback when this Player is turned on.	33
	<b>Language</b>		
	OSD	Selects the language for On Screen Display.	34
	Menu	Prioritizes the language for disc menu.	34
	Audio	Prioritizes the language for audio.	34
	Subtitle	Prioritizes the language for subtitle.	34
	<b>Playback</b>		
	Closed Caption	Sets the closed caption to on/off.	34
	Angle Mark	Sets to display the Angle Mark when BD/DVD with multiple angles is played back.	34
	PIP Mark	Sets to display the PIP Mark when BD/DVD with Picture in Picture is played back.	34
	Secondary Audio Mark	Sets to display the Secondary Audio Mark when BD/DVD with secondary audio is played back.	34
	Last Memory	Sets this Player to remember the last playback position of a disc when it is set to the standby mode or the disc tray is opened.	34
	DivX(R) VOD DRM	Displays registration code for DivX(R) video.	34
	Netflix Information	Deactivates this Player from Netflix and displays ESN (Electronic Serial Number).	34
	<b>Security</b>		
	Change Password	Changes password for Parental Control and Country Code.	34
	Parental Control	Sets the Parental Control depending on the disc content.	34
	Country Code	Sets your Country Code.	34
	<b>Network</b>		
	Internet Connection	Sets the internet connection to Enable/Disable.	35
	Information	Displays network information screen.	35
	Connection Test	Performs the network connection test.	35
	IP Setting	Sets the IP setting to Auto/Manual.	35
	BD-Live Connection	Sets the BD-Live connection to Permitted/Partial Permitted/Prohibited.	35
DLNA	Sets the DLNA to Enable/Disable.	35	
Proxy Setting	Sets the proxy setting.	35	

Menu/Submenu	Item	Function	Page	
 <b>Display Setting</b>	<b>TV</b>	3D Output	Selects 3D or 2D videos.	35
		TV Screen	Sets the screen aspect ratio of the connected TV, and adjust the video output.	35
		Resolution	Selects the resolution of output video.	36
		TV System	Selects the TV System from NTSC/PAL/Multi.	36
		Color Space	Selects Color Space from YCbCr 4:4:4/YCbCr 4:2:2/ Full RGB/RGB.	36
		HDMI Deep Color	Selects HDMI Deep Color from 30 bits/36 bits/Off.	36
		HDMI 1080p 24Hz	Sets HDMI 1080p 24Hz to auto/off.	36
		Lip Sync	Adjusts the lag between video and audio, such as when the mouth movement is out of sync with the voice.	36
	<b>Video Process</b>	Video Mode	Adjusts the visual image.	36
		Color Adjust	Adjusts Brightness/Saturation/Hue for each color.	36
		Auto Contrast	Adjusts contrast to optimize the played back image.	36
		Noise Reduction	Sets the level of Noise Reduction.	36
		De-interlacing Mode	Sets how to detect the video signal.	36
	 <b>Audio Setting</b>	<b>Audio Output</b>	Coaxial/Optical	Selects the output mode of COAXIAL jack/OPTICAL terminal from Bitstream/PCM/Reencode/Off.
HDMI			Selects the output mode of HDMI terminal from Bitstream/PCM/Reencode/Off.	37
Downsampling			Selects the digital audio signal down sampling frequency from 48k/96k/192k.	37
DRC			Sets the DRC (Dynamic Range Compression).	37
<b>Speaker Setting</b>		2ch Downmix	Sets the audio output from AUDIO OUT L/R jack.	37
<b>Post Process</b>		Up Mix	Multi-channelizes the 2-channel audio signal.	37
 <b>System Information</b>		Displays software version and MAC address (p. 45).	37	

## ■ Example of SETUP menu operation

You need to call up the SETUP menu screen to perform settings for this Player. The following is the explanation for basic operations of the SETUP menu.

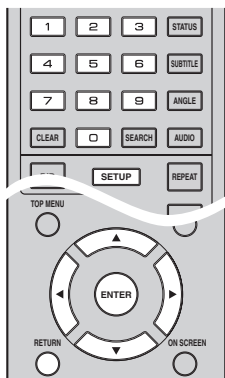

**Example:** Setting Parental Control

**Note**

- Some items cannot be set during playback. In this case, press **■** twice to stop playback completely before setting.

### 1. Display the SETUP menu screen.

Press **SETUP** to display the SETUP menu screen. Press **◀/▶** to select General Setting, then press **ENTER** or **▼**.

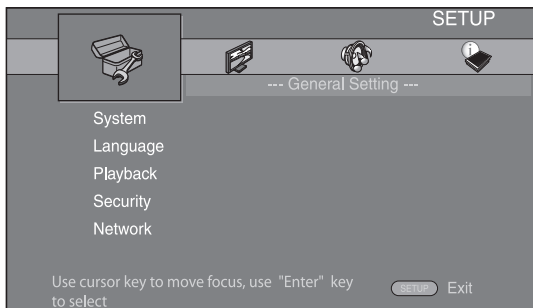

### 2. Select a Submenu.

Press **▲/▼** to select Security, then press **ENTER** or cursor **▶**.

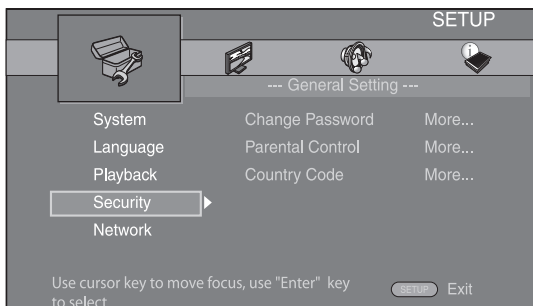

### 3. Select a menu item.

Press **▲/▼** to select Parental Control, then press **ENTER** or cursor **▶**.

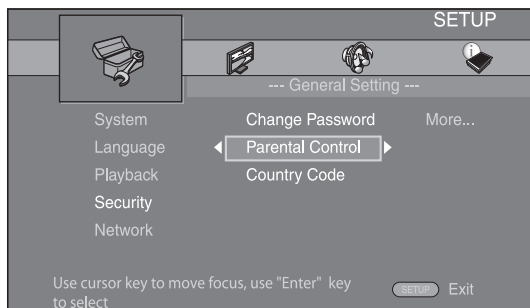

### 4. Enter password.

Enter your password with number buttons.

- The default password is 0000.
- You cannot move to the next setting screen until you have input the correct password.
- To change the password, refer to “Change Password” (p. 34).

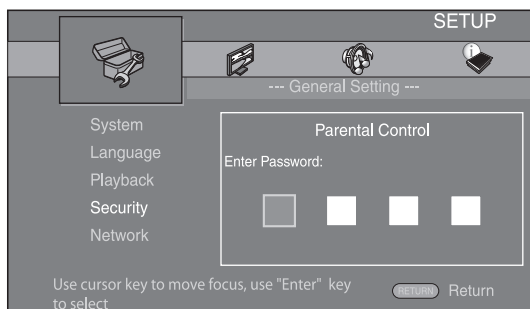

### 5. Select a next item.

Press **▲/▼** to select the Parental Control Level for BD/DVD, then press **ENTER**.

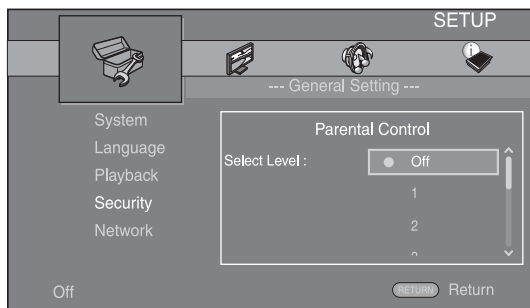

### 6. Exit the menu screen.

Press **◀** to return to the previous menu.

## ■ General Setting

The default settings are marked with “\*”.

### System

#### Screen Saver

You can set the screen saver to on/off.

When set to on, this Player will switch to screen saver mode if there is no operation for 5 minutes. After that, this Player will turn to standby mode when there is no operation for 20 minutes.

On\*, Off

#### Disc Auto Playback

You can set Disc Auto Playback to on/off. When set to on, a disc will play back automatically after loading.

On\*, Off

#### HDMI Control

You can set the Player to receive control signal from a TV/AV receiver compatible with the HDMI Control function via an HDMI cable (p. 12).

On, Off\*

#### Using HDMI Control function

Using the HDMI Control function, you can interactively operate this Player with your TV (HDMI Control function supported).

When you connect this Player to the TV compatible with the HDMI Control function using an HDMI cable and set HDMI Control in the SETUP menu to on (p. 33), you can perform the function listed below.

- Automatic input select function  
When you start playback of this Player, the input selector of the TV (and an AV receiver if this Player is connected to the TV via the AV receiver) is switched to this Player automatically. TV Power is turned on automatically depending on the TV.
- Automatic power off function  
When you turn off the TV while this Player is in stop mode and the SETUP menu screen is not displayed, the power of this Player is also turned off automatically.

#### Notes

- HDMI Control function may not work properly depending on the TV.
- Functions other than ones shown above may work depending on the TV or AV receiver.
- In order to make the HDMI Control function available, set up settings for the HDMI Control function on ALL components (this Player, TV, and AV receiver). Certain operation may also be required.
- Each function may be set independently to activate/deactivate depending on the TV.
- Refer to the operation manuals supplied with the TV and/or AV receiver for details regarding setup.
- When set to on, power consumption during standby mode increases due to HDMI control function.

## Network Control

You can set control via Ethernet to on/off. This player employs Yamaha Network Control protocol (YNC).

On, Off\*

#### Notes

- When set to on, power consumption during standby mode increases due to network control function.
- When set to on, the system startup time is decreased.

#### Load Default

You can reset all settings of this Player to default setting except Security setting (p. 34). For details on default settings, see pages 30-37.

#### Upgrade

You can upgrade the software manually from Disc, USB Storage or Network. For details on software upgrade, refer to “SOFTWARE UPGRADE” (p. 40).

#### Easy Setup

You can perform Easy Setup (p. 18).

#### Local Storage

You can display Local Storage information, format Local Storage, and select Front USB/Rear USB to save the BD-Live data.

To format (empty) the “BUDA” folder in the USB memory device, select Information and press **ENTER** when “Format” is focused on the screen.

#### Front USB, Rear USB\*

#### Hint

- Local Storage is used as an auxiliary memory when Blu-ray Disc is played back.

#### 3D Playback Message

You can turn on or off a warning message concerning 3D video playback that appears on the TV when this Player is turned on.

On\*, Off

## Language

### OSD

You can select the language for On Screen Display which is the messages or menu displayed on the screen such as SETUP menu.

English\*, Français, Español, Deutsch, Italiano, Svenska, Nederlandse, Русский, 中文

### Menu

You can prioritize the language for disc menu.

English\*, Français, 中文, Español, Deutsch, Italiano, Nederlandse, Portuguese, Danish, Svenska, Finnish, Norwegian, Русский, Korean, Japanese, More

### Audio

You can prioritize the audio language for BD/DVD playback. For details on setting items, see “Menu” (p. 34).

### Subtitle

You can prioritize the language for Subtitle.

English, Français, 中文, Español, Deutsch, Italiano, Nederlandse, Portuguese, Danish, Svenska, Finnish, Norwegian, Русский, Korean, Japanese, More, Off\*

## Playback

### Closed Caption

You can set to display the closed caption (p. 44) when BD/DVD with closed caption is played back.

On\*, Off

### Angle Mark

You can set to display the Angle Mark () when BD/DVD with multiple angles is played back.

On\*, Off

### PIP Mark

You can set to display the PIP Mark () when BD with picture in picture (p. 29) is played back.

On\*, Off

### Secondary Audio Mark

You can set to display the Secondary Audio Mark () when BD with secondary audio is played back.

On\*, Off

### Last Memory

You can set whether this Player remembers the last playback position of a disc when it is set to the standby mode or the disc tray is opened.

On\*, Off

#### Note

- Some discs are not compatible with this function.

### DivX(R) VOD DRM

You can display registration code for DivX(R) video.

## Netflix Information

You can deactivate this Player from Netflix and display ESN (Electronic Serial Number).

To activate this Player again, refer to “PLAYING VIDEOS FROM NETFLIX” (p. 23).

ESN (Electronic Serial Number) is a unique number that allows you to use Netflix streaming.

## Security

### Change Password

You can set the password for changing the Parental Control Level and Country Code. Refer to “Parental Control” (p. 34) and “Country Code” (p. 34).

#### Notes

- The default password is 0000.
- If you forget the password, refer to “TROUBLESHOOTING” (p. 41) and set all the Security settings to their default settings.

### Parental Control

In some BD/DVD discs, a control level for disc viewing is set depending on the age of the viewer. You can set the Parental Control shown on the screen depending on the disc content.

The password (see “Change Password” on p. 34) needs to be entered before the Parental Control Levels is set.

After you set the Parental Control, when you play back a disc with level higher than current Parental Control Level, or you want to change the Parental Control Level, a dialog box will pop up to ask you to enter the password.

Off\*, 1 to 8

### Country Code

You can set the Country Code you live in. The password (see “Change Password” on p. 34) needs to be entered before the Country Code is set. This setting may be used for rating of Parental Control and disc playback.

## Network

### Internet Connection

Set this item to Enable when you use BD-Live (p. 29), DLNA (p. 21) and software upgrade from the network (p. 40).

**Enable\*, Disable**

### Information

You can display network information screen. On this screen, you can view the information of Interface (Ethernet), Address Type, IP Address, Subnet Mask, Default Gateway, and DNS.

### Connection Test

You can perform an internet connection test. If the test is failed, please check "IP Setting" (p. 35) and perform the test again.

### IP Setting

You can configure the network settings.

- Auto\*** Select to automatically configure the network settings of this Player with the DHCP server.
- Manual** Select to configure the network settings (IP Address, Subnet Mask, Default Gateway, and DNS) manually.

#### Hints

- **Numeric keys** Enters characters.
- **◀/▶** Moves the highlight.
- **CLEAR** Deletes a character.
- **ENTER** Saves the settings and exits from the menu.

### BD-Live Connection

You can set access restriction to BD-Live contents.

- Permitted** Allows all BD-Live discs to connect the network.
- Partial Permitted\*** Allows only discs with owner certification.
- Prohibited** Prohibits all BD-Live discs to connect the network.

### DLNA

You can set the DLNA (p. 21) to Enable/Disable. When you do not use the DLNA function, set to Disable.

**Enable\*, Disable**

### Proxy Setting

You can set Proxy Setting. Set to Disable for normal use. Set to Enable to set the proxy setting.

- Enable** Enables proxy host and proxy port setting.
- Disable\*** Sets proxy server to disable. Select this item when proxy server is not used.
- Proxy Host** Sets proxy host.
- Proxy Port** Sets proxy port.

## Display Setting

The default settings are marked with "\*".

### TV

#### 3D Output

You can select 3D or 2D video output from this Player.

- Auto\*** This Player automatically selects 3D or 2D videos.
- Off** This Player always selects 2D videos.

#### Note

- Even if you set "3D Output" to "Auto" and play back a Blu-ray 3D disc, this Player selects 2D images depending on the connection and the setting of TV, etc (p. 12).



### TV Screen

You can set the screen aspect ratio of the connected TV, and adjust the video output.

If you switch your TV (i.e. because you have bought a new one) and the screen aspect ratio of the connected TV changes, you will have to change the TV Screen setting.

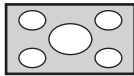
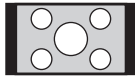
- 16:9 Full** Select this when this Player is connected to a TV with a 16:9 screen. When a 4:3 aspect ratio video is played back, the video is displayed as shown below.
- 16:9 Normal\*** Select this when this Player is connected to a TV with a 16:9 screen. When a 4:3 aspect ratio video is played back, the video is displayed as shown below.
- 4:3 Pan Scan** Select this when this Player is connected to a TV with a 4:3 screen. When a 16:9 aspect ratio video is played back, the video is displayed as shown below.
- 4:3 Letterbox** Select this when this Player is connected to a TV with a 4:3 screen. When a 16:9 aspect ratio video is played back, the video is displayed as shown below.

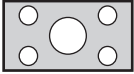
Original image size	On 16:9 (wide screen) TV	
	16:9 Full	16:9 Normal
 4:3		

Original image size	On 4:3 TV	
	4:3 Pan Scan	4:3 Letterbox
 16:9		

## Resolution

You can select the video output resolution from Auto, 480i/576i, 480p/576p, 720p, 1080i, and 1080p. When set to Auto, resolution is set to the maximum resolution according to the connected TV. For more details on output formats, refer to “About the video output formats” (p. 39).

**Auto\***, **480i/576i**, **480p/576p**, **720p**, **1080i**, **1080p**

### Note

- To output HD audio (such as Dolby TrueHD or DTS-HD Master Audio) from HDMI terminal, set Resolution to Auto or more than 720p.

## TV System

You can select TV System from PAL, NTSC and Multi. Set the same TV System as your TV set. For more details on output formats, refer to “About the video output formats” (p. 39).

**NTSC, PAL\***, **Multi** (Australia, Asia, China, U.K., Europe and Russia models)

**NTSC\***, **PAL**, **Multi** (U.S.A., Canada, Central and South America models)

## Color Space

You can select the Color Space (p. 44) output from HDMI. This function is available when this Player is connected with an HDMI cable.

**YCbCr 4:4:4\*** Sets Color Space to YCbCr 4:4:4.

**YCbCr 4:2:2** Sets Color Space to YCbCr 4:2:2.

**Full RGB** When RGB is set and white and black on the screen are too faint, select this item. This setting is effective when a connected component supports RGB 0-255 range.

**RGB** Outputs video signal at normal signal range.

### Note

- This function is only available on TVs that support this function.

## HDMI Deep Color

When your TV and/or AV receiver is compatible with Deep Color (p. 44), set this item according to your TV/AV receiver. This function is available when this Player is connected with an HDMI cable.

**30 bits**, **36 bits**, **Off\***

## HDMI 1080p 24Hz

This outputs the BD-Video encoded in 24Hz frame rate in HDMI 1080p 24Hz. Smoother video playback may be available with this function. This function is available when your TV/AV receiver support this function, and this Player is connected with an HDMI cable. For more details on output formats, refer to “About the video output formats” (p. 39).

**Auto\***, **Off**

### Note

- This setting is disabled when output resolution is other than 1080p.

## Lip Sync

You can set/adjust the Lip Sync (p. 45) function.

**Auto\*** This Player adjusts the Lip Sync function automatically.

**Manual** You can adjust the Lip Sync function manually. You can set the delay of the audio for 2D and 3D contents independently.

**2D**

**3D**

**Off** This Player does not adjust the Lip Sync function.

## Video Process

### Video Mode

You can select Video Mode below.

**Standard\*** The image is most natural and well-balanced. This mode suits for normal use.

**Vivid** The image is more vivid and sharp.

**Cinema** The image suits for watching movie in dark room.

**Custom** You can adjust the visual image manually. Press ▲/▼ to select the parameter, then press ◀/▶ to adjust the figure.

### Brightness

Adjusts the overall brightness of the image.

### Saturation

Adjusts the richness of the color in the projected image.

### Hue

Adjusts the tint of the projected image.

### Contrast

Adjusts the bright areas (white levels) in the image.

### Sharpness

Adjusts the sharpness of objects in the video.

### CTI

Smooths out the edges of color images. Color images are rendered more distinct.

**The default settings are 0.**

## Color Adjust

You can adjust Brightness/Saturation/Hue for each color (Red/Green/Blue/Yellow/Cyan/Magenta). To use this function, set Video Mode to Custom. For details on the setting items, see “Video Mode” (p. 36).

**The default settings are 0.**

## Auto Contrast

Adjusts contrast to optimize the played back image. To use this function, set Video Mode to Custom.

**Off\***, **On**

## Noise Reduction

You can set the Noise Reduction to a level of 0 to 3. 0 is off, and 3 is the maximum level.

**0\***, **1**, **2**, **3**

## De-interlacing Mode

You can select how to detect the video signal. Set to Auto for normal use. When horizontal stripping noise appears on the screen, set this to Film/Video to remove the noise.

**Auto\***, **Film**, **Video**



## ■ Audio Setting

The default settings are marked with “\*”.

### Audio Output

#### Coaxial/Optical

You can select the output mode of COAXIAL jack and OPTICAL terminal. For more details on output formats, refer to “About the audio output formats” (p. 38).

<b>Bitstream</b>	Outputs digital signal without any processing. Secondary Audio is not output.
<b>PCM</b>	Outputs 2-channel PCM.
<b>Reencode*</b>	Outputs Bitstream with Secondary Audio.
<b>Off</b>	Mutes sound.

#### HDMI

You can select the output mode of HDMI terminal. For details on setting items, see “Coaxial/Optical” (p. 37). For more details on output formats, refer to “About the audio output formats” (p. 38).

**Bitstream\*, PCM, Reencode, Off**

#### Note

- To output HD audio (such as Dolby TrueHD or DTS-HD Master Audio) from HDMI terminal, set Resolution to Auto or more than 720p (p. 36).

### Downsampling

You can select digital audio signal down-sample frequency. This function is effective for the audio signal output from the COAXIAL jack/OPTICAL terminal.

<b>48k*</b>	The highest sampling rate of digital PCM output is 48 kHz.
<b>96k</b>	The highest sampling rate of digital PCM output is 96 kHz.
<b>192k</b>	The highest sampling rate of digital PCM output is 192 kHz.

### DRC

You can set the DRC (Dynamic Range Compression) (p. 44) to on/off/Auto. When set to Auto, DRC is automatically turned on for a source with DRC information in Dolby TrueHD format. DRC makes the strong sound such as plosive sound lower, and conversations more audible. It is useful when you watch movies in the night.

**Off, On, Auto\***

## Speaker Setting

### 2ch Downmix

You can select down mix method to analog 2-ch from Stereo or Lt/Rt.

<b>Lt/Rt</b>	Select this item if this unit is connected to a Dolby Pro Logic decoder. Sound from rear speakers is mixed to the 2-ch stereo sound.
<b>Stereo*</b>	Changes channel output to stereo, which only delivers sound from the two front speakers.

## Post Process

### Up Mix

You can multi-channelize the 2-channel audio signal. To multi-channelize, select NEO6, then select Cinema or Music mode.

**Off\*, NEO6**

## ■ System Information

Software version and MAC address (p. 45) are displayed.

## ■ About the audio output formats

Source format		HDMI			COAXIAL/OPTICAL			MIXED 2CH
		Bitstream	PCM	Reencode	Bitstream	PCM	Reencode	
PCM 2ch		PCM 2ch			PCM 2ch			2ch
PCM 5.1ch		PCM 5.1ch			PCM 2ch			2ch
PCM 7.1ch		PCM 7.1ch			PCM 2ch			2ch
Dolby Digital		Dolby Digital	PCM up to 5.1ch	Dolby Digital	Dolby Digital	PCM 2ch	Dolby Digital	2ch
	with SA* or BCS**							
Dolby Digital Plus		Dolby Digital Plus	PCM up to 7.1ch	Dolby Digital Plus	Dolby Digital	PCM 2ch	Dolby Digital	2ch
	with SA* or BCS**			Dolby Digital				
Dolby TrueHD		Dolby TrueHD	PCM up to 7.1ch	Dolby TrueHD	Dolby Digital	PCM 2ch	Dolby Digital	
	with SA* or BCS**			Dolby Digital				
DTS		DTS	PCM up to 5.1ch	DTS	DTS	PCM 2ch	DTS	2ch
	with SA* or BCS**							
DTS HD High Resolution		DTS HD High Resolution	PCM up to 7.1ch	DTS HD High Resolution	DTS	PCM 2ch	DTS	2ch
	with SA* or BCS**			DTS				
DTS-HD Master Audio		DTS-HD Master Audio	PCM up to 7.1ch	DTS-HD Master Audio	DTS	PCM 2ch	DTS	
	with SA* or BCS**			DTS				

\* “SA” is a Secondary Audio.

\*\* “BCS” is a button click sound, the sound effect for pop-up menus, etc.

### Notes

- When Coaxial/Optical or HDMI is set to Bitstream, secondary audio is not output. (p. 37)
- To output HD audio (such as Dolby TrueHD or DTS-HD Master Audio) from HDMI terminal, set Resolution to Auto or more than 720p (p. 36).

## ■ About the video output formats

### When TV System is set to NTSC

	Resolution	Auto	480i/576i	480p/576p	720p	1080i	1080p	
							24Hz	Others
HDMI	Playback BD	Max	Max	Max	720p 60 Hz	1080i 60 Hz	1080p 24 Hz	1080p 60 Hz
	others						1080p 60 Hz	
COMPONENT	Playback commercially-released DVD	480i	480i	480p	480p	480p	480p	
	Playback BD			480i	480i	480i	off	480i
	others			480p	720p 60 Hz *	1080i 60 Hz *	1080i 60 Hz *	
VIDEO	Playback BD	480i	480i	480i	480i	480i	off	480i
	others						480i	

\* Depending on the disc or contents, this Player outputs 480p video signal.

### When TV System is set to PAL

	Resolution	Auto	480i/576i	480p/576p	720p	1080i	1080p	
							24Hz	Others
HDMI	Playback BD	Max	Max	Max	720p 50 Hz	1080i 50 Hz	1080p 24 Hz	1080p 50 Hz
	others						1080p 50 Hz	
COMPONENT	Playback commercially-released DVD	576i	576i	576p	576p	576p	576p	
	Playback BD			576i	576i	576i	off	576i
	others			576p	720p 50 Hz *	1080i 50 Hz *	1080i 50 Hz *	
VIDEO	Playback BD	576i	576i	576i	576i	576i	off	576i
	others						576i	

\* Depending on the disc or contents, this Player outputs 576p video signal.

### When TV System is set to Multi

When TV System is set to Multi, video signal is output at the same frequency as the source. Refer to the tables above for details on the frequency setting of the TV and resolution of the output video signal.

While a menu screen such as SETUP menu is displayed, video signal is output at the same frequency as the source.

#### Notes

- "Max" in the table means that resolution is set to the maximum resolution supported by the connected TV.
- HDMI 1080p 24Hz setting is disabled when output resolution is other than 1080p.
- When this Player outputs the 1080p 24 Hz video signal from HDMI, no signals are output from the COMPONENT and VIDEO jacks.
- When commercially-released DVD is played back with component output, maximum resolution is 480p/576p.
- When TV System is set to NTSC and video source is not 60 Hz, the video output signal is converted to 60 Hz.
- When TV System is set to PAL and video source is not 50 Hz, the video output signal is converted to 50 Hz.

# SOFTWARE UPGRADE

Some of the newly released BD discs cannot be played back unless you upgrade this Player software to the latest version. We recommend upgrading the software of this Player with software upgrade so that this Player is operated based on the latest software.

To check for the availability of a software upgrade, visit

<http://download.yamaha.com/downloads/service/top/?site=europe.yamaha.com&language=en>

## Hint

- Software upgrade is automatically started after loading the disc which contains upgrade file package.

## Note

- Do not remove the disc/USB memory device, set this Player to standby mode or unplug the power cable/ LAN cable while the software upgrade is being performed.

## ■ Upgrading the software

### 1. Prepare for the software upgrade.

When you upgrade the software from Disc/USB Storage:

- ① Save the upgrade file package to the appropriate folder on the disc/USB memory device. For more details, refer to the procedure document attached with the upgrade file package.
- ② Load the disc or connect the USB memory device.  
When the disc is loaded, software upgrade is started automatically. Skip step 2.

When you upgrade the software from Network:  
Confirm that this Player is connected to the network.

### 2. Select the upgrade method and start upgrade from SETUP menu.

- ① Press **SETUP** to display SETUP menu screen.
- ② Select General Setting → System → Upgrade.

- ③ Select the item which contains the upgrade file package from Disc/USB Storage/Network.

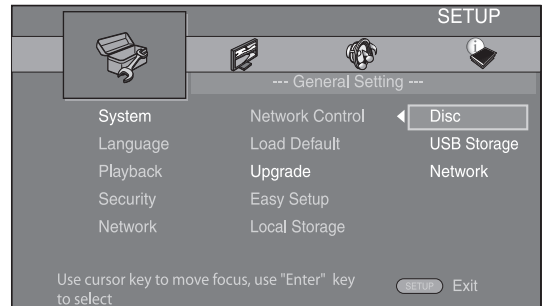

### 3. The system will search for upgrade file package.

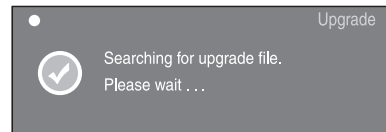

### 4. Press ENTER to start upgrade.

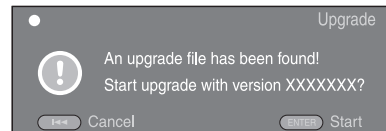

### 5. Upgrade is completed. The system will restart.





# TROUBLESHOOTING

Refer to the table below when this Player does not function properly. If the problem you are experiencing is not listed below or if the instruction below does not help, turn off this Player, disconnect the power cable, and contact the nearest authorized Yamaha dealer or service center.

## ■ Power

Problem	Possible causes and solutions
No power.	<ul style="list-style-type: none"> <li>– Connect the AC power cable properly.</li> <li>– Press  on the front panel to turn on the power.</li> </ul>
The Player power is turned off.	<ul style="list-style-type: none"> <li>– The power will be automatically turned off after 25 continuous minutes of inactivity (no playback).</li> </ul>

## ■ Basic operation

Problem	Possible causes and solutions
The remote control does not work.	<ul style="list-style-type: none"> <li>– Use the remote control within its operating range. (p. 9)</li> <li>– Replace the batteries. (p. 9)</li> <li>– Check the ID settings for the main unit and the remote control. (p. 9)</li> </ul>
Buttons do not work.	<ul style="list-style-type: none"> <li>– Press and hold  on the front panel for around 5 seconds to restart this Player.</li> <li>– To completely reset this Player, unplug the power cable from the AC outlet for 10 seconds or more, plug the power cable to the AC outlet again, and then turn on this Player.</li> </ul>
Password is forgotten.	<ul style="list-style-type: none"> <li>– Press and hold  and  on the front panel simultaneously when no disc is inserted and playback is stopped to set all the Security settings (p. 34) of this Player to their default settings. After the power is turned off automatically, press  to turn on the power again.</li> </ul>

## ■ Disc playback

Problem	Possible causes and solutions
The Player cannot play a disc.	<ul style="list-style-type: none"> <li>– Take out the disc and clean it. (p. 4)</li> <li>– Make sure that the disc is loaded properly (aligned in disc tray and label-side up). (p. 4)</li> <li>– Use a disc supported by the Player. (p. 3)</li> <li>– Remove the disc and then check whether the Player supports the disc or not. (p. 3)</li> <li>– Check the region code. (p. 3)</li> <li>– Check whether the disc is defective by trying another disc.</li> <li>– The CD-R/RW, DVD+R/RW/R DL, and DVD-R/RW/R DL must be finalized. (p. 3)</li> </ul>
Video stops.	<ul style="list-style-type: none"> <li>– The Player will stop if it senses shock or vibration.</li> </ul>
The Player makes a snapping sound when starting playback or loading a disc.	<ul style="list-style-type: none"> <li>– These sounds are not malfunctions of the Player but are normal operating conditions.</li> </ul>

## ■ Picture

Problem	Possible causes and solutions
<b>No picture.</b>	<ul style="list-style-type: none"> <li>– Make sure that the cables are connected correctly. (p. 10)</li> <li>– Make sure that the connected TV or the AV receiver is set to the correct input. (p. 10)</li> <li>– Connect this Player to the TV with VIDEO jack (p. 13) using the supplied video pin cable.               <ul style="list-style-type: none"> <li>– If picture is still not displayed with the unit connected to the VIDEO jack, press and hold <b>■</b> on the front panel for around 5 seconds when no disc is inserted and playback is stopped to switch NTSC/PAL and then set Resolution properly. (p. 36).</li> </ul> </li> <li>– TV System is set to the incorrect setting. Press and hold <b>▶</b> and <b>■</b> on the front panel simultaneously when no disc is inserted and playback is stopped to reset the TV System and Resolution settings to their default settings.</li> </ul>
<b>Screen freezes and operation buttons do not work.</b>	<ul style="list-style-type: none"> <li>– Press <b>■</b>, then restart playback.</li> <li>– Turn off the power and turn on the power again.</li> <li>– Press and hold <b>⏻</b> on the front panel for around 5 seconds to restart this Player.</li> </ul>
<b>Video is not output with the desired resolution.</b>	<ul style="list-style-type: none"> <li>– Set to the desired resolution. (p. 36)</li> </ul>
<b>Widescreen video appears vertically stretched, or black bands appear at the top and bottom of the screen. Or 4:3 video appears horizontally stretched.</b>	<ul style="list-style-type: none"> <li>– Change the aspect ratio of your TV. (p. 35)</li> </ul>
<b>Square noise (mosaic) appears on the screen.</b>	<ul style="list-style-type: none"> <li>– Blocks in images may be visible in scenes with rapid movement due to the characteristics of digital image compression technology.</li> </ul>
<b>The playback screen will be disturbed if DVD video is recorded to a VCR, or played back through a VCR.</b>	<ul style="list-style-type: none"> <li>– This Player complies with analog copy protection. Some discs contain a copy prohibiting signal. If you try to play back such discs through a VCR, or record to a VCR and play back the signal, the copy protection will prevent normal playback.</li> </ul>
<b>Audio is not output, or images are not played back properly.</b>	<ul style="list-style-type: none"> <li>– The audio may not be output or the images may not be played back properly for some discs in which copyright-protected contents are recorded.</li> </ul>

## ■ Sound

Problem	Possible causes and solutions
<b>No sound, or sound is distorted.</b>	<ul style="list-style-type: none"> <li>– Check that the audio cable is connected correctly. (p. 10)</li> <li>– Turn the volume of TV or AV receiver up.</li> <li>– There is no sound during still mode, slow motion playback, fast forward and fast reverse. (p. 8)</li> <li>– Audio may not be output depending on the audio recording status, such as when audio other than an audio signal or non-standard audio is recorded for the audio content. (p. 3)</li> </ul>
<b>Left and right channels of audio are reversed, or sound comes out of only one side.</b>	<ul style="list-style-type: none"> <li>– Check the audio connection. (p. 10)</li> </ul>
<b>Audio is not output, or images are not played back properly.</b>	<ul style="list-style-type: none"> <li>– The audio may not be output or the images may not be played back properly for some discs in which copyright-protected contents are recorded.</li> </ul>
<b>Cannot hear the desired audio type and/ or number of channels.</b>	<ul style="list-style-type: none"> <li>– Refer to Audio Output setting and “About the audio output formats”. (p. 37, 38)</li> </ul>
<b>Cannot hear the sound of PIP (secondary audio).</b>	<ul style="list-style-type: none"> <li>– Set Coaxial/Optical or HDMI to PCM/Reencode. (p. 37)</li> <li>– To hear secondary audio, press <b>2ND AUDIO</b>. (p. 6)</li> <li>– Depending on the disc, you may need to set secondary audio on the top menu of the disc. (p. 8)</li> </ul>

## ■ Network

Problem	Possible causes and solutions
<b>Cannot connect to the Internet.</b>	<ul style="list-style-type: none"> <li>– Connect the Network cable properly.</li> <li>– Turn on the connected equipment, such as broadband router or modem.</li> <li>– Connect the broadband router and/or modem properly.</li> <li>– Set the proper value(s) in the network setting. Check “Network”. (p. 35)</li> </ul>
<b>Cannot download BD-Live contents.</b>	<ul style="list-style-type: none"> <li>– Connect the Network cable properly. (p. 16)</li> <li>– Connect USB memory device properly. Check that the USB memory device is connected to the USB port of this Player. (p. 16)</li> <li>– Check if the BD disc supports BD-Live.</li> <li>– Check the setting for “Internet Connection”. (p. 35)</li> <li>– Connect the USB memory device formatted in FAT16 or FAT32.</li> <li>– It is recommended to connect the USB memory device with at least 2 GB of free space. If there is not enough free space, format the USB memory device. (p. 33)</li> <li>– Refer to the supplied user’s manual of the disc or consult the disc manufacturer.</li> </ul>
<b>Cannot detect the DLNA server.</b>	<ul style="list-style-type: none"> <li>– Connect the network cable properly.</li> <li>– Turn on the connected equipment, such as broadband router or the server.</li> <li>– Confirm the Player and the server are connected to the same access point.</li> <li>– Set the proper value(s) in the network setting. Check “Network”. (p. 35)</li> <li>– Depending on the DLNA server, the Player may need to be permitted from the server.</li> </ul>
<b>Cannot a play the file on the home network server.</b>	<ul style="list-style-type: none"> <li>– Make sure the file is playable. (p. 3)</li> <li>– Check your DLNA server’s setting.</li> <li>– The playback and operating quality may be affected by your home network condition.</li> </ul>

## ■ Messages on the screen

- The following messages appear on the TV screen in case the disc you tried to play back is not appropriate or the operation is not correct.

Error message	Possible causes and solutions
<b>Not Support This File!</b>	– The file is not supported with this Player. See “Types of discs/files that can be used with this player” (p. 3).
<b>Wrong region code!</b>	– The disc is an incompatible region code. See “Region management information” (p. 3).
<b>Network has FAILED.</b>	– This Player cannot be connected to the network. Check connection (p. 16) and Network setting (p. 35).
<b>Network is OK, proxy has FAILED.</b>	– This Player cannot be connected to the proxy server. See “Proxy Setting” (p. 35).
<b>The Setting is prohibited, please setup again.</b>	– BD-Live connection is prohibited. See “BD-Live Connection” (p. 35).
<b>No valid upgrade file is found!</b>	– Check if the upgrade file is in the appropriate folder.
<b>Upgrade has failed for some reason!</b>	– Upgrade is failed. Check if the upgrade file is corrupted or unreadable.

# GLOSSARY

## **AVCHD**

AVCHD is a new format (standard) for high definition video cameras that can be used to record and play high-resolution HD images.

## **BD-Live™**

BD-Live is a BD standard that utilizes a network connection, enabling this Player to go online to download promotional videos and other data.

## **BDMV**

BDMV (Blu-ray Disc Movie, BD-MV) refers to one of the application formats used for BD-ROM which is one of the Blu-ray Disc specifications. BDMV is a recording format equivalent to DVD-Video of the DVD specification.

## **Blu-ray 3D™**

Blu-ray 3D enables you to view full high definition 3D images.

## **BONUSVIEW™**

BONUSVIEW compatible discs let you simultaneously enjoy video sub-channel for two screens, audio sub-channel and sub-titles. A small screen appears within the main screen during playback (Picture in Picture).

## **Closed caption**

Closed captions are kind of subtitle, and the difference between subtitles and captions is that subtitles are intended for hearing persons and captions are for the hearing impaired. Subtitles rarely show all of the audio. For example, captions show sound effects (e.g., “phone ringing” and “footsteps”), while subtitles do not. Before you select this setting, please ensure that the disc contains closed caption information.

## **Color Space**

Color Space is a color range that can be represented. RGB is a color space based on the RGB color model (red, green and blue) and is typically used for PC monitors. YCbCr is a color space based on a luminance signal (Y) and two color difference signals (Cb and Cr).

## **Deep Color**

Deep Color refers to the use of various color depths in displays, up from the 24-bit depths in previous versions of the HDMI specification. This extra bit depth allows HDTVs and other displays go from millions of colors to billions of colors and eliminate on-screen color banding for smooth tonal transitions and subtle gradations between colors. The increased contrast ratio can represent many times more shades of gray between black and white. Also Deep Color increases the number of available colors within the boundaries defined by the RGB or YCbCr color space.

## **DivX®**

DivX® is a popular media technology created by DivX, Inc. DivX® media files contain highly compressed video with high visual quality that maintains a relatively small file size. DivX® files can also include advanced media features like menus, subtitles, and alternate audio tracks. Many DivX® media files are available for download online, and you can create your own using your personal content and easy-to-use tools from DivX.com.

## **Dolby Digital**

A sound system developed by Dolby Laboratories Inc. that gives movie theater ambience to audio output when the product is connected to a Dolby Digital processor or amplifier.

## **Dolby Digital Plus**

A sound system developed as an extension to Dolby Digital. This audio coding technology supports 7.1 multi-channel surround sound.

## **Dolby TrueHD**

Dolby TrueHD is a lossless coding technology that supports up to 8 channels of multi-channel surround sound for the next generation optical discs. The reproduced sound is true to the original source bit-for-bit.

## **DRC (Dynamic Range Control)**

DRC lets you adjust the range between the loudest and softest sounds (dynamic range) for playback at average volume. Use this when it is hard to hear dialog, or during times when playback may disturb neighbors.

## **DTS**

This is a digital sound system developed by DTS, Inc. for use in cinemas.

## **DTS-HD High Resolution Audio**

DTS-HD High Resolution Audio is a new technology developed for the next generation high definition optical disc format.

## **DTS-HD Master Audio**

DTS-HD Master Audio is a lossless audio compression technology developed for the next generation high definition optical disc format.

## **HDMI**

HDMI (High-Definition Multimedia Interface) is an interface that supports both video and audio on a single digital connection. The HDMI connection carries standard to high definition video signals and multi-channel audio signals to AV components such as HDMI equipped TVs, in digital form without degradation.

## **Letterbox (LB 4:3)**

A screen size with black bars on the top and bottom of the image to allow viewing of wide-screen (16:9) material on a connected 4:3 TV.



**Linear PCM Sound**

Linear PCM is a signal recording format used for Audio CDs and on some DVD and Blu-ray discs. The sound on Audio CDs is recorded at 44.1 kHz with 16 bits. (Sound is recorded between 48 kHz with 16 bits and 96 kHz with 24 bits on DVD discs and between 48 kHz with 16 bits and 192 kHz with 24 bits on BD discs.)

**Lip Sync**

Lip Sync, an abbreviation for lip synchronization, is a technical term that involves both a problem and a capability of maintaining audio and video signals synchronized during post-production and transmission. Whereas the audio and video latency requires complex end-user adjustments, HDMI version 1.3 incorporates an automatic audio and video syncing capability that allows devices to perform this synchronization automatically and accurately without user interaction.

**Mac address**

The Mac address is a unique value assigned to a network device for identification purposes.

**Pan Scan (PS 4:3)**

A screen size that cuts off the sides of the image to allow viewing of wide-screen (16:9) material on a connected 4:3 TV.

**Subtitles**

These are the lines of text appearing at the bottom of the screen which translate or transcribe the dialog. They are recorded on many DVD and BD discs.

**Top menu**

In a BD-Video/DVD-Video, this is the menu for selecting things like the chapter to be played back and the subtitle language. In some DVD-Videos, the top menu may be called the "Title Menu".

**x.v.Color**

x.v.Color reproduces a greater range of color than before, showing almost all of the colors that the human eye can detect.

## SPECIFICATIONS

### ■ General

Power supply	
[U.S.A. and Canada models].....	AC 110-240 V, 60 Hz
[Central and South America model] .....	AC 110-240 V, 50/60 Hz
[Australia model] .....	AC 110-240 V, 50 Hz
[U.K., Europe and Russia model] .....	AC 110-240 V, 50 Hz
[China model].....	AC 110-240 V, 50 Hz
[Asia model].....	AC 110-240 V, 50/60 Hz
Power consumption (Normal) .....	23 W
Power consumption (Standby) .....	0.5 W or less
Dimensions (W × H × D) .....	435 × 86 × 257 mm
	(17-1/8 × 3-3/8 × 10-1/8 in)
Weight .....	3.0 kg (6.6 lbs.)

### ■ Input/output

HDMI output .....	Type A connector × 1
	480i/576i/480p/576p/720p/1080i/1080p/1080p@24Hz,
	Deep Color, x.v. Color support
Component video output .....	Y: 1 Vp-p (75 ohms)
	Pb, Pr: 0.7 Vp-p (75 ohms)
Video output .....	1 Vp-p (75 ohms)
Digital output.....	Optical × 1, Coaxial × 1
Analog audio output .....	Mixed 2 ch × 1
	2 ± 0.3 V (1 kHz, 0 dB)
USB .....	Type A connector × 2
Other equipments .....	Remote IN/OUT × 1
	Ethernet × 1

Specifications are subject to change without notice.

## ■ Copyright

- Audio-visual material may consist of copyrighted works which must not be recorded without the authority of the owner of the copyright. Refer to relevant laws in your country.
- This item incorporates copy protection technology that is protected by U.S. patents and other intellectual property rights of Rovi Corporation. Reverse engineering and disassembly are prohibited.
- Manufactured under license from Dolby Laboratories. Dolby and the double-D symbol are trademarks of Dolby Laboratories.
- Manufactured under license under U.S. Patent #'s: 5,451,942; 5,956,674; 5,974,380; 5,978,762; 6,226,616; 6,487,535; 7,212,872; 7,333,929; 7,392,195; 7,272,567 & other U.S. and worldwide patents issued & pending. DTS and the Symbol are registered trademarks, & DTS-HD, DTS-HD Master Audio, and the DTS logos are trademarks of DTS, Inc. Product includes software. © DTS, Inc. All Rights Reserved.
- “Blu-ray Disc™”, “Blu-ray™”, “Blu-ray 3D™”, “BD-Live™”, “BONUSVIEW™”, and the logos are trademarks of the Blu-ray Disc Association.
-  is a trademark of DVD Format/Logo Licensing Corporation.
- HDMI, the HDMI logo and High-Definition Multimedia Interface are trademarks or registered trademarks of HDMI Licensing LLC.
- “x.v.Color” and “x.v.Color” logo are trademarks.
- “AVCHD” and the “AVCHD” logo are trademarks of Panasonic Corporation and Sony Corporation.
- Java and all Java-based trademarks and logos are trademarks or registered trademarks of Sun Microsystems, Inc. in the United States and/or other countries.
- This product is licensed under the AVC patent portfolio license and VC-1 patent portfolio license for the personal and non-commercial use of a consumer to (i) encode video in compliance with the AVC Standard and VC-1 Standard (“AVC/VC-1 Video”) and/or (ii) decode AVC/VC-1 Video that was encoded by a consumer engaged in a personal and non-commercial activity and/or was obtained from a video provider licensed to provide AVC/VC-1 Video. No license is granted or shall be implied for any other use. Additional information may be obtained from MPEG LA, LLC. See <http://www.mpegla.com>.
- Windows Media Player is a registered trademark or trademark of Microsoft corporation in the United States and/or other countries.
- DLNA and DLNA CERTIFIED are trademarks and/or service marks of Digital Living Network Alliance.
- YouTube and the YouTube logo are trademarks of Google, Inc.
- Netflix and the Netflix logo are the registered trademarks of Netflix, Inc.
- BLOCKBUSTER name, design and related marks are trademarks of Blockbuster Inc. © 2010 Blockbuster Inc. All rights reserved.
- Film Fresh and the Film Fresh logo are registered trademarks of Film Fresh Inc.

- “DivX®, DivX Certified®, DivX Plus™ HD and associated logos are registered trademarks of DivX, Inc. and are used under license.”
- “DivX Certified® to play DivX® and DivX Plus™ HD (H.264/MKV) video up to 1080p HD and premium content.”

ABOUT DIVX VIDEO: DivX® is a digital video format created by DivX, Inc. This is an official DivX Certified® device that plays DivX video. Visit [divx.com](http://divx.com) for more information and software tools to convert your files into DivX video.

ABOUT DIVX VIDEO-ON-DEMAND: This DivX Certified® device must be registered in order to play purchased DivX Video-on-Demand (VOD) movies. To obtain your registration code, locate the DivX VOD section in your device setup menu. Go to [vod.divx.com](http://vod.divx.com) for more information on how to complete your registration.

# Information about software

This product uses the following software.  
For information (copyright, etc) about each software, read the original sentences stated below.

## ■ About Linux, Busybox, SquashFS, LIRC, U-boot

GNU GENERAL PUBLIC LICENSE  
Version 2, June 1991

Copyright (C) 1989, 1991 Free Software Foundation, Inc.  
51 Franklin St, Fifth Floor, Boston, MA 02110-1301 USA

Everyone is permitted to copy and distribute verbatim copies of this license document, but changing it is not allowed.

### Preamble

The licenses for most software are designed to take away your freedom to share and change it. By contrast, the GNU General Public License is intended to guarantee your freedom to share and change free software—to make sure the software is free for all its users. This General Public License applies to most of the Free Software Foundation's software and to any other program whose authors commit to using it. (Some other Free Software Foundation software is covered by the GNU Library General Public License instead.) You can apply it to your programs, too.

When we speak of free software, we are referring to freedom, not price. Our General Public Licenses are designed to make sure that you have the freedom to distribute copies of free software (and charge for this service if you wish), that you receive source code or can get it if you want it, that you can change the software or use pieces of it in new free programs; and that you know you can do these things. To protect your rights, we need to make restrictions that forbid anyone to deny you these rights or to ask you to surrender the rights. These restrictions translate to certain responsibilities for you if you distribute copies of the software, or if you modify it. For example, if you distribute copies of such a program, whether gratis or for a fee, you must give the recipients all the rights that you have. You must make sure that they, too, receive or can get the source code. And you must show them these terms so they know their rights.

We protect your rights with two steps: (1) copyright the software, and (2) offer you this license which gives you legal permission to copy, distribute and/or modify the software. Also, for each author's protection and ours, we want to make certain that everyone understands that there is no warranty for this free software. If the software is modified by someone else and passed on, we want its recipients to know that what they have is not the original, so that any problems introduced by others will not reflect on the original authors' reputations.

Finally, any free program is threatened constantly by software patents. We wish to avoid the danger that redistributors of a free program will individually obtain patent licenses, in effect making the program proprietary. To prevent this, we have made it clear that any patent must be licensed for everyone's free use or not licensed at all. The precise terms and conditions for copying, distribution and modification follow.

### GNU GENERAL PUBLIC LICENSE TERMS AND CONDITIONS FOR COPYING, DISTRIBUTION AND MODIFICATION

- This License applies to any program or other work which contains a notice placed by the copyright holder saying it may be distributed under the terms of this General Public License. The "Program", below, refers to any such program or work, and a "work based on the Program" means either the Program or any derivative work under copyright law: that is to say, a work containing the Program or a portion of it, either verbatim or with modifications and/or translated into another language. (Hereinafter, translation is included without limitation in the term "modification".) Each licensee is addressed as "you". Activities other than copying, distribution and modification are not covered by this License; they are outside its scope. The act of running the Program is not restricted, and the output from the Program is covered only if its contents constitute a work based on the Program (independent of having been made by running the Program). Whether that is true depends on what the Program does.
- You may copy and distribute verbatim copies of the Program's source code as you receive it, in any medium, provided that you conspicuously and appropriately publish on each copy an appropriate copyright notice and disclaimer of warranty; keep intact all the notices that refer to this License and to the absence of any warranty; and give any other recipients of the Program a copy of this License along with the Program. You may charge a fee for the physical act of transferring a copy, and you may at your option offer warranty protection in exchange for a fee.
- You may modify your copy or copies of the Program or any portion of it, thus forming a work based on the Program, and copy and distribute such modifications or work under the terms of Section 1 above, provided that you also meet all of these conditions:
  - You must cause the modified files to carry prominent notices stating that you changed the files and the date of any change.
  - You must cause any work that you distribute or publish, that in whole or in part contains or is derived from the Program or any part thereof, to be licensed as a whole at no charge to all third parties under the terms of this License.
  - If the modified program normally reads commands interactively when run, you must cause it, when started running for such interactive use in the most ordinary way, to print or display an announcement including an appropriate copyright notice and a notice that there is no warranty (or else, saying that you provide a warranty) and that users may redistribute the program under these conditions, and telling the user how to view a copy of this License. (Exception: if the Program itself is interactive but does not normally print such an announcement, your work based on the Program is not required to print an announcement.)

These requirements apply to the modified work as a whole. If identifiable sections of that work are not derived from the Program, and can be reasonably considered independent and separate works in themselves, then this License, and its terms, do not apply to those sections when you distribute them as separate works. But when you distribute the same sections as part of a whole which is a work based on the Program, the distribution of the whole must be on the terms of this License, whose permissions for other licensees extend to the entire whole, and thus to each and every part regardless of who wrote it.

Thus, it is not the intent of this section to claim rights or contest your rights to work written entirely by you; rather, the intent is to exercise the right to control the distribution of derivative or collective works based on the Program.

In addition, mere aggregation of another work not based on the Program with the Program (or with a work based on the Program) on a volume of a storage or distribution medium does not bring the other work under the scope of this License.

- You may copy and distribute the Program (or a work based on it, under Section 2) in object code or executable form under the terms of Sections 1 and 2 above provided that you also do one of the following:
  - Accompany it with the complete corresponding machine-readable source code, which must be distributed under the terms of Sections 1 and 2 above on a medium customarily used for software interchange; or,
  - Accompany it with a written offer, valid for at least three years, to give any third party, for a charge no more than your cost of physically performing source distribution, a complete machine-readable copy of the corresponding source code, to be distributed under the terms of Sections 1 and 2 above on a medium customarily used for software interchange; or,
  - Accompany it with the information you received as to the offer to distribute corresponding source code. (This alternative is allowed only for noncommercial distribution and only if you received the program in object code or executable form with such an offer, in accord with Subsection b above.)

The source code for a work means the preferred form of the work for making modifications to it. For an executable work, complete source code means all the source code for all modules it contains, plus any associated interface definition files, plus the scripts used to control compilation and installation of the executable. However, as a special exception, the source code distributed need not include anything that is normally distributed (in either source or binary form) with the major components (compiler, kernel, and so on) of the operating system on which the executable runs, unless that component itself accompanies the executable.

If distribution of executable or object code is made by offering access to copy from a designated place, then offering equivalent access to copy the source code from the same place counts as distribution of the source code, even though third parties are not compelled to copy the source along with the object code.

- You may not copy, modify, sublicense, or distribute the Program except as expressly provided under this License. Any attempt otherwise to copy, modify, sublicense or distribute the Program is void, and will automatically terminate your rights under this License. However, parties who have received copies, or rights, from you under this License will not have their licenses terminated so long as such parties remain in full compliance.
- You are not required to accept this License, since you have not signed it. However, nothing else grants you permission to modify or distribute the Program or its derivative works. These actions are prohibited by law if you do not accept this License. Therefore, by modifying or distributing the Program (or any work based on the Program), you indicate your acceptance of this License to do so, and all its terms and conditions for copying, distributing or modifying the Program or works based on it.
- Each time you redistribute the Program (or any work based on the Program), the recipient automatically receives a license from the original licensor to copy, distribute or modify the Program subject to these terms and conditions. You may not impose any further restrictions on the recipients' exercise of the rights granted herein. You are not responsible for enforcing compliance by third parties to this License.
- If, as a consequence of a court judgment or allegation of patent infringement or for any other reason (not limited to patent issues), conditions are imposed on you (whether by court order, agreement or otherwise) that contradict the conditions of this License, they do not excuse you from the conditions of this License. If you cannot distribute so as to satisfy simultaneously your obligations under this License and any other pertinent obligations, then as a consequence you may not distribute the Program at all. For example, if a patent license would not permit royalty-free redistribution of the Program by all those who receive copies directly or indirectly through you, then the only way you could satisfy both it and this License would be to refrain entirely from distribution of the Program.

If any portion of this section is held invalid or unenforceable under any particular circumstance, the balance of the section is intended to apply and the section as a whole is intended to apply in other circumstances.

It is not the purpose of this section to induce you to infringe any patents or other property right claims or to contest validity of any such claims; this section has the sole purpose of protecting the integrity of the free software distribution system, which is implemented by public license practices. Many people have made generous contributions to the wide range of software distributed through that system in reliance on consistent application of that system; it is up to the author/donor to decide if he or she is willing to distribute software through any other system and a licensee cannot impose that choice.

This section is intended to make thoroughly clear what is believed to be a consequence of the rest of this License.

8. If the distribution and/or use of the Program is restricted in certain countries either by patents or by copyrighted interfaces, the original copyright holder who places the Program under this License may add an explicit geographical distribution limitation excluding those countries, so that distribution is permitted only in or among countries not thus excluded. In such case, this License incorporates the limitation as if written in the body of this License.

9. The Free Software Foundation may publish revised and/or new versions of the General Public License from time to time. Such new versions will be similar in spirit to the present version, but may differ in detail to address new problems or concerns.

Each version is given a distinguishing version number. If the Program specifies a version number of this License which applies to it and "any later version", you have the option of following the terms and conditions either of that version or of any later version published by the Free Software Foundation. If the Program does not specify a version number of this License, you may choose any version ever published by the Free Software Foundation.

10. If you wish to incorporate parts of the Program into other free programs whose distribution conditions are different, write to the author to ask for permission. For software which is copyrighted by the Free Software Foundation, write to the Free Software Foundation; we sometimes make exceptions for this. Our decision will be guided by the two goals of preserving the free status of all derivatives of our free software and of promoting the sharing and reuse of software generally.

#### NO WARRANTY

11. BECAUSE THE PROGRAM IS LICENSED FREE OF CHARGE, THERE IS NO WARRANTY FOR THE PROGRAM, TO THE EXTENT PERMITTED BY APPLICABLE LAW. EXCEPT WHEN OTHERWISE STATED IN WRITING THE COPYRIGHT HOLDERS AND/OR OTHER PARTIES PROVIDE THE PROGRAM "AS IS" WITHOUT WARRANTY OF ANY KIND, EITHER EXPRESSED OR IMPLIED, INCLUDING, BUT NOT LIMITED TO, THE IMPLIED WARRANTIES OF MERCHANTABILITY AND FITNESS FOR A PARTICULAR PURPOSE. THE ENTIRE RISK AS TO THE QUALITY AND PERFORMANCE OF THE PROGRAM IS WITH YOU. SHOULD THE PROGRAM PROVE DEFECTIVE, YOU ASSUME THE COST OF ALL NECESSARY SERVICING, REPAIR OR CORRECTION.

12. IN NO EVENT UNLESS REQUIRED BY APPLICABLE LAW OR AGREED TO IN WRITING WILL ANY COPYRIGHT HOLDER, OR ANY OTHER PARTY WHO MAY MODIFY AND/OR REDISTRIBUTE THE PROGRAM AS PERMITTED ABOVE, BE LIABLE TO YOU FOR DAMAGES, INCLUDING ANY GENERAL, SPECIAL, INCIDENTAL OR CONSEQUENTIAL DAMAGES ARISING OUT OF THE USE OR INABILITY TO USE THE PROGRAM (INCLUDING BUT NOT LIMITED TO LOSS OF DATA OR DATA BEING RENDERED INACCURATE OR LOSSES SUSTAINED BY YOU OR THIRD PARTIES OR A FAILURE OF THE PROGRAM TO OPERATE WITH ANY OTHER PROGRAMS), EVEN IF SUCH HOLDER OR OTHER PARTY HAS BEEN ADVISED OF THE POSSIBILITY OF SUCH DAMAGES.

#### END OF TERMS AND CONDITIONS

##### How to Apply These Terms to Your New Programs

If you develop a new program, and you want it to be of the greatest possible use to the public, the best way to achieve this is to make it free software which everyone can redistribute and change under these terms.

To do so, attach the following notices to the program. It is safest to attach them to the start of each source file to most effectively convey the exclusion of warranty; and each file should have at least the "copyright" line and a pointer to where the full notice is found.

<one line to give the program's name and a brief idea of what it does.>  
Copyright (C) <year> <name of author>

This program is free software; you can redistribute it and/or modify it under the terms of the GNU General Public License as published by the Free Software Foundation; either version 2 of the License, or (at your option) any later version.

This program is distributed in the hope that it will be useful, but WITHOUT ANY WARRANTY; without even the implied warranty of MERCHANTABILITY or FITNESS FOR A PARTICULAR PURPOSE. See the GNU General Public License for more details.

You should have received a copy of the GNU General Public License along with this program; if not, write to the Free Software Foundation, Inc., 51 Franklin St, Fifth Floor, Boston, MA 02110-1301 USA

Also add information on how to contact you by electronic and paper mail.

If the program is interactive, make it output a short notice like this when it starts in an interactive mode:

Gnomovision version 69, Copyright (C) year name of author Gnomovision comes with ABSOLUTELY NO WARRANTY; for details type 'show w'. This is free software, and you are welcome to redistribute it under certain conditions; type 'show c' for details.

The hypothetical commands 'show w' and 'show c' should show the appropriate parts of the General Public License. Of course, the commands you use may be called something other than 'show w' and 'show c'; they could even be mouse-clicks or menu items--whatever suits your program.

You should also get your employer (if you work as a programmer) or your school, if any, to sign a "copyright disclaimer" for the program, if necessary. Here is a sample; alter the names:

Yoyodyne, Inc., hereby disclaims all copyright interest in the program 'Gnomovision' (which makes passes at compilers) written by James Hacker.

<signature of Ty Coon>, 1 April 1989

Ty Coon, President of Vice

This General Public License does not permit incorporating your program into proprietary programs. If your program is a subroutine library, you may consider it more useful to permit linking proprietary applications with the library. If this is what you want to do, use the GNU Library General Public License instead of this License..

## ■ About glibc, libmtp, libusb, libusb-compat, DirectFB

### GNU LESSER GENERAL PUBLIC LICENSE

Version 2.1, February 1999

Copyright (C) 1991, 1999 Free Software Foundation, Inc.  
59 Temple Place, Suite 330, Boston, MA 02111-1307 USA

Everyone is permitted to copy and distribute verbatim copies of this license document, but changing it is not allowed.

[This is the first released version of the Lesser GPL. It also counts as the successor of the GNU Library Public License, version 2, hence the version number 2.1.]

#### Preamble

The licenses for most software are designed to take away your freedom to share and change it. By contrast, the GNU General Public Licenses are intended to guarantee your freedom to share and change free software--to make sure the software is free for all its users.

This license, the Lesser General Public License, applies to some specially designated software packages--typically libraries--of the Free Software Foundation and other authors who decide to use it. You can use it too, but we suggest you first think carefully about whether this license or the ordinary General Public License is the better strategy to use in any particular case, based on the explanations below.

When we speak of free software, we are referring to freedom of use, not price. Our General Public Licenses are designed to make sure that you have the freedom to distribute copies of free software (and charge for this service if you wish); that you receive source code or can get it if you want it; that you can change the software and use pieces of it in new free programs; and that you are informed that you can do these things.

To protect your rights, we need to make restrictions that forbid distributors to deny you these rights or to ask you to surrender these rights. These restrictions translate to certain responsibilities for you if you distribute copies of the library or if you modify it. For example, if you distribute copies of the library, whether gratis or for a fee, you must give the recipients all the rights that we gave you. You must make sure that they, too, receive or can get the source code. If you link other code with the library, you must provide complete object files to the recipients, so that they can relink them with the library after making changes to the library and recompiling it. And you must show them these terms so they know their rights.

We protect your rights with a two-step method: (1) we copyright the library, and (2) we offer you this license, which gives you legal permission to copy, distribute and/or modify the library.

To protect each distributor, we want to make it very clear that there is no warranty for the free library. Also, if the library is modified by someone else and passed on, the recipients should know that what they have is not the original version, so that the original author's reputation will not be affected by problems that might be introduced by others.

Finally, software patents pose a constant threat to the existence of any free program. We wish to make sure that a company cannot effectively restrict the users of a free program by obtaining a restrictive license from a patent holder. Therefore, we insist that any patent license obtained for a version of the library must be consistent with the full freedom of use specified in this license.

Most GNU software, including some libraries, is covered by the ordinary GNU General Public License. This license, the GNU Lesser General Public License, applies to certain designated libraries, and is quite different from the ordinary General Public License. We use this license for certain libraries in order to permit linking those libraries into non-free programs.

When a program is linked with a library, whether statically or using a shared library, the combination of the two is legally speaking a combined work, a derivative of the original library. The ordinary General Public License therefore permits such linking only if the entire combination fits its criteria of freedom. The Lesser General Public License permits more lax criteria for linking other code with the library.

We call this license the "Lesser" General Public License because it does Less to protect the user's freedom than the ordinary General Public License. It also provides other free software developers Less of an advantage over competing non-free programs. These disadvantages are the reason we use the ordinary General Public License for many libraries. However, the Lesser license provides advantages in certain special circumstances.

For example, on rare occasions, there may be a special need to encourage the widest possible use of a certain library, so that it becomes a de-facto standard. To achieve this, non-free programs must be allowed to use the library. A more frequent case is that a free library does the same job as widely used non-free libraries. In this case, there is little to gain by limiting the free library to free software only, so we use the Lesser General Public License.

In other cases, permission to use a particular library in non-free programs enables a greater number of people to use a large body of free software. For example, permission to use the GNU C Library in non-free programs enables many more people to use the whole GNU operating system, as well as its variant, the GNU/Linux operating system. Although the Lesser General Public License is Less protective of the users' freedom, it does ensure that the user of a program that is linked with the Library has the freedom and the wherewithal to run that program using a modified version of the Library.

The precise terms and conditions for copying, distribution and modification follow. Pay close attention to the difference between a "work based on the library" and a "work that uses the library". The former contains code derived from the library, whereas the latter must be combined with the library in order to run.

GNU LESSER GENERAL PUBLIC LICENSE

TERMS AND CONDITIONS FOR COPYING, DISTRIBUTION AND MODIFICATION

0. This License Agreement applies to any software library or other program which contains a notice placed by the copyright holder or other authorized party saying it may be distributed under the terms of this Lesser General Public License (also called "this License"). Each licensee is addressed as "you".

A "library" means a collection of software functions and/or data prepared so as to be conveniently linked with application programs (which use some of those functions and data) to form executables.

The "Library", below, refers to any such software library or work which has been distributed under these terms. A "work based on the Library" means either the Library or any derivative work under copyright law: that is to say, a work containing the Library or a portion of it, either verbatim or with modifications and/or translated straightforwardly into another language. (Hereinafter, translation is included without limitation in the term "modification".)

"Source code" for a work means the preferred form of the work for making modifications to it. For a library, complete source code means all the source code for all modules it contains, plus any associated interface definition files, plus the scripts used to control compilation and installation of the library.

Activities other than copying, distribution and modification are not covered by this License; they are outside its scope. The act of running a program using the Library is not restricted, and output from such a program is covered only if its contents constitute a work based on the Library (independent of the use of the Library in a tool for writing it). Whether that is true depends on what the Library does and what the program that uses the Library does.

1. You may copy and distribute verbatim copies of the Library's complete source code as you receive it, in any medium, provided that you conspicuously and appropriately publish on each copy an appropriate copyright notice and disclaimer of warranty; keep intact all the notices that refer to this License and to the absence of any warranty; and distribute a copy of this License along with the Library.

You may charge a fee for the physical act of transferring a copy, and you may at your option offer warranty protection in exchange for a fee.

2. You may modify your copy or copies of the Library or any portion of it, thus forming a work based on the Library, and copy and distribute such modifications or work under the terms of Section 1 above, provided that you also meet all of these conditions:

- a) The modified work must itself be a software library.
- b) You must cause the files modified to carry prominent notices stating that you changed the files and the date of any change.
- c) You must cause the whole of the work to be licensed at no charge to all third parties under the terms of this License.
- d) If a facility in the modified Library refers to a function or a table of data to be supplied by an application program that uses the facility, other than as an argument passed when the facility is invoked, then you must make a good faith effort to ensure that, in the event an application does not supply such function or table, the facility still operates, and performs whatever part of its purpose remains meaningful.

(For example, a function in a library to compute square roots has a purpose that is entirely well-defined independent of the application. Therefore, Subsection 2d requires that any application-supplied function or table used by this function must be optional: if the application does not supply it, the square root function must still compute square roots.)

These requirements apply to the modified work as a whole. If identifiable sections of that work are not derived from the Library, and can be reasonably considered independent and separate works in themselves, then this License, and its terms, do not apply to those sections when you distribute them as separate works. But when you distribute the same sections as part of a whole which is a work based on the Library, the distribution of the whole must be on the terms of this License, whose permissions for other licensees extend to the entire whole, and thus to each and every part regardless of who wrote it.

Thus, it is not the intent of this section to claim rights or contest your rights to work written entirely by you; rather, the intent is to exercise the right to control the distribution of derivative or collective works based on the Library.

In addition, mere aggregation of another work not based on the Library with the Library (or with a work based on the Library) on a volume of a storage or distribution medium does not bring the other work under the scope of this License.

3. You may opt to apply the terms of the ordinary GNU General Public License instead of this License to a given copy of the Library. To do this, you must alter all the notices that refer to this License, so that they refer to the ordinary GNU General Public License, version 2, instead of to this License. (If a newer version than version 2 of the ordinary GNU General Public License has appeared, then you can specify that version instead if you wish.) Do not make any other change in these notices.

Once this change is made in a given copy, it is irreversible for that copy, so the ordinary GNU General Public License applies to all subsequent copies and derivative works made from that copy.

This option is useful when you wish to copy part of the code of the Library into a program that is not a library.

4. You may copy and distribute the Library (or a portion or derivative of it, under Section 2) in object code or executable form under the terms of Sections 1 and 2 above provided that you accompany it with the complete corresponding machine-readable source code, which must be distributed under the terms of Sections 1 and 2 above on a medium customarily used for software interchange.

If distribution of object code is made by offering access to copy from a designated place, then offering equivalent access to copy the source code from the same place satisfies the requirement to distribute the source code, even though third parties are not compelled to copy the source along with the object code.

5. A program that contains no derivative of any portion of the Library, but is designed to work with the Library by being compiled or linked with it, is called a "work that uses the Library". Such a work, in isolation, is not a derivative work of the Library, and therefore falls outside the scope of this License.

However, linking a "work that uses the Library" with the Library creates an executable that is a derivative of the Library (because it contains portions of the Library), rather than a "work that uses the library". The executable is therefore covered by this License. Section 6 states terms for distribution of such executables.

When a "work that uses the Library" uses material from a header file that is part of the Library, the object code for the work may be a derivative work of the Library even though the source code is not. Whether this is true is especially significant if the work can be linked without the Library, or if the work is itself a library. The threshold for this to be true is not precisely defined by law.

If such an object file uses only numerical parameters, data structure layouts and accessors, and small macros and small inline functions (ten lines or less in length), then the use of the object file is unrestricted, regardless of whether it is legally a derivative work. (Executables containing this object code plus portions of the Library will still fall under Section 6.)

Otherwise, if the work is a derivative of the Library, you may distribute the object code for the work under the terms of Section 6. Any executables containing that work also fall under Section 6, whether or not they are linked directly with the Library itself.

6. As an exception to the Sections above, you may also combine or link a "work that uses the Library" with the Library to produce a work containing portions of the Library, and distribute that work under terms of your choice, provided that the terms permit modification of the work for the customer's own use and reverse engineering for debugging such modifications.

You must give prominent notice with each copy of the work that the Library is used in it and that the Library and its use are covered by this License. You must supply a copy of this License. If the work during execution displays copyright notices, you must include the copyright notice for the Library among them, as well as a reference directing the user to the copy of this License. Also, you must do one of these things:

- a) Accompany the work with the complete corresponding machine-readable source code for the Library including whatever changes were used in the work (which must be distributed under Sections 1 and 2 above); and, if the work is an executable linked with the Library, with the complete machine-readable "work that uses the Library", as object code and/or source code, so that the user can modify the Library and then relink to produce a modified executable containing the modified Library. (It is understood that the user who changes the contents of definitions files in the Library will not necessarily be able to recompile the application to use the modified definitions.)
- b) Use a suitable shared library mechanism for linking with the Library. A suitable mechanism is one that (1) uses at run time a copy of the library already present on the user's computer system, rather than copying library functions into the executable, and (2) will operate properly with a modified version of the library, if the user installs one, as long as the modified version is interface-compatible with the version that the work was made with.
- c) Accompany the work with a written offer, valid for at least three years, to give the same user the materials specified in Subsection 6a, above, for a charge no more than the cost of performing this distribution.
- d) If distribution of the work is made by offering access to copy from a designated place, offer equivalent access to copy the above specified materials from the same place.
- e) Verify that the user has already received a copy of these materials or that you have already sent this user a copy.

For an executable, the required form of the "work that uses the Library" must include any data and utility programs needed for reproducing the executable from it. However, as a special exception, the materials to be distributed need not include anything that is normally distributed (in either source or binary form) with the major components (compiler, kernel, and so on) of the operating system on which the executable runs, unless that component itself accompanies the executable.

It may happen that this requirement contradicts the license restrictions of other proprietary libraries that do not normally accompany the operating system. Such a contradiction means you cannot use both them and the Library together in an executable that you distribute.

7. You may place library facilities that are a work based on the Library side-by-side in a single library together with other library facilities not covered by this License, and distribute such a combined library, provided that the separate distribution of the work based on the Library and of the other library facilities is otherwise permitted, and provided that you do these two things:

- a) Accompany the combined library with a copy of the same work based on the Library, uncombined with any other library facilities. This must be distributed under the terms of the Sections above.
- b) Give prominent notice with the combined library of the fact that part of it is a work based on the Library, and explaining where to find the accompanying uncombined form of the same work.

8. You may not copy, modify, sublicense, link with, or distribute the Library except as expressly provided under this License. Any attempt otherwise to copy, modify, sublicense, link with, or distribute the Library is void, and will automatically terminate your rights under this License. However, parties who have received copies, or rights, from you under this License will not have their licenses terminated so long as such parties remain in full compliance.

9. You are not required to accept this License, since you have not signed it. However, nothing else grants you permission to modify or distribute the Library or its derivative works. These actions are prohibited by law if you do not accept this License. Therefore, by modifying or distributing the Library (or any work based on the Library), you indicate your acceptance of this License to do so, and all its terms and conditions for copying, distributing or modifying the Library or works based on it.
10. Each time you redistribute the Library (or any work based on the Library), the recipient automatically receives a license from the original licensor to copy, distribute, link with or modify the Library subject to these terms and conditions. You may not impose any further restrictions on the recipients' exercise of the rights granted herein. You are not responsible for enforcing compliance by third parties with this License.
11. If, as a consequence of a court judgment or allegation of patent infringement or for any other reason (not limited to patent issues), conditions are imposed on you (whether by court order, agreement or otherwise) that contradict the conditions of this License, they do not excuse you from the conditions of this License. If you cannot distribute so as to satisfy simultaneously your obligations under this License and any other pertinent obligations, then as a consequence you may not distribute the Library at all. For example, if a patent license would not permit royalty-free redistribution of the Library by all those who receive copies directly or indirectly through you, then the only way you could satisfy both it and this License would be to refrain entirely from distribution of the Library.

If any portion of this section is held invalid or unenforceable under any particular circumstance, the balance of the section is intended to apply, and the section as a whole is intended to apply in other circumstances.

It is not the purpose of this section to induce you to infringe any patents or other property right claims or to contest validity of any such claims; this section has the sole purpose of protecting the integrity of the free software distribution system which is implemented by public license practices. Many people have made generous contributions to the wide range of software distributed through that system in reliance on consistent application of that system; it is up to the author/donor to decide if he or she is willing to distribute software through any other system and a licensee cannot impose that choice.

This section is intended to make thoroughly clear what is believed to be a consequence of the rest of this License.

12. If the distribution and/or use of the Library is restricted in certain countries either by patents or by copyrighted interfaces, the original copyright holder who places the Library under this License may add an explicit geographical distribution limitation excluding those countries, so that distribution is permitted only in or among countries not thus excluded. In such case, this License incorporates the limitation as if written in the body of this License.
13. The Free Software Foundation may publish revised and/or new versions of the Lesser General Public License from time to time. Such new versions will be similar in spirit to the present version, but may differ in detail to address new problems or concerns.

Each version is given a distinguishing version number. If the Library specifies a version number of this License which applies to it and "any later version", you have the option of following the terms and conditions either of that version or of any later version published by the Free Software Foundation. If the Library does not specify a license version number, you may choose any version ever published by the Free Software Foundation.

14. If you wish to incorporate parts of the Library into other free programs whose distribution conditions are incompatible with these, write to the author to ask for permission. For software which is copyrighted by the Free Software Foundation, write to the Free Software Foundation; we sometimes make exceptions for this. Our decision will be guided by the two goals of preserving the free status of all derivatives of our free software and of promoting the sharing and reuse of software generally.

#### NO WARRANTY

15. BECAUSE THE LIBRARY IS LICENSED FREE OF CHARGE, THERE IS NO WARRANTY FOR THE LIBRARY, TO THE EXTENT PERMITTED BY APPLICABLE LAW. EXCEPT WHEN OTHERWISE STATED IN WRITING THE COPYRIGHT HOLDERS AND/OR OTHER PARTIES PROVIDE THE LIBRARY "AS IS" WITHOUT WARRANTY OF ANY KIND, EITHER EXPRESSED OR IMPLIED, INCLUDING, BUT NOT LIMITED TO, THE IMPLIED WARRANTIES OF MERCHANTABILITY AND FITNESS FOR A PARTICULAR PURPOSE. THE ENTIRE RISK AS TO THE QUALITY AND PERFORMANCE OF THE LIBRARY IS WITH YOU. SHOULD THE LIBRARY PROVE DEFECTIVE, YOU ASSUME THE COST OF ALL NECESSARY SERVICING, REPAIR OR CORRECTION.
16. IN NO EVENT UNLESS REQUIRED BY APPLICABLE LAW OR AGREED TO IN WRITING WILL ANY COPYRIGHT HOLDER, OR ANY OTHER PARTY WHO MAY MODIFY AND/OR REDISTRIBUTE THE LIBRARY AS PERMITTED ABOVE, BE LIABLE TO YOU FOR DAMAGES, INCLUDING ANY GENERAL, SPECIAL, INCIDENTAL OR CONSEQUENTIAL DAMAGES ARISING OUT OF THE USE OR INABILITY TO USE THE LIBRARY (INCLUDING BUT NOT LIMITED TO LOSS OF DATA OR DATA BEING RENDERED INACCURATE OR LOSSES SUSTAINED BY YOU OR THIRD PARTIES OR A FAILURE OF THE LIBRARY TO OPERATE WITH ANY OTHER SOFTWARE), EVEN IF SUCH HOLDER OR OTHER PARTY HAS BEEN ADVISED OF THE POSSIBILITY OF SUCH DAMAGES.

#### END OF TERMS AND CONDITIONS

How to Apply These Terms to Your New Libraries

If you develop a new library, and you want it to be of the greatest possible use to the public, we recommend making it free software that everyone can redistribute and change. You can do so by permitting redistribution under these terms (or, alternatively, under the terms of the ordinary General Public License).

To apply these terms, attach the following notices to the library. It is safest to attach them to the start of each source file to most effectively convey the exclusion of warranty; and each file should have at least the "copyright" line and a pointer to where the full notice is found.

```
<one line to give the library's name and a brief idea of what it does.> Copyright (C)
<year> <name of author>
```

This library is free software; you can redistribute it and/or modify it under the terms of the GNU Lesser General Public License as published by the Free Software Foundation; either version 2 of the License, or (at your option) any later version.

This library is distributed in the hope that it will be useful, but WITHOUT ANY WARRANTY; without even the implied warranty of MERCHANTABILITY or FITNESS FOR A PARTICULAR PURPOSE. See the GNU Lesser General Public License for more details.

You should have received a copy of the GNU Lesser General Public License along with this library; if not, write to the Free Software Foundation, Inc., 59 Temple Place, Suite 330, Boston, MA 02111-1307 USA

Also add information on how to contact you by electronic and paper mail.

You should also get your employer (if you work as a programmer) or your school, if any, to sign a "copyright disclaimer" for the library, if necessary. Here is a sample; alter the names:

```
Yoyodyne, Inc., hereby disclaims all copyright interest in the library 'Frob' (a
library for tweaking knobs) written by James Random Hacker.
```

```
<signature of Ty Coon>, 1 April 1990 Ty Coon, President of Vice
```

That's all there is to it!

## ■ About Fusion

DirectFB Fusion kernel module: introduction and API  
by Niels Roest

Copyright (C) 2009 Niels Roest

This documentation is free software; you can redistribute it and/or modify it under the terms of the GNU General Public License as published by the Free Software Foundation; either version 2 of the License, or (at your option) any later version.

This program is distributed in the hope that it will be useful, but WITHOUT ANY WARRANTY; without even the implied warranty of MERCHANTABILITY or FITNESS FOR A PARTICULAR PURPOSE. See the GNU General Public License for more details.

You should have received a copy of the GNU General Public License along with this program; if not, write to the Free Software Foundation, Inc., 59 Temple Place, Suite 330, Boston, MA 02111-1307 USA

For more details see the "COPYING" in the source distribution of Linux.

## ■ About openssl

Copyright (C) 1998-2008 The OpenSSL Project. All rights reserved.

Redistribution and use in source and binary forms, with or without modification, are permitted provided that the following conditions are met:

1. Redistributions of source code must retain the above copyright notice, this list of conditions and the following disclaimer.
2. Redistributions in binary form must reproduce the above copyright notice, this list of conditions and the following disclaimer in the documentation and/or other materials provided with the distribution.
3. All advertising materials mentioning features or use of this software must display the following acknowledgment:  
"This product includes software developed by the OpenSSL Project for use in the OpenSSL Toolkit. (<http://www.openssl.org/>)"
4. The names "OpenSSL Toolkit" and "OpenSSL Project" must not be used to endorse or promote products derived from this software without prior written permission. For written permission, please contact [openssl-core@openssl.org](mailto:openssl-core@openssl.org).
5. Products derived from this software may not be called "OpenSSL" nor may "OpenSSL" appear in their names without prior written permission of the OpenSSL Project.
6. Redistributions of any form whatsoever must retain the following acknowledgment:  
"This product includes software developed by the OpenSSL Project for use in the OpenSSL Toolkit (<http://www.openssl.org/>)"

THIS SOFTWARE IS PROVIDED BY THE OPENSSL PROJECT "AS IS" AND ANY EXPRESSED OR IMPLIED WARRANTIES, INCLUDING, BUT NOT LIMITED TO, THE IMPLIED WARRANTIES OF MERCHANTABILITY AND FITNESS FOR A PARTICULAR PURPOSE ARE DISCLAIMED. IN NO EVENT SHALL THE OPENSSL PROJECT OR ITS CONTRIBUTORS BE LIABLE FOR ANY DIRECT, INDIRECT, INCIDENTAL, SPECIAL, EXEMPLARY, OR CONSEQUENTIAL DAMAGES (INCLUDING, BUT NOT LIMITED TO, PROCUREMENT OF SUBSTITUTE GOODS OR SERVICES; LOSS OF USE, DATA, OR PROFITS; OR BUSINESS INTERRUPTION) HOWEVER CAUSED AND ON ANY THEORY OF LIABILITY, WHETHER IN CONTRACT, STRICT LIABILITY, OR TORT (INCLUDING NEGLIGENCE OR OTHERWISE) ARISING IN ANY WAY OUT OF THE USE OF THIS SOFTWARE, EVEN IF ADVISED OF THE POSSIBILITY OF SUCH DAMAGE.

This product includes cryptographic software written by Eric Young ([ey@cryptsoft.com](mailto:ey@cryptsoft.com)). This product includes software written by Tim Hudson ([tjh@cryptsoft.com](mailto:tjh@cryptsoft.com)).

## Original SSLeay License

Copyright (C) 1995-1998 Eric Young (eay@cryptsoft.com) All rights reserved. This package is an SSL implementation written by Eric Young (eay@cryptsoft.com). The implementation was written so as to conform with Netscapes SSL. This library is free for commercial and non-commercial use as long as the following conditions are adhered to. The following conditions apply to all code found in this distribution, be it the RC4, RSA, lhash, DES, etc., code; not just the SSL code. The SSL documentation included with this distribution is covered by the same copyright terms except that the holder is Tim Hudson (tjh@cryptsoft.com). Copyright remains Eric Young's, and as such any Copyright notices in the code are not to be removed. If this package is used in a product, Eric Young should be given attribution as the author of the parts of the library used. This can be in the form of a textual message at program startup or in documentation (online or textual) provided with the package.

Redistribution and use in source and binary forms, with or without modification, are permitted provided that the following conditions are met:

1. Redistributions of source code must retain the copyright notice, this list of conditions and the following disclaimer.
2. Redistributions in binary form must reproduce the above copyright notice, this list of conditions and the following disclaimer in the documentation and/or other materials provided with the distribution.
3. All advertising materials mentioning features or use of this software must display the following acknowledgement:  
"This product includes cryptographic software written by Eric Young (eay@cryptsoft.com)" The word 'cryptographic' can be left out if the routines from the library being used are not cryptographic related :-).
4. If you include any Windows specific code (or a derivative thereof) from the apps directory (application code) you must include an acknowledgement:  
"This product includes software written by Tim Hudson (tjh@cryptsoft.com)"

THIS SOFTWARE IS PROVIDED BY ERIC YOUNG "AS IS" AND ANY EXPRESS OR IMPLIED WARRANTIES, INCLUDING, BUT NOT LIMITED TO, THE IMPLIED WARRANTIES OF MERCHANTABILITY AND FITNESS FOR A PARTICULAR PURPOSE ARE DISCLAIMED. IN NO EVENT SHALL THE AUTHOR OR CONTRIBUTORS BE LIABLE FOR ANY DIRECT, INDIRECT, INCIDENTAL, SPECIAL, EXEMPLARY, OR CONSEQUENTIAL DAMAGES (INCLUDING, BUT NOT LIMITED TO, PROCUREMENT OF SUBSTITUTE GOODS OR SERVICES; LOSS OF USE, DATA, OR PROFITS; OR BUSINESS INTERRUPTION) HOWEVER CAUSED AND ON ANY THEORY OF LIABILITY, WHETHER IN CONTRACT, STRICT LIABILITY, OR TORT (INCLUDING NEGLIGENCE OR OTHERWISE) ARISING IN ANY WAY OUT OF THE USE OF THIS SOFTWARE, EVEN IF ADVISED OF THE POSSIBILITY OF SUCH DAMAGE.

The licence and distribution terms for any publically available version or derivative of this code cannot be changed. i.e. this code cannot simply be copied and put under another distribution licence [including the GNU Public Licence.]

## ■ About zlib

Copyright notice:

(C) 1995-2004 Jean-loup Gailly and Mark Adler

This software is provided 'as-is', without any express or implied warranty. In no event will the authors be held liable for any damages arising from the use of this software. Permission is granted to anyone to use this software for any purpose, including commercial applications, and to alter it and redistribute it freely, subject to the following restrictions:

1. The origin of this software must not be misrepresented; you must not claim that you wrote the original software. If you use this software in a product, an acknowledgment in the product documentation would be appreciated but is not required.

2. Altered source versions must be plainly marked as such, and must not be misrepresented as being the original software.

3. This notice may not be removed or altered from any source distribution.

Jean-loup Gailly Mark Adler  
jloup@zip.org madler@alumni.caltech.edu

If you use the zlib library in a product, we would appreciate \*not\* receiving lengthy legal documents to sign. The sources are provided for free but without warranty of any kind. The library has been entirely written by Jean-loup Gailly and Mark Adler; it does not include third-party code.

If you redistribute modified sources, we would appreciate that you include in the file ChangeLog history information documenting your changes. Please read the FAQ for more information on the distribution of modified source versions.

## ■ About FreeType

The FreeType Project LICENSE

2006-Jan-27

Copyright 1996-2002, 2006 by

David Turner, Robert Wilhelm, and Werner Lemberg

### Introduction

The FreeType Project is distributed in several archive packages; some of them may contain, in addition to the FreeType font engine, various tools and contributions which rely on, or relate to, the FreeType Project.

This license applies to all files found in such packages, and which do not fall under their own explicit license. The license affects thus the FreeType font engine, the test programs, documentation and makefiles, at the very least.

This license was inspired by the BSD, Artistic, and IJG (Independent JPEG Group) licenses, which all encourage inclusion and use of free software in commercial and freeware products alike. As a consequence, its main points are that:

- o We don't promise that this software works. However, we will be interested in any kind of bug reports. ('as is' distribution)
- o You can use this software for whatever you want, in parts or full form, without having to pay us. ('royalty-free' usage)
- o You may not pretend that you wrote this software. If you use it, or only parts of it, in a program, you must acknowledge somewhere in your documentation that you have used the FreeType code. ('credits')

We specifically permit and encourage the inclusion of this software, with or without modifications, in commercial products. We disclaim all warranties covering The FreeType Project and assume no liability related to The FreeType Project. Finally, many people asked us for a preferred form for a credit/disclaimer to use in compliance with this license. We thus encourage you to use the following text:

Portions of this software are copyright (C) <year> The FreeType Project (www.freetype.org). All rights reserved.

Please replace <year> with the value from the FreeType version you actually use.

### Legal Terms

#### 0. Definitions

Throughout this license, the terms 'package', 'FreeType Project', and 'FreeType archive' refer to the set of files originally distributed by the authors (David Turner, Robert Wilhelm, and Werner Lemberg) as the 'FreeType Project', be they named as alpha, beta or final release.

'You' refers to the licensee, or person using the project, where 'using' is a generic term including compiling the project's source code as well as linking it to form a 'program' or 'executable'. This program is referred to as 'a program using the FreeType engine'. This license applies to all files distributed in the original FreeType Project, including all source code, binaries and documentation, unless otherwise stated in the file in its original, unmodified form as distributed in the original archive. If you are unsure whether or not a particular file is covered by this license, you must contact us to verify this.

The FreeType Project is copyright (C) 1996-2000 by David Turner, Robert Wilhelm, and Werner Lemberg. All rights reserved except as specified below.

#### 1. No Warranty

THE FREETYPE PROJECT IS PROVIDED 'AS IS' WITHOUT WARRANTY OF ANY KIND, EITHER EXPRESS OR IMPLIED, INCLUDING, BUT NOT LIMITED TO, WARRANTIES OF MERCHANTABILITY AND FITNESS FOR A PARTICULAR PURPOSE. IN NO EVENT WILL ANY OF THE AUTHORS OR COPYRIGHT HOLDERS BE LIABLE FOR ANY DAMAGES CAUSED BY THE USE OR THE INABILITY TO USE, OF THE FREETYPE PROJECT.

#### 2. Redistribution

This license grants a worldwide, royalty-free, perpetual and irrevocable right and license to use, execute, perform, compile, display, copy, create derivative works of, distribute and sublicense the FreeType Project (in both source and object code forms) and derivative works thereof for any purpose; and to authorize others to exercise some or all of the rights granted herein, subject to the following conditions:

- o Redistribution of source code must retain this license file ('FTL.TXT') unaltered; any additions, deletions or changes to the original files must be clearly indicated in accompanying documentation. The copyright notices of the unaltered, original files must be preserved in all copies of source files.
- o Redistribution in binary form must provide a disclaimer that states that the software is based in part of the work of the FreeType Team, in the distribution documentation. We also encourage you to put an URL to the FreeType web page in your documentation, though this isn't mandatory.

These conditions apply to any software derived from or based on the FreeType Project, not just the unmodified files. If you use our work, you must acknowledge us. However, no fee need be paid to us.

#### 3. Advertising

Neither the FreeType authors and contributors nor you shall use the name of the other for commercial, advertising, or promotional purposes without specific prior written permission.

We suggest, but do not require, that you use one or more of the following phrases to refer to this software in your documentation or advertising materials: 'FreeType Project', 'FreeType Engine', 'FreeType library', or 'FreeType Distribution'.

As you have not signed this license, you are not required to accept it. However, as the FreeType Project is copyrighted material, only this license, or another one contracted with the authors, grants you the right to use, distribute, and modify it. Therefore, by using, distributing, or modifying the FreeType Project, you indicate that you understand and accept all the terms of this license.

#### 4. Contacts

There are two mailing lists related to FreeType:

- o [freetype@nongnu.org](mailto:freetype@nongnu.org)  
Discusses general use and applications of FreeType, as well as future and wanted additions to the library and distribution. If you are looking for support, start in this list if you haven't found anything to help you in the documentation.
- o [freetype-devel@nongnu.org](mailto:freetype-devel@nongnu.org)  
Discusses bugs, as well as engine internals, design issues, specific licenses, porting, etc. Our home page can be found at <http://www.freetype.org>

## ■ About Expat

Copyright (C) 1998, 1999, 2000 Thai Open Source Software Center Ltd  
and Clark Cooper

Copyright (C) 2001, 2002, 2003, 2004, 2005, 2006 Expat maintainers.

Permission is hereby granted, free of charge, to any person obtaining a copy of this software and associated documentation files (the "Software"), to deal in the Software without restriction, including without limitation the rights to use, copy, modify, merge, publish, distribute, sublicense, and/or sell copies of the Software, and to permit persons to whom the Software is furnished to do so, subject to the following conditions: The above copyright notice and this permission notice shall be included in all copies or substantial portions of the Software.

THE SOFTWARE IS PROVIDED "AS IS", WITHOUT WARRANTY OF ANY KIND, EXPRESS OR IMPLIED, INCLUDING BUT NOT LIMITED TO THE WARRANTIES OF MERCHANTABILITY, FITNESS FOR A PARTICULAR PURPOSE AND NONINFRINGEMENT. IN NO EVENT SHALL THE AUTHORS OR COPYRIGHT HOLDERS BE LIABLE FOR ANY CLAIM, DAMAGES OR OTHER LIABILITY, WHETHER IN AN ACTION OF CONTRACT, TORT OR OTHERWISE, ARISING FROM, OUT OF OR IN CONNECTION WITH THE SOFTWARE OR THE USE OR OTHER DEALINGS IN THE SOFTWARE.

## ■ About cURL

COPYRIGHT AND PERMISSION NOTICE

Copyright (C) 1996 - 2009, Daniel Stenberg, <daniel@haxx.se>.

All rights reserved.

Permission to use, copy, modify, and distribute this software for any purpose with or without fee is hereby granted, provided that the above copyright notice and this permission notice appear in all copies.

THE SOFTWARE IS PROVIDED "AS IS", WITHOUT WARRANTY OF ANY KIND, EXPRESS OR IMPLIED, INCLUDING BUT NOT LIMITED TO THE WARRANTIES OF MERCHANTABILITY, FITNESS FOR A PARTICULAR PURPOSE AND NONINFRINGEMENT OF THIRD PARTY RIGHTS. IN NO EVENT SHALL THE AUTHORS OR COPYRIGHT HOLDERS BE LIABLE FOR ANY CLAIM, DAMAGES OR OTHER LIABILITY, WHETHER IN AN ACTION OF CONTRACT, TORT OR OTHERWISE, ARISING FROM, OUT OF OR IN CONNECTION WITH THE SOFTWARE OR THE USE OR OTHER DEALINGS IN THE SOFTWARE.

Except as contained in this notice, the name of a copyright holder shall not be used in advertising or otherwise to promote the sale, use or other dealings in this Software without prior written authorization of the copyright holder.

## ■ About Independent JPEG group

The Independent JPEG Group's JPEG software

README for release 7 of 27-Jun-2009

This distribution contains the seventh public release of the Independent JPEG Group's free JPEG software. You are welcome to redistribute this software and to use it for any purpose, subject to the conditions under LEGAL ISSUES, below.

This software is the work of Tom Lane, Guido Vollbeding, Philip Gladstone, Bill Allombert, Jim Boucher, Lee Crocker, Bob Friesenhahn, Ben Jackson, Julian Minguiillon, Luis Ortiz, George Phillips, Davide Rossi, Ge' Weijers, and other members of the Independent JPEG Group.

IJG is not affiliated with the official ISO JPEG standards committee.

### DOCUMENTATION ROADMAP

This file contains the following sections:

OVERVIEW	General description of JPEG and the IJG software.
LEGAL ISSUES	Copyright, lack of warranty, terms of distribution.
REFERENCES	Where to learn more about JPEG.
ARCHIVE LOCATIONS	Where to find newer versions of this software.
ACKNOWLEDGMENTS	Special thanks.
FILE FORMAT WARS	Software *not* to get.
TO DO	Plans for future IJG releases.

Other documentation files in the distribution are:

User documentation:

install.txt	How to configure and install the IJG software.
usage.txt	Usage instructions for cjpeg, djpeg, jpegtran, rdjpgcom, and wrjpgcom.
*.1	Unix-style man pages for programs (same info as usage.txt).
wizard.txt	Advanced usage instructions for JPEG wizards only.
change.log	Version-to-version change highlights.

Programmer and internal documentation:

libjpeg.txt	How to use the JPEG library in your own programs.
example.c	Sample code for calling the JPEG library.
structure.txt	Overview of the JPEG library's internal structure.
filelist.txt	Road map of IJG files.
coderrules.txt	Coding style rules --- please read if you contribute code.

Please read at least the files install.txt and usage.txt. Some information can also be found in the JPEG FAQ (Frequently Asked Questions) article. See ARCHIVE LOCATIONS below to find out where to obtain the FAQ article.

If you want to understand how the JPEG code works, we suggest reading one or more of the REFERENCES, then looking at the documentation files (in roughly the order listed) before diving into the code.

OVERVIEW

This package contains C software to implement JPEG image encoding, decoding, and transcoding. JPEG (pronounced "jay-peg") is a standardized compression method for full-color and gray-scale images.

This software implements JPEG baseline, extended-sequential, and progressive compression processes. Provision is made for supporting all variants of these processes, although some uncommon parameter settings aren't implemented yet. We have made no provision for supporting the hierarchical or lossless processes defined in the standard.

We provide a set of library routines for reading and writing JPEG image files, plus two sample applications "cjpeg" and "djpeg", which use the library to perform conversion between JPEG and some other popular image file formats. The library is intended to be reused in other applications.

In order to support file conversion and viewing software, we have included considerable functionality beyond the bare JPEG coding/decoding capability; for example, the color quantization modules are not strictly part of JPEG decoding, but they are essential for output to colormapped file formats or colormapped displays.

These extra functions can be compiled out of the library if not required for a particular application.

We have also included "jpegtran", a utility for lossless transcoding between different JPEG processes, and "rdjpgcom" and "wrjpgcom", two simple applications for inserting and extracting textual comments in JFIF files.

The emphasis in designing this software has been on achieving portability and flexibility, while also making it fast enough to be useful. In particular, the software is not intended to be read as a tutorial on JPEG. (See the REFERENCES section for introductory material.) Rather, it is intended to be reliable, portable, industrial-strength code. We do not claim to have achieved that goal in every aspect of the software, but we strive for it.

We welcome the use of this software as a component of commercial products. No royalty is required, but we do ask for an acknowledgement in product documentation, as described under LEGAL ISSUES.

### LEGAL ISSUES

In plain English:

1. We don't promise that this software works. (But if you find any bugs, please let us know!)
2. You can use this software for whatever you want. You don't have to pay us.
3. You may not pretend that you wrote this software. If you use it in a program, you must acknowledge somewhere in your documentation that you've used the IJG code.

In legalese:

The authors make NO WARRANTY or representation, either express or implied, with respect to this software, its quality, accuracy, merchantability, or fitness for a particular purpose. This software is provided "AS IS", and you, its user, assume the entire risk as to its quality and accuracy.

This software is copyright (C) 1991-2009, Thomas G. Lane, Guido Vollbeding.

All Rights Reserved except as specified below.

Permission is hereby granted to use, copy, modify, and distribute this software (or portions thereof) for any purpose, without fee, subject to these conditions:

- (1) If any part of the source code for this software is distributed, then this README file must be included, with this copyright and no-warranty notice unaltered; and any additions, deletions, or changes to the original files must be clearly indicated in accompanying documentation.
- (2) If only executable code is distributed, then the accompanying documentation must state that "this software is based in part on the work of the Independent JPEG Group".
- (3) Permission for use of this software is granted only if the user accepts full responsibility for any undesirable consequences; the authors accept NO LIABILITY for damages of any kind.

These conditions apply to any software derived from or based on the IJG code, not just to the unmodified library. If you use our work, you ought to acknowledge us.

Permission is NOT granted for the use of any IJG author's name or company name in advertising or publicity relating to this software or products derived from it. This software may be referred to only as "the Independent JPEG Group's software".

We specifically permit and encourage the use of this software as the basis of commercial products, provided that all warranty or liability claims are assumed by the product vendor.

ansi2knr.c is included in this distribution by permission of L. Peter Deutsch, sole proprietor of its copyright holder, Aladdin Enterprises of Menlo Park, CA. ansi2knr.c is NOT covered by the above copyright and conditions, but instead by the usual distribution terms of the Free Software Foundation; principally, that you must include source code if you redistribute it. (See the file ansi2knr.c for full details.) However, since ansi2knr.c is not needed as part of any program generated from the IJG code, this does not limit you more than the foregoing paragraphs do.

The Unix configuration script "configure" was produced with GNU Autoconf. It is copyright by the Free Software Foundation but is freely distributable. The same holds for its supporting scripts (config.guess, config.sub, ltmain.sh). Another support script, install-sh, is copyright by X Consortium but is also freely distributable.

The IJG distribution formerly included code to read and write GIF files. To avoid entanglement with the Unisys LZW patent, GIF reading support has been removed altogether, and the GIF writer has been simplified to produce "uncompressed GIFs". This technique does not use the LZW algorithm; the resulting GIF files are larger than usual, but are readable by all standard GIF decoders.

We are required to state that

"The Graphics Interchange Format(c) is the Copyright property of

CompuServe Incorporated. GIF(sm) is a Service Mark property of

CompuServe Incorporated."

### REFERENCES

We recommend reading one or more of these references before trying to understand the innards of the JPEG software.

The best short technical introduction to the JPEG compression algorithm is

Wallace, Gregory K. "The JPEG Still Picture Compression Standard",



(Adjacent articles in that issue discuss MPEG motion picture compression, applications of JPEG, and related topics.) If you don't have the CACM issue handy, a PostScript file containing a revised version of Wallace's article is available at <http://www.ijg.org/files/wallace.ps.gz>. The file (actually a preprint for an article that appeared in IEEE Trans. Consumer Electronics) omits the sample images that appeared in CACM, but it includes corrections and some added material. Note: the Wallace article is copyright ACM and IEEE, and it may not be used for commercial purposes. A somewhat less technical, more leisurely introduction to JPEG can be found in "The Data Compression Book" by Mark Nelson and Jean-loup Gailly, published by M&T Books (New York), 2nd ed. 1996, ISBN 1-55851-434-1. This book provides good explanations and example C code for a multitude of compression methods including JPEG. It is an excellent source if you are comfortable reading C code but don't know much about data compression in general. The book's JPEG sample code is far from industrial-strength, but when you are ready to look at a full implementation, you've got one here...

The best currently available description of JPEG is the textbook "JPEG Still Image Data Compression Standard" by William B. Pennebaker and Joan L. Mitchell, published by Van Nostrand Reinhold, 1993, ISBN 0-442-01272-1. Price US\$59.95, 638 pp. The book includes the complete text of the ISO JPEG standards (DIS 10918-1 and draft DIS 10918-2).

Although this is by far the most detailed and comprehensive exposition of JPEG publicly available, we point out that it is still missing an explanation of the most essential properties and algorithms of the underlying DCT technology. If you think that you know about DCT-based JPEG after reading this book, then you are in delusion. The real fundamentals and corresponding potential of DCT-based JPEG are not publicly known so far, and that is the reason for all the mistaken developments taking place in the image coding domain.

The original JPEG standard is divided into two parts, Part 1 being the actual specification, while Part 2 covers compliance testing methods. Part 1 is titled "Digital Compression and Coding of Continuous-tone Still Images, Part 1: Requirements and guidelines" and has document numbers ISO/IEC IS 10918-1, ITU-T T.81. Part 2 is titled "Digital Compression and Coding of Continuous-tone Still Images, Part 2: Compliance testing" and has document numbers ISO/IEC IS 10918-2, ITU-T T.83. The JPEG standard does not specify all details of an interchangeable file format. For the omitted details we follow the "JFIF" conventions, revision 1.02. A copy of the JFIF spec is available from:

Literature Department  
C-Cube Microsystems, Inc.  
1778 McCarthy Blvd.  
Milpitas, CA 95035  
phone (408) 944-6300, fax (408) 944-6314

A PostScript version of this document is available at <http://www.ijg.org/files/jfif.ps.gz>. There is also a plain text version at <http://www.ijg.org/files/jfif.txt.gz>, but it is missing the figures.

The TIFF 6.0 file format specification can be obtained by FTP from <ftp://ftp.sgi.com/graphics/tiff/TIFF6.ps.gz>. The JPEG incorporation scheme found in the TIFF 6.0 spec of 3-June-92 has a number of serious problems. IJG does not recommend use of the TIFF 6.0 design (TIFF Compression tag 6). Instead, we recommend the JPEG design proposed by TIFF Technical Note #2 (Compression tag 7). Copies of this Note can be obtained from <http://www.ijg.org/files/>. It is expected that the next revision of the TIFF spec will replace the 6.0 JPEG design with the Note's design. Although IJG's own code does not support TIFF/JPEG, the free libtiff library uses our library to implement TIFF/JPEG per the Note.

#### ARCHIVE LOCATIONS

The "official" archive site for this software is [www.ijg.org](http://www.ijg.org). The most recent released version can always be found there in directory "files". This particular version will be archived as <http://www.ijg.org/files/jpegsr.v7.tar.gz>, and in Windows-compatible "zip" archive format as <http://www.ijg.org/files/jpegsr7.zip>. The JPEG FAQ (Frequently Asked Questions) article is a source of some general information about JPEG. It is available on the World Wide Web at <http://www.faqs.org/faqs/jpeg-faq/> and other news.answers archive sites, including the official news.answers archive at [rtfm.mit.edu](mailto:rtfm.mit.edu): <ftp://rtfm.mit.edu/pub/usenet/news.answers/jpeg-faq/>. If you don't have Web or FTP access, send e-mail to [mail-server@rtfm.mit.edu](mailto:mail-server@rtfm.mit.edu) with body

send usenet/news.answers/jpeg-faq/part1  
send usenet/news.answers/jpeg-faq/part2

#### ACKNOWLEDGMENTS

Thank to Juergen Bruder of the Georg-Cantor-Organization at the Martin-Luther-University Halle for providing me with a copy of the common DCT algorithm article, only to find out that I had come to the same result in a more direct and comprehensible way with a more generative approach.

Thank to Istvan Sebestyen and Joan L. Mitchell for inviting me to the ITU JPEG (Study Group 16) meeting in Geneva, Switzerland.

Thank to Thomas Wiegand and Gary Sullivan for inviting me to the Joint Video Team (MPEG & ITU) meeting in Geneva, Switzerland.

Thank to John Korejwa and Massimo Ballerini for inviting me to fruitful consultations in Boston, MA and Milan, Italy.

Thank to Hendrik Elstner, Roland Fassauer, and Simone Zuck for corresponding business development.

Thank to Nico Zschach and Dirk Stelling of the technical support team at the Digital Images company in Halle for providing me with extra equipment for configuration tests.

Thank to Richard F. Lyon (then of Foveon Inc.) for fruitful communication about JPEG configuration in Sigma Photo Pro software.

Last but not least special thank to Thomas G. Lane for the original design and development of this singular software package.

#### FILE FORMAT WARS

The ISO JPEG standards committee actually promotes different formats like JPEG-2000 or JPEG-XR which are incompatible with original DCT-based JPEG and which are based on faulty technologies. IJG therefore does not and will not support such momentary mistakes (see REFERENCES). We have little or no sympathy for the promotion of these formats. Indeed, one of the original reasons for developing this free software was to help force convergence on common, interoperable format standards for JPEG files. Don't use an incompatible file format! (In any case, our decoder will remain capable of reading existing JPEG image files indefinitely.)

#### TO DO

v7 is basically just a necessary interim release, paving the way for a major breakthrough in image coding technology with the next v8 package which is scheduled for release in the year 2010.

Please send bug reports, offers of help, etc. to [jpeg-info@jpegclub.org](mailto:jpeg-info@jpegclub.org).

#### ■ About International Components for Unicode

ICU License - ICU 1.8.1 and later

#### COPYRIGHT AND PERMISSION NOTICE

Copyright (C) 1995-2003 International Business Machines Corporation and others  
All rights reserved.

Permission is hereby granted, free of charge, to any person obtaining a copy of this software and associated documentation files (the "Software"), to deal in the Software without restriction, including without limitation the rights to use, copy, modify, merge, publish, distribute, and/or sell copies of the Software, and to permit persons to whom the Software is furnished to do so, provided that the above copyright notice(s) and this permission notice appear in all copies of the Software and that both the above copyright notice(s) and this permission notice appear in supporting documentation.

THE SOFTWARE IS PROVIDED "AS IS", WITHOUT WARRANTY OF ANY KIND, EXPRESS OR IMPLIED, INCLUDING BUT NOT LIMITED TO THE WARRANTIES OF MERCHANTABILITY, FITNESS FOR A PARTICULAR PURPOSE AND NONINFRINGEMENT OF THIRD PARTY RIGHTS. IN NO EVENT SHALL THE COPYRIGHT HOLDER OR HOLDERS INCLUDED IN THIS NOTICE BE LIABLE FOR ANY CLAIM, OR ANY SPECIAL INDIRECT OR CONSEQUENTIAL DAMAGES, OR ANY DAMAGES WHATSOEVER RESULTING FROM LOSS OF USE, DATA OR PROFITS, WHETHER IN AN ACTION OF CONTRACT, NEGLIGENCE OR OTHER TORTIOUS ACTION, ARISING OUT OF OR IN CONNECTION WITH THE USE OR PERFORMANCE OF THIS SOFTWARE.

Except as contained in this notice, the name of a copyright holder shall not be used in advertising or otherwise to promote the sale, use or other dealings in this Software without prior written authorization of the copyright holder.

All trademarks and registered trademarks mentioned herein are the property of their respective owners.

#### ■ About libpng

This copy of the libpng notices is provided for your convenience. In case of any discrepancy between this copy and the notices in the file png.h that is included in the libpng distribution, the latter shall prevail.

COPYRIGHT NOTICE, DISCLAIMER, and LICENSE:

If you modify libpng you may insert additional notices immediately following this sentence.

libpng versions 1.2.6, August 15, 2004, through 1.2.35, February 14, 2009, are Copyright (C) 2004, 2006-2008 Glenn Randers-Pehrson, and are distributed according to the same disclaimer and license as libpng-1.2.5 with the following individual added to the list of Contributing Authors

Cosmin Truta

libpng versions 1.0.7, July 1, 2000, through 1.2.5 - October 3, 2002, are Copyright (C) 2000-2002 Glenn Randers-Pehrson, and are distributed according to the same disclaimer and license as libpng-1.0.6 with the following individuals added to the list of Contributing Authors

Simon-Pierre Cadieux

Eric S. Raymond

Gilles Vollant

and with the following additions to the disclaimer:

There is no warranty against interference with your enjoyment of the library or against infringement. There is no warranty that our efforts or the library will fulfill any of your particular purposes or needs. This library is provided with all faults, and the entire risk of satisfactory quality, performance, accuracy, and effort is with the user.

libpng versions 0.97, January 1998, through 1.0.6, March 20, 2000, are Copyright (C) 1998, 1999 Glenn Randers-Pehrson, and are distributed according to the same disclaimer and license as libpng-0.96, with the following individuals added to the list of Contributing Authors:

Tom Lane

Glenn Randers-Pehrson

Willem van Schaik

libpng versions 0.89, June 1996, through 0.96, May 1997, are Copyright (C) 1996, 1997 Andreas Dilger Distributed according to the same disclaimer and license as libpng-0.88, with the following individuals added to the list of Contributing Authors:

John Bowler

Kevin Bracey

Sam Bushell

Magnus Holmgren

Greg Roelofs

Tom Tanner

libpng versions 0.5, May 1995, through 0.88, January 1996, are Copyright (C) 1995, 1996 Guy Eric Schalnat, Group 42, Inc. For the purposes of this copyright and license, "Contributing Authors" is defined as the following set of individuals:

Andreas Dilger

Dave Martindale

Guy Eric Schalnat

Paul Schmidt

Tim Wegner

The PNG Reference Library is supplied "AS IS". The Contributing Authors and Group 42, Inc. disclaim all warranties, expressed or implied, including, without limitation, the warranties of merchantability and of fitness for any purpose. The Contributing Authors and Group 42, Inc. assume no liability for direct, indirect, incidental, special, exemplary, or consequential damages, which may result from the use of the PNG Reference Library, even if advised of the possibility of such damage. Permission is hereby granted to use, copy, modify, and distribute this source code, or portions hereof, for any purpose, without fee, subject to the following restrictions:

1. The origin of this source code must not be misrepresented.
2. Altered versions must be plainly marked as such and must not be misrepresented as being the original source.
3. This Copyright notice may not be removed or altered from any source or altered source distribution.

The Contributing Authors and Group 42, Inc. specifically permit, without fee, and encourage the use of this source code as a component to supporting the PNG file format in commercial products. If you use this source code in a product, acknowledgment is not required but would be appreciated.

A "png\_get\_copyright" function is available, for convenience use in "about" boxes and the like:

```
printf("%s",png_get_copyright(NULL));
```

Also, the PNG logo (in PNG format, of course) is supplied in the files "pngbar.png" and "pngbar.jpg (88x31)" and "pngnow.png" (98x31). Libpng is OSI Certified Open Source Software. OSI Certified Open Source is a certification mark of the Open Source Initiative.

Glenn Randers-Pehrson

glennrp at users.sourceforge.net

February 14, 2009

## ■ About tinyxml

[www.sourceforge.net/projects/tinyxml](http://www.sourceforge.net/projects/tinyxml)

Original code (2.0 and earlier) copyright (C) 2000-2006 Lee Thomason ([www.grinninglizard.com](http://www.grinninglizard.com))

This software is provided 'as-is', without any express or implied warranty. In no event will the authors be held liable for any damages arising from the use of this software.

Permission is granted to anyone to use this software for any purpose, including commercial applications, and to alter it and redistribute it freely, subject to the following restrictions:

1. The origin of this software must not be misrepresented; you must not claim that you wrote the original software. If you use this software in a product, an acknowledgment in the product documentation would be appreciated but is not required.
2. Altered source versions must be plainly marked as such, and must not be misrepresented as being the original software.
3. This notice may not be removed or altered from any source distribution.

## ■ About dtoa and strtod

The author of this software is David M. Gay.

Copyright (C) 1991, 2000, 2001 by Lucent Technologies.

Permission to use, copy, modify, and distribute this software for any purpose without fee is hereby granted, provided that this entire notice is included in all copies of any software which is or includes a copy or modification of this software and in all copies of the supporting documentation for such software.

THIS SOFTWARE IS BEING PROVIDED "AS IS", WITHOUT ANY EXPRESS OR IMPLIED WARRANTY. IN PARTICULAR, NEITHER THE AUTHOR NOR LUCENT MAKES ANY REPRESENTATION OR WARRANTY OF ANY KIND CONCERNING THE MERCHANTABILITY OF THIS SOFTWARE OR ITS FITNESS FOR ANY PARTICULAR PURPOSE.

## ■ About gSOAP

gSOAP Public License

Version 1.3b

The gSOAP public license is derived from the Mozilla Public License (MPL1.1). The sections that were deleted from the original MPL1.1 text are 1.0.1, 2.1.(c),(d), 2.2.(c),(d), 8.2.(b), 10, and 11.

Section 3.8 was added. The modified sections are 2.1.(b), 2.2.(b), 3.2 (simplified), 3.5 (deleted the last sentence), and 3.6 (simplified).

This license applies to the gSOAP software package, with the exception of the wsdl2h source code located in `gsoap/wsdl`, all code generated by `wsdl2h`, the UDDI source code `gsoap/uddi2`, and the Web server sample source code `samples/webserver`. To use all of the software commercially, a commercial license has to be obtained from [www.genivia.com](http://www.genivia.com).

1 DEFINITIONS.

1.0.1.

1.1. "Contributor" means each entity that creates or contributes to the creation of Modifications.

1.2. "Contributor Version" means the combination of the Original Code, prior Modifications used by a Contributor, and the Modifications made by that particular Contributor.

1.3. "Covered Code" means the Original Code, or Modifications or the combination of the Original Code, and Modifications, in each case including portions thereof.

1.4. "Electronic Distribution Mechanism" means a mechanism generally accepted in the software development community for the electronic transfer of data.

1.5. "Executable" means Covered Code in any form other than Source Code.

1.6. "Initial Developer" means the individual or entity identified as the Initial Developer in the Source Code notice required by Exhibit A.

1.7. "Larger Work" means a work which combines Covered Code or portions thereof with code not governed by the terms of this License.

1.8. "License" means this document.

1.8.1. "Licensable" means having the right to grant, to the maximum extent possible, whether at the time of the initial grant or subsequently acquired, any and all of the rights conveyed herein.

1.9. "Modifications" means any addition to or deletion from the substance or structure of either the Original Code or any previous Modifications. When Covered Code is released as a series of files, a Modification is: A.

Any addition to or deletion from the contents of a file containing Original Code or previous Modifications. B.

Any new file that contains any part of the Original Code, or previous Modifications.

1.10. "Original Code" means Source Code of computer software code which is described in the Source Code notice required by Exhibit A as Original Code, and which, at the time of its release under this License is not already Covered Code governed by this License.

1.10.1. "Patent Claims" means any patent claim(s), now owned or hereafter acquired, including without limitation, method, process, and apparatus claims, in any patent Licensable by grantor.

<http://www.cs.fsu.edu/~engelen/license.html>

1.11. "Source Code" means the preferred form of the Covered Code for making modifications to it, including all modules it contains, plus any associated interface definition files, scripts used to control compilation and installation of an Executable, or source code differential comparisons against either the Original Code or another well known, available Covered Code of the Contributor's choice. The Source Code can be in a compressed or archival form, provided the appropriate decompression or de-archiving software is widely available for no charge.

1.12. "You" (or "Your") means an individual or a legal entity exercising rights under, and complying with all of the terms of, this License or a future version of this License issued under Section 6.1. For legal entities, "You" includes any entity which controls, is controlled by, or is under common control with You. For purposes of this definition, "control" means (a) the power, direct or indirect, to cause the direction or management of such entity, whether by contract or otherwise, or (b) ownership of more than fifty percent (50%) of the outstanding shares or beneficial ownership of such entity.

### 2 SOURCE CODE LICENSE.

2.1. The Initial Developer Grant. The Initial Developer hereby grants You a world-wide, royalty-free, non-exclusive license, subject to third party intellectual property claims:

- (a) under intellectual property rights (other than patent or trademark) Licensable by Initial Developer to use, reproduce, modify, display, perform, sublicense and distribute the Original Code (or portions thereof) with or without Modifications, and/or as part of a Larger Work; and
- (b) under patents now or hereafter owned or controlled by Initial Developer, to make, have made, use and sell ("offer to sell and import") the Original Code, Modifications, or portions thereof, but solely to the extent that any such patent is reasonably necessary to enable You to utilize, alone or in combination with other software, the Original Code, Modifications, or any combination or portions thereof.

(c)

(d)

### 2.2. Contributor Grant.

Subject to third party intellectual property claims, each Contributor hereby grants You a world-wide, royalty-free, non-exclusive license

- (a) under intellectual property rights (other than patent or trademark) Licensable by Contributor, to use, reproduce, modify, display, perform, sublicense and distribute the Modifications created by such Contributor (or portions thereof) either on an unmodified basis, with other Modifications, as Covered Code and/or as part of a Larger Work; and
- (b) under patents now or hereafter owned or controlled by Contributor, to make, have made, use and sell ("offer to sell and import") the Contributor Version (or portions thereof), but solely to the extent that any such patent is reasonably necessary to enable You to utilize, alone or in combination with other software, the Contributor Version (or portions thereof).

(c)

(d)

### 3 DISTRIBUTION OBLIGATIONS.

#### 3.1. Application of License.

The Modifications which You create or to which You contribute are governed by the terms of this License, including without limitation Section 2.2. The Source Code version of Covered Code may be distributed only under the terms of this License or a future version of this License released under Section 6.1, and You must include a copy of this License with every copy of the Source Code You distribute. You may not offer or impose any terms on any Source Code version that alters or restricts the applicable version of this License or the recipients' rights hereunder. However, You may include an additional document offering the additional rights described in Section 3.5.

#### 3.2. Availability of Source Code.

Any Modification created by You will be provided to the Initial Developer in Source Code form and are subject to the terms of the License.

### 3.3. Description of Modifications.

You must cause all Covered Code to which You contribute to contain a file documenting the changes You made to create that Covered Code and the date of any change. You must include a prominent statement that the Modification is derived, directly or indirectly, from Original Code provided by the Initial Developer and including the name of the Initial Developer in (a) the Source Code, and (b) in any notice in an Executable version or related documentation in which You describe the origin or ownership of the Covered Code.

### 3.4. Intellectual Property Matters.

#### (a) Third Party Claims.

If Contributor has knowledge that a license under a third party's intellectual property rights is required to exercise the rights granted by such Contributor under Sections 2.1 or 2.2, Contributor must include a text file with the Source Code distribution titled "LEGAL" which describes the claim and the party making the claim in sufficient detail that a recipient will know whom to contact. If Contributor obtains such knowledge after the Modification is made available as described in Section 3.2, Contributor shall promptly modify the LEGAL file in all copies Contributor makes available thereafter and shall take other steps (such as notifying appropriate mailing lists or newsgroups) reasonably calculated to inform those who received the Covered Code that new knowledge has been obtained.

#### (b) Contributor APIs.

If Contributor's Modifications include an application programming interface and Contributor has knowledge of patent licenses which are reasonably necessary to implement that API, Contributor must also include this information in the LEGAL file.

#### (c) Representations.

Contributor represents that, except as disclosed pursuant to Section 3.4(a) above, Contributor believes that Contributor's Modifications are Contributor's original creation(s) and/or Contributor has sufficient rights to grant the rights conveyed by this License.

### 3.5. Required Notices.

You must duplicate the notice in Exhibit A in each file of the Source Code. If it is not possible to put such notice in a particular Source Code file due to its structure, then You must include such notice in a location (such as a relevant directory) where a user would be likely to look for such a notice. If You created one or more Modification(s) You may add your name as a Contributor to the notice described in Exhibit A. You must also duplicate this License in any documentation for the Source Code where You describe recipients' rights or ownership rights relating to Covered Code. You may choose to offer, and to charge a fee for, warranty, support, indemnity or liability obligations to one or more recipients of Covered Code. However, You may do so only on Your own behalf, and not on behalf of the Initial Developer or any Contributor.

### 3.6. Distribution of Executable Versions.

You may distribute Covered Code in Executable form only if the requirements of Section 3.1-3.5 have been met for that Covered Code. You may distribute the Executable version of Covered Code or ownership rights under a license of Your choice, which may contain terms different from this License, provided that You are in compliance with the terms of this License and that the license for the Executable version does not attempt to limit or alter the recipient's rights in the Source Code version from the rights set forth in this License. If You distribute the Executable version under a different license You must make it absolutely clear that any terms which differ from this License are offered by You alone, not by the Initial Developer or any Contributor. If You distribute executable versions containing Covered Code as part of a product, you must reproduce the notice in Exhibit B in the documentation and/or other materials provided with the product.

### 3.7. Larger Works.

You may create a Larger Work by combining Covered Code with other code not governed by the terms of this License and distribute the Larger Work as a single product. In such a case, You must make sure the requirements of this License are fulfilled for the Covered Code.

### 3.8. Restrictions.

You may not remove any product identification, copyright, proprietary notices or labels from gSOAP.

### 4. INABILITY TO COMPLY DUE TO STATUTE OR REGULATION.

If it is impossible for You to comply with any of the terms of this License with respect to some or all of the Covered Code due to statute, judicial order, or regulation then You must: (a) comply with the terms of this License to the maximum extent possible; and (b) describe the limitations and the code they affect. Such description must be included in the LEGAL file described in Section 3.4 and must be included with all distributions of the Source Code. Except to the extent prohibited by statute or regulation, such description must be sufficiently detailed for a recipient of ordinary skill to be able to understand it.

### 5. APPLICATION OF THIS LICENSE.

This License applies to code to which the Initial Developer has attached the notice in Exhibit A and to related Covered Code.

### 6. VERSIONS OF THE LICENSE.

#### 6.1. New Versions.

Grantor may publish revised and/or new versions of the License from time to time. Each version will be given a distinguishing version number.

#### 6.2. Effect of New Versions.

Once Covered Code has been published under a particular version of the License, You may always continue to use it under the terms of that version. You may also choose to use such Covered Code under the terms of any subsequent version of the License.

#### 6.3. Derivative Works.

If You create or use a modified version of this License (which you may only do in order to apply it to code which is not already Covered Code governed by this License), You must (a) rename Your license so that the phrase "gSOAP" or any confusingly similar phrase do not appear in your license (except to note that your license differs from this License) and (b) otherwise make it clear that Your version of the license contains terms which differ from the gSOAP Public License. (Filling in the name of the Initial Developer, Original Code or Contributor in the notice described in Exhibit A shall not of themselves be deemed to be modifications of this License.)

### 7. DISCLAIMER OF WARRANTY.

COVERED CODE IS PROVIDED UNDER THIS LICENSE ON AN "AS IS" BASIS, WITHOUT WARRANTY OF ANY KIND, WHETHER EXPRESS, IMPLIED OR STATUTORY, INCLUDING, WITHOUT LIMITATION, THE IMPLIED WARRANTIES OF MERCHANTABILITY, OF FITNESS FOR A PARTICULAR PURPOSE, NON-INFRINGEMENT OF THIRD PARTY INTELLECTUAL PROPERTY RIGHTS, AND ANY WARRANTY THAT MAY ARISE BY REASON OF TRADE USAGE, CUSTOM, OR COURSE OF DEALING, WITHOUT LIMITING THE FOREGOING, YOU ACKNOWLEDGE THAT THE SOFTWARE IS PROVIDED "AS IS" AND THAT THE AUTHORS DO NOT WARRANT THE SOFTWARE WILL RUN UNINTERRUPTED OR ERROR FREE. LIMITED LIABILITY THE ENTIRE RISK AS TO RESULTS AND PERFORMANCE OF THE SOFTWARE IS ASSUMED BY YOU. UNDER NO CIRCUMSTANCES WILL THE AUTHORS BE LIABLE FOR ANY SPECIAL, INDIRECT, INCIDENTAL, EXEMPLARY OR CONSEQUENTIAL DAMAGES OF ANY KIND OR NATURE WHATSOEVER, WHETHER BASED ON CONTRACT, WARRANTY, TORT (INCLUDING NEGLIGENCE), STRICT LIABILITY OR OTHERWISE, ARISING OUT OF OR IN ANY WAY RELATED TO THE SOFTWARE, EVEN IF THE AUTHORS HAVE BEEN ADVISED ON THE POSSIBILITY OF SUCH DAMAGE OR IF SUCH DAMAGE COULD HAVE BEEN REASONABLY FORESEEN, AND NOTWITHSTANDING ANY FAILURE OF ESSENTIAL PURPOSE OF ANY EXCLUSIVE REMEDY PROVIDED. SUCH LIMITATION ON DAMAGES INCLUDES, BUT IS NOT LIMITED TO, DAMAGES FOR LOSS OF GOODWILL, LOST PROFITS, LOSS OF DATA OR SOFTWARE, WORK STOPPAGE, COMPUTER FAILURE OR MALFUNCTION OR IMPAIRMENT OF OTHER GOODS. IN NO EVENT WILL THE AUTHORS BE LIABLE FOR THE COSTS OF PROCUREMENT OF SUBSTITUTE SOFTWARE OR SERVICES. YOU ACKNOWLEDGE THAT THIS SOFTWARE IS NOT DESIGNED FOR USE IN ON-LINE EQUIPMENT IN HAZARDOUS ENVIRONMENTS SUCH AS OPERATION OF NUCLEAR FACILITIES, AIRCRAFT NAVIGATION OR CONTROL, OR LIFE-CRITICAL APPLICATIONS. THE AUTHORS EXPRESSLY DISCLAIM ANY LIABILITY RESULTING FROM USE OF THE SOFTWARE IN ANY SUCH ON-LINE EQUIPMENT IN HAZARDOUS ENVIRONMENTS AND ACCEPTS NO LIABILITY IN RESPECT OF ANY ACTIONS OR CLAIMS BASED ON THE USE OF THE SOFTWARE IN ANY SUCH ON-LINE EQUIPMENT IN HAZARDOUS ENVIRONMENTS BY YOU. FOR PURPOSES OF THIS PARAGRAPH, THE TERM "LIFE-CRITICAL APPLICATION" MEANS AN APPLICATION IN WHICH THE FUNCTIONING OR MALFUNCTIONING OF THE SOFTWARE MAY RESULT DIRECTLY OR INDIRECTLY IN PHYSICAL INJURY OR LOSS OF HUMAN LIFE. THIS DISCLAIMER OF WARRANTY CONSTITUTES AN ESSENTIAL PART OF THIS LICENSE. NO USE OF ANY COVERED CODE IS AUTHORIZED HEREUNDER EXCEPT UNDER THIS DISCLAIMER.

### 8. TERMINATION.

#### 8.1.

This License and the rights granted hereunder will terminate automatically if You fail to comply with terms herein and fail to cure such breach within 30 days of becoming aware of the breach. All sublicenses to the Covered Code which are properly granted shall survive any termination of this License. Provisions which, by their nature, must remain in effect beyond the termination of this License shall survive.

#### 8.2.

#### 8.3.

If You assert a patent infringement claim against Participant alleging that such Participant's Contributor Version directly or indirectly infringes any patent where such claim is resolved (such as by license or settlement) prior to the initiation of patent infringement litigation, then the reasonable value of the licenses granted by such Participant under Sections 2.1 or 2.2 shall be taken into account in determining the amount or value of any payment or license.

#### 8.4.

In the event of termination under Sections 8.1 or 8.2 above, all end user license agreements (excluding distributors and resellers) which have been validly granted by You or any distributor hereunder prior to termination shall survive termination.

### 9. LIMITATION OF LIABILITY.

UNDER NO CIRCUMSTANCES AND UNDER NO LEGAL THEORY, WHETHER TORT (INCLUDING NEGLIGENCE), CONTRACT, OR OTHERWISE, SHALL YOU, THE INITIAL DEVELOPER, ANY OTHER CONTRIBUTOR, OR ANY DISTRIBUTOR OF COVERED CODE, OR ANY SUPPLIER OF ANY OF SUCH PARTIES, BE LIABLE TO ANY PERSON FOR ANY INDIRECT, SPECIAL, INCIDENTAL, OR CONSEQUENTIAL DAMAGES OF ANY CHARACTER INCLUDING, WITHOUT LIMITATION, DAMAGES FOR LOSS OF GOODWILL, WORK STOPPAGE, COMPUTER FAILURE OR MALFUNCTION, OR ANY AND ALL OTHER COMMERCIAL DAMAGES OR LOSSES, EVEN IF SUCH PARTY SHALL HAVE BEEN INFORMED OF THE POSSIBILITY OF SUCH DAMAGES. THIS LIMITATION OF LIABILITY SHALL NOT APPLY TO LIABILITY FOR DEATH OR PERSONAL INJURY RESULTING FROM SUCH PARTY'S NEGLIGENCE TO THE EXTENT APPLICABLE LAW PROHIBITS SUCH LIMITATION. SOME JURISDICTIONS DO NOT ALLOW THE EXCLUSION OR LIMITATION OF INCIDENTAL OR CONSEQUENTIAL DAMAGES, SO THIS EXCLUSION AND LIMITATION MAY NOT APPLY TO YOU.

### 10. U.S. GOVERNMENT END USERS.

### 11. MISCELLANEOUS.

### 12. RESPONSIBILITY FOR CLAIMS.

As between Initial Developer and the Contributors, each party is responsible for claims and damages arising, directly or indirectly, out of its utilization of rights under this License and You agree to work with Initial Developer and Contributors to distribute such responsibility on an equitable basis. Nothing herein is intended or shall be deemed to constitute any admission of liability.

### EXHIBIT A.

"The contents of this file are subject to the gSOAP Public License Version 1.3 (the "License"); you may not use this file except in compliance with the License. You may obtain a copy of the License at <http://www.cs.fsu.edu/~engelen/soaplicense.html>

Software distributed under the License is distributed on an "AS IS" basis, WITHOUT WARRANTY OF ANY KIND, either express or implied. See the License for the specific language governing rights and limitations under the License.

The Original Code of the gSOAP Software is: stdsoap.h, stdsoap2.h, stdsoap.c, stdsoap2.e, stdsoap.cpp, stdsoap2.cpp, soapcpp2.h, soapcpp2.c, soapcpp2\_lex.l, soapcpp2\_yacc.y, error2.h, error2.c, symbol2.c, init2.c, soapdoc2.html, and soapdoc2.pdf, httpget.h, httpget.c, stl.h, stldeque.h, stllist, stlvector.h, stlset.h.

The Initial Developer of the Original Code is Robert A. van Engelen. Portions created by Robert A. van Engelen are Copyright (C) 2001-2004 Robert A. van Engelen, Genivia inc. All Rights Reserved. Contributor(s):

"....."

[Note: The text of this Exhibit A may differ slightly from the text of the notices in the Source Code files of the Original code. You should use the text of this Exhibit A rather than the text found in the Original Code Source Code for Your Modifications.] EXHIBIT B.

"Part of the software embedded in this product is gSOAP software.

Portions created by gSOAP are Copyright (C) 2001-2009 Robert A. van Engelen, Genivia inc. All Rights Reserved. THE SOFTWARE IN THIS PRODUCT WAS IN PART PROVIDED BY GENIVIA INC AND ANY EXPRESS OR IMPLIED WARRANTIES, INCLUDING, BUT NOT LIMITED TO, THE IMPLIED WARRANTIES OF MERCHANTABILITY AND FITNESS FOR A PARTICULAR PURPOSE ARE DISCLAIMED. IN NO EVENT SHALL THE AUTHOR BE LIABLE FOR ANY DIRECT, INDIRECT, INCIDENTAL, SPECIAL, EXEMPLARY, OR CONSEQUENTIAL DAMAGES (INCLUDING, BUT NOT LIMITED TO, PROCUREMENT OF SUBSTITUTE GOODS OR SERVICES; LOSS OF USE, DATA, OR PROFITS; OR BUSINESS INTERRUPTION) HOWEVER CAUSED AND ON ANY THEORY OF LIABILITY, WHETHER IN CONTRACT, STRICT LIABILITY, OR TORT (INCLUDING NEGLIGENCE OR OTHERWISE) ARISING IN ANY WAY OUT OF THE USE OF THIS SOFTWARE, EVEN IF ADVISED OF THE POSSIBILITY OF SUCH DAMAGE."

<http://www.cs.fsu.edu/~engelen/license.html>

## ■ About fonts

Fonts are (c) Bitstream (see below). DejaVu changes are in public domain.

Glyphs imported from Arev fonts are (c) Tavmjong Bah (see below)

### Bitstream Vera Fonts Copyright

Copyright (c) 2003 by Bitstream, Inc. All Rights Reserved. Bitstream Vera is a trademark of Bitstream, Inc.

Permission is hereby granted, free of charge, to any person obtaining a copy of the fonts accompanying this license ("Fonts") and associated documentation files (the "Font Software"), to reproduce and distribute the Font Software, including without limitation the rights to use, copy, merge, publish, distribute, and/or sell copies of the Font Software, and to permit persons to whom the Font Software is furnished to do so, subject to the following conditions:

The above copyright and trademark notices and this permission notice shall be included in all copies of one or more of the Font Software typefaces.

The Font Software may be modified, altered, or added to, and in particular the designs of glyphs or characters in the Fonts may be modified and additional glyphs or characters may be added to the Fonts, only if the fonts are renamed to names not containing either the words "Bitstream" or the word "Vera".

This License becomes null and void to the extent applicable to Fonts or Font Software that has been modified and is distributed under the "Bitstream Vera" names.

The Font Software may be sold as part of a larger software package but no copy of one or more of the Font Software typefaces may be sold by itself.

THE FONT SOFTWARE IS PROVIDED "AS IS". WITHOUT WARRANTY OF ANY KIND, EXPRESS OR IMPLIED, INCLUDING BUT NOT LIMITED TO ANY WARRANTIES OF MERCHANTABILITY, FITNESS FOR A PARTICULAR PURPOSE AND NONINFRINGEMENT OF COPYRIGHT, PATENT, TRADEMARK, OR OTHER RIGHT. IN NO EVENT SHALL BITSTREAM OR THE GNOME FOUNDATION BE LIABLE FOR ANY CLAIM, DAMAGES OR OTHER LIABILITY, INCLUDING ANY GENERAL, SPECIAL, INDIRECT, INCIDENTAL, OR CONSEQUENTIAL DAMAGES, WHETHER IN AN ACTION OF CONTRACT, TORT OR OTHERWISE, ARISING FROM, OUT OF THE USE OR INABILITY TO USE THE FONT SOFTWARE OR FROM OTHER DEALINGS IN THE FONT SOFTWARE.

Except as contained in this notice, the names of Gnome, the Gnome Foundation, and Bitstream Inc., shall not be used in advertising or otherwise to promote the sale, use or other dealings in this Font Software without prior written authorization from the Gnome Foundation or Bitstream Inc., respectively. For further information, contact: fonts at gnome dot org.

### Arev Fonts Copyright

Copyright (c) 2006 by Tavmjong Bah. All Rights Reserved.

Permission is hereby granted, free of charge, to any person obtaining a copy of the fonts accompanying this license ("Fonts") and associated documentation files (the "Font Software"), to reproduce and distribute the modifications to the Bitstream Vera Font Software, including without limitation the rights to use, copy, merge, publish, distribute, and/or sell copies of the Font Software, and to permit persons to whom the Font Software is furnished to do so, subject to the following conditions:

The above copyright and trademark notices and this permission notice shall be included in all copies of one or more of the Font Software typefaces.

The Font Software may be modified, altered, or added to, and in particular the designs of glyphs or characters in the Fonts may be modified and additional glyphs or characters may be added to the Fonts, only if the fonts are renamed to names not containing either the words "Tavmjong Bah" or the word "Arev".

This License becomes null and void to the extent applicable to Fonts or Font Software that has been modified and is distributed under the "Tavmjong Bah Arev" names.

The Font Software may be sold as part of a larger software package but no copy of one or more of the Font Software typefaces may be sold by itself.

THE FONT SOFTWARE IS PROVIDED "AS IS". WITHOUT WARRANTY OF ANY KIND, EXPRESS OR IMPLIED, INCLUDING BUT NOT LIMITED TO ANY WARRANTIES OF MERCHANTABILITY, FITNESS FOR A PARTICULAR PURPOSE AND NONINFRINGEMENT OF COPYRIGHT, PATENT, TRADEMARK, OR OTHER RIGHT. IN NO EVENT SHALL TAVMJONG BAH BE LIABLE FOR ANY CLAIM, DAMAGES OR OTHER LIABILITY, INCLUDING ANY GENERAL, SPECIAL, INDIRECT, INCIDENTAL, OR CONSEQUENTIAL DAMAGES, WHETHER IN AN ACTION OF CONTRACT, TORT OR OTHERWISE, ARISING FROM, OUT OF THE USE OR INABILITY TO USE THE FONT SOFTWARE OR FROM OTHER DEALINGS IN THE FONT SOFTWARE.

Except as contained in this notice, the name of Tavmjong Bah shall not be used in advertising or otherwise to promote the sale, use or other dealings in this Font Software without prior written authorization from Tavmjong Bah. For further information, contact: tavmjong @ free. fr.





**CAUTION**

Use of controls or adjustments or performance of procedures other than those specified herein may result in hazardous radiation exposure.

**LASER Specification:**

Class 1 LASER Product

Wave length: 790 nm (CDs)/658 nm (DVDs)/405 nm (BDs)

Laser output: max. 1 mW

**LASER SAFETY**

This unit employs a laser. Due to possible eye injury, only a qualified service person should remove the cover or attempt to service this device.

**DANGER**

This unit emits visible laser radiation when open. Avoid direct eye exposure to beam. When this unit is plugged into the wall outlet, do not place your eyes close to the opening of the disc tray and other openings to look into inside.

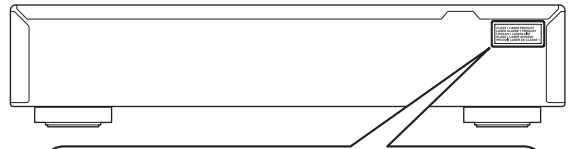

**CLASS 1 LASER PRODUCT  
LASER KLASSE 1 PRODUKT  
LUOKAN 1 LASERLAITE  
KLASS 1 LASER APPARAT  
PRODUIT LASER DE CLASSE 1**

**CAUTION: INVISIBLE LASER RADIATION WHEN OPEN.  
DO NOT STARE INTO BEAM.  
DANGER: INVISIBLE LASER RADIATION WHEN OPEN.  
AVOID DIRECT EXPOSURE TO THE BEAM.**

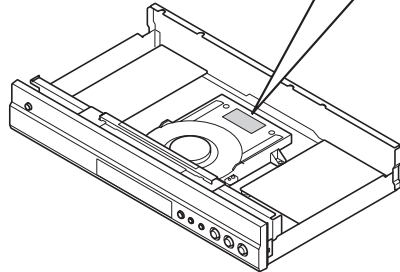



BONUS VIEW™



x.v.Color



**BLOCKBUSTER**  
ON DEMAND®

**FILM FRESH**