

YAMAHA
PORTATONE
PSR-330

Owner's Manual

SPECIAL MESSAGE SECTION

This product utilizes batteries or an external power supply (adapter). DO NOT connect this product to any power supply or adapter other than one described in the manual, on the name plate, or specifically recommended by Yamaha.

This product should be used only with the components supplied or; a cart, rack, or stand that is recommended by Yamaha. If a cart, etc., is used, please observe all safety markings and instructions that accompany the accessory product.

SPECIFICATIONS SUBJECT TO CHANGE:

The information contained in this manual is believed to be correct at the time of printing. However, Yamaha reserves the right to change or modify any of the specifications without notice or obligation to update existing units.

This product, either alone or in combination with an amplifier and headphones or speaker/s, may be capable of producing sound levels that could cause permanent hearing loss. DO NOT operate for long periods of time at a high volume level or at a level that is uncomfortable. If you experience any hearing loss or ringing in the ears, you should consult an audiologist.

IMPORTANT: The louder the sound, the shorter the time period before damage occurs.

NOTICE:

Service charges incurred due to a lack of knowledge relating to how a function or effect works (when the unit is operating as designed) are not covered by the manufacturer's warranty, and are therefore the owners responsibility. Please study this manual carefully and consult your dealer before requesting service.

ENVIRONMENTAL ISSUES:

Yamaha strives to produce products that are both user safe and environmentally friendly. We sincerely believe that our products and the production methods used to produce them, meet these goals. In keeping with both the letter and the spirit of the law, we want you to be aware of the following:

Battery Notice:

This product MAY contain a small non-rechargeable battery which (if applicable) is soldered in place. The average life span of this type of

battery is approximately five years. When replacement becomes necessary, contact a qualified service representative to perform the replacement.

This product may also use "household" type batteries. Some of these may be rechargeable. Make sure that the battery being charged is a rechargeable type and that the charger is intended for the battery being charged.

When installing batteries, do not mix batteries with new, or with batteries of a different type. Batteries MUST be installed correctly. Mismatches or incorrect installation may result in overheating and battery case rupture.

Warning:

Do not attempt to disassemble, or incinerate any battery. Keep all batteries away from children. Dispose of used batteries promptly and as regulated by the laws in your area. Note: Check with any retailer of household type batteries in your area for battery disposal information.

Disposal Notice:

Should this product become damaged beyond repair, or for some reason its useful life is considered to be at an end, please observe all local, state, and federal regulations that relate to the disposal of products that contain lead, batteries, plastics, etc. If your dealer is unable to assist you, please contact Yamaha directly.

NAME PLATE LOCATION:

The name plate is located on the bottom of the product. The model number, serial number, power requirements, etc., are located on this plate. You should record the model number, serial number, and the date of purchase in the spaces provided below and retain this manual as a permanent record of your purchase.

Model

Serial No.

Purchase Date

PLEASE KEEP THIS MANUAL

92-BP

FCC INFORMATION (U.S.A.)

IMPORTANT NOTICE: DO NOT MODIFY THIS UNIT!

This product, when installed as indicated in the instructions contained in this manual, meets FCC requirements. Modifications not expressly approved by Yamaha may void your authority, granted by the FCC, to use the product.

IMPORTANT:

When connecting this product to accessories and/or another product use only high quality shielded cables. Cable/s supplied with this product MUST be used. Follow all installation instructions. Failure to follow instructions could void your FCC authorization to use this product in the USA.

NOTE:

This product has been tested and found to comply with the requirements listed in FCC Regulations, Part 15 for Class "B" digital devices. Compliance with these requirements provides a reasonable level of assurance that your use of this product in a residential environment will not result in harmful interference with other electronic devices. This equipment generates/uses radio frequencies and, if not installed and used according to

the instructions found in the users manual, may cause interference harmful to the operation of other electronic devices. Compliance with FCC regulations does not guarantee that interference will not occur in all installations. If this product is found to be the source of interference, which can be determined by turning the unit "OFF" and "ON", please try to eliminate the problem by using one of the following measures:

- Relocate either this product or the device that is being affected by the interference.
- Utilize power outlets that are on different branch (circuit breaker or fuse) circuits or install AC line filter/s.
- In the case of radio or TV interference, relocate/reorient the antenna. If the antenna lead-in is 300 ohm ribbon lead, change the lead-in to co-axial type cable.

If these corrective measures do not produce satisfactory results, please contact the local retailer authorized to distribute this type of product. If you can not locate the appropriate retailer, please contact Yamaha Corporation of America, Electronic Service Division, 6600 Orangethorpe Ave, Buena Park, CA90620

PRECAUTIONS

PLEASE READ CAREFULLY BEFORE PROCEEDING

* Please keep these precautions in a safe place for future reference.

WARNING

Always follow the basic precautions listed below to avoid the possibility of serious injury or even death from electrical shock, short-circuiting, damages, fire or other hazards. These precautions include, but are not limited to, the following:

- Do not open the instrument or attempt to disassemble the internal parts or modify them in any way. The instrument contains no user-serviceable parts. If it should appear to be malfunctioning, discontinue use immediately and have it inspected by qualified Yamaha service personnel.
- Do not expose the instrument to rain, use it near water or in damp or wet conditions, or place containers on it containing liquids which might spill into any openings.
- If the AC adaptor cord or plug becomes frayed or damaged, or if there is a sudden loss of sound during use of the instrument, or if any unusual smells or smoke should appear to be caused by it, immediately turn off the power switch, disconnect the adaptor plug from the outlet, and have the instrument inspected by qualified Yamaha service personnel.
- Use the specified adaptor (PA-5, PA-5B, PA-5C or an equivalent recommended by Yamaha) only. Using the wrong adaptor can result in damage to the instrument or overheating.
- Before cleaning the instrument, always remove the electric plug from the outlet. Never insert or remove an electric plug with wet hands.
- Check the electric plug periodically and remove any dirt or dust which may have accumulated on it.

CAUTION

Always follow the basic precautions listed below to avoid the possibility of physical injury to you or others, or damage to the instrument or other property. These precautions include, but are not limited to, the following:

- Do not place the AC adaptor cord near heat sources such as heaters or radiators, and do not excessively bend or otherwise damage the cord, place heavy objects on it, or place it in a position where anyone could walk on, trip over, or roll anything over it.
- When removing the electric plug from the instrument or an outlet, always hold the plug itself and not the cord.
- Do not connect the instrument to an electrical outlet using a multiple-connector. Doing so can result in lower sound quality, or possibly cause overheating in the outlet.
- Unplug the AC power adaptor when not using the instrument, or during electrical storms.
- Always make sure all batteries are inserted in conformity with the +/- polarity markings. Failure to do so might result in overheating, fire, or battery fluid leakage.
- Always replace all batteries at the same time. Do not use new batteries together with old ones. Also, do not mix battery types, such as alkaline batteries with manganese batteries, or batteries from different makers, or different types of batteries from the same maker, since this can cause overheating, fire, or battery fluid leakage.
- Do not dispose of batteries in fire.
- Do not attempt to recharge batteries that are not intended to be charged.
- If the instrument is not to be in use for a long time, remove the batteries from it, in order to prevent possible fluid leakage from the battery.
- Keep batteries away from children.
- Before connecting the instrument to other electronic components, turn off the power for all components. Before turning the power on or off for all components, set all volume levels to minimum.
- Do not expose the instrument to excessive dust or vibrations, or extreme cold or heat (such as in direct sunlight, near a heater, or in a car during the day) to prevent the possibility of panel disfiguration or damage to the internal components.
- Do not use the instrument near other electrical products such as televisions, radios, or speakers, since this might cause interference which can affect proper operation of the other products.
- Do not place the instrument in an unstable position where it might accidentally fall over.
- Before moving the instrument, remove all connected adaptor and other cables.
- When cleaning the instrument, use a soft, dry cloth. Do not use paint thinners, solvents, cleaning fluids, or chemical-impregnated wiping cloths. Also, do not place vinyl or plastic objects on the instrument, since this might discolor the panel or keyboard.
- Do not rest your weight on, or place heavy objects on the instrument, and do not use excessive force on the buttons, switches or connectors.
- Use only the stand specified for the instrument. When attaching the stand, use the provided screws only. Failure to do so could cause damage to the internal components or result in the instrument falling over.
- Do not operate the instrument for a long period of time at a high or uncomfortable volume level, since this can cause permanent hearing loss. If you experience any hearing loss or ringing in the ears, consult a physician.

■ SAVING USER DATA

- Save all data to an external device such as the Yamaha MIDI Data Filer MDF2, in order to help prevent the loss of important data due to a malfunction or user operating error.

Yamaha cannot be held responsible for damage caused by improper use or modifications to the instrument, or data that is lost or destroyed.

Always turn the power off when the instrument is not in use.

Make sure to discard used batteries according to local regulations.

(4)

..... Congratulations!

You are the proud owner of a fine electronic keyboard. The Yamaha PSR-330 PortaTone combines the most advanced tone generation technology with state-of-the-art digital electronics and features to give you stunning sound quality with maximum musical enjoyment. A large graphic display and easy-to-use interface also greatly enhance the operability of this advanced instrument.

In order to make the most of your PortaTone's features and extensive performance potential, we urge you to read the manual thoroughly while trying out the various features described. Keep the manual in a safe place for later reference.

..... Important Features



Touch-sensitive 61-key keyboard for a wide range of dynamic musical expression.



Digital effects add depth and ambience to your sound.



An outstanding range of 126 panel voices and 10 drum kits, plus a full set of 128 GM voices.



Minus-one and Repeat functions are ideal for learning new songs and polishing your keyboard technique.



Voice set feature automatically selects the appropriate voice parameter settings for the panel voices.



Song recording feature lets you record four melody tracks with an accompaniment track.



Advanced auto-accompaniment technology gives you 100 fully-orchestrated accompaniment "styles" to back up what you play on the keyboard.



Multi Pads play a number of short rhythmic and melodic sequences that can be used to add impact and variety to your performances.



One Touch Setting feature automatically selects appropriate voice, effect, and other settings for the selected accompaniment style — all you have to do is select a style and play.



Optional Yamaha Music Cartridges can be plugged in for enjoyable automated performance, keyboard practice, and extra accompaniment styles.



Large multi-function LCD display panel makes it easy to select and edit parameters.

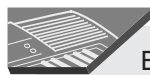

Built-in amplifier and speaker system delivers top-quality sound without the need for external equipment.



Registration Memory saves your favorite panel settings for instant recall when needed.



A range of MIDI functions for expanded musical enjoyment (General MIDI System Level 1 compatible).

Contents

Panel Controls	4	Song Playback	44
Included Accessories	5	Song Playback Procedure	44
The Music Stand	5	Song Volume Control	45
Basic Display Operation	6	Play from a Specified Measure	46
The Display Icons	6	Minus-one Practice	47
The Menus	8	Minus-one Track Assignment	47
Shortcuts	9	Repeat Play	49
Setting Up	10	Song Recording	50
Power Supply	10	Song Recording Procedure	51
Using An Optional AC Power Adaptor	10	Clearing Song Data	54
Using Batteries	10	Clearing an Entire Song	54
Connections	11	Clearing Selected Melody Tracks	54
The PHONES Jack	11	Using Music Cartridges	55
SUSTAIN Jack	11	Inserting a Music Cartridge	55
MIDI IN and OUT Connectors	11	Music Cartridge Handling Precautions	55
The Demonstration	12	Cartridge Songs	56
Playing the PSR-330	14	Cartridge Song Playback	56
The PSR-330 Voices	14	Cartridge Accompaniment Styles	57
A Word About the "R1", "R2", and "L" Voices	14	Revoicing	58
Selecting & Playing Voices	15	Revoicing the R1, R2, and L Voices	58
Keyboard Percussion	17	Revoicing a Style	60
The Dual Voice Mode	17	Revoicing a User Song	61
The Split Voice Mode	18	Overall Functions	63
Changing the SPLIT VOICE Split Point	18	Touch Sensitivity	64
Auto Accompaniment	20	Master Tuning	64
Using Auto Accompaniment	20	Scale Tuning	64
The Synchro Stop Function	24	Metronome	65
Accompaniment Track Muting	25	Split Voice Split Point	65
Muting Individual Tracks	25	Accompaniment Split Point	65
Accompaniment Volume Control	26	Fingering Mode	65
Changing the Accompaniment Split Point	27	Voice Set	65
Interaction Between the AUTO ACCOMPANIMENT		MIDI Functions	66
and SPLIT VOICE Split Points	28	The MIDI Connectors	66
The Auto Accompaniment Fingering Modes	28	Simple MIDI Control	66
The Stop Accompaniment Function	32	MIDI Sequence Recording	67
One Touch Setting	32	The PSR-330 MIDI Functions	67
Digital Effects	34	Transmit Channel & Transmit Track	68
Reverb	34	Receive Channel & Receive Mode	69
Turning the Reverb Effect On or Off	34	Local Control	70
Selecting a Reverb Type	34	Clock	70
Harmony	35	Bulk Data Send	70
Turning the Harmony Effect On or Off	36	Initial Data Send	71
Selecting a Harmony Type	36	Appendix	
Adjusting the Harmony Volume	37	PSR-330 Display MENU/SUB MENU Structure	72
Transpose	38	Troubleshooting	73
Setting Transposition	38	Voice List	74
Registration Memory	39	Maximum Polyphony	74
Registering the Panel Settings	39	Drum Kit List	78
Recall the Registered Panel Settings	40	Data Backup & Initialization	80
The Accompaniment Freeze Function	40	Data Backup	80
The Multi Pads	41	Data Initialization	80
Selecting a MULTI PAD Set	41	MIDI Implementation Chart	81
Turning the CHORD MATCH Function On/Off	42	MIDI Data Format	83
Playing the MULTI PADS	43	Specifications	84
		Index	85

Panel Controls

Top Panel Controls

- 1 POWER Switch page 12
- 2 MASTER VOLUME Control page 12
- 3 DEMO Button page 12
- 4 TEMPO Buttons page 21
- 5 TRANPOSE Buttons page 38
- 6 ACCOMPANIMENT/SONG VOLUME Buttons pages 26, 45
- 7 AUTO ACCOMPANIMENT SECTION
 - AUTO ACCOMPANIMENT ON/OFF Button page 20
 - SYNC STOP Button page 24
 - SYNC START Button page 22
 - INTRO Button page 22
 - MAIN/AUTO FILL A & B Buttons page 22
 - ENDING Button page 24
- 8 RECORD Button page 51
- 9 START/STOP Button pages 13, 22, 24
- 10 DIGITAL EFFECT SECTION
 - REVERB Button page 34
 - HARMONY Button page 36
- 11 DISPLAY & RELATED CONTROLS
 - DISPLAY page 6
 - MENU Buttons page 8
 - SUB MENU Buttons page 8
 - VOICE Button pages 8, 15
 - STYLE Button pages 8, 20
 - SONG Button pages 8, 44
 - CARTRIDGE Button pages 8, 56
 - REVOICE Button page 58
 - TRACK Buttons pages 17, 25, 47, 52
- 12 REGISTRATION MEMORY SECTION
 - MEMORY Button page 40
 - 1, 2, 3, 4 Buttons pages 33, 40
 - FREEZE Button page 40
- 13 ONE TOUCH SETTING Button page 33
- 14 NUMBER Buttons page 15
- 15 + and - Buttons page 13
- 16 MUSIC CARTRIDGE Slot page 55

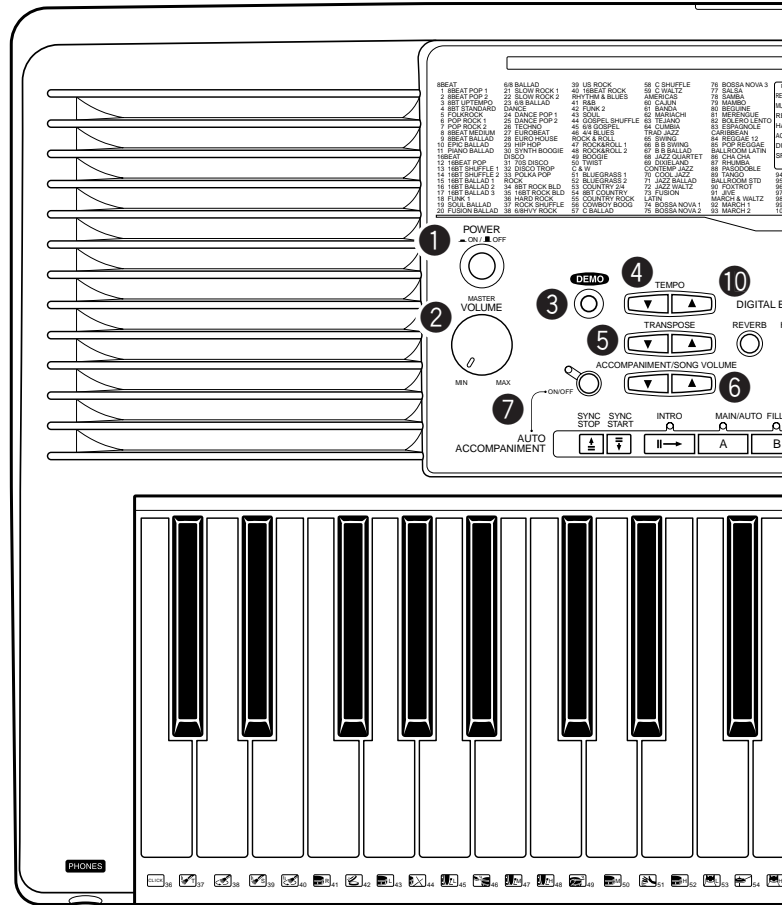

20

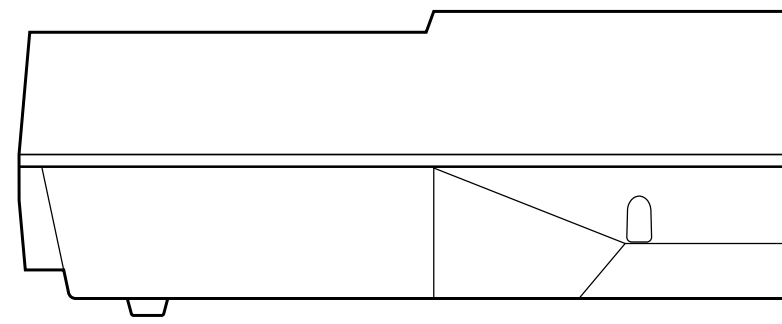

17 KEYBOARD SECTION

- DUAL VOICE Button page 17
- SPLIT VOICE Button page 18

18 MULTI PAD SECTION

- STOP Button page 43
- 1, 2, 3, 4 Buttons page 43

19 Keyboard page 16

20 PHONES Jack page 11

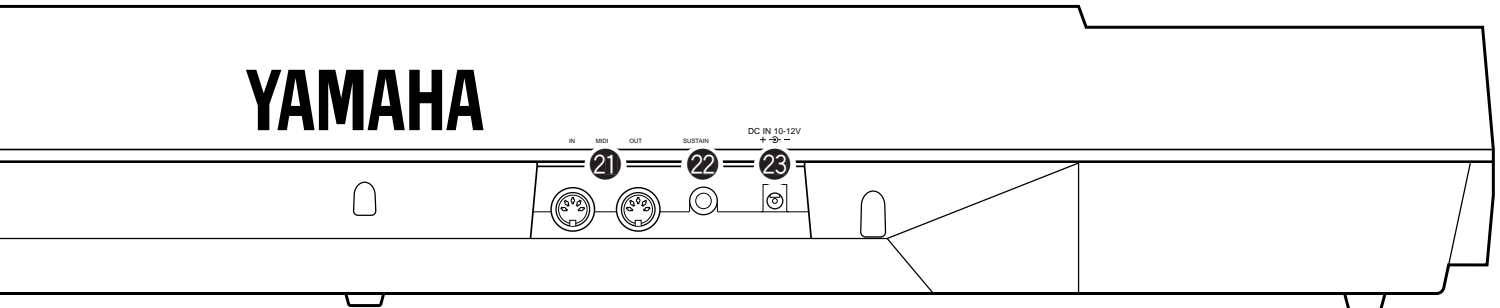
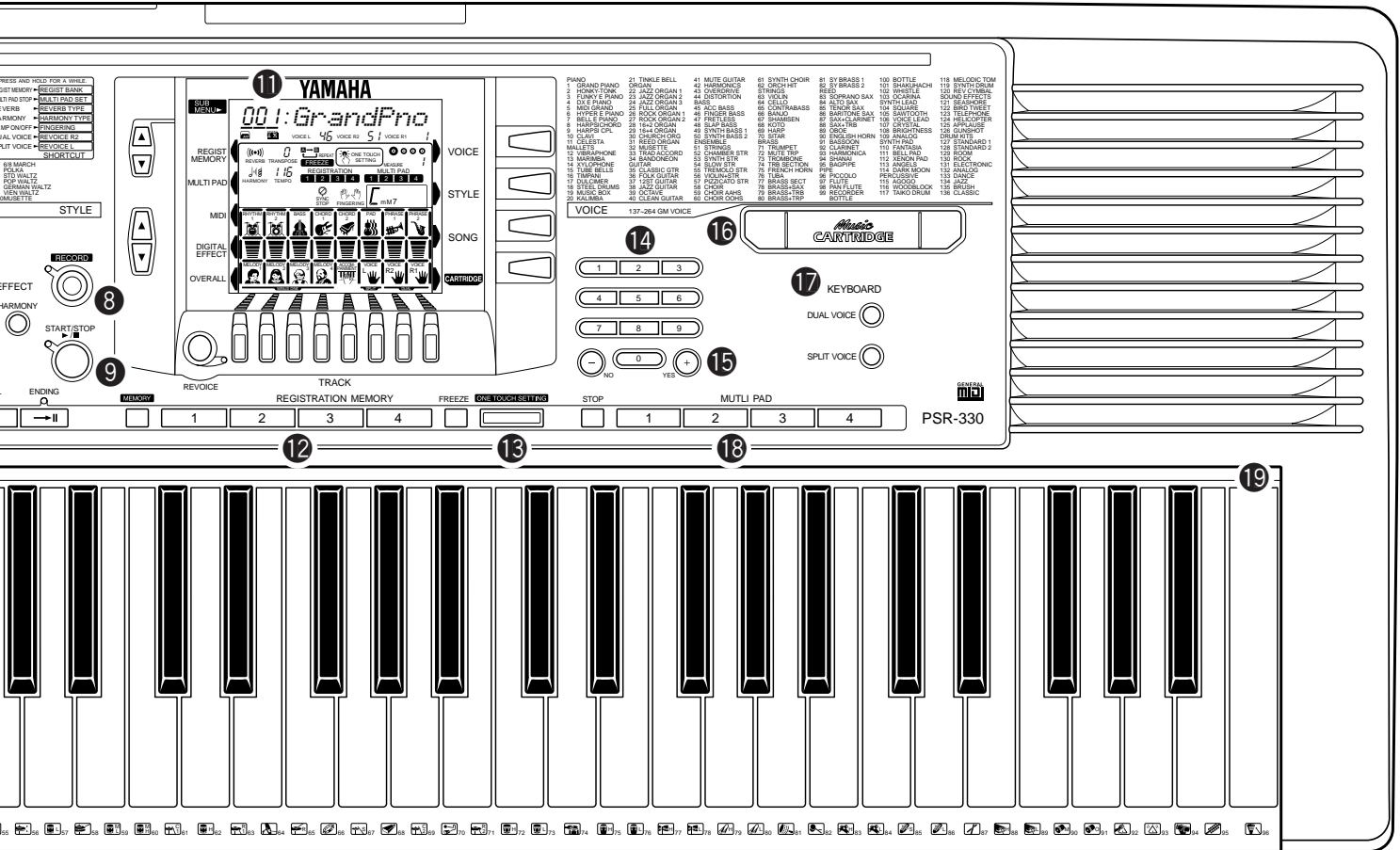

■ Rear Panel Controls

- 21 MIDI IN and OUT Connectors pages 11, 66
- 22 SUSTAIN Jack page 11
- 23 DC IN 10-12V Jack page 11

◆ Included Accessories

- Music Stand
- Music Cartridge

◆ The Music Stand

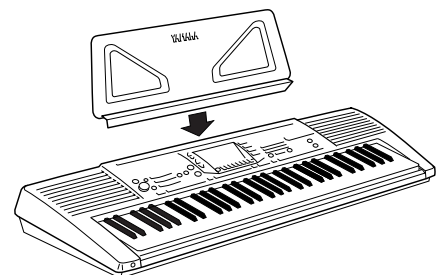

The PSR-330 is supplied with a music stand that can be attached to the instrument by inserting it into the slot at the rear of the control panel.

Basic Display Operation

The PSR-330 LCD panel is a large multi-function type that simultaneously displays and provides access to a number of important parameters. Basic operation of the display as well as the MENU and SUB MENU buttons, and the meaning of the icons which appear in the display, are summarized briefly below.

The Display Icons



CART (Cartridge)

Appears when a Music Cartridge song or style is selected (page 56).



GM (General MIDI)

Appears when one of the PSR-330's GM voices is selected (pages 14, 83).

VOICE L 46 VOICE R2 51 VOICE R1 1

VOICE L, VOICE R2, and VOICE R1

The currently selected L (Left-hand), R2 (Right-hand 2) and R1 (Right-hand 1) voice numbers are displayed in these display locations (page 14).



REVERB

Appears when the PSR-330 REVERB effect is turned on (page 34).



HARMONY

Appears when the HARMONY effect is turned on (page 36).



TRANSPOSE

The current transpose value (page 38).



TEMPO

Shows the current tempo of accompaniment/song playback (page 21).

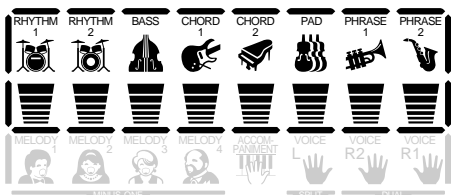
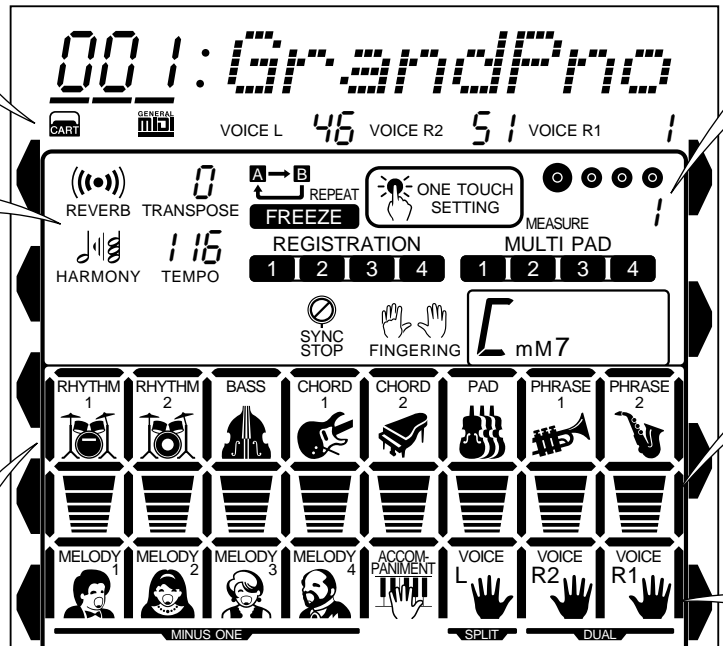

ACCOMPANIMENT TRACKS

The top row of 8 icons light to indicate which of the 8 possible accompaniment tracks are being used for accompaniment playback. They are also used to specify tracks when using the REVOICE function (pages 25, 60).



REPEAT

Indicates the “A” and “B” repeat points when programming a repeat section, and whether REPEAT PLAY is on or off (page 49).



ONE TOUCH SETTING

Appears when the ONE TOUCH SETTING feature is engaged (page 32).



REGISTRATION 1 ... 4 (Registration Memory)

Indicates the currently selected REGISTRATION MEMORY number (page 39).



FREEZE

Appears when the REGISTRATION MEMORY “FREEZE” function is on (page 40).



MULTI PAD 1 ... 4

Indicates the currently playing MULTI PAD number (page 43).



BEAT

Flashes at the current tempo and indicates the current beat during accompaniment and song playback. (page 23)



MEASURE

Indicates the current measure number during song recording and playback (page 46).



SYNC STOP

Appears when the AUTO ACCOMPANIMENT SYNC STOP function is engaged (page 24).



FINGERING

Shows the currently selected fingering mode (page 28).



CHORD

Displays the current chord name during AUTO ACCOMPANIMENT playback or SONG recording/playback (page 23).



VOLUME

These icons show the volume (actually velocity) of each accompaniment track during accompaniment playback, the volume of the melody and accompaniment tracks during song playback, and the volume of the R1, R2 and L voices (pages 26, 45, 59).

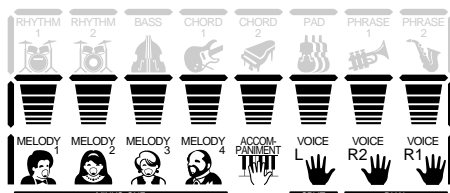

MELODY TRACKS 1 ... 4, ACCOMPANIMENT TRACK

These icons indicate the playback on/off status of each song track, and are used to specify tracks for song recording (page 52). They are also used to specify tracks when using the REVOICE function (page 61).

VOICE L, VOICE R2, VOICE R1

These icons indicate the on/off status of the L, R2, and R1 voices when the DUAL VOICE and/or SPLIT VOICE functions are used (page 14). They are also used to specify tracks when using the REVOICE function (page 58).

The Menu

The buttons to the right of the display directly select one of the PSR-330's four main function menus: VOICE, STYLE, SONG, and CARTRIDGE. The currently selected menu is indicated by a triangular indicator in the display next to the menu list printed immediately to the right of the display panel. In addition to the menus and functions which are available directly via the PSR-330 panel controls, there is also a range of important "background" functions which can be selected via the MENU and SUB MENU [▲] and [▼] buttons.

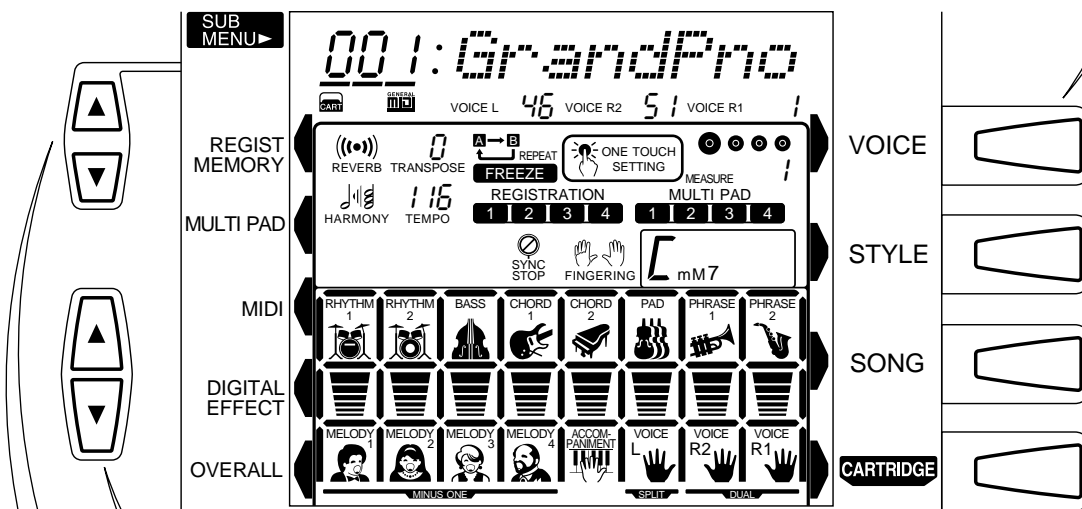

The MENU [▲] and [▼] buttons are used to select the menu: REGISTRATION MEMORY, MULTI PAD, MIDI, DIGITAL EFFECT, or OVERALL. The currently selected MENU category is indicated by a triangular indicator in the display next to the menu list printed immediately to the left of the display panel. All of the listed menu categories can be selected by pressing either the MENU [▲] or [▼] button as many times as necessary until the triangular indicator in the display appears next to the name of the desired category. Once a MENU has been selected, the SUB MENU [▲] and [▼] buttons can be used to select the desired function. The SUB MENU functions will be described in detail in the appropriate chapters throughout this manual.

Shortcuts

To make operation as easy and as efficient as possible, the PSR-330 features a number of “shortcuts” which allow you to jump directly to certain functions without having to use the MENU and SUB MENU buttons. All of these shortcuts work in the same way: press and hold a panel button for a few seconds to go to the related function. For example, if you press and hold the [REVERB] button for a few seconds, you will go directly to the REVERB type selection function. The shortcut buttons and the functions they access are listed on the PSR-330 panel, near the upper left corner of the display. The shortcuts will also be described where appropriate throughout this manual.



:Reverb

Setting Up

This section contains information about setting up your PSR-330 and preparing to play. Be sure to go through this section carefully before using your PSR-330.

Power Supply

Although the PSR-330 will run either from an optional AC adaptor or batteries, Yamaha recommends use of the more environmentally safe AC adaptor. Follow the instructions below according to the power source you intend to use.

CAUTION

- *Never interrupt the power supply (e.g. remove the batteries or unplug the AC adaptor) during any PSR-330 record operation! Doing so can result in a loss of data.*

Using An Optional AC Power Adaptor

- 1 Plug an optional Yamaha PA-5, PA-5B, or PA-5C Power Adaptor into a wall AC outlet.
- 2 Then plug the DC output cable from the PA-5, PA-5B, or PA-5C into the **DC IN 10-12V** jack on the rear panel of the PSR-330. The internal batteries are automatically disconnected when an AC Power Adaptor is used.

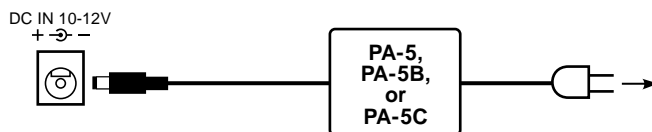

When turning the power OFF, simply reverse the procedure.

WARNING

- *Use ONLY a Yamaha PA-5, PA-5B, or PA-5C AC Power Adaptor (or other adaptor specifically recommended by Yamaha) to power your instrument from the AC mains. The use of other adaptors may result in irreparable damage to both the adaptor and the PSR-330.*
- *Unplug the AC Power Adaptor when not using the PSR-330, or during electrical storms.*

Using Batteries

For battery operation the PSR-330 requires six 1.5V SUM-1, “D” size, R-20 or equivalent batteries.

When the batteries need to be replaced the volume may be reduced, the sound may be distorted, and other problems may occur. When this happens, turn the power off and replace the batteries.

Replace the batteries as follows:

- 1 Open the battery compartment cover located on the instrument’s bottom panel.
- 2 Insert the six new batteries, being careful to follow the polarity markings on the inside of the compartment.
- 3 Replace the compartment cover, making sure that it locks firmly in place.

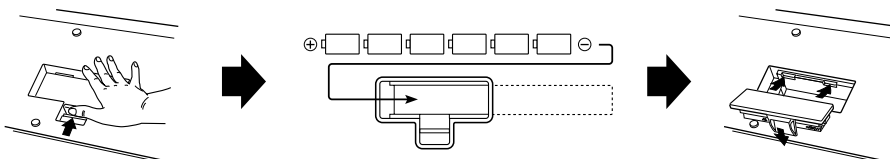

CAUTION

- *When the batteries run down, replace them with a complete set of six new batteries. NEVER mix old and new batteries.*
- *Do not use different kinds of batteries (e.g. alkaline and manganese) at the same time.*
- *If the instrument is not to be in use for a long time, remove the batteries from it, in order to prevent possible fluid leakage from the battery.*

Connections

The PHONES Jack

A standard pair of stereo headphones can be plugged in here for private practice or late-night playing. The internal stereo speaker system is automatically shut off when a pair of headphones is plugged into the **PHONES** jack.

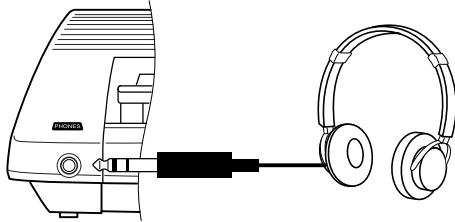

SUSTAIN Jack

An optional Yamaha FC4 or FC5 footswitch can be plugged into the rear-panel **SUSTAIN** jack for sustain control. The footswitch functions like the damper pedal on a piano — press for sustain, release for normal sound.

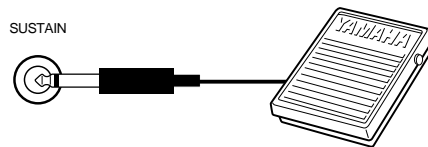

NOTE

- Be sure that you do not press the footswitch while turning the power on. If you do, the ON/OFF status of the footswitch will be reversed.

MIDI IN and OUT Connectors

The **MIDI IN** connector receives MIDI data from an external MIDI device (such as a MIDI sequencer) which can be used to control the PSR-330. The **MIDI OUT** connector transmits MIDI data generated by the PSR-330 (e.g. note and velocity data produced by playing the keyboard). More details on MIDI are provided on page 66.

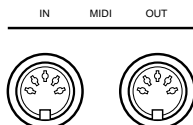

The Demonstration

Once you've set up your PSR-330, try listening to the pre-programmed demonstration songs. A total of 20 demo songs are provided.

1 Switch ON

Turn the power ON by pressing the **[POWER]** switch.



2 Set an Initial Volume Level

Turn the **[MASTER VOLUME]** control up (clockwise) about a quarter-turn from its minimum position. You can re-adjust the **[MASTER VOLUME]** control for the most comfortable overall volume level after playback begins.

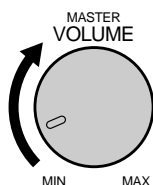

3 Press the **[DEMO]** Button

Press the **[DEMO]** button to start demo playback. The PSR-330 SONG menu will automatically be selected and the number and name of the first demo song will appear on the top line of the display. The demo will begin playing automatically. The demo songs will play in sequence, and the sequence will repeat until stopped.



01: DancePop

NOTE

- You can play along on the PSR-330 keyboard while the demonstration is playing.
- The volume icons will move in response to the data in each track while the demonstration plays.

4 Skip to the Beginning Of a Different Demo Song

While the demonstration is playing you can select any of the demo songs by using the [-] and [+] buttons. Playback will skip to the beginning of the selected song.

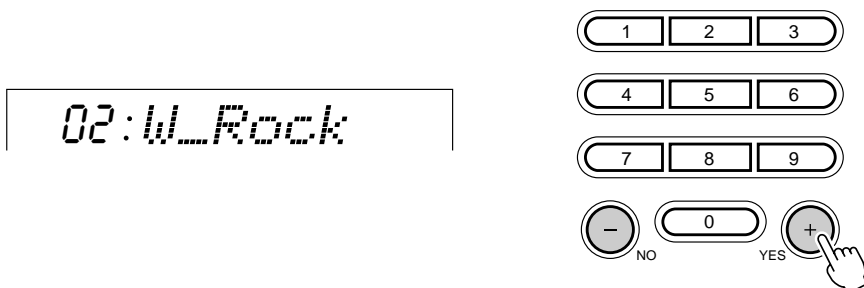

5 Stop When Done

Press the [DEMO] button or the [START/STOP] button to stop demo playback.

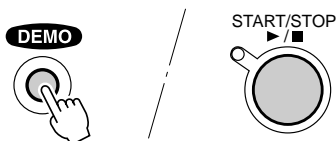

NOTE

- Demo playback can be restarted after it has been stopped by pressing the [START/STOP] button. In this case the selected demo song will play through to the end and then playback will stop automatically.
- When a demo which uses the PSR-330's internal accompaniment styles is playing, the names of the chords being played will appear on the display.
- Since playing the demo automatically selects the SONG menu, the SONG menu will remain active when demo playback is stopped. To select and play voices after stopping the demo, for example, you will have to press the [VOICE] button to go to the VOICE menu. The same applies for other menus.

Playing the PSR-330

The PSR-330 Voices

The PSR-330 actually includes two voice sets: the “panel” voices and drum kits (listed on the PSR-330 panel), and the GM (General MIDI) voices. The panel voices include 126 “pitched” voices (voice numbers 1 through 126) and 10 drum kits (numbers 127 through 136), while the GM voice set includes 128 pitched voices (voice numbers 137 through 264).

Panel voices	1 ... 126
Panel drum kits	127 ... 136
GM voices	137 ... 264

A Word About the “R1”, “R2”, and “L” Voices

The PSR-330 allows up to three voices to be selected at the same time: “R1” (Right-hand 1), “R2”, (Right-hand 2) and “L” (Left-hand). Only the “R1” voice is used when you’re playing a single voice over the entire range of the keyboard. When you’re using the DUAL VOICE and/or SPLIT VOICE modes (described on pages 17 and 18), however, the “R2” and/or “L” voice will be used as well. The numbers of the currently selected R1, R2, and L voices are all shown on the display panel.

VOICE L 46 VOICE R2 51 VOICE R1 1

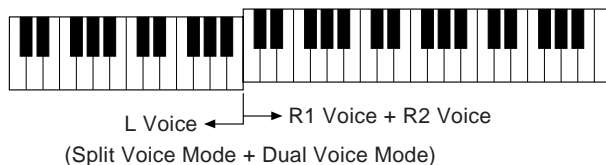
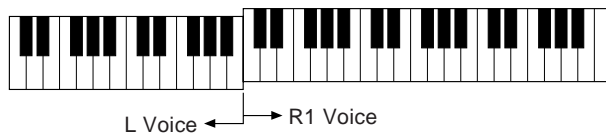

The R2 and L voices will be discussed in more detail in the DUAL VOICE and SPLIT VOICE sections. For now we’ll describe how to select and play the main R1 voice.

Selecting & Playing Voices

Here's how you can select and play the panel voices.

1 Select the VOICE Menu

Press the [VOICE] button so that the triangular indicator appears in the display next to "VOICE" to the right of the display. The number and name of the currently selected "R1" voice appears on the top line of the display panel when the VOICE menu is selected.



2 Select a Panel Voice

The PSR-330 voices can be selected by using the [-] and [+] buttons, the number buttons, or the [VOICE] button. The panel voices are listed in the VOICE list printed at the top of the instrument's control panel.

● The [-] and [+] Buttons

When the VOICE menu is selected these buttons step up or down through the PSR-330's voices. Press either button briefly to step to the next voice in the corresponding direction, or hold the button to scroll rapidly through the voices in the corresponding direction.

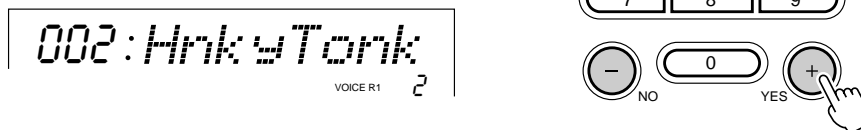

● The Number Buttons

The number buttons can be used to directly enter the number of the desired voice, thereby immediately selecting that voice without having to step through a number of other voices. To select voice number 109 (ANALOG LEAD), for example, press the [1], [0], and [9] number buttons in sequence.



Playing the PSR-330

One- or two-digit voice numbers can be entered without leading zeros. To select voice number “23” (JAZZ ORGAN 2), for example, simply press the [2] button and then the [3] button. The bars below the voice number on the display will flash for a few seconds, and then disappear when the selected voice number has been recognized by the PSR-330.

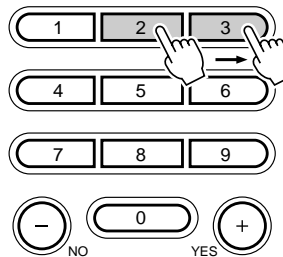
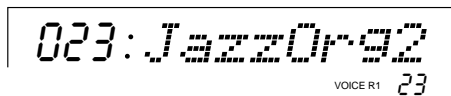

One- or two-digit voice numbers can also be entered with leading zeroes: e.g. “23” can be entered as “023” by pressing the [0], [2], and [3] buttons. In this case the specified voice number will be immediately recognized by the PSR-330.

● The [VOICE] Button

Pressing the [VOICE] button increments the voice number. Press briefly to increment by one, or hold for continuous incrementing.

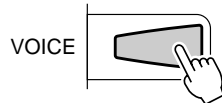

3 Play & Adjust Volume

You can now play the selected voice on the PSR-330 keyboard. Use the [MASTER VOLUME] control to adjust the overall volume level.

If the Voice Set function (page 65) is turned “on”, whenever a panel voice is selected appropriate “R2” and “L” voices (i.e. DUAL VOICE and SPLIT VOICE modes) as well as digital effects, etc., will be automatically selected at the same time.

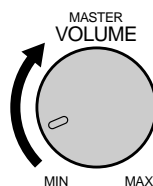

NOTE

- The PSR-330's GM voices are selected in the same way as the panel voices, as described above.
- When a GM voice is selected the GM icon will appear below the voice number.
- Refer to page 74 for a complete list of the panel and GM voices.

◆ Keyboard Percussion

When one of the 10 panel DRUM KIT voices are selected (voice numbers 127 through 136) you can play different drums and percussion instruments on the keyboard. The drums and percussion instruments played by the various keys are marked by symbols below the keys.



● The Drum Kits

127	Standard Kit1	132	Analog Kit
128	Standard Kit2	133	Dance Kit
129	Room Kit	134	Jazz Kit
130	Rock Kit	135	Brush Kit
131	Electronic Kit	136	Classic Kit

NOTE

- The HARMONY effect (page 35) cannot be turned on while a drum kit is selected for the "R1" voice, and will automatically be turned off if a drum kit is selected while HARMONY is on.
- The TRANSPOSE parameter (page 38) has no effect on the drum kit voices.
- When a drum kit is selected the OCTAVE parameter (page 58) is automatically set to "-1".
- See page 78 for a complete listing of the keyboard percussion drum instrument assignments.

The Dual Voice Mode

When the DUAL VOICE mode is engaged you can play two voices (the R1 and R2 voices) simultaneously across the entire keyboard.

The DUAL VOICE mode is turned on and off by pressing the [DUAL VOICE] button. When the DUAL VOICE mode is turned on both R1 and R2 icons in the display will light. Press the [DUAL VOICE] button a second time to turn the DUAL VOICE mode off: the R2 icon in the display will go out leaving only the R1 icon lit.

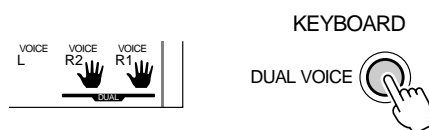

The R2 TRACK button below the display can also be used to turn the R2 voice on or off as required (when a frame appears around the voice icons).

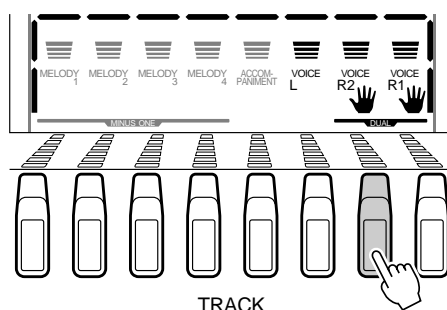

NOTE

- The R1/R2 voice settings can be changed as required by using the REVOICE function, described on page 58.
- The R1 voice cannot be turned off.
- The DUAL VOICE mode can be used at the same time as the SPLIT VOICE mode, described below. In this case the L voice is played on the left-hand section of the keyboard while both the R1 and R2 voices are played on the right-hand section of the keyboard. See the "The Split Voice Mode" section, below, for more information.

The Split Voice Mode

The SPLIT VOICE mode lets you play different voices with the left and right hands. You could, for example, play bass with the left hand (the L voice) while playing piano with the right (the R1 or R1 and R2 voices). The “split point” is initially set at B2 (note number 59), but it can be set at any key on the keyboard.

The SPLIT VOICE mode is engaged by pressing the [SPLIT VOICE] button. When turned on, the L icon in the display will light in addition to the R1 or R1 and R2 icons. Press the [SPLIT VOICE] button a second time to disengage the SPLIT VOICE mode: the L icon will go out leaving only the R voice.

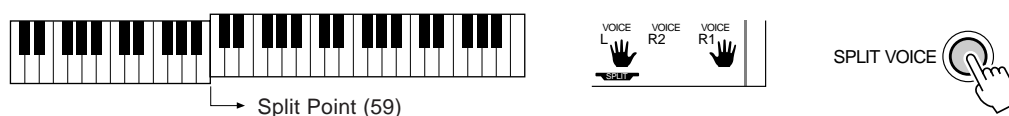

The L TRACK button below the display can also be used to turn the L voice on or off as required (when a frame appears around the voice icons).

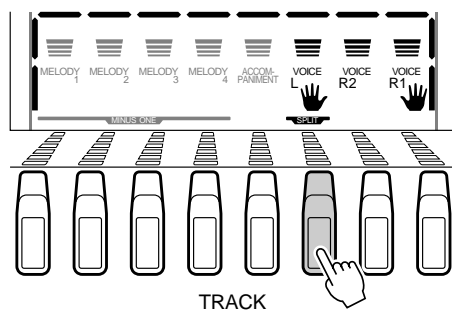

NOTE

- The L/R1/R2 voice settings can be changed as required by using the RE-VOICE function, described on page 58.
- The split point can be changed as required as described below.
- The SPLIT VOICE mode can be used at the same time as the DUAL VOICE mode, described above. In this case the L voice is played on the left-hand section of the keyboard while both the R1 and R2 voices are played on the right-hand section of the keyboard. See the “The Dual Voice Mode” section, above, for more information.

Changing the SPLIT VOICE Split Point

The SPLIT VOICE split point can be set to any key on the PSR-330 keyboard to match your individual playing requirements.

1 Select the SPLIT VOICE Split Point Function

Use the MENU [▲] and [▼] buttons to the left of the display to move the triangular indicator next to “OVERALL” on the left side of the display.

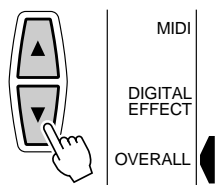

Then use the SUB MENU [▲] and [▼] buttons to select the “S.Split” function from within the OVERALL menu . The MIDI note number corresponding to the current split point will appear to the left of “S.Split” on the top line of the display.

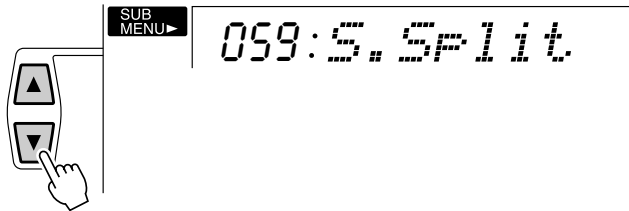

2 Set As Required

Simply press the key you want to assign as the split point. The key number of the key you press will appear to the left of “S.Split” on the top line of the display. You can also use the [-] and [+] buttons or number buttons to enter the split point key number. The lowest key on the keyboard (C1) is key number “36”, middle C (C3) is “60”, and the highest key (C5) is 96. The split point can be set at any key number from 0 through 127, allowing the split point to be set outside the range of the PSR-330 keyboard for MIDI applications.

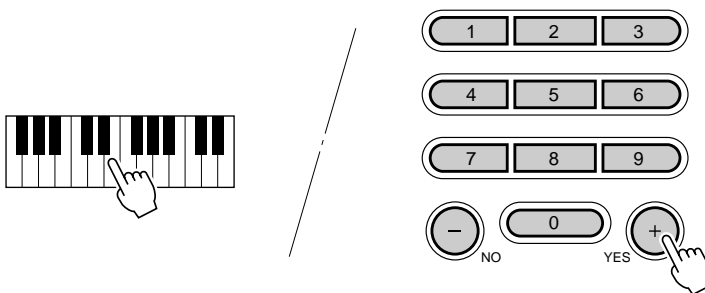

NOTE

- The split point key becomes the highest key in the left-hand section of the keyboard.
- The default split point (59) can be instantly recalled by pressing the [-] and [+] buttons at the same time.
- The SPLIT VOICE split point and AUTO ACCOMPANIMENT split point (page 27) can be independently specified, with the following limitations. The SPLIT VOICE split point cannot be set at a lower key than the AUTO ACCOMPANIMENT split point (if you attempt to do this the AUTO ACCOMPANIMENT split point will be set to the same key as the SPLIT VOICE split point). Conversely, the AUTO ACCOMPANIMENT split point cannot be set at a higher key than the SPLIT VOICE split point (if you attempt to do this the SPLIT VOICE split point will be set to the same key as the AUTO ACCOMPANIMENT split point).
- The split point cannot be set via the keyboard while Auto Accompaniment is playing.

Auto Accompaniment

The PSR-330 has 100 different accompaniment “styles” that can be used to provide fully-orchestrated or rhythm-only accompaniment. The PSR-330’s sophisticated AUTO ACCOMPANIMENT system can provide automated bass and chord backing that is perfectly matched to the selected accompaniment style.

When Auto-Accompaniment is turned on, the specified left-hand section of the keyboard becomes the “auto accompaniment” section, and chords played in this section are automatically detected and used as a basis for fully automatic accompaniment with the selected style.

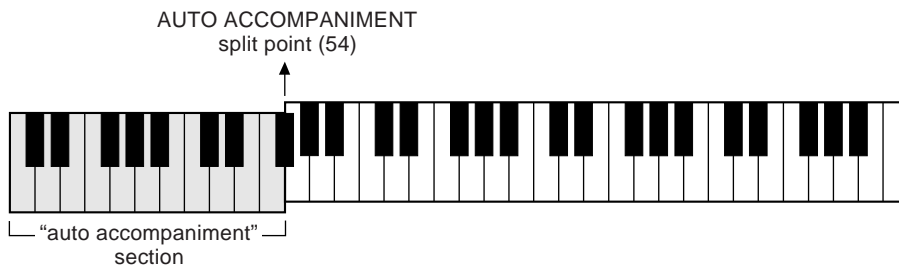

Using Auto Accompaniment

1 Select the Style Menu

Press the [STYLE] button to select the STYLE menu (the triangular indicator will appear next to “STYLE” to the right of the display). The number and name of the currently selected style will appear on the top line of the display, and the accompaniment track and volume icons in the display will appear framed.

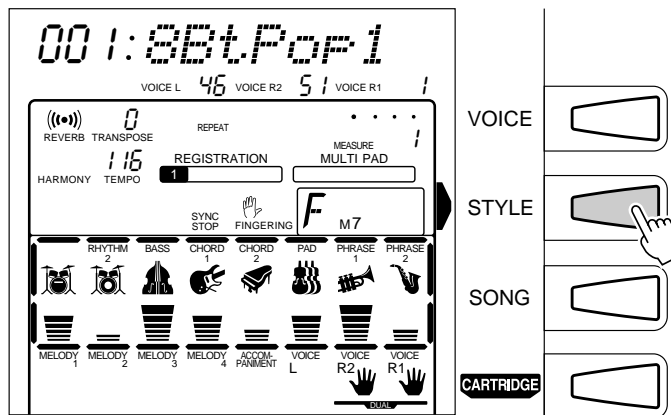

2 Select a Style

The PSR-330 has 100 styles that can be selected by using the [-] and [+] buttons, the number buttons, or the [STYLE] button (these controls function in the same way as for voice selection — see page 15). The styles are listed in the STYLE list printed at the top of the instrument's control panel.

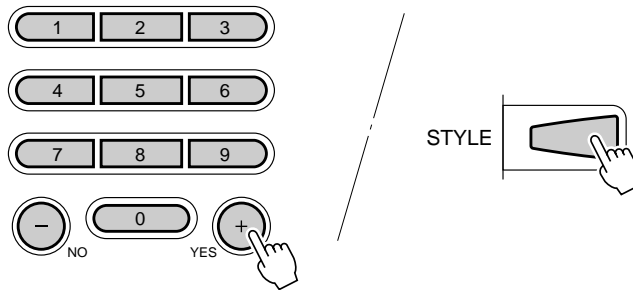

NOTE

- See page 57 for details on selecting cartridge styles.

3 Turn AUTO ACCOMPANIMENT On

Press the AUTO ACCOMPANIMENT [ON/OFF] so that its indicator lights.

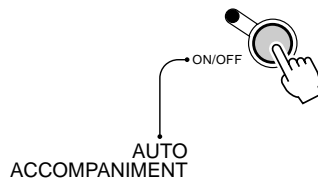

NOTE

- If **AUTO ACCOMPANIMENT** is off, only rhythm (drums and percussion) accompaniment will be produced.

4 Set the Tempo

When you select a different style while the accompaniment is not playing, the “default” tempo for that style is also selected, and the tempo is displayed immediately above “TEMPO” in the display in quarter-note beats per minute. If the accompaniment is playing and the One Touch Setting function is off (page 32), the same tempo is maintained even if you select a different style.

You can change the tempo to any value between 32 and 280 beats per minute, however, by using the TEMPO [▼] and [▲] buttons. Press either button briefly to decrement or increment the tempo value by one, or hold the button for continuous decrementing or incrementing.



When either of the TEMPO buttons is pressed the current tempo value will appear on the top line of the display for a few seconds — during this time the number or [-] and [+] buttons can also be used to set the tempo. The default tempo for the selected style can be recalled at any time by pressing both the TEMPO [▼] and [▲] buttons simultaneously (or by pressing the [-] and [+] buttons simultaneously while the tempo value is showing on the top line of the display).

5 Start the Accompaniment

There are several ways to start the accompaniment:

● Straight start

Press the [START/STOP] button. The rhythm will begin playing immediately without bass and chord accompaniment. The currently selected MAIN [A] or [B] section will play.

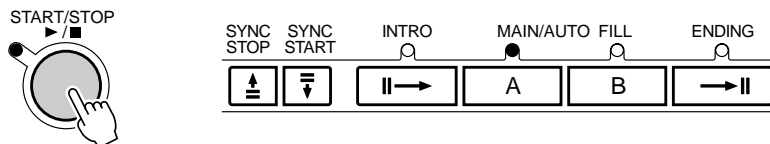

NOTE

- It is possible to select the MAIN A or B section prior to a straight start — refer to “7. Select the MAIN A and B Sections as Required,” below.

● Start with an introduction followed by the MAIN A variation

Press the [INTRO] button so that its indicator lights, press the MAIN/AUTO FILL [A] button (not necessary if its indicator is already flashing), then press [START/STOP].

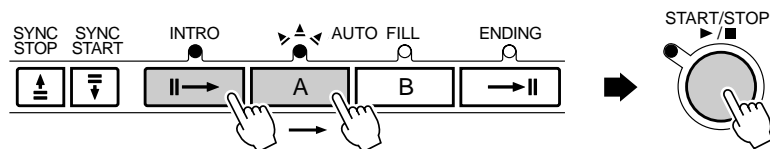

● Start with an introduction followed by the MAIN B variation

Press the [INTRO] button so that its indicator lights, press the MAIN/AUTO FILL [B] button (not necessary if its indicator is already flashing), then press [START/STOP].

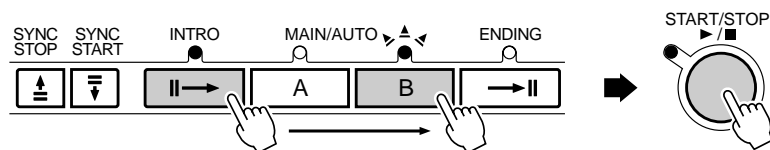

● Synchronized start

Any of the above start types can be synchronized to the first note or chord played on the left-hand section of the keyboard (i.e. keys to the left of and including the split-point key — normally 54) by first pressing the [SYNC START] button.

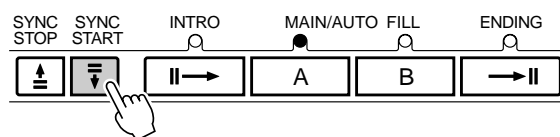

NOTE

- If you press the [SYNC START] button while the accompaniment is playing, the accompaniment will stop and the synchro start mode will be engaged.
- The [INTRO] button can be used to select the INTRO section even while the accompaniment is playing.
- The accompaniment split point can be changed via the “Accompaniment Split Point” function in the OVERALL menu — see page 27.

Pressing the [SYNC START] button alone causes a straight start to occur when the first note or chord is played. Press the [SYNC START] button and then the appropriate [INTRO] and [MAIN/AUTO FILL] buttons for a synchronized introduction start. The BEAT indicator will flash at the current tempo when a synchronized start mode has been selected. The synchro start mode can be disengaged prior to actually starting the accompaniment by pressing the [SYNC START] button a second time.

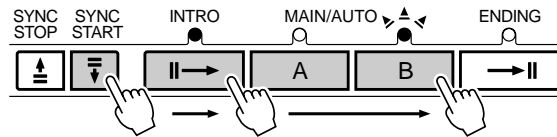

NOTE

- When the AUTO ACCOMPANIMENT split point and SPLIT VOICE split point are set at different keys, the L voice can be played between the AUTO ACCOMPANIMENT split point and SPLIT VOICE split point when the AUTO ACCOMPANIMENT function is on.
- When the AUTO ACCOMPANIMENT split point and SPLIT VOICE split point are set to the same key, the L voice can be played anywhere to the left of the AUTO ACCOMPANIMENT split point and SPLIT VOICE split point while AUTO ACCOMPANIMENT is not playing.

6 Play On the Auto-accompaniment Section Of the Keyboard

As soon as you play any chord that the PSR-330 can “recognize” on the left-hand section of the keyboard, the PSR-330 will automatically begin to play the chord along with the selected rhythm and an appropriate bass line. The name of the current chord will appear on the display. The accompaniment will continue playing even if you release the keys (unless the Synchro Stop function is engaged — page 24).

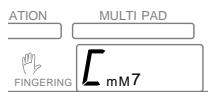
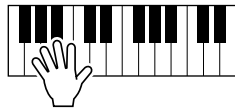

NOTE

- The PSR-330 has several fingering modes which allow you to play chords in different ways. See “The Auto Accompaniment Fingering Modes” on page 28 for details.

● The Beat Indicator

The four dots of the BEAT indicator provide a visual indication of the selected tempo as shown below.

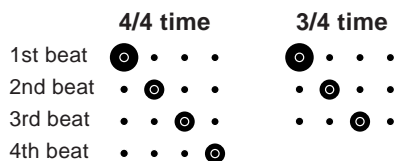

7 Select the MAIN A and B Sections as Required

The MAIN A and MAIN B sections can be selected at any time during playback by pressing the corresponding button. Whenever you press the MAIN/AUTO FILL [A] or [B] button during playback, the PSR-330 will generate an appropriate “fill-in” (one of four types: AA, AB, BA, and BB) which will smoothly connect the current section to the selected section — even if it is the same section. For

Auto Accompaniment

example, if you press the MAIN/AUTO FILL [A] button while the MAIN A section is playing, a fill-in will be produced, then the MAIN A section will continue playing. When you select a different section, the fill-in will begin immediately and the new section will actually begin playing from the top of the next measure unless the MAIN/AUTO FILL [A] or [B] button is pressed during the last beat of the measure, in which case the fill-in will begin from the first beat of the next measure.

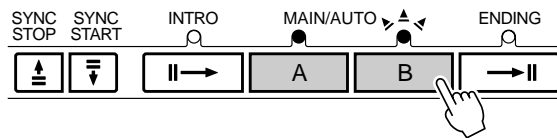

NOTE

- The MAIN A section is automatically selected whenever the PSR-330 power is initially turned on.
- The indicator of the destination section (MAIN A or B) will flash while the corresponding fill-in is playing. During this time you can change the destination section by pressing the appropriate MAIN/AUTO FILL [A] or [B] button.

8 Stop the Accompaniment

The accompaniment can be stopped at any time by pressing the [START/STOP] button. Press the [ENDING] button if you want to go to the ending section and then stop. The ending section will begin from the top of the next measure.

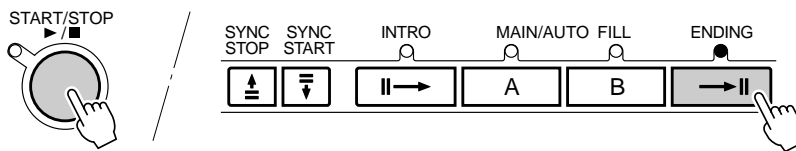

NOTE

- Some INTRO and ENDING sections have their own chord progressions which play in the current accompaniment key.
- If the MAIN/AUTO FILL [A] or [B] button is pressed while the ENDING section is playing, an appropriate fill-in will be played, followed by a return to the MAIN A or B section.
- The accompaniment volume can be adjusted independently of the keyboard volume via the ACCOMPANIMENT/SONG VOLUME [▼] and [▲] buttons (page 26).

◆ The Synchro Stop Function

When the Synchro Stop function is engaged, accompaniment playback will stop completely when all keys in the auto-accompaniment section of the keyboard are released. Accompaniment playback will start again as soon as a chord is played. The BEAT indicators in the display will flash while the accompaniment is stopped.

The Synchro Stop function is engaged by pressing the [SYNC STOP] button so that the SYNC STOP icon in the display appears. Press the [SYNC STOP] button again so that the icon disappears to turn the Synchro Stop function off.



NOTE

- The Synchro Stop function can not be turned on when the FULL KEYBOARD AUTO ACCOMPANIMENT fingering mode is selected. The Synchro Stop function will be automatically turned off if the FULL KEYBOARD fingering mode is selected while the Synchro Stop function is on.

Accompaniment Track Muting

The PSR-330 has eight accompaniment tracks — RHYTHM 1, RHYTHM 2, BASS, CHORD 1, CHORD 2, PAD, PHRASE 1, and PHRASE 2 — that you can control to modify the “orchestration” and therefore the overall sound of the accompaniment. When a style is selected the icons corresponding to the tracks which contain data for any section of that style will light.

NOTE

- Individual track voices, volume, and other parameters can be changed by using the REVOICE function — page 58.

● What's in the Tracks

RHYTHM 1 & 2	These are the main rhythm tracks. The RHYTHM tracks produce the drum and percussion sounds.
BASS	The BASS track always plays a bass line, but the voice will change to fit the selected style ... acoustic bass, synth bass, tuba, etc.
CHORD 1 & 2	These tracks provide the rhythmic chordal accompaniment required by each style. You'll find guitar, piano, and other chordal instruments here.
PAD	This track plays long chords where necessary, using sustained instruments such as strings, organ, choir.
PHRASE 1 & 2	This is where the musical embellishments reside. The PHRASE tracks are used for punchy brass stabs, arpeggiated chords, and other extras that make the accompaniment more interesting.

■ Muting Individual Tracks

Individual accompaniment tracks can be turned OFF (muted) or ON by using the **TRACK** buttons corresponding to the target tracks. The track icon will disappear when a track is muted.

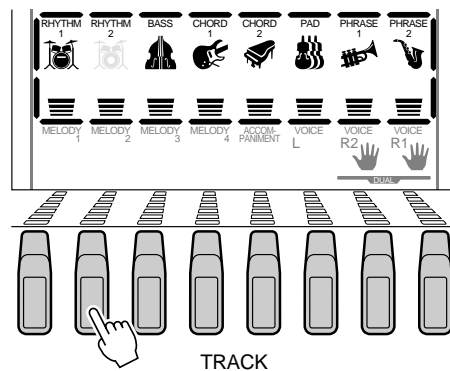

Accompaniment Volume Control

When the STYLE menu is selected (i.e. the accompaniment track and volume icons are framed) the volume of the accompaniment in relation to the keyboard can be adjusted for the best overall balance by using the ACCOMPANIMENT/SONG VOLUME [▼] and [▲] buttons. When either button is pressed the current accompaniment volume setting will appear on the top line of the display for a few seconds. The accompaniment volume range is from “0” (no sound) to “127” (maximum volume). The default setting is “100”. Press the ACCOMPANIMENT/SONG VOLUME [▼] button to decrease the volume or the [▲] button to increase the volume. Pressing briefly to single step, or hold for continuous decremmenting/incrementing.

ACCOMPANIMENT/SONG VOLUME

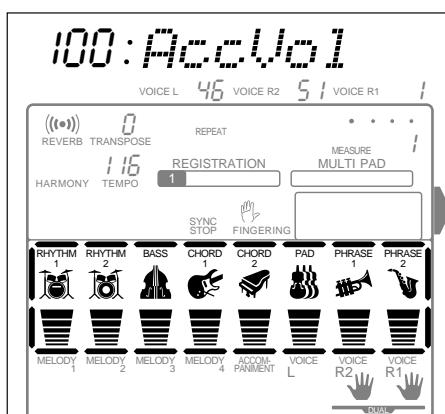

While the accompaniment volume setting appears on the top line of the display the number or [-] and [+] buttons can also be used to set the accompaniment volume.

Changing the Accompaniment Split Point

The AUTO ACCOMPANIMENT split point can be set to any key on the PSR-330 keyboard to match your individual playing requirements.

1 Select the Accompaniment Split Point Function

Use the MENU [▲] and [▼] buttons to the left of the display to move the triangular indicator next to “OVERALL” on the left side of the display.

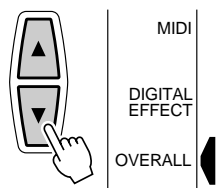

Then use the SUB MENU [▲] and [▼] buttons to select the “AccSpPnt” function from within the OVERALL menu. The MIDI note number corresponding to the current split point will appear to the left of “AccSpPnt” on the top line of the display.

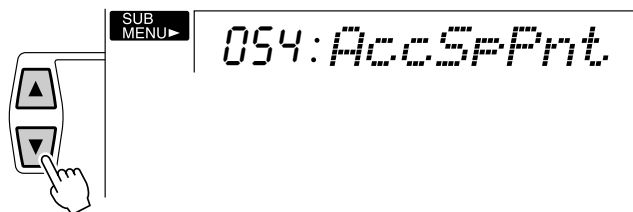

2 Set As Required

Simply press the key you want to assign as the split point. The key number of the key you press will appear to the left of “AccSpPnt” on the top line of the display. You can also use the [-] and [+] buttons or number buttons to enter the split point key number. The lowest key on the keyboard (C1) is key number “36”, middle C (C3) is “60”, and the highest key (C5) is 96. The split point can be set at any key number from 0 through 127, allowing the split point to be set outside the range of the PSR-330 keyboard for MIDI applications.

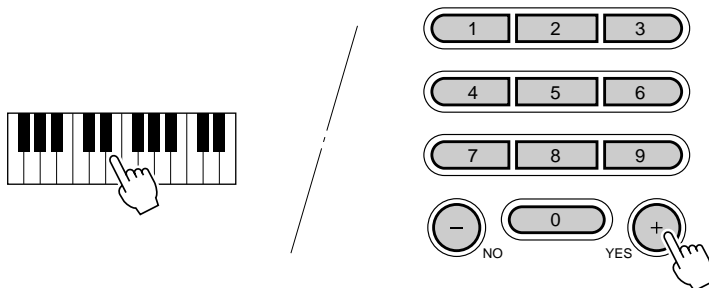

NOTE

- The split point key becomes the highest key in the Auto Accompaniment section of the keyboard.
- The default split point (54) can be instantly recalled by pressing the [-] and [+] buttons at the same time.
- The split point cannot be set via the keyboard while Auto Accompaniment is playing.

◆ Interaction Between the AUTO ACCOMPANIMENT and SPLIT VOICE Split Points

The SPLIT VOICE split point (page 18) and AUTO ACCOMPANIMENT split point can be independently specified, with the following limitations. The SPLIT VOICE split point cannot be set at a lower key than the AUTO ACCOMPANIMENT split point (if you attempt to do this the AUTO ACCOMPANIMENT split point will be set to the same key as the SPLIT VOICE split point). Conversely, the AUTO ACCOMPANIMENT split point cannot be set at a higher key than the SPLIT VOICE split point (if you attempt to do this the SPLIT VOICE split point will be set to the same key as the AUTO ACCOMPANIMENT split point).

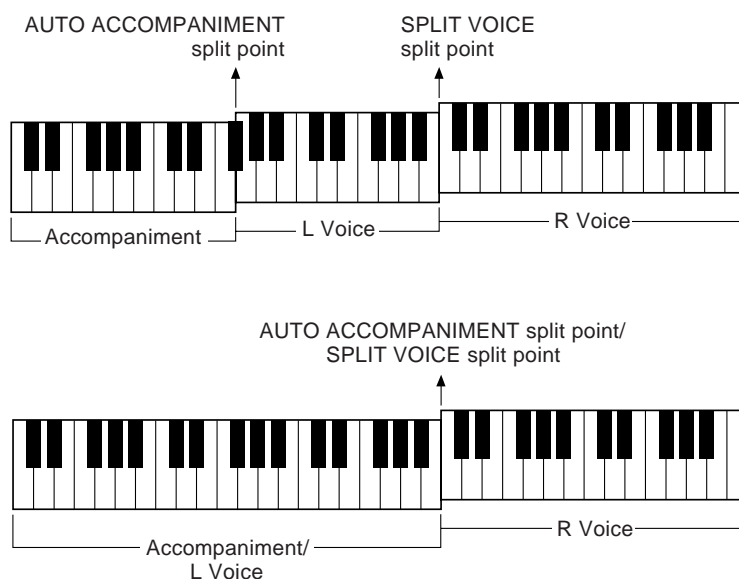

The Auto Accompaniment Fingering Modes

The PSR-330 AUTO ACCOMPANIMENT feature has five different fingering modes which can be selected as follows.

1 Select the Fingering Mode Function

Use the MENU [▲] and [▼] buttons to the left of the display to move the triangular indicator next to "OVERALL" on the left side of the display.

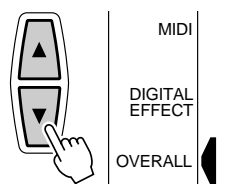

Shortcut

- You can jump directly to the "FngrngMd" function by pressing and holding the AUTO ACCOMPANIMENT [ON/OFF] button for a few seconds.

Then use the SUB MENU [▲] and [▼] buttons to select the “FngrngMd” function from within the OVERALL menu. The abbreviated name of the current fingering mode will appear to the left of “FngrngMd” on the top line of the display.

SF : FngrngMd

2 Select the Required Fingering Mode

Use the [-] and [+] buttons to select the desired fingering mode:

SF	Single Finger
F1	Fingered 1
F2	Fingered 2
FuL	Full Keyboard
MuL	Multi-finger

● SF: The SINGLE FINGER Mode



SF : FngrngMd

Single-finger accompaniment makes it simple to produce beautifully orchestrated accompaniment using major, seventh, minor and minor-seventh chords by pressing a minimum number of keys on the AUTO ACCOMPANIMENT section of the keyboard. The abbreviated chord fingerings described below are used:

C



- For a major chord, press the root key only.

Cm

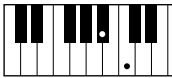

- For a minor chord, simultaneously press the root key and a black key to its left.

C7

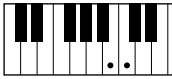

- For a seventh chord, simultaneously press the root key and a white key to its left.

Cm7

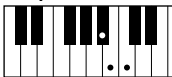

- For a minor-seventh chord, simultaneously press the root key and both a white and black key to its left.

● F1: The FINGERED 1 Mode



F 1: Fngred 1

The Fingered 1 mode lets you finger your own chords on the AUTO ACCOMPANIMENT section of the keyboard (i.e. all keys to the left of and including the split-point key — normally 54) while the PSR-330 supplies appropriately orchestrated rhythm, bass, and chord accompaniment in the selected style.

The FINGERED 1 mode recognizes the following chords:

Chord Name/[Abbreviation]	Normal Voicing	Chord (C)	Display
Major [M]	1 - 3 - 5	C	C
Add ninth [(9)]	1 - 2 - 3 - 5	C(9)	C(9)
Sixth [6]	1 - (3) - 5 - 6	C6	C6
Sixth add ninth [6(9)]	1 - 2 - 3 - (5) - 6	C6(9)	C6(9)
Major seventh [M7]	1 - 3 - (5) - 7 or 1 - (3) - 5 - 7	CM7	CM7
Major seventh ninth [M7(9)]	1 - 2 - 3 - (5) - 7	CM7(9)	CM7(9)
Major seventh sharp eleventh [M7#11]	1 - 2 - 3 - #4 - (5) - 7 or 1 - (2) - 3 - #4 - 5 - 7	CM7#11	CM7#11
Flatted fifth [(b5)]	1 - 3 - b5	C(b5)	C(b5)
Major seventh flatted fifth [M7b5]	1 - 3 - b5 - 7	CM7b5	CM7b5
Suspended fourth [sus4]	1 - 4 - 5	Csus4	Csus4
Augmented [aug]	1 - 3 - #5	Caug	Caug
Major seventh augmented [M7aug]	1 - (3) - #5 - 7	CM7aug	CM7aug
Minor [m]	1 - b3 - 5	Cm	Cm
Minor add ninth [m(9)]	1 - 2 - b3 - 5	Cm(9)	Cm(9)
Minor sixth [m6]	1 - b3 - 5 - 6	Cm6	Cm6
Minor seventh [m7]	1 - b3 - (5) - b7	Cm7	Cm7
Minor seventh add ninth [m7(9)]	1 - 2 - b3 - (5) - b7	Cm7(9)	Cm7(9)
Minor seventh eleventh [m7_11]	1 - (2) - b3 - 4 - 5 - (b7)	Cm7_11	Cm7_11
Minor major seventh [mM7]	1 - b3 - (5) - 7	CmM7	CmM7
Minor major seventh ninth [mM7(9)]	1 - 2 - b3 - (5) - 7	CmM7(9)	CmM7(9)
Minor seventh flatted fifth [m7b5]	1 - b3 - b5 - b7	Cm7b5	Cm7b5
Minor major seventh flatted fifth [mM7b5]	1 - b3 - b5 - 7	CmM7b5	CmM7b5
Diminished [dim]	1 - b3 - b5	Cdim	Cdim
Diminished seventh [dim7]	1 - b3 - b5 - 6	Cdim7	Cdim7
Seventh [7]	1 - 3 - (5) - b7 or 1 - (3) - 5 - b7	C7	C7
Seventh flatted ninth [7(b9)]	1 - b2 - 3 - (5) - b7	C7(b9)	C7(b9)
Seventh flatted thirteenth [7b13]	1 - 3 - 5 - b6 - b7	C7b13	C7b13
Seventh ninth [7(9)]	1 - 2 - 3 - (5) - b7	C7(9)	C7(9)
Seventh sharp eleventh [7#11]	1 - 2 - 3 - #4 - (5) - b7 or 1 - (2) - 3 - #4 - 5 - b7	C7#11	C7#11
Seventh add thirteenth [7(13)]	1 - 3 - (5) - 6 - b7	C7(13)	C7(13)
Seventh sharp ninth [7(#9)]	1 - #2 - 3 - (5) - b7	C7(#9)	C7(#9)
Seventh flatted fifth [7b5]	1 - 3 - b5 - b7	C7b5	C7b5
Seventh augmented [7aug]	1 - 3 - #5 - b7	C7aug	C7aug
Seventh suspended fourth [7sus4]	1 - 4 - (5) - b7	C7sus4	C7sus4
One plus two plus five [1+2+5]	1 - 2 - 5	C1+2+5	C

NOTE

- Notes in parentheses can be omitted.
- If you play any three adjacent keys (including black keys), the chord sound will be cancelled and only the rhythm instruments will continue playing (CHORD CANCEL function).
- An octave produces accompaniment based only on the root.
- A perfect fifth (1 + 5) produces accompaniment based only on the root and fifth which can be used with both major and minor chords.
- The chord fingerings listed are all in "root" position, but other inversions can be used — with the following exceptions:
 - m7, m7b5, 6, m6, sus4, aug, dim7, 7b5, 6(9), m7_11, 1+2+5.
- Inversion of the 7sus4, 7#11 chord are not recognized if the 5th is omitted.

Example for “C” chords

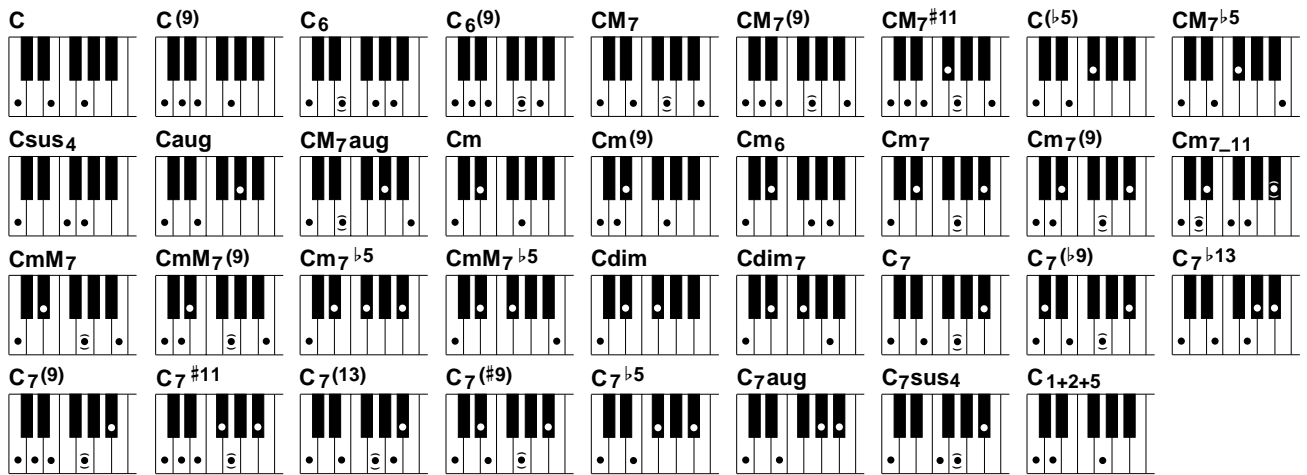

● F2: The FINGERED 2 Mode



F2: F n g r n g h d

This is essentially the same as the FINGERED 1 mode, described above, except that the FINGERED 2 mode additionally allows you to specify the lowest note of each chord — simply, the lowest note played in the AUTO ACCOMPANIMENT section of the keyboard is used as the accompaniment bass note. This means you can specify “on-bass” chords in which the main bass note for the chord is not the root of the chord. For a C major chord, for example, you could use E (the third) or G (the fifth) as the bass note rather than C.

C



C on E



C on G



● FuL: The FULL KEYBOARD Mode



FuL: F n g r n g h d

In this mode the PSR-330 automatically differentiates between left-hand chords and right-hand melody, no matter where they are played on the keyboard. Right-hand chords with a left-hand bass line — single or octave — are also recognized. In the first case left-hand chords are recognized and accompaniment is produced in the same way as in the FINGERED 1 mode, in the latter case the right-hand chords are recognized in the same way but the accompaniment bass line will be based on the left-hand bass line you play. This means you can play in just about any style anywhere on the keyboard, and the PSR-330 will automatically produce appropriate accompaniment.

NOTE

- A single note one octave lower than the lowest note of the chord is recognized as a bass note, and notes eleven notes or more higher are recognized as melody notes.

● MuL: The MULTI-FINGER Mode



MuL: Fngerngld

This is the default accompaniment mode. The MULTI-FINGER mode automatically detects SINGLE FINGER or FINGERED 1 chord fingerings, so you can use either type of fingering without having to switch fingering modes.

◆ The Stop Accompaniment Function

While the SINGLE FINGER, FINGERED 1, FINGERED 2, or MULTI-FINGER mode is selected chords played in the AUTO ACCOMPANIMENT section of the keyboard are also detected and played by the PSR-330 Auto Accompaniment system when the accompaniment is stopped (except when the FULL KEYBOARD mode is engaged). In this case the bass note and chord voices are selected automatically.

NOTE

- When the AUTO ACCOMPANIMENT split point and SPLIT VOICE split point are set to the same key, the L voice and the automatically selected bass note will sound.

One Touch Setting

The PSR-330's 100 internal styles each have four recommended "panel setups" that can be instantly selected via the [ONE TOUCH SETTING] and REGISTRATION MEMORY [1] ... [4] buttons. The One Touch Setting feature automatically sets the following parameters:

● One Touch Setting Parameter List

- R1 Voice
(Voice number, volume, octave, pan, reverb level)
- Dual Voice ON/OFF
- R2 Voice
(Voice number, volume, octave, pan, reverb level)
- Split Voice ON/OFF
- L Voice
(Voice number, volume, octave, pan, reverb level)
- Split Point : Split Voice=59
 : Auto Accompaniment=54
- Tempo=Default (for the currently selected style)
- Auto Accompaniment=ON
- Main A/B section
- Accompaniment Track data
(Style parameters=default, Track ON/OFF)
- Synchro start=ON
- Accompaniment volume=100
- Harmony ON/OFF, type, volume
- Reverb ON/OFF
- Reverb type
- Multi Pad Set number
- Chord Match ON/OFF=Default (Multi Pad1...4)

1 Select a Style

Select the STYLE menu and select an accompaniment style as described on page 20.

2 Press the [ONE TOUCH SETTING] Button

Press the [ONE TOUCH SETTING] button. The ONE TOUCH SETTING and REGIST [1] icons will appear in the display, and the ONE TOUCH SETTING type 1 panel settings will be recalled. At the same time, AUTO ACCOMPANIMENT will automatically be turned on if it was off, and the SYNC START mode will be engaged.



3 Select a ONE TOUCH SETTING Type, as Required

If you want to select a different REGISTRATION MEMORY, use the REGISTRATION MEMORY buttons to select the desired ONE TOUCH SETTING type. The corresponding number will appear in the display, and all settings will change according to the recalled data.

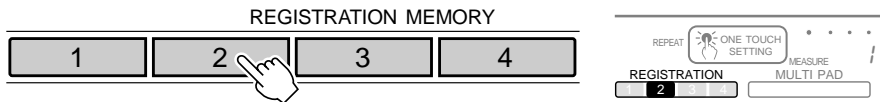

4 Turn ONE TOUCH SETTING Off When Done

Press the [ONE TOUCH SETTING] button so that the ONE TOUCH SETTING icon in the display disappears to turn the ONE TOUCH SETTING feature off.

NOTE

- "No OTS" will appear on the display if an optional cartridge style which has no ONE TOUCH SETTING data is selected.

Digital Effects

The PSR-330 has digital REVERB and HARMONY effects that can be used to add extra ambience and depth to your sound.

Reverb

The PSR-330 has 8 digital reverb effects that simulate the natural reverberation of a range of acoustic environments. There's also an "Off" setting:

1	Hall 1	4	Room 2	7	Delay 1
2	Hall 2	5	Plate 1	8	Delay 2
3	Room 1	6	Plate 2	9	Off

Turning the Reverb Effect On or Off

Press the [REVERB] button so that the REVERB icon appears in the display to turn the selected REVERB effect on. Press [REVERB] a second time so that the REVERB icon disappears to turn the REVERB effect off.



The [REVERB] buttons affect the reverb applied to all PSR-330 sound: i.e. the R1, R2, and L voices, accompaniment playback, song playback, and the MULTI PADS (see "The Multi Pads" on page 41). Overall reverb can be turned off by selecting the "Off" reverb type as described below.

NOTE

- When the Voice Set function is ON (page 65), the REVERB effect will be turned on or off according to the selected R1 panel voice.

Selecting a Reverb Type

1 Select the Digital Effect "Reverb" Function

Use the MENU [▲] and [▼] buttons to move the triangular indicator in the display next to "DIGITAL EFFECT".

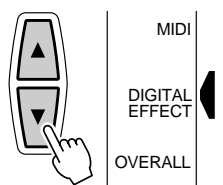

Shortcut

- You can also jump directly to the DIGITAL EFFECT REVERB TYPE function by pressing and holding the [REVERB] button for a few seconds.

Then use the SUB MENU [▲] and [▼] buttons to select “Reverb”. After a few seconds the name of the currently selected REVERB type will appear on top line of the display.

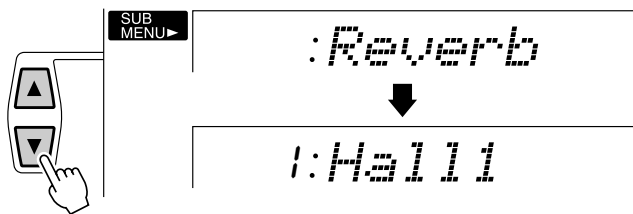

2 Select a Reverb Effect

Use the [-] and [+] buttons or number buttons to select the desired REVERB effect (the name of the selected REVERB effect will appear on the top line of the display). Select “OFF” if you want no REVERB effect on any part of the PSR-330 sound.

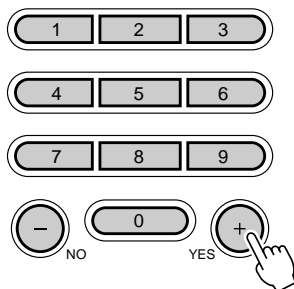

Harmony

When HARMONY is on and HARMONY type 1 through 4 is selected (see list below), playing single notes or chords on the right-hand section of the keyboard produces automatic harmony matched to the accompaniment chords (AUTO ACCOMPANIMENT must be on). HARMONY types 5 through 25 are delay-based effects which do not depend on the AUTO ACCOMPANIMENT chords. Harmony is applied to the R1 voice. When chords are played the harmony is based on the last note played (i.e. last-note priority).

The PSR-330 has 25 different harmony types, as listed below.

Type	Description	Type	Description
1 Duet	An extra note is added to the melody to produce duet type harmony.	3 Country	One note is added above the melody for a country-style harmony feel.
2 Trio	Two notes are added below the melody for three-part harmony.	4 Octave	One note is added an octave below the melody.

Type	Description	Type	Description
5 Trill 1/4	Two notes played on the keyboard are played alternately at the currently set tempo.	19 Echo 1/4	An echo effect is applied to the melody at the currently set tempo.
6 Trill 1/6		20 Echo 1/6	
7 Trill 1/8		21 Echo 1/8	
8 Trill 1/12		22 Echo 1/12	
9 Trill 1/16		23 Echo 1/16	
10 Trill 1/24		24 Echo 1/24	
11 Trill 1/32		25 Echo 1/32	
12 Tremolo 1/4	A tremolo effect is applied to the melody at the currently set tempo.		
13 Tremolo 1/6			
14 Tremolo 1/8			
15 Tremolo 1/12			
16 Tremolo 1/16			
17 Tremolo 1/24			
18 Tremolo 1/32			

Turning the Harmony Effect On or Off

Press the [HARMONY] button so that the HARMONY icon appears in the display to turn the selected HARMONY effect on. Press [HARMONY] a second time so that the HARMONY icon disappears to turn the HARMONY effect off.



NOTE

- HARMONY can not be turned on when a drum kit is selected for the R1 voice.
- HARMONY can not be turned on when the FULL KEYBOARD AUTO ACCOMPANIMENT fingering mode is selected even if AUTO ACCOMPANIMENT is on. HARMONY will be automatically turned off if the FULL KEYBOARD fingering mode is selected while the HARMONY effect is on.
- HARMONY is automatically turned off during song playback.
- When the Voice Set function is ON (page 65), the HARMONY effect settings may change according to the selected R1 panel voice.
- When a "Trill" harmony type (7 ... 12) is selected, two notes played on the keyboard will sound alternately at the specified note value.

Selecting a Harmony Type

1 Select the Digital Effect "Harmony" Function

Use the MENU [▲] and [▼] buttons to move the triangular indicator in the display next to "DIGITAL EFFECT".

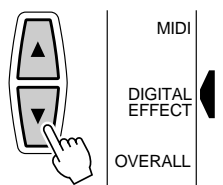

Then use the SUB MENU [▲] and [▼] buttons to select “Harmony”. After a few seconds the name of the currently selected HARMONY type will appear on top line of the display.

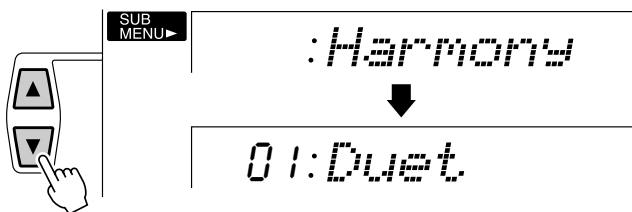

Shortcut

- You can also jump directly to the DIGITAL EFFECT HARMONY TYPE function by pressing and holding the [HARMONY] button for a few seconds.

2 Select a Harmony Type

Use the [-] and [+] buttons or number buttons to select the desired HARMONY type (the name of the selected HARMONY type will appear on the top line of the display).

Adjusting the Harmony Volume

The volume of the harmony sound in relation to the keyboard sound can be adjusted for HARMONY types 1 through 4 as follows (HARMONY types 5 through 25 are not affected):

1 Select the Digital Effect “HarmVol” Function

Use the MENU [▲] and [▼] buttons to move the triangular indicator in the display next to “DIGITAL EFFECT”, then use the SUB MENU [▲] and [▼] buttons to select “HarmVol”. The current harmony volume setting will appear to the left of “HarmVol” on the display.

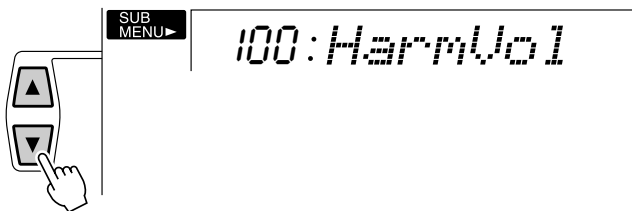

2 Adjust the Harmony Volume

Use the [-] and [+] buttons or number buttons to adjust the harmony volume as required. The range is from “0” to “127” — “0” is minimum (no sound) and “127” is maximum volume.

Transpose

This functions allow the overall pitch of the PSR-330 to be transposed up or down by a maximum of one octave in semitone increments.

Setting Transposition

Use the TRANSPOSE [▼] and [▲] buttons to set the desired degree of transposition. Press either button briefly to decrement or increment by one, or hold for continuous decrementing or incrementing. The current transpose value will appear on the top line of the display for a few seconds whenever one of the TRANSPOSE buttons is pressed — during this time the [-] and [+] buttons or number buttons can also be used to set the transpose value (the transpose value also appears continuously above “TRANSPOSE” in the display).

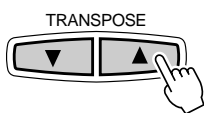

NOTE

- Press the TRANSPOSE [▼] and [▲] buttons simultaneously to instantly reset the transpose value to “0”.
- The new TRANSPOSE value will take effect from the next key played.
- The TRANSPOSE value cannot be changed during song playback or while the record mode is engaged.

The transpose range is from -12 to +12. Each step corresponds to one semitone, allowing a maximum upward or downward transposition of 1-octave. A setting of “0” produces the normal pitch.

Registration Memory

The PSR-330 Registration Memory feature can be used to memorize 32 complete control-panel setups (8 banks, 4 setups each) that you can recall whenever needed.

Registering the Panel Settings

1 Set Up the Controls as Required

Make the desired control settings. The following settings are memorized by the Registration Memory function:

● Data Stored By the Registration Memory

VOICE PARAMETERS

- R1 Voice (Voice number, volume, octave, pan, reverb send level)
- Dual Voice ON/OFF
- R2 Voice (Voice number, volume, octave, pan, reverb send level)
- Split Voice ON/OFF
- L Voice (Voice number, volume, octave, pan, reverb send level)
- Split Point (Split Voice)
- Touch Sensitivity
- Reverb ON/OFF
- Harmony ON/OFF, type, volume
- Scale Tuning

ACCOMPANIMENT PARAMETERS

- Auto Accompaniment ON/OFF
- Style number
- Fingering mode
- Tempo
- Split point (Auto Accompaniment)
- Accompaniment volume
- Track data (Track ON/OFF, voice, volume, pan, reverb send level)
- Accompaniment section (Main A/B)
- Multi Pad Set number
- Chord Match ON/OFF (Multi Pad1...4)
- Transpose*
- Reverb type

* The transpose value will not be affected if a different registration memory is selected during song playback or while the record mode is engaged.

2 Select a Registration Bank (if necessary)

Any of the eight Registration Memory banks can be selected via the REGISTRATION MEMORY menu. Use the MENU [▲] and [▼] buttons to move the triangular indicator next to “REGISTRATION MEMORY “ in the menu list to the left of the display — the currently selected registration bank number and name will appear on the top line of the display. Then use the [-] and [+] buttons or number buttons to select the desired bank (1 through 8).

Shortcut

- Press and hold the REGISTRATION MEMORY [MEMORY] button for a few seconds to go directly to the REGISTRATION BANK display.

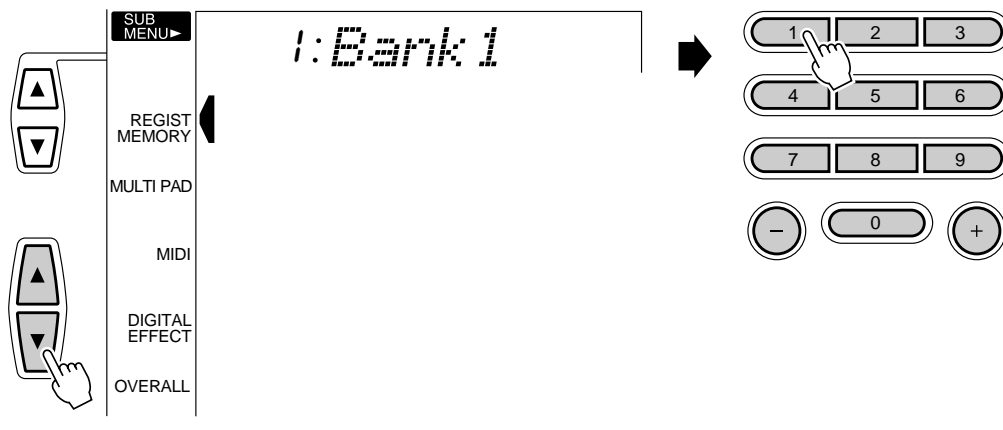

3 Register the Settings

While holding the [MEMORY] button, press one of the REGISTRATION MEMORY buttons — [1] through [4]. Any data that was previously in the selected location is erased and replaced by the new settings. The corresponding REGISTRATION MEMORY number will appear below “REGISTRATION” in the display.

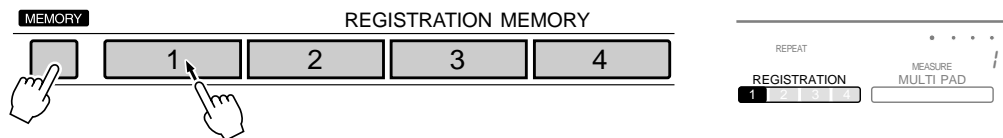

NOTE

- The REGISTRATION MEMORY contents will be retained even after turning the power off. See page 80 for the details.

Recall the Registered Panel Settings

Simply select the appropriate bank as described above, then press the desired REGISTRATION MEMORY button at any time to recall the memorized settings. The corresponding Registration Memory number will appear below “REGISTRATION” in the display, and the appropriate setting changes will appear in the display.

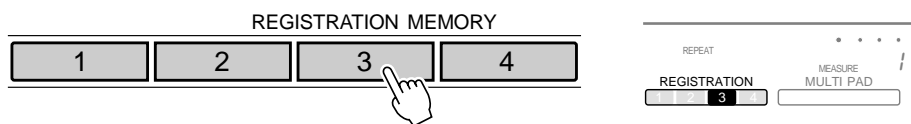

NOTE

- REGISTRATION MEMORY data cannot be recalled when the ONE TOUCH SETTING feature is on.
- No REGISTRATION MEMORY indicator will be showing when the PSR-330 is initially turned on or when a bank is selected prior to actually selecting a REGISTRATION MEMORY number.

The Accompaniment Freeze Function

When the FREEZE function is engaged, the accompaniment parameters listed above will not be changed when a REGISTRATION MEMORY is recalled. This allows you to recall different REGISTRATION MEMORY settings while using Auto Accompaniment, without suddenly disturbing the flow of the accompaniment. The FREEZE function is turned on and off by pressing the [FREEZE] button. The “FREEZE” icon appears in the display when it is turned on.



NOTE

- FREEZE remains on even if a different registration bank is selected.
- FREEZE will automatically be turned on when a demo, cartridge, or user song is played, and when a user song is recorded. FREEZE will then be automatically be turned off when playback or recording is finished.

The Multi Pads

The PSR-330 MULTI PADS can be used to play a number of short pre-recorded rhythmic and melodic sequences that can be used to add impact and variety to your keyboard performances. Percussion type pad phrases simply play back as programmed, while the “pitched” phrases are “chord match” types which, if the CHORD MATCH function is turned on, are automatically transposed to match chords played using the PSR-330 Auto Accompaniment feature.

Selecting a MULTI PAD Set

The PSR-330 has 26 multi pad sets, each containing a complete set of 4 MULTI PAD phrases — 104 phrases in all. Before using the MULTI PADS, select the MULTI PAD set containing the phrases you want to use as follows:

1 Select the Multi Pad Function

To select a multi pad set first use the MENU [▲] and [▼] buttons to select the MULTI PAD function so that the triangular indicator in the display appears next to “MULTI PAD” to the left of the display.

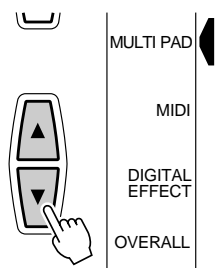

2 Select a Multi Pad Set Number

If necessary use the SUB MENU [▲] and [▼] buttons so that the name of the currently selected MULTI PAD set appears on the display (see list on page 43), then use the [-] and [+] or number buttons to select the MULTI PAD set you want to use.

01:Funky

Shortcut

- Press and hold the MULTI PAD [STOP] button for a few seconds to go directly to the MULTI PAD SET display.

Turning the CHORD MATCH Function On/Off

The CHORD MATCH function can be individually turned on or off for each of the MULTI PADS, as described below.

NOTE

- The chord match function has no effect with pads that contain percussion phrases.

1 Select the MULTI PAD Function

Use the MENU [▲] and [▼] buttons to select the MULTI PAD function so that the triangular indicator in the display appears next to “MULTI PAD” to the left of the display.

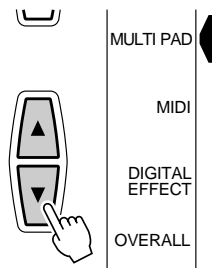

2 Select a CHORD MATCH Function

Use the SUB MENU [▲] and [▼] buttons to select “Pad1Chd”, “Pad2Chd”, “Pad3Chd”, or “Pad4Chd”, depending on the pad for which you want to turn the CHORD MATCH function on or off.

on: Pad1Chd

3 Turn the CHORD MATCH Function On or Off

Use the [-] and [+] buttons to turn the CHORD MATCH function for the selected pad “on” or “off” as required.

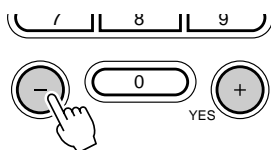

NOTE

- The CHORD MATCH ON/OFF setting is restored to its original status when a new MULTI PAD set is selected.

Playing the MULTI PADS

Simply tap any of the MULTI PADS at any time to play back the corresponding phrase at the currently set tempo. MULTI PAD playback begins as soon as the button is pressed. You can even play two, three, or four MULTI PADS at the same time (only one pad can be played during SONG playback). Also, you can create “retriggered sample” effects by repeatedly pressing a pad before its contents are completely played back.

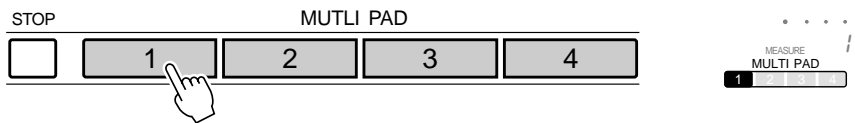

The MULTI PAD voices are independent from the voices you have currently selected for keyboard performance. You could, for example, play piano on the keyboard while a MULTI PAD plays a brass chord stab.

When the CHORD MATCH function for a pad is turned on, the corresponding phrase will be automatically transposed to match chords played using the PSR-330 Auto-accompaniment feature.

MULTI PAD playback can be terminated by pressing the MULTI PAD [STOP] button.

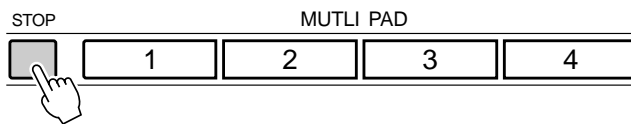

● The Multi Pad Sets

1 Funky	10 Synth Brass	19 Techno Kit
2 Techno 1	11 Fanfare 1	20 Techno Sequence
3 Techno 2	12 Fanfare 2	21 Analog Kit
4 Guitar Play	13 Jingle 1	22 Analog Sequence
5 Pianist	14 Jingle 2	23 Latin Percussion 1
6 Strings	15 Sound Effect	24 Latin Percussion 2
7 Arpeggio	16 Crystal	25 Bongo Sequence
8 Twinkle	17 Rock Kit	26 Timbales
9 Brass Hit	18 Tom Flam	

Song Playback

Use the following procedure to play back the PSR-330's internal demonstration songs as well as songs you record yourself (see "Song Recording", page 50).

Song Playback Procedure

1 Select the Song Menu

Press the [SONG] button to select the SONG menu (the triangular indicator will appear next to "SONG" to the right of the display). The number and name of the currently selected song will appear on the top line of the display, and the song track and volume icons near the bottom of the display will appear framed.

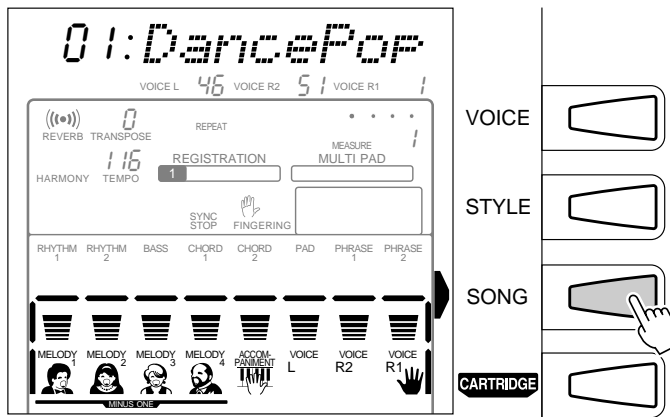

2 Select a SONG Number

If necessary, use the [-] and [+] or number buttons to select the SONG number you want to play. The SONG number can also be incremented by pressing the [SONG] button: press briefly to increment by one, or hold for continuous incrementing.



3 Start Playback

Playback will begin as soon as the [START/STOP] button is pressed. You can turn the MELODY and ACCOMPANIMENT tracks on and off during playback as required by using the TRACK buttons.



NOTE

- You can also start playback from any specified measure (see page 46).

4 Play Along If You Like

Play along on the keyboard if you like. You can also change the tempo during playback.

5 Stop Playback

SONG playback will stop automatically when the entire SONG has been played back. You can also stop playback at any time by pressing the [START/STOP] button.

Song Volume Control

When the SONG menu is selected (i.e. the song track and volume icons near the bottom of the display are framed) the volume of SONG playback in relation to the keyboard can be adjusted for the best overall balance by using the ACCOMPANIMENT/SONG VOLUME [▼] and [▲] buttons. When either button is pressed the current song volume setting will appear on the top line of the display for a few seconds. The song volume range is from “0” (no sound) to “127” (maximum volume). The default setting is “100”. Press the ACCOMPANIMENT/SONG VOLUME [▼] button to decrease the volume or the [▲] button to increase the volume. Pressing briefly to single step, or hold for continuous decrementing/incrementing.

While the song volume setting appears on the top line of the display the number or [-] and [+] buttons can also be used to set the accompaniment volume.

ACCOMPANIMENT/SONG VOLUME

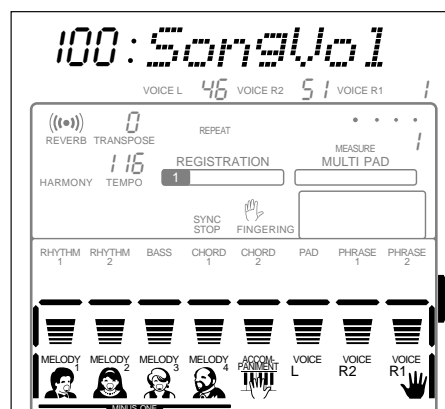

Play from a Specified Measure

You can start SONG playback from any specified measure, as long as the specified measure is within the range of measures that has already been recorded:

1 Select the Measure Parameter

While the SONG menu is selected, but no playback or recording is in progress, use the SUB MENU [▲] and [▼] buttons to select the “Measure” parameter in the display. The current measure number will appear to the left of “Measure” on the top line of the display (the current measure number is also continuously displayed next to “MEASURE” in the display).



2 Enter the Desired Measure Number

Use the [-] and [+] buttons or the number buttons to enter the desired measure number.

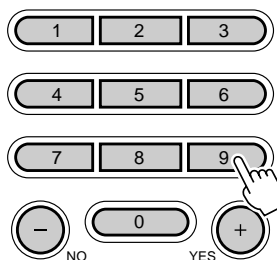

3 Start Playback

You can now start playback from the specified measure number by pressing the [START/STOP] button.



Minus-one Practice

Minus-one playback lets you turn off specific parts of a song so you can practice them on the PSR-330 keyboard while the other parts play automatically. Any of the PSR-330's four MELODY tracks and/or the ACCOMPANIMENT track can be turned on or off as required. Individual SONG tracks can be turned OFF (muted) or ON by using the **TRACK** buttons corresponding to the target MELODY or ACCOMPANIMENT tracks. The track icon will disappear when a track is muted.

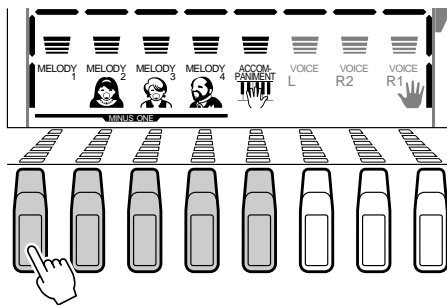

Minus-one Track Assignment

Many of the PSR-330 demonstration songs, and songs provided on Music Cartridges (see “Using Music Cartridges”, page 55) have more than 4 channels — as many as 16, in fact. This function lets you assign any of the song's channels to the PSR-330's MELODY tracks so they can be turned on or off for minus-one practice.

1 Select the MinusOne Parameter

While the SONG menu is selected, but no recording is in progress, use the SUB MENU [▲] and [▼] buttons to select the “MinusOne” parameter in the display. After a few seconds “MinusOne” will change to “MinusCh”, the number of the current minus-one channel will appear to the left of “MinusCh”, and a frame will appear around the MELODY 1 song track icon.

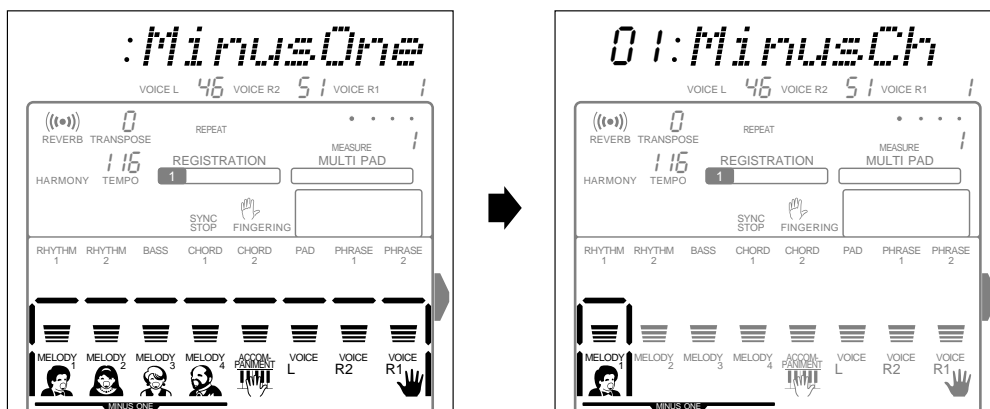

2 Select a MELODY Track

Use the **TRACK** buttons to select the song **MELODY** track (1...4) to which a minus-one channel is to be assigned. A frame will appear around the selected track icon.

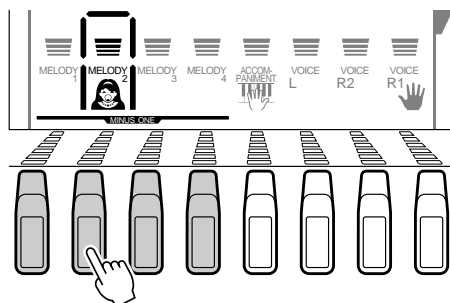

3 Assign a Channel to the Selected Track

Use the [-] and [+] buttons to assign the desired minus-one channel (1...16) to the selected **MELODY** track. The number of the assigned channel will appear to the left of “MinusCh” on the top line of the display.

05: MinusCh

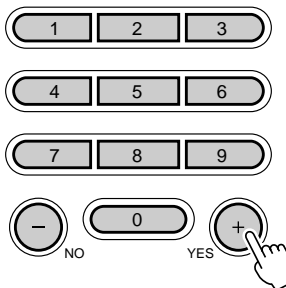

NOTE

- Press the [+] and [-] buttons simultaneously to recall the song's initial channel assignment for the selected track.
- Minus-one channel assignments do not apply to songs you record yourself.
- If a selected song includes minus-one channel settings, those channels will automatically be assigned to the appropriate tracks.

Repeat Play

This function allows you to specify any section of a song — internal or cartridge — for continuous repeat playback.

1 Select the A-b Repeat Parameter

While the SONG menu is selected, but no recording is in progress, use the SUB MENU [▲] and [▼] buttons to select the “A-b Repeat” parameter in the display. The MAIN/AUTO FILL [A] and [B] button indicators will flash.



2 Start Playback

Press the [START/STOP] button to start song playback.



3 Specify the Repeat “A” and “B” Points

While the song is playing, press the MAIN/AUTO FILL [A] button at the beginning of the section to be repeated (the [A] button indicator will light continuously, and the “A” repeat icon will appear in the display), then press the MAIN/AUTO FILL [B] button at the end of the section to be repeated (the [B] button indicator will light continuously, and the “B” repeat icon will appear in the display). Repeat playback will begin automatically from the A point as soon as the B point has been specified, and will continue until either the MAIN/AUTO FILL [A] button is pressed again to cancel the repeat function, or until song playback is stopped.

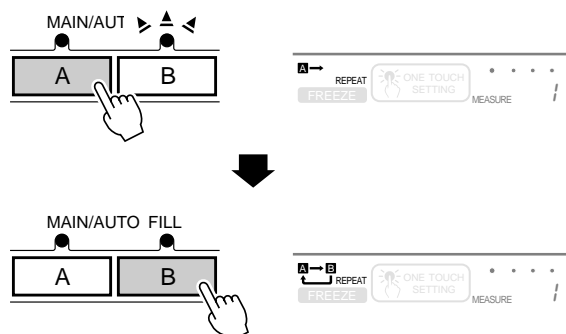

NOTE

- A-B repeat points are automatically placed at the nearest measure lines.
- If only the “A” repeat point is specified, repeat playback will occur between the “A” point and the end of the song.
- If the MAIN/AUTO FILL [B] button is pressed during repeat playback, the previously specified “B” point will be cancelled and a new “B” point can be specified as required.
- Repeat playback will continue even if a different SONG menu is selected during repeat playback.
- Repeat playback will be cancelled if a different SONG number selected or the record mode is engaged.

Song Recording

The PSR-330 SONG tracks allows you to record and play back complete songs including chord sequences created using the AUTO ACCOMPANIMENT feature and a melody lines you play on the keyboard. The SONG tracks include one ACCOMPANIMENT track and four MELODY tracks.

The PSR-330 can retain up to 2 complete songs in internal memory, and these can be selected and played back as described in the preceding section.

NOTE

- Material recorded on the SONG tracks will be retained even after turning the power off. See page 80 for the details.
- The recorded data will be lost if the power is turned off, the AC adaptor is unplugged, or the batteries fail during recording.

● The SONG MELODY tracks record the following operations and data:

- Note on/off.
- Velocity.
- R1 and R2 voice number, volume, octave*, pan, reverb send level.
- Dual voice on/off.
- Harmony on/off, type.**
- Sustain pedal on/off.
- Scale Tuning.***

NOTE

- Up to approximately 1000 notes can be recorded in the PSR-330 MELODY tracks.
- Only harmony applied to the last track recorded will be included in the recorded song data (see page 35 for details on the HARMONY effect).

● The SONG ACCOMPANIMENT track records the following operations and data:

- Section changes.
- Style number.*
- Accompaniment track changes* (8 tracks: track on/off, voice number, volume, pan, reverb send level).
- Accompaniment volume.*
- Chord changes, timing.
- Reverb on/off.
- Reverb type.
- Tempo and time signature (common to the ACCOMPANIMENT and MELODY tracks).*

NOTE

- Up to approximately 1400 chords can be recorded in the ACCOMPANIMENT track.

* Recorded only at the beginning of a song; changes cannot be made during recording.

** Recorded only at the beginning of a song; changes cannot be made during recording. Only one melody track can be recorded with harmony. The harmony data for the last track recorded with harmony will be retained (last priority).

*** Recorded only at the beginning of a song; changes cannot be made during recording. Only recorded once for all melody tracks (last priority).

Song Recording Procedure

1 Set Up to Record

Before recording set up the PSR-330 as required: e.g. select the required voice(s), effects, accompaniment style, accompaniment fingering mode, etc.

2 Engage the Record Ready Mode

Press the **[RECORD]** button to engage the record-ready mode. The **[RECORD]** button indicator will light, the SONG menu will automatically be selected, and a SONG number will appear on the top line of the display. The beat indicator dots will flash at the currently set tempo, indicating that the record ready (synchro-start) mode is engaged. Also, the frame surrounding the song MELODY and ACCOMPANIMENT track icons will flash, indicating that a MELODY and/or ACCOMPANIMENT track must be selected before recording can begin.

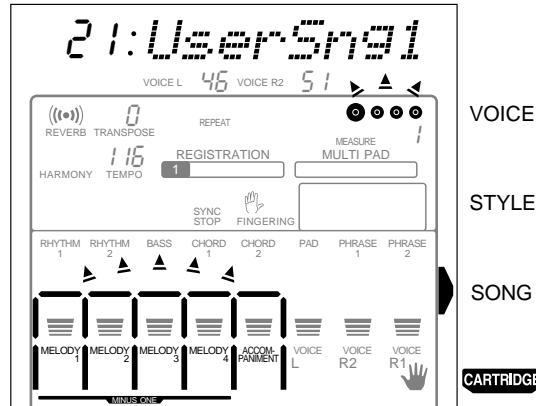

NOTE

- If the **[RECORD]** button is pressed while a demonstration song or cartridge song is selected, the lowest-numbered user song which does not contain any recorded data will automatically be selected. If other user songs already contain data, however, user song number 21 will be selected.
- The following panel setting changes will occur when the record ready mode is engaged:
 - The measure number will be reset to "1".
 - If the Metronome function is on (page 65), the metronome will sound at the current tempo.
 - The **REGISTRATION MEMORY FREEZE** function will be turned on (it cannot be turned off while the record mode is engaged).
 - The **SYNCHRO STOP** function will be turned off.

3 If Necessary, Select a User Song Number

If the desired user song is not already selected, use the **[+]** and **[-]** or number buttons to select as required.

4 Select the Track(s) to be Recorded

Use the **TRACK** buttons to select a **SONG MELODY** track to record (only one **MELODY** track can be recorded at a time). A frame appears continuously around the icon of the **MELODY** track selected for recording.

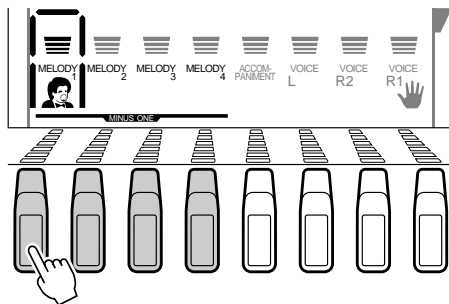

The **ACCOMPANIMENT** track can be recorded alone or at the same time as one **MELODY** track. If you intend to record accompaniment use the appropriate **TRACK** button to select the **ACCOMPANIMENT** track (a frame will appear continuously around the **ACCOMPANIMENT** track icon).

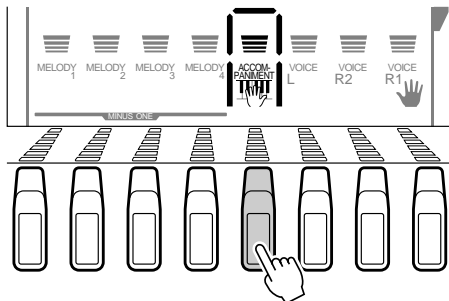

NOTE

- The R1 and R2 voices can be simultaneously recorded on a single track. The L voice cannot be recorded.
- If you start recording without selecting a specific track, the **MELODY 1** and **ACCOMP** tracks will automatically be selected for recording.

NOTE

- The panel **AUTO ACCOMPANIMENT [ON/OFF]** button is automatically turned off when the **ACCOMPANIMENT** track is turned off.
- **AUTO ACCOMPANIMENT** will automatically be turned on if it is off when the **ACCOMPANIMENT** track is selected for recording. Conversely, the **ACCOMPANIMENT** track will automatically be selected for recording if the **AUTO ACCOMPANIMENT [ON/OFF]** button is turned on.
- **AUTO ACCOMPANIMENT** cannot be turned on or off during recording.

5 Record

Recording will begin as soon as you play a note on the keyboard or press the **[START/STOP]** button, and the **BEAT** indicator dots will begin to indicate the current beat as in the **Auto Accompaniment** mode. The **MEASURE** parameter will also show the current measure number during recording.



NOTE

- Before actually starting to record you can try playing the **PSR-330** the way it is set up by using the "Rehearsal Mode": press the **[SYNC START]** button to temporarily disengage the record ready mode, rehearse as necessary, then press the **[SYNC START]** button again to return to the record ready mode.
- Whenever you record using a **SONG**, any previously recorded material in the same track will be erased.
- If the **SONG** memory becomes full while recording, "FULL" will appear on the display and recording will stop (the "Rehearsal Mode" will be engaged).

- Recording is carried out in 1-measure increments. If you stop recording in the middle of a measure, rests will automatically be recorded until the end of that measure.
- If you start recording by pressing the [START/STOP] button, nothing will be recording on a MELODY track until you begin playing on the keyboard. Only rhythm accompaniment will be recorded on the ACCOMPANIMENT track until you play a chord in the auto accompaniment section of the keyboard.

- During recording you can use the TRACK buttons to turn playback of previously-recorded MELODY tracks or the ACCOMPANIMENT track on or off as required.

6 Stop Recording

Stop recording by pressing the [START/STOP] button. If you press the [ENDING] button while recording the ACCOMPANIMENT track, recording will stop automatically after the ending section has finished. When recording is stopped the MEASURE number on the display will return to “001” and the record-ready mode will be engaged.

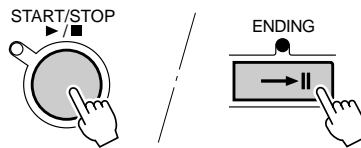

NOTE

- You can also press the [SYNC START] button to stop recording and return to the record ready mode.

7 Record Additional Tracks as Required

By repeating steps 4 through 6, above, you can select and record additional tracks as required.

NOTE

- While the record ready mode is engaged you can press the [VOICE] button to go to the VOICE menu and change the R1 voice as required. The R2 voice, however, cannot be changed (If the Voice Set function is on — page 65 — the R2 voice will automatically be changed when an R1 panel voice is selected). The record-ready mode must be disengaged in order to change the R2 voice and other settings.

8 Exit From the Record Mode

When you're finished recording a song, press the [RECORD] button so that its indicator goes out to exit from the record mode. The recorded user song can now be played back in the same way as the demonstration songs (page 44).



NOTE

- Many types of data recorded in user songs can be re-written (“revoiced”) as described on page 61.

Clearing Song Data

This function makes it possible to clear unneeded data from the PSR-330 SONG memory.

Clearing an Entire Song

While the SONG record-ready or rehearsal mode is engaged use the SUB MENU [▲] and [▼] buttons to select the “SongClr?” function, then press the [+] (YES) button: “Sure?” will appear on the display. Press the [+] (YES) button a second time to actually clear the currently selected user song (the demonstration songs and cartridge songs cannot be cleared). Press [-] (NO) if you want to abort the clear operation.

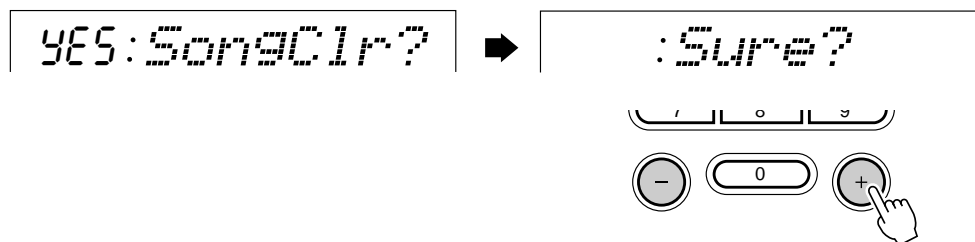

Clearing Selected Melody Tracks

While the SONG record-ready or rehearsal mode is engaged use the SUB MENU [▲] and [▼] buttons to select the “TrkClr?” function. The SONG tracks icons corresponding to MELODY tracks which contain data will flash (the ACCOMPANIMENT track cannot be cleared — neither can tracks in demonstration or cartridge songs). Use the **TRACK** buttons to select track(s) you want to clear (frames will appear continuously around the selected tracks). Once the desired tracks have been selected, press the [+] (YES) button: “Sure?” will appear on the display. Press the [+] (YES) button a second time to actually clear the currently selected track(s). Press [-] (NO) if you want to abort the clear operation.

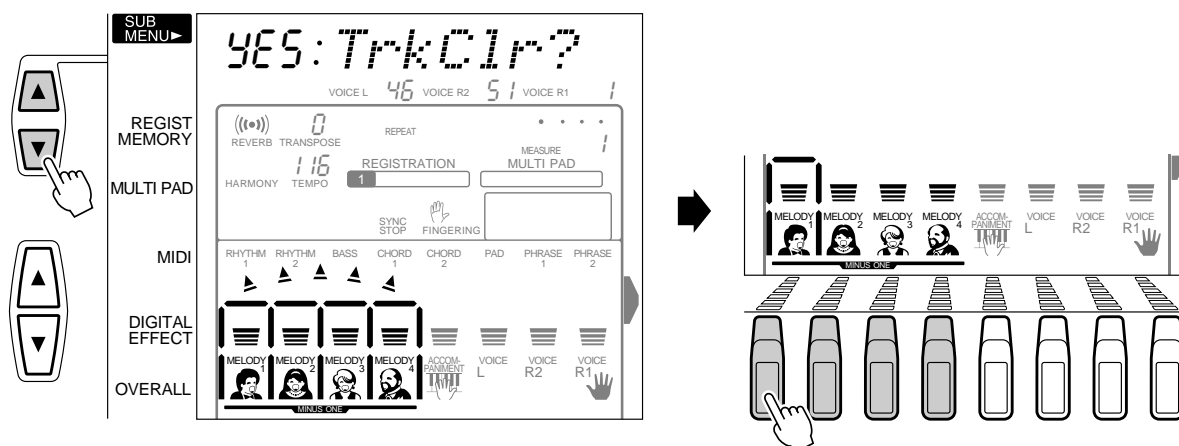

Using Music Cartridges

The PSR-330 features a cartridge slot which accepts pre-programmed Yamaha Music Cartridges containing style and/or song data. One sample Music Cartridge containing song data is supplied with the PSR-330. Others are available from your Yamaha dealer.

◆ Inserting a Music Cartridge

With the power OFF, insert the Music Cartridge into the cartridge slot as shown, and press down firmly until the Cartridge is seated properly (as shown in the illustration). The Cartridge is shaped so that it will only fit in the slot one way - don't try to force it in the wrong way. Turn the power back ON again after inserting.

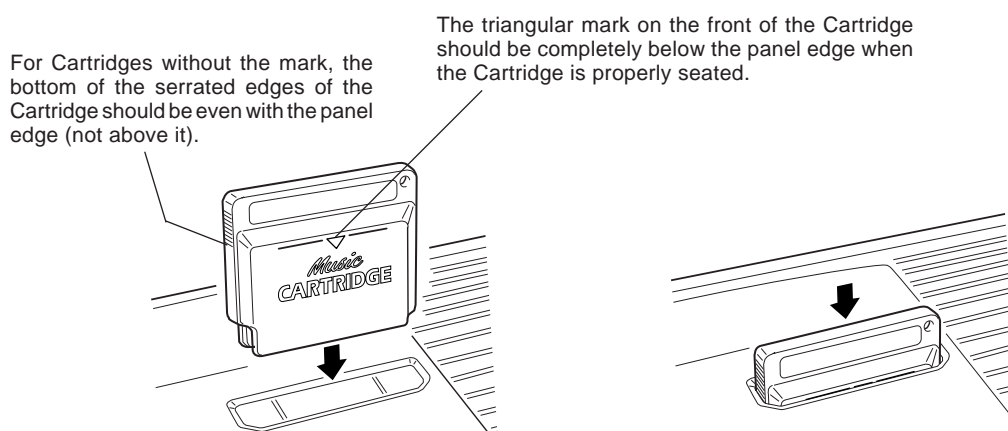

◆ Music Cartridge Handling Precautions

- Do not leave Music Cartridges in locations which are subject to excessive heat or humidity.
- Do not drop Music Cartridges or subject them to strong shock.
- Do not disassemble Music Cartridges.
- Do not directly touch the Music Cartridge's electrical contacts. Persistently touching it may cause to break electrical contacts or generate static electricity. Static electric charges can cause loss of data and unreliable operation.
- Do not insert objects or cartridges other than Yamaha Music Cartridges in the PortaTone cartridge slot. Doing so can result in serious damage to the instrument.
- Never attempt to insert or remove a cartridge when the power switch is ON. Doing so can result in loss of the PSR-330 memory data (song data/registration memory data) or complete lack of control.
- The Music Cartridge data may not be selected or played back correctly, if the electrical contacts on the Music Cartridge are affected with dust. If this happens, insert and remove the Music Cartridge several times. This may solve the problem. If the problem still happens, wipe and clean the electrical contacts on the Music Cartridge with a dry soft cloth.

NOTE

- Be sure to insert the Music Cartridge when you recall the registration settings based on the cartridge data or playback the song based on the cartridge data. Otherwise, "No Cart (Cartridge)" will appear on the display.

Cartridge Songs

Using Yamaha Music Cartridges (the one supplied with the PSR-330 includes 7 songs, others are available from your Yamaha dealer), the PSR-330 will let you enjoy listening to automated performances, or function as your “private music tutor,” allowing you to practice various parts of a piece while the others are played automatically.

Cartridge Song Playback

1 Select the Cartridge Menu

Press the [CARTRIDGE] button to select the CARTRIDGE menu (the triangular indicator will appear next to “CARTRIDGE” to the right of the display). The number and name of the currently selected cartridge song will appear on the top line of the display, the CART icon will appear in the upper left corner of the display, and the song track and volume icons near the bottom of the display will appear framed. The [START/STOP] indicator will flash.

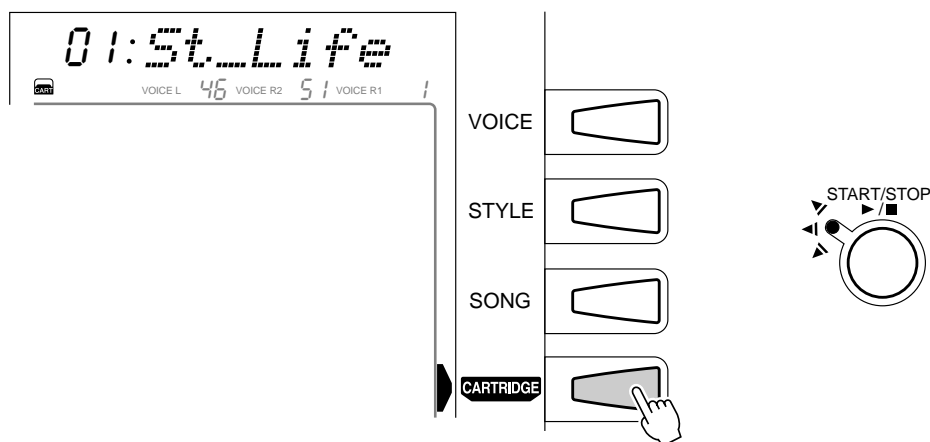

NOTE

- Cartridge song numbers can also be selected from the SONG menu as follows: press and hold the number [3] button until the cartridge icon appears in the display, then enter the number of the cartridge song you want to select via the number buttons in the normal way.
- The cartridge songs can also be selected from the SONG menu by using the [-] and [+] buttons to go beyond the highest or lowest internal song numbers — e.g. pressing the [+] button while internal song number 22 is selected will select cartridge song number 1 (the cartridge icon will appear).

2 Select a Cartridge Song Number

Use the [-] and [+] or number buttons to select the cartridge song number you want to play. The song number can also be incremented by pressing the [CARTRIDGE] button: press briefly to increment by one, or hold for continuous incrementing.

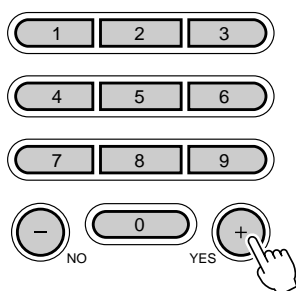

3 Start Playback

Playback will begin as soon as the [START/STOP] button is pressed. You can turn the MELODY and ACCOMPANIMENT tracks on and off during playback as required by using the TRACK buttons.



NOTE

- Playback can be started from any measure — page 46.
- The playback tempo can be changed freely as required.
- Cartridge song data cannot be revoiced.

Cartridge Accompaniment Styles

Optional Style Music Cartridges provides extra accompaniment styles that can be used in the same way as the internal accompaniment styles after pressing the [STYLE] button to select the STYLE menu.

Cartridges which contain both song and style data require a slightly different style selection procedure: Press and hold the number [3] button until the cartridge icon appears to the left of the style name in the display, then enter the number of the cartridge style you want to select via the number buttons in the normal way. The cartridge styles can also be selected by using the [-] and [+] buttons to go beyond the highest or lowest internal style numbers — e.g. pressing the [+] button while internal style number 100 is selected will select cartridge style number 01 (the cartridge icon will appear).

The cartridge styles are used in exactly the same way as the internal accompaniment styles (page 20).

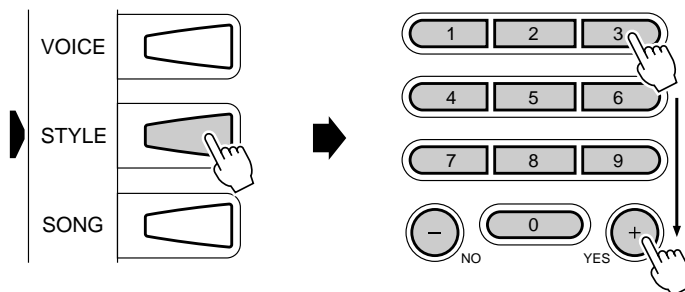

Revoicing

The PSR-330 REVOICE function lets you change the following parameters for the R1, R2 and L voices, the AUTO ACCOMPANIMENT tracks, and the user SONG tracks.

● Revoice Parameters

Parameter	Display	Range	Comments
Voice	Voice Name	1 ... 264	Assigns a voice number to the specified PSR-330 voice or track.
Volume	<i>Volume</i>	0 ... 127	Sets the volume of the specified PSR-330 voice or track.
Octave	<i>Octave</i>	-2 ... 2	Shifts the pitch of the specified voice or track up or down by one or two octaves. A setting of "0" produces normal pitch.
Pan	<i>Pan</i>	-7 ... 7	Positions the sound of the specified voice or track from left to right in the stereo sound field. "-7" is full left, "7" is full right, "0" is center, and all other settings are corresponding positions in between.
Reverb Send Level	<i>RevSndLv</i>	0 ... 127	Sets the reverb send level for the specified voice or track, and thus the amount of reverb effect applied to that voice or track.

Revoicing the R1, R2, and L Voices

1 Select the VOICE REVOICE Mode

While the VOICE menu is selected, press the [REVOICE] button (actually, the order here is not important: you can also press the [VOICE] button after pressing the [REVOICE] button). The [REVOICE] button indicator will light and a frame will appear around the R1 voice icon in the display (i.e. the R1 voice is initially selected for revoicing).

NOTE

- The VOICE REVOICE mode cannot be selected while the song record mode is engaged.

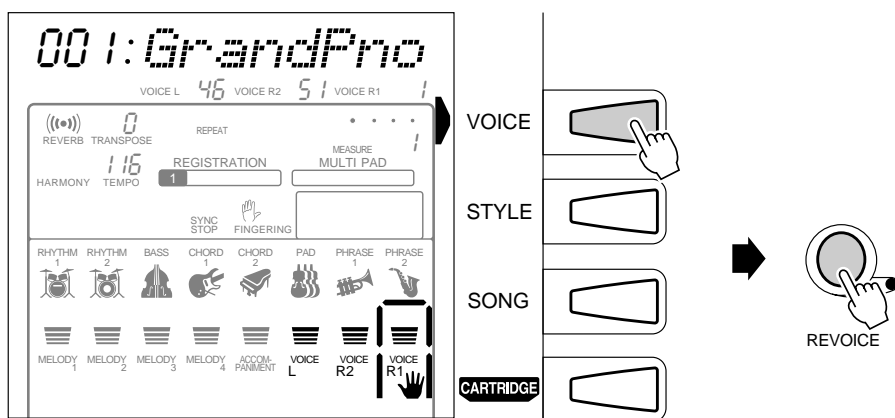

2 If Necessary Select a Voice to Revoice

Use the three rightmost **TRACK** buttons to select the voice you want to revoice: L, R2, or R1. A frame will appear around the icon of the selected voice.

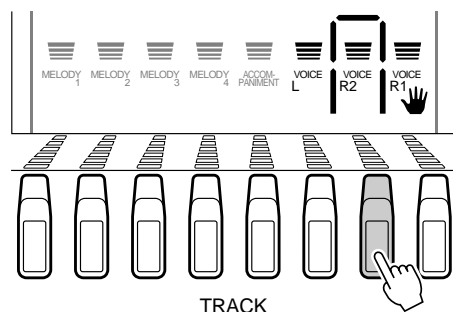

NOTE

- The **TRACK** button below the selected voice can be used to turn the voice on or off. Make sure that the voice is turned on if you want to monitor the sound while revoicing (the R1 voice cannot be turned off).

3 Select and Edit the Revoice Parameters

Use the **SUB MENU** [▲] and [▼] buttons to select the desired parameter. The name of the selected parameter will appear on the top line of the display to the right of the parameter's current value. Use the [+] and [-] or number buttons to set the parameter's value as required. Refer to the "Revoice Parameters" chart on page 58.

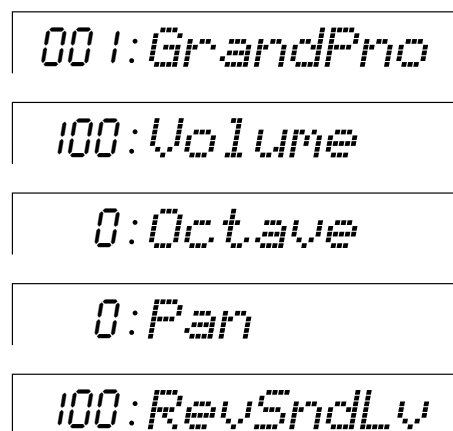

Shortcut

- You can jump directly to the **REVOICE R2 VOICE** display by pressing and holding the [DUAL VOICE] button for a few seconds.
- You can jump directly to the **REVOICE L VOICE** display by pressing and holding the [SPLIT VOICE] button for a few seconds.

NOTE

- If the Voice Set function is turned on (page 65) the R1, R2, and L voice parameter settings may be changed when a different R1 panel voice is selected, thus the REVOICE settings will be lost. Turn off the Voice Set function if you do not want this to occur.
- Minus settings for the Octave and Pan parameters can be directly entered by pressing the appropriate number button while holding the [-] button.

4 Repeat as Required and Exit When Done

Repeat steps 2 and 3, above, to revoice the voices as required, then press the **[REVOICE]** button so that its indicator goes out to exit from the REVOICE mode.



NOTE

- The REVOICE mode will automatically be exited if the **MENU** [▲] and [▼] buttons are used to select any of the menus to the left of the display, or if the [CARTRIDGE] button is pressed.
- Save any revoice settings you want to keep to the **PSR-330 REGISTRATION MEMORY** (page 39). The revoice settings are temporary and will be lost if the power is turned off, a different R1 panel voice is selected while the Voice Set function is on, or a **REGISTRATION MEMORY** is recalled.

Revoicing a Style

1 Select the STYLE REVOICE Mode

While the STYLE menu and the style you want to revoice are selected, press the [REVOICE] button (actually, the order here is not important: you can also press the [STYLE] button after pressing the [REVOICE] button). The [REVOICE] button indicator will light and a frame will appear around the RHYTHM 1 track icon in the display (i.e. the RHYTHM 1 track is initially selected for revoicing).

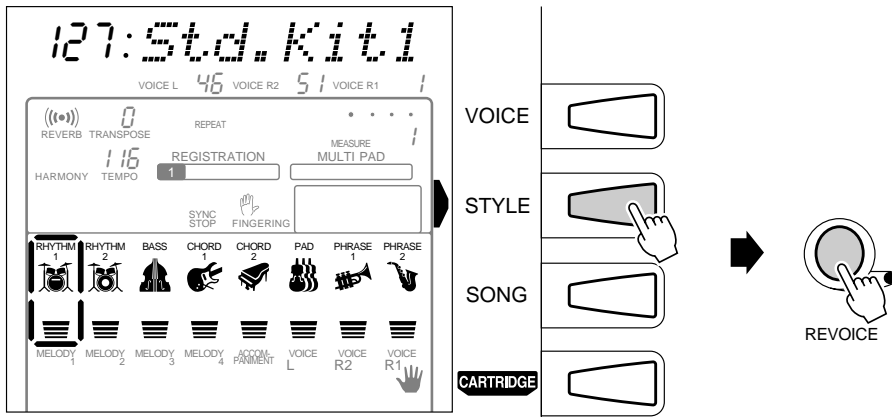

NOTE

- The STYLE REVOICE mode can even be selected by pressing the [REVOICE] button while an accompaniment is playing.
- The STYLE REVOICE mode cannot be selected while the song record mode is engaged.
- The STYLE REVOICE mode cannot be selected while a song or voice is being revoiced during song playback.
- The TRACK button below the selected track can be used to turn the track on or off. Make sure that the track is turned on if you want to monitor the sound while revoicing.
- Only drum kits (voice numbers 127 ... 136) can be selected for the RHYTHM 1 track.
- Any voice can be selected for the RHYTHM 2 track, but please note that the RHYTHM 2 track is not affected by the AUTO ACCOMPANIMENT feature.
- The OCTAVE parameter cannot be edited in the STYLE REVOICE mode.
- Style revoicing affects all sections of the selected style.
- “- -” will appear on the top line of the display if you select an accompaniment track which contains no data for revoicing, and revoicing will not be possible.
- Minus settings for the Octave and Pan parameters can be directly entered by pressing the appropriate number button while holding the [-] button.

2 If Necessary Select a Track to Revoice

Use the TRACK buttons to select the accompaniment track you want to revoice: RHYTHM 1, RHYTHM 2, BASS, CHORD 1, CHORD 2, PAD, PHRASE 1, or PHRASE 2. A frame will appear around the icon of the selected track.

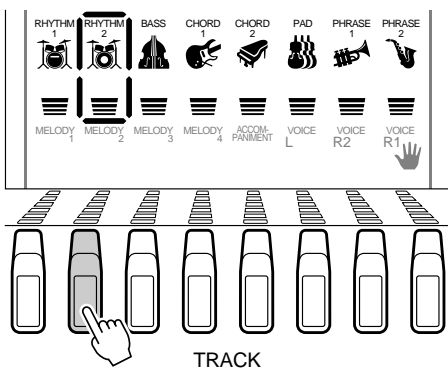

3 Select and Edit the Revoice Parameters

Use the SUB MENU [▲] and [▼] buttons to select the desired parameter. The name of the selected parameter will appear on the top line of the display to the right of the parameter's current value. Use the [+] and [-] or number buttons to set the parameter's value as required. Refer to the “Revoice Parameters” chart on page 58.

4 Repeat as Required and Exit When Done

Repeat steps 2 and 3, above, to revoice the tracks as required, then press the [REVOICE] button so that its indicator goes out to exit from the REVOICE mode.



REVOICE

NOTE

- The REVOICE mode will automatically be exited if the MENU [▲] and [▼] buttons are used to select any of the menus to the left of the display, or if the [CARTRIDGE] button is pressed.
- Save any revoice settings you want to keep to the PSR-330 REGISTRATION MEMORY (page 39). The revoice setting are temporary and will be lost if the power is turned off, a different style is selected, or a REGISTRATION MEMORY is recalled.

Revoicing a User Song

1 Select the SONG REVOICE Mode

While the SONG menu and the user song you want to revoice are selected, press the [REVOICE] button (actually, the order here is not important: you can also press the [SONG] button after pressing the [REVOICE] button). The [REVOICE] button indicator will light and a frame will appear around the MELODY 1 track icon in the display (i.e. the MELODY 1 track is initially selected for revoicing).

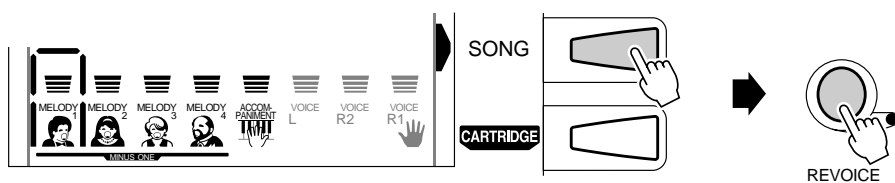

REVOICE

NOTE

- Revoicing a user song actually rewrites the recorded song data, so the original data will be lost.
- The pre-programmed internal songs and cartridge songs cannot be revoiced.
- The SONG REVOICE mode cannot be selected while the song record mode is engaged.
- The SONG REVOICE mode cannot be selected while a style or voice is being revoiced during accompaniment style playback.

2 If Necessary Select a Track to Revoice

Use the TRACK buttons to select the SONG track you want to revoice: MELODY 1 ... MELODY 4, or ACCOMP. A frame will appear around the icon of the selected track.

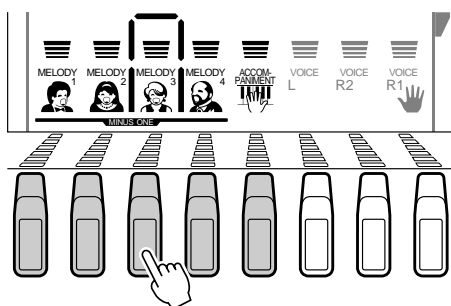

NOTE

- The TRACK button below the selected track can be used to turn the track on or off. Make sure that the track is turned on if you want to monitor the sound while revoicing.

3 Select and Edit the Revoice Parameters

Use the SUB MENU [▲] and [▼] buttons to select the desired parameter. The name of the selected parameter will appear on the top line of the display to the right of the parameter's current value.

100: RevSndLv

Use the [+] and [-] or number buttons to set the parameter's value as required. Refer to the "Revoice Parameters" chart on page 58.

70: RevSndLv

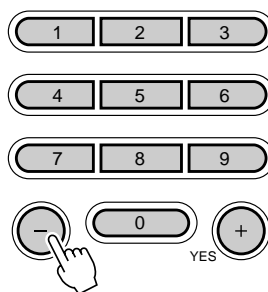

NOTE

- " - - " will appear on the top line of the display if you select a song track which contains no data for revoicing, and revoicing will not be possible.
- Only the Volume parameter can be revoiced for the ACCOMPANIMENT track. If you attempt to change any other parameter " - - " will appear on the top line of the display and revoicing will not be possible.
- If the R1 and R2 voices have been recorded to a single track, only the R1 voice can be revoiced.
- Minus settings for the Octave and Pan parameters can be directly entered by pressing the appropriate number button while holding the [-] button.
- Only one song revoice parameter can be recorded per track. If you revoice a song while playing back the song, only the last-entered data will be recorded.

4 Repeat as Required and Exit When Done

Repeat steps 2 and 3, above, to revoice the tracks as required, then press the [REVOICE] button so that its indicator goes out to exit from the REVOICE mode.



NOTE

- The REVOICE mode will automatically be exited if the MENU [▲] and [▼] buttons are used to select any of the menus to the left of the display, or if the [CARTRIDGE] button is pressed.
- Since revoicing a user song actually rewrites the song data, the revoiced song will remain in memory as long as a working set of batteries is installed in the PSR-330, or the AC adapter is connected.

Overall Functions

Some of the functions in the OVERALL function group have already been described in appropriate sections of this manual. Others will be introduced for the first time in this section. Refer to the chart below for the page numbers on which each function is described. The chart also lists the full name of each function, the abbreviated name which appears on the display, and the available settings or range of settings. Ranges are indicated by two or more values separated by ellipsis (...).

Function	Display	Settings	Page
Touch Sensitivity	<i>TouchSns</i>	0 ... 127	64
Master Tuning	<i>Tuning</i>	-50 ... +50	64
Scale Tuning Note	<i>SC.Note</i>	C ... b	64
Scale Tuning	<i>SC.Tune</i>	-64 ... 63	64
Metronome	<i>Metronom</i>	oFF, on	65
Split Voice Split Point	<i>S.Split</i>	0 ... 127	18
Accompaniment Split Point	<i>AccSPnt</i>	0 ... 127	27
Fingering Mode	<i>FngrngMd</i>	SF, F1, F2, FuL, MuL	28
Voice Set	<i>VoiceSet</i>	oFF, on	65

To access an OVERALL function first use the MENU [▲] and [▼] buttons to move the triangular indicator in the display next to “OVERALL”.

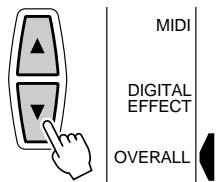

Then use the SUB MENU [▲] and [▼] buttons to select the desired function from within the OVERALL menu. When a function is selected the current setting will appear to the left of the function name on the top line of the display. Once the function has been selected, use the [-] and [+] buttons (or number buttons, where applicable) to set the function as required.

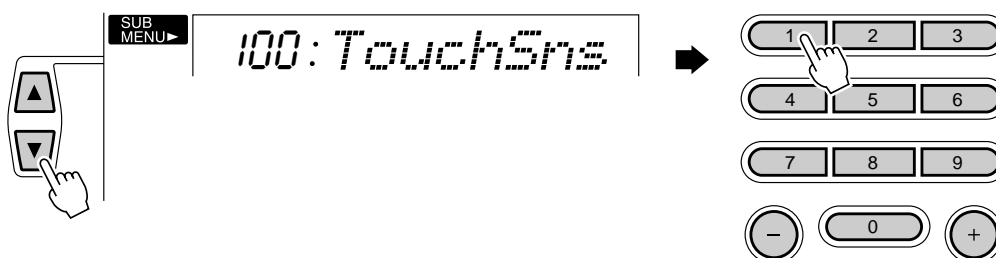

Overall Functions

Touch Sensitivity

This function sets the keyboard touch sensitivity. The range is from “0” to “127”. The higher the value the higher the sensitivity. When the touch sensitivity value is set to “0”, “oFF” appears in the display and the same volume is produced no matter how hard you play the keys. — this setting can produce a more realistic effect with voices that normally do not have touch response: e.g. organ and harpsichord.

100: TouchSns

Master Tuning

The Tuning function sets the overall pitch of the PSR-330 over a ± 50 cent range (from -50 to $+50$) in 1-cent increments. Since 1 cent is 1/100th of a semitone, the total tuning range is from a semitone below normal pitch to a semitone above normal pitch.

00: Tuning

NOTE

- The “normal” tuning value (“0”) can be recalled by simultaneously pressing the [-] and [+] buttons.
- Minus values can be entered by using the number buttons while holding the [-] button.

Scale Tuning

Scale tuning allows each individual note of the octave to be tuned over range from -64 to $+63$ cents in 1-cent increments (1 cent = 1/100th of a semitone). This makes it possible to produce subtle tuning variations, or tune the instrument to totally different scales (e.g. classic or Arabic scales).

First use the SC.Note function to select the note to be tuned. The range is from C to b: C, $d\flat$, d, $E\flat$, E, F, $G\flat$, G, $A\flat$, A, $b\flat$, b.

C : SC. Note

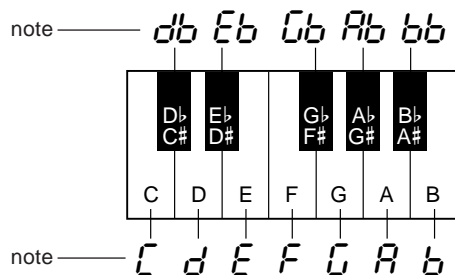

NOTE

- The scale tuning settings are common to each octave on the keyboard.
- The Accompaniment and Multi Pad sound is affected by Scale Tuning.
- The “normal” tuning value (“0”) can be recalled by simultaneously pressing the [-] and [+] buttons.
- Minus values can be entered by using the number buttons while holding the [-] button.

Then use the SC.Tune function to tune the selected note as required.

-50: SC. Tune

Metronome

When turned “on” the PSR-330 metronome will sound during AUTO ACCOMPANIMENT playback as well as SONG playback and recording.

`on:Metronom`

Split Voice Split Point

See page 18.

Accompaniment Split Point

See page 27.

Fingering Mode

See page 28.

Voice Set

The VOICE SET feature brings out the best in each individual voice by automatically setting a range of important voice-related parameters whenever an R1 panel voice (voice numbers 1 ... 136) is selected. The parameters that may be set by the VOICE SET feature are listed below. This function lets you turn VOICE SET on or off, as required.

NOTE

- The Voice Set function is on by default when the power is initially turned on.

`on:VoiceSet`

● Voice Set parameter list

- R1 Voice (Volume, octave, pan, reverb send level)
- R2 Voice (Voice number, volume, octave, pan, reverb send level)
- L Voice (Voice number, volume, octave, pan, reverb level)
- Reverb ON/OFF
- Harmony type, volume

MIDI Functions

MIDI, the Musical Instrument Digital Interface, is a world-standard communication interface that allows MIDI-compatible musical instruments and equipment to share musical information and control one another. This makes it possible to create “systems” of MIDI instruments and equipment that offer far greater versatility and control than is available with isolated instruments.

The MIDI Connectors

The MIDI IN connector receives MIDI data from an external MIDI device which can be used to control the PSR-330. The MIDI OUT connector transmits MIDI data generated by the PSR-330 (e.g. note and velocity data produced by playing the keyboard).

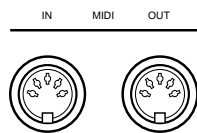

Simple MIDI Control

Most MIDI keyboards (including the PSR-330, of course) transmit note and velocity (touch response) information via the MIDI OUT connector whenever a note is played on the keyboard. If the MIDI OUT connector is connected to the MIDI IN connector of a second keyboard (synthesizer, etc.) or a tone generator (essentially a synthesizer with no keyboard), the second keyboard or tone generator will respond precisely to notes played on the original transmitting keyboard. The result is that you can effectively play two instruments at once, providing thick multi-instrument sounds. The PSR-330 also transmits “program change” data when one of its voices is selected. Depending on how the receiving device is set up, the corresponding voice will be automatically selected on the receiving keyboard or tone generator whenever a voice is selected on the PSR-330.

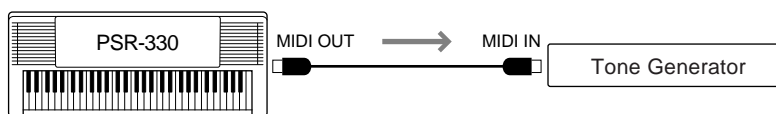

The PSR-330 is capable of receiving the same MIDI data, so a second MIDI keyboard connected to the PSR-330 MIDI IN connector can be used to remotely play the PSR-330 and select voices as required.

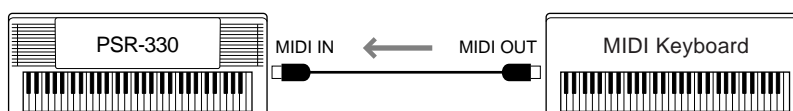

MIDI Sequence Recording

Although the PSR-330 features a built-in “sequencer” (the SONG recorder is a type of sequencer), the same type of musical information transfer described above can be used for more sophisticated MIDI sequence recording using an external sequencer or music computer. A MIDI sequence recorder or music computer can be used to “record” MIDI data received from a PSR-330, for example. When the recorded data is played back, the PSR-330 automatically “plays” the recorded performance in precise detail.

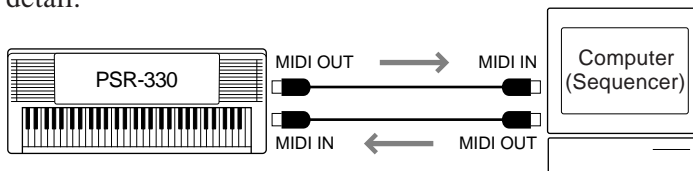

NOTE

- Never use MIDI cables longer than about 15 meters. Cables longer than this can pick up noise which can cause data errors.

The PSR-330 MIDI Functions

The PSR-330 has the following MIDI functions.

Function	Display	Settings	Page
Transmit Channel	Tr. Ch	1 ... 16	68
Transmit Track	Tr. Trk	r 1, r 2, L, rH 1, rH 2, bAS, CH 1, CH 2, PRd, PH 1, PH 2, oFF	68
Receive Channel	Rcv. Ch	1 ... 16	69
Receive Mode	Rcv. Mod	nor, oFF, rE	69
Local Control	Local	oFF, on	70
External Clock	ExtClock	oFF, on	70
Bulk Data Send	BlkSnd?	None	70
Initial Data Send	InitSnd?	None	71

NOTE

- No MIDI transmission or reception occurs while the song track icons in the display are active (i.e. when they are framed). In other words, no MIDI transmission or reception occurs during song playback, song stop, song recording, song record standby, or the song rehearsal mode.

To access a MIDI function first use the MENU [▲] and [▼] buttons to move the triangular indicator in the display next to “MIDI”, then use the SUB MENU [▲] and [▼] buttons to select the desired function from within the MIDI menu. When a function is selected the current setting will appear on the top line of the display. Once the function has been selected, use the [-] and [+] buttons (or number buttons, where applicable) to set the function as required.

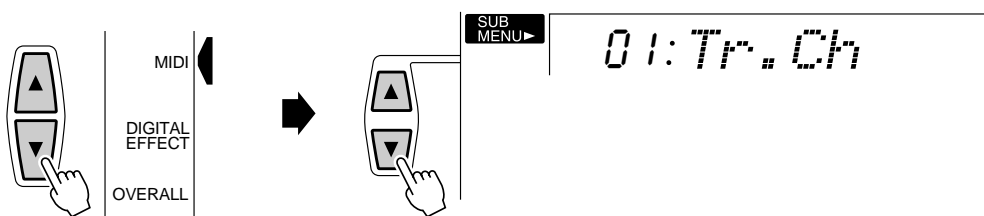

Transmit Channel & Transmit Track

The PSR-330 can simultaneously transmit data on all 16 MIDI channels. The Transmit Channel and Transmit Track functions determine what PSR-330 data is transmitted via which MIDI channels.

● Transmit Channel

The “Tr.Ch” function selects a MIDI channel to which a PSR-330 track can be assigned via the Transmit Track function, below. First select a transmit channel, then the transmit track for that channel. Different tracks can be assigned to each of the 16 MIDI channels. Any of the standard MIDI channels - 1 through 16 — can be specified.

01:Tr.Ch

● Transmit Track

The “Tr.Trk” function selects the track to be transmitted via the transmit channel specified by the Transmit Channel function, above. The available settings are as follows:

r1:Tr.Trk

r1	R1 keyboard voice.
r2	R2 keyboard voice
L	L keyboard voice.
rH1	Auto accompaniment rhythm 1 track data.
rH2	Auto accompaniment rhythm 2 track data.
bB5	Auto accompaniment bass track data.
CH1	Auto accompaniment chord 1 track data.
CH2	Auto accompaniment chord 2 track data.
PA1	Auto accompaniment pad track data.
PH1	Auto accompaniment phrase 1 track data.
PH2	Auto accompaniment phrase 2 track data.
OFF	No data transmitted.

NOTE

- The initial default channel/track settings are:
Channel 1: R1 voice.
Channel 2: L voice
Channel 11: R2 voice.
All other channels: OFF.
- When a track is assigned to more than one MIDI channel, the data from that track is transmitted via the lowest-numbered channel.
- To avoid MIDI loops which can cause operational errors, check the PSR-330 Local Control setting (page 70), and the MIDI THRU settings of any external MIDI devices.
- MIDI transmit track settings will be retained even after turning the power off. See page 80 for the details.

Receive Channel & Receive Mode

The PSR-330 can simultaneously receive data on all 16 MIDI channels, allowing it to function as a 16-channel multi-timbral tone generator. The Receive Channel and Receive Mode functions determine how each channel will respond to received MIDI data.

● Receive Channel

The “Rcv.Ch” function selects a MIDI channel to which a receive mode is to be assigned via the Receive Mode function, below. First select a receive channel, then the receive mode for that channel. Any of the standard MIDI channels — 1 through 16 — can be specified.

01:Rcv.Ch

● Receive Mode

The “Rcv.Mod” function specifies the receive mode for the channel selected via the Receive Channel function, above. The receive mode settings are as follows:

nor : Rcv. Mod

nor	“Normal”. Received MIDI data is sent directly to the PSR-330 tone generator. If all channels are set to “nor”, the PSR-330 functions as a 16-channel multi-timbral tone generator.
oFF	No MIDI data is received on channels set to “oFF”.
rE	“Remote”. Received MIDI data is handled in the same way as data generated by the PSR-330’s own keyboard. In other words, a remote keyboard could be used to control the PSR-330 AUTO ACCOMPANIMENT functions, etc.

NOTE

- MIDI receive mode settings will be retained even after turning the power off. See page 80 for the details.

Local Control

“Local Control” refers to the fact that, normally, the PSR-330 keyboard controls the internal tone generator, allowing the internal voices to be played directly from the keyboard. This situation is “Local Control on” since the internal tone generator is controlled locally by its own keyboard. Local control can be turned off, however, so that the keyboard does not play the internal voices, but the appropriate MIDI information is still transmitted via the MIDI OUT connector when notes are played on the keyboard. At the same time, the internal tone generator can respond to MIDI information received on channels set to the “nor” (normal) mode via the MIDI IN connector. This means that while an external MIDI sequencer, for example, plays the PSR-330 internal voices, an external tone generator can be played from the PSR-330 keyboard. The default Local Control setting is “on”.

A rectangular LCD display showing the text "on:Local" in a pixelated font.

Clock

Reception of an external MIDI clock signal can be enabled or disabled as required. When disabled (“off”), all of the time-based functions (Auto Accompaniment, SONG recording and playback, etc.) are controlled by its own internal clock. When MIDI clock reception is enabled (“on”), however, all timing is controlled by an external MIDI clock signal received via the MIDI IN terminal (in this case the PSR-330 TEMPO setting has no effect). The default setting is “off”.

A rectangular LCD display showing the text "off:ExtClock" in a pixelated font.

NOTE

- Clock is “off” by default when the power is initially turned on.
- When Clock is turned “on”, AUTO ACCOMPANIMENT playback cannot be started or stopped via the panel [START/STOP] button, or started via the synchro start function. Also, the MULTI PAD playback cannot be initiated by pressing the MULT PADS.

Bulk Data Send

This function causes the contents of the registration and song memories to be transmitted via the MIDI OUT connector. This data can be saved to memory or disk via a MIDI sequence recorder or MIDI data recorder, and then reloaded when required. The bulk data can also be sent directly to a second PSR-330.

To send the bulk data select the “BkSnd?” function, then press the [+] (YES) button. “Sure?” will appear on the display. Press [+] (YES) again to begin transmission of the bulk data. “BkSnd:Rg” (registration data) and then “BkSnd:Sg” (song data) will appear on the display during transmission. “End” will appear on the display briefly when the transmission has finished.

NOTE

- A bulk dump transmission can be stopped at any time by pressing the [-] (NO) button.
- No other operations can be performed during bulk dump transmission.

A rectangular LCD display showing the text "YES:BkSnd?" in a pixelated font.



A rectangular LCD display showing the text ":Sure?" in a pixelated font.

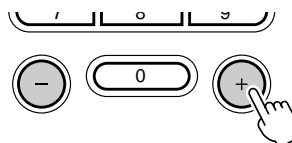

● Receiving Bulk Data

The PSR-330 will automatically receive compatible bulk data from an external MIDI device as long as no auto accompaniment, multi pad, or song recording/playback operation is in progress. “BkRcv” will appear on the display during reception, then “End” will appear briefly when all data has been received.

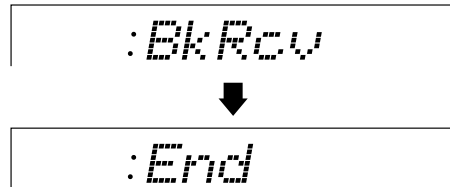





NOTE

- No other operations can be performed during bulk dump reception.
- If an error is encountered during bulk data reception, “Blk Err” will appear on the display, and song and registration memory will be cleared.
- When a bulk dump is received, the received data replaces any data that was previously in the PSR-330 memory.

■ Initial Data Send

Transmits all current panel settings to a second PSR-330 or a MIDI data storage device. To send the initial data select the “InitSnd?” function, then press the [+] (YES) button. “Sure?” will appear on the display. Press the [+] (YES) again to begin transmission of the initial data.

YES: InitSnd?

MENU	SUB MENU	FUNCTION	PAGE
VOICE	<i>ex</i> GrandPno (R1 voice name)	R1 voice selection.	15, 58
	<i>ex</i> 8BtPop1 (Style name)	Accompaniment style selection.	20, 60
SONG	<i>ex</i> DancePop (Song name)	Song selection.	12, 44
	Measure *	Measure from which to start playback.	46
	MinusCh [MinusOne] *	Minus-one channel setting.	47
	A-b:Repeat *	Repeat playback setting.	49
	SongClr? *	Song clear.	54
	TrkClr? *	Track clear.	54
CARTRIDGE	<i>ex</i> St_Life (Song name)	Cartridge song selection.	56
REGISTRATION MEMORY	Bank 1 (Bank name)	Registration bank selection.	39
	 REGISTRATION MEMORY Button		
MULTI PAD	<i>ex</i> Funky (Multi Pad set name)	Multi Pad set selection.	41
	 MULTI PAD STOP Button		
	Pad1Chd	Chord match on/off selection (pad 1)	42
	Pad2Chd	Chord match on/off selection (pad 2)	42
	Pad3Chd	Chord match on/off selection (pad 3)	42
	Pad4Chd	Chord match on/off selection (pad 4)	42
MIDI	Tr. Ch	Transmit channel selection.	68
	Tr. Trk	Transmit track selection.	68
	Rcv. Ch	Receive channel selection.	69
	Rcv. Mod	Receive mode selection.	69
	Local	Local on/off selection.	70
	ExtClock	External/internal clock selection.	70
	BlkSnd?	Bulk dump transmission.	70
	InitSnd?	Initial panel setting transmission.	71
DIGITAL EFFECT	<i>ex</i> Hall1 [Reverb] (Reverb type name)	Reverb type selection.	34
	 REVERB Button		
	<i>ex</i> Duet [Harmony] (Harmony type name)	Harmony type selection.	36
	 HARMONY Button		
	HarmVol	Harmony volume setting.	37
OVERALL	TouchSns	Touch sensitivity setting.	64
	Tuning	Overall tuning.	64
	SC.Note	Scale tuning (note) setting.	64
	SC.Tune	Scale tuning (tune) setting.	64
	Metronom	Metronome on/off selection.	65
	S.Split	Split mode split point selection.	18
	AccSPnt	Auto accompaniment split point selection.	27
	FngrrngMd  AUTO ACCOMPANIMENT	Fingering mode selection.	28
		ON/OFF Button	
	VoiceSet	Voice set on/off selection.	65

- Sub-menu items with a “ * ” appear only when the record mode is engaged.
- Sub-menu items with a “ ☆ ” appear only when the record mode is not engaged.
- Sub-menu items with “  ” have shortcut access (press and hold the specified button for a few seconds to jump directly to the associated sub-menu function). In addition to the shortcuts listed above, the [DUAL VOICE] button can be held to jump to the R2 voice revoice function, and the [SPLIT VOICE] button can be held to jump to the L voice revoice function.

Troubleshooting

Something not working as it should? In many cases what appears to be a malfunction can be traced to a simple error that can be remedied immediately. Before assuming that your PSR-330 is faulty, please check the following points.

PROBLEM	POSSIBLE CAUSE/SOLUTION
The speakers produce a “pop” sound whenever the power is turned ON or OFF.	This is normal and is no cause for alarm.
The volume is reduced or the sound is distorted.	The batteries probably need to be replaced. Either replace all six batteries, or use an AC power adaptor.
The registration memory doesn’t work properly.	
Recorded song data will not play back properly.	
The display goes bland and all panel controls are reset.	
No sound when the keyboard is played.	The R1/R2/L voice volume settings could be set too low. Make sure the voice volumes are set at appropriate levels (page 58).
	The Local Control function could be turned off. Make sure Local Control is turned on (page 70).
Not all simultaneously-played notes sound.	You are probably exceeding the maximum polyphony of the PSR-330. The PSR-330 can play up to 31 notes at the same time — including split, dual, auto-accompaniment, song, and multi pad notes. Notes exceeding this limit will not sound.
Auto Accompaniment seems to “skip” when the keyboard is played.	
Auto Accompaniment doesn’t sound when started.	The MIDI Clock mode may be set to “on”. Make sure it is turned “off” (page 70).
Auto accompaniment won’t function properly. No lower keyboard sound.	Make sure that all accompaniment tracks are turned on, and that they are all set to appropriate volume levels.
	Make sure you are using fingerings recognized by the selected fingering mode, and are playing in the Auto Accompaniment section of the keyboard.
	Are you sure you’re playing in the Auto-Accompaniment section of the keyboard? Make sure that the Auto Accompaniment split point is set appropriately (page 27).
	Are you playing chords that the PSR-330 can recognize (see chord types on page 29~)?
The Harmony function will not turn on.	Harmony cannot be turned on when the FULL KEYBOARD fingering mode is selected or if a percussion kit voice is selected. Select an appropriate fingering mode or voice.
Certain notes sound at the wrong pitch.	Make sure that the scale tuning value for those notes is set to “0” (page 64).
A cartridge style or song cannot be selected or will not play properly.	Make sure that an appropriate Yamaha Music Cartridge is properly plugged into the cartridge slot (page 55), or the cartridge contacts are dirty. Try re-inserting the cartridge. If the contacts are dirty removing and inserting the cartridge several times will sometimes solve the problem. If this doesn’t work, try wiping the cartridge connectors carefully with a soft, dry cloth.
Operation of the sustain pedal is reversed.	Sustain pedal operation will be reversed if you turn on the power or plug in the pedal while pressing the pedal. For normal operation turn off the power then turn it back on while the pedal is not pressed.
Individual registration or song memory data transmitted via bulk dump from an external sequencer or other device is not received by the PSR-330.	Transmit the data with no more than a 2-second break between blocks, or transmit as entirely separate data.

Voice List

Maximum Polyphony

The PSR-330 has 31-note maximum polyphony. This means that it play a maximum of up to 31 notes at once, regardless of what functions are used. Auto Accompaniment uses a number of the available notes, so when Auto Accompaniment is used the total number of notes that can be played on the keyboard is correspondingly reduced. The same applies to the Dual Voice, Split Voice, Multi Pad, and Song functions. Furthermore, some of the PSR-330 voices actually use two notes, thus reducing the total number of notes that can be played. The number of notes used by each voice are listed in the voice list, below.

When the maximum 31-note polyphony of the PSR-330 is exceeded, notes are played using last-note priority.

NOTE

- The Voice List includes MIDI program numbers for each voice. Use these program numbers when playing the PSR-330 via MIDI from an external device.
- The following voices use only one note outside the specified ranges:
95, 246 (Bagpipe) : above A#2.
182 (Pizzicato strings) :
below C#2 and above F5.
- When a voice number between 127 and 264 is selected using the corresponding bank select (MSB No./LSB No.) and MIDI program number, the PSR-330's GM voice set is selected.

Panel Voice List

Voice Number	Bank Select		MIDI Program Number	Voice Name	Number of Notes Used
	MSB	LSB			
PIANO					
001	0	112	0	Grand Piano	1
002	0	112	3	Honky-tonk Piano	2
003	0	112	4	Funky Electric Piano	2
004	0	112	5	DX Electric Piano	2
005	0	112	2	MIDI Grand Piano	2
006	0	113	5	Hyper Electric Piano	2
007	0	114	5	Bell Electric Piano	2
008	0	112	6	Harpsichord	1
009	0	113	6	Harpsichord Coupled	2
010	0	112	7	Clavi	1
011	0	112	8	Celesta	1
MALLETS					
012	0	112	11	Vibraphone	1
013	0	112	12	Marimba	1
014	0	112	13	Xylophone	1
015	0	112	14	Tubular Bells	1
016	0	112	47	Timpani	1
017	0	112	15	Dulcimer	2
018	0	112	114	Steel Drums	2
019	0	112	10	Music Box	2
020	0	112	108	Kalimba	1
021	0	112	112	Tinkle Bell	2
ORGAN					
022	0	112	17	Jazz Organ 1	2
023	0	113	17	Jazz Organ 2	2
024	0	112	16	Jazz Organ 3	2
025	0	113	16	Full Organ	2
026	0	112	18	Rock Organ 1	2
027	0	113	18	Rock Organ 2	2
028	0	114	16	16'+2' Organ	2
029	0	115	16	16'+4' Organ	2
030	0	112	19	Church Organ	2
031	0	112	20	Reed Organ	2
032	0	112	21	Musette Accordion	2
033	0	113	21	Traditional Accordion	2
034	0	112	23	Bandoneon	2

Voice Number	Bank Select		MIDI Program Number	Voice Name	Number of Notes Used
	MSB	LSB			
GUITAR					
035	0	112	24	Classical Guitar	1
036	0	112	25	Folk Guitar	1
037	0	113	25	12Strings Guitar	2
038	0	112	26	Jazz Guitar	2
039	0	113	26	Octave Guitar	2
040	0	112	27	Clean Guitar	2
041	0	112	28	Muted Guitar	1
042	0	112	31	Guitar Harmonics	1
043	0	112	29	Overdriven Guitar	2
044	0	112	30	Distortion Guitar	2
BASS					
045	0	112	32	Acoustic Bass	1
046	0	112	33	Finger Bass	1
047	0	112	35	Fretless Bass	1
048	0	112	36	Slap Bass	1
049	0	112	38	Synth Bass 1	2
050	0	112	39	Synth Bass 2	2
ENSEMBLE					
051	0	112	48	Strings	2
052	0	112	49	Chamber Strings	2
053	0	112	51	Synth Strings	2
054	0	113	49	Slow Strings	2
055	0	112	44	Tremolo Strings	2
056	0	114	49	Violin+Strings	2
057	0	112	45	Pizzicato Strings	1
058	0	113	52	Choir	2
059	0	112	52	Choir Aahs	2
060	0	112	53	Choir Oohs	2
061	0	112	54	Synth Choir	2
062	0	112	55	Orchestra Hit	2
STRINGS					
063	0	112	40	Violin	1
064	0	112	42	Cello	1
065	0	112	43	Contrabass	1
066	0	112	105	Banjo	1
067	0	112	106	Shamisen	1

Voice Number	Bank Select		MIDI Program Number	Voice Name	Number of Notes Used
	MSB	LSB			
068	0	112	107	Koto	1
069	0	112	46	Harp	2
070	0	112	104	Sitar	2
BRASS					
071	0	112	56	Trumpet	1
072	0	112	59	Muted Trumpet	1
073	0	112	57	Trombone	1
074	0	113	57	Trombone Section	2
075	0	112	60	French Horn	1
076	0	112	58	Tuba	1
077	0	112	61	Brass Section	2
078	0	113	61	Brass+Sax	2
079	0	114	61	Brass+Trombone	2
080	0	115	61	Brass+Trumpet	2
081	0	112	62	Synth Brass 1	2
082	0	113	63	Synth Brass 2	2
REED					
083	0	112	64	Soprano Sax	1
084	0	112	65	Alto Sax	1
085	0	112	66	Tenor Sax	1
086	0	112	67	Baritone Sax	1
087	0	113	66	Sax+Clarinet	2
088	0	114	66	Sax+Trombone	2
089	0	112	68	Oboe	1
090	0	112	69	English Horn	1
091	0	112	70	Bassoon	1
092	0	112	71	Clarinet	1
093	0	112	22	Harmonica	1
094	0	112	111	Shanai	1
095	0	112	109	Bagpipe	2
PIPE					
096	0	112	72	Piccolo	1
097	0	112	73	Flute	1
098	0	112	75	Pan Flute	1
099	0	112	74	Recorder	1
100	0	112	76	Blown Bottle	2
101	0	112	77	Shakuhachi	1
102	0	112	78	Whistle	1
103	0	112	79	Ocarina	1
SYNTH LEAD					
104	0	112	80	Square Lead	2
105	0	112	81	Sawtooth Lead	2
106	0	112	85	Voice Lead	2
107	0	112	98	Crystal	2
108	0	112	100	Brightness	2
109	0	113	81	Analog Lead	2
SYNTH PAD					
110	0	112	88	Fantasia	2
111	0	113	100	Bell Pad	2
112	0	112	89	Xenon Pad	2
113	0	112	91	Angels	2
114	0	114	81	Dark Moon	2

Voice Number	Bank Select		MIDI Program Number	Voice Name	Number of Notes Used
	MSB	LSB			
PERCUSSIVE					
115	0	112	113	Agogo	1
116	0	112	115	Woodblock	1
117	0	112	116	Taiko Drum	1
118	0	112	117	Melodic Tom	1
119	0	112	118	Synth Drum	1
120	0	112	119	Reverse Cymbal	1
SOUND EFFECTS					
121	0	112	122	Seashore	2
122	0	112	123	Bird Tweet	2
123	0	112	124	Telephone Ring	1
124	0	112	125	Helicopter	2
125	0	112	126	Applause	2
126	0	112	127	Gunshot	1
DRUM KITS					
127	127	0	0	Standard Kit 1	1
128	127	0	1	Standard Kit 2	1
129	127	0	8	Room Kit	1
130	127	0	16	Rock Kit	1
131	127	0	24	Electronic Kit	1
132	127	0	25	Analog Kit	1
133	127	0	27	Dance Kit	1
134	127	0	32	Jazz Kit	1
135	127	0	40	Brush Kit	1
136	127	0	48	Classic Kit	1

Voice List

Voice Number	Bank Select		MIDI Program Number	Voice Name	Number of Notes Used
	MSB	LSB			
Piano					
137	0	0	0	Acoustic Grand Piano	1
138	0	0	1	Bright Acoustic Piano	1
139	0	0	2	Electric Grand Piano	2
140	0	0	3	Honky-tonk Piano	2
141	0	0	4	Electric Piano 1	2
142	0	0	5	Electric Piano 2	2
143	0	0	6	Harpsichord	1
144	0	0	7	Clavi	1
Chromatic Percussion					
145	0	0	8	Celesta	1
146	0	0	9	Glockenspiel	1
147	0	0	10	Music Box	2
148	0	0	11	Vibraphone	1
149	0	0	12	Marimba	1
150	0	0	13	Xylophone	1
151	0	0	14	Tubular Bells	1
152	0	0	15	Dulcimer	2
Organ					
153	0	0	16	Drawbar Organ	2
154	0	0	17	Percussive Organ	2
155	0	0	18	Rock Organ	2
156	0	0	19	Church Organ	2
157	0	0	20	Reed Organ	1
158	0	0	21	Accordion	2
159	0	0	22	Harmonica	1
160	0	0	23	Bandoneon	2
Guitar					
161	0	0	24	Acoustic Guitar (nylon)	1
162	0	0	25	Acoustic Guitar (steel)	1
163	0	0	26	Electric Guitar (jazz)	1
164	0	0	27	Electric Guitar (clean)	2
165	0	0	28	Electric Guitar (muted)	1
166	0	0	29	Overdriven Guitar	1
167	0	0	30	Distortion Guitar	1
168	0	0	31	Guitar Harmonics	1
Bass					
169	0	0	32	Acoustic Bass	1
170	0	0	33	Electric Bass (finger)	1
171	0	0	34	Electric Bass (pick)	1
172	0	0	35	Fretless Bass	1
173	0	0	36	Slap Bass 1	1
174	0	0	37	Slap Bass 2	1
175	0	0	38	Synth Bass 1	1
176	0	0	39	Synth Bass 2	1
Strings					
177	0	0	40	Violin	1
178	0	0	41	Viola	1
179	0	0	42	Cello	1
180	0	0	43	Contrabass	1
181	0	0	44	Tremolo Strings	2
182	0	0	45	Pizzicato Strings	2
183	0	0	46	Orchestral Harp	1
184	0	0	47	Timpani	1

Voice Number	Bank Select		MIDI Program Number	Voice Name	Number of Notes Used
	MSB	LSB			
Ensemble					
185	0	0	48	Strings Ensemble 1	1
186	0	0	49	Strings Ensemble 2	1
187	0	0	50	Synth Strings 1	2
188	0	0	51	Synth Strings 2	2
189	0	0	52	Choir Aahs	1
190	0	0	53	Voice Oohs	1
191	0	0	54	Synth Voice	1
192	0	0	55	Orchestra Hit	1
Brass					
193	0	0	56	Trumpet	1
194	0	0	57	Trombone	1
195	0	0	58	Tuba	1
196	0	0	59	Muted Trumpet	1
197	0	0	60	French Horn	1
198	0	0	61	Brass Section	1
199	0	0	62	Synth Brass 1	2
200	0	0	63	Synth Brass 2	2
Reed					
201	0	0	64	Soprano Sax	1
202	0	0	65	Alto Sax	1
203	0	0	66	Tenor Sax	1
204	0	0	67	Baritone Sax	1
205	0	0	68	Oboe	1
206	0	0	69	English Horn	1
207	0	0	70	Bassoon	1
208	0	0	71	Clarinet	1
Pipe					
209	0	0	72	Piccolo	1
210	0	0	73	Flute	1
211	0	0	74	Recorder	1
212	0	0	75	Pan Flute	1
213	0	0	76	Blown Bottle	2
214	0	0	77	Shakuhachi	1
215	0	0	78	Whistle	1
216	0	0	79	Ocarina	1
Synth Lead					
217	0	0	80	Lead 1 (square)	2
218	0	0	81	Lead 2 (sawtooth)	2
219	0	0	82	Lead 3 (calliope)	2
220	0	0	83	Lead 4 (chiff)	2
221	0	0	84	Lead 5 (charang)	2
222	0	0	85	Lead 6 (voice)	2
223	0	0	86	Lead 7 (fifth)	2
224	0	0	87	Lead 8 (bass+Lead)	2
Synth Pad					
225	0	0	88	Pad 1 (new age)	2
226	0	0	89	Pad 2 (warm)	2
227	0	0	90	Pad 3 (polysynth)	2
228	0	0	91	Pad 4 (choir)	2
229	0	0	92	Pad 5 (bowed)	2
230	0	0	93	Pad 6 (metallic)	2
231	0	0	94	Pad 7 (halo)	2
232	0	0	95	Pad 8 (sweep)	2

Voice Number	Bank Select		MIDI Program Number	Voice Name	Number of Notes Used
	MSB	LSB			
Synth Effects					
233	0	0	96	FX 1 (rain)	2
234	0	0	97	FX 2 (soundtrack)	2
235	0	0	98	FX 3 (crystal)	2
236	0	0	99	FX 4 (atmosphere)	2
237	0	0	100	FX 5 (brightness)	2
238	0	0	101	FX 6 (goblins)	2
239	0	0	102	FX 7 (echoes)	2
240	0	0	103	FX 8 (sci-fi)	2
Ethnic					
241	0	0	104	Sitar	1
242	0	0	105	Banjo	1
243	0	0	106	Shamisen	1
244	0	0	107	Koto	1
245	0	0	108	Kalimba	1
246	0	0	109	Bagpipe	2
247	0	0	110	Fiddle	1
248	0	0	111	Shanai	1
Percussive					
249	0	0	112	Tinkle Bell	2
250	0	0	113	Agogo	1
251	0	0	114	Steel Drums	2
252	0	0	115	Woodblock	1
253	0	0	116	Taiko Drum	1
254	0	0	117	Melodic Tom	1
255	0	0	118	Synth Drum	1
256	0	0	119	Reverse Cymbal	1
Sound Effects					
257	0	0	120	Guitar Fret Noise	1
258	0	0	121	Breath Noise	1
259	0	0	122	Seashore	2
260	0	0	123	Bird Tweet	2
261	0	0	124	Telephone Ring	1
262	0	0	125	Helicopter	2
263	0	0	126	Applause	2
264	0	0	127	Gunshot	1

Drum Kit List

- “<—” indicates that the drum kit is the same as “127: Standard Kit”.
- Each percussion voice uses one note.
- The MIDI Note # and Note actually sound one octave lower than listed. For example, in “127: Standard kit”, the “Seq Click” (Note# 36/Note C1) corresponds to (Note# 24/Note C0).
- Voices with the same Alternate Note Number (*1 ... 2) cannot be played simultaneously.

Voice#		127	128	129	130	131
Bank MSB#		127	127	127	127	127
Bank LSB#		0	0	0	0	0
Program#		0	1	8	16	24
Keyboard		Standard Kit 1	Standard Kit 2	Room Kit	Rock Kit	Electronic Kit
Note#	Note					
36	C1	Seq Click	<—	<—	<—	<—
37	C#1	Brush Tap	<—	<—	<—	<—
38	D1	Brush Swirl	<—	<—	<—	<—
39	D#1	Brush Slap	<—	<—	<—	<—
40	E1	Brush Swirl W/Attack	<—	<—	<—	Reverse Cymbal
41	F1	Snare Roll	<—	<—	<—	<—
42	F#1	Castanet	<—	<—	<—	Hi Q
43	G1	Snare L	Snare L 2	<—	SD Rock M	Snare M 3
44	G#1	Sticks	<—	<—	<—	<—
45	A1	Bass Drum L	Bass Drum L2	<—	Bass Drum L3	Bass Drum H 4
46	A#1	Open Rim Shot	<—	<—	<—	<—
47	B1	Bass Drum M	<—	<—	Bass Drum H 3	BD Rock 2
48	C2	Bass Drum H	Bass Drum H 2	<—	BD Rock	BD Rock 3
49	C#2	Side Stick	<—	<—	<—	<—
50	D2	Snare M	Snare M 2	<—	SD Rock L	SD Rock M
51	D#2	Hand Clap	<—	<—	<—	<—
52	E2	Snare H	Snare H 2	<—	SD Rock Rim	SD Rock H
53	F2	Floor Tom L	<—	Room Tom 1	Room Tom 1	E Tom 1
54	F#2 *1	Hi-Hat Closed	<—	<—	<—	<—
55	G2	Floor Tom H	<—	Room Tom 2	Room Tom 2	E Tom 2
56	G#2 *1	Hi-Hat Pedal	<—	<—	<—	<—
57	A2	Low Tom	<—	Room Tom 3	Room Tom 3	E Tom 3
58	A#2 *1	Hi-Hat Open	<—	<—	<—	<—
59	B2	Mid Tom L	<—	Room Tom 4	Room Tom 4	E Tom 4
60	C3	Mid Tom H	<—	Room Tom 5	Room Tom 5	E Tom 5
61	C#3	Crash Cymbal 1	<—	<—	<—	<—
62	D3	High Tom	<—	Room Tom 6	Room Tom 6	E Tom 6
63	D#3	Ride Cymbal 1	<—	<—	<—	<—
64	E3	Chinese Cymbal	<—	<—	<—	<—
65	F3	Ride Cymbal Cup	<—	<—	<—	<—
66	F#3	Tambourine	<—	<—	<—	<—
67	G3	Splash Cymbal	<—	<—	<—	<—
68	G#3	Cowbell	<—	<—	<—	<—
69	A3	Crash Cymbal 2	<—	<—	<—	<—
70	A#3	Vibraslap	<—	<—	<—	<—
71	B3	Ride Cymbal 2	<—	<—	<—	<—
72	C4	Bongo H	<—	<—	<—	<—
73	C#4	Bongo L	<—	<—	<—	<—
74	D4	Conga H Mute	<—	<—	<—	<—
75	D#4	Conga H Open	<—	<—	<—	<—
76	E4	Conga L	<—	<—	<—	<—
77	F4	Timbale H	<—	<—	<—	<—
78	F#4	Timbale L	<—	<—	<—	<—
79	G4	Agogo H	<—	<—	<—	<—
80	G#4	Agogo L	<—	<—	<—	<—
81	A4	Cabasa	<—	<—	<—	<—
82	A#4	Maracas	<—	<—	<—	<—
83	B4	Samba Whistle H	<—	<—	<—	<—
84	C5	Samba Whistle L	<—	<—	<—	<—
85	C#5	Guiro Short	<—	<—	<—	<—
86	D5	Guiro Long	<—	<—	<—	<—
87	D#5	Claves	<—	<—	<—	<—
88	E5	Wood Block H	<—	<—	<—	<—
89	F5	Wood Block L	<—	<—	<—	<—
90	F#5	Cuica Mute	<—	<—	<—	Scratch Push
91	G5	Cuica Open	<—	<—	<—	Scratch Pull
92	G#5 *2	Triangle Mute	<—	<—	<—	<—
93	A5 *2	Triangle Open	<—	<—	<—	<—
94	A#5	Shaker	<—	<—	<—	<—
95	B5	Jingle Bell	<—	<—	<—	<—
96	C6	Bell Tree	<—	<—	<—	<—

Voice#		132	133	134	135	136
Bank MSB#		127	127	127	127	127
Bank LSB#		0	0	0	0	0
Program#		25	27	32	40	48
Keyboard		Analog Kit	Dance Kit	Jazz Kit	Brush Kit	Classic Kit
Note#	Note					
36	C1	<---	<---	<---	<---	<---
37	C#1	<---	<---	<---	<---	<---
38	D1	<---	<---	<---	<---	<---
39	D#1	<---	<---	<---	<---	<---
40	E1	Reverse Cymbal	Reverse Cymbal	<---	<---	<---
41	F1	<---	<---	<---	<---	<---
42	F#1	Hi Q	Hi Q	<---	<---	<---
43	G1	SD Rock H	SD Analog 2	<---	Brush Slap L	<---
44	G#1	<---	<---	<---	<---	<---
45	A1	Bass Drum H 5	BD Analog 2	<---	<---	Bass Drum L2
46	A#1	<---	SD Analog Open Rim	SD Jazz Open Rim	SD Jazz Open Rim	<---
47	B1	BD Analog 1 L	BD Analog 3	<---	<---	Gran Casa
48	C2	BD Analog 1 H	BD Analog 4	BD Jazz	BD Jazz	Gran Casa Mute
49	C#2	Analog Side Stick	Analog Side Stick	<---	<---	<---
50	D2	SD Analog 1 H	SD Analog 3	SD Jazz L	Brush Slap H	Marching SD M
51	D#2	<---	<---	<---	<---	<---
52	E2	SD Analog 1 L	SD Analog 4	SD Jazz H	Brush Tap	Marching SD H
53	F2	Analog Tom 1	Analog Tom 1	Jazz Tom 1	Brush Tom 1	Jazz Tom 1
54	F#2 *1	Analog HH 1 Closed	Analog HH 3 Closed	<---	<---	<---
55	G2	Analog Tom 2	Analog Tom 2	Jazz Tom 2	Brush Tom 2	Jazz Tom 2
56	G#2 *1	Analog HH 2 Closed	Analog HH 4 Closed	<---	<---	<---
57	A2	Analog Tom 3	Analog Tom 3	Jazz Tom 3	Brush Tom 3	Jazz Tom 3
58	A#2 *1	Analog HH 1 Open	Analog HH 3 Open	<---	<---	<---
59	B2	Analog Tom 4	Analog Tom 4	Jazz Tom 4	Brush Tom 4	Jazz Tom 4
60	C3	Analog Tom 5	Analog Tom 5	Jazz Tom 5	Brush Tom 5	Jazz Tom 5
61	C#3	Analog Cymbal	Analog Cymbal	<---	<---	Hand Cym.L Open
62	D3	Analog Tom 6	Analog Tom 6	Jazz Tom 6	Brush Tom 6	Jazz Tom 6
63	D#3	<---	<---	<---	<---	Hand Cym. L Closed
64	E3	<---	<---	<---	<---	<---
65	F3	<---	<---	<---	<---	<---
66	F#3	<---	<---	<---	<---	<---
67	G3	<---	<---	<---	<---	<---
68	G#3	Analog Cowbell	Analog Cowbell	<---	<---	<---
69	A3	<---	<---	<---	<---	Hand Cym. H Open
70	A#3	<---	<---	<---	<---	<---
71	B3	<---	<---	<---	<---	Hand Cym. H Closed
72	C4	<---	<---	<---	<---	<---
73	C#4	<---	<---	<---	<---	<---
74	D4	Analog Conga H	Analog Conga H	<---	<---	<---
75	D#4	Analog Conga M	Analog Conga M	<---	<---	<---
76	E4	Analog Conga L	Analog Conga L	<---	<---	<---
77	F4	<---	<---	<---	<---	<---
78	F#4	<---	<---	<---	<---	<---
79	G4	<---	<---	<---	<---	<---
80	G#4	<---	<---	<---	<---	<---
81	A4	<---	<---	<---	<---	<---
82	A#4	Analog Maracas	Analog Maracas	<---	<---	<---
83	B4	<---	<---	<---	<---	<---
84	C5	<---	<---	<---	<---	<---
85	C#5	<---	<---	<---	<---	<---
86	D5	<---	<---	<---	<---	<---
87	D#5	Analog Claves	Analog Claves	<---	<---	<---
88	E5	<---	<---	<---	<---	<---
89	F5	<---	<---	<---	<---	<---
90	F#5	Scratch Push	Scratch Push	<---	<---	<---
91	G5	Scratch Pull	Scratch Pull	<---	<---	<---
92	G#5 *2	<---	<---	<---	<---	<---
93	A5 *2	<---	<---	<---	<---	<---
94	A#5	<---	<---	<---	<---	<---
95	B5	<---	<---	<---	<---	<---
96	C6	<---	<---	<---	<---	<---

Data Backup & Initialization

Data Backup

Except for the data listed below, all PSR-330 panel settings are reset to their initial settings whenever the power is turned on.

- Registration Memory
- User Song Data
- MIDI Transmit Settings
- MIDI Receive Settings

The data listed above can be backed up — i.e. retained in memory — as long as a working set of batteries is installed and you keep the following Off/On procedure.

- 1** Turn the power OFF by pressing the [STAND BY/ON] switch.
- 2** Unplug the DC output cable of the PA-5, PA-5B, or PA-5C from the DC IN 10-12V jack on the rear panel of the PSR-330.
- 3** Then unplug the PA-5, PA-5B, or PA-5C Power Adaptor from the wall AC outlet.

When turning the power ON, simply reverse the procedure.

Data Initialization

All data can be initialized and restored to the factory preset condition by turning on the power while holding the highest (rightmost) white key on the keyboard. “CLr BackUp” will appear briefly on the display.

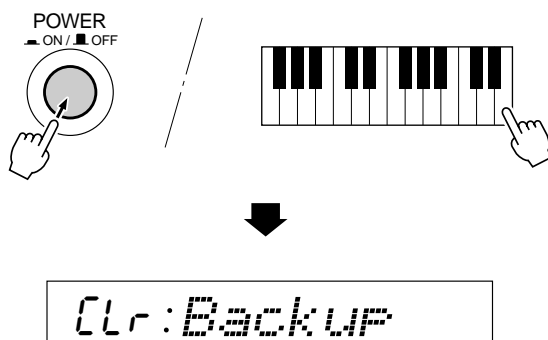

CAUTION

- All registration and song memory data, plus the other settings listed above, will be erased and/or changed when the data initialization procedure is carried out.
- Carrying out the data initialization procedure will usually restore normal operation if the PSR-330 freezes or begins to act erratically for any reason.

MIDI Implementation Chart

[Portable Keyboard]
Model: PSR-330

MIDI Implementation Chart

Date: 1997. 1. 31
Version: 1.0

Function	Transmitted	Recognized	Remarks
Basic Default Channel Changed	1~16 CH 1~16 CH	1~16 CH (*0) 1~16 CH (*0)	
Mode Default Messages Altered	Mode 3 X *****	(*0) X X	
Note Number : True voice	0~127 *****	0~127 0~127	
Velocity Note on Note off	O 9nH, v=1~127 X 9nH, v=0	O 9nH, v=1~127 X 9nH, v=0 or 8nH	
After key's Touch Ch's	X X	X X	
Pitch Bender	O	O	
Control Change	0, 32 1 6, 38 7 10 11 64 66 84 91 96 97 100, 101 120 121	O (*1) O O O O O O X O O O X O X O (*2) O O O (*3)	Bank select MSB, LSB Modulation depth Data entry MSB, LSB Volume Pan Expression Sustain Sostenuto Portamento control Reverb depth RPN Data increment RPN Data decrement RPN LSB, MSB All sound off Reset all controllers
Program Change : True #	O 0~127 *****	O 0~127 0~127	
System Exclusive	O (*4)	O (*4)	
System : Song Position : Song Select Common : Tune	X X X	X X X	
System : Clock Real Time : Commands	O O (*6)	O (*5) O (*6)	
Aux : Local ON/OFF : All Notes Off Messages : Active Sense : Reset	X X O X	X O O X	

Mode 1: OMNI ON, POLY
Mode 3: OMNI OFF, POLY

Mode 2: OMNI ON, MONO
Mode 4: OMNI OFF, MONO

O: Yes
X: No

MIDI Implementation Chart

*0 By default (factory settings) the PSR-330 ordinarily functions as a 16 channel multi-timbral tone generator. The Remote Channel can be designated with the panel settings. The designated channel can be controlled in the same manner as the PSR-330's keyboard ON/OFF control. The following messages can be received by the designated channel in this mode. All other messages will be ignored.

- Note ON
- Note OFF
- Control change : Bank select MSB, LSB
 - Volume
 - Pan
 - Sustain
 - Reverb depth
 - All sound off
 - Reset all controller
- Program change
- Exclusive

*1 BANK SELECT

- The bank select MSB is used for melody and rhythm voice switching.
(MSB 00H: Melody Voice/MSB 7FH: Rhythm Voice)
- Refer to the Voice List for details on LSB.

*2 RPN transmission/reception

Pitch bend Sensitivity	BnH, 64H, 00H, 65, 00H
Fine Tune	BnH, 64H, 01H, 65, 00H
Course Tune	BnH, 64H, 02H, 65, 00H
Null	BnH, 64H, 7FH, 65, 00H

*3 Pitch Bend, modulation, expression, sustain, sostenuto and RPN are returned to their default values. Also, resets the portamento control.

*4 EXCLUSIVE

<GM System ON> F0H, 7EH, 7FH, 09H, 01H, F7H

- All parameters except MIDI Master Tuning settings are reset to their default values.

<DISK ORCHESTRA ON> F0H, 43H, 73H, 01H, 14H, F7H

<DISK ORCHESTRA OFF> F0H, 43H, 73H, 01H, 13H, F7H

<MIDI MASTER VOLUME> F0H, 7FH, 7FH, 04H, 01H, ll, mm, F7H

- Allows the volume of all channels to be changed simultaneously. (Universal System Exclusive)
- "mm" is used as the MIDI Master Volume value ("ll" is ignored).
- The relationship between the MIDI Master Volume value and the real volume is the same as the Control Change Master Volume.
- The default value for "mm" is 7FH.

<MIDI MASTER TUNING>

F0H, 43H, 1nH, 27H, 30H, 00H, 00H, mm, ll, cc, F7H

- Simultaneously changes the tuning of all channels.
- "mm, ll" is used as the MIDI Master Tuning Value. The tuning value is represented as follows:
 T=M-128 (28<=M<=228)
 T: Tuning Value (in cents)
 M: is decimal value represented by 1-byte using bits 0..3 of "mm" as the MSB and bits 0..3 of "ll" as the LSB.

- The default values for "mm" and "ll" are 08H, 00H. Also, n and cc are recognized.
- This value is not reset by a GM System ON or Reset All Controllers message.

<BULK DUMP>

Resist Memory

F0H, 43H, 73H, 4CH, 06H, 09H, 0nH, 0nH, 0nH, 0nH, [DATA], sum, F7H

0nH, 0nH, 0nH, 0nH : Data length (nnnnH Byte)
sum : Check Sum

User Song Data

F0H, 43H, 73H, 4CH, 06H, 0AH, 0nH, 0nH, 0nH, 0nH, 0nH, 0nH, [DATA], sum, F7H

0nH, 0nH, 0nH, 0nH, 0nH, 0nH : Data length (nnnnnH Byte)
sum : Check Sum

<Section Control> F0H, 43H, 7EH, 00H, ss, dd, F7H

- This message is related to the SW section operation.

ss : 00H-07H	INTRO
08H	MAIN A
09H-0FH	MAIN B
10H	FILL IN AA
11H-17H	FILL IN BB
18H	FILL IN AB
19H-1FH	FILL IN BA
20H-27H	ENDING
dd : Switch ON/OFF	7FH (ON)/ 00H (OFF)

<START, STOP Control> F0H, 43H, 6nH, xx, F7H

- This message controls the Start/Stop for the Style. (received only)

n : Ignores the Device Number.
xx : 7A= Reset Start, 7D= Stop & Rewind

<TEMPO CONTROL> F0H, 43H, 7EH, 01H, tt, tt, tt, F7H

- This message is used to change the Tempo Value.

tt, tt, tt : Tempo Data

<Internal Clock, External Clock> (Received Only)

F0H, 43H, 73H, 01H, 02H, F7H (Internal Clock)

F0H, 43H, 73H, 01H, 03H, F7H (External Clock)

- This message controls the Clock Mode of the Style.

<XG System ON> (Received Only)

F0H, 43H, 1nH, 4CH, 00H, 00H, 7EH, 00H, F7H

n : ignores the Device Number.

- All parameters except MIDI Master Tuning are reset to their default values.
- Remote Channel setting is canceled.
- This message requires approximately 50ms to execute, so sufficient time should be allowed before the next message is sent.

<XG Parameter Change>

F0H, 43H, 1nH, 4CH, aaH, bbH, ccH, ddH, ..., F7H

n: Device number is ignored.

aa, bb, cc: address High, Mid, Low

dd: data (successive transmission and reception are possible within the amount of data shown in the following Table-1)

- For more details refer to Table-1.

Caution: The PSR-330 corresponds to the XG parameters in Table-1, but this is only a portion of XG parameters. The PSR-330 does not completely correspond to the XG format.

*5 It is possible to switch between the External and Internal Clocks.

*6 Start/Stop commands for the style can only be received when External Clock is ON.

*7 All MIDI messages will be ignored when in the Song Mode.

MIDI Data Format

<Table-1> Parameter Change

	Address (H)	Size (H)	Data (H)	Parameter	Description	Default Value (H)
SYSTEM	00 00 7E	1	00	XG SYSTEM ON		
EFFECT	02 01 00	2	00 — 7F 00 — 7F	REVERB TYPE MSB REVERB TYPE LSB	Refer Table-2 Refer Table-2	01 (=HALL1) 00
MULTI PART	08 nn 41	1	00 — 7F	SCALE TUNING C	-64 — +63 cent	40
	08 nn 42	1	00 — 7F	SCALE TUNING C#	-64 — +63 cent	40
	08 nn 43	1	00 — 7F	SCALE TUNING D	-64 — +63 cent	40
	08 nn 44	1	00 — 7F	SCALE TUNING D#	-64 — +63 cent	40
	08 nn 45	1	00 — 7F	SCALE TUNING E	-64 — +63 cent	40
	08 nn 46	1	00 — 7F	SCALE TUNING F	-64 — +63 cent	40
	08 nn 47	1	00 — 7F	SCALE TUNING F#	-64 — +63 cent	40
	08 nn 48	1	00 — 7F	SCALE TUNING G	-64 — +63 cent	40
	08 nn 49	1	00 — 7F	SCALE TUNING G#	-64 — +63 cent	40
	08 nn 4A	1	00 — 7F	SCALE TUNING A	-64 — +63 cent	40
	08 nn 4B	1	00 — 7F	SCALE TUNING A#	-64 — +63 cent	40
08 nn 4C	1	00 — 7F	SCALE TUNING B	-64 — +63 cent	40	

<Table-2> Effect map

MSB \ LSB	00H	01H	02H	7FH
00H	NO EFFECT	NO EFFECT			
01H	HALL1	HALL2			
02H	ROOM1	ROOM2			
03H	HALL1	HALL2			
04H	PLATE1	PLATE2			
05H	DELAY1	DELAY2			
06H	NO EFFECT	NO EFFECT			
⋮	⋮	⋮			
7FH	NO EFFECT	NO EFFECT			

Other than 00H, any LSB effect type that has no effect name in its corresponding part, will be directed to the corresponding effect type of the MSB value and LSB 00H.

◆ GM System Level 1

The existing MIDI protocol allows performance and other data to be transferred between different instruments, even if they are from different manufacturers. This means, for example, that sequence data that was originally created to control a tone generator from manufacturer A can also be used to control a different tone generator from manufacturer B. Since the voice allocation in different devices from different manufacturers is usually different, however, appropriate program change data must be transmitted to select the right voices.

The General MIDI protocol was developed to minimize confusion and the need for re-programming when playing software created by one MIDI device on another. This has been achieved by defining a standard voice allocation in which the same or similar voices are accessed by the same program change numbers or MIDI channels. The current standard recognized by the International MIDI Association is known as “GM System Level 1.” The PSR-330 voice allocation complies with the GM System Level 1 standard.

Specifications

Keyboards

- 61 standard-size keys (C1 — C6) with touch response.

Display

- Large multi-function LCD display

Setup

- Power : ON/OFF
- Master Volume : MIN — MAX

Control & Number Buttons

- MENU ▲▼, VOICE, STYLE, SONG, CARTRIDGE, SUB MENU ▲▼, [1] — [0], [+], [-] (YES), [-] (NO)

Cartridge Slot

Demo

- 20 Songs

Voice

- 126 Panel Voices +10 Drum Kits + 128 GM Voices
- Polyphony : 31
- Voice Set
- R1/R2/L Voices
- Revoice : Volume, Octave, Pan, Reverb Send Level
- Split Voice Mode
- Dual Voice Mode

Auto Accompaniment

- 100 Styles
- Auto Accompaniment ON/OFF
- Accompaniment Track : RHYTHM1/2, BASS, CHORD1/2, PAD, PHRASE1/2
- Accompaniment Track Settings : ON/OFF
- Accompaniment Control : SYNC START, SYNC STOP, START/STOP, INTRO, MAIN A/B (AUTO FILL), ENDING
- Beat Indicator
- Accompaniment Volume
- Revoice : Volume, Pan, Reverb Send Level

One Touch Setting

Overall Controls

- Tempo : 32 — 280
- Transpose
- Touch Sensitivity
- Master Tuning
- Scale Tuning
- Metronome
- Split Voice Split Point
- Accompaniment Split Point
- Fingering Mode : SINGLE FINGER/FINGERED 1/FINGERED 2/ FULL KEYBOARD/MULTI-FINGER
- Voice Set

Digital Effect

- Reverb : 9 types
- Harmony : 25 types

Registration Memory

- 8 Regist Bank : 1 — 4
- Accompaniment Freeze

Multi Pads

- 26 Multi Pad Sets
- 4 Pads + STOP

User Song

- User Song : 2 Songs
- Recording Tracks : ACCOMPANIMENT, MELODY 1 — 4
- Song Clear, Track Clear
- Song Volume
- Minus One Practice (Minus One Channel Setting)
- Repeat Play
- Revoice : Volume, Octave, Pan, Reverb Send Level

MIDI

- Transmit Settings
- Receive Settings
- Local Control
- Clock
- Bulk Data Send/Receive
- Initial Data Send

Auxiliary Jacks

- DC IN 10-12V, PHONES, SUSTAIN, MIDI IN/OUT

Amplifiers

- 6.0W + 6.0W (when using PA-5B power adaptor)
- 5.5W + 5.5W (when using batteries)

Speakers

- 12cm (4-3/4") x 2

Power Consumption

- 19 W (when using PA-5B AC power adaptor)

Batteries

- Six SUM-1, "D" size, R-20 or equivalent batteries

Rated Voltage

- DC 10-12V

Dimensions (W x D x H)

- 933 x 372 x 128 mm (36-3/4" x 14-2/3" x 5-1/16")

Weight

- 5.9 kg (13 lbs.) excluding batteries

Supplied Accessories

- Music Cartridge
- Music Stand
- Owner's Manual

Optional Accessories

- Headphones : HPE-150
- AC Power Adaptor : PA-5, PA-5B, PA-5C
- Foot Switch : FC4, FC5
- Keyboard Stand : L-6
- Music Cartridge

* Specifications subject to change without notice.

Index

- A** AC power adaptor 10
- Accompaniment styles, cartridge 57
- Accompaniment tracks, song 50
- Auto accompaniment 20
- Auto accompaniment on/off 20
- Auto Fill 23

- B** Bank, registration 39
- Batteries 10
- Beat indicator 23
- Bulk data receive 71
- Bulk data send 70

- C** Cartridge accompaniment styles 57
- Cartridge song playback 56
- Chord Match function 42
- Chord types, auto accompaniment 30
- Clock 70
- Connectors 11
- Contents 3

- D** Demonstration playback 12
- Digital Effect 34
- Display operation 6
- Drum kit list 78
- Dual voice mode 17

- E** Effects 34
- Ending, accompaniment 24

- F** Features 2
- Freeze (Accompaniment Freeze function) 40
- Fill-in 23
- Fingered 1 fingering mode 30
- Fingered 2 fingering mode 31
- Fingering modes, accompaniment 28
- Full Keyboard fingering mode 31

- G** GM System Level 1 14, 83

- H** Harmony 35

- I** Icons 6
- Initial data send 71
- Initialization (data backup) 80
- Intro, accompaniment 22

- K** Keyboard percussion 17

- L** Local control 70

- M** Main A & Main B sections 23
- Master tuning 64
- Measure, song play from specified 46
- Melody tracks, clearing 54
- Melody tracks, song 50
- Menu structure 72
- Menus 8
- Metronome 65
- MIDI connectors 11, 66
- MIDI data format 83
- MIDI functions 66
- MIDI implementation chart 81

- MIDI sequence recording 67
- Minus-one practice 47
- Multi pad set selection 41
- Multi Pads, playing 43
- Multi-finger fingering mode 32
- Music cartridges, handling 55
- Music stand 5

- O** One touch setting 32
- Overall functions 63

- P** Panel controls 4
- Phones jack 11
- Polyphony 74
- Power supply 10
- Precautions 1

- R** R1, R2, & L voices 14
- Receive channel & mode 69
- Record Ready Mode 51
- Registration memory 39
- Rehearsal mode 52
- Repeat play 49
- Reverb 34
- Revoicing 58

- S** Scale tuning 64
- Shortcuts 9
- Single Finger fingering mode 29
- Song clear 54
- Song playback 44
- Song playback, cartridge 56
- Song recording 50
- Song, revoice 61
- Specifications 84
- Split point, auto accompaniment 23, 27
- Split point, split voice 18
- Split voice mode 18
- Start modes, accompaniment 22
- Stop Accompaniment function 32
- Style selection 20
- Style, revoice 60
- Sustain jack 11
- Synchro Stop function 24
- Synchronized start 22

- T** Tempo, accompaniment 21
- Touch sensitivity 64
- Track assignment, minus-one 47
- Track muting, accompaniment 25
- Transmit channel & track 68
- Transposition 38
- Troubleshooting 73

- V** Voice list 74
- Voice set 65
- Voice, revoice 58
- Voices, about the 14
- Voices, selecting & playing 15
- Volume control, accompaniment 26
- Volume control, song 45
- Volume, harmony 37

Limited Warranty

90 DAYS LABOR

1 YEAR PARTS

Yamaha Corporation of America, hereafter referred to as Yamaha, warrants to the original consumer of a product included in the categories listed below, that the product will be free of defects in materials and/or workmanship for the periods indicated. This warranty is applicable to all models included in the following series of products:

PSR SERIES OF PORTATONE ELECTRONIC KEYBOARDS

If during the first 90 days that immediately follows the purchase date, your new Yamaha product covered by this warranty is found to have a defect in material and/or workmanship, Yamaha and/or its authorized representative will repair such defect without charge for parts or labor.

If parts should be required after this 90 day period but within the one year period that immediately follows the purchase date, Yamaha will, subject to the terms of this warranty, supply these parts without charge. However, charges for labor, and/or any miscellaneous expenses incurred are the consumers responsibility. Yamaha reserves the right to utilize reconditioned parts in repairing these products and/or to use reconditioned units as warranty replacements.

THIS WARRANTY IS THE ONLY EXPRESS WARRANTY WHICH YAMAHA MAKES IN CONNECTION WITH THESE PRODUCTS. ANY IMPLIED WARRANTY APPLICABLE TO THE PRODUCT, INCLUDING THE WARRANTY OF MERCHANT ABILITY IS LIMITED TO THE DURATION OF THE EXPRESS WARRANTY. YAMAHA EXCLUDES AND SHALL NOT BE LIABLE IN ANY EVENT FOR INCIDENTAL OR CONSEQUENTIAL DAMAGES.

Some states do not allow limitations that relate to implied warranties and/or the exclusion of incidental or consequential damages. Therefore, these limitations and exclusions may not apply to you.

This warranty gives you specific legal rights. You may also have other rights which vary from state to state.

CONSUMERS RESPONSIBILITIES

If warranty service should be required, it is necessary that the consumer assume certain responsibilities:

1. Contact the Customer Service Department of the retailer selling the product, or any retail outlet authorized by Yamaha to sell the product for assistance. You may also contact Yamaha directly at the address provided below.
2. Deliver the unit to be serviced under warranty to: the retailer selling the product, an authorized service center, or to Yamaha with an explanation of the problem. Please be prepared to provide proof purchase date (sales receipt, credit card copy, etc.) when requesting service and/or parts under warranty.
3. Shipping and/or insurance costs are the consumers responsibility.* Units shipped for service should be packed securely.

*Repaired units will be returned PREPAID if warranty service is required within the first 90 days.

IMPORTANT: Do NOT ship anything to ANY location without prior authorization. A Return Authorization (RA) will be issued that has a tracking number assigned that will expedite the servicing of your unit and provide a tracking system if needed.

4. Your owners manual contains important safety and operating instructions. It is your responsibility to be aware of the contents of this manual and to follow all safety precautions.

EXCLUSIONS

This warranty does not apply to units whose trade name, trademark, and/or ID numbers have been altered, defaced, exchanged removed, or to failures and/or damages that may occur as a result of:

1. Neglect, abuse, abnormal strain, modification or exposure to extremes in temperature or humidity.
2. Improper repair or maintenance by any person who is not a service representative of a retail outlet authorized by Yamaha to sell the product, an authorized service center, or an authorized service representative of Yamaha.
3. This warranty is applicable only to units sold by retailers authorized by Yamaha to sell these products in the U.S.A., the District of Columbia, and Puerto Rico. This warranty is not applicable in other possessions or territories of the U.S.A. or in any other country.

Please record the model and serial number of the product you have purchased in the spaces provided below.

Model _____ Serial # _____ Sales Slip # _____

Purchased from _____ Date _____
(Retailer)

YAMAHA CORPORATION OF AMERICA
Electronic Service Division
6600 Orangethorpe Avenue
Buena Park, CA 90620

KEEP THIS DOCUMENT FOR YOUR RECORDS. DO NOT MAIL!

For details of products, please contact your nearest Yamaha or the authorized distributor listed below.

Pour plus de détails sur les produits, veuillez-vous adresser à Yamaha ou au distributeur le plus proche de vous figurant dans la liste suivante.

Die Einzelheiten zu Produkten sind bei Ihrer unten aufgeführten Niederlassung und bei Yamaha Vertragshändlern in den jeweiligen Bestimmungsländern erhältlich.

Para detalles sobre productos, contacte su tienda Yamaha más cercana o el distribuidor autorizado que se lista debajo.

NORTH AMERICA

CANADA

Yamaha Canada Music Ltd.
135 Milner Avenue, Scarborough, Ontario,
M1S 3R1, Canada
Tel: 416-298-1311

U.S.A.

Yamaha Corporation of America
6600 Orangethorpe Ave., Buena Park, Calif. 90620,
U.S.A.
Tel: 714-522-9011

CENTRAL & SOUTH AMERICA

MEXICO

**Yamaha de Mexico S.A. De C.V.,
Departamento de ventas**
Javier Rojo Gomez No.1149, Col. Gpe Del
Moral, Deleg. Iztapalapa, 09300 Mexico, D.F.
Tel: 686-00-33

BRASIL

Yamaha Musical do Brasil LTDA.
Ave. Reboucas 2636, São Paulo, Brasil
Tel: 011-853-1377

ARGENTINA

Yamaha Music Argentina S.A.
Viamonte 1145 Piso2-B 1053,
Buenos Aires, Argentina
Tel: 1-371-7021

PANAMA AND OTHER LATIN AMERICAN COUNTRIES/ CARIBBEAN COUNTRIES

Yamaha de Panama S.A.
Torre Banco General, Piso 7, Urbanización Marbella,
Calle 47 y Aquilino de la Guardia,
Ciudad de Panamá, Panamá
Tel: 507-269-5311

EUROPE

THE UNITED KINGDOM

Yamaha-Kemble Music (U.K.) Ltd.
Sherbourne Drive, Tilbrook, Milton Keynes,
MK7 8BL, England
Tel: 01908-366700

IRELAND

Danfay Ltd.
61D, Sallynoggin Road, Dun Laoghaire, Co. Dublin
Tel: 01-2859177

GERMANY/SWITZERLAND

Yamaha Europa GmbH.
Siemensstraße 22-34, 25462 Rellingen,
F.R. of Germany
Tel: 04101-3030

AUSTRIA

Yamaha Music Austria
Schleiergasse 20, A-1100 Wien Austria
Tel: 01-60203900

THE NETHERLANDS

Yamaha Music Nederland
Kanaalweg 18G, 3526KL, Utrecht, The Netherlands
Tel: 030-2828411

BELGIUM

Yamaha Music Belgium
Keiberg Imperiastraat 8, 1930 Zaventem, Belgium
Tel: 02-7258220

FRANCE

**Yamaha Musique France,
Division Claviers**
BP 70-77312 Marne-la-Vallée Cedex 2, France
Tel: 01-64-61-4000

ITALY

**Yamaha Musica Italia S.P.A.,
Home Keyboard Division**
Viale Italia 88, 20020 Lainate (Milano), Italy
Tel: 02-935-771

SPAIN

Yamaha-Hazen Electronica Musical, S.A.
Jorge Juan 30, 28001, Madrid, Spain
Tel: 91-577-7270

PORTUGAL

Valentim de Carvalho CI SA
Estrada de Porto Salvo, Paço de Arcos 2780 Oeiras,
Portugal
Tel: 01-443-3398/4030/1823

GREECE

Philippe Nakas S.A.
Navarinou Street 13, P.Code 10680, Athens, Greece
Tel: 01-364-7111

SWEDEN

Yamaha Scandinavia AB
J. A. Wettergrens Gata 1
Box 30053
S-400 43 Göteborg, Sweden
Tel: 031 89 34 00

DENMARK

YS Copenhagen Liaison Office
Generatorvej 8B
DK-2730 Herlev, Denmark
Tel: 44 92 49 00

FINLAND

Warner Music Finland OY/Fazer Music
Aleksanterinkatu 11, P.O. Box 260
SF-00101 Helsinki, Finland
Tel: 0435 011

NORWAY

Norsk filial av Yamaha Scandinavia AB
Grini Næringspark 1
N-1345 Østerås, Norway
Tel: 67 16 77 70

ICELAND

Skifan HF
Skeifan 17 P.O. Box 8120
IS-128 Reykjavik, Iceland
Tel: 525 5000

OTHER EUROPEAN COUNTRIES

Yamaha Europa GmbH.
Siemensstraße 22-34, 25462 Rellingen, F.R. of
Germany
Tel: 04101-3030

AFRICA

**Yamaha Corporation,
International Marketing Division**
Nakazawa-cho 10-1, Hamamatsu, Japan 430
Tel: 053-460-2312

MIDDLE EAST

TURKEY/CYPRUS

Yamaha Europa GmbH.
Siemensstraße 22-34, 25462 Rellingen,
F.R. of Germany
Tel: 04101-3030

OTHER COUNTRIES

**Yamaha Corporation,
International Marketing Division**
Nakazawa-cho 10-1, Hamamatsu, Japan 430
Tel: 053-460-2312

ASIA

HONG KONG

Tom Lee Music Co., Ltd.
11/F., Silvercord Tower 1, 30 Canton Road,
Tsimshatsui, Kowloon, Hong Kong
Tel: 730-1098

INDONESIA

**PT. Yamaha Music Indonesia (Distributor)
PT. Nusantik**
Gedung Yamaha Music Center, Jalan Jend. Gatot
Subroto Kav. 4, Jakarta 12930, Indonesia
Tel: 21-520-2577

KOREA

Cosmos Corporation
#131-31, Neung-Dong, Sungdong-Ku, Seoul
Korea
Tel: 02-466-0021~5

MALAYSIA

Yamaha Music Malaysia, Sdn., Bhd.
16-28, Jalan SS 2/72, Petaling Jaya, Selangor,
Malaysia
Tel: 3-717-8977

PHILIPPINES

Yupangco Music Corporation
339 Gil J. Puyat Avenue, P.O. Box 885 MCPO,
Makati, Metro Manila, Philippines
Tel: 819-7551

SINGAPORE

Yamaha Music Asia Pte., Ltd.
Blk 202 Hougang, Street 21 #02-01,
Singapore 530202
Tel: 382-1922

TAIWAN

Yamaha KHS Music Co., Ltd.
10F, 150, Tun-Hwa Northroad,
Taipei, Taiwan, R.O.C.
Tel: 02-717-3812

THAILAND

Siam Music Yamaha Co., Ltd.
121/60-61 RS Tower 17th Floor,
Ratchadaphisek RD., Dindaeng,
Bangkok 10320, Thailand
Tel: 02-641-2951

THE PEOPLE'S REPUBLIC OF CHINA AND OTHER ASIAN COUNTRIES

**Yamaha Corporation,
International Marketing Division**
Nakazawa-cho 10-1, Hamamatsu, Japan 430
Tel: 053-460-2317

OCEANIA

AUSTRALIA

Yamaha Music Australia Pty. Ltd.
17-33 Market Street, South Melbourne, Vic. 3205,
Australia
Tel: 3-699-2388

NEW ZEALAND

Music Houses of N.Z. Ltd.
146/148 Captain Springs Road, Te Papapa,
Auckland, New Zealand
Tel: 9-634-0099

COUNTRIES AND TRUST TERRITORIES IN PACIFIC OCEAN

**Yamaha Corporation,
International Marketing Division**
Nakazawa-cho 10-1, Hamamatsu, Japan 430
Tel: 053-460-2317

