

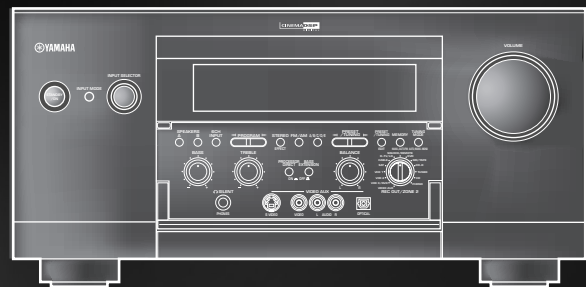

CINEMA DSP
DIGITAL

RX-Z1

AV Receiver



OWNER'S MANUAL

IMPORTANT SAFETY INSTRUCTIONS

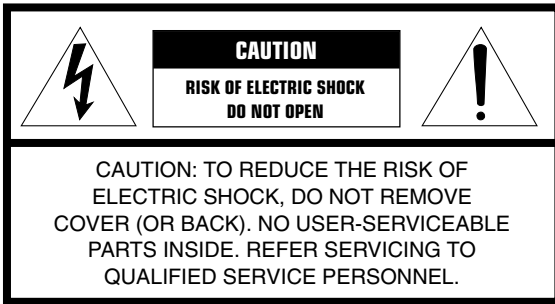

• Explanation of Graphical Symbols

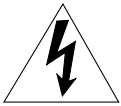

The lightning flash with arrowhead symbol, within an equilateral triangle, is intended to alert you to the presence of uninsulated "dangerous voltage" within the product's enclosure that may be of sufficient magnitude to constitute a risk of electric shock to persons.



The exclamation point within an equilateral triangle is intended to alert you to the presence of important operating and maintenance (servicing) instructions in the literature accompanying the appliance.

WARNING

TO REDUCE THE RISK OF FIRE OR ELECTRIC SHOCK, DO NOT EXPOSE THIS UNIT TO RAIN OR MOISTURE.

- 1** Read Instructions – All the safety and operating instructions should be read before the product is operated.
- 2** Retain Instructions – The safety and operating instructions should be retained for future reference.
- 3** Heed Warnings – All warnings on the product and in the operating instructions should be adhered to.
- 4** Follow Instructions – All operating and use instructions should be followed.
- 5** Cleaning – Unplug this product from the wall outlet before cleaning. Do not use liquid cleaners or aerosol cleaners. Use a damp cloth for cleaning.
- 6** Attachments – Do not use attachments not recommended by the product manufacturer as they may cause hazards.
- 7** Water and Moisture – Do not use this product near water – for example, near a bath tub, wash bowl, kitchen sink, or laundry tub; in a wet basement; or near a swimming pool; and the like.
- 8** Accessories – Do not place this product on an unstable cart, stand, tripod, bracket, or table. The product may fall, causing serious injury to a child or adult, and serious damage to the product. Use only with a cart, stand, tripod, bracket, or table recommended by the manufacturer, or sold with the product. Any mounting of the product should follow the manufacturer's instructions, and should use a mounting accessory recommended by the manufacturer.
- 9** A product and cart combination should be moved with care. Quick stops, excessive force, and uneven surfaces may cause the product and cart combination to overturn. 
- 10** Ventilation – Slots and openings in the cabinet are provided for ventilation and to ensure reliable operation of the product and to protect it from overheating, and these openings must not be blocked or covered. The openings should never be blocked by placing the product on a bed, sofa, rug, or other similar surface. This product should not be placed in a built-in installation such as a bookcase or rack unless proper ventilation is provided or the manufacturer's instructions have been adhered to.
- 11** Power Sources – This product should be operated only from the type of power source indicated on the marking label. If you are not sure of the type of power supply to your home, consult your product dealer or local power company. For products intended to operate from battery power, or other sources, refer to the operating instructions.
- 12** Grounding or Polarization – This product may be equipped with a polarized alternating current line plug (a plug having one blade wider than the other). This plug will fit into the power outlet only one way. This is a safety feature. If you are unable to insert the plug fully into the outlet, try reversing the plug. If the plug should still fail to fit, contact your electrician to replace your obsolete outlet. Do not defeat the safety purpose of the polarized plug.
- 13** Power-Cord Protection – Power-supply cords should be routed so that they are not likely to be walked on or pinched by items placed upon or against them, paying particular attention to cords at plugs, convenience receptacles, and the point where they exit from the product.
- 14** Lightning – For added protection for this product during a lightning storm, or when it is left unattended and unused for long periods of time, unplug it from the wall outlet and disconnect the antenna or cable system. This will prevent damage to the product due to lightning and power-line surges.
- 15** Power Lines – An outside antenna system should not be located in the vicinity of overhead power lines or other electric light or power circuits, or where it can fall into such power lines or circuits. When installing an outside antenna system, extreme care should be taken to keep from touching such power lines or circuits as contact with them might be fatal.
- 16** Overloading – Do not overload wall outlets, extension cords, or integral convenience receptacles as this can result in a risk of fire or electric shock.
- 17** Object and Liquid Entry – Never push objects of any kind into this product through openings as they may touch dangerous voltage points or short-out parts that could result in a fire or electric shock. Never spill liquid of any kind on the product.
- 18** Servicing – Do not attempt to service this product yourself as opening or removing covers may expose you to dangerous voltage or other hazards. Refer all servicing to qualified service personnel.
- 19** Damage Requiring Service – Unplug this product from the wall outlet and refer servicing to qualified service personnel under the following conditions:
 - a)** When the power-supply cord or plug is damaged,
 - b)** If liquid has been spilled, or objects have fallen into the product,
 - c)** If the product has been exposed to rain or water,
 - d)** If the product does not operate normally by following the operating instructions. Adjust only those controls that are covered by the operating instructions as an improper adjustment of other controls may result in damage and will often require extensive work by a qualified technician to restore the product to its normal operation,
 - e)** If the product has been dropped or damaged in any way, and
 - f)** When the product exhibits a distinct change in performance - this indicates a need for service.
- 20** Replacement Parts – When replacement parts are required, be sure the service technician has used replacement parts specified by the manufacturer or have the same characteristics as the original part. Unauthorized substitutions may result in fire, electric shock, or other hazards.
- 21** Safety Check – Upon completion of any service or repairs to this product, ask the service technician to perform safety checks to determine that the product is in proper operating condition.

- 22 Wall or Ceiling Mounting – The unit should be mounted to a wall or ceiling only as recommended by the manufacturer.
- 23 Heat – The product should be situated away from heat sources such as radiators, heat registers, stoves, or other products (including amplifiers) that produce heat.
- 24 Outdoor Antenna Grounding – If an outside antenna or cable system is connected to the product, be sure the antenna or cable system is grounded so as to provide some protection against voltage surges and built-up static charges. Article 810 of the National Electrical Code, ANSI/NFPA 70, provides information with regard to proper grounding of the mast and supporting structure, grounding of the lead-in wire to an antenna discharge unit, size of grounding conductors, location of antenna discharge unit, connection to grounding electrodes, and requirements for the grounding electrode.

EXAMPLE OF ANTENNA GROUNDING

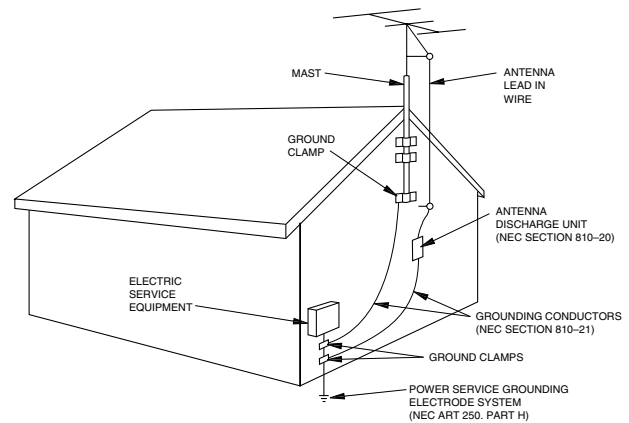

NEC – NATIONAL ELECTRICAL CODE

Note to CATV system installer:

This reminder is provided to call the CATV system installer’s attention to Article 820-40 of the NEC that provides guidelines for proper grounding and, in particular, specifies that the cable ground shall be connected to the grounding system of the building, as close to the point of cable entry as practical.

FCC INFORMATION (for US customers only)

- 1. **IMPORTANT NOTICE : DO NOT MODIFY THIS UNIT!**
This product, when installed as indicated in the instructions contained in this manual, meets FCC requirements. Modifications not expressly approved by Yamaha may void your authority, granted by the FCC, to use the product.
- 2. **IMPORTANT :** When connecting this product to accessories and/or another product use only high quality shielded cables. Cable/s supplied with this product **MUST** be used. Follow all installation instructions. Failure to follow instructions could void your FCC authorization to use this product in the USA.
- 3. **NOTE :** This product has been tested and found to comply with the requirements listed in FCC Regulations, Part 15 for Class “B” digital devices. Compliance with these requirements provides a reasonable level of assurance that your use of this product in a residential environment will not result in harmful interference with other electronic devices.

This equipment generates/uses radio frequencies and, if not installed and used according to the instructions found in the users manual, may cause interference harmful to the operation of other electronic devices.

Compliance with FCC regulations does not guarantee that interference will not occur in all installations. If this product is found to be the source of interference, which can be determined by turning the unit “OFF” and “ON”, please try to eliminate the problem by using one of the following measures:

Relocate either this product or the device that is being affected by the interference.

Utilize power outlets that are on different branch (circuit breaker or fuse) circuits or install AC line filter/s.

In the case of radio or TV interference, relocate/reorient the antenna. If the antenna lead-in is 300 ohm ribbon lead, change the lead-in to coaxial type cable.

If these corrective measures do not produce satisfactory results, please contact the local retailer authorized to distribute this type of product. If you can not locate the appropriate retailer, please contact Yamaha Electronics Corp., U.S.A. 6660 Orangethorpe Ave, Buena Park, CA 90620.

The above statements apply **ONLY** to those products distributed by Yamaha Corporation of America or its subsidiaries.

We Want You Listening For A Lifetime

YAMAHA and the Electronic Industries Association’s Consumer Electronics Group want you to get the most out of your equipment by playing it at a safe level. One that lets the sound come through loud and clear without annoying blaring or distortion – and, most importantly, without affecting your sensitive hearing.

Since hearing damage from loud sounds is often undetectable until it is too late, YAMAHA and the Electronic Industries Association’s Consumer Electronics Group recommend you to avoid prolonged exposure from excessive volume levels.



CAUTION: READ THIS BEFORE OPERATING YOUR UNIT.

- 1 To assure the finest performance, please read this manual carefully. Keep it in a safe place for future reference.
- 2 Install this unit in a well ventilated, cool, dry, clean place with at least 30 cm on the top, 10 cm on the right and left, and 10 cm at the back of this unit — away from direct sunlight, heat sources, vibration, dust, moisture, and/or cold.
- 3 Locate this unit away from other electrical appliances, motors, or transformers to avoid humming sounds. To prevent fire or electrical shock, do not place this unit where it may get exposed to rain, water, and/or any type of liquid.
- 4 Do not expose this unit to sudden temperature changes from cold to hot, and do not locate this unit in a environment with high humidity (i.e. a room with a humidifier) to prevent condensation inside this unit, which may cause an electrical shock, fire, damage to this unit, and/or personal injury.
- 5 On the top of this unit, do not place:
 - Other components, as they may cause damage and/or discoloration on the surface of this unit.
 - Burning objects (i.e. candles), as they may cause fire, damage to this unit, and/or personal injury.
 - Containers with liquid in them, as they may cause electrical shock to the user and/or damage to this unit.
- 6 Do not cover this unit with a newspaper, tablecloth, curtain, etc. in order not to obstruct heat radiation. If the temperature inside this unit rises, it may cause fire, damage to this unit, and/or personal injury.
- 7 Do not plug in this unit to a wall outlet until all connections are complete.
- 8 Do not operate this unit upside-down. It may overheat, possibly causing damage.
- 9 Do not use force on switches, knobs and/or cords.
- 10 When disconnecting the power cord from the wall outlet, grasp the plug; do not pull the cord.
- 11 Do not clean this unit with chemical solvents; this might damage the finish. Use a clean, dry cloth.
- 12 Only voltage specified on this unit must be used. Using this unit with a higher voltage than specified is dangerous and may cause fire, damage to this unit, and/or personal injury. YAMAHA will not be held responsible for any damage resulting from use of this unit with a voltage other than specified.
- 13 To prevent damage by lightning, disconnect the power cord from the wall outlet during an electrical storm.
- 14 Take care of this unit so that no foreign objects and/or liquid drops inside this unit.
- 15 Do not attempt to modify or fix this unit. Contact qualified YAMAHA service personnel when any service is needed. The cabinet should never be opened for any reasons.
- 16 When not planning to use this unit for long periods of time (i.e. vacation), disconnect the AC power plug from the wall outlet.
- 17 Be sure to read the “TROUBLESHOOTING” section on common operating errors before concluding that this unit is faulty.
- 18 Before moving this unit, press **STANDBY/ON** to set this unit in the standby mode, and disconnect the AC power plug from the wall outlet.

This unit is not disconnected from the AC power source as long as it is connected to the wall outlet, even if this unit itself is turned off. This state is called the standby mode. In this state, this unit is designed to consume a very small quantity of power.

FOR CANADIAN CUSTOMERS

To prevent electric shock, match wide blade of plug to wide slot and fully insert.
This Class B digital apparatus complies with Canadian ICES-003.

IMPORTANT

Please record the serial number of this unit in the space below.
Model:
Serial No.:
The serial number is located on the rear of the unit.
Retain this Owner's Manual in a safe place for future reference.

For RAV-2000Z1

- 1 To assure the finest performance, please read this manual carefully. Keep it in a safe place for future reference.
- 2 To avoid failure, do not spill liquid on the remote control.
- 3 Be sure to read the “Troubleshooting” section on common operating errors before concluding that the remote control is faulty.

FOR CANADIAN CUSTOMERS

This Class B digital apparatus complies with Canadian ICES-003.

IMPORTANT

Please record the serial number of this unit in the space below.
Model:
Serial No.:
The serial number is located inside the battery compartment.
Retain this Owner's Manual in a safe place for future reference.

COMPLIANCE INFORMATION STATEMENT

(DECLARATION OF CONFORMITY PROCEDURE)

Responsible Party: Yamaha Electronics Corp.,
 Address: 6660 Orangethorpe Ave.
 Buena Park, CA90620
 Telephone: 714-522-9105
 Type of Equipment: Remote Control
 Model Name: RAV-2000Z1

This device complies with Part 15 of the FCC Rules.

Operation is subject to the following conditions:

- 1) this device may not cause harmful interference, and
- 2) this device must accept any interference received including interference that may cause undesired operation.

See the user manual instructions if interference to radio reception is suspected.

FCC INFORMATION (U.S.A)

1. IMPORTANT NOTICE: DO NOT MODIFY THIS UNIT!

This product, when installed as indicated in the instructions contained in this manual, meets FCC requirements. Modifications not expressly approved by Yamaha may void your authority, granted by the FCC, to use the product.

- 2. IMPORTANT:** When connecting this product to accessories and/or another product use only high quality shielded cables. Cable/s supplied with this product **MUST** be used. Follow all installation instructions. Failure to follow instructions could void your FCC authorization to use this product in the USA.

- 3. NOTE:** This product has been tested and found to comply with the requirements listed in FCC Regulations, Part 15 for Class "B" digital devices. Compliance with these requirements provides a reasonable level of assurance that your use of this product in a residential environment will not result in harmful interference with other electronic devices.

This equipment generates/uses radio frequencies and, if not installed and used according to the instructions found in the users manual, may cause interference harmful to the operation of other electronic devices.

Compliance with FCC regulations does not guarantee that interference will not occur in all installations. If this product is found to be the source of interference, which can be determined by turning the product "OFF" and "ON", please try to eliminate the problem by using one of the following measures:

Relocate either this product or the device that is being affected by the interference.

Utilize power outlets that are on different branch (circuit breaker or fuse) circuits or install AC line filter/s. In the case of radio or TV interference, relocate/reorient the antenna. If the antenna lead-in is 300 ohm ribbon lead, change the lead-in to coaxial type cable.

If these corrective measures do not produce satisfactory results, please contact the local retailer authorized to distribute this type of product. If you can not locate the appropriate retailer, please contact Yamaha Electronics Corp., 6660 Orangethorpe Ave. Buena Park, CA90620.

The above statements apply **ONLY** to those products distributed by Yamaha Corporation of America or its subsidiaries.

Contents

INTRODUCTION	3
Features	4
Controls and functions	6
PREPARATIONS	13
Speaker system configurations	14
Speaker placement	16
Connections	18
On-screen displays (OSD)	33
Speaker mode settings	34
Speaker output levels	38
BASIC OPERATIONS	41
Basic playback	42
Basic recording	50
ADVANCED OPERATION	51
Set menu items	52
Remote control features	64
Adjusting the levels of the effect speakers	81
Sleep timer	82
Zone 2	83
SOUND FIELD PROGRAMS	85
Digital sound field processing (DSP)	86
Hi-Fi DSP-sound field program	88
CINEMA-DSP sound field program	90
Sound field program parameter editing	95
Digital sound field parameter descriptions	96
APPENDIX	101
Troubleshooting	102
CINEMA EQ frequency characteristics	105
Reference chart for the input and output jacks	106
Specifications	107

CHECKING THE PACKAGE CONTENTS

Check your package to make sure it has the following items.

RAV-2000Z1
Intelligent remote control



Batteries (4) (LR6)

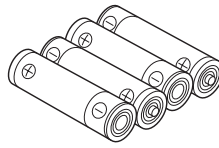

Power cord

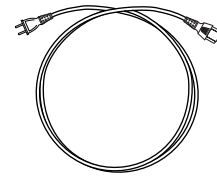

Computer interface cable
(RS-232C)

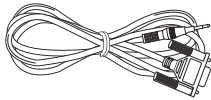

AM loop antenna



Indoor FM antenna

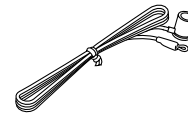

Introduction

This section describes the features of the RX-Z1, and its controls and functions.

FEATURES 4

CONTROLS AND FUNCTIONS 6

Front panel	6
Remote control	8
Front panel display	11
Rear panel	12

FEATURES

■ Built-in 8-channel power amplifier

- Main: 130 W + 130 W (8Ω) RMS Output Power, 0.015% THD, 20 – 20,000 Hz
- Center: 130 W (8Ω) RMS Output Power, 0.015% THD, 20 – 20,000 Hz
- Rear: 130 W + 130 W (8Ω) RMS Output Power, 0.015% THD, 20 – 20,000 Hz
- Front: 45 W + 45 W (8Ω) RMS Output Power, 0.05% THD, 1 kHz
- Rear center: 130 W (8Ω) RMS Output Power, 0.015% THD, 20 – 20,000 Hz

■ Digital Sound Fields (DSP)

Technological advances in sound reproduction over the last 30 years have enhanced the listening experience with improved clarity, precision, and power. However, something has been missing: the atmosphere and acoustic ambience of the public venue. Our Yamaha engineers have extensively researched the nature of sound acoustics and the way sound reflects inside a room. We sent these engineers to famous theaters and concert halls around the world to measure the acoustics of those venues with sophisticated microphones. The data they collected is used to recreate these environments in digital sound fields. Some of these digital sound fields have been created using data measured at the original venue; others have been created from combinations of data to form unique environments for specific purposes. Some have been designed especially for music, and others especially for movies. Of course, this only solves half of the problem. Because these engineers have no way of knowing the acoustics of your entertainment room, we have made it possible for you to adjust the various parameters of this data to tailor each virtual venue to your taste. You can use these sound fields to enhance any source and in combination with any of the following surround sound technologies.

■ CINEMA-DSP: Dolby Digital + DSP and DTS + DSP

The Dolby Digital system and DTS system show their full capability in large movie theaters, because feature film soundtracks are designed to be reproduced in such environments. It is difficult to recreate a sound environment similar to a movie theater in your entertainment room because of the room size, wall materials, and the number of speakers in your entertainment system. Yamaha DSP technology makes it possible for you to enjoy nearly the same sound experience as that of a large movie theater in your entertainment room by compensating for lack of presence and dynamics in your entertainment room with Yamaha's original digital sound fields combined with Dolby Digital or DTS soundtracks.

■ Virtual CINEMA DSP and SILENT CINEMA DSP

Yamaha developed the Virtual CINEMA DSP algorithm which allows you to experience the virtual sound fields without surround speakers. This makes it possible for the RX-Z1 to produce a full surround sound catering to the number of speakers you have. The RX-Z1 also has a SILENT CINEMA DSP algorithm which is achieved by the crosstalk processing applying the precise Head Related Transfer Function. You can therefore enjoy listening to the CINEMA DSP soundfields on headphones.

■ Various decoders to support the newest sound effect technology

This unit is equipped with the following signal format decoders.



• Dolby Digital and Dolby Digital EX

The Matrix decoder enables 6.1-channel playback of the 5.1-channel sources by extracting the rear center channel signals from the rear L/R channel signals.

• DOLBY PRO LOGIC

• DOLBY PRO LOGIC II

DOLBY PRO LOGIC II is the improved technique to decode vast numbers of existing Dolby Surround programs. This new technology enables a discrete 5-channel playback with two left and right main channels, a center channel, and two left and right rear channels compared with one limited rear channel for the conventional Pro Logic technology. Also the music mode is available for 2-channel sources in addition to the movie mode.



• DTS and DTS ES

The RX-Z1 is also equipped with a DTS decoder, which uses a 5.1-channel system to create a full surround sound environment. It was developed as a way to replace the analog soundtracks of movies with six channels of digital sound. In comparison with Dolby Digital, DTS uses less compression to store the sound information. The newly presented DTS ES system reproduces digital sound similar to Dolby Digital EX. The use of the rear center speaker along with the existing 5.1-channel speakers provides a fully immersive cinematic audio experience.

• DTS Neo: 6

Neo: 6 decodes the conventional 2-channel sources for 6-channel playback by the specific decoder. It enables playback with the full-range channels with higher separation just like digital discrete signal playback. Two modes are available; "Music mode" for playing music sources and "Cinema mode" for movies.

• DTS 96/24

DTS 96/24 achieves the high quality playback with all 5.1 channels at the sampling frequency 96 kHz/24 bit.

■ Various input and output jacks

The RX-Z1 has various output jacks for audio and video signals as well as a digital recording output jack. Many input jacks are also available for connection to multiple audio-video sources. All the video inputs and outputs have S-video jacks in addition to standard composite video jacks for improved video picture quality. Component video input and output jacks are also available to deliver the excellent video signals from DVD players and other high quality video sources. The coaxial and optical digital signal jacks (provided for direct transmission of digital signals) automatically detect Dolby Digital, DTS, and PCM signals. A demodulator circuit is built into the Dolby Digital RF input so you can connect it directly to the Dolby Digital RF signal output on your LD player. Additionally, there are six audio inputs for discrete multichannel reproduction from an external decoder.

The RX-Z1 also comes with a monaural subwoofer jack and split subwoofer jacks which can reproduce delicate but powerful low frequency effects.

■ Intelligent remote control

The intelligent remote control can be used with most components that understand infrared (IR) remote control signals. Its easy-to-use touch screen and its intuitive interface make it the perfect remote control for every user.

The remote control (RC) is completely customizable. In the memory of the remote control, RC codes are stored to activate different brands of all kinds of video and audio components. The remote control is set up by default to operate with YAMAHA components. If you have other brands, you simply define the brands of your components when you use the remote control for the first time.

The remote control can also learn RC codes from existing remote controls. It is designed to add components and functions, relabel buttons, record macros and set timers. With the RAVedit software you create your own control panels and define your personal look.



Manufactured under license from Dolby Laboratories.

“Dolby”, “Pro Logic”, and the double-D symbol are trademarks of Dolby Laboratories.



“DTS”, “DTS-ES Extended Surround” and “Neo: 6” are trademarks of Digital Theater System, Inc.

CONTROLS AND FUNCTIONS

Front panel

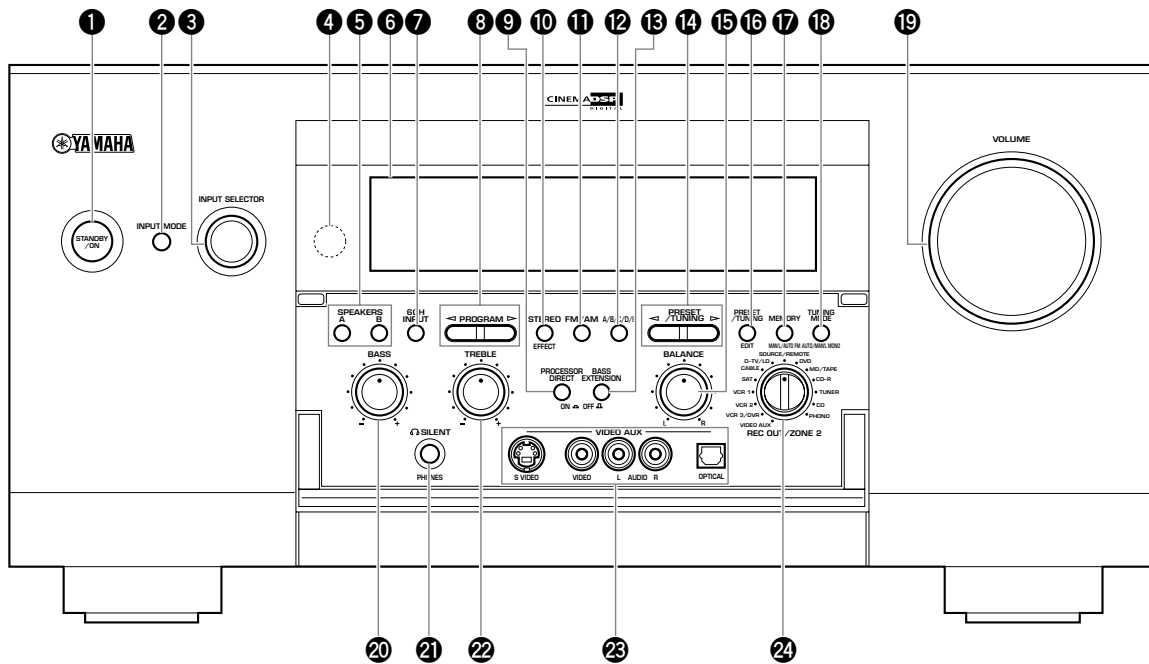

1 STANDBY/ON

Turns this unit on (On mode) and off (Standby mode). When you turn on this unit, you will hear a click and there will be a 4 to 5-second delay before this unit can reproduce sound. In Standby mode, this unit consumes a small amount of power so it can respond to the remote control.

2 INPUT MODE

Selects the mode of input for sources that output two or more types of signals to this unit (see page ___).

Caution

- You cannot control the input mode when you select **6CH INPUT** as the input source.

3 INPUT SELECTOR

Selects the input source (**D-TV/LD, CABLE, SAT, VCR 1, VCR 2, VCR3/DVR, V-AUX, DVD, MD/TAPE, CD-R, TUNER, CD, PHONO**) you want to listen to or watch (see page ___).

4 Remote control sensor

Receives signals from the remote control.

5 SPEAKERS A/B

When pushed in (ON), these buttons turn on the set of main speakers connected to the **A** and/or **B** terminals on the rear panel.

6 Front panel display

Shows information about the operational status of this unit (see page ___).

7 6CH INPUT

Switches between 6CH INPUT mode and normal input modes. 6CH INPUT mode takes priority over the source selected with **INPUT SELECTOR**.

You cannot use DSP sound field programs while using an external decoder.

8 PROGRAM </>

Selects the sound field program (see page ___). Selecting a sound field program turns on the effect.

9 PROCESSOR DIRECT ON/OFF

When pushed in (ON), **BASS, TREBLE, BALANCE, and BASS EXTENSION** are bypassed, eliminating any alteration of the original signal.

10 STEREO/EFFECT

Switches the effect speakers (center, front effect, rear and rear center) on and off. If you turn off the output of these speakers using **STEREO/EFFECT**, all DTS and Dolby Digital audio signals are directed to the main left and right channels except for the LFE channel.

Cautions

- When DTS or Dolby Digital signals are mixed, the left and right main channel signal levels may not match.
- If "1B MAIN SP" on the SET MENU is set to "SMALL" and "1E LFE/BASS OUT" is set to "SW", or "1E LFE/BASS OUT" is set to "BOTH", the LFE signals will be output from the subwoofer.

11 FM/AM

Switches the reception band between FM and AM.

12 A/B/C/D/E

Selects one of the 5 preset station groups (A to E).

13 BASS EXTENSION ON/OFF

When pushed in (ON), this feature boosts the bass frequency of the left and right main channels by +6 dB (60 Hz) while maintaining overall tonal balance. This boost is useful if you do not use a subwoofer.

However, this boost may not be noticeable if the main speakers are set to "SMALL" and the bass output mode is set to "SW."

14 PRESET/TUNING </>

Selects preset station number 1 to 8 when the colon (:) appears on the left of the band indication (“FM” or “AM”) on the front panel display, and selects the tuning frequency when the colon (:) does not appear.

15 BALANCE

Controls the balance of the sound levels coming from the left and right main speaker(s). Setting this control to the center position is appropriate for most situations.

16 PRESET/TUNING EDIT

Switches the function of **PRESET/TUNING** </> (the colon (:)) turns on or off) between selecting a preset station number and tuning.

This button is also used to exchange the assignment of two preset stations with each other.

17 MEMORY (MAN'L/AUTO FM)

Stores a station in the memory. Hold down this button for more than 3 seconds to start automatic presetting stations.

18 TUNING MODE (AUTO/MAN'L MONO)

Switches the tuning mode between automatic and manual. To select the automatic tuning mode, press this button so that the “AUTO” indicator lights up on the front panel display. To select the manual tuning mode, press this button so that the “AUTO” indicator does not light up.

19 VOLUME

Controls the output level of all audio channels. This does not affect the REC OUT level.

20 BASS

Adjusts the low frequency response for the left and right main speaker channels.

Turn the control to the right to increase the low frequency response and turn the control to the left to decrease the low frequency response.

Caution

- If you increase or decrease the low frequency sound to an extreme level, the tonal quality from the center, front effect, rear center, and rear speakers may not match that of the left and right main speakers.

21 PHONES

Outputs audio signals for private listening using headphones.

Cautions

- When you connect headphones, no signals are output to the **PREOUT** jacks or the speakers.
- When the signal input into the **6CH INPUT** jack is being played back, only the left and right channel signals are output through the headphones.

22 TREBLE

Adjusts the high frequency response for the left and right main channels.

Turn the control to the right to increase the high frequency response and turn the control to the left to decrease the high frequency response.

Caution

- If you increase or decrease the high frequency sound to an extreme level, the tonal quality from the center, front effect, rear center, and rear speakers may not match that of the left and right main speakers.

23 VIDEO AUX

Inputs audio and video signals from a portable external source such as a video camera.

24 REC OUT/ZONE 2

Selects the source you want to direct to the audio/video recorder and **ZONE 2** outputs independent of the source you are listening to in the main room. When set to the **SOURCE/REMOTE** position, the input source is directed to all outputs.

Opening and closing the front panel door

When you are not operating the controls behind the front panel door, close the door.

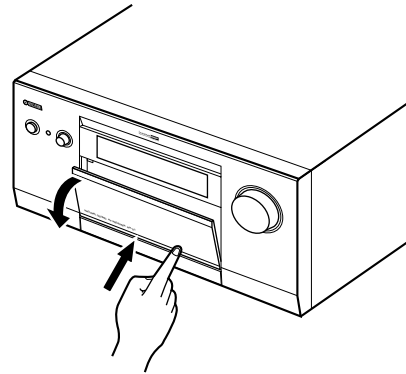

Remote control

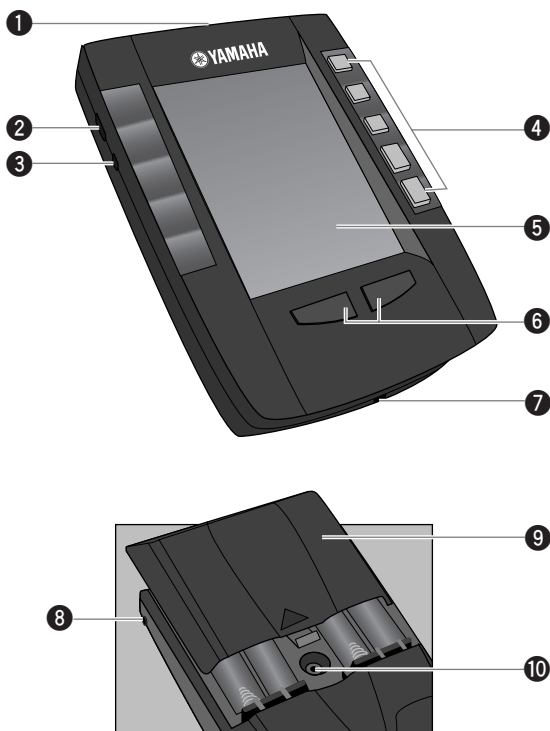

1 Sending eye

Outputs infrared (IR) remote control signals. Aim this at the component you want to operate.

2 CONTRAST +/-

Adjust the contrast of the display.

3 BACKLIGHT

Turns the backlight on.

4 Direct-access buttons

- **POWER:** Turns on the power of this unit.
- **STANDBY:** Sets this unit in the standby mode.
- **MUTE:** Mutes the sound. While the mute function is on, "MUTE ON" appears on the front panel display.
- **VOL +/-:** Increases or decreases the volume level.

5 Touch screen

6 Left/right buttons

Depending on the components the remote control is operating, these buttons change function. The current function is displayed on the touch screen right above the button.

7 Learning eye

Receives RC codes from existing remote controls.

8 I/O (Serial port)

See page __ for information.

9 Battery door

10 RESET

See page __ for information.

■ Display on the touch screen

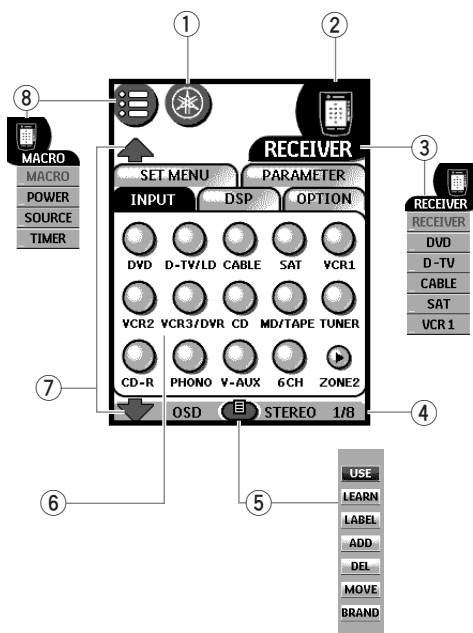

1 Home

To go to the Home menu.

2 Remote control icon

Touch and hold to enter Setup.

3 Device menu

To open control panel of components.

4 Panel number

Shows active control panel.

5 Mode menu

To customize the remote control.

6 Control panel

To send commands to components.

7 Scroll buttons

To display previous/next control panel.

8 Macro menu

To open stored list of commands.

■ Installing batteries in the remote control

- 1 Slide the battery door off the back of the remote control.

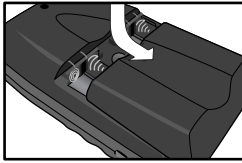

- 2 Insert 4 supplied batteries as indicated on the bottom of the battery compartment.

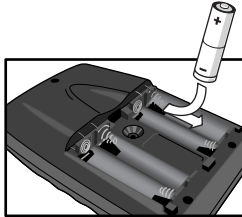

- 3 Slide the battery door back on.

After a few seconds, the remote control set up automatically and beeps twice to indicate that it is ready to use.

Cautions

- Insert the batteries in the correct direction by aligning the + and – marks on the batteries with the polarity illustrations (+ and –) inside the battery compartment.
- Change the batteries periodically.
- Do not use old batteries together with new ones.
- Do not use different types of batteries (such as alkaline and manganese batteries) together. Read the packaging carefully as these different types of batteries may have the same shape and color.
- Do not use rechargeable batteries.
- If the batteries have leaked, dispose of them immediately. Avoid touching the leaked material or letting it come into contact with clothing, etc. Clean the battery compartment thoroughly before installing new batteries.

■ About changing batteries

When batteries are running low, the low battery icon  flashes at the center top of the display. Replace the batteries as soon as possible to ensure perfect performance.

Note

- The remote control retains all settings when the batteries have discharged or when you remove and replace them. You will need only to reset the clock.

■ Using the remote control

The remote control transmits a directional infrared beam. Be sure to aim the remote control directly at the remote control sensor on the main unit during operation.

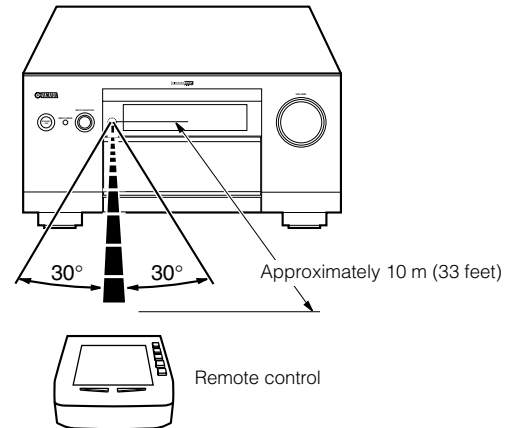

Cautions

- When the sensor is covered or there is a large object between the remote control and the main unit, the sensor cannot receive signals.
- The sensor may not be able to receive signals properly when it is exposed to direct sunlight or a strong artificial light (such as a fluorescent or strobe light). In this case, change the direction of the light or reposition the main unit to avoid direct lighting.
- Handle the remote control with care.
- Do not spill water or other liquids on the remote control.
- Do not drop the remote control.
- Do not leave or store the remote control in the following types of conditions:
 - ① high humidity or temperature such as near a heater, stove or bath
 - ② dusty places
 - ③ in places subject to extremely low temperatures

■ Turning on the display

Tap the screen gently with your finger or a blunt, soft object like a pencil eraser.

The display is activated and the Home menu appears.

Tap the screen gently.

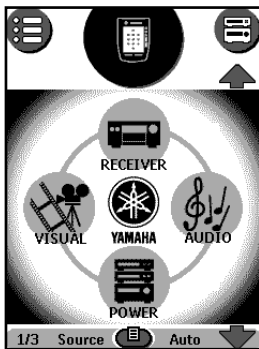

The Home menu appears.

Notes

- If the display stays blank or becomes black, adjust the contrast using **CONTRAST +/-** on the left side of the remote control.
- If another panel is displayed, tap the Home button.
- The remote control shuts down automatically.

■ Using the backlight

Press **BACKLIGHT** on the left side of the remote control. The backlight shuts off after a few seconds to save power.

Note

- In the settings, you can choose to activate the backlight automatically when you turn on the remote control (see page __).

■ Activating modes

The remote control has different modes.

When controlling components, the remote control should be set to Use mode. If a label (like **BRAND** or **LEARN**) appears at the center top of the touch screen, see page __ for information or switching your remote control to the Use mode.

■ Using touch screen buttons

1. Sending commands

By tapping the touch screen buttons you send commands to the components you have selected. When you send a command, the remote control icon indicates that it is transmitting signals . The name of the active components is indicated on the device tab.

2. Scrolling

Most components have more than one control panel. You can scroll through these control panels using and . The panel number on the left (or right) bottom of the screen indicates the active panel number and the total number of panels, for example **1/5**.

By holding down a scroll button, you cycle repeatedly through all the control panels of a component.

■ Using the left/right buttons

The left/right buttons change function depending on the component the remote control is operating. The current function is displayed on the touch screen right above the button. The function can be an IR command which is transmitted, or a jump to a specific component page.

■ Using the direct-access buttons

You can operate this unit with the direct-access buttons (**POWER**, **STANDBY**, **MUTE** and **VOL +/-**) at any time, even without turning on the touch screen.

Front panel display

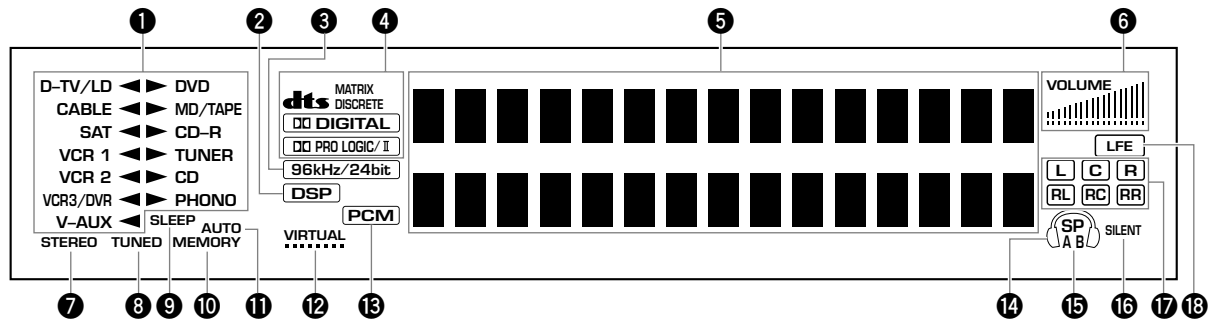

1 Input source indicator

Shows the current input source with the arrow-shaped cursor.

2 DSP indicator

Lights up when you select a digital sound field program.

3 96kHz/24bit indicator

Lights up when the DTS 96/24 signal is input to this unit.

4 Processor indicators

When any function of DTS, MATRIX, DISCRETE, DIGITAL, and PRO LOGIC/II is activated, its indicator lights up.

5 Multi-information display

Shows the current DSP program and other information when adjusting or changing settings.

6 VOLUME level indicator

Indicates the volume level.

7 STEREO indicator

Lights up when this unit is receiving a strong signal for an FM stereo broadcast while the "AUTO" indicator is lit.

8 TUNED indicator

Lights up when this unit tunes in to a station.

9 SLEEP indicator

Lights up while the sleep timer is on.

10 MEMORY indicator

Flashes to show a station can be stored.

11 AUTO indicator

Shows that this unit is in the automatic tuning mode.

12 VIRTUAL indicator

Lights up when using Virtual CINEMA DSP (see page __).

13 PCM indicator

Lights up when this unit is reproducing PCM (Pulse Code Modulation) digital audio signals.

14 Headphones indicator

Lights up when headphones are connected.

15 SPEAKERS A/B indicator

Lights up according to which set of main speakers are selected. Both indicators light up when both sets of speakers are selected.

16 SILENT indicator

Lights up when headphones are connected with the sound effect (see "SILENT CINEMA DSP" on page __).

17 Input channel indicator

Indicates the channel components of input signals being received.

18 LFE indicator

Lights up when the input signal contains the LFE signal.

Rear panel

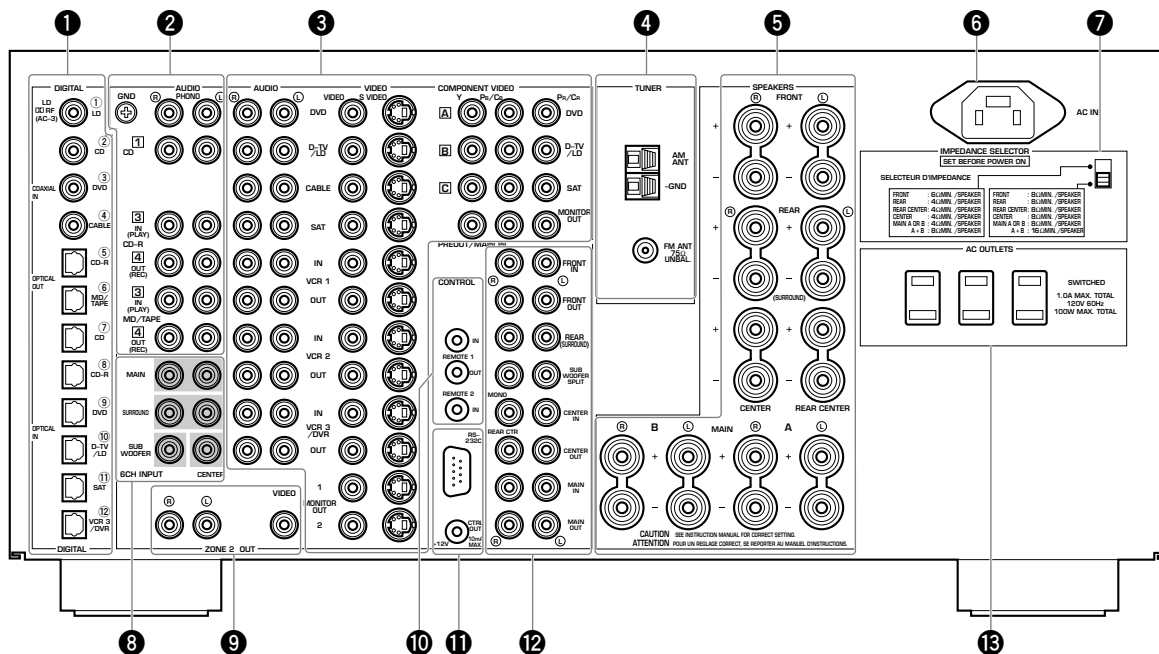

1 DIGITAL OPTICAL/COAXIAL jacks

See page __ for detailed information.

2 Audio component jacks

See pages __ and __ for connection information.

3 Video component jacks

See pages __ and __ for connection information.

4 Antenna input terminals

See page __ for connection information.

5 Speaker terminals

See pages __ and __ for connection information.

6 AC IN

Use this inlet to plug in the supplied power cord.

7 IMPEDANCE SELECTOR

Use this switch to match the amplifier output to your speaker impedance. Turn off the power before you change the setting of this switch (see page __).

8 6CH INPUT jacks

See page __ for connection information.

9 ZONE 2 OUT jacks

See page __ for connection information.

10 REMOTE 1 IN/OUT/REMOTE 2 IN jacks

See page __ for connection information.

11 RS-232C/CTRL OUT +12V terminals

These are control expansion terminals for commercial use. Consult your dealer for details.

12 PREOUT/MAIN IN jacks

See page __ for connection information.

13 AC OUTLETS

Use these outlets to supply power to your other audio/video component.

Preparations

This section explains how to make preparations (speaker selection and placement, subwoofer usage, connection with other components, speaker mode setting, and speaker level adjustment) to fully use the RX-Z1.

SPEAKER SYSTEM CONFIGURATIONS	14
SPEAKER PLACEMENT	16
CONNECTIONS	18
Before connecting components	18
Connecting digital jacks	19
Connecting audio components	19
Connecting video components	21
Connecting speakers	29
Connecting other components	31
Connecting the power supply cords	32
ON-SCREEN DISPLAYS (OSD)	33
OSD modes	33
Selecting the OSD mode	33
SPEAKER MODE SETTINGS	34
SPEAKER OUTPUT LEVELS	38
TEST DOLBY SUR.	39
TEST DSP	40

SPEAKER SYSTEM CONFIGURATIONS

The most complete speaker configuration consists of eight speakers: the left and right main speakers, a center speaker, the left and right rear speakers, the left and right front effect speakers, and a rear center speaker. If you do not use eight speakers, you can direct the signals for speakers that are not in your system to other speakers in your configuration. A subwoofer can be used with any of these configurations to produce a fuller sound.

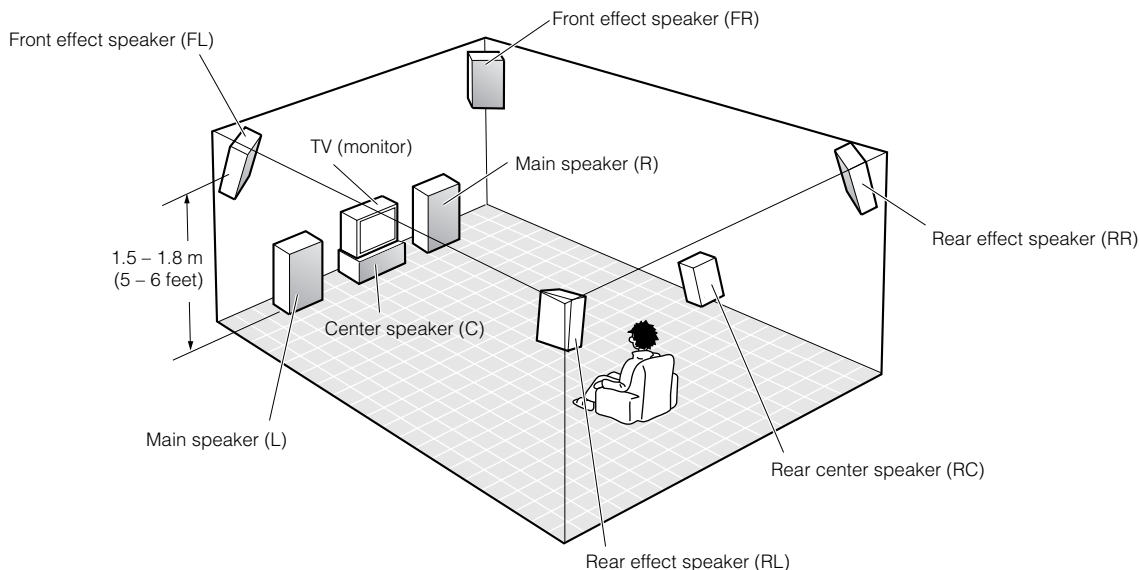

■ 8-speaker configuration –full CINEMA-DSP–

When you reproduce feature film software, this configuration fully expresses the powerful and realistic sound qualities of 70 mm multitrack audio. The dialogue is positioned as if it were coming from directly on the screen, the sound effect is positioned slightly behind the screen, and the soundtrack music is positioned even further behind the screen to express the width and depth of the overall presentation. This configuration makes the most of this unit's capability.

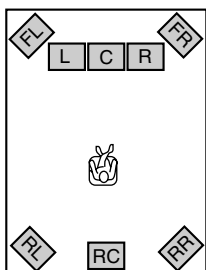

Speakers to be used

- Main L/R
- Center
- Rear L/R
- Front effect L/R
- Rear center

■ 6-speaker configuration –Hi-Fi DSP–

This configuration is used the most for audio playback with Hi-Fi DSP. It does not position the dialogue sound as well as a 7- or 8-speaker configuration. However, it creates a dynamic DSP (Digital Sound Field Processor) sound field which adds depth to the sound. For this speaker configuration, change SET MENU item "1A CENTER SP" to "NONE" and "1D REAR CT SP" to "NONE".

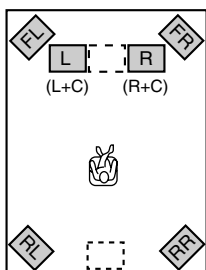

Speakers to be used

- Main L/R
- Rear L/R
- Front effect L/R

5-speaker configuration –standard 5.1 channel–

This configuration does not express the height of the sound field as well as the 7- or 8-speaker configuration. However, it positions the dialogue sound as coming directly from the screen.

For this speaker configuration, change SET MENU item “1F FRONT EFCT SP” to “NONE” and “1D REAR CT SP” to “NONE”.

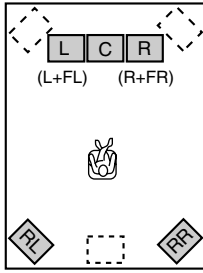

Speakers to be used

- Main L/R
- Center
- Rear L/R

4-speaker configuration –minimum requirement–

In this configuration, the center speaker signals and front effect speaker signals are directed to the left and right main speakers.

For this speaker configuration, change SET MENU item “1A CENTER SP” to “NONE”, item “1F FRONT EFCT SP” to “NONE”, and item “1D REAR CT SP” to “NONE”.

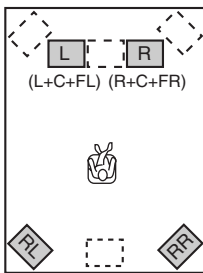

Speakers to be used

- Main L/R
- Rear L/R

Speaker configurations and speaker mode

Select the appropriate speaker mode depending on the speaker configuration. See “SPEAKER MODE SETTINGS” on page __ for details.

	8 speakers	7 speakers	6 speakers	5 speakers	4 speakers
1A CENTER SP (Center)	LRG/SML	LRG/SML	NONE	LRG/SML	NONE
1B MAIN SP (Main L/R)	LARGE/SMALL	LARGE/SMALL	LARGE/SMALL	LARGE/SMALL	LARGE/SMALL
1C REAR L/R SP (Rear L/R)	LRG/SML	LRG/SML	LRG/SML	LRG/SML	LRG/SML
1D REAR CT SP (Rear center)	LRG/SML	NONE	NONE	NONE	NONE
1F FRONT EFCT SP (Front effect L/R)	YES	YES	YES	NONE	NONE

Note

- As a guideline, select “LARGE” for the larger speaker diameter than 16 cm, and “SMALL” for the smaller speaker diameter than 15 cm. Change the speaker mode setting as listening to the actual playback sound if it does not meet your expectation.

SPEAKER PLACEMENT

Refer to the following diagram when you place the speakers.

Caution

- Use magnetically shielded speakers. If this type of speakers still creates the interference with a monitor, place the speakers away from the monitor.

■ Placing the main speakers

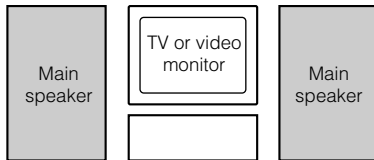

Place the left and right main speakers an equal distance from the main listening position. If you have a TV or video monitor in your system, the distance of each speaker from each side of the TV or video monitor should be the same.

■ Placing the center speaker

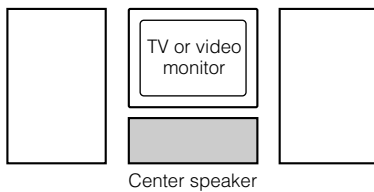

If you have a TV or video monitor in your system, align the front face of the center speaker with the front face of the monitor. Place the speaker as close to the monitor as possible, such as directly over or under the monitor. If you place the speaker under the monitor, the front effect speakers can adjust the height of the sound to correspond with the action on the screen (depending on the listener's position). If you have a projection screen in your system, place the center speaker under the screen. Be sure to align the speaker with the center of the screen.

■ Placing the front effect, rear and rear center speakers

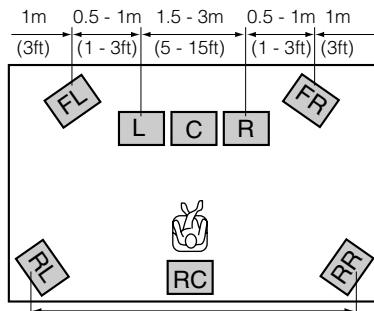

This distance can be farther than the front effect speakers.

These speakers should be placed about 0.5 – 1 m (1 – 3 feet) outside the main speakers and in the front of the room. They should be turned toward the main listening position. Place the rear speakers in the back of the room so they face the main listening position. The rear speakers can be placed farther apart than the front effect speakers. Place these speakers at the height of 1.5 m when listening as sitting on the floor or 1.8 m when listening as sitting on the chair.

Once you begin listening to programs, continue to adjust the speaker placement until you obtain a balanced sound from the main speakers and the front effect and rear speakers.

■ When you use a projection screen

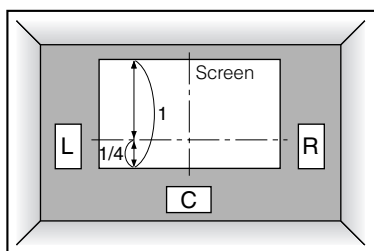

Place the speakers as shown in the illustration.

The main speakers should be placed about one-quarter of the way up from the bottom of the screen.

Place the center speaker in the center and directly under the screen. The center speaker provides precise dialogue localization.

When you use a projection screen with your system, the front effect speakers provide better effect quality. The CINEMA-DSP sound field programs (see pages __ to __) raise the sound from the center speaker upward and provide natural sound corresponding with the video images.

■ Placing the subwoofers

Place the front subwoofer near the main speakers. Turn it slightly toward the center of the room to reduce wall reflections.

If you use a rear subwoofer, place it behind the main listening position. The placement of the rear subwoofer is not critical because of the ultra low frequencies of the sound being reproduced.

By adding a high quality subwoofer to the speaker configurations shown on page __, you can enjoy more powerful and realistic movie effects, even if your main speakers are large.

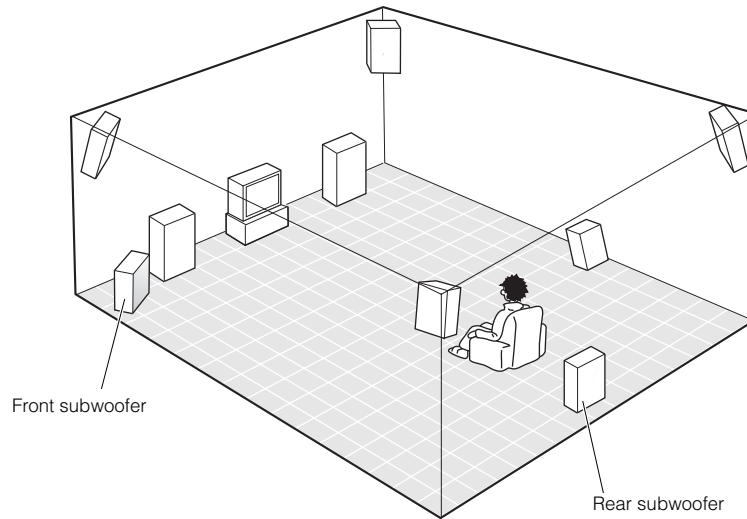

Note

- If you use different brands of speakers (with different tonal qualities) in your configuration, the tone of a moving human voice and other types of sound may not shift smoothly. We recommend that you use speakers from the same manufacturer or speakers with the same tonal quality.

You can also adjust the output levels and equalization of your effect speakers using the SET MENU (see pages __ and __).

If you are using small speakers, the addition of a subwoofer will reinforce the sound effects of movies.

CONNECTIONS

Before connecting components

CAUTION

Never connect this unit and other components to mains power until all connections between components have been completed.

- Some components require different connection methods and have different jack names. Refer to the operation instructions for each component also.
- Input and output jacks for the pin jacks are color-coded depending on the signal type.
- When connecting input and output jacks, use commercially available cables (pin-plug cable, fiber-optic cable, coaxial cable and S-Video cable).
- When this unit interferes with the other components, replace this unit apart from those components. To prevent the interference with other components, it is recommended that an external antenna is placed and coaxial cables are used for connections.

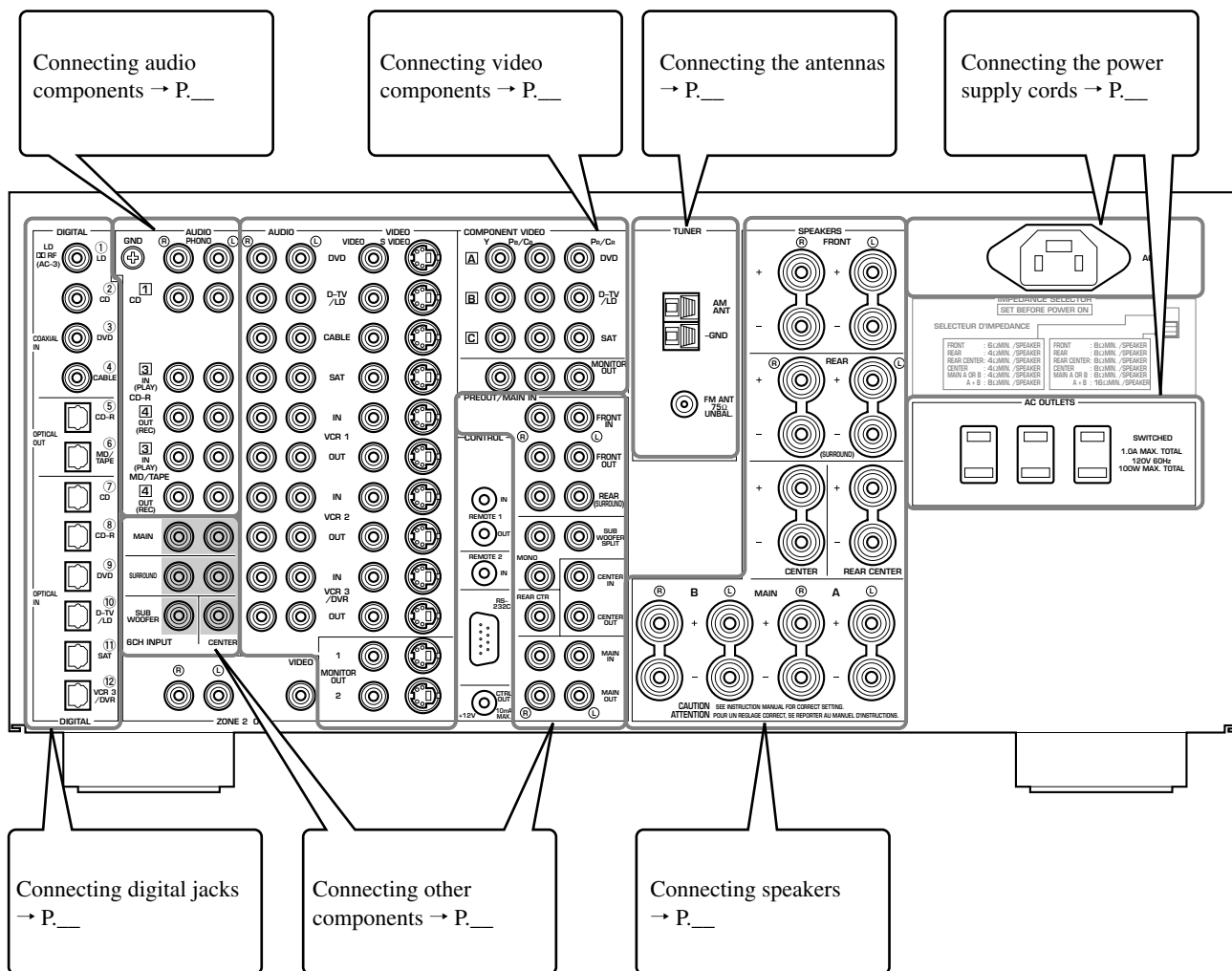

Connecting digital jacks

This unit has digital jacks for direct transmission of digital signals through either coaxial or fiber optic cables.

Notes

- **DIGITAL OUTPUT** jacks and analog **OUT (REC)** jacks are independent. Only digital signals are output from **DIGITAL OUTPUT** jacks and analog signals from **OUT (REC)** jacks.
- You can use the digital jacks to input PCM, Dolby Digital and DTS bitstreams.
- When you connect components to both the **COAXIAL** and **OPTICAL** jacks, priority is given to the input signals from the **COAXIAL** jack.
- The **OPTICAL** jacks on this unit conform to the EIA standard. If you use a fiber optic cable that does not conform to this standard, this unit may not function properly.
- You can designate the input for each digital jacks according to your component by using “8 I/O ASSIGNMENT” on the SET MENU (see page __ for details).

Digital input jacks of this unit support the following sampling frequency.

- **32 kHz**
- **44.1 kHz:** CD, CD-R and MD
- **48 kHz:** DVD (48 kHz mode)
- **96 kHz:** DVD (96 kHz mode)
- **192 kHz (coaxial input only):** DVD audio (2-channel)

Connecting audio components

Before you connect any components, disconnect the power supply to all the components you plan to connect including this unit and determine which jacks are for the left and right channels and for input and output.

When you connect other YAMAHA audio component (such as a CD player or changer, MD deck, or tape deck), connect to terminals with the same number labels. Yamaha applies this labelling system to all its products.

■ Connecting a CD recorder

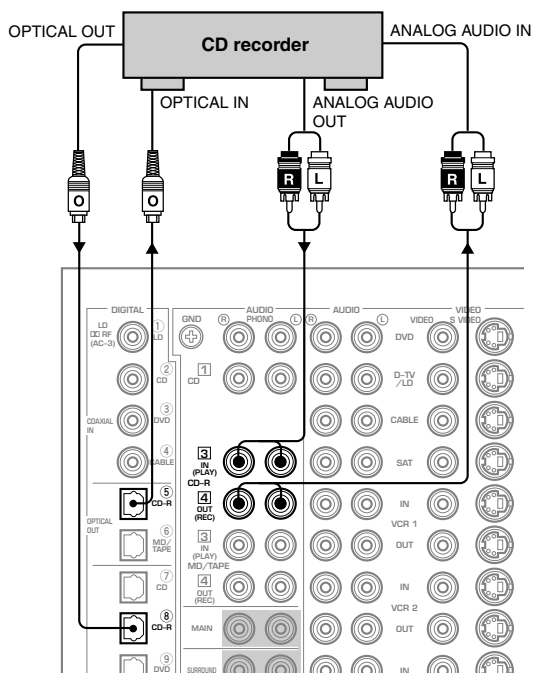

■ Connecting a CD player

The **COAXIAL CD** and **OPTICAL CD** jacks are available for a CD player which has coaxial or optical digital outputs.

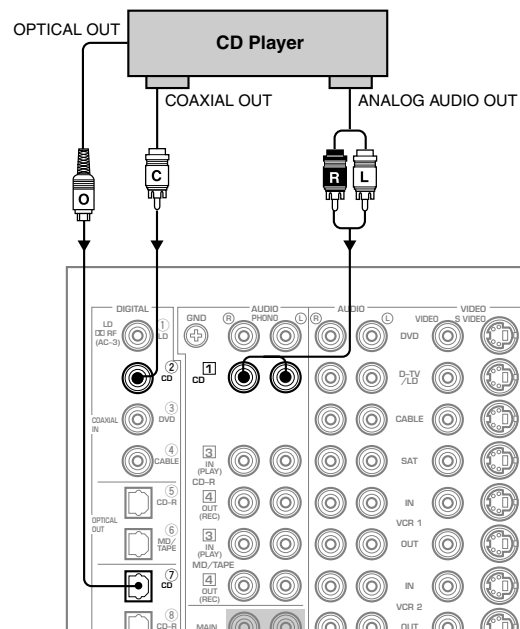

CONNECTIONS

■ Connecting an MD recorder/tape deck

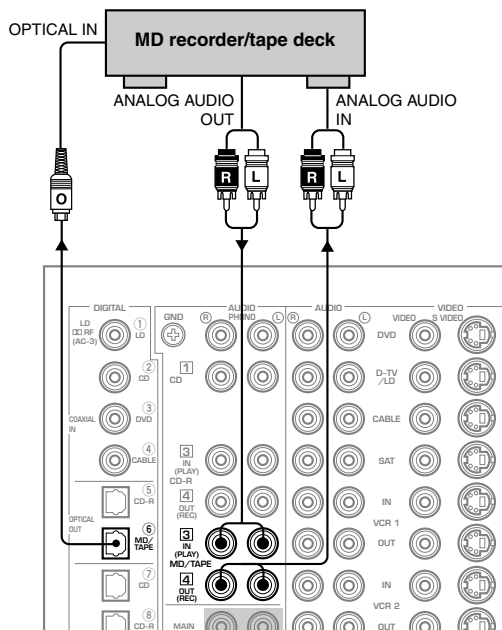

Note

- To connect the OPTICAL (COAXIAL) output jack for an MD recorder with this unit, you can use any of the **OPTICAL (COAXIAL) IN** jacks by changing the setting for "8 I/O ASSIGNMENT" on the SET MENU (see page ___).

■ Connecting a turntable

These jacks are for connecting a turntable with an MM or high output MC cartridge. If you have a turntable with a low output MC cartridge, use an inline boosting transformer or MC-head amplifier when connecting to these jacks.

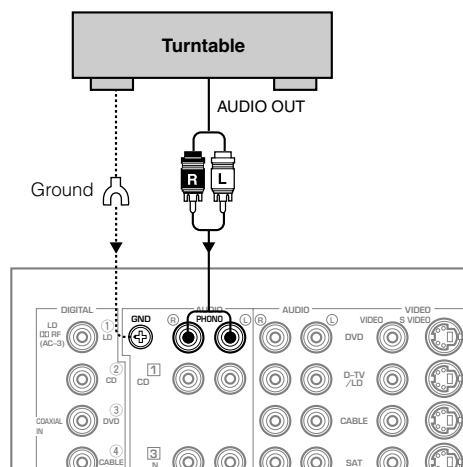

Caution

- The **GND** terminal does not electrically ground the turntable. It simply reduces noise in the signal. In some cases, you may hear less noise if you do not connect to the **GND** terminal.

Connecting the antennas

Both AM and FM indoor antennas are included with this unit. In general, these antennas should provide sufficient signal strength. Connect each antenna correctly to the designated terminals.

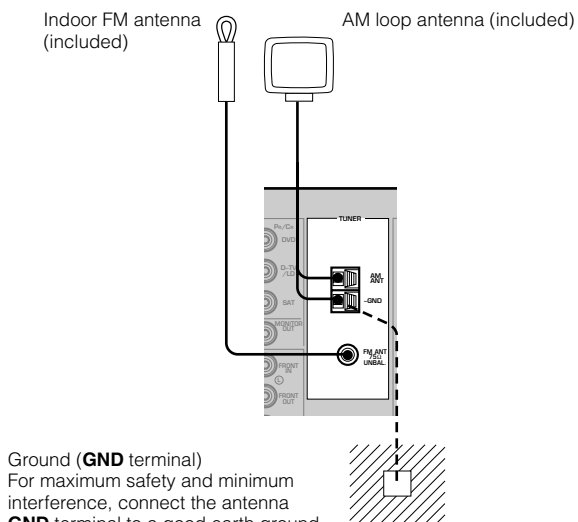

Ground (**GND** terminal)
For maximum safety and minimum interference, connect the antenna **GND** terminal to a good earth ground. A good earth ground is a metal stake driven into moist earth.

A properly installed outdoor antenna provides clearer reception than an indoor one. If you experience poor reception quality, an outdoor antenna may improve the quality. Consult the nearest authorized YAMAHA dealer or service center about the outdoor antennas.

■ Connecting the indoor FM antenna

Connect the included indoor FM antenna to the FM ANT 75Ω UNBAL. terminal.

■ Connecting the AM loop antenna

- 1 Set up the AM loop antenna, then connect it.

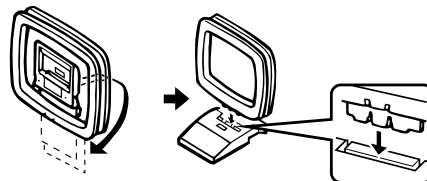

- 2 Press and hold the tab to insert the AM loop antenna lead wires into the AM ANT and GND terminals.



- 3 Orient the AM loop antenna for the best reception.

Notes

- The AM loop antenna should be placed away from this unit.
- The AM loop antenna should always be connected, even if an outdoor AM antenna is connected to this unit.

Connecting video components

Before you connect any components, disconnect the power supply to all the components you plan to connect including this unit and determine which jacks are for the left and right channels and for input and output. After you finish all connections, check them again to make sure they are correct.

About the video jacks

There are three types of video jacks.

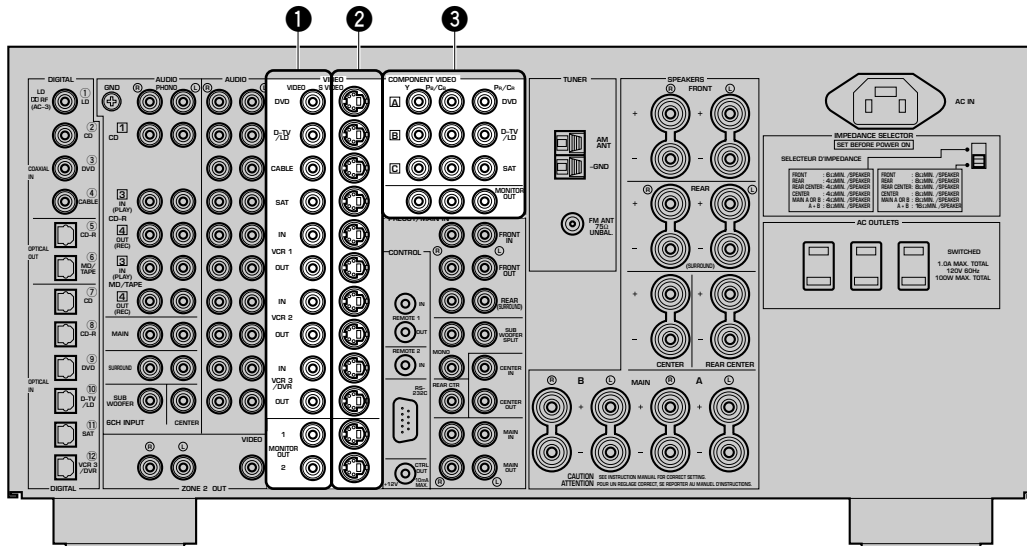

1 Composite VIDEO jack

Video signals input through the **VIDEO** jacks are the conventional composite video signals.

2 S VIDEO jack

Video signals input through the **S VIDEO** jacks are separated into luminance (Y) and color (C) video signals. The S-video signals achieve high quality color reproduction. When you are using the **S VIDEO** jacks, check the details in the owner's manual that came with the component being connected.

3 COMPONENT VIDEO jacks

Video signals input through the **COMPONENT VIDEO** jacks are separated into luminance (Y) and color difference (Pb/Cb, Pr/Cr) video signals. The jacks are also separated into three for each signal. The labels of the component video jacks may be different depending on the component (e.g. Y, Cb, Cr / Y, Pb, Pr / Y, B-Y, R-Y/ etc.). Component video signals provide the best quality in picture reproduction. When you are using the **COMPONENT VIDEO** jacks, check the details in the owner's manual that came with the component being connected.

Cautions

- Use a commercially available S-video cable when connecting to the **S VIDEO** jacks, and commercially available video cables when connecting to the **COMPONENT VIDEO** jacks.
- Each type of video jack works independently. Signals input through the composite video, S-video, and component jacks are output through the corresponding composite video, S-video, and component jacks respectively.
- If your video monitor is connected only to the **COMPONENT VIDEO** jacks of this unit, the OSD is not shown.

Note

- You can designate the input for the **COMPONENT VIDEO A, B** and **C** jacks according to your component by using "8 I/O ASSIGNMENT" on the SET MENU (see page ___ for details).

■ Connecting a DVD player

- Connect the left and right analog signal output jacks on your DVD player to the **DVD L** and **R** jacks. Connect the composite video signal output jack on your DVD player to the **DVD VIDEO** jack.
- If your DVD player has an S-video output or component video output, you can connect it to this unit. Connect the S-video signal output jack on your DVD player to the **DVD S VIDEO** jack or connect the component video signal output jacks on your DVD player to the **DVD COMPONENT VIDEO** jacks.
- Connect the optical digital signal output jack on your DVD player to the **OPTICAL DVD** jack.
- Connect the coaxial digital signal output jack on your DVD player to the **COAXIAL DVD** jack.

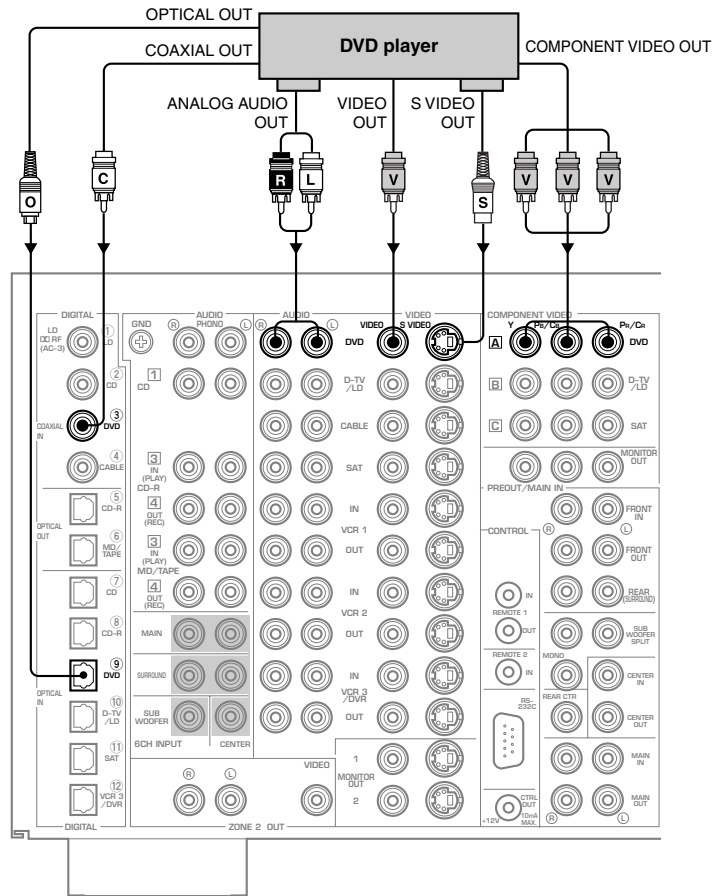

■ Connecting a digital TV/TV

- Connect the left and right analog signal output jacks on your digital TV/TV to the **D-TV/LD** (L) and (R) jacks. Connect the composite video signal output jack on your digital TV/TV to the **D-TV/LD VIDEO** jack.
- If your digital TV/TV has an S-video output or component video output, you can connect it to this unit. Connect the S-video signal output jack on your digital TV/TV to the **D-TV/LD S VIDEO** jack or connect the component video signal output jacks on your digital TV/TV to the **D-TV/LD COMPONENT VIDEO** jacks.
- Connect the optical digital signal output jack on your digital TV/TV to the **OPTICAL D-TV/LD** jack.

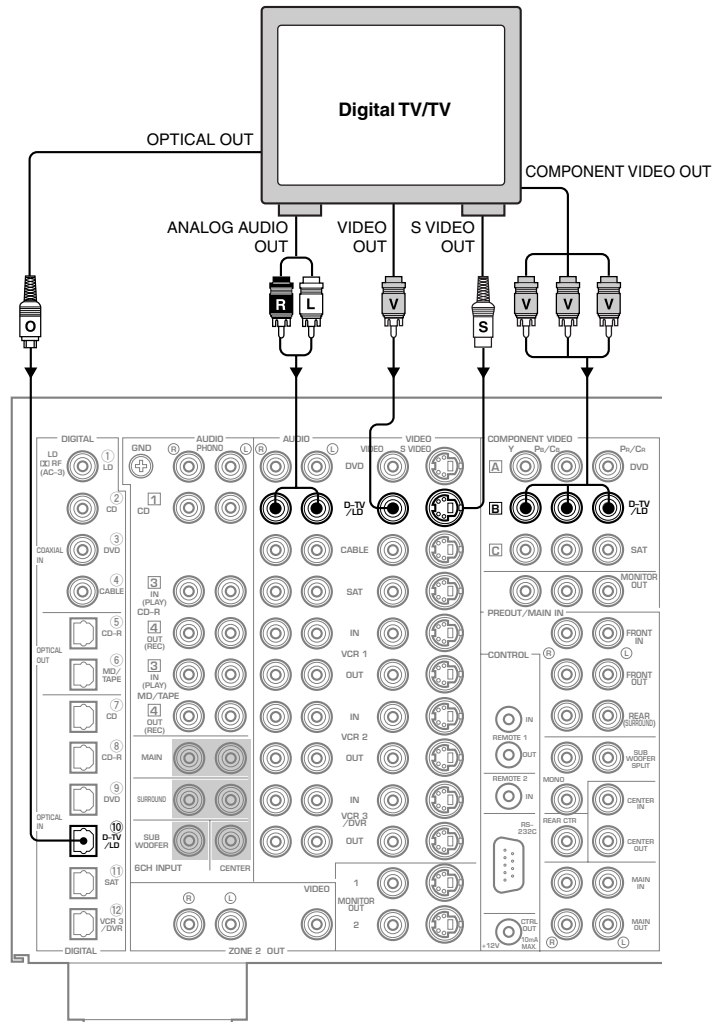

PREPARATIONS

English

CONNECTIONS

■ Connecting a cable TV tuner

- Connect the left and right analog signal output jacks on your cable TV tuner to the **CABLE** (L) and (R) jacks. Connect the composite video signal output jack on your cable TV tuner to the **CABLE VIDEO** jack.
- If your cable TV tuner has an S-video output or component video output, you can connect it to this unit. Connect the S-video signal output jack on your cable TV tuner to the **CABLE S VIDEO** jack or connect the component video signal output jacks on your cable TV tuner to the **SAT COMPONENT VIDEO** jacks.
- Connect the optical digital signal output jack on your cable TV tuner to the **OPTICAL SAT** jack.
- Connect the coaxial digital signal output jack on your cable TV tuner to the **COAXIAL CABLE** jack.

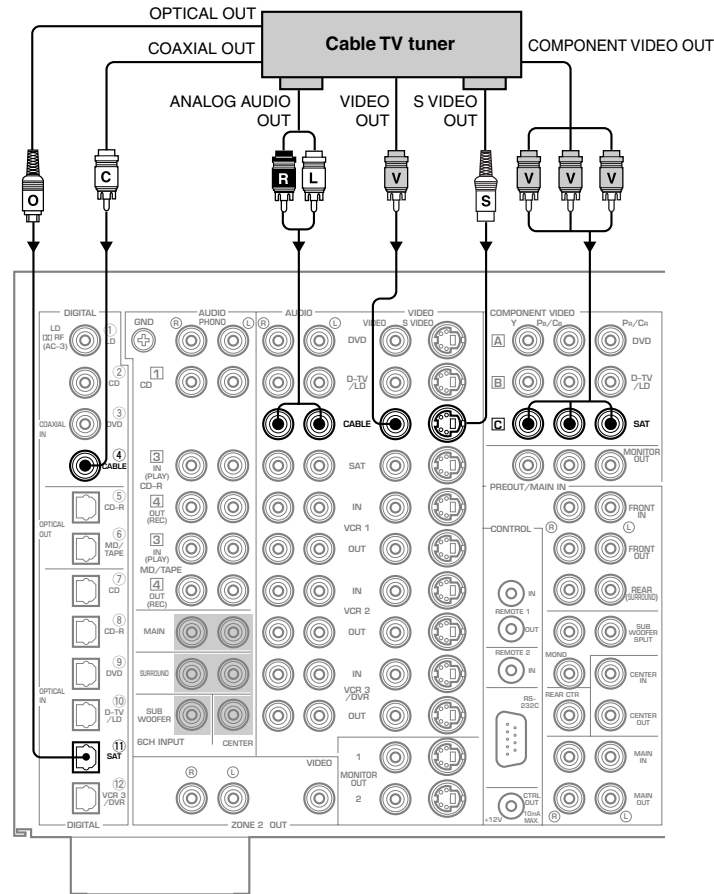

Cautions

- When connecting the optical digital signal output jack on your cable TV tuner, it is necessary to change the setting for the **OPTICAL SAT** jack of "8 I/O ASSIGNMENT" on the SET MENU in order to connect the digital audio signals to the **SAT** jack and the video signals to **CABLE** jack (see page ___).
- When connecting the component video signal output jacks on your cable TV tuner, it is necessary to change the setting for **SAT COMPONENT VIDEO** jacks of "8 I/O ASSIGNMENT" on the SET MENU in order to connect the audio signals to the **CABLE** jack and the component video signal to the **SAT** jack (see page ___).

■ Connecting a satellite tuner

- Connect the left and right analog signal output jacks on your satellite tuner to the **SAT L** and **R** jacks. Connect the composite video signal output jack on your satellite tuner to the **SAT VIDEO** jack.
- If your satellite tuner has an S-video output or component video output, you can connect it to this unit. Connect the S-video signal output jack on your satellite tuner to the **SAT S VIDEO** jack or connect the component video signal output jacks on your satellite tuner to the **SAT COMPONENT VIDEO** jacks.
- Connect the optical digital signal output jack on your satellite tuner to the **OPTICAL SAT** jack.
- Connect the coaxial digital signal output jack on your satellite tuner to the **COAXIAL CABLE** jack.

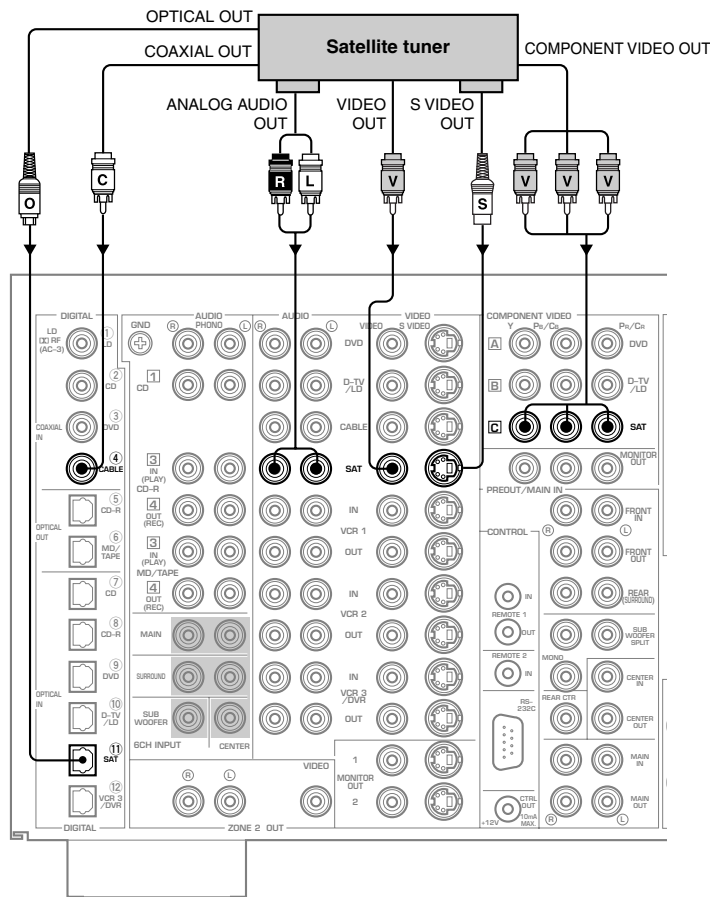

Caution

- When connecting the coaxial digital signal output jack on your satellite tuner, it is necessary to change the setting for the **COAXIAL CABLE** jack of “8 I/O ASSIGNMENT” on the SET MENU in order to connect the digital audio signals to the **CABLE** jack and the video signals to **SAT** jack (see page ___).

PREPARATIONS

English

CONNECTIONS

■ Connecting a VCR

- Connect the left and right audio signal output jacks on your VCR to the **VCR 1 IN** (L) and (R) jacks. Connect the left and right audio signal input jacks on your VCR to the **VCR 1 OUT** (L) and (R) jacks. Connect the composite video signal output jack on your VCR to the **VCR 1 VIDEO IN** jack. Connect the composite video signal input jack on your VCR to the **VCR 1 VIDEO OUT** jack.
- If your VCR has an S-video output, you can connect it to this unit. Connect the S-video signal output jack on your VCR to the **VCR 1 IN S VIDEO** jack. If your VCR has an S-video input, you can connect it to this unit. Connect the S-video signal input jack on your VCR to the **VCR 1 OUT S VIDEO** jack.
- If your VCR has an optical digital signal output jack, connect it to the **OPTICAL VCR 3/DVR** jack.

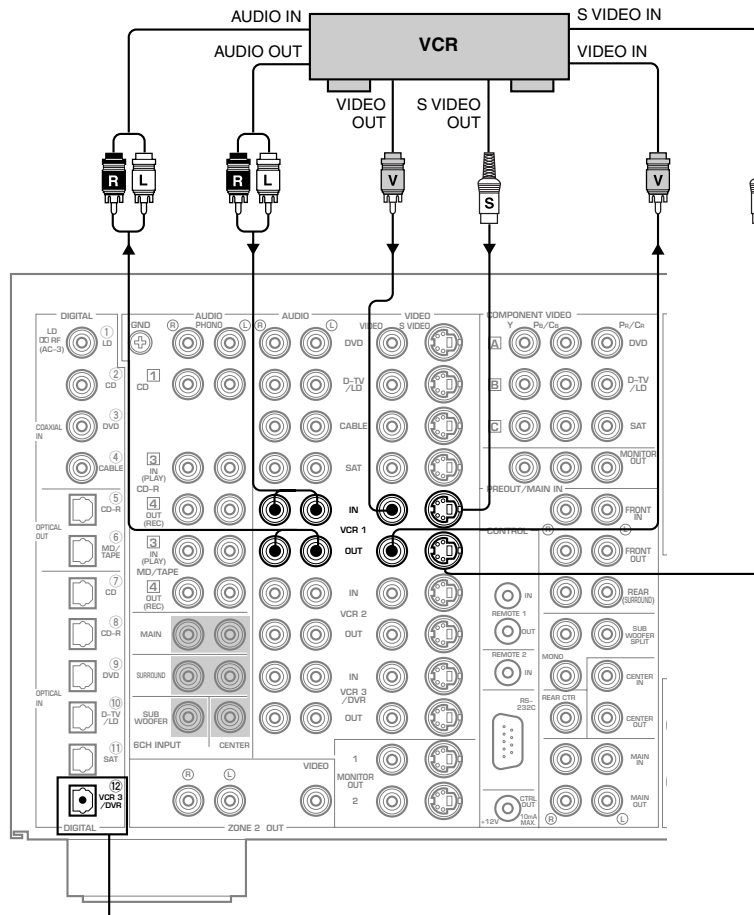

This jack is for connecting with the component that has an optical digital output jack such as a DVD recorder.

Note

- You can connect other VCRs to this unit using the **VCR 2** and **VCR 3/DVR** jacks.

■ Connecting an LD player

- Connect the left and right audio signal output jacks on your LD player to the **D-TV/LD** (L) and (R) jacks. Connect the composite video signal output jack on your LD player to the **D-TV/LD VIDEO** jack.
- If your LD player has an S-video output, you can connect it to this unit. Connect the S-video signal output jack on your LD player to the **D-TV/LD S VIDEO** jack.
- Connect the optical digital signal output jack on your LD player to the **OPTICAL D-TV/LD** jack.
- Connect the RF signal output jack on your LD player to the **LD RF (AC-3)** jack.

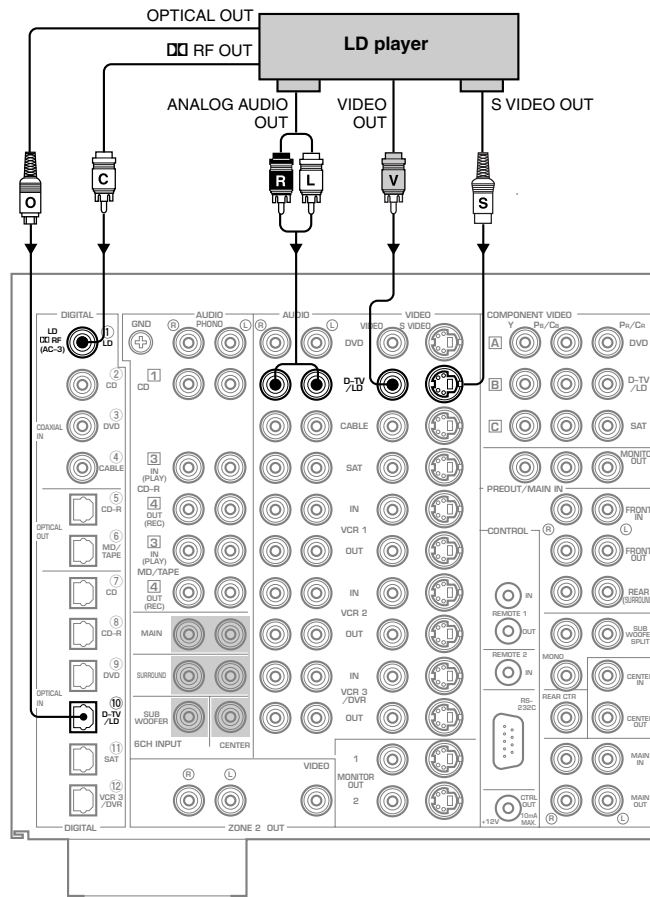

PREPARATIONS

English

CONNECTIONS

■ Connecting a video monitor

- Connect the composite video signal input jack on your video monitor to **MONITOR OUT 1 VIDEO** jack.
- If your video monitor has an S-video input or component video input, you can connect it to this unit. Connect the S-video signal input jack on your video monitor to the **MONITOR OUT 1 S VIDEO** jack or connect the component video signal input jacks on your video monitor to the **COMPONENT VIDEO MONITOR OUT** jacks.

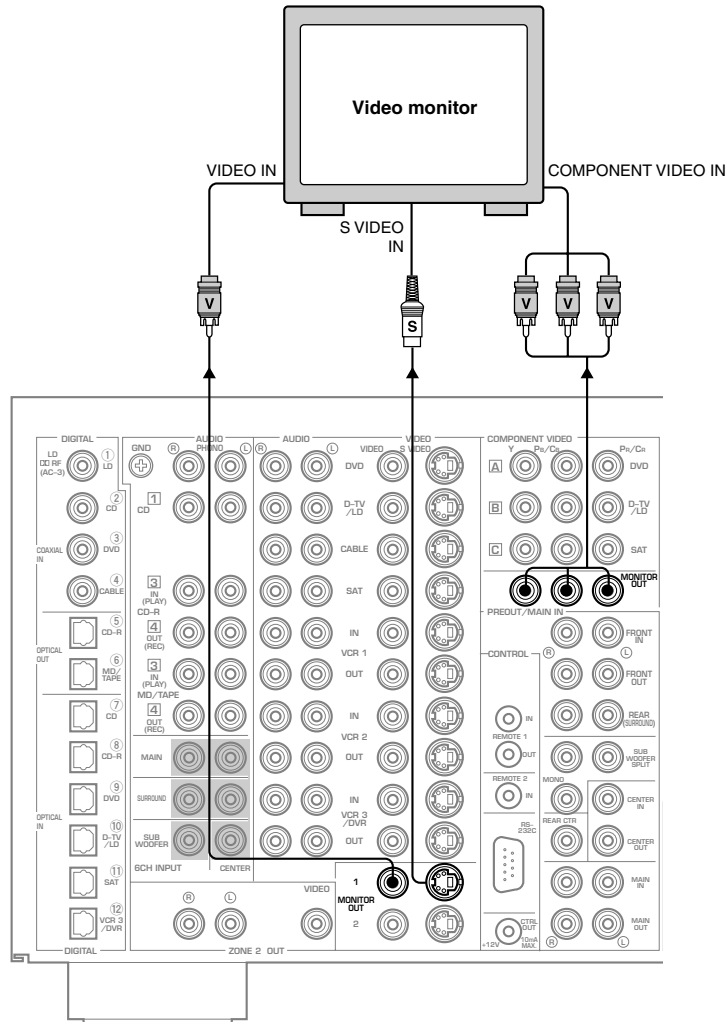

Note

- You can connect another monitor to this unit using the **MONITOR OUT 2** jacks.

Connecting speakers

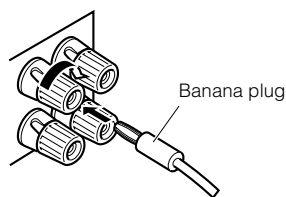
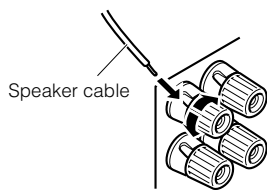
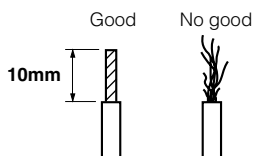
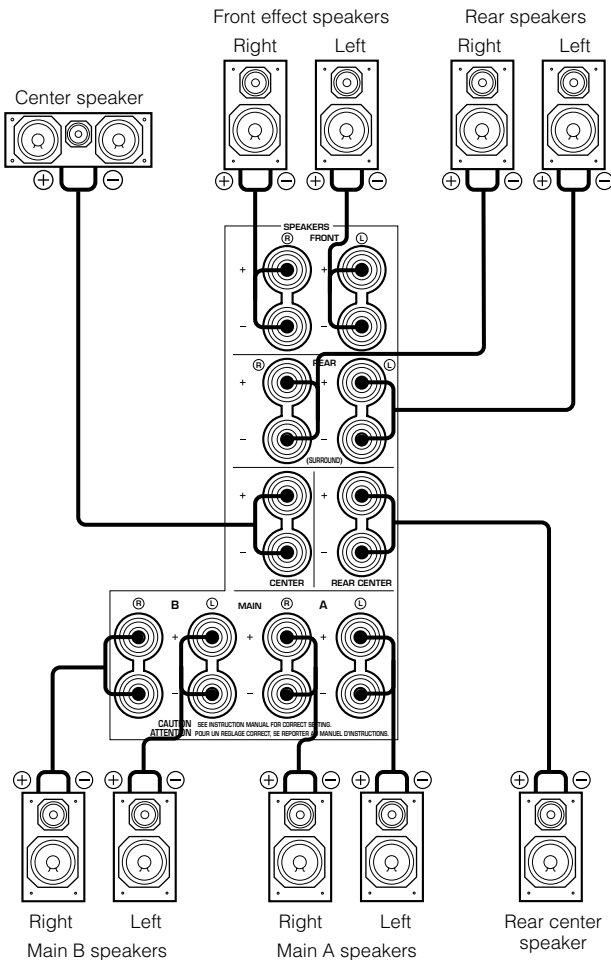

- Be sure to connect the left channel (L), right channel (R), “+” (red) and “-” (black) properly. If the connections are faulty, no sound will be heard from the speakers, and if the polarity of the speaker connections is incorrect, the sound will be unnatural and lack bass.
- Connect the speaker cables with care to avoid creating a short circuit. If you turn on the power and there is a short circuit, this unit may be damaged even though the protection circuit automatically shuts off the power.

After you finish connecting your speakers, use the SET MENU to change the signal output settings according to the number and size of the speakers in your configuration.

■ Connecting the SPEAKERS terminals

A speaker cable is actually a pair of insulated cables running side by side. One of the cables is colored or shaped differently, perhaps with a stripe, groove or ridge.

- 1 Strip off 10 mm (3/8”) of insulation from the ends of the cables.
- 2 Twist the exposed wires of the cable together to prevent short circuits.
- 3 Loosen the terminal knob by turning it counterclockwise.
- 4 Insert only the exposed portion of the cable into the slot in the side of the terminal, and tighten the terminal knob.

Note

- If your speaker cables have banana plugs, tighten the terminal knob and insert the plug into the end of the terminal.

CONNECTIONS

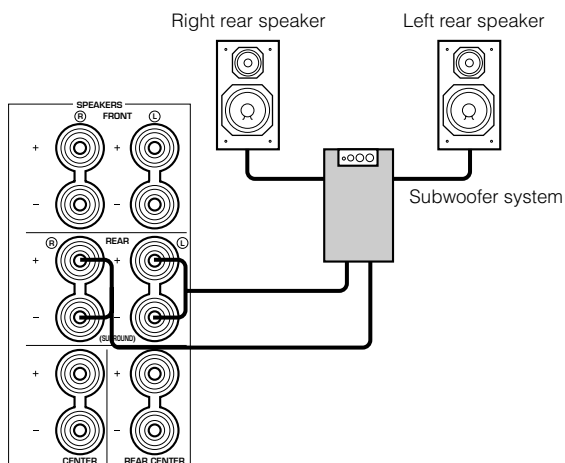
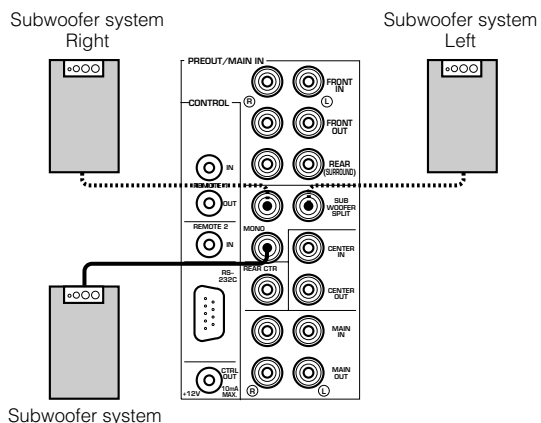

WARNING

Do not change the **IMPEDANCE SELECTOR** switch setting while the power to this unit is on, otherwise this unit may be damaged.

IF THIS UNIT FAILS TO TURN ON WHEN THE **STANDBY/ON SWITCH IS PRESSED:**

The **IMPEDANCE SELECTOR** switch may not be set to either end. If so, set the switch to either end when this unit is in the standby mode.

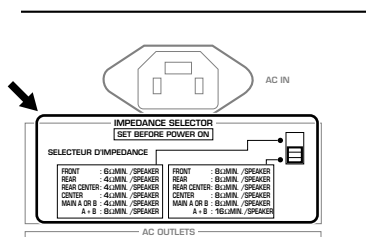

■ Connecting a front subwoofer

Connect the signal input jack on your subwoofer to the **PREOUT/MAIN IN SUBWOOFER MONO** jack.

By connecting two subwoofers to the **SUBWOOFER SPLIT** jacks, this unit can reproduce subtle directional changes in the low frequency sounds.

When you use two subwoofers, connect both of them to the **SUBWOOFER SPLIT** jacks using pin plugs.

■ Connecting a rear subwoofer

By using both front and rear subwoofers, the CINEMA-DSP sound field programs can produce realistic movie effects with powerful, dynamic sound. To take advantage of this dynamic sound, be sure to set the "1C REAR L/R SP" item in the SET MENU to "LARGE" (see page ___).

Caution

- Adjust the speaker volume for the subwoofer with the controls on the subwoofers, not on this unit.

■ Impedance selector switch

Select the position whose requirements your speaker system meets.

 (Upper position)

Front effect: The impedance of each speaker must be 6Ω or higher.

Rear: The impedance of each speaker must be 4Ω or higher.

Rear Center: The impedance of the speaker must be 4Ω or higher.

Center: The impedance of the speaker must be 4Ω or higher.

Main: If you use one pair of main speakers, the impedance of each speaker must be 4Ω or higher. If you use two pairs of main speakers, the impedance of each speaker must be 8Ω or higher.

 (Lower position)

Front effect: The impedance of each speaker must be 8Ω or higher.

Rear: The impedance of each speaker must be 8Ω or higher.

Rear Center: The impedance of the speaker must be 8Ω or higher.

Center: The impedance of the speaker must be 8Ω or higher.

Main: If you use one pair of main speakers, the impedance of each speaker must be 8Ω or higher. If you use two pairs of main speakers, the impedance of each speaker must be 16Ω or higher.

Connecting other components

■ Connecting external amplifiers

If you want to increase the power output to the speakers, or want to use another amplifier, connect an external amplifier to the **PREOUT/MAIN IN** terminals as follows.

Caution

- When an RCA pin-plug cable is connected to the **PREOUT** jack in order to output to the external amplifier, do not connect speakers to this unit. If you do, the sound will be output from both speakers connected to the external amplifier and this unit.

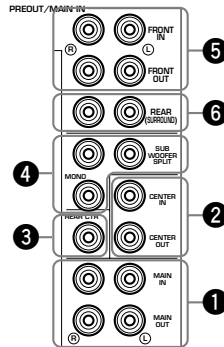

1 MAIN jacks

MAIN OUT jacks

Main channel line output jacks. The signals output through these jacks are affected by **VOLUME**, **BASS**, **TREBLE**, and **BASS EXTENSION** settings.

MAIN IN jacks

Line input to this unit's main channel amplifiers. When connecting to these jacks, signals input to the preamplifier of this unit will not be output from the main amplifier of this unit.

2 CENTER jacks

CENTER OUT jack

Center channel line output jacks.

CENTER IN jack

Line input to this unit's center channel amplifier. When connecting to these jacks, signals input to the preamplifier of this unit will not be output from the center amplifier of this unit.

3 REAR CTR jack

Rear center channel line output jack.

4 SUBWOOFER jacks

Subwoofers reinforce very low frequencies.

MONO

Main, center and rear channel frequencies below 90 Hz are output through this jack. You can also direct DTS and Dolby Digital LFE signals to this output.

SPLIT

The **SPLIT** jacks output stereo separation for the main and rear channels and a split mono signal for the center and LFE channels.

Adjust the volume level of the subwoofer with the control on the subwoofer. Subwoofer volume cannot be adjusted from this unit. Depending on the settings in SET MENU item "1 SPEAKER SET", some signals may not be output from the **SUBWOOFER** jacks.

5 FRONT jacks

FRONT OUT jacks

Front effect channel line output jacks.

FRONT IN jacks

Line input to this unit's front effect channel amplifiers. When connecting to these jacks, signals input to the preamplifier of this unit will not be output from the front effect amplifier of this unit.

6 REAR (SURROUND) jacks

Rear channel line output jacks.

CONNECTIONS

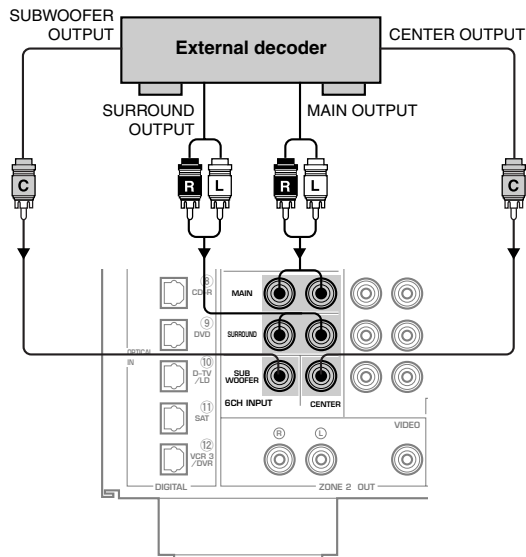

■ Connecting an external decoder

This unit is equipped with six additional input jacks (left and right **MAIN**, **CENTER**, left and right **SURROUND** and **SUBWOOFER**) for discrete multi-channel input from an external decoder, sound processor, or pre-amplifier. Connect the output jacks on your external decoder to the **6CH INPUT** jacks.

Notes

- When you select “6CH INPUT” as the input source, this unit automatically turns off the digital sound field processor, and you cannot listen to DSP programs.
- When you select “6CH INPUT” as the input source, settings of “1 SPEAKER SET” on the SET MENU do not apply (except for “1G MAIN LEVEL”).

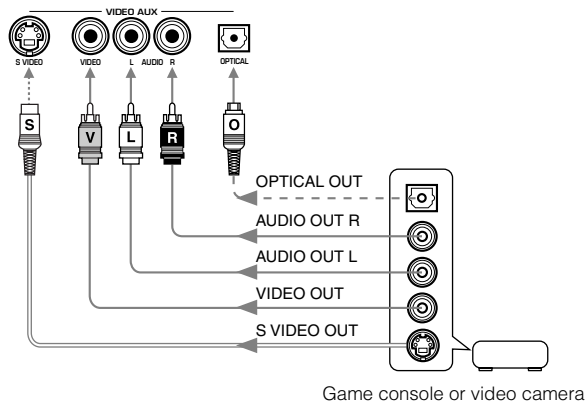

■ Connecting a game console

These jacks are used to connect any video input source such as a game console and a video camera to this unit.

Connecting the power supply cords

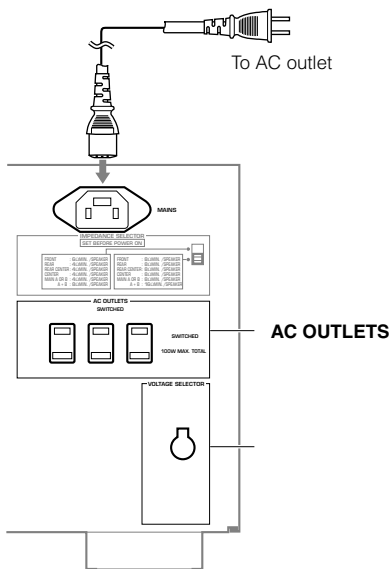

■ Connecting the AC power cord

Plug the power cord into the AC inlet when all connections are complete, and then plug in this unit to the wall outlet.

Caution

- Do not use other AC power cords than the one provided. Otherwise it may result in causing fire or an electrical shock.

■ AC OUTLETS

Use these outlets to connect the power cords from your components to this unit. The power to the **AC OUTLETS** is controlled by this unit's **STANDBY/ON (POWER and STANDBY)**. These outlets will supply power to any connected component whenever this unit is turned on. The maximum power (total power consumption of components) that can be connected to the **AC OUTLETS** is 100 W.

ON-SCREEN DISPLAYS (OSD)

You can display the operation information for this unit on a video monitor. If you display the SET MENU and DSP sound field program parameter settings on a screen, it is much easier to see the available options and parameters than it is by reading this information on the front panel display.

Notes

- If a video source is being reproduced, the OSD is superimposed over the image.
- The OSD signal is not output through the **REC OUT** selector, and will not be recorded with any video signal.

OSD modes

You can change the amount of information the OSD shows.

- Full display:** This mode always shows the sound field program parameter settings on the video monitor (see page ____).
- Short display:** This mode briefly shows the same contents as the front panel display at the bottom of the screen, then disappears.
- Display off:** This mode briefly shows the “DISPLAY OFF” message at the bottom of the screen, then disappears. Afterwards, no changes to operations appear on the screen except those when pressing the left button (labeled “OSD”).

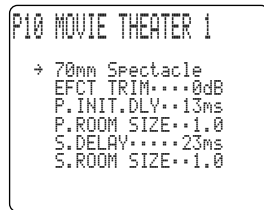

Full display

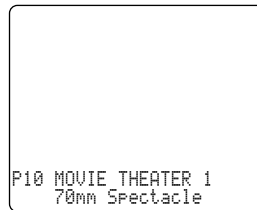



Short display

Notes

- The SET MENU, “TEST DOLBY SUR.” and “TEST DSP” appear regardless of the OSD mode.
- When you choose the Full Display mode, **INPUT SELECTOR**, **VOLUME** and some other types of operation information are displayed at the bottom of the screen in the same format as the front panel display.

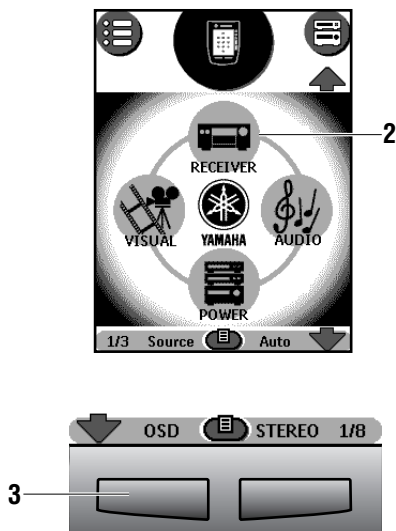
Selecting the OSD mode



- 1 Turn on the video monitor connected to this unit.
- 2 Tap  on the Home menu to open the RECEIVER control panels.
- 3 Press the left button (labeled “OSD”) repeatedly to change the display mode.
The OSD mode changes in the following order: full display, short display, and display off.

Cautions

- If your video monitor is connected only to the **COMPONENT VIDEO** terminals of this unit, the OSD is not shown.
- If you choose a video input source that has component connected to both the **S VIDEO IN** and composite **VIDEO IN** jacks, and both the **S VIDEO OUT** and composite **VIDEO OUT** jacks are connected to a video monitor, the video signal is output to both the **S VIDEO OUT** and **VIDEO OUT** jacks. However, the OSD is carried only on the S-video signal. If no video signal is input, the OSD is carried on both the S-video and composite video signals.
- Playing back video software that has an anti-copy signal or video signals with a lot of noise may produce unstable images.

SPEAKER MODE SETTINGS

This unit has seven SPEAKER SET items in the SET MENU that you must set according to the number of speakers in your configuration and their size. The following table summarizes these SPEAKER SET items, and shows the initial settings as well as other possible settings. If the initial settings are not appropriate for your speaker configuration, change the settings in the SET MENU.

■ Summary of SPEAKER SET items 1A through 1G

Item	Description	Control value (default setting indicated in bold)
1A CENTER SP	Selects the output mode according to whether or not a center speaker is being used and its performance.	LRG /SML/NONE
1B MAIN SP	Selects the output mode according to the performance of the main speakers.	LARGE /SMALL
1C REAR L/R SP	Selects the output mode according to whether or not rear L/R speakers are being used and their performance.	LRG /SML/NONE
1D REAR CT SP	Selects the output mode according to whether or not a rear center speaker is being used and its performance.	LRG /SML/NONE
1E LFE/BASS OUT	Selects the speaker according to use for LFE signal output and low bass signal.	SW/ MAIN /BOTH
1F FRONT EFCT SP	Selects the output mode according to whether or not front effect speakers are being used.	YES /NONE
1G MAIN LEVEL	Selects the main speaker level.	Normal /-10dB

Cautions

- When you select **6CH INPUT** as the input source, settings of “1 SPEAKER SET” on the SET MENU do not apply (except for “1G MAIN LEVEL”).
- When the digital signals with over 96 kHz sampling frequency are input, only the “1G MAIN LEVEL” setting is effective.

■ Mode setting

Adjustment should be made with the remote control.

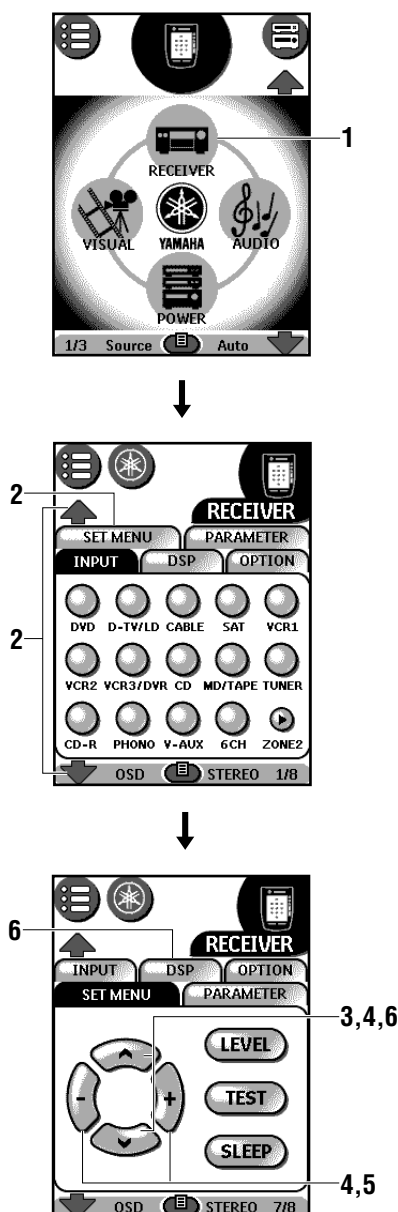

- 1 Tap **RECEIVER** on the Home menu to open the **RECEIVER** control panels.
- 2 Tap **SET MENU** (↓ or ↑ repeatedly) to open the **SET MENU** control panel (page 7/8).
- 3 Select “1 SPEAKER SET” on the SET MENU. Tap **←** or **→** to display the SET MENU on the video monitor. Tap **←** or **→** repeatedly to select “1 SPEAKER SET” on the SET MENU.
- 4 Enter the setting mode. Tap **+** or **-** to enter the setting mode. The current setting is shown on the front panel display and the video monitor. Select item (1A – 1G) to be set by tapping **←** or **→**.
- 5 Change the setting. Tap **+** or **-** to change the setting for the selected item.
- 6 Close the SET MENU. Tap **←** or **→** repeatedly until the DSP program name appears to close SET MENU or tap **DSP** and select one of the DSP program.

■ 1A CENTER SP (center speaker mode)

By adding a center speaker to your speaker configuration, this unit can provide good dialogue localization for many listeners and superior synchronization of sound and images. The OSD shows a large, small, or no center speaker depending on how you set this item. The initial setting is “LRG”.

- LRG:** Select the “LRG” (Large) setting if you have a large center speaker. The entire range of center channel signals is sent to the center speaker.
- SML:** Select the “SML” (Small) setting if you have a small center speaker. Center channel low frequency signals of 90 Hz and below are directed to the speakers selected with the “1E LFE/BASS OUT” item.
- NONE:** Select the “NONE” setting if you do not have a center speaker. All of the center channel signals are directed to the left and right main speakers.



■ 1B MAIN SP (main speaker mode)

The display shows small or large main speakers depending on how you set this item. The initial setting is “LARGE”.

- LARGE:** Select the “LARGE” setting if you have large main speakers. The entire range of left and right main channel signals is directed to the left and right main speakers.
- SMALL:** Select the “SMALL” setting if you have small main speakers. The main channel low frequency signals of 90 Hz and below are directed to the speakers selected with the “1E LFE/BASS OUT” item.

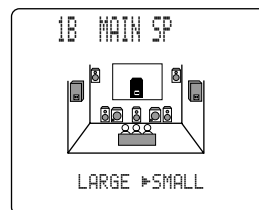
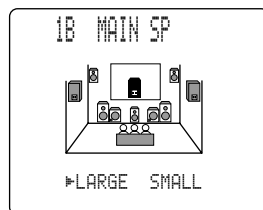

Caution

- When you select the “MAIN” setting for the “1E LFE/BASS OUT” item, the main channel low frequency signals of 90 Hz and below are directed to the main speakers even if you select the “SMALL” setting for the main speaker mode.

SPEAKER MODE SETTINGS

■ 1C REAR L/R SP (rear speaker mode)

The OSD shows large, small, or no rear speakers depending on how you set this item. The initial setting is “LRG”.

- LRG:** Select the “LRG” setting if you have large left and right rear speakers or if you use a rear subwoofer. The entire range of rear channel signals is sent to the left and right rear speakers.
- SML:** Select the “SML” setting if you have small left and right rear speakers. Rear channel low frequency signals of 90 Hz and below are directed to the speakers selected with the “1E LFE/BASS OUT” item.
- NONE:** Select the “NONE” setting if you do not have rear speakers. All of the rear channel signals are directed to the left and right main speakers.

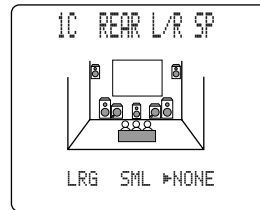

Cautions

- This unit is set in the virtual CINEMA DSP mode by selecting “NONE” for “1C REAR L/R SP” while the sound effect is on.
- In this case, the rear center speaker will automatically be set to “NONE” and the “1D REAR CT SP” item will be skipped.

■ 1D REAR CT SP (rear center speaker mode)

By adding a rear center speaker to your speaker configuration, this unit can provide more realistic front-to-back and back-to-front transitions. The initial setting is “LRG”.

- LRG:** Select the “LRG” setting if you have a large rear center speaker. The entire range of rear center channel signals is sent to the rear center speakers.
- SML:** Select the “SML” (small) setting if you have a small rear center speaker. Rear center channel low frequency signals of 90 Hz and below are distributed to speakers selected with the “1E LFE/BASS OUT” item.
- NONE:** Select the “NONE” setting if you do not have a rear center speaker. The rear center signal is directed to the rear L/R speakers.

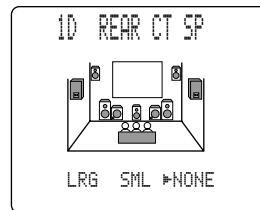
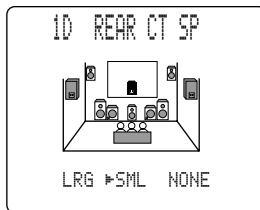

Caution

- If “1C REAR L/R SP” is set to “NONE”, “1D REAR CT SP” will be skipped from the SET MENU and the setting cannot be changed.

■ 1E LFE/BASS OUT (bass output mode)

LFE signals carry low frequency effects when this unit decodes DTS or Dolby Digital signals. Low frequency signals are defined as 90 Hz and below. The initial setting is “BOTH”.

- SW:** Select the “SW” (subwoofer) setting if you use a subwoofer. The LFE signals are directed to the subwoofer.
- MAIN:** Select the “MAIN” setting if you do not use a subwoofer. The LFE signals are directed to the main speakers.
- BOTH:** Select the “BOTH” setting if you use a subwoofer and you want to mix the main channel low frequency sound signals with the LFE signals.

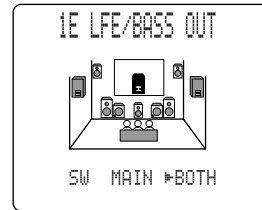
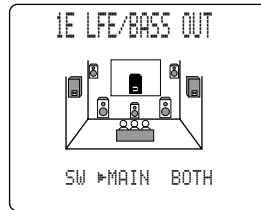
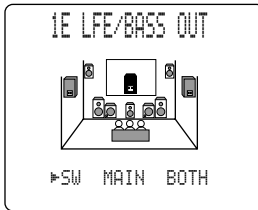

Caution

- The low frequency signals of 90 Hz and below from all main, center, rear, and rear center channels are directed to the LFE channel when you select the small speaker setting in items 1A, 1B, 1C, and 1D.

■ 1F FRONT EFCT SP (front effect speaker mode)

This unit uses front effect speakers to localize the virtual sound sources of the sound field programs. If you do not use front effect speakers, you can direct the front effect signals to the main speakers.

The OSD shows small or no front effect speakers depending on how you set this item. The initial setting is “YES”.

- YES:** Select the “YES” setting if you use front effect speakers.
- NONE:** Select the “NONE” setting if you do not use front effect speakers. The front effect signals are mixed with the main channels.

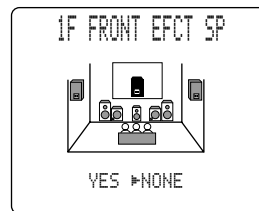
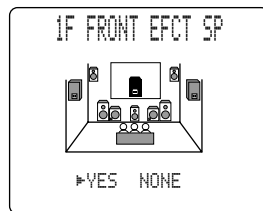

■ 1G MAIN LEVEL

Change this setting if you cannot match the sound volume of the front effect, rear, center, and rear center speakers with the main speakers because of the unusually high efficiency performance of the main speakers. The initial setting is “Normal”.

- Normal:** Select the “Normal” setting if you can match the volume of your effect speakers with the volume of your main speakers using the “TEST DOLBY SUR.”.
- 10dB:** Select the “-10dB” setting if you cannot match the volume of your effect speakers with the volume of your main speakers using the “TEST DOLBY SUR.”.

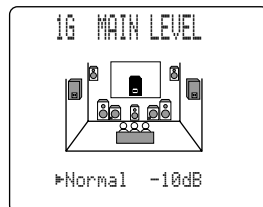

SPEAKER OUTPUT LEVELS

This section explains how to set the speaker output levels using the test tone generator. The “TEST DOLBY SUR.” is for balancing the output levels of the six speakers required for surround sound systems. The “TEST DSP” is for balancing the front effect speakers with the main speakers for the DSP sound field programs.

■ Before you begin

- 1 Set **BASS**, **TREBLE** and **BALANCE** on the front panel to the center position.

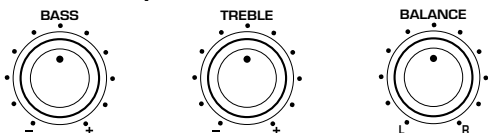

- 2 Turn off **BASS EXTENSION**.



Cautions

- Since this unit cannot enter the test mode while headphones are connected to this unit, be sure to unplug the headphones from the **PHONES** jack when using the test tone.
- If the headphone is connected while “TEST DOLBY SUR.” or “TEST DSP” is being used, the testing mode will be cancelled.

■ Display (on the remote control) to be used

Before you begin, go to the **PARAMETER** control panel following the steps below.

- 1 Tap  on the Home menu to open the **RECEIVER** control panels.

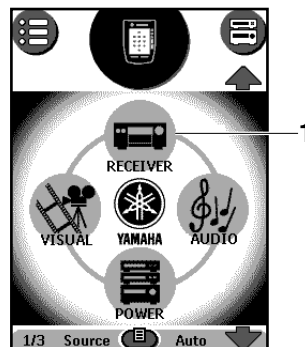

- 2 Tap  (↓ or ↑ repeatedly) to open the **PARAMETER** control panel (page 8/8).

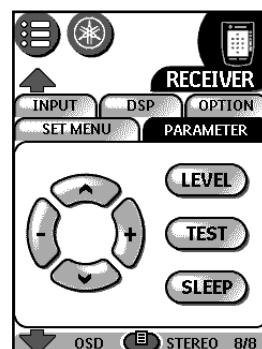
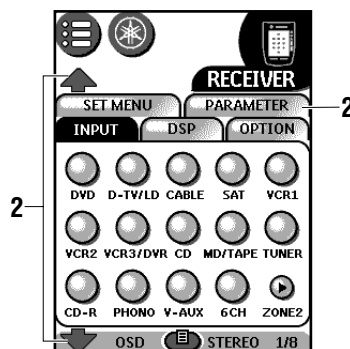

TEST DOLBY SUR.

Select “TEST DOLBY SUR.” to match the output levels of the center, rear center and left and right rear speakers to the left and right main speakers.

- 1 Tap **TEST** on the **PARAMETER** control panel. “TEST DOLBY SUR.” appears on the video monitor and front panel display.

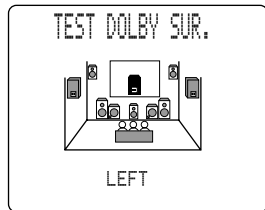

TEST DOLBY SUR.
LEFT

The test tone is produced from the left main speaker, center speaker, right main speaker, right rear speaker, rear center speaker and left rear speaker in order. The tone is produced for 2.5 seconds each time. You can also select the speaker to be adjusted by tapping or .

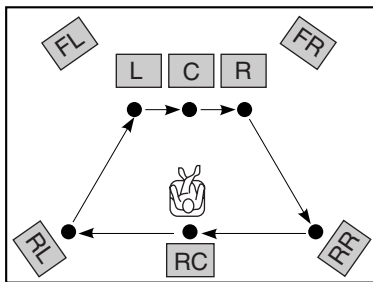

Cautions

- Speakers whose settings are set to “NONE” in “1 SPEAKER SET” (except for “1A CENTER SP”) on the SET MENU will be skipped and no test tone will be output.
- You can also enter the TEST DSP SUR. mode by tapping **TEST** on the SET MENU control panel. However, the adjustment cannot be made by tapping , , , and on the SET MENU control panel.

- 2 Adjust VOL +/- so you can hear the test tone.

Caution

- If the test tone cannot be heard, turn down the volume, set this unit in the standby mode and check the speaker connections.

- 3 Tap or repeatedly to adjust the output level of the effect speakers so that the output level coming from each speaker is the same.

Each speaker level can be adjusted in the range of -10 to +10 dB.

While adjusting, the test tone is heard from the selected speaker.

Cautions

- If “1A CENTER SP” on the SET MENU is set to “NONE”, the center channel sound is automatically output from the left and right main speakers.
- If “1D REAR CT SP” on the SET MENU is set to “NONE”, the output level of the rear center speaker cannot be adjusted in step 3.
- Main L/R speaker level cannot be adjusted by itself. Use **VOLUME** to adjust the main volume.

- 4 Tap **TEST** to enter the TEST DSP mode.

Tap **TEST** again to stop the test tone and the DSP program name appears on the front panel display and the video monitor.

Notes

- The tonal quality of the speakers can be adjusted using the “4 CENTER GEQ”, “5 REAR CT GEQ”, and “6 CINEMA EQ” items in the SET MENU (see pages ___ to ___).
- You can increase the output levels of the effect channels (left rear, right rear, rear center and center) to +10 dB. If the output level of the center, rear, and rear center speakers is lower than that from the main speakers even after you have increased the sound volume level of the center, rear, and rear center speakers up to +10 dB, set the “1G MAIN LEVEL” item in the SET MENU to “-10dB”. Setting the “1G MAIN LEVEL” item to this setting decreases the main speaker volume level to about one-third the normal level. After you set the “1G MAIN LEVEL” item in the SET MENU to “-10dB”, adjust the levels for the center, rear, and rear center speakers again.
- The adjustment of output levels of the center speaker, and left and right rear speakers is also effective to the speaker output level during the playback of the source connected to **6CH INPUT** jacks.

TEST DSP

Select “TEST DSP” to match the output levels of the front effect speakers to the main speakers.



Caution

- You cannot enter the TEST DSP mode if “1F FRONT EFCT SP” is set to “NONE”.

1 Tap  repeatedly.

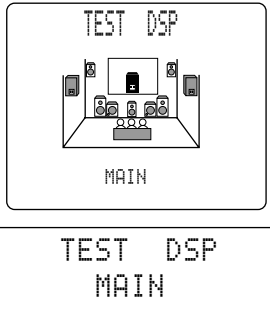



“TEST DSP” appears on the video monitor and front panel display.

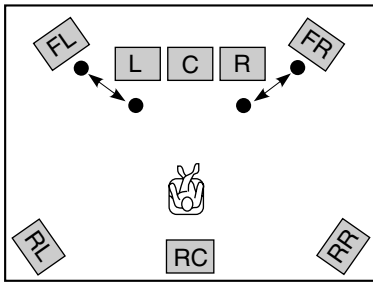

The test tone is produced alternately from the front effect speakers and main speakers. The tone is produced for 2.5 seconds each time. Tap  to hear the test tone from the front effect L speaker (FRONT L), and  to hear the test tone from the front effect R speaker (FRONT R).





Caution

- You can also enter the TEST DSP mode by tapping  repeatedly on the SET MENU control panel. However, the adjustment cannot be made by tapping , , , and  on the SET MENU control panel.

2 Adjust VOL +/- so you can hear the test tone.

Caution

- If the test tone cannot be heard, turn down the volume, set this unit in the standby mode and check the speaker connections.

3 Tap  or  repeatedly to adjust the output level of the front effect speakers so that the output level coming from each speaker is the same.

The front effect speaker level can be adjusted in the range of -10 to +10 dB. Test tone is output only from the front effect speakers.

Caution

- Main L/R speaker level cannot be adjusted.

4 Tap  to close the TEST DSP mode.

The test tone stops and the DSP program name appears on the front panel display and the video monitor.

Notes

- The tonal quality of the speakers can be adjusted using the “6 CINEMA EQ” item in the SET MENU (see pages __ and __).
- If the sound volume of the front effect speakers is lower than that of the main speakers, even after you have increased the output level up to +10 dB, set the “1G MAIN LEVEL” item in the SET MENU to “-10dB”. Setting the “1G MAIN LEVEL” item to “-10dB” decreases the main speaker output level to about one-third of the normal level. After you set the “1G MAIN LEVEL” item in the SET MENU to “-10dB”, repeat the “TEST DOLBY SUR.” procedure on the previous page.

Basic operations

This section explains the playback operation, DSP program selection and recording operation.

BASIC PLAYBACK	42
Input modes and indications	44
Selecting a sound field program	46
BASIC RECORDING	50

REMOTE CONTROL OPERATIONS

Operating this unit

The remote control provides you with 8 pages of intuitive control panels for operating the RX-Z1. First go to the RECEIVER control panels by tapping  on the Home menu.

Item tabs

Tap an item tab to select the item you want to operate.

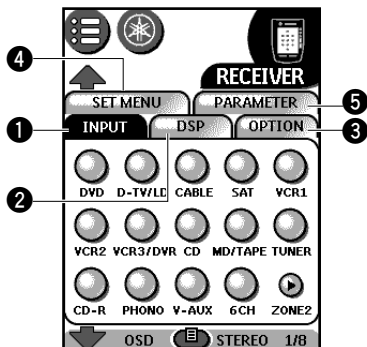

1 INPUT

You can select a source component (see page __).

2 DSP

You can select a DSP sound field program (see page __).

The  controls can be used to select one of three DSP control panels.

3 OPTION

By default there are buttons to select main speaker A/B, zone 2, etc., appear.

4 SET MENU

You can adjust the items on the SET MENU (see page __).

5 PARAMETER

You can change the parameter settings of each DSP program (see page __).

Left/right buttons

While any of the RECEIVER control panel appears on the touch screen, you can use the left/right buttons for the following operations.



1 Selecting the OSD mode

You can select the OSD mode with the left button (labeled "OSD").

2 Turning DSP on and off

You can turn the DSP effect on and off directly with the right button (labeled "STEREO").

BASIC PLAYBACK

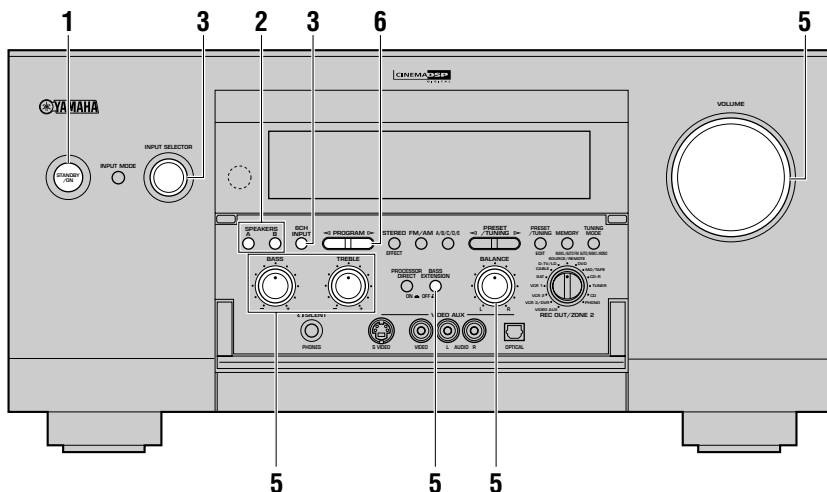
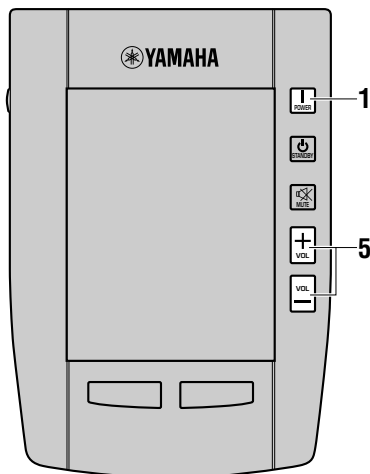

1 Press **STANDBY/ON (POWER on the remote control)** to turn on the power.

The front panel (and the monitor screen) shows the level of the volume for a few seconds and then switches to show the current sound field program.



2 Select the main speakers to be used.

<On the front panel>

Press **SPEAKERS A** or **B**.

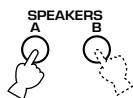

<On the remote control>

Go to the RECEIVER control panel and tap **OPTION** to open the OPTION control panel. Then tap **SPEAKERS A ON** or **SPEAKERS B ON**.

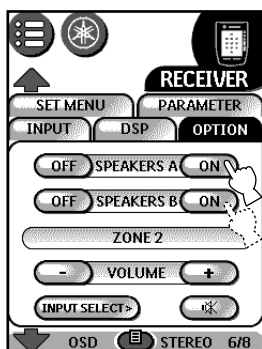

If you are using two sets of main speakers, press both **A** and **B** (or tap both **SPEAKERS A ON** and **SPEAKERS B ON**). The speaker indicator(s) for the selected set(s) lights up on the front panel display.

3 Select the source.

<On the front panel>

Rotate **INPUT SELECTOR** to select the input source.

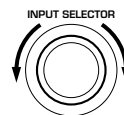

<On the remote control>

Tap **INPUT** on the RECEIVER control panel to open the INPUT control panel. Then tap one of the input selector buttons (such as **DVD**).



The current source name and input mode appear on the front panel display and the video monitor for a few seconds.

Selected input source

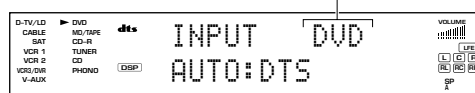

To select a source connected to the **6CH INPUT** jacks,
<On the front panel>
 Press **6CH INPUT**.



<On the remote control>

Tap  on the INPUT control panel.

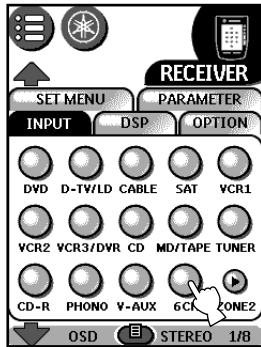

“6CH INPUT” appears on the front panel display.

6CH INPUT

Cautions

- If “6CH INPUT” is shown on the front panel display, no other source can be played. To select another input source with **INPUT SELECTOR** (or one of the input selector buttons on the INPUT control panel), press **6CH INPUT** (or tap  on the INPUT control panel) to turn off “6CH INPUT” from the front panel display.
- The input source name corresponds to the jack name to which the input component is connected. If the component is not connected to its corresponding jack, input source name and the playback component do not match. (For example, if a CD player is connected to the MD input jack and MD is selected as an input source, the playback sound will be output from the CD player.) In this case, the input source name can be changed with “7 INPUT RENAME” on the SET MENU.

4 Start playback or select a broadcast station on the source component.

Refer to the operation instructions for the component.

5 Adjust the volume to the desired output level.

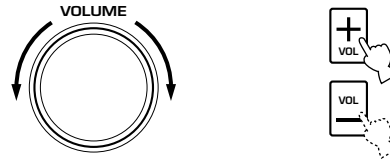

If desired, use **BASS**, **TREBLE**, **BASS EXTENSION** and **BALANCE**. These controls are only effective for sound from the main speakers.

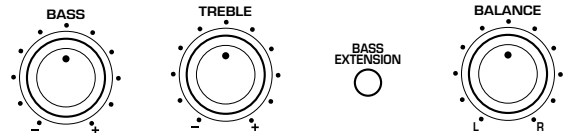

Cautions

- If the component connected to the **VCR 1 OUT**, **VCR 2 OUT**, **VCR 3/DVR OUT**, **CD-R OUT** and **MD/TAPE OUT** jacks is turned off, the reproduced sound may be distorted or the volume may be lowered for the characteristics of A/V component. In this case, turn on the component.
- While **PROCESSOR DIRECT** is tuned on, tone controls (**BASS** and **TREBLE**) or/and **BASS EXTENSION** cannot be activated.

6 Select a DSP program if desired.

<On the front panel>
 Press **PROGRAM** .

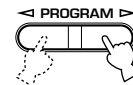

<On the remote control>

Tap  on the RECEIVER control panel to open the DSP control panel. Then tap one of the DSP program buttons.

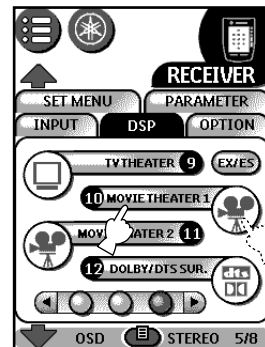

See pages __ to __ for details about the DSP program.

■ BGV (Back Ground Video) function

The BGV (Back Ground Video) function allows you to combine a video signal from a video source with a sound signal from an audio source. (For example, you can listen to classical music while you are watching a video.)

Using the remote control, select a source from the video group, then select a source from the audio group. Use the input selector buttons on the remote control to make your selections.

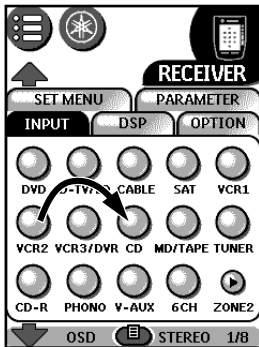

Note

- The BGV function does not work if you select the sources using **INPUT SELECTOR** on the front panel.

■ To mute the sound

Press **MUTE** on the remote control. To resume the audio output, press **MUTE** again.



Notes

- You can also cancel mute to press any operation buttons such as **VOL +/-**.
- While the mute function is on, "MUTE ON" appears on the front panel display.
- When this unit enters the standby mode, the mute function will be cancelled.

■ When you have finished using this unit

Press **STANDBY/ON** (**STANDBY** on the remote control) to set this unit in the standby mode.



Input modes and indications

This unit comes with various input jacks. If your external component is connected to more than one type of input jack, you can set the priority of the input signal. Press **INPUT MODE** on the front panel or tap an input selector button (tap it repeatedly) on the remote control to display or change the input mode.

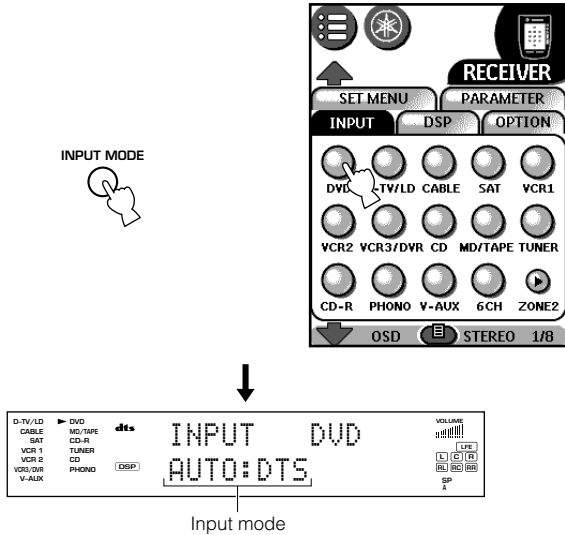

Input mode

AUTO: This mode is automatically selected when you turn on the power of this unit. In this mode, the input signal is automatically selected in the following order.

- ① Digital signals
- ② Analog signals

<When D-TV/LD is selected as the input source>

- ① Dolby Digital RF encoded signals
- ② Digital signals
- ③ Analog signals

D.D. RF: This unit only selects Dolby Digital RF signals (when **D-TV/LD** is selected as the input source).

DTS: In this mode, only digital input signals encoded with DTS are selected even if other signals are input at the same time.

DGTL: This unit only selects digital signals input through the **OPTICAL** or **COAXIAL** jacks (when **D-TV/LD** is selected as the input source).

ANALOG: In this mode, only analog input signals are selected even if digital signals are input at the same time.

Cautions

- When you turn on the power of this unit, the input mode is set according to “9 INPUT MODE” on the SET MENU (see page ___ for details).
- When you connect components to both the **COAXIAL** and **OPTICAL** jacks, priority is given to the input signals from the **COAXIAL** jack.

Notes on the digital signal

The digital input jacks of this unit can handle up to 192 kHz sampling digital signal. Both **OPTICAL** and **COAXIAL** input jacks can be used to input the digital signal up to 96 kHz. However when inputting the higher digital signals than 96 kHz, be aware the following points.

- DSP programs cannot be selected. Sound will be output as normal 2-channel stereo sound from only the left and right main speakers.
- Use the coaxial input (**COAXIAL IN**) jack to input over 96 kHz digital signal. The signals may not be correctly played back if the optical input (**OPTICAL IN**) jack is used.
- Level adjustment for effect speakers excluding a subwoofer is not possible.

Sound effects will be added to 96 kHz sampling digital signals after converted to 48 kHz.

■ Notes on playing DTS-CD/LDs

- If the digital output data of the player has been processed in any way, you may not be able to perform DTS decoding even if you make a digital connection between this unit and the player.
- If you play a source encoded with a DTS signal and set the input mode to “ANALOG”, this unit may reproduce the noise of an unprocessed DTS signal. In this case, connect the source to a digital input jack and set the input mode to “AUTO” or “DTS”.
- If you switch the input mode to “ANALOG” while playing a source encoded with a DTS signal, this unit reproduces no sound.
- If you play a source encoded with a DTS signal with the input mode set to “AUTO”, this unit automatically switches to the DTS-decoding mode (The “**dts**” indicator lights up.) after having detected the DTS signal. When playback of the DTS source is completed, the “**dts**” indicator may flash. While this indicator is flashing, only DTS source can be played. If you want to play a normal PCM source soon, set the input mode back to “AUTO”.
- If you play a source encoded with a DTS signal with the input mode set to “AUTO”, the “**dts**” indicator may flash when a search or skip operation is performed while the DTS source is playing back with the input mode set to “AUTO”. If this status continues for longer than 30 seconds, this unit will automatically switch from “DTS-decoding” mode to PCM digital signal input mode. The “**dts**” indicator will turn off.

■ Notes on playing an LD source

- For LD software that does not contain a digital soundtrack, connect the LD player to the analog jacks and set the input mode to “AUTO” or “ANALOG”.
- If the LD player is transmitting a signal by a non-standard method, this unit cannot detect the Dolby Digital or DTS signal. In this case, the decoder automatically switches to PCM or analog.
- Some A/V components such as LD players output different audio signals through their analog and digital jacks. Change the input mode as necessary.
- While you are operating the LD player and playing a disc encoded with a Dolby Digital signal, if you switch from the pause or chapter forwarding function to normal playback, you may hear the PCM or analog sound an instant before the Dolby Digital signal is played. In this case, set the input mode to “D.D.RF”.

Selecting a sound field program

You can enhance your listening experience by selecting a DSP program. There are 12 programs with sub-programs available with this unit. However the selection depends on the input signal format and not all the sub-programs are possible for all input signal formats. For details about each program, see pages ___ to ___.

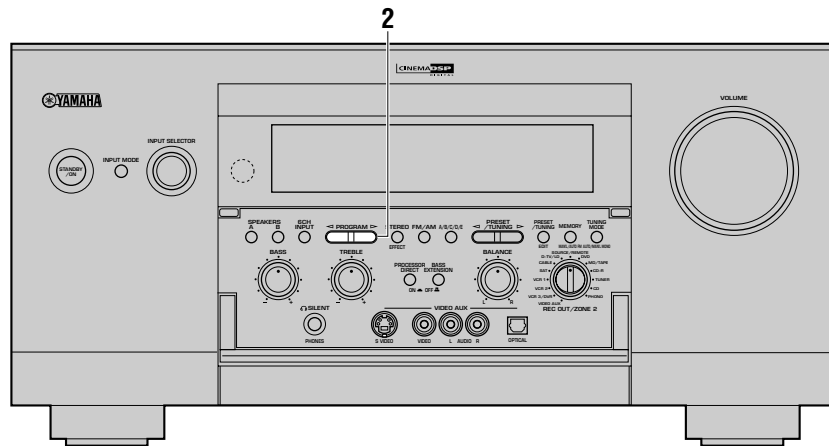

1 Tap **DSP** on the RECEIVER control panel to open the DSP control panel.

The DSP control panel is displayed as shown below.

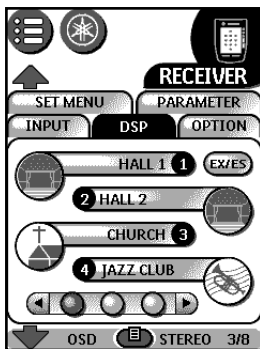

2 Select the desired program.

<On the front panel>
Press **PROGRAM** </>.

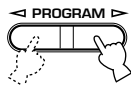

<On the remote control>

Tap one of the DSP program buttons (such as **MOVIE THEATER 1** or **MOVIE THEATER 2**).

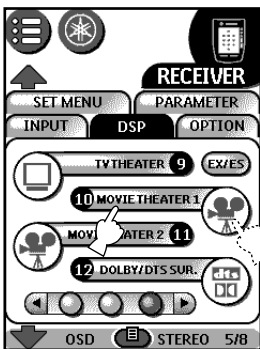

Note

- The whole DSP control panel consists of three control panels (pages 3/8 to 5/8). You can scroll through these control panels using **UP** and **DOWN**. The **LEFT** and **RIGHT** controls also can be used to select one of three DSP control panels. After selecting the desired program, tap the same button repeatedly to select the desired sub-program if available.
- Example:** Each time **MOVIE THEATER 1** or **MOVIE THEATER 2** is tapped the sub-programs (“Spectacle” and “Sci-Fi”) switch.

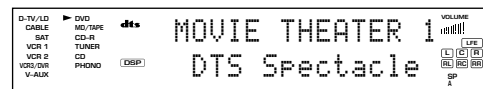

Cautions

- If a Dolby Digital or DTS signal is input when the input mode is set to “AUTO”, the DSP program automatically switches to the appropriate decoding program.
- Choose a DSP program based on your listening preference, and not on the name of the program. The acoustics of your listening room affect the DSP program. Minimize the sound reflections in your room to maximize the effect created by the program.
- When you select an input source, this unit automatically selects the last DSP program used with that source.
- When you set this unit in the standby mode, the current source and DSP program are memorized and are automatically selected when you turn on the power again.
- When a source connected to the **6CH INPUT** jacks of this unit is selected, the digital sound field processor cannot be used.
- While the over 96 kHz sampling digital signals are being input, sound effects cannot be added and only normal stereo playback is possible.
- Sound effects will be added to 96 kHz sampling digital signals after converted to 48 kHz.

Normal stereo reproduction

<On the front panel>

Press **STEREO/EFFECT** to turn off the sound effect for normal stereo reproduction.

<On the remote control>

Press the right button (labeled "STEREO") while any of the RECEIVER control panel is displayed to turn off the sound effect for normal stereo reproduction.

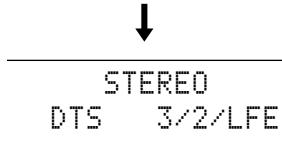
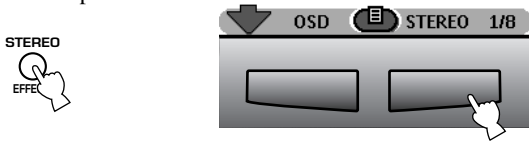

When "STEREO" is selected while Dolby Digital, DTS, or PCM signals are being played, the following information will be shown on the front panel display.

When Dolby Digital signals are played:

"Dolby D" + the number of channels (front/rear/ LFE signal)

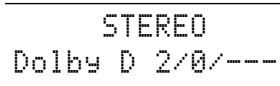

When DTS signals are played:

"DTS" + the number of channels (front/rear/ LFE signal)

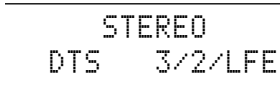

When PCM signals are played:

"PCM" + sampling frequency

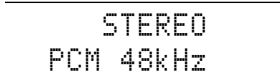

When analog signals are played:

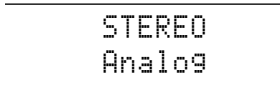

Cautions

- If you turn off the sound effect, no sound is output from the center speaker, rear speakers, rear center speaker and front effect speakers.
- If you turn off the sound effect while a Dolby Digital or DTS signal is being output, the dynamic range of the signal is automatically compressed and the sounds of the center and rear speaker channels are mixed and output from the main speakers.
- The volume may be greatly reduced when you turn off the sound effect or if you set "12 DYNAMIC RANGE" on the SET MENU to "MIN". In this case turn on the sound effect.

Displaying the information about the input source

During the stereo reproduction, information about the signal being played back can be displayed by tapping or on the PARAMETER control panel.

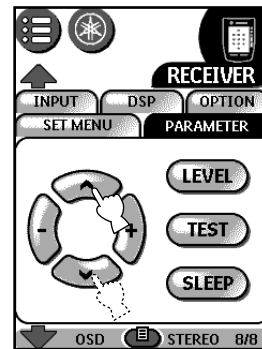

The three types of information shown below are displayed as switched every time is tapped.

fs: "unknown" is displayed when the sampling frequency for the input signal is not known.

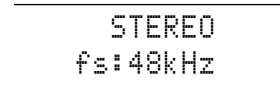

rate: "unknown" is displayed when the bit rate of the input signal is not known.

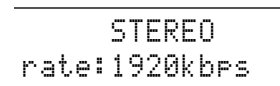

flg: "None" is displayed when the flag contained in the input signal to be used for signal process cannot be detected.

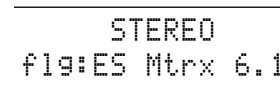

■ Playing the Dolby Digital EX or DTS ES software

Tap **DSP** on the RECEIVER control panel to open the DSP control panel. Then tap **EX/ES** to turn on the Dolby Digital EX or DTS ES decoder to listen to the Dolby Digital EX and DTS ES software with a rear center speaker. The display changes AUTO → Discrete 6.1 → Matrix 6.1 → OFF each time **EX/ES** is tapped.

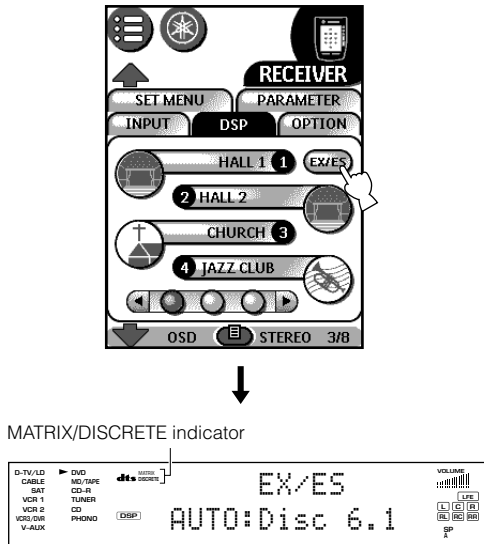

AUTO: This mode automatically switches Dolby Digital EX/DTS ES Matrix 6.1/DTS ES Discrete 6.1 depending on the signal in the input source that this unit can detect. Rear center speaker does not work for 5.1 channel sources.

Discrete 6.1: This mode can be selected when the source with DTS ES Discrete format has been detected. (The “DISCRETE” indicator lights up.)

Matrix 6.1: This mode makes 6-channel playback of the input source with Matrix or Matrix compatible format through the Matrix 6.1 decoder. (The “MATRIX” indicator lights up.)

OFF: Rear center speaker does not work in this mode.

Cautions

- Some 6.1-channel compatible discs do not have the signal (flag) which this unit can automatically detect. When playing this kind of discs with 6.1 channel, select “Matrix 6.1”.
- 6.1-channel playback is not possible even if **EX/ES** is tapped in the following cases:
 - ① when “1C REAR L/R SP” is set to “NONE”
 - ② when the sound effect is turned off
 - ③ when the source connected to the **6CH INPUT** jack is being played
 - ④ when Dolby Digital KARAOKE source is being played

■ Selecting PRO LOGIC, PRO LOGIC II or Neo: 6

You can enjoy the 2-channel sources decoded into five or six discrete channels by selecting PRO LOGIC, PRO LOGIC II or Neo: 6 in the program No. 12.

1 Select a 2-channel source and start playback on the source component.

2 Select the decoder.

Tap **▲** or **▼** on the DSP control panel repeatedly to open the third DSP control panel (page 5/8). Then tap **DOLBY/DTS SUR.** or **PRO LOGIC** repeatedly to select the decoder; PRO LOGIC, PRO LOGIC II, and Neo: 6.

The decoder selection switches among PRO LOGIC, PRO LOGIC II and Neo: 6 on the front panel display.

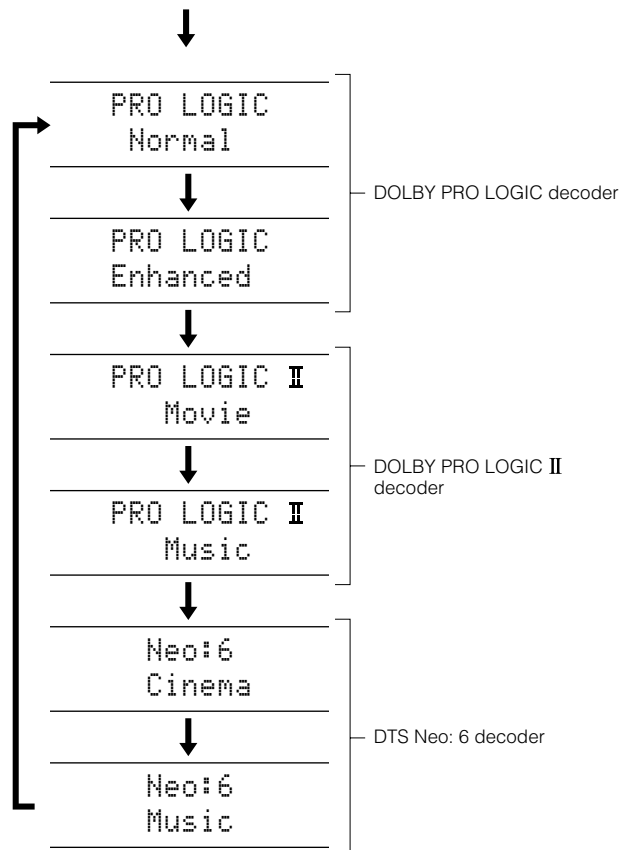

Cautions

- Playback using DOLBY PRO LOGIC II and DTS Neo: 6 decoders is possible only for 2-channel signals.
- **PROGRAM** </> on the front panel can be also used to select these programs.

■ Virtual CINEMA DSP

With the Virtual CINEMA DSP, you can enjoy all the DSP programs without rear speakers. It creates the virtual speakers to reproduce the natural sound field.

The sound field processing is changed to the Virtual CINEMA DSP mode according to the selected DSP program by setting "1C REAR L/R SP" on the SET MENU to "NONE".

Caution

- This unit is not set in the virtual CINEMA DSP mode even if "1C REAR L/R SP" is set to "NONE" in the following cases:
 - ① when the 8ch Stereo, DOLBY DIGITAL Normal, PRO LOGIC Normal, PRO LOGIC II, DTS Normal or Neo: 6 program is selected;
 - ② when the sound effect is turned off
 - ③ when connecting the headphones
 - ④ when **6CH INPUT** is selected as the input source
 - ⑤ when over 96 kHz sampling digital signals are being input

■ SILENT CINEMA DSP

You can enjoy the powerful sound field as if there were actual speakers with the SILENT CINEMA DSP. You can listen to SILENT CINEMA DSP by connecting your headphones to the **PHONES** jack while the digital sound field processor is on. Enjoy all the DSP program using the headphones. The "SILENT" indicator lights up on the front panel display. (If the sound effect is off, you listen to the source with normal stereo reproduction.)

Caution

- This unit is not set in the SILENT CINEMA DSP mode even if the sound effect is on in the following cases:
 - ① when over 96 kHz sampling digital signals are being input
 - ② when the sound effect is turned off
 - ③ when **6CH INPUT** is selected as the input source

■ DTS 96/24

Be aware the following points when the DTS 96/24 signal is being input.

- Select the subprogram "NORMAL" in "DOLBY DIGITAL/DTS SURROUND" among CINEMA DSP programs in order to decode the DTS 96/24 signals correctly.
- Tap **EX/ES** while the DTS 96/24 signals are being input for matrix 6.1 playback.
- DTS 96/24 decoder functions only for those two cases described above. In other cases, necessary process such as sound effect addition and down mixing is given depending on the sampling frequency of the input signals.

96kHz/24bit indicator lights up when the DTS 96/24 signal is input to this unit.

TUNING

Automatic and manual tuning

There are 2 ways of tuning; automatic and manual.

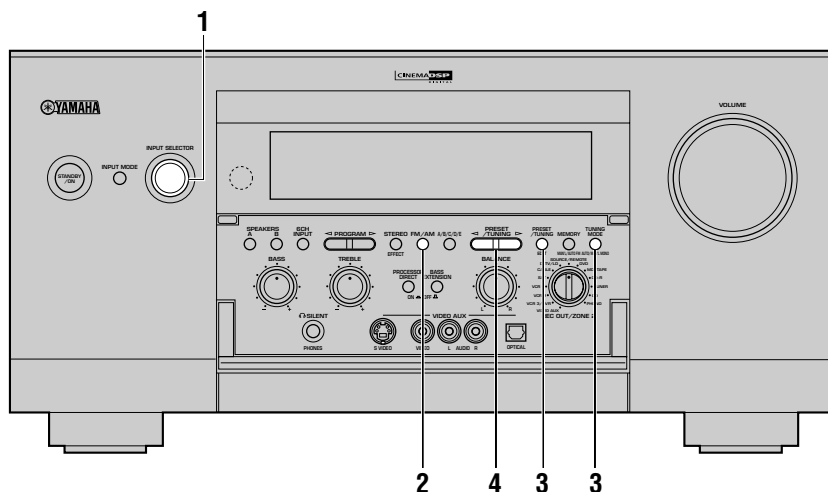

Automatic tuning

Automatic tuning is effective when station signals are strong and there is no interference.

1 Use **INPUT SELECTOR** (TUNER) on the **INPUT** control panel) to select **TUNER** as the input source.

2 Press **FM/AM** to select the reception band. “FM” or “AM” appears on the front panel display.

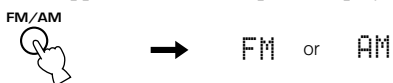

3 Press **TUNING MODE (AUTO/MAN'L MONO)** so that the “AUTO” indicator lights up on the front panel display.



If the colon (:) appears on the front panel display on the left of the band indication (“FM” or “AM”), press **PRESET/TUNING EDIT** to turn it off.

4 Press **PRESET/TUNING** once to begin automatic tuning.

Press \triangleright to tune in to a higher frequency, or press \triangleleft to tune in to a lower frequency.

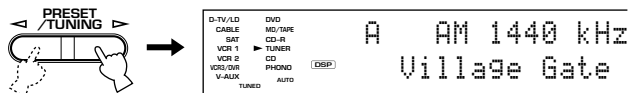

When tuned in to a station, the “TUNED” indicator lights up and the frequency of the received station is shown on the front panel display.

Note

- Use the manual tuning method if the tuning search does not stop at the desired station because the signal is weak.

Manual tuning

If the signal from the station you want to select is weak, you must tune in to it manually.

1 Use **INPUT SELECTOR** (TUNER) on the **INPUT** control panel) to select **TUNER** as the input source.

2 Press **FM/AM** to select the reception band. “FM” or “AM” appears on the front panel display.

3 Press **TUNING MODE (AUTO/MAN'L MONO)** so that the “AUTO” indicator goes off from the front panel display.



If the colon (:) appears on the front panel display on the left of the band indication (“FM” or “AM”), press **PRESET/TUNING EDIT** to turn it off.

4 Press **PRESET/TUNING** to tune in to the desired station manually.

Hold down the button to continue the tuning search.

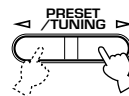

Note

- Manually tuning in to an FM station will automatically change the reception mode to monaural to increase the signal quality.

Presetting stations

Automatically presetting stations (for FM stations)

You can use the automatic preset tuning feature to store FM stations. This function enables this unit to automatically tune in to FM stations with strong signals, and to store up to 40 (8 stations x 5 groups) of those stations in order. This feature enables you to easily tune in to any preset station by selecting the preset station number (see page ___).

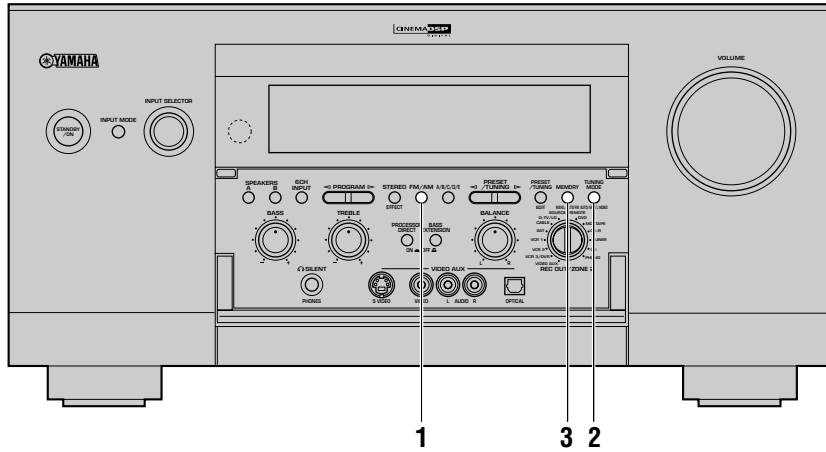

1 Press FM/AM to select the FM band.



2 Press TUNING MODE (AUTO/MAN'L MONO) so that the "AUTO" indicator lights up on the front panel display.



3 Press and hold MEMORY (MAN'L/AUTO FM) for more than 3 seconds.

The preset number, the "MEMORY" and "AUTO" indicators flash. Then, after about 5 seconds, automatic preset tuning begins from the frequency currently displayed toward the higher frequencies.

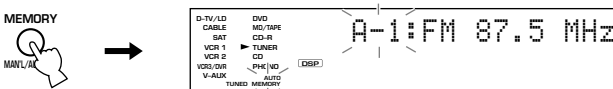

When automatic preset tuning is completed, the front panel display shows the frequency of the last preset station.

Notes

- Any stored station data existing under a preset number is cleared when you store a new station under that preset number.
- When a station data is stored under a preset number, the frequency and reception band are also stored.
- You can manually replace a preset station with another FM or AM station by simply following the procedure in the section "Manually presetting stations" on page ___.
- If the number of the received stations does not reach E-8, automatic preset tuning has automatically stopped after searching all stations.
- Only FM stations with sufficient signal strength are stored automatically by automatic preset tuning. If the station you want to store is weak in signal strength, tune in to it manually in the monaural mode, and store it by following the procedure in "Manually presetting stations" on page ___.

Automatic preset tuning options

You can select the preset number from which this unit will store FM stations and/or begin tuning toward lower frequencies. After pressing **MEMORY** in step 3:

1. Press **A/B/C/D/E** and **PRESET/TUNING** <F> to select the preset number under which the first station will be stored. Automatic preset tuning will stop when stations have all been stored up to E-8.
2. Press **PRESET/TUNING EDIT** to turn off the colon (:) and then press **PRESET/TUNING** <L> to begin tuning toward lower frequencies.

Memory back-up

The memory back-up circuit prevents the stored data from being lost even if this unit is set in the standby mode, the power cord is disconnected from the AC outlet, or the power supply is temporarily cut due to power failure. However, if the power is cut for more than one week, the preset stations may be cleared. If so, store the stations again by using the presetting station methods.

Manually presetting stations

You can also store up to 40 stations (8 stations x 5 groups) manually.

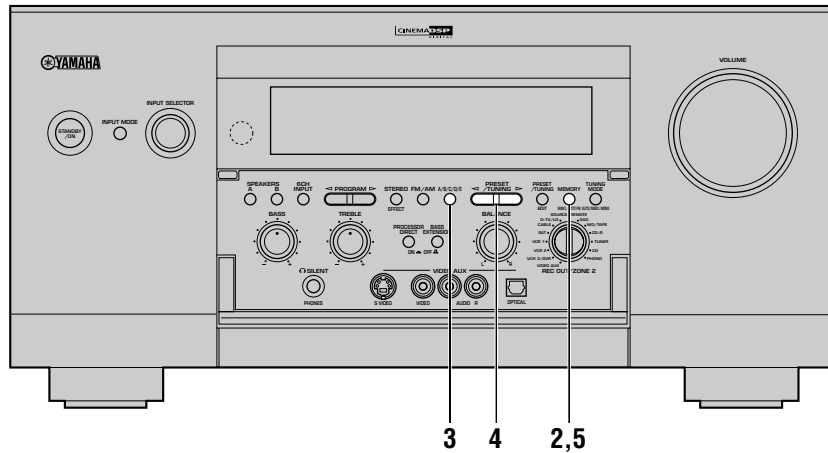

1 Tune in to a station.

See page __ for tuning instructions.

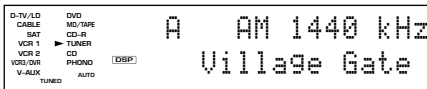

When tuned in to a station, the front panel display shows the frequency of received station.

2 Press MEMORY (MAN'L/AUTO FM).

The "MEMORY" indicator flashes for about 5 seconds.

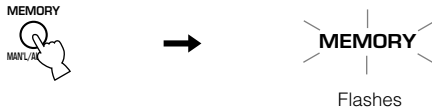

3 Press A/B/C/D/E repeatedly to select a preset station group (A to E) while the "MEMORY" indicator is flashing.

The group letter appears and make sure that the colon (:) appears on the front panel display on the left of the band indication ("FM" or "AM").

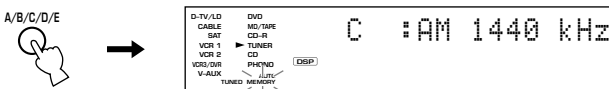

4 Press PRESET/TUNING </> to select a preset station number (1 to 8) while the "MEMORY" indicator is flashing.

Press > to select a higher preset station number. Press < to select a lower preset station number.

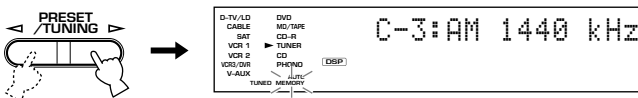

5 Press MEMORY (MAN'L/AUTO FM) on the front panel while the "MEMORY" indicator is flashing.

The station band and frequency appear on the front panel display.

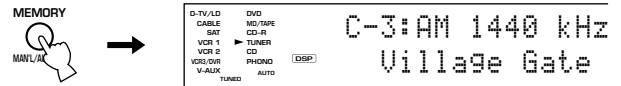

Shows the displayed station has been stored as C-3.

6 Repeat steps 1 to 5 to store other stations.

Notes

- Any stored station data existing under a preset number is cleared when you store a new station under that preset number.
- The reception mode (stereo or monaural) is stored along with the station frequency.

Preset stations

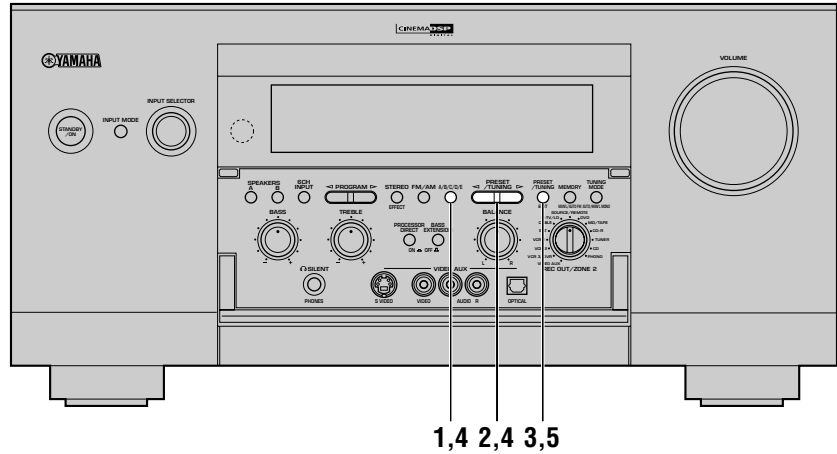
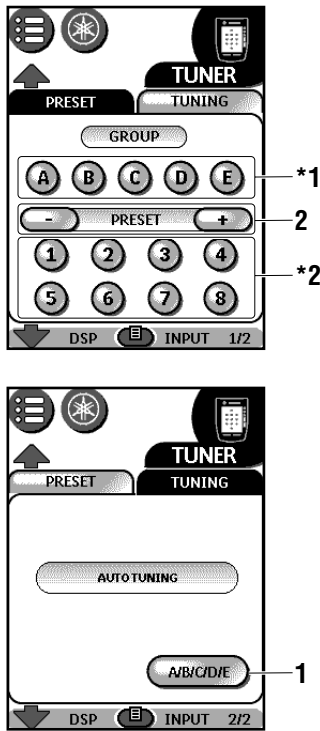

- *1 These buttons can be used to directly select the preset group.
- *2 These buttons can be used to directly select the preset station number 1 to 8.

Tuning in to a preset station

You can tune any desired station simply by selecting the preset station number under which it was stored.

Note

- For the remote control operations, you need to switch the display of the touch screen to the TUNER control panels. See page ___ for detailed information.

- 1 Press **A/B/C/D/E** (or tap **A/B/C/D/E** on the TUNING control panel of the remote control) to select the preset station group.
The preset group letter appears on the front panel display and changes each time you press **A/B/C/D/E** (or tap **A/B/C/D/E**).



- 2 Press **PRESET/TUNING** </> (or tap **PRESET** </> on the PRESET control panel of the remote control) to select a preset station number (1 to 8).

The preset group and number appear on the front panel display along with the station band, frequency and the "TUNED" indicator lights up.

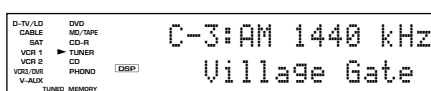

Exchanging preset stations

You can exchange the assignment of two preset stations with each other. The example below describes the procedure for exchanging preset station "C-3" with "A-5".

- 1 Press **A/B/C/D/E** (or tap **A/B/C/D/E** on the TUNING control panel of the remote control) to select the preset station group.
- 2 Press **PRESET/TUNING** </> (or tap **PRESET** </> on the PRESET control panel of the remote control) to select a preset station number (1 to 8).
- 3 Press and hold **PRESET/TUNING EDIT** for more than 3 seconds.
"C-3" and the "MEMORY" indicator flash on the front panel display.

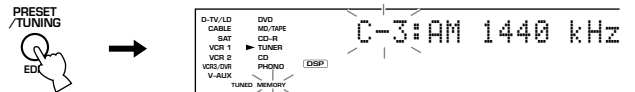

- 4 Tune in to preset station "A-5" by using **A/B/C/D/E** and **PRESET/TUNING** </>.

- 5 Press **PRESET/TUNING EDIT** again.

The stations stored at the two preset assignments are exchanged.

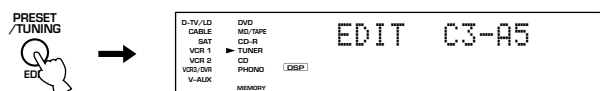

Shows the exchange of stations has been completed.

BASIC RECORDING

REC OUT/ZONE 2 allows you to record one source while viewing and/or listening to another source.

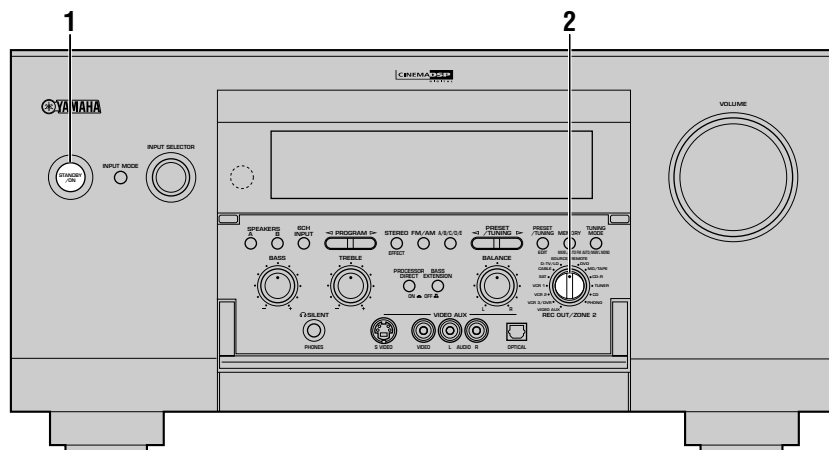

1 Turn on the power to this unit and all connected components.

2 Select the source component you want to record from by using **REC OUT/ZONE 2**.

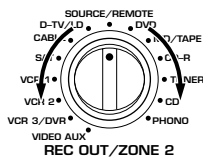

To record the current input source that you are watching or listening to, set **REC OUT/ZONE 2** to **SOURCE/REMOTE**. To record the other source than the one that you are watching or listening to, set **REC OUT/ZONE 2** to the source you want to record.

3 Start playback (or select a broadcast station) on the source component.

4 Start recording on the recording component.

Notes

- Do a test recording before you start an actual recording.
- It is not possible to record the sound effect created by this unit's DSP processing.
- When this unit is set in the standby mode, you cannot record between other components connected to this unit.
- Operating **BASS** and **TREBLE**, **BASS EXTENSION**, **BALANCE**, **VOLUME**, and DSP programs do not affect the recorded signal.
- Setting **REC OUT/ZONE 2** to **SOURCE/REMOTE** and using the BGV function (see page __) allows the recording of audio and video from a different source.
- Use **INPUT SELECTOR** to switch the source from the one you are watching or listening to while making recording with **REC OUT/ZONE 2** set to the source component you are recording from.

Cautions

- A given input source is not output on the same **REC OUT** channel. (For example, the signal input from **VCR 1 IN** is not output on **VCR 1 OUT**.)
- S-video and composite video signals pass independently through this unit's video circuits. Therefore, when recording or dubbing video signals, if your video source component is connected to provide only an S-video (or only a composite video) signal, you can record only an S-video (or only a composite video) signal by your VCR.
- **DIGITAL OUTPUT** jacks and analog **OUT (REC)** jacks are independent. Only digital signals are output from **DIGITAL OUTPUT** jacks and analog signals from **OUT (REC)** jacks.
- A source connected to the **6CH INPUT** jacks of this unit cannot be recorded.
- The **LD RF (AC-3)** input signal cannot be output using **REC OUT/ZONE 2**.
- Check the copyright laws in your country to record from records, CDs, radio, etc. Recording of copyrighted material may infringe copyright laws.

Special considerations when recording DTS software

The DTS signal is a digital bitstream. Attempting to digitally record the DTS bitstream will result in noise being recorded. Therefore, if you want to use this unit to record sources that have DTS signals recorded on them, the following considerations and adjustments need to be made. For LDs, DVDs and CDs encoded with DTS, when your player is compatible with the DTS format, follow its operation instruction to make a setting so that the analog signal will be output from the player.

Advanced operation

This section explains SET MENU setting, remote control features and the other functions.

SET MENU ITEMS	52
Operating the SET MENU	53
1 SPEAKER SET	54
2 LOW FREQ. TEST	54
3 HP TONE CTRL (headphone tone control)	55
4 CENTER GEQ (center graphic equalizer)	55
5 REAR CT GEQ (rear center graphic equalizer)	55
6 CINEMA EQ	56
7 INPUT RENAME	57
8 I/O ASSIGNMENT	58
9 INPUT MODE (initial input mode)	59
10 PARAMETER INI (parameter initialization)	59
11 LFE LEVEL	59
12 DYNAMIC RANGE	60
13 SP DELAY	60
14 AUDIO DELAY	61
15 DISPLAY SET	62
16 MEMORY GUARD	62
17 ZONE2 SET	63
18 6CH INPUT SET	63
REMOTE CONTROL FEATURES	64
Using the remote control	64
Setting the manufacturer code	66
Programming a new remote control function (Learn feature)	68
Each component control area	70
Using the Macro feature	75
Changing the source name in the display window	78
Clearing a learned function or macro	79
Clearing learned functions, macros, renamed source names, and setup manufacturer codes	80
ADJUSTING THE LEVELS OF THE EFFECT SPEAKERS	81
SLEEP TIMER	82
ZONE 2	83
Connections	83
Remote control in ZONE 2	84

SET MENU ITEMS

The SET MENU consists of eighteen items including the Speaker Set, Center Graphic Equalizer and Parameter Initialization features. Choose the appropriate item and adjust or select the values as necessary.

Notes

- You can adjust the items in the SET MENU while reproducing a source.
- We recommend that you adjust the items in the SET MENU while using a video monitor. It is easier to see the video monitor screen than it is to see the front panel display on this unit while adjusting SET MENU items.

1 SPEAKER SET	1A CENTER SP	Selects the output mode suitable for your center speaker.
	1B MAIN SP	Selects the output mode suitable for your main speakers.
	1C REAR L/R SP	Selects the output mode suitable for your rear speakers.
	1D REAR CT SP	Selects the output mode suitable for your rear center speaker.
	1E LFE/BASS OUT	Selects the speakers for your LFE/BASS signal output.
	1F FRONT EFCT SP	Selects the output mode for your front effect speakers.
	1G MAIN LEVEL	Selects the output level for your main channels.
2 LOW FREQ. TEST	Matches the subwoofer level with the level of the other speakers.	
3 HP TONE CTRL	Adjusts the tonal balance of the headphones.	
4 CENTER GEQ	Matches the center speaker tonal quality with the main speakers.	
5 REAR CT GEQ	Matches the rear center speaker tonal quality with the rear speakers.	
6 CINEMA EQ	Adjusts the tonal balance of the main and center speakers, front effect speakers, rear speakers and rear center speaker separately.	
7 INPUT RENAME	Changes the name of the inputs.	
8 I/O ASSIGNMENT	Assigns the I/O terminals to the designated input sources.	
9 INPUT MODE	Selects the initial input mode of the sources.	
10 PARAMETER INI	Initializes the parameters of a group of DSP programs.	
11 LFE LEVEL	Adjusts the output level of the LFE channel for Dolby Digital or DTS signals.	
12 DYNAMIC RANGE	Adjusts the dynamic range for Dolby Digital signals.	
13 SP DELAY	Adjusts the delay time for center and rear center speakers.	
14 AUDIO DELAY	Adjusts the delay time for all channels.	
15 DISPLAY SET	Sets the background or position of on screen displays and changes the brightness of this unit's front panel display.	
16 MEMORY GUARD	Locks DSP program parameters and other SET MENU settings.	
17 ZONE2 SET	Selects the mode of Zone 2.	
18 6CH INPUT SET	Sets the destination of the center channel and subwoofer channel signals that are input into the 6CH INPUT jacks.	

Operating the SET MENU

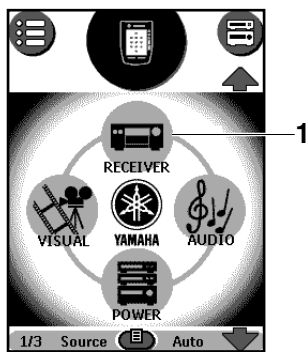

Adjustment should be made with the remote control.

Note

• Some items require extra steps to change to the desired setting.

- 1 Tap on the Home menu to open the RECEIVER control panels.
- 2 Tap (▼ or ▲ repeatedly) to open the SET MENU control page (page 7/8).
- 3 Tap or repeatedly to select the item (1 to 18) you want to adjust.

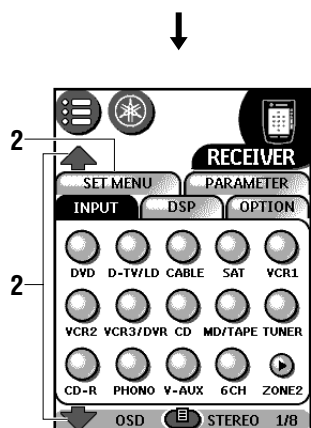
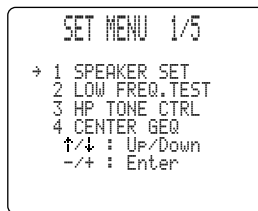

- 4 Tap or once to enter the setup mode of the selected item.
The last setting you adjusted appears on the video monitor or on the front panel display. Depending on the item, tap or to select a sub item.

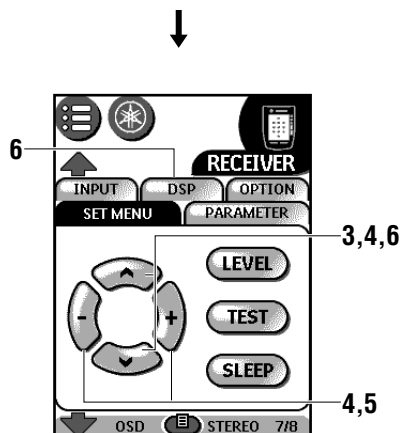
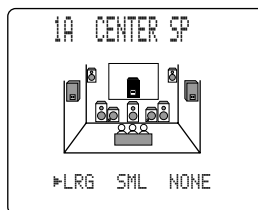

- 5 Tap or repeatedly to change the setting of the item.
- 6 Tap or repeatedly until the DSP program name appears or tap and select one of the DSP program to exit from the SET MENU.

1 SPEAKER SET

Set the speaker mode depending on your speaker system. See “SPEAKER MODE SETTINGS” on pages ___ to ___ for details about the setting items.

2 LOW FREQ. TEST

Use this feature to adjust the output level of the subwoofer so it matches that of the other speakers in your configuration.

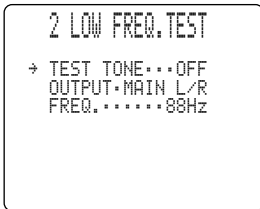

1 Tap **+** or **-** to set “TEST TONE” to “ON”.

Cautions

- “ON” cannot be selected when the headphones are being used.
- Setting turns to “OFF” if the headphones are connected during testing.
- While the test tone is being output, the source sound cannot be output.

2 Adjust the volume with VOL +/- so you can hear the tone.

Cautions

- Do not turn up the volume too high.
- If no test tone is heard, turn down the volume, set this unit in the standby mode and make sure all the necessary connections are correct.

3 Tap **Output** to go to “OUTPUT” and tap **+** or **-** to select the speaker you want to compare with the subwoofer.

If “SWFR” is selected, the test tone above 90 Hz will not be output from the subwoofer. The test tone will not necessarily be output from the selected speakers. The output mode of the test tone depends on the settings of “1 SPEAKER SET” on the SET MENU.

4 Tap **FREQ.** to go to “FREQ.” and tap **+** or **-** to select the frequency you want to use.

Set the center frequency (35 – 250 Hz or “35-250Hz”) to check that the subwoofer level matches that of the other speakers.

5 Adjust the volume of the subwoofer with the controls on the subwoofer so it matches that of the speaker you are comparing it to.

■ About the test tone

Digital generator
(wide band noise produced)

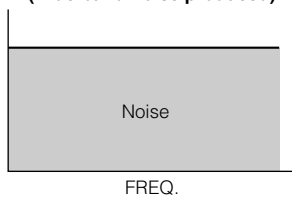

Band pass filter

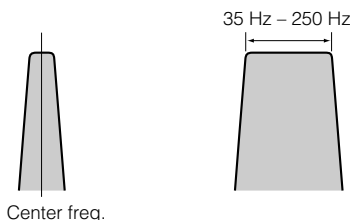

- The test tone is produced by the tone generator. The tone generator produces a narrow-band noise centered on a specified frequency by the band pass filter.
- You can change this center frequency from 35 Hz through 250 Hz in one-sixth octave steps.
- You can use the test tone not only for adjusting the subwoofer level, but also for checking the low-frequency characteristics of your listening room. Low-frequency sounds are especially affected by the listener’s position, speaker placement, subwoofer polarity and other conditions.

3 HP TONE CTRL (headphone tone control)

Use this feature to adjust the level of the bass and treble when you use your headphones.

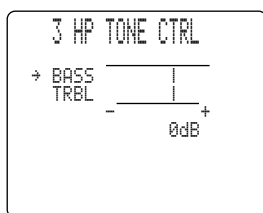

Control range (dB): -6 – +3 for both BASS and TRBL (treble)
Initial setting: 0 dB for both BASS and TRBL (treble)

- 1 Select “BASS” or “TRBL”.
- 2 Tap or to change each level.

4 CENTER GEQ (center graphic equalizer)

Use this feature to adjust the built-in 5-band graphic equalizer so that the center speaker tonal quality matches that of the left and right main speakers.

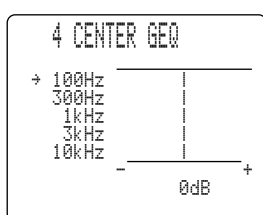

Control range (dB): -6 – +6
Initial setting: 0 dB for 5-band

- 1 Tap to select a higher frequency and tap to select a lower frequency.
You can select the 100 Hz, 300 Hz, 1 kHz, 3 kHz, or 10 kHz frequencies.
- 2 Tap or to adjust the level of that frequency.

Note

- You can monitor the center speaker sound while adjusting this item by using the test tone. Tap on the PARAMETER control panel before starting the foregoing procedure. “TEST DOLBY SUR.” (or “TEST DSP”) appears on the video monitor, and the test tone starts alternating among the speakers. Once you begin this procedure, the test tone remains at the center speaker and you can hear how the sound changes as you adjust the various frequency levels. To stop the test tone, tap (see pages ___ and ___).

5 REAR CT GEQ (rear center graphic equalizer)

Use this feature to adjust the built-in 5-band graphic equalizer so the rear center speaker tone matches that of the left and right rear speakers.

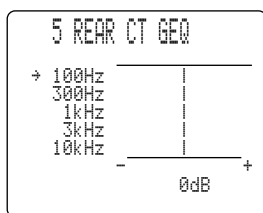

Control range (dB): -6 – +6
Initial setting: 0 dB for 5-band

- 1 Tap to select a higher frequency and Tap to select a lower frequency.
You can select the 100 Hz, 300 Hz, 1 kHz, 3 kHz, or 10 kHz frequencies.
- 2 Tap or to adjust the level of that frequency.

Note

- You can monitor the center speaker sound while adjusting this item by using the test tone. Tap on the PARAMETER control panel before starting the foregoing procedure. “TEST DOLBY SUR.” (or “TEST DSP”) appears on the video monitor, and the test tone starts alternating among the speakers. Once you begin this procedure, the test tone remains at the rear center speaker and you can hear how the sound changes as you adjust the various frequency levels. To stop the test tone, tap (see pages ___ and ___).

6 CINEMA EQ

Use this feature to match the tonal quality of four groups of speakers: the main and center speaker group, the front effect speakers group, the rear speakers group, and the rear center speaker group. CINEMA-EQ consists of a high-shelving equalizer (HIGH) and a parametric equalizer (PEQ). The high-shelving equalizer changes high frequency characteristics, and the parametric equalizer boosts or cuts any selected frequency. The equalizer can be used for a variety of purposes, such as adjusting the tonal quality of differing types of speakers, adjusting the tonal quality in different installation environments, or adjusting the source sound to your liking.

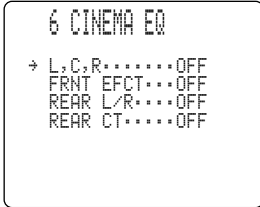

1 Tap or repeatedly to select one of the speaker groups and tap or to select “ON”.

2 Tap or several times to display the setting screen for the channel to be set.

There are 4 groups (6A – 6D) to be set.

Caution

- If “OFF” is selected in step 1, the setting screen for that group will not be displayed.

3 Tap or to select the item to be adjusted.

Select one item at each time from “FRQ”/”GAIN” for “HIGH” and “FRQ”/”GAIN” for “PEQ”.

4 Adjust the value for the item by tapping or .

“FRQ” (frequency) for “HIGH” is to set the turn over frequency and “PEQ” for the band central frequency. The amplification increases for higher “GAIN” value while the attenuation increases for lower “GAIN” value.

Notes

- When any change has been made on the initial setting, * (asterisk) will be placed in front of its parameter name.
- CINEMA-EQ does not work when you press **STEREO/EFFECT** or the right button (labeled “STEREO”) on the remote control to turn off the effect.
- While “TEST DOLBY SUR.” or “TEST DSP” is being activated, the test tones are output as described below.
 - ① **6A L,C,R EQ:** The test tones are output from the main L/R and center channels. (When “1A CENTER SP” is set to “NONE”, the test tones are output from the main L/R only.)
 - ② **6B FRNT EFCT EQ:** The test tones are output from the front effect channels.
 - ③ **6C REAR L/R EQ:** The test tones are output from the rear L/R channels.
 - ④ **6D REAR CT EQ:** The test tones are output from the rear center channels.

■ 6A L, C, R EQ (main L/center/main R equalizer)

Use this feature to adjust the tonal quality of the main L/R and center channels.

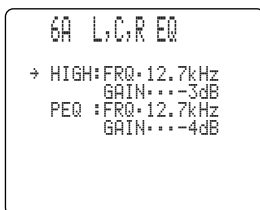

Control range: 1.0 kHz – 12.7 kHz (HIGH: FRQ, PEQ: FRQ),
-9 dB – +6 dB (HIGH: GAIN, PEQ: GAIN)

Initial setting: 12.7 kHz (HIGH: FRQ, PEQ: FRQ), -3 dB (HIGH: GAIN),
-4 dB (PEQ: GAIN)

6B FRNT EFCT EQ (front effect equalizer)

Use this feature to adjust the tonal quality of the front effect channels.

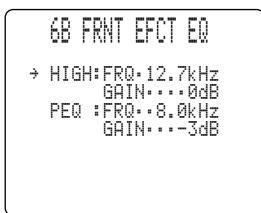

Control range: 1.0 kHz – 12.7 kHz (HIGH: FRQ, PEQ: FRQ),
-9 dB – +6 dB (HIGH: GAIN, PEQ: GAIN)

Initial setting: 12.7 kHz (HIGH: FRQ), 8.0 kHz (PEQ: FRQ),
0 dB (HIGH: GAIN), -3 dB (PEQ: GAIN)

6C REAR L/R EQ (rear L/R equalizer)

Use this feature to adjust the tonal quality of the rear L/R channels.

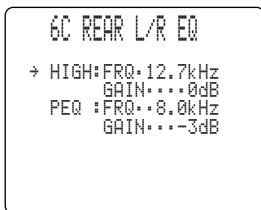

Control range: 1.0 kHz – 12.7 kHz (HIGH: FRQ, PEQ: FRQ),
-9 dB – +6 dB (HIGH: GAIN, PEQ: GAIN)

Initial setting: 12.7 kHz (HIGH: FRQ), 8.0 kHz (PEQ: FRQ),
0 dB (HIGH: GAIN), -3 dB (PEQ: GAIN)

6D REAR CT EQ (rear center equalizer)

Use this feature to adjust the tonal quality of the rear center channel.

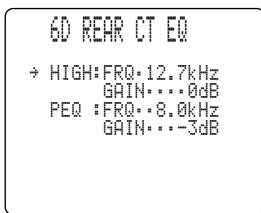

Control range: 1.0 kHz – 12.7 kHz (HIGH: FRQ, PEQ: FRQ),
-9 dB – +6 dB (HIGH: GAIN, PEQ: GAIN)

Initial setting: 12.7 kHz (HIGH: FRQ), 8.0 kHz (PEQ: FRQ),
0 dB (HIGH: GAIN), -3 dB (PEQ: GAIN)

7 INPUT RENAME

Use this feature to change the name of the input which appears on the OSD or the front panel display.

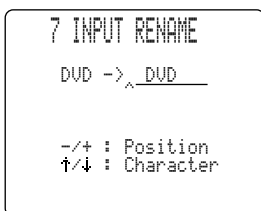

- 1 Select the input you want to change the name of by tapping an input selector button on the INPUT control panel.
- 2 Tap or to place the “^” under the space or the character you want to edit.
- 3 Tap or to select the character you want to use.
Tap to change the character in the following order, or tap to go in the reverse order.
A – Z, a space, 0 – 9, a space, a – z, a space, #, *, +, and so on.
- 4 Tap or to move to the next one.
- 5 Tap or repeatedly to exit the INPUT RENAME mode.

8 I/O ASSIGNMENT

It is possible to assign jacks according to the component to be used if this unit's **COMPONENT VIDEO INPUT** jack or **DIGITAL INPUT/OUTPUT** jack settings (component names for jacks) differ from that component. This makes it possible to change the jack assignment and effectively connect more component.

Once you assign, you can select that component with **INPUT SELECTOR** (the input selector buttons on the INPUT control panel of the remote control).

Caution

- You cannot assign the same component for different jacks of each item (8A – 8D).

■ 8A <1> to <4> COAXIAL INPUT jacks

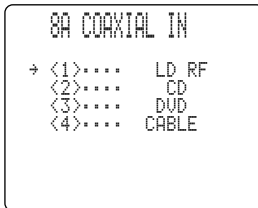

Choices:

LD RF (<1> only), V-AUX, VCR3/DVR, VCR2, VCR1, SAT, CABLE, D-TV/LD, DVD, MD/TAPE, CD-R, CD, PHONO

Initial settings:

<1> LD RF, <2> CD, <3> DVD, <4> CABLE

■ 8B <5> and <6> OPTICAL OUTPUT jacks



Choices:

CD-R, CD, PHONO, V-AUX, VCR3/DVR, VCR2, VCR1, SAT, CABLE, D-TV/LD, DVD, MD/TAPE

Initial settings:

<5> CD-R, <6> MD/TAPE

■ 8C <7> to <12> OPTICAL INPUT jacks

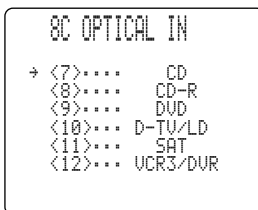

Choices:

CD, PHONO, VCR3/DVR, VCR2, VCR1, SAT, CABLE, D-TV/LD, DVD, MD/TAPE, CD-R

Initial settings:

<7> CD, <8> CD-R, <9> DVD, <10> D-TV/LD, <11> SAT, <12> VCR3/DVR

■ 8D [A] to [C] COMPONENT VIDEO INPUT jacks



Choices:

DVD, V-AUX, VCR3/DVR, VCR2, VCR1, SAT, CABLE, D-TV/LD

Initial settings:

[A] DVD, [B] D-TV/LD, [C] SAT

9 INPUT MODE (initial input mode)

Use this feature to designate the input mode for sources connected to the **COAXIAL (OPTICAL) IN** jacks when you turn on this unit (see page __ for details about the input mode).

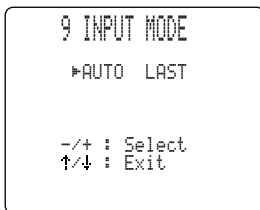

Choices: AUTO, LAST
Initial setting: AUTO

AUTO: Select this to allow this unit to automatically detect the type of input signal and select the appropriate input mode.
LAST: Select this to set this unit to automatically select the last input mode used for that source.

Caution

- Even if “LAST” is selected, the setting for **EX/ES** is not stored in memory.

10 PARAMETER INI (parameter initialization)

Use this feature to initialize the parameters for each DSP program within a DSP program group. When you initialize a DSP program group, all of the parameter values within that group revert to their initial settings.

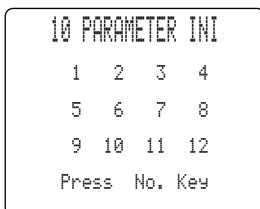

Press the corresponding numeric button for the DSP program that you want to initialize. The asterisk (*) next to the program number means that the parameter values have been changed.

Cautions

- You cannot initialize the individual DSP programs within a group separately.
- The parameter values of the DSP programs do not change if you initialize a program group that does not have the asterisk mark (*).
- When “16 MEMORY GUARD” is set to “ON” (see page __), you cannot initialize any program groups.
- Once you initialize a DSP program group, you cannot automatically revert to the previous parameter settings.

11 LFE LEVEL

Use this feature to adjust the output level of the LFE (low-frequency effect) channel when playing back a Dolby Digital or DTS signal. The LFE signal carries the low-frequency special effect sound which is only added to certain scenes.



Control range (dB): -20 – 0 for both SPEAKER and HEADPHONE
Initial setting: 0 dB for both SPEAKER and HEADPHONE

- 1 Tap or to select the item to be adjusted.
- 2 Tap or to adjust the LFE level.

Note

- Adjust the LFE level according to the capacity of your subwoofer or headphones.

12 DYNAMIC RANGE

Use this feature to adjust the dynamic range. This setting is effective only when this unit decodes Dolby Digital signals.

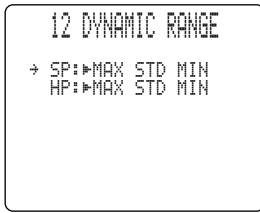

Choices: MAX, STD, MIN
Initial setting: MAX (for both speakers and headphones)

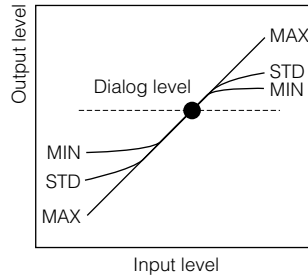

MAX: Select the "MAX" setting for feature films.
STD: Select the "STD" (Standard) setting for general use.
MIN: Select the "MIN" setting for listening to sources at extremely low volume levels.

Caution

- Some types of the Dolby Digital software do not support "MIN" for the dynamic range. If "MIN" is selected to play this type of software, the volume may be extremely lowered. If this problem occurs, select "MAX" or "STD".

13 SP DELAY

Use this feature to adjust the delay of the center and the rear center channel sounds. This feature works when there is sound output from the center speakers, with a source like Dolby Digital or DTS, etc.

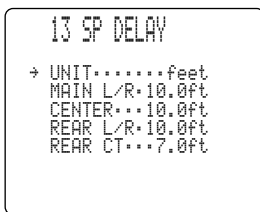

Ideally, the center speaker and the rear center speaker should be the same distance from the main listening position as the left and right main speakers. However, in most home situations, the center speaker or the rear center speaker is placed in line with the main speakers or the rear speakers. By delaying the sound from the center speaker and the rear center speaker, the apparent distance from the center speaker and the rear center speaker to the main listening position can be adjusted to make it seem the same as the distance between the left and right main speaker, and the left and right rear speakers to the listening position. Adjusting the delay time for the center speaker is especially important for giving depth to the dialogue.

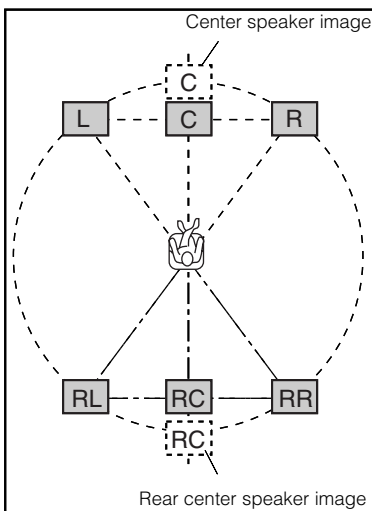

1 Tap or to select "UNIT".

2 Tap or to select the unit to be used for setting.
 Select one from "msec", "meters", and "feet".

Notes

- Setting items change depending on the unit chosen.
- When "meters" or "feet" is selected, enter the distance from your listening position to each speaker.

3 Tap or to select the speaker for which the delay is adjusted.

4 Tap or to set the delay.

Tap for higher value and for lower value.

■ Setting by “msec”

```

13 SP DELAY
→ UNIT.....msec
  CENTER.....0ms
  REAR CT...3.0ms
  
```

Control range: 0 – 5.0 ms (for center), 0 – 30.0 ms (for rear center)
Initial settings: 0 ms (for center), 3.0 ms (for rear center)

■ Setting by “meters”

```

13 SP DELAY
→ UNIT.....meters
  MAIN L/R...3.04m
  CENTER...3.04m
  REAR L/R...3.04m
  REAR CT...2.13m
  
```

Control range: 0.15 – 30.48 m (for main L/R, center, rear L/R, rear center)
Initial settings: 3.04 m (for main L/R, center, rear L/R), 2.13 m (for rear center)

■ Setting by “feet”

```

13 SP DELAY
→ UNIT.....feet
  MAIN L/R...10.0ft
  CENTER...10.0ft
  REAR L/R...10.0ft
  REAR CT...7.0ft
  
```

Control range: 0.5 – 100 ft (for main L/R, center, rear L/R, rear center)
Initial settings: 10.0 ft (for main L/R, center, rear L/R), 7.0 ft (for rear center)

Caution

- No delay will be set if the same distance is set for the main L/R and center, or the rear L/R and rear center with “meters” or “feet” selected.

14 AUDIO DELAY

Use this feature to adjust the delay time of all channel sounds, when this unit decodes DTS or Dolby Digital signals. Adjusting “AUDIO DELAY” is especially important for matching the sounds to screen pictures.

```

14 AUDIO DELAY
      0ms
  
```

Control range: 0 – 160 ms
Initial setting: 0 ms

Note

- This feature is effective when the Dolby Digital, DTS or PCM (with the sampling frequency lower than 96 kHz) signal is being played. The set value can be used for either format and applies to all channels.

15 DISPLAY SET

Use this feature to set the background and the location of the OSD, and the brightness of this unit's front panel display.

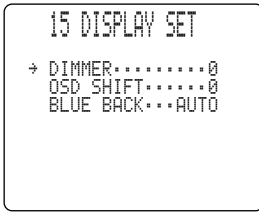

■ DIMMER

You can adjust the brightness of the front panel display.

Control range: -4 - 0
Initial setting: 0

■ OSD SHIFT (OSD off-set position)

This setting is used to adjust the vertical position of the OSD.

Control range: +5 (downward) - -5 (upward)
Initial setting: 0

Tap to lower the position of the OSD. Tap to raise the position of the OSD.

■ BLUE BACK

This item sets the OSD background.

Choices: AUTO, OFF
Initial setting: AUTO

AUTO: Blue background is displayed when no video signal is being input.
OFF: Nothing is displayed when no video signal is being input.

Caution

- With “OFF” selected, no on-screen display is shown on the video monitor when no video signal is being input.

16 MEMORY GUARD

Use this feature to prevent accidental changes to DSP program parameter values and other settings on this unit.

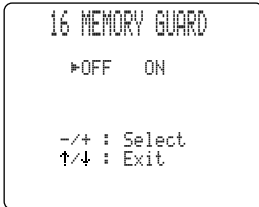

Initial setting: OFF

Select “ON” to protect the following features:

- DSP program parameters
- All SET MENU items except “16 MEMORY GUARD”
- Center, front effect, rear speakers, rear center, and subwoofer levels
- The on-screen display (OSD) mode

Cautions

- When “16 MEMORY GUARD” is set to “ON”, you cannot select any other SET MENU items.
- When “16 MEMORY GUARD” is set to “ON”, you cannot use the test tone.

17 ZONE2 SET

Use this feature to change the volume control setting for audio output to **ZONE 2 OUT** and the setting of the **REMOTE 1 IN** and **REMOTE 2 IN** jacks.

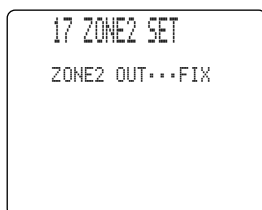

■ ZONE2 OUT

This item changes the volume control setting for audio output to **ZONE 2 OUT**.

Choices: VAR., FIX

Initial setting: FIX

VAR.: To adjust the **ZONE 2 OUT** volume with **VOL +/-** on the remote control.

FIX: To fix the **ZONE 2 OUT** volume to the volume level of this unit.

■ CTRL IN

Use this feature to change the setting of the **REMOTE 1 IN** and **REMOTE 2 IN** jacks.

Choices: MODE1, MODE2

Initial setting: MODE1

MODE1: To control this unit using the tuner preset buttons on the remote control.

MODE2: To control this unit without using the tuner preset buttons on the remote control.

18 6CH INPUT SET

Use this feature to set the direction of the signals input into the center and subwoofer channels when the source component is connected to the **6CH INPUT** jacks.

■ 18A CENTER to (direction of the center channel signals)

This item sets the direction of the signals input into the **CENTER** jack.

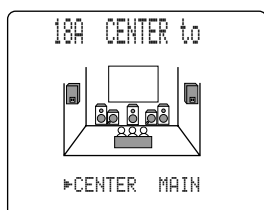

Choices: CENTER, MAIN

Initial setting: CENTER

CENTER: The input signals are output from the center speaker.

MAIN: The input signals are directed to the main L/R speakers with same level.

■ 18B SWFR to (direction of the signals input into the subwoofer)

This item sets the direction of the signals input into the **SUBWOOFER** jack.

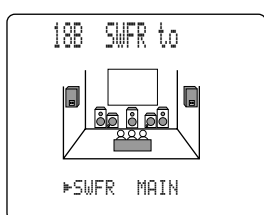

Choices: SWFR, MAIN

Initial setting: SWFR

SWFR: The input signals are output from the subwoofer.

MAIN: The input signals are directed to the main L/R speakers with same level.

REMOTE CONTROL FEATURES



The remote control is set up by default to operate with YAMAHA components. When you have other brands, you can define the brands for your components and install the RC codes to activate those components.

What makes the remote control so powerful is the ability to extend its functionality in multiple ways like programming additional functions, adding supplementary components, recording macros and customizing the interface as it suits you best.

For operations of this unit, see page ___.

Selecting a component

■ Via the Home menu

- 1 Tap  (or ) to select a video (or audio) component.

The remote control displays buttons that enable you to select your components. If you cannot find the component you want to select on the first panel, scroll through the pages using .

or tap  to display the second (or third) Home menu panel.

- 2 Tap the component you want to operate.

The first control panel of the selected component appears.

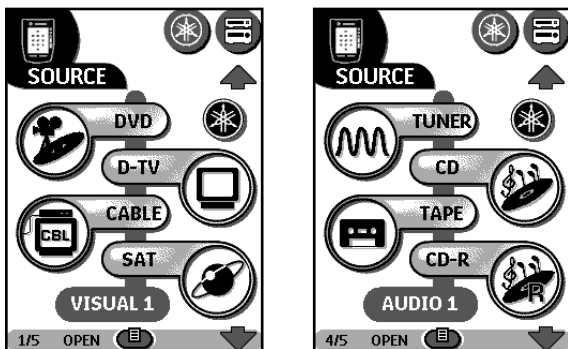

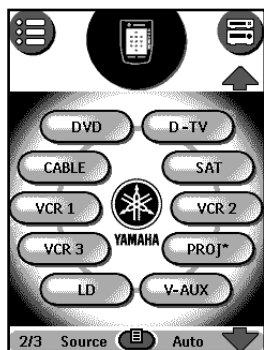

or



■ Via the Device menu

The Device menu allows you to easily switch to another component without having to return to the Home menu.

- 1 From within any component control panel, tap the device tab.

The Device menu pops up. You can scroll through this menu using  and .

- 2 In the Device menu, tap the component you want to operate.

The control panel that was last accessed for the component appears.

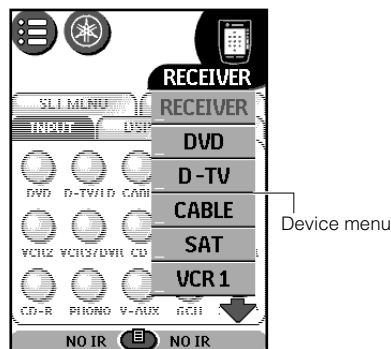
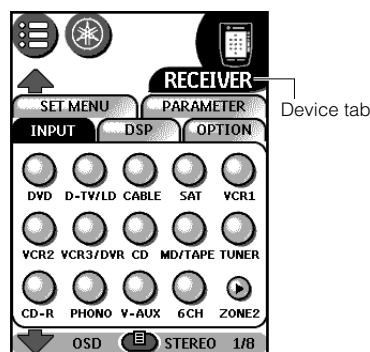

Note

- You can also activate the Device menu from Home by tapping the device tab icon.

Switching to another component without affecting the active component

If you switch to another component (for which you already defined a component action), RC codes are sent out the moment you select the component.

To switch to another component without sending RC codes, follow this procedure.

Example

You defined a device action for the VCR1: when you select the VCR1, the D-TV switches to channel 10. Now you wish to keep watching channel 2 on the D-TV when you switch to the VCR1 to rewind a tape.

1 Open the Device menu.

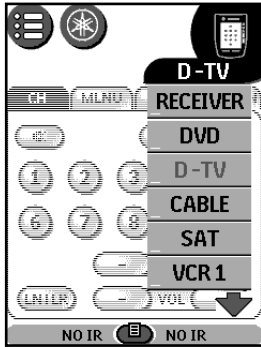

2 Press and hold the left or right button (labeled “NO IR”).

The remote control icon turns around , indicating that the component you are going to select will not send IR codes so as not to affect the active component.

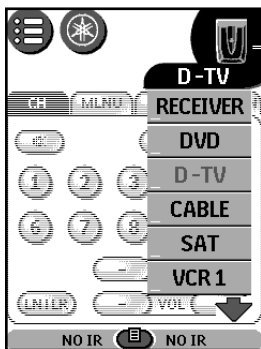
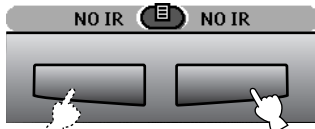

The remote control icon turns around.

3 Tap the component you want to select.

The control panel of the new selected component appears and the remote control icon returns to its original position. You can now operate the new selected component without affecting the previously active component.

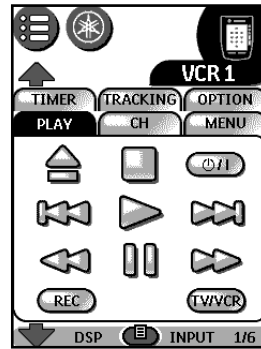
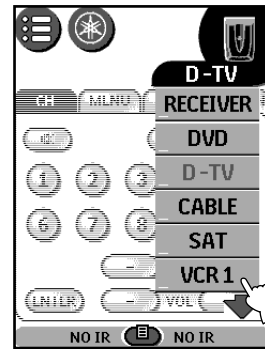

The control panel of the new selected components appears.

Defining the brands of your components

The remote control uses RC codes to activate components. Because there are several brands using specific RC codes, you have to define the brands of your components. The remote control is set up by default to operate with YAMAHA components.

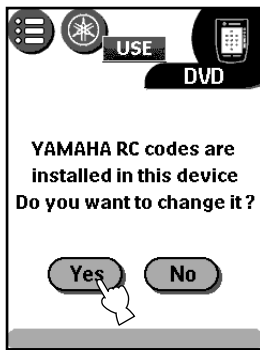
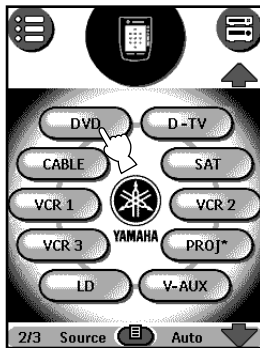
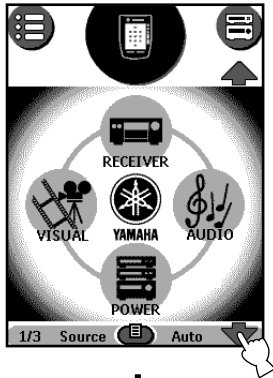

- 1 Tap scroll button  to go to second (or third) Home menu panel.

A/V components are listed in the second and third control panel.

- 2 Tap a component name to select the desired component.

- 3 If the brand of your component is YAMAHA, click .

The remote control switches to the Use mode.

If you want to adjust the remote control to operate with your brand, click .

The remote control switches to the Brand mode. You can define your brands by selecting or by searching.

To define the brands by selecting, follow the instructions on “Defining brands by selecting” on page __.

To define the brands by searching, follow the instructions on “Defining brands by searching” on page __.

Notes

- For RECEIVER and TUNER, the brands are set up for YAMAHA by default and the display on the step 3 does not appear.
- Before you start using the remote control, make sure you define the brand for each component you want to operate.

■ Defining brands by selecting

A list of brands and their corresponding RC codes are stored in the remote control's memory.

Select your brand from the list. Because not every component of a certain brand uses the same RC codes, you might also need to select from a set of RC codes for your brand.

4 Tap **Next.**

A scrollable list of brands for the selected component and a "virtual auto-zooming" mini-keyboard appears.

5 Navigate the list of brands.

Use **↑** or **↓** to scroll up or down the list. By tapping **↑** or **↓**, you scroll through the brands one by one. Holding down **↑** or **↓** increases the scrolling speed.



Use the mini-keyboard to jump through the list of brands. To enter a character, tap near it on the keyboard. The keyboard zooms in, allowing you to tap exactly the character you need.

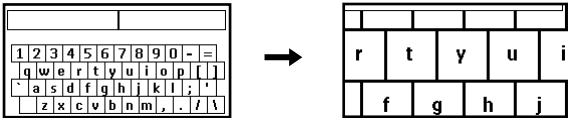

To enter a space, tap the lower left corner of the keyboard. When the keyboard zooms in, tap the empty key.

After you tap the character, the keyboard zooms out. Repeat this action for every character.

Every time you enter a character the list displays the brands that match the character(s). The remote control makes a pre-selection of the (first) brand that matches. You have to type only as many characters as needed to display your brand.

Note

- When your brand is not displayed in the list of brands, you can use the Search mode. See "Defining brands by searching" on page ____.

6 Select your brand in the list.

The selected brand turns black. **Search** becomes to **Next**.

7 Tap **Next.**

When your brand uses only one set of RC codes, the remote control switches to the Try mode. Continue with step 10.

When there are several code sets for your brand, the following screen appears.

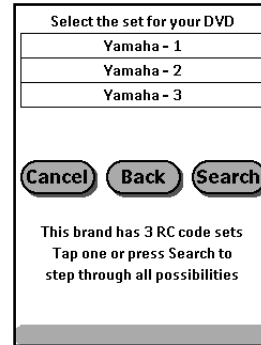

Notes

- The code sets are ranked. The first code set in the list is used for most components of the selected brand.
- When you do not know which code set to select from the list, you can use the Search mode. See "Defining brands by searching" on page ____.

8 Select a code set from the list.

The selected code set turns black. **Search** becomes to **Next**.

Go on to the next page.

REMOTE CONTROL FEATURES

9 Tap **Next**.

The remote control switches to the Try mode.

10 Tap **Next** to open the first control panel of the selected component.



11 Try out the buttons on the different control panels and check whether the component responds to the RC codes the remote control is sending.

Note

- Even when your component is responding to the current code set, it is advised to try out other code sets. When your component responds to more than one code set, install the most suitable one.

12 If you are not satisfied with the way the component responds to the selected code set, tap **Back** to select another code set.

If you are satisfied with the selected code set, tap **Install**.

When the RC codes for your component are installed, the remote control beeps and returns to the Use mode. Your brand is now defined for the selected component.

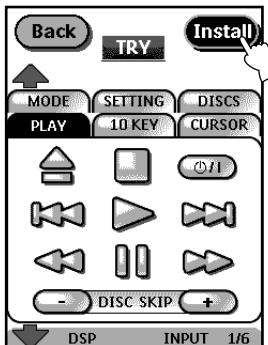

13 Define other components you want to operate.

■ Defining brands by searching

You can use the Search mode to find the matching RC codes for your component when your brand is not displayed in the list of brands, or you selected your brand, but do not know which code set to select.

4 Tap **Next**.

A scrollable list of brands for the selected component and a “virtual auto-zooming” mini-keyboard appears.

5 Tap **Search**.

The remote control automatically searches through all available brands and code sets to find the matching RC codes for your component.

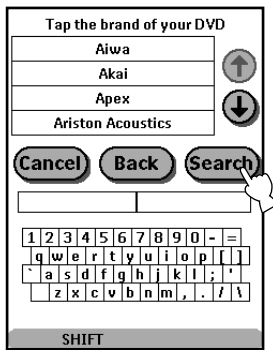

6 Tap **Next** to start sending appropriate commands for the selected component.



7 Tap **OK** when the component reacts.

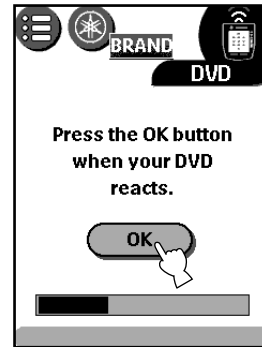

Notes

- Even when the component is responding to the current code set, it is still advisable to try out other code sets. When your component responds to more than one code set, install the most suitable one.
- If you have specified the brand at step 4, the name of the responding code set is displayed when you tap **OK**, so you know which code set to select from the list after you try out other code sets.

8 Tap **Next** to open the first control panel of the selected component.

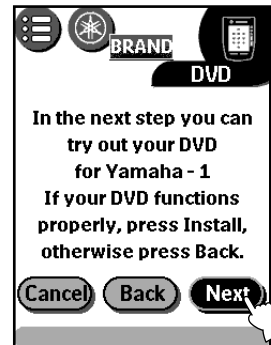

9 Try out the buttons on the control panels and install the RC codes following steps 11 to 13 described in “Defining brands by selecting” on the left page.

Controlling power on/off of your A/V components

Using the POWER control panel, you can simultaneously turn on or off (standby) multiple components without switching the control panel for each component.

Notes

- This function is effective only with components that have a power on/off button on their original remote control.
- Most of the component buttons listed below power groups (e.g., **ALL VISUAL**, **ALL AUDIO**) are not assigned commands by default. If the remote control of your component has a power on/off button, you can assign a command by defining the brand of the corresponding component. See page __ to define the brand of your components.
- You cannot turn this unit on or off using the buttons on the POWER control panel. Use direct-access buttons to turn this unit on or off (standby).

- 1 Tap  on the Home menu panel (or open the Macro menu and tap "POWER").
- 2 Tap a power group button.

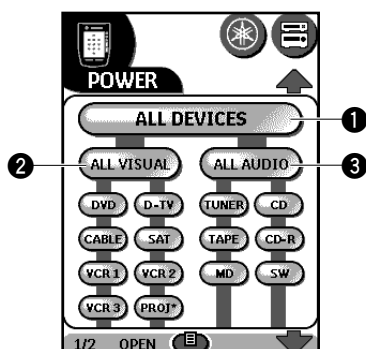

- 1 To turn on /off the power for all components at once, tap **ALL DEVICES**.
- 2 To turn on/off the power for the video components one at a time, tap **ALL VISUAL**.
- 3 To turn on/off the power for the audio components one at a time, tap **ALL AUDIO**.

Whether a component turns on or off depends on the previous state of each component. Tap the buttons of each component to turn on or off the components individually.

Note

- You can add or move components and assign their power on/off commands on the list below **ALL DEVICES**, **ALL VISUAL** or **ALL AUDIO** (power group). See page __ "Recording macros".

Working with modes

When you operate your components, the remote control is in the Use mode. For actions other than operating (like programming buttons, recording macros, adding components, and so on), **ADD** you have to switch to the appropriate mode:

USE	For operating components.
LEARN	For learning commands from other components. *1
EDIT	For recording macros and setting timers.
LABEL	For labeling buttons and commands. *1
ADD	For adding new components.
DEL	For deleting buttons, components and macros. *1
MOVE	For changing the order in a menu.
BRAND	For defining brands using the remote control's database. *2

*1: These actions cannot be made on the RECEIVER and TUNER. To make these actions, copy the RECEIVER and TUNER (see page __) and make actions on the copied one.



*2: You can define brands other than YAMAHA for the RECEIVER and TUNER. However, you cannot operate this unit after defining the other brands. If you want to operate this unit, reset the RC code to "Yamaha-6" for the RECEIVER, and "Yamaha-1" for the TUNER.

■ Switching to another mode

- 1 Tap  at the bottom of the touch screen.
The Mode menu pops up.
- 2 Tap the mode you want to use.
The label of the active mode appears on the top center of the touch screen.
You can now work in the selected mode.

■ Hiding the Mode menu

To prevent accidental changes to the remote control interface and commands, you can hide the Mode menu.

- 1 Make sure the remote control is in the Use mode.
- 2 Touch and hold the remote control icon  for a few seconds.
The first setup panel appears.
- 3 Scroll down to the second setup panel.
- 4 Tap .
The mode menu icon  is crossed out.
- 5 Tap the remote control icon.
The remote control switches to the Use mode.

Note

- Repeat steps 1 to 5 to turn the Mode menu back on.

Redefining brands

If you purchase a new component with a brand that you have not yet defined in the remote control, you need to redefine the brand to activate your new component.

You can redefine brands by selecting or by searching.

■ Redefining brands by selecting

- 1 **Switch to the Brand mode via  at the bottom of the touch screen.**

The Device menu pops up.

- 2 **Select the component for which you want to redefine the brand.**

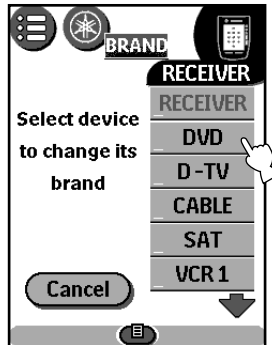

- 3 **Complete steps 4 to 12 in “Defining brands by selecting” on page ___.**

- 4 **Redefine all the other components you want.**

■ Redefining brands by searching

You can use the Search mode to find the matching RC codes for your component when your brand is not displayed in the list of brands, or you selected your brand, but do not know which code set to select.

- 1 **Switch to the Brand mode via  at the bottom of the touch screen.**

The Device menu pops up.

- 2 **Select the component for which you want to redefine the brand.**

- 3 **Complete steps 4 to 9 in “Defining brands by searching” on page ___.**

- 4 **Redefine all the other components you want.**

Learning commands

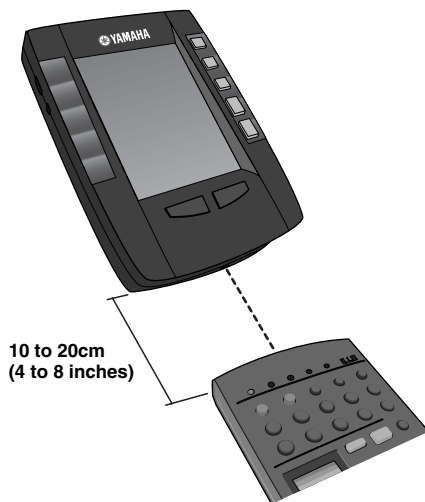

You can program the remote control commands by transmitting IR signals from your existing remote controls to the remote control's learning eye. To do this, place the remote control and the component's remote control on a flat surface, 10 to 20 cm (4 to 8 inches) apart.



The following buttons can be programmed:

- Control panel buttons.
- Device actions.
- Direct-access buttons and left/right buttons.

You cannot program Home menu buttons directly. You must program components via the Device menu.

The remote control also offers empty control panel buttons that you can program and label as existing buttons. They are visible only in the Learn and Label mode and appear with or without labels (intended for a specific function). You will also see previously deleted buttons: you can restore them by reprogramming them or you can reuse them for other commands.

■ Learning control panel buttons



- 1 Navigate to the control panel buttons you want to program.**
- 2 Switch to the Learn mode via  at the bottom of the touch screen.**
Additional empty buttons appear: they can be programmed and labeled as existing buttons.
- 3 Point the component's original remote control at the remote control's learning eye.**
- 4 Tap the control panel button you want to program.**
The button starts flashing.
- 5 Press and hold the corresponding button on your component's original remote control.**
If the remote control has learned the command successfully, "OK" flashes on the upper center of the touch screen. You can release the button you're holding.
If the remote control has not learned the command successfully, you will hear a short buzz and "FAIL" will appear on the remote control icon.
- 6 Program all other buttons you want and relabel them if necessary.**
- 7 Return to the Use mode via .**

■ Learning device actions

A device action is a command that is assigned to a component button on the Home menu or a component in the Device menu. The action is executed every time you select the component.

Note

- When you program a device action, RC codes are sent the moment you select the component. This might affect the operation of the active component. For information on switching to another component without sending RC codes and without affecting the active component, see “Switching to another component without affecting the active component” on page ___.

- 1 Make sure the device tab is active.**
The device tab is active when the name of a component is displayed.
- 2 Switch to the Learn mode via  at the bottom of the touch screen.**
- 3 Point the component’s original remote control at the remote control’s learning eye.**
- 4 Tap the device tab to open the Device menu.**
- 5 Touch and hold the remote control’s left or right button (both labeled “DEVICE”) and tap the component you want to program.**
Even when you want to program a device action for the currently active component, you must tap it in the Device menu. The label “device” starts flashing on the upper center of the touch screen.
- 6 Press and hold the button you wish the remote control to learn as device action on your component’s original remote control. The command for the device action is assigned to the Device button in the Home menu and in the Device menu.**
If the remote control learns the command successfully, “OK” flashes on the display. You can release the button you’re holding. If the remote control has not learned the command successfully, you will hear a short buzz and “FAIL” will appear on the remote control icon.
- 7 Program all the other device actions you want and return to the Use mode via .**

■ Learning direct-access and left/right buttons

Direct-access and left/right buttons can be programmed with a global function or with functions per component. Buttons with global functions always execute the same command, no matter what component is active. Buttons with functions per component execute commands depending on the active component.

Note

- Per component functions override global functions. For example, when you program **VOL +/-** globally, but assign a specific function to them with the DVD, the specific command will be executed when the DVD is the active component.

- 1 To learn a button per component, switch to the components for which you want to program the button.**
To learn a button globally, tap .
- 2 Complete steps 2 to 7 in “Learning control panel buttons” on page __. Instead of tapping a button on the touch screen, press the direct-access button or left/right button you want to program.**
The label of the button you press (e.g. “vol+” or “left”) starts flashing at the center top of the touch screen.

Labeling elements

The following elements can be labeled:

- Control panel buttons
- Components, macro groups and timer groups
- Macros and timers
- The left/right buttons labels

To label control panel buttons, macros, timers and the left/right buttons labels, go to “Labeling a button”. To label components, macro groups and timer groups, go to “Labeling a component”.

You cannot label buttons on the second and third Home menu panel directly. You must label them via the Device menu.

■ Labeling a button

- 1 **Navigate to the panel containing the button you want to label.**
- 2 **Switch to the Label mode via  at the bottom of the touch screen.**
- 3 **Tap the button you want to label.**
The display shows a “virtual auto-zooming” mini-keyboard. The button you want to label is displayed above the keyboard.

Note

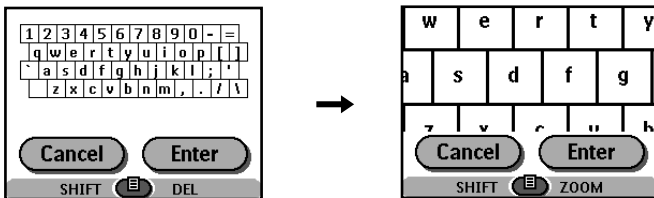

 - There are some buttons you cannot label. If you tap a button you cannot label, you will hear a short buzz.
- 4 **Edit the label.**
 - To delete a character, press the right button (labeled “DEL”).
 - To enter a character, tap the keyboard near the character you want to use.
The keyboard zooms in, allowing you to tap exactly the character you need.
 - To enter a space, tap the lower left corner of the keyboard. When the keyboard zooms in, tap the empty key.
 - For capital letters and symbols, press the left button (labeled “SHIFT”) repeatedly to display the keyboard you want.



After you tap the character, the keyboard zooms out. Repeat this action for each character.

Notes

- You can zoom out again without tapping a character by pressing the right button (labeled “ZOOM”).
- Symbols cannot be entered if the point of characters used in the label are too small.

- 5 Tap  to save the changes and return to the previous panel, or tap  to return to the previous panel without saving changes.
- 6 **Label all the other elements you want and return to the Use mode via .**

■ Labeling a component

- 1 **Switch to the Label mode via  at the bottom of the touch screen.**
- 2 **Tap the device tab to open the Device menu.**
- 3 **Touch and hold either the remote control’s left or right button (labeled “DEVICE”) and tap the component you want to label.**
Even when you want to label the currently active component, you must tap it in the Device menu.
The display shows a “virtual auto-zooming” mini-keyboard. The button you want to label is displayed above the keyboard.
- 4 **Complete steps 4 to 6 described in “Labeling a button”.**

Adding and moving

■ Adding a component

If you have a component that is not listed in the Device menu, you can add it to the remote control.

You cannot add components to the Home menu directly. You must add them via the Device menu.

1 Make sure the device tab is active.

The device tab is active when the name of a component is displayed.

2 Switch to the Add mode via  at the bottom of the touch screen.

The remote control displays the following choices:

- **Create New Device**: Choose this option to add a completely new component.
- **Copy Existing Device**: Choose this option to copy a component already listed in the Device menu (for example for a second DVD).
- **Restore Deleted Device**: Use this option to restore a component you have deleted.

3 Tap the component you want to add in the Device menu.

Note

- If the component you want to add is not listed, choose a similar one. You can customize it later.

The remote control allows you to add new components with or without RC codes.

- **Create with RC codes**: Choose this option if you think the new component understands RC codes. The new component is added with operational buttons.
- **Don't add RC codes**: If you choose this option, the new component is added without operational buttons. You will then have to program them as explained in "Learning control panel buttons".

You cannot define a component in the Brand mode, because there are no RC codes available.

4 Tap the button of your choice.

The new component is automatically displayed in the Use mode.

Note

- A new device tab is automatically created in the Device menu and in the third Home menu panel. However, you cannot add the button of the new component to the audio/visual source panels.

■ Moving a component, macro group or timer group

You can change the order in the Device menu and the Macro menu. Changes you make in the Device menu are automatically updated in the Home menu.

1 Make sure the device tab or macro tab is active.

The device or macro tab is active when the name of a component, macro or timer is displayed.

2 Switch to the Move mode via  at the bottom of the touch screen.

The remote control displays the menu.

3 Tap the component or group you want to move.



The menu item is highlighted.

4 Use the left and right button to move the menu item up or down.

5 Tap  to save the changes.

You return to the Use mode.

Note

- The item at the top of the device tab corresponds to  on the first Home menu panel. If you move the RECEIVER tab down, it is advisable to label  with the name of the item at the top of the Device menu.

Deleting

You can delete the following elements:

- Control panel buttons and actions associated with a direct-access or a left/right button
- Device actions
- Components, macro groups and timer groups

Home menu buttons cannot be deleted directly. You must delete them via the Device menu.



Note

- Buttons that are programmed in the Learn mode and deleted afterwards will disappear from the display. When you redefine the component in the Brand mode, those buttons will stay empty. You will need to program them again in the Learn mode.



■ Deleting a button or button action

Note





- Shadeless buttons like  cannot be deleted. You can only hide them by removing their label. See “Labeling a button” on page —.

- 1 **Switch to the Delete mode via  at the bottom of the touch screen.**
- 2 **Tap the button you want to delete.**
- 3 **Tap .**
The result depends on the element you are deleting:
 - Control panel button: The button disappears from the display.
 - Left or right button command: The corresponding label disappears from the display.
 - Direct-access button: The button becomes inactive.
- 4 **Delete all the buttons and button actions you want and return to the Use mode via .**

■ Deleting a device action

- 1 **Switch to the Delete mode via  at the bottom of the touch screen.**
- 2 **Tap the device tab.**
When you open the Device menu, the left button label changes to “DEVICE” and the right button label changes to “ACTION”.
- 3 **Press and hold down the right button (labeled “ACTION”).**
- 4 **Tap the component associated with the device action you want to delete.**
- 5 **Tap .**
The device action is deleted.
- 6 **Delete all the device actions you want and return to the Use mode via .**

■ Deleting a component, macro group or timer group

- 1 **Switch to the Delete mode via  at the bottom of the touch screen.**
- 2 **Navigate to the component or group you want to delete.**
If you have opened the Device menu, the left button label changes to “DEVICE” and the right button label to “ACTION”. If you have opened the Macro menu, the left and right button labels change to “GROUP”.
- 3 **Press and hold down the left or right button depending on what you are deleting:**
 - Left button labeled “DEVICE”: To delete a component in the Device menu.
 - Left or right button labeled “GROUP”: To delete a macro group or a timer group in the Macro menu.
- 4 **Tap the component or group you want to delete.**
- 5 **Tap ,  or .**
The component (and its associated Home menu button), the macro group (including its macros) or the timer group (including its settings) is deleted.
- 6 **Delete all the components, macro groups and timer groups you want and return to the Use mode via .**

Restoring

When you delete elements, they are no longer visible in the Use mode but remain in the remote control's memory. This allows you to restore them.

- You can restore a deleted button or a device action in the Learn mode.
- You can restore a deleted component, macro group or timer group in the Add mode.

Actions associated with direct-access or left/right buttons cannot be restored. You must reprogram them as explained in “Learning direct-access and left/right buttons” on page __.



■ Restoring buttons and button actions

- 1 Switch to the Learn mode via  at the bottom of the touch screen.**
The empty buttons become visible.
- 2 Complete steps 3 to 7 in “Learning control panel buttons” on page __.**
The button is restored.

■ Restoring device actions

- 1 Switch to the Learn mode via  at the bottom of the touch screen.**
- 2 Complete steps 3 to 7 in “Learning device actions” on page __.**
The device item is restored.

■ Restoring components, macro groups or timer groups

- 1 Make sure the device tab or macro tab is active.**
The device or macro tab is active when the name of a component, macro or timer is displayed.
- 2 Switch to the Add mode via  at the bottom of the touch screen.**
- 3 Tap  or .**
The deleted components, macro groups or timer groups become visible.
- 4 Tap the item you want to restore.**
The item is restored and you return to the Use mode.

Note

- Only the macro group or timer group itself is restored, not the macros or timers it contained. You will need to record the macros and set the timers again in the Edit mode.

Recording macros

A macro allows you to send a sequence of IR commands using a single button.



When you select “MACRO” in the Macro menu, seven macro groups (“DVD”, “GAME”, etc.) appears by default. Each group includes buttons that allow you to record a sequence of commands.

In the Macro menu, there are two other macro groups (“POWER” and “SOURCE”).

• POWER

When you select “POWER” in the Macro menu, you see the touch screen that appears when you tap  in the Home menu panel. Commands for turning several A/V components on or off at the same time are recorded in each power group button. A command for turning a single component on or off is recorded in the corresponding component button.

• SOURCE

When you select “SOURCE” in the Macro menu, you see the touch screen that appears when tapping  or  in the Home menu panel. A command to switch the component control panel (and to switch the input of this unit, not of all components) is recorded in each component button.

You can enhance and customize macros by recording new commands and editing them.

Notes

- To record a macro, there must be at least one macro group in the Macro menu. To create these groups, see “Organizing macros into groups” on page __.
- Brands must be defined before macro can be set.

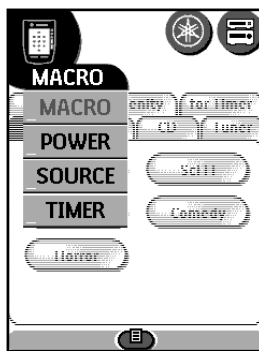

■ Recording macros

- 1 Tap .
- 2 Open the Macro menu and select a macro group.



- 3 Switch to the Edit mode via  at the bottom of the touch screen.
Empty macro buttons appear in the macro control panel.
- 4 Tap the button you want to use for your macro.
- 5 Enter the sequence of commands you want to record.
You can navigate to any control panel you want, just as you do in Use mode.

Note

- Use  or  when switching to another page within the same component. Do not tap the item tab that corresponds to each command group (as you do with the “DSP”, “INPUT” tab, etc., that appear in the RECEIVER control panels).

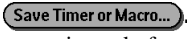
- 6 Tap .
 - 7 Press the left button to close the macro.
A confirmation screen appears that enables you to save or cancel the macro.
 - 8 Tap .
- The macro is ready for use.

■ Adding a component to a power group

Select “POWER” on the Macro menu in step 2 and tap the button that corresponds to the component to which you want to assign the power on/off command in step 4. Then tap the power on/off button in the component control panel in step 5.

Recording extra commands

There are two extra commands you can record in a macro:

• Source switching

To record a device action that includes a source switching command, open the Device menu, hold down the right button (labeled “ACTION”) and tap the component to which you want to switch.

• Ending with a component control panel

To end a macro with the display of a component, open the Device menu, hold down the left button (labeled “DEVICE”) and tap the component you want.

Editing macros

You can edit any macro you have recorded.

- 1 **Open the macro group that contains the macro.**
- 2 **Switch to the Edit mode via  at the bottom of the touch screen.**
- 3 **Tap the macro you want to edit.**
The contents of the macro appear.



- 4 **Edit the macro.**
You can move or delete listed commands or record new commands.

You can also add delays to the macro (for example, to insert a short pause between turning on a component and sending commands to it, allowing the component to warm up).

- 1 Tap **Delay**.
 - 2 Tap **-** or **+** to decrease or increase the length of the delay.
 - 3 Use **↑** and **↓** to move the delay to the right position in the sequence.
- 5 **Press the left button to close the macro.**
A confirmation screen appears that enables you to save or cancel the macro.
 - 6 **Tap **Save Timer or Macro...****
The macro is ready for use.

Organizing macros into groups

You can create as many macro groups as you like. Each group can contain up to 25 macros.



- 1 **Open any macro group.**
- 2 **Switch to the Add mode via  at the bottom of the touch screen.**
You can create a new group, copy an existing group, or restore a previously-deleted group.
 - **Create New Group**: You add a new group in which you can record new macros.
 - **Copy Existing Group**: You copy a group and its macros and use the copy to create new macros.
 - **Restore Deleted Group**: You restore a deleted group and reuse the macros.
- 3 **Tap **Create Macro Group**.**
You see a touch screen on which you can create and edit macro groups. The new group is added to the Macro menu.

Setting timers



With a timer you can activate a component at the time you determine.

■ Setting timers

To activate a component at a desired time, you can use the timer.

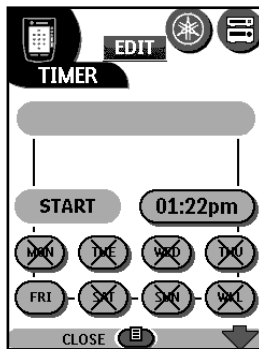
- 1 Tap .
- 2 Open the Macro menu and select a timer group.
- 3 Switch to the Edit mode via  at the bottom of the touch screen.
Empty timer buttons appear in the TIMER control panel.
- 4 Tap the button for which you want to set a timer.
The first TIMER control panel appears, enabling you to set the start time.

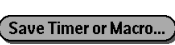

- 5 Enter the command the timer should execute and tap .
A timer can contain either a single IR command or a macro. You can navigate to any control panel you want, just as you do in the Use mode.
- 6 Tap the clock button and set the start time using the left/right buttons.
- 7 Tap one or more day buttons to select or deselect days for the timer.
You can choose to repeat the timer weekly.
- 8 Scroll down to display the second TIMER control panel, in which you can set the stop time.
- 9 Enter the command the timer should execute and tap .
- 10 Set the stop time and select the days following the same procedure described in steps 6 and 7.
- 11 Tap the clock button to deselect it and press the left button (labeled "CLOSE") to close the timer.
A confirmation screen appears, enabling you to save or cancel the timer.
- 12 Tap .
The timer is activated.

Note

- The timer works only when the remote control's sending eye is pointed at the controlled component and no obstructions interfere with the IR signal.

■ Editing timers

You can edit any timer you have set.





- 1 Open the timer group that contains the timer.
- 2 Switch to the Edit mode via  at the bottom of the touch screen.
- 3 Tap the timer you want to edit.
The contents of the timer appear.



- 4 Edit the timer.
- 5 Press the left button to close the timer.
A confirmation screen appears, enabling you save or cancel the timer.
- 6 Tap .
The timer is edited.

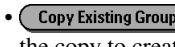

■ Organizing timers into groups

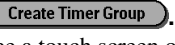
You can create as many timer groups as you like. Each group can contain up to 25 timers.

- 1 Open any timer group.
- 2 Switch to the Add mode via  at the bottom of the touch screen.
You can create a new group, copy an existing group, or restore a previously-deleted group.
 - : You add a new group in which you can record new macros.
 - : You copy a group and its macros and use the copy to create new macros.
 - : You restore a deleted group and reuse the macros.
- 3 Tap .
You see a touch screen on which you can create and edit timer groups. The new group is added to the Macro menu.

Adjusting the settings

Most of the remote control's features can be set to suit your preferences.

- 1 Touch and hold the remote control icon for a few seconds.**
 The first setup panel appears. You can display the second and third setup panel by using  or . The third panel provides technical information about your remote control.
- 2 Tap the button for the setting you want to adjust.**
 The button turns black.
- 3 Use the left and right buttons to adjust the setting.**
- 4 Tap the remote control icon to exit setup mode.**
 The remote control returns to the Use mode.

■ Functions and adjustments

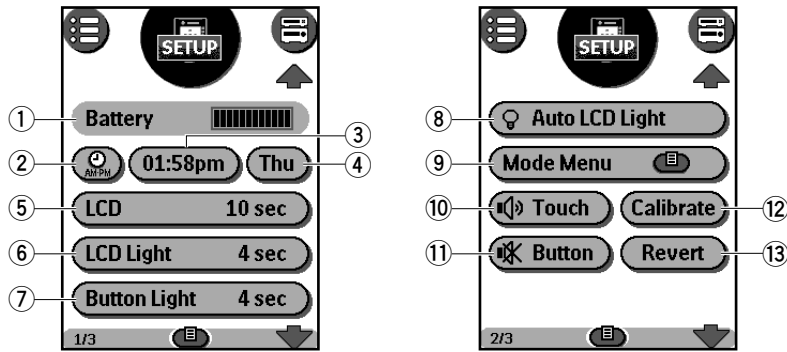

Setting	Function	Adjustments
① Battery	Shows the battery level.	—
② Clock	Turns the clock display on or off and lets you set 12 or 24h time display.	Tap the button repeatedly.
③ Time	Sets the clock.	Tap the button and use the left and right buttons.
④ Day	Sets the day.	Tap the button and use the left and right buttons.
⑤ LCD	Sets how long the touch screen stays on.	Tap the button and use the left and right buttons.
⑥ LCD Light	Sets how long the backlight of the touch screen stays on.	Tap the button and use the left and right buttons.
⑦ Button Light	Sets how long the backlight of the direct-access buttons stays on.	Tap the button and use the left and right buttons.
⑧ Auto LCD Light	Sets whether the backlight turns on or off when tapping the touch screen and pressing the direct-access buttons.	Tap the button.
⑨ Mode Menu	Hides or shows  at the bottom of the touch screen.	Tap the button.
⑩ Touch	Adjusts or turns off the touch screen beep.	Tap the button repeatedly.
⑪ Button	Adjusts or turns off the beep of left / right and direct-access buttons.	Tap the button repeatedly.
⑫ Calibrate	Calibrates the touch screen.	Tap the button and follow the on-screen instructions.
⑬ Revert	Reverts the remote control to the factory default configuration.	Tap the button and follow the on-screen instructions.

RAVedit

If you want to personalize your remote control beyond its standard programming features, RAVedit is the tool for you. RAVedit is the remote control's companion software that you can download from <http://www.yamaha.com/>



With RAVedit you can:

- Upload and download new configurations to and from your remote control, using included serial cable.
- Add, delete, modify and move control panels, components and commands anywhere on the touch screen.
- Save, duplicate and share configuration files, codes or components with other remote controls.
- Preview new configuration files on RAVemulator. In this way you can check the appearance of the remote control's interface.
- Import new graphics to create new buttons and designs.
- Personalize configuration files to optimize the use of your remote control.

Caution

- Never connect the remote control to the RS-232C terminal on the rear panel of the RX-Z1.

When you become familiar with RAVedit, you can achieve results like the following:

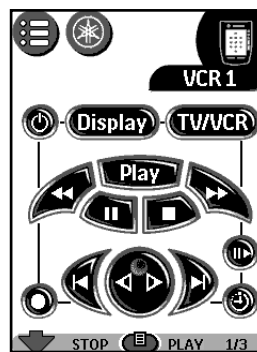
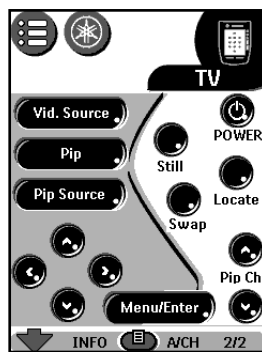

■ System requirements

- PC
- Windows 95/98/2000/ME or NT 4.0
- 16 MB of RAM
- 16 MB of free hard disk space
- Free serial port

ADJUSTING THE LEVELS OF THE EFFECT SPEAKERS

You can adjust the volume level of each effect speaker (center, right rear, rear center, left rear, front effect, and subwoofer) while listening to a music source.

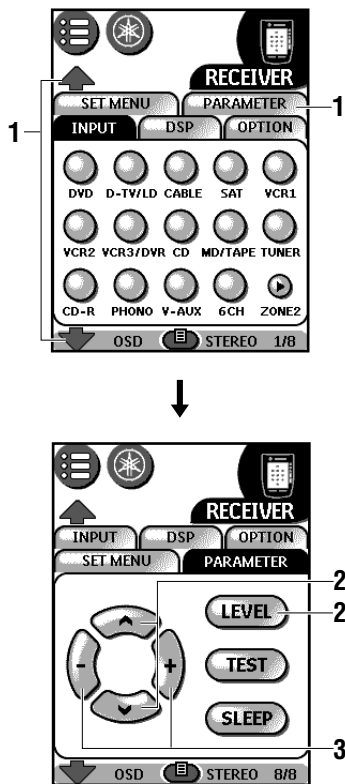

- 1 Go to the RECEIVER control panel and tap **PARAMETER** (▼ or ▲) to open the PARAMETER control panel (page 8/8).
- 2 Tap **LEVEL** to select the speaker(s) you want to adjust. Each time you tap **LEVEL**, the selected speaker changes and appears in the front panel display only as follows:

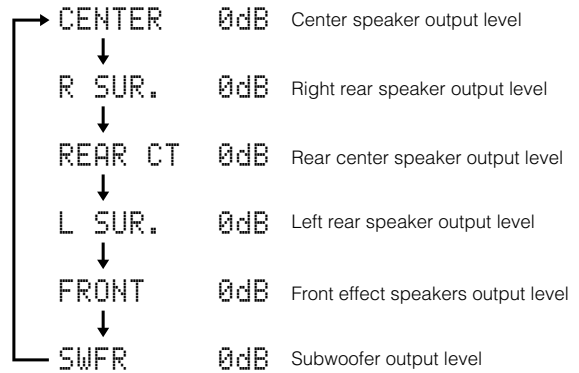

Note

- Once you tap **LEVEL**, you can also select the speaker(s) to be adjusted by tapping ▲ or ▼.

- 3 Tap ▲ or ▼ to adjust the speaker output level.
 - The control range for the center, left and right rear or rear center speakers is from +10 dB to -10 dB.
 - The control range for the subwoofer is from -20 dB to 0 dB.

Cautions

- When you adjust the output level with **LEVEL**, the setting you made with the test tone will be changed.
- You cannot adjust the output level by using **LEVEL** on the SET MENU control panel. However, each time you tap **LEVEL**, the current level of the each speaker appears on the front panel display and you can check the speaker level.
- When the speaker output modes for “1A CENTER SP”, “1C REAR L/R SP”, “1D REAR CT SP” and “1F FRONT EFCT SP” are set to “NONE”, and “1E LFE/BASS OUT” to “MAIN”, the output level of those speakers cannot be adjusted because there is no sound coming from these speakers.

SLEEP TIMER

Use this feature to automatically set this unit in the standby mode after the amount of time you have set. The sleep timer is useful when you are going to sleep while this unit is playing or recording a source. The sleep timer also automatically turns off the external components connected to **AC OUTLETS**.

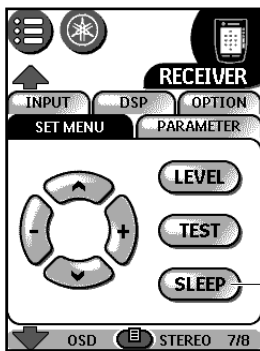
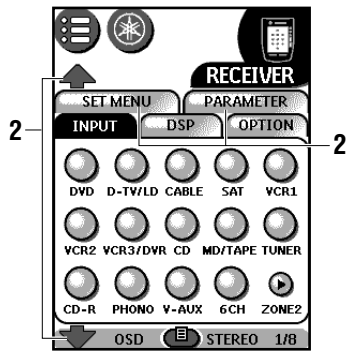

or

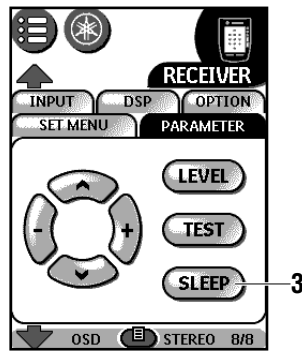

■ Setting the sleep timer

- 1 Select a source and start playback on the source component.
- 2 Go to the RECEIVER control panel and tap **SET MENU** or **PARAMETER** (▼ or ▲ repeatedly) to open the SET MENU or PARAMETER control panel (page 7/8 or 8/8).
- 3 Tap **SLEEP** repeatedly to set the amount of time. Each time you tap **SLEEP**, the front panel display changes as shown below.

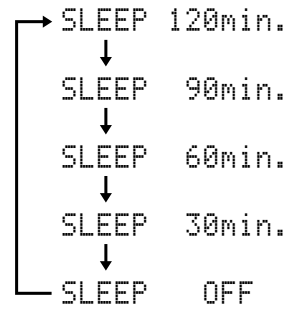

The “SLEEP” indicator soon lights up on the front panel display after the sleep timer has been set. The display then returns to the previous indication.

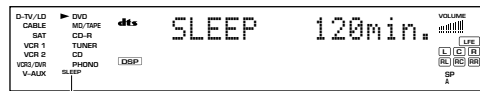

SLEEP indicator

■ Canceling the sleep timer

Tap **SLEEP** repeatedly until “SLEEP OFF” appears on the front panel display. After a few seconds, “SLEEP OFF” disappears, the “SLEEP” indicator goes off and the display returns to the previous indication.

Note

- The sleep timer setting can also be canceled by setting this unit in the standby mode by using **STANDBY** on the remote control (or **STANDBY/ON** on the front panel) or by disconnecting the AC power cord from the AC outlet.

ZONE 2

You can make up a multi-room audio-video system with this unit. With this feature, you can set this unit to reproduce separate input sources in the main room and second (Zone 2) room using the supplied remote control in the second room.

ONLY ANALOG SIGNALS ARE SENT TO THE SECOND ROOM. FOR ANY SOURCE YOU WISH TO LISTEN TO IN THE SECOND ROOM, YOU MUST CONNECT THE ANALOG OUTPUT FROM THE SOURCE TO THE CORRESPONDING ANALOG INPUT ON THIS UNIT.

Connections

To use the multi-room functions of this unit, you need the following additional equipment:

- An infrared signal receiver in the second room
- An infrared emitter in the main room
This emitter transmits the infrared signals from the remote control in the second room to the main room (for example, to a CD player or LD player).
- An amplifier and speakers for the second room
- A video monitor for the second room

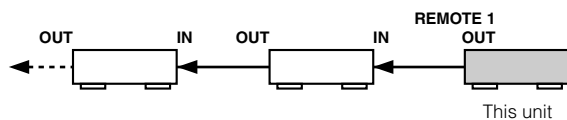

Cautions

- Since there are so many ways to connect and use this unit in a multi-room installation, we recommend that you consult with a custom installation specialist for the Zone 2 connections which will best meet your requirements.
- Some Yamaha models are able to connect directly to the **REMOTE 1 OUT** jacks of this unit. If you own these products, you may not need to use an infrared emitter. Up to six Yamaha components can be connected as shown.

■ A sample of system configuration and connections

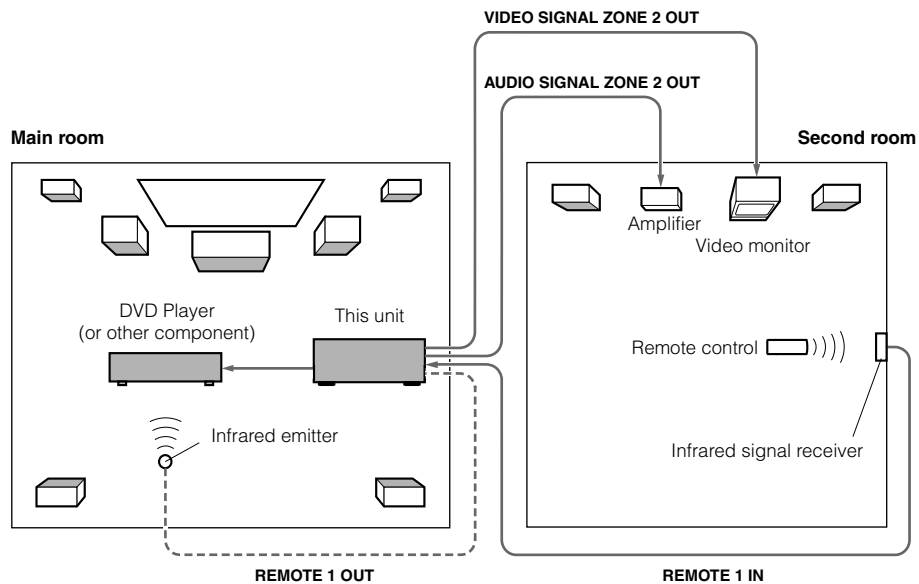

■ Special considerations when using DTS software

The DTS signal is a digital bitstream. Therefore, if you attempt to send the DTS signal to Zone 2, you will only be able to hear the digital noise that could damage your loudspeakers.

Due to this characteristic of DTS encoded discs, the following considerations and adjustments need to be made.

For DTS encoded LDs or DVDs

Only 2-channel audio signals may be sent to Zone 2. Set your Laser Disc/DVD player's left and right outputs to the analog sound track.

For DTS encoded compact discs

DO NOT USE the Zone 2 feature with DTS encoded compact discs.

Remote control in ZONE 2

In the second (Zone 2) room, the supplied remote control can be used as the Zone 2 remote control. You can select the input source and control the component which is located in the main room directly from the second room regardless of the listening condition in the main room.

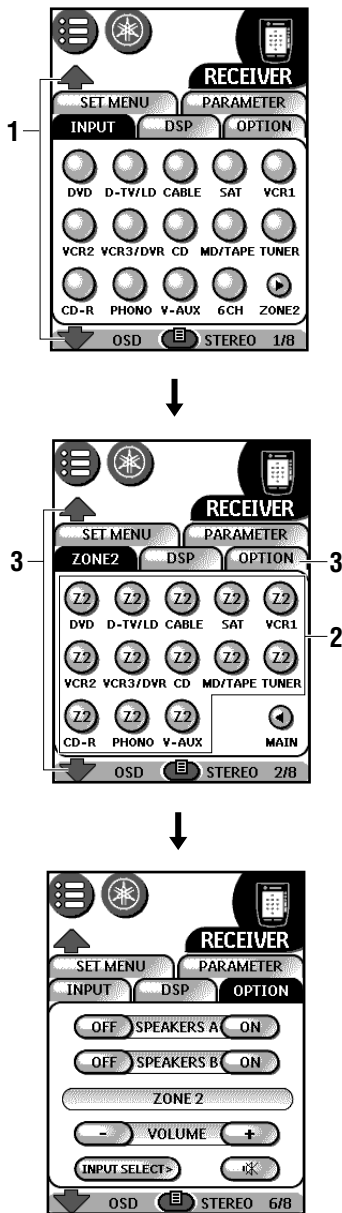

- 1 Go to the RECEIVER control panel and tap or repeatedly to open the ZONE2 control panel.
- 2 Use the input selector buttons (such as) to select the input source you want to listen to.
- 3 Tap (or repeatedly) to open the OPTION control panel.

On the OPTION control panel, you can:

- Adjust the volume of **ZONE 2 OUT** independently by using .
- Mute the sound of **ZONE 2 OUT** by using .
- Select the input source by using .

Note

- can be used to adjust the volume only when you set the SET MENU item “17 ZONE2 SET”, “ZONE2 OUT” to “VAR.” (see page [__](#)).

- 4 Switch to the component control panel via the Device menu.

You can control the component by using the buttons on the component control panels.

Sound field programs

This section explains the sound field programs and its parameters.

DIGITAL SOUND FIELD PROCESSING (DSP)	86
Understanding sound fields	86
Recreating a sound field	87
Illustration of the virtual sound sources and echo patterns	87
HI-FI DSP-SOUND FIELD PROGRAM	88
Programs and features	88
CONCERT HALL 1	89
CONCERT HALL 2	89
CHURCH	89
JAZZ CLUB	89
ROCK CONCERT	89
ENTERTAINMENT	89
CINEMA-DSP SOUND FIELD PROGRAM	90
The sound design of CINEMA-DSP sound field programs	90
Sound field images of the CINEMA-DSP programs	90
Programs and features	91
MOVIE THEATER programs	93
ENTERTAINMENT	94
CONCERT VIDEO 1	94
CONCERT VIDEO 2	94
TV THEATER	94
MOVIE THEATER 1	94
MOVIE THEATER 2	94
DOLBY DIGITAL/DTS SURROUND	94
SOUND FIELD PROGRAM PARAMETER EDITING	95
Changing parameter settings	95
DIGITAL SOUND FIELD PARAMETER DESCRIPTIONS	96

DIGITAL SOUND FIELD PROCESSING (DSP)

Understanding sound fields



A sound field is defined as the “characteristic sound reflections of a particular space”. In concert halls and other music venues, we hear early reflections and reverberations as well as the direct sound produced by the artist(s). The variations in the early reflections and other reverberations among the different music venues is what gives each venue its special and recognizable sound quality.

Yamaha sent teams of sound engineers all around the world to measure the sound reflections of famous concert halls and music venues, and collect detailed sound field information such as the direction, strength, range, and delay time of those reflections. Then we stored this enormous amount of data in the ROM chips of this unit.

■ Early reflections

Reflected sounds reach our ears extremely rapidly (50 ms – 80 ms after the direct sound), after reflecting from one surface only — for example, from the ceiling or a wall. These reflections provide vital information to our ears. Early reflections actually add clarity to the direct sound.

■ Reverberations

These are caused by reflections from more than one surface — walls, ceiling, the back of the room — so numerous that they merge together to form a continuous sonic “afterglow”. They are non-directional, and lessen the clarity of the direct sound.

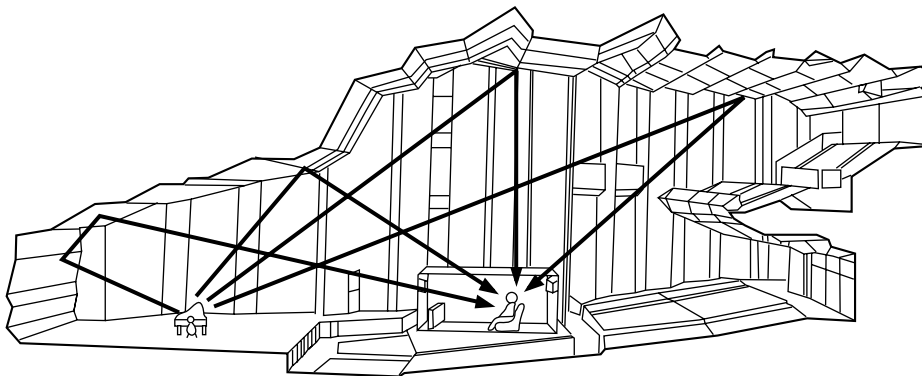

Reflected sounds image

Recreating a sound field

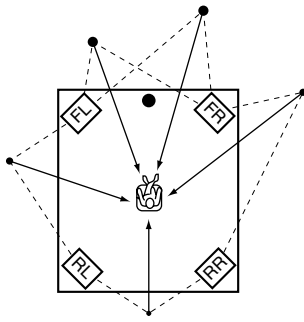

Recreating the sound field of a concert hall or an opera house requires localizing the virtual sound sources in your listening room. The traditional stereo system that uses only two speakers is not capable of recreating a realistic sound field. Yamaha's DSP requires four effect speakers to recreate sound fields based on the measured sound field data. The processor controls the strength and delay time of the signals output from the four effect speakers to localize the virtual sound sources in a full circle around the listener.

The DSP sound field programs can be classified in two types based on the sound field processing method: programs that use early reflections only and programs that use both early reflections and reverberation.

Illustration of the virtual sound sources and echo patterns

The virtual sound sources and echo patterns for the DSP sound field programs are shown below. The illustration of the virtual sound sources shows early reflection sound only and the illustration of the echo patterns shows both reflected sound and reverberation.

Virtual sound sources

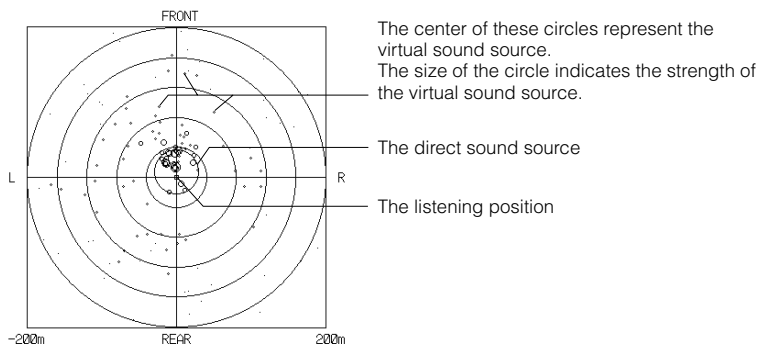

Echo patterns

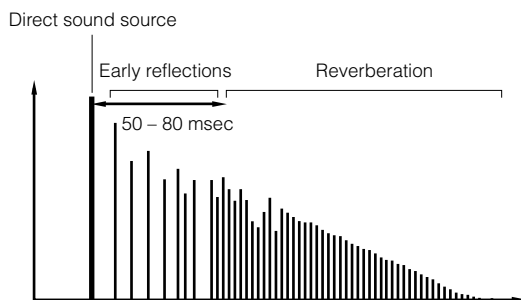

HI-FI DSP-SOUND FIELD PROGRAM

Programs and features

- These programs are the most suitable for the stereo music sources such as CDs.
- Sound field is created using four effect speakers (front L, front R, rear L and rear R) in addition to the main speakers.
- When “8ch Stereo” is selected, input signals are output from the all speakers that have been set on the SET MENU.
- Appropriate decoders automatically turn on depending on the input signals.

No.	Program	Features	
1	CONCERT HALL 1	Europe Hall A	A large fan-shaped concert hall
		Europe Hall B	A large shoe-box type concert hall that has a solid, powerful sound
		Europe Hall C	A classic shoe-box type concert hall that creates complex reflections for a full, rich sound
2	CONCERT HALL 2	U.S.A. Hall D	A large concert hall where the middle and high frequencies are richly and beautifully reinforced
		Europe Hall E	A large classic shoe-box type concert hall that produces rich sounds
		Live Concert	Near the center of a large round concert hall, where rich surround effect is produced
3	CHURCH	Tokyo	An ordinary church with moderate reverberations
		Freiburg	A church with a high ceiling that has the long reverberation delay
		Royaumont	The refectory (dining hall) of a beautiful medieval Gothic monastery
4	JAZZ CLUB	Village Gate	A famous New York jazz club that has with a spacious floor
		Village Vanguard	A traditional jazz club in New York
		The Bottom Line	A famous New York jazz club “The Bottom Line”
5	ROCK CONCERT	Roxy Theatre	LA’s “hottest” rock club
		Warehouse Loft	A concrete-built warehouse
		Arena	A classic shoe-box type concert hall that creates the spacious feel of a large arena
6	ENTERTAINMENT	Disco	High-energy, “hot” disco
		Party	For background music at home parties
		8ch Stereo	

Caution

- The sound field programs for this unit are designed based upon the detailed information that Yamaha sound engineers have collected by measuring the sound effect characteristics at the actual concert halls and music venues all over the world. Therefore you may find some difference in reverberation and volume of the sounds that are output from each of your speakers.

CONCERT HALL 1

■ Europe Hall A

This is a large fan-shaped concert hall in Munich which has approximately 2500 seats. Almost the whole interior is made of wood. There is relatively little reflection from the walls, and sound spreads finely and beautifully.

■ Europe Hall B

This is a large shoe-box type concert hall with less than 2400 seats located in Frankfurt. This hall has a very solid, powerful sound. The listener's virtual seat is in the center-right section on the first floor.

■ Europe Hall C

A classic shoe-box type concert hall with approximately 1700 seats. Pillars and ornate carvings create extremely complex reflections which produce a very full, rich sound.

CONCERT HALL 2

■ U.S.A. Hall D

This is a large 2600 seat concert hall in the United States which features a fairly traditional European design. The interior is relatively simple, in the American style. The middle and high frequencies are richly and beautifully reinforced.

■ Europe Hall E

This is a large 2200 seat shoe-box type concert hall in Amsterdam. It has a circular stage with seats located behind the stage.

■ Live Concert

A large round concert hall with a rich surround effect. Pronounced reflections from all directions emphasize the extension of sounds. The sound field has a great deal of presence, and your virtual seat is near the center, close to the stage.

CHURCH

■ Tokyo

The acoustic environment of an ordinary church with moderate reverberations. The reverberation lasts 2.5 seconds. This is ideal for reproducing church organ and choral music.

■ Freiburg

This program recreates the acoustic environment of a big church located in south Germany. The reverberation delay is very long while the early reflections are smaller than with other sound field programs.

■ Royaumont

This program features the sound field created by the refectory (dining hall) of a beautiful medieval Gothic monastery located in Royaumont on the outskirts of Paris.

JAZZ CLUB

■ Village Gate

This is the sound field at a jazz club in New York. It is in a basement and has a relatively spacious floor area. The listener's virtual seat is at the center left of the hall.

■ Village Vanguard

A traditional jazz club in New York, located on 7th Avenue. This room has a low ceiling, and the "stage" is located in a corner. This program creates an intimate "close-to-the music" feel.

■ The Bottom Line

This is the sound field at stage front in "The Bottom Line", a famous New York jazz club. The floor can seat 300 people to the left and right in a sound field offering a real and vibrant sound.

ROCK CONCERT

■ Roxy Theatre

The ideal program for lively, dynamic rock music. The data for this program was recorded at LA's "hottest" rock club. The listener's virtual seat is at the center-left of the hall.

■ Warehouse Loft

This program simulates a space enclosed by concrete. An energetic sound field is created with relatively clear reflections from the walls.

■ Arena

A classic shoe-box type concert hall. This program gives you long delays between direct sounds and effect sounds, with the extraordinarily spacious feel of a large arena.

ENTERTAINMENT

■ Disco

This program recreates the acoustic environment of a lively disco in the heart of a big city. The sound is dense and highly concentrated. It is also characterized by a high-energy, "immediate" sound.

■ Party

This is a sound field suitable for background music at parties where you can hear the sound directly from the rear as well, thus realizing music enjoyment over a wide area.

■ 8ch Stereo

This is a sound field suitable for background music at parties where you can hear the sound directly from the rear as well. The number of speakers to output depends on "1 SPEAKER SET" in SET MENU.

CINEMA-DSP SOUND FIELD PROGRAM

The sound design of CINEMA-DSP sound field programs

Filmmakers intend the dialog to be located right on the screen, the effect sound a little farther back, the music spread even farther back, and the surround sound around the listener. Of course, all of these sounds must be synchronized with the images on the screen.

CINEMA-DSP is an upgraded version of YAMAHA DSP specially designed for movie soundtracks. CINEMA-DSP integrates the DTS, Dolby Digital, and DOLBY PRO LOGIC surround sound technologies with YAMAHA DSP sound field programs to provide the surround sound field. It recreates the most complete movie sound design in your audio room. In CINEMA-DSP sound field programs, Yamaha's exclusive DSP processing is added to the front left, center, and right channels, so the listener can enjoy realistic dialogue, depth of sound, smooth transition between sound sources, and a surround sound field that goes beyond the screen.

When a DTS or Dolby Digital signal is detected, the CINEMA-DSP sound field processor automatically chooses the most suitable sound field program for that signal.

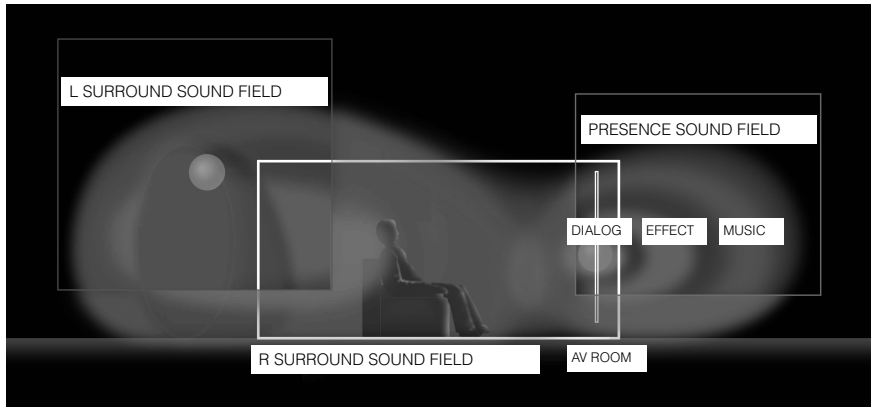

Sound field images of the CINEMA-DSP programs

Each CINEMA-DSP program has its own type of sound field processing block. The sound field data, including the presence and surround sound fields, are based on actual measured data. The presence and surround sound fields can be expressed in the distribution of virtual sound sources and echo patterns. However, as these two types of sound fields are processed with complex elements such as energy balance and mixing signal ratios, they are expressed as a sound field based on auditory perception.

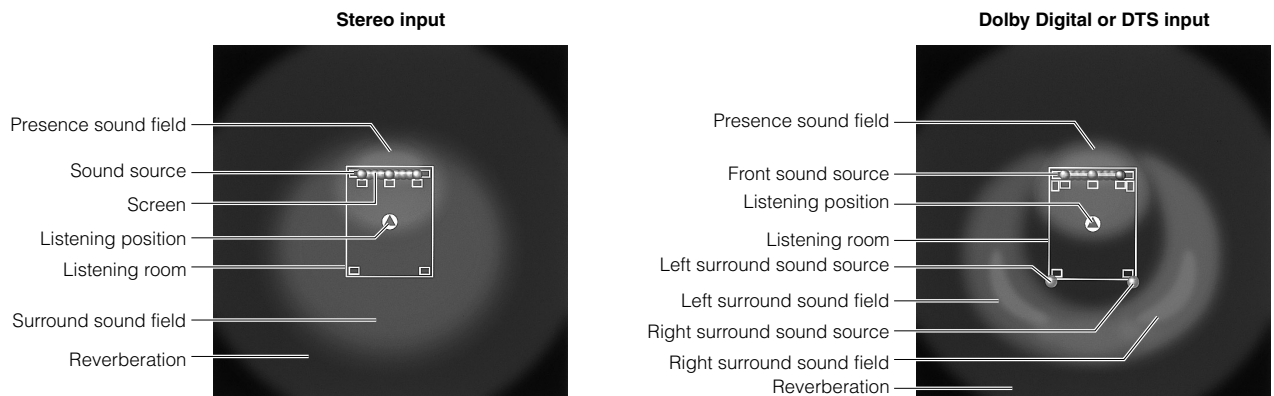

Programs and features

If a Dolby Digital signal or DTS signal is input when the input mode is set to "AUTO", the DSP program will be automatically switched to the Dolby Digital playback sound field or DTS playback sound field.

No.	Program		Features
6	ENTERTAINMENT	Game	A deep and spatial feeling to reinforce lively video game sounds
7	CONCERT VIDEO 1	Pop/Rock	An enthusiastic atmosphere of an actual rock or jazz concert
		DJ	Clearer voice of a disc jockey sound
8	CONCERT VIDEO 2	Classical/Opera	Great presence and beautiful sounds
		Pavilion	A feel of the spaciousness of a pavilion
9	TV THEATER	Mono Movie	Natural reproduction of old monaural movies with moderate DSP processing
		Variety/Sports	For various TV programs such as variety shows or sports programs
10	MOVIE THEATER 1	Spectacle	Ideal for any kind of Dolby Surround video sources, especially large-scale movie productions
		Sci-Fi	For the newest science fiction films
11	MOVIE THEATER 2	Adventure	Ideal for the newest 70 mm and multichannel soundtrack films
		General	Reproduction of sounds from 70 mm and multichannel soundtrack films with soft and extensive sound field
12	DOLBY DIGITAL/ DTS SURROUND	Normal/EX/DTS-ES/ ES Matrix 6.1/ES Discrete 6.1	To reproduce the Dolby Digital or DTS sources with excellent channel separation and stable decoding
		Enhanced/EX/ES	To add DSP effects to the Dolby Digital and DTS surround signals
	DOLBY PRO LOGIC	Normal	To reproduce 2 channel sources as creating virtual multichannels
		Enhanced	
	DOLBY PRO LOGIC II	Movie	
		Music	
	DTS Neo: 6	Cinema	
		Music	

Cautions

- The "[DSP]" indicator does not light up when selecting the program No. 12 except for the "Enhanced" mode.
- No sound will be output from the main speakers when a monaural source is played with sound field Program Groups 6 (Game) and 7 – 12.
- No surround signals will be output when a monaural source is played with the CINEMA DSP program No.12.

Table of program names for each input format

According to the input signal format, this unit automatically chooses the appropriate decoder and DSP sound field pattern.

No.	Input Program	2 channel	5.1 channel		6.1 channel *1	
		Stereo	DOLBY DIGITAL	DTS	DOLBY DIGITAL EX *2	DTS ES *3
10	MOVIE THEATER 1	70 mm Spectacle	DGTL Spectacle	DTS Spectacle	Spectacle EX	Spectacle ES
		70 mm Sci-Fi	DGTL Sci-Fi	DTS Sci-Fi	Sci-Fi EX	Sci-Fi ES
11	MOVIE THEATER 2	70 mm Adventure	DGTL Adventure	DTS Adventure	Adventure EX	Adventure ES
		70 mm General	DGTL General	DTS General	General EX	General ES
12	DOLBY DIGITAL	—	Normal	—	Matrix EX	—
		—	Enhanced	—	Enhanced EX	—
	DTS DIGITAL SUR	—	—	Normal	—	ES Matrix 6.1 *4 ES Discrete 6.1 *5 DTS-ES *6
		—	—	Enhanced	—	Enhanced ES
	PRO LOGIC	Normal	—	—	—	—
		Enhanced	—	—	—	—
	PRO LOGIC II	Movie	—	—	—	—
		Music	—	—	—	—
	DTS Neo: 6	Cinema	—	—	—	—
		Music	—	—	—	—

*1 means the EX/ES decoder is ON.

*2 means the DOLBY DIGITAL EX software is input.

*3 means the DTS ES software is input.

*4 means the DTS ES software encoded with Matrix 6.1 is input.

*5 means the DTS ES software encoded with Discrete 6.1 is input.

*6 means the DTS 96/24 software is input.

MOVIE THEATER programs

Most movie software has four-channel (left, center, right and surround) sound information encoded using Dolby Surround matrix processing and stored on the left and right tracks. These signals are processed by the DOLBY PRO LOGIC decoder. The MOVIE THEATER programs are designed to recreate the spaciousness and delicate nuances of sound that tend to be lost in the encoding and decoding processes.

The six-channel soundtracks found on 70 mm film produce precise sound field localization and rich, deep sound without using matrix processing. This unit's MOVIE THEATER 70 mm Programs provide the same quality of sound and sound localization that six-channel soundtracks do. The built-in Dolby Digital decoder brings the professional quality sound designed for movie theaters into your home. With this unit's MOVIE THEATER program, you can recreate a dynamic sound that gives you the feeling of being at a public theater in your living room using the Dolby Digital technology.

■ DOLBY PRO LOGIC + DSP sound field effect

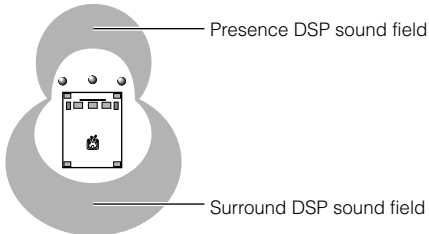

These programs express an immense sound field and a large surround effect. They also give depth to the sound from the main speakers to recreate the realistic sound of a Dolby Stereo theater.

- 70mm Spectacle
- 70mm Sci-Fi
- 70mm Adventure
- 70mm General

■ Dolby Digital/DTS + DSP sound field effect

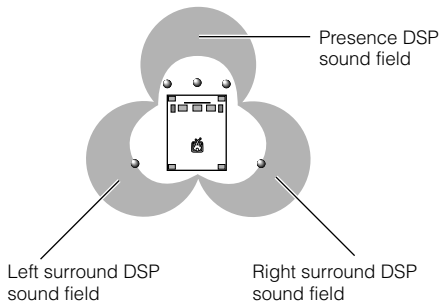

These programs use Yamaha's tri-field DSP process on each of the Dolby Digital or DTS signals for the front, left surround, and right surround channels. This processing enables this unit to reproduce the immense sound field and surround expression of a Dolby Digital or DTS equipped movie theater without sacrificing the clear separation of all channels.

- DGTL/DTS Spectacle
- DGTL/DTS Sci-Fi
- DGTL/DTS Adventure
- DGTL/DTS General

Note

- If a Dolby Digital signal or DTS signal is input when the input mode is set to "AUTO", the DSP program will be automatically switched to the Dolby Digital playback sound field or DTS playback sound field.

■ Dolby Digital EX/DTS ES + DSP sound field effect

These programs provide you the maximum experience of the spacious surround effects since an extra rear center DSP sound field created from the rear center channel is added.

ENTERTAINMENT

■ Game

This program adds a deep and spatial feeling to video game sounds and is also suitable for karaoke.

CONCERT VIDEO 1

■ Pop/Rock

This program produces an enthusiastic atmosphere and lets you feel as if you are at an actual jazz or rock concert.

■ DJ

The sound field makes the voice of a disc jockey sound clearer.

CONCERT VIDEO 2

■ Classical/Opera

This program provides excellent vocal depth and overall clarity by restraining excessive reverberation.

The surround sound field is relatively moderate but it reproduces beautiful sound using data collected from a concert hall.

■ Pavilion

This program reproduces vocals clearly, letting you feel the spaciousness of a pavilion. Reverberation, which is somewhat delayed, reproduces the live acoustics unique to a pavilion, and helps to make concert scenes more exciting.

TV THEATER

■ Mono Movie

This program is provided for reproducing monaural video sources (such as old movies). The program produces the optimum reverberation to create sound depth using only the presence sound field.

■ Variety/Sports

Though the presence sound field is relatively narrow, the surround sound field employs the sound environment of a large concert hall. With this program, you can enjoy watching various TV programs such as news, variety shows, music programs or sports programs.

MOVIE THEATER 1

■ Spectacle

This program creates the extremely wide sound field of a 70 mm movie theater. It precisely reproduces the source sound in detail, making both the video and the sound fields incredibly real. This program is ideal for any kind of Dolby Surround video source (especially large-scale movie productions).

■ Sci-Fi

This program clearly reproduces the broad and expansive cinematic space from the soundtracks of the latest science fiction films.

MOVIE THEATER 2

■ Adventure

This program is ideal for precisely reproducing the sound design of the newest 70 mm and multichannel soundtrack films. The sound field is made to be similar to that of the newest movie theaters, so the reverberations of the sound field itself are restrained as much as possible.

■ General

This program is for reproducing sounds from 70 mm and multichannel soundtrack films, and is characterized by a soft and extensive sound field. The presence sound field is relatively narrow. It spatially spreads all around and toward the screen, restraining the effect of conversations without losing clarity.

DOLBY DIGITAL/DTS SURROUND

■ Normal/EX/DTS-ES/ES Matrix 6.1/ES Discrete 6.1

The built-in decoder precisely reproduces sounds and sound effects from sources. The highly efficient decoding process improves crosstalk and channel separation and makes sound positioning smoother and more precise.

In this program, no DSP effect is applied.

■ Enhanced/EX/ES

This program ideally simulates the multiple surround speaker systems of 35 mm film theaters. The Dolby Surround decoding and the digital sound field processing create precise effects without altering the original sound orientation. The surround effects produced by this sound field wrap around the viewer naturally from the back to the left and right and toward the screen.

SOUND FIELD PROGRAM PARAMETER EDITING

You can enjoy good quality sound with the preset parameters. Although you do not have to change the initial settings, you can change some of the parameters to better suit the input source or your listening room.

Changing parameter settings

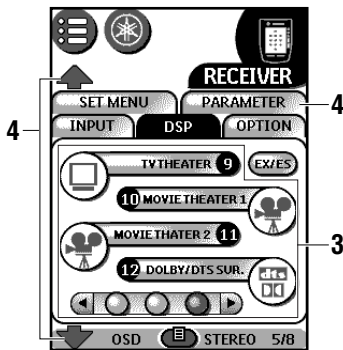
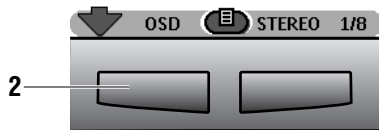

* This display shows the third DSP control panel.

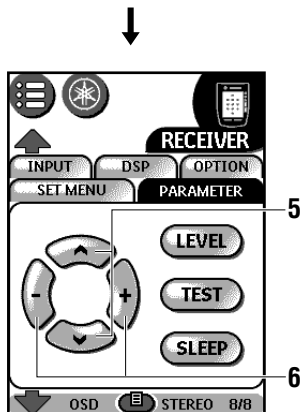

Adjustment should be made with the remote control.

- 1 Turn on the video monitor.
- 2 Go to the RECEIVER control panel and press left button (labeled “OSD”) repeatedly to select the full display mode.
- 3 Go to one of the DSP control panels and select a DSP program you want to adjust.

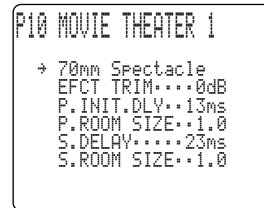

- 4 Tap **PARAMETER** (↓ or ↑ repeatedly) to open the **PARAMETER** control panel.
- 5 Tap or to select the parameter.
- 6 Tap or to change the parameter value.
When you set the parameter to a value other than the factory-set value, an asterisk mark (*) appears by the parameter name on the video monitor.
- 7 Repeat steps 3 to 6 above as necessary to change other parameters.

Cautions

- The available parameters may be displayed on more than one OSD page for some of the programs. To scroll through pages, tap or .
- You cannot change parameter values when “16 MEMORY GUARD” on the SET MENU is set to “ON”. If you want to change the parameter values, set “16 MEMORY GUARD” to “OFF” (see page __).

■ To reset some of the parameters to the factory-set values

Select the parameter you want to reset. Then tap and hold or until the value temporarily stops at the factory-set value. The asterisk mark (*) by the parameter name disappears on the video monitor.

■ To reset all of the parameters to the factory-set values

Use “10 PARAMETER INT” on the SET MENU to reset all of the parameter values of all DSP programs within the selected group to the factory-set values (see page __). This operation resets all of the parameter values of all DSP programs within that group to the factory-set values.

DIGITAL SOUND FIELD PARAMETER DESCRIPTIONS

You can adjust the values of certain digital sound field parameters so the sound fields are recreated accurately in your listening room. Not all of the following parameters are found in every program.

■ EFCT TRIM (Effect Trim)

Function This parameter adjusts the level of all the effect sounds within a narrow range.

Control range -3 dB - +3 dB

Description Depending on the acoustics of your listening room, you may want to increase or decrease the effect level relative to the direct sound.

■ INIT. DLY (Initial Delay)

Function This parameter changes the apparent distance from the source sound by adjusting the delay between the direct sound and the first reflection heard by the listener.

Control range 1 - 99 ms

Description The smaller the value, the closer the sound source seems to the listener. The larger the value, the farther the apparent distance seems. For a small room, this parameter would be set to a small value, for a large room, set it to a large value.

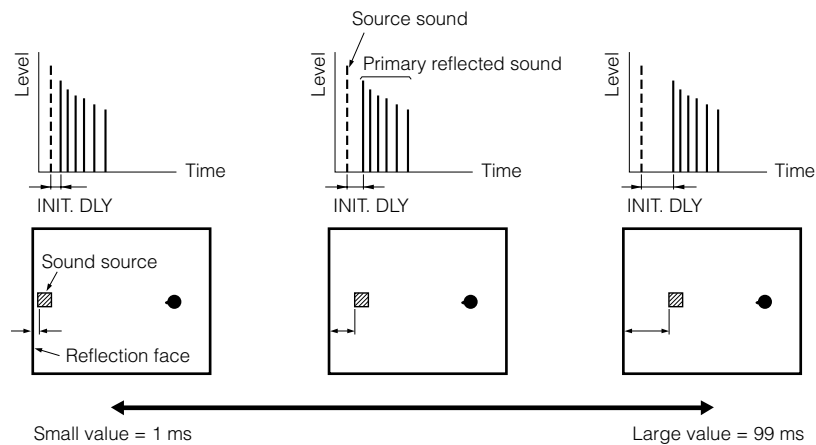

■ ROOM SIZE/P. ROOM SIZE for the presence sound field

Function This parameter adjusts the apparent size of the surround sound field. The larger the value, the larger the surround sound field becomes.

Control range 0.1 - 2.0

Description As the sound is repeatedly reflected around a room, the larger the hall is, the longer the time between the original reflected sound and the subsequent reflections. By controlling the time between the reflected sounds, you can change the apparent size of the virtual venue. Changing this parameter from one to two, doubles the apparent length of the room.

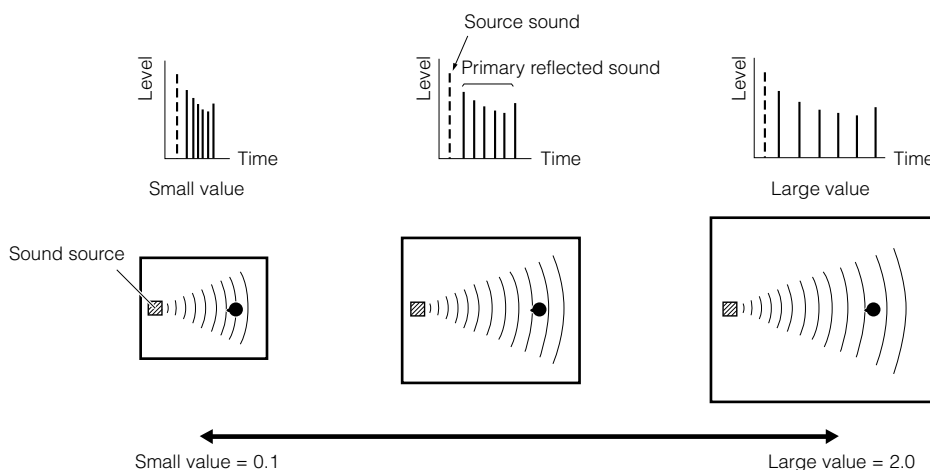

■ LIVENESS

Function This parameter adjusts the reflectivity of the virtual walls in the hall by changing the rate at which the early reflections decay.

Control range 0 – 10

Description The early reflections of a sound source decay much faster in a room with acoustically absorbent wall surfaces than in one which has highly reflective surfaces. A room with acoustically absorbent surfaces is referred to as “dead,” while a room with highly reflective surfaces is referred to as “live”. The LIVENESS parameter lets you adjust the early reflection decay rate, and thus the “liveness” of the room.

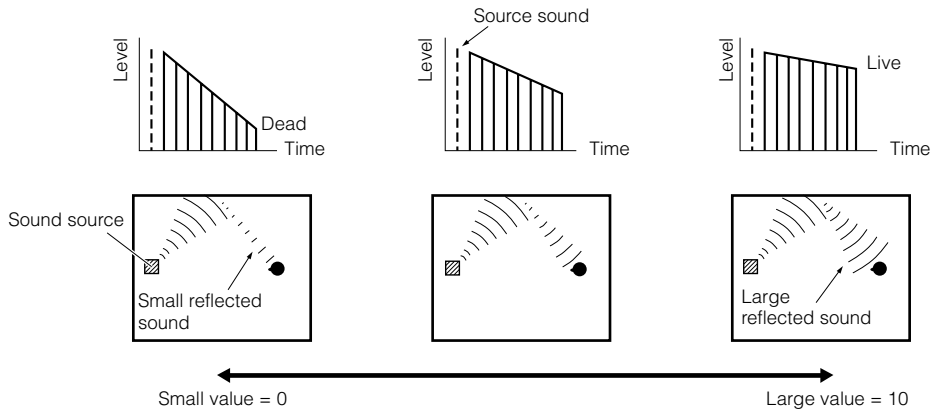

■ P. INIT. DLY (Presence Initial Delay)

Function This parameter adjusts the delay between the direct sound and the first reflection in the presence sound field.

Control range 1 – 99 ms

Description The larger the value, the later the first reflection begins.

■ S. INIT. DLY (Surround Initial Delay)

Function This parameter adjusts the delay between the direct sound and the first reflection on the surround side of the sound field. You can only adjust this parameter when at least two front channels and two rear channels are used.

Control range 1 – 49 ms

Description The larger the value, the later the first reflection begins. You can only adjust this parameter for the Dolby Digital and DTS signals.

DIGITAL SOUND FIELD PARAMETER DESCRIPTIONS

■ S. DELAY (Surround Delay)

- Function** This parameter adjusts the delay between the direct sound and the first reflection in the surround sound field.
- Control range** 0 – 49 ms (The range depends on the signal format.)
- Description** When Dolby Digital signals are decoded: the larger the parameter, the later the surround sound source begins.
When a non-Dolby Digital program is decoded: the larger the parameter, the later the surround sound field begins.
No surround sound source is produced.

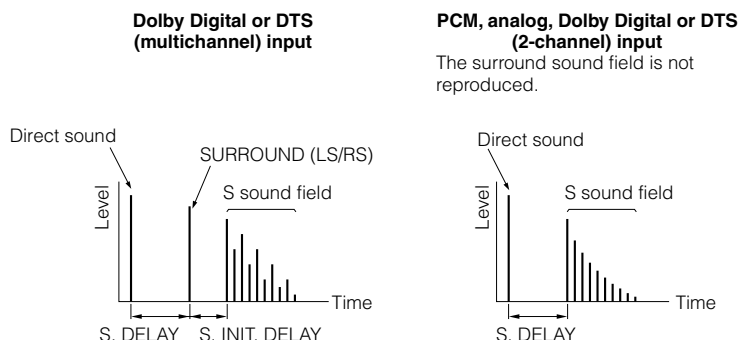

■ S. ROOM SIZE (Surround Room Size)

- Function** This parameter adjusts the apparent size of the surround sound field.
- Control range** 0.1 – 2.0
- Description** The larger the value, the larger the surround sound field becomes.

■ S. LIVENESS (Surround Liveness)

- Function** This parameter adjusts the apparent reflectivity of the virtual walls in the surround sound field.
- Control range** 0 – 10
- Description** The larger the value, the more reflective the surround sound field walls become.

■ RC INI. DLY (Rear Center Initial Delay)

- Function** This parameter adjusts the delay between the direct sound and the first reflection in the rear center sound field.
- Control range** 1 – 49 ms
- Description** The larger the value, the later the first reflection begins.

■ RC ROOM SIZE (Rear Center Room Size)

- Function** This parameter adjusts the apparent size of the rear center sound field.
- Control range** 0.1 – 2.0
- Description** The larger the value, the more reflective the presence sound field walls become.

■ RC LIVENESS (Rear Center Liveness)

- Function** This parameter adjusts the apparent reflectivity of the virtual wall in the rear center sound field.
- Control range** 0 – 10
- Description** The larger the value, the more reflective the surround sound field walls become.

REV. TIME (Reverberation Time)

Function This parameter adjusts the amount of time it takes for the dense, subsequent reverberation sound to decay by 60 dB (at 1 kHz). This changes the apparent size of the acoustic environment over an extremely wide range.

Control range 1.0 – 5.0 s

Description Set a longer reverberation time for “dead” sources and listening room environments and a shorter time for “live” sources and listening room environments.

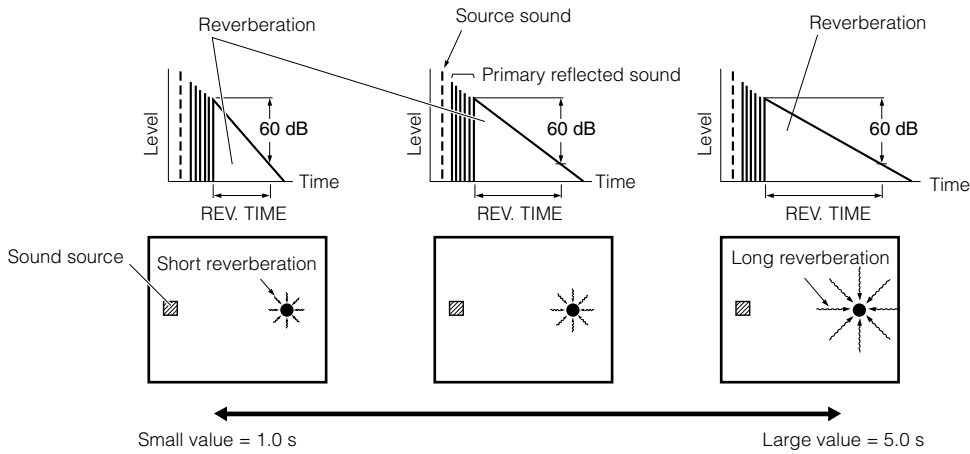

REV. DELAY (Reverberation Delay)

Function This parameter adjusts the time difference between the beginning of the direct sound and the beginning of the reverberation sound.

Control range 0 – 250 ms

Description The larger the value, the later the reverberation sound begins. A later reverberation sound makes you feel like you are in a larger acoustic environment.

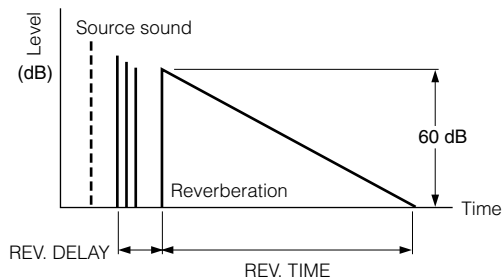

REV. LEVEL (Reverberation Level)

Function This parameter adjusts the volume of the reverberation sound.

Control range 0 – 100%

Description The larger the value, the stronger the reverberation becomes.

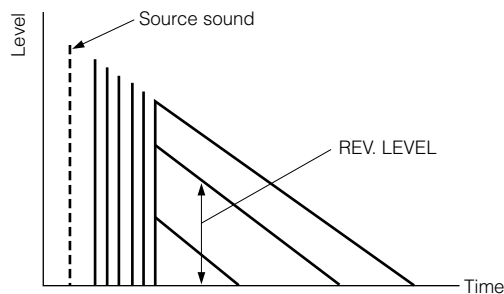

DIGITAL SOUND FIELD PARAMETER DESCRIPTIONS

For 8ch Stereo

■ CT LEVEL (Center Level)

■ RL LEVEL (Rear Left Level)

■ RC LEVEL (Rear Center Level)

■ RR LEVEL (Rear Right Level)

■ FL LEVEL (Front Left Level)

■ FR LEVEL (Front Right Level)

Function These parameters adjust the volume level for each channel in 8-channel stereo mode.

Control range 0 – 100 %

For PRO LOGIC II Music

■ PANORAMA

Function This parameter extends the front stereo image to include the surround speakers for wraparound effect.

Control range OFF/ON

■ DIMENSION

Function This parameter gradually adjusts the soundfield either towards the front or towards the rear.

Control range -3 – STD – +3

■ CENTER WIDTH

Function This parameter adjusts the center image from all three front speakers to varying degrees.

Control range 0 – 7

For DTS Neo: 6 Music

■ C. IMAGE (Center Image)

Function This parameter extends the front stereo image to include the surround speakers for wraparound effect.

Control range 0 – 0.5



Appendix

TROUBLESHOOTING	102
CINEMA EQ FREQUENCY CHARACTERISTICS	105
REFERENCE CHART FOR THE INPUT AND OUTPUT JACKS	106
SPECIFICATIONS	107

TROUBLESHOOTING

Refer to the chart below when this unit does not function properly. If the problem you are experiencing is not listed below or if the instruction below does not help, set this unit in the standby mode, disconnect the power cord, and contact the nearest authorized YAMAHA dealer or service center.

■ General

Problem	Cause	Remedy
This unit fails to turn on when STANDBY/ON (or POWER) is pressed, or enters in the standby mode soon after the power has been turned on.	The power cord is not connected or the plug is not completely inserted.	Firmly connect the power cord.
	IMPEDANCE SELECTOR on the rear panel is not fully set to the upper or lower position.	Set the switch fully to the upper or lower position when this unit is in the standby mode.
	The protection circuitry has been activated.	Make sure all speaker wire connections on this unit and on all speakers are secure and that the wire for each connection does not touch anything other than its respective connection.
	This unit has been exposed to a strong external electric shock (such as lightning and strong static electricity).	Set this unit in the standby mode, disconnect the power cord, plug it back in after 30 seconds, and start operating.
On-screen display does not appear.	The setting for the on-screen display is set to "DISPLAY OFF".	Select the full display or short display mode (see page __).
	The BLUE BACK setting under "15 DISPLAY SET" on the SET MENU is set to "OFF", and no video signal is input to this unit.	Set BLUE BACK to "AUTO" to always show the OSD (see page __).
No sound and/or no picture.	Incorrect input or output cable connections.	Connect the cables properly. If the problem persists, the cables may be defective.
	An appropriate input source has not been selected.	Select an appropriate input source with INPUT SELECTOR or 6CH INPUT (or the input selector buttons) (see page __).
	The speaker connections are not secure.	Secure the connections.
	The main speakers to be used have not been selected properly.	Select the main speakers with SPEAKERS A and/or B (or speaker A and/or B "ON") (see page __).
	The volume is turned down.	Turn up the volume.
	The sound is muted.	Press MUTE or any operation buttons of this unit to cancel a mute and adjust the volume.
	The signals that this unit cannot reproduce such as a CD-ROM are being input.	Play a source whose signals this unit can reproduce.
	The output and input for the picture are connected to different types of video jacks.	Make connections using the same type of jack (between S VIDEO , VIDEO (composite), or COMPONENT VIDEO jacks) for both the input and output.
The sound suddenly goes off.	The protection circuit has been activated because of a short circuit, etc.	Check IMPEDANCE SELECTOR is set to the appropriate position and then turn this unit back on. Check the speaker wires are not touching each other and then turn this unit back on.
	The sleep timer has functioned.	Turn on the power, and play the source again.
	The sound is muted.	Press MUTE or any operation buttons of this unit to cancel a mute and adjust the volume.
	Only the speaker on one side can be heard.	Incorrect cable connections.
BALANCE is turned to the left or right end.		Adjust it to the appropriate position.

Problem	Cause	Remedy
No sound from the effect speakers.	The input source is being played with normal stereo reproduction. ("STEREO" is shown in the front panel display.)	Press STEREO/EFFECT (or the left button labeled "STEREO") to turn on the sound effect (see page ____).
	Digital signals that are over 96 kHz sampling frequency are input into this unit.	
No sound from the center speaker.	"1A CENTER SP" on the SET MENU is set to "NONE".	Select the appropriate mode for your center speaker (see page ____).
	One of the Hi-Fi DSP programs (1 to 6 except for Game and 8ch Stereo) has been selected.	Select another DSP program.
No sound from the rear speakers.	"1C REAR L/R SP" on the SET MENU is set to "NONE".	Select the appropriate speaker mode for the rear L/R speakers (see page ____).
	A monaural source is being played with the program 12.	Select another DSP program.
No sound from the rear center speaker.	"1C REAR L/R SP" on the SET MENU is set to "NONE".	If the speaker mode for the rear L/R speakers is set to "NONE", the speaker mode for the rear center speaker is automatically set to "NONE". Select the appropriate speaker mode for the rear L/R speaker mode (see page ____).
	"1D REAR CT SP" on the SET MENU is set to "NONE".	Select "LRG" or "SML" (see page ____).
No sound from the subwoofer.	"1E LFE/BASS OUT" on the SET MENU is set to "MAIN" when a Dolby Digital or DTS signal is being played.	Select "SW" or "BOTH" (see page ____).
	"1E LFE/BASS OUT" on the SET MENU is set to "SW" or "MAIN" when a 2-channel source is being played.	Select "BOTH" (see page ____).
	The source does not contain low bass signals (90 Hz and below).	
Poor bass reproduction.	"1E LFE/BASS OUT" on the SET MENU is set to "SW" or "BOTH" and your system does not include a subwoofer.	Select "MAIN" (see page ____).
	The output mode for each speaker (main, center, rear, or rear center) on the SET MENU does not match your speaker configuration.	Select the appropriate output mode for each speaker based on the size of the speakers in your configuration.
A "humming" sound can be heard.	Incorrect cable connections.	Firmly connect the audio plugs. If the problem persists, the cables may be defective.
	No connection from the turntable to the GND terminal.	Connect the grounding cord of your turntable to the GND terminal of this unit (see page ____).
The volume level is low while playing a record.	The record is being played on a turntable with an MC cartridge.	The turntable should be connected to this unit through an MC-head amplifier.
The volume level cannot be increased, or the sound is distorted.	The component connected to the OUT (REC) jacks of this unit is turned off.	Turn on the power to the component.
A source cannot be recorded.	A source component is connected to the analog input jacks of this unit for digital recording.	Connect a source component to the digital input jacks.
	Digital connections are not made between this unit and other components for playback or recording.	Make digital connections.
	A source component is connected to the digital input jacks of this unit for analog recording.	Connect a source component to the analog input jacks.
	Analog connections are not made between this unit and other components for playback or recording.	Make analog connections.
	Some recording components cannot record the Dolby Digital or DTS sources.	

TROUBLESHOOTING

Problem	Cause	Remedy
The sound field parameters and some other settings on this unit cannot be changed.	“16 MEMORY GUARD” on the SET MENU is set to “ON”.	Select “OFF” (see page ___).
This unit does not operate properly.	The internal microcomputer has been frozen by an external electric shock (such as lightning or excessive static electricity) or by a power supply with low voltage.	Disconnect the AC power cord from the outlet and then plug it in again after about 30 seconds.
“CHECK SP WIRES” appears on the front panel display.	Speaker cables are short circuited.	Make sure all speaker cables are connected correctly.
The sound is degraded when listening with headphones connected to a tape deck or CD player that is connected to this unit.	This unit is in the standby mode.	Turn on the power of this unit.
There is noise interference from digital or high-frequency equipment, or this unit.	This unit is too close to the digital or high-frequency equipment.	Move this unit further away from such equipment.
This unit suddenly turns into the standby mode.	The internal temperature becomes too high and the overheat protection circuitry has been activated.	Wait until this unit cools down and then turn it back on.

■ Tuner

Program		Cause	Remedy
FM	FM stereo reception is noisy.	The characteristics of FM stereo broadcasts may cause this problem when the transmitter is too far away or the antenna input is poor.	Check the antenna connections. Try using a high-quality directional FM antenna. Use the manual tuning method.
	There is distortion, and clear reception cannot be obtained even with a good FM antenna.	There is multipath interference.	Adjust the antenna position to eliminate multipath interference.
	The desired station cannot be tuned in with the automatic tuning method.	The station is too weak.	Use the manual tuning method. Use a high-quality directional FM antenna.
	Previously preset stations can no longer be tuned in.	This unit has been disconnected for a long period.	Re-store the stations.
AM	The desired station cannot be tuned in with the automatic tuning method.	The signal is weak or the antenna connections are loose.	Tighten the AM loop antenna connections and orient it for best reception. Use the manual tuning method.
	There are continuous crackling and hissing noises.	Noises result from lightning, fluorescent lamps, motors, thermostats and other electrical equipment.	Use an outdoor antenna and a ground wire. This will help somewhat, but it is difficult to eliminate all noise.
	There are buzzing and whining noises (especially in the evening).	A TV set is being used nearby.	Move this unit away from the TV.

Problem	Cause	Remedy
Components do not respond to commands from the remote control.	Wrong distance or angle.	The remote control will function within a maximum range of 10m (33 feet) and no more than 30 degrees off-axis from the front panel of the component.
	Direct sunlight or lighting (from an inverter type of fluorescent lamp, etc.) is striking the remote control sensor of the component.	Reposition the component.
	The batteries are weak (the low battery icon is flashing).	Replace the batteries with new one.
	The remote control is not in the Use mode.	Switch to the Use mode (see page __).
	The button you are trying to use is not programmed properly.	Program the button properly (see page __).
The display of the remote control is blank.	The remote control shuts itself off to save power.	Tap the screen to make sure the remote control is turned on.
	CONTRAST +/- is turned to the + end.	Adjust it to the appropriate position.
	The batteries are not installed properly.	Install the batteries properly.
	The batteries are weak.	Replace the batteries with new one.
The display of the remote control is too light or too dark.		Adjust CONTRAST +/- to the appropriate position.
The remote control beeps 4 times after you insert the batteries.		Use RAVedit to update the remote control's software (RAVedit > Tools > Update RAV-2000).
Buttons are not sending the correct commands.		Check whether the button is programmed globally or per component.
The remote control does not learn commands.	The batteries of this remote controls and/or the other remote control are too weak.	Replace the batteries with new one.
	The distance between the two remote controls is too much or too little.	Place the remote controls at the proper distance (see page __).
	The signal coding or modulation of the remote control is not compatible with this remote control.	Learning is not possible.
Macros do not work.		Make sure the remote control's sending eye is pointed towards the component the entire time the macro is being executed.
	The component cannot respond because the interval between each commands is short.	Insert delay to allow components to start up properly (see page __).
	The inactive buttons are included in your macro.	Check to ensure you have not included inactive buttons in your macro.
	The recorded buttons are reprogrammed, and the macro executes the new commands assigned to the buttons.	Check to ensure you have not reprogrammed the buttons.
The remote control won't edit, label or delete commands.	You try to modify or delete commands for RECEIVER and TUNER.	The RECEIVER and TUNER control panels are locked to prevent unwanted changes. You cannot modify or delete commands for RECEIVER and TUNER (the "locked" label appears).
		Make sure the button you want to edit has a shade. Shadeless buttons cannot be programmed.
	Bright lighting (from an inverter type of fluorescent lamp, etc.) might affect the infrared signals.	Avoid programming the remote control under bright lighting.
The remote control won't switch modes.	When the batteries are weak, the remote control prevents you from switching to customizing modes so that no customization can be lost.	Replace the batteries with new one.

TROUBLESHOOTING

Problem	Cause	Remedy
The remote control is low on memory.		The remote control displays a message indicating it is time to clean up the memory. The remote control will do this by permanently removing the components and macro/timer groups you have deleted. Clearing up memory can take 10 minutes or longer. Never remove the batteries during the process.
The TV goes blank or the input source changes.	The Device menu item might be programmed to switch the input source.	Operate the component without affecting the input source (see page __).
The configuration file is corrupted.		You have to revert to the original configuration. All your customized commands, components and macros are lost. You must reprogram your remote control.
The remote control displays one of the following error messages: <ul style="list-style-type: none"> • Can't open configuration file • Configuration file error • No configuration file found • Invalid configuration file version 		Please contact your dealer or the YAMAHA customer service.

FAQ about the remote control

Can I program a button to execute more than one command?

No, you can't. However, you can create a macro to execute a sequence of commands.

How do I program source switching?

See "Learning device actions" on page ___.

How can I edit, label or delete buttons on the Home menu panels?

You can do this via the Device menu items. All changes you make to these items are automatically updated in the Home menu.

How do I reset the remote control?

Normally, you never have to reset the remote control. However, if the remote control's display freezes or if you notice unusual behavior, you might need to reset. You will not lose any saved programmed commands or macros.

Carefully press **RESET** on the back of the remote control with a paperclip or sharp pencil. The remote control restarts and beeps to indicate it is ready for use.

How do I revert to the original configuration?

Reverting to the original configuration restores the remote control's components and commands to its state when you purchased it. This means that all programming is lost permanently. Normally, you never have to revert the remote control.

1 Touch and hold the remote control icon  for a few seconds.

The first setup panel appears.

2 Scroll to the second setup panel.

3 Tap .

4 Tap  to confirm the action.

Note

- If you find that  is inactive, that is because no change has been made using the remote control, even though you made changes using RAVedit. To activate the button, define the brand of a component or label any element using the remote control's touch screen.

How do I calibrate the touch screen?

The remote control is calibrated when it leaves the factory, so normally you do not have to calibrate it yourself. It is possible that the remote control will display a message requesting that you calibrate the touch screen. If this message appears, do the following:

You will first see the instruction "Touch TOP LEFT corner" and then "Touch BOTTOM RIGHT corner".

1 Tap as close as possible to the upper left corner using the blunt tip of a pencil.

2 Tap as close as possible to the lower right corner using the blunt tip of a pencil.

CINEMA EQ FREQUENCY CHARACTERISTICS

■ L, C, R preset value

HIGH: FRQ 12.7 kHz/GAIN -3 dB

PEQ: FRQ 12.7 kHz/GAIN -4 dB

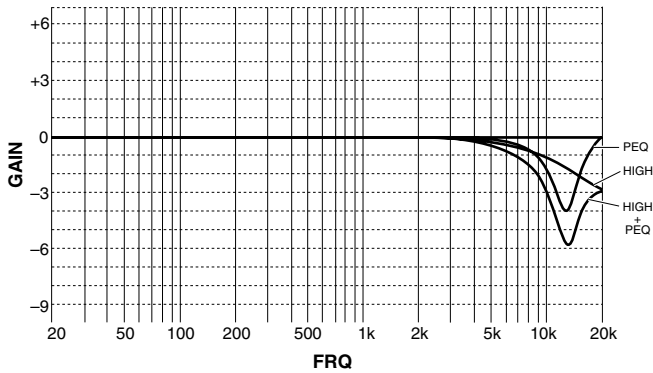

■ FRONT and REAR preset value

HIGH: FRQ 12.7 kHz/GAIN 0 dB

PEQ: FRQ 8.0 kHz/GAIN -3 dB

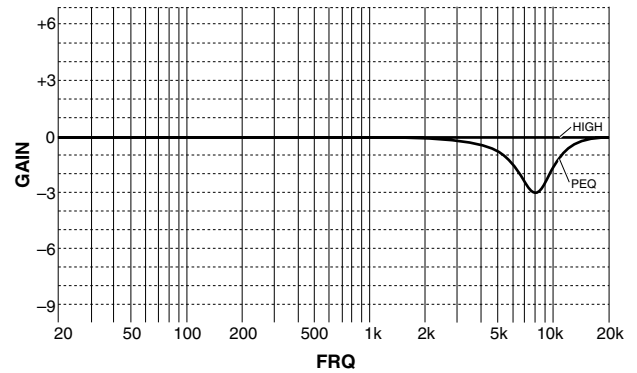

■ HIGH frequency

FRQ 1.0 kHz/GAIN +6 -9 dB

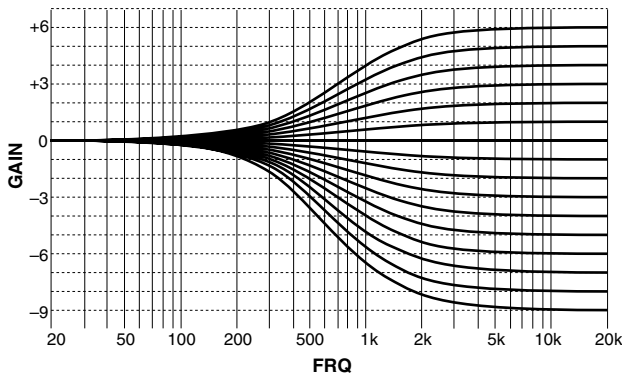

FRQ 1.0 - 12.7 kHz/GAIN +6/-9 dB

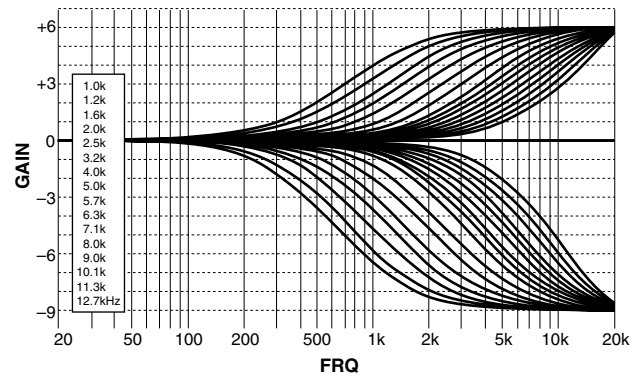

■ PEQ frequency

FRQ 1.0 kHz/GAIN +6 -9 dB/Q 1.85 (fixed)

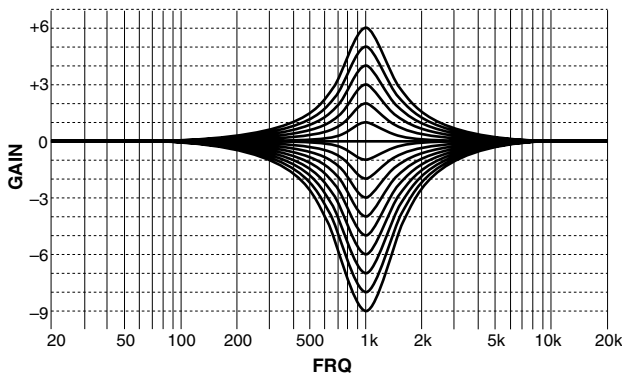

FRQ 1.0 - 12.7 kHz/GAIN +6/-9 dB/Q 1.85 (fixed)

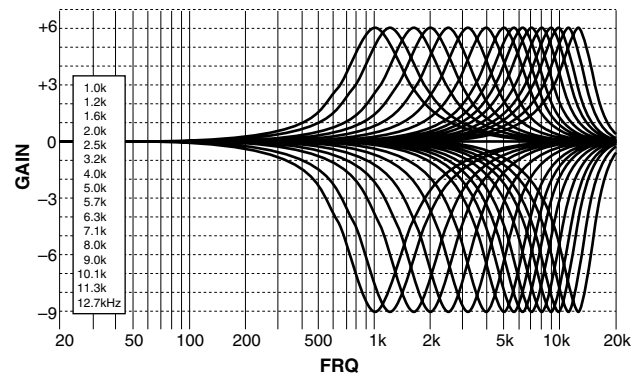

REFERENCE CHART FOR THE INPUT AND OUTPUT JACKS

	AUDIO						VIDEO					
	ANALOG		DIGITAL *1				COMPOSITE		S VIDEO		COMPONENT	
	IN	OUT	COAXIAL		OPTICAL							
			IN	OUT	IN	OUT	IN	OUT	IN	OUT		
PHONO	✓											
CD	✓		✓		✓							
CD-R	✓	✓			✓	✓						
MD/TAPE	✓	✓				✓						
DVD	✓		✓		✓		✓		✓		✓*1	
D-TV/LD	✓		✓*2		✓		✓		✓		✓*1	
CABLE	✓		✓				✓		✓			
SAT	✓				✓		✓		✓		✓*1	
VCR 1	✓	✓					✓	✓	✓	✓		
VCR 2	✓	✓					✓	✓	✓	✓		
VCR 3/DVR	✓	✓			✓		✓	✓	✓	✓		
VIDEO AUX	✓				✓		✓		✓			
6CH INPUT												
MAIN	✓											
SURROUND	✓											
CENTER	✓											
SUBWOOFER	✓											
PREOUT/MAIN IN												
MAIN	✓	✓										
REAR (SURROUND)		✓										
CENTER	✓	✓										
REAR CTR		✓										
SUBWOOFER		✓										
FRONT	✓	✓										
MONITOR OUT								✓		✓		
ZONE 2 OUT		✓						✓				✓
PHONES		✓										
SPEAKERS	MAIN A/B, REAR (SURROUND), CENTER, REAR CENTER, FRONT											

*1 You can designate the input for these jacks according to your component by using "8 I/O ASSIGNMENT" on the SET MENU (see page __ for details).

*2 You can switch the setting of this jack between **LD D D RF (AC-3)** and **COAXIAL LD** by using "8 I/O ASSIGNMENT" on the SET MENU (see page __ for details).

SPECIFICATIONS

■ Audio Section

Minimum RMS Output Power per Channel	
MAIN L/R, CENTER, REAR L/R/C (20 Hz to 20 kHz, 0.015% THD, 8 Ω)	130 W
FRONT L/R (1 kHz, 0.05% THD, 8 Ω)	45 W
Power Band Width	
MAIN L/R (55 W, 0.04% THD, 8 Ω)	10 Hz to 50 kHz
Damping Factor	
MAIN L/R (20 Hz to 20 kHz, 8 Ω)	200 or more
Input Sensitivity/Impedance (100 W/8 Ω)	
CD, etc.	150 mV/47 kΩ
PHONO MM	2.5 mV/47 kΩ
MAIN IN	1 V/47 kΩ
Output Level/Impedance	
REC OUT	150 mV/600 Ω
MAIN OUT	1 V/1.2 kΩ
SUBWOOFER	
[SPLIT L/R]	2 V/1.2 kΩ
[MONO]	4 V/1.2 kΩ
PHONES Output	150 mV/100 Ω
Frequency Response (10 Hz to 100 kHz)	
CD, etc. to MAIN L/R SP. OUT	-3 dB
Total Harmonic Distortion (20 Hz to 20 kHz)	
CD, etc. to MAIN OUT (1 V)	0.005% or less
MAIN IN to SP OUT (65 W/8 Ω)	0.005% or less
Signal to Noise Ratio (IHF-A network)	
(Input shorted, EFFECT off, 250 mV)	100 dB or more
Residual Noise (IHF-A network)	
MAIN L/R SP. OUT	150 μV or less
Channel Separation (Vol -30 dB, 5.1 kΩ terminated)	
1 kHz/10 kHz	70 dB/60 dB or more
Tone Control (MAIN L/R)	
Bass Boost/Cut	±10 dB (50 Hz)
Treble Boost/Cut	±10 dB (20 kHz)
Bass Extension	+6 dB (60 Hz)

■ Video Section

Video Signal Type	NTSC
Composite Video Signal Level	1 V _{p-p} /75 Ω
S-Video Signal Level	
Y	1 V _{p-p} /75 Ω
C	0.286 V _{p-p} /75 Ω
Component Video Signal Level	
Y	1 V _{p-p} /75 Ω
P _B /C _B , P _R /C _R	0.7 V _{p-p} /75 Ω
Maximum Input Level	1.5 V _{p-p}
Signal to Noise Ratio	50 dB or more
Frequency Response (MONITOR OUT)	
VIDEO, S VIDEO	5 Hz to 10 MHz, -3 dB
COMPONENT VIDEO	DC to 100 MHz, -3 dB

■ FM Section

Tuning Range	87.5 to 107.9 MHz
50 dB Quieting Sensitivity (IHF, 100% mod.)	
Mono/Stereo	2.0 μV (17.3 dBf)/25 μV (39.2 dBf)
Selectivity (400 kHz)	70 dB
Signal to Noise Ratio (IHF)	
Mono/Stereo	76 dB/70 dB
Harmonic Distortion (1 kHz)	
Mono/Stereo	0.2%/0.3%
Stereo Separation (1 kHz)	45 dB
Frequency Response	20 Hz to 15 kHz +0.5, -2 dB

■ AM Section

Tuning Range	530 to 1710 kHz
Usable Sensitivity	300 μV/m

■ General

Power Supply	AC 120V, 60 Hz
Power Consumption	550 W
Standby Mode	1.1 W
AC Outlets	3 (Total 100 W maximum)
Dimensions (W x H x D)	435 x 211 x 473 mm (17-1/8" x 8-1/4" x 18-5/8")
Weight	28 kg (61 lbs 11 oz)
Accessories	RAV-2000Z1 Intelligent remote control Batteries (4) (LR6) Power cord Computer interface cable (RS-232C) AM loop antenna Indoor FM antenna

* Specifications are subject to change without notice.

■ Remote Control

Hardware

- High-resolution (320 x 240) liquid crystal display (LCD) with contrast control
- Large touch screen
- Seven programmable direct-access buttons
- Backlighting for LCD and direct-access buttons
- Built-in YAMAHA RC codes
- Infrared sending and learning eyes
- 3-wire (RS-232C) serial port connector
- Database with RC codes to operate different brands

Software

- Dynamic, animated interface
- Editable macros (up to 255 commands per macro)
- Total number of components and macros limited only by memory

Infrared (IR)

- Operating distance: 10 m (33 feet)
- Learning frequency: up to 56 kHz
- Learning distance: 2.5 cm (1") up to 30 cm (1 foot)

Memory

- Non-volatile flash memory (retains commands when batteries are not present)
- 512 K SRAM

Battery Life

- Approximately 6 months with typical use

Power Management

- Power on by tapping the touch screen, power off automatically

Dimensions 136 x 93 x 38mm
(5-3/8" x 3-11/16" x 1-1/2")

Operating Temperature 5° C to 40° C (41° F to 104° F)

Database information:

- Designed by UEI Technology
- Licensed under U.S. Patent 5,689,353
- Portions (c) UEI 1999



YAMAHA ELECTRONICS CORPORATION, USA 6660 ORANGETHORPE AVE., BUENA PARK, CALIF. 90620, U.S.A.
YAMAHA CANADA MUSIC LTD. 135 MILNER AVE., SCARBOROUGH, ONTARIO M1S 3R1, CANADA
YAMAHA ELECTRONIK EUROPA G.m.b.H. SIEMENSSTR. 22-34, 25462 RELINGEN BEI HAMBURG, F.R. OF GERMANY
YAMAHA ELECTRONIQUE FRANCE S.A. RUE AMBROISE CROIZAT BP70 CROISSY-BEAUBOURG 77312 MARNE-LA-VALLÉE CEDEX02, FRANCE
YAMAHA ELECTRONICS (UK) LTD. YAMAHA HOUSE, 200 RICKMANSWORTH ROAD WATFORD, HERTS WD1 7JS, ENGLAND
YAMAHA SCANDINAVIA A.B. J A WETTERGRENS GATA 1, BOX 30053, 400 43 VÄSTRA FRÖLUNDA, SWEDEN
YAMAHA MUSIC AUSTRALIA PTY, LTD. 17-33 MARKET ST., SOUTH MELBOURNE, 3205 VIC., AUSTRALIA

YAMAHA CORPORATION
Printed in Japan **UP** VIDEO V847670