



User Guide

Earphones

EP-E70A

EN

Contents

Notice 4

About this Documentation 4

Trademarks 4

Handling this product 6

Battery-related notes 6

Product Overview 7

Advantages of this product 7

Accessories 9

Part names 11

Charging and Powering 12

Charging this product 12

Turning the power on 13

Turning the power off 14

Checking the remaining battery power 15

Connections 16

Registering a Bluetooth device (pairing) 16

Connecting to a Bluetooth device 18

Disconnecting from a Bluetooth device 19

Connecting using the cable 20

Wearing this product 21

Putting the earphones on 21

Replacing the eartips 22

Operating this Product 23

Adjusting the volume 23

| | |
|--|-----------|
| Listening to music | 24 |
| Receiving a phone call | 25 |
| Using the voice assistance feature on your smartphone | 26 |

Settings **27**

| | |
|--|-----------|
| About the app for earphones/headphones | 27 |
| List of settings (main screen) | 28 |
| Automatically adjust the sound quality according to the volume | 30 |
| Automatically adjust the sound quality according to the product's fit | 31 |
| Playing back sound according to your surroundings | 32 |
| Setting the auto-standby time | 33 |
| Updating the firmware | 34 |

Troubleshooting **35**

| | |
|--|-----------|
| Read this first | 35 |
| No sound can be heard | 36 |
| Your voice is hard to hear with the person to whom you are talking. | 37 |
| Power will not turn on | 38 |
| The product cannot be charged | 39 |
| Cannot connect to a Bluetooth device | 40 |
| The product does not operate or play back | 41 |
| The sound is distorted, noisy or choppy | 42 |
| Problem Still Not Resolved (Customer Support) | 43 |

Appendix **44**

| | |
|--|-----------|
| Specifications | 44 |
| List of operations | 45 |
| List of indicator displays and audio messages | 47 |

Notice

About this Documentation

Trademarks

The trademarks used in this documentation are as follows.



The Bluetooth® word mark and logos are registered trademarks owned by Bluetooth SIG, Inc. and any use of such marks by Yamaha Corporation is under license. Other trademarks and trade names are those of their respective owners.



Qualcomm aptX is product of Qualcomm Technologies, Inc. and/or its subsidiaries.

Qualcomm is a trademark registered by Qualcomm Incorporated in the U.S.A. and other countries. aptX is a trademark registered by Qualcomm Technologies International, Ltd. in the U.S.A. and other countries.

Android™ and Google Play™

Android and Google Play are trademarks of Google LLC.

App StoreSM

The App Store is a service mark of Apple Inc.

Siri®

Siri is a trademark registered by Apple Inc. in the U.S.A. and other countries.

Notice regarding the contents of this documentation

- This documentation is a user's guide intended for the following readers.
 - Those who will use this product
- This documentation classifies precautions and other matters as follows.



WARNING

This content indicates "*risk of serious injury or death.*"



CAUTION

This content indicates "*risk of injury.*"

- **NOTICE**
Indicates points that you must observe in order to prevent product failure, damage or malfunction and data loss, as well as to protect the environment.
- **NOTE**
Indicates notes on instructions, restrictions on functions, and additional information that may be helpful.
- All illustrations and screens shown in this documentation are for explanatory purposes.
- All company names, product names and other such listings in this documentation are the registered trademarks or trademarks of their respective companies.
- Software may be revised and updated without prior notice.

Handling this product

Battery-related notes

The lithium-ion battery contained in this product is a consumable item. To extend the life of the battery as long as possible, use caution regarding the following.

- If the product is not used for a long period of time, the charging time may get longer.
- When storing the product for a long time, charge the product around once every six months to avoid excessive discharge.

Product Overview

Advantages of this product

This product is a set of wireless earphones that connect to Bluetooth devices such as a portable music player or smartphone over the air.

High-definition playback of sound from Bluetooth devices

This product supports the Qualcomm aptX™ Adaptive and AAC codecs.

ADVANCED ANC feature

This feature analyzes the playback sound and outside noise, and reduces only the noise while maintaining the playback sound quality. By reducing noises from outside such as trains, buses and so on, you can absorb yourself in the music without the need to raise the volume too much.

AMBIENT SOUND function

The sounds around you will be mixed together with the playback sound. This feature is convenient when you want to listen to music while being careful of what is going on around you, such as while you are walking, when you want to briefly talk with someone and so on.

LISTENING CARE feature

This product features LISTENING CARE, which lets you enjoy rich sound quality even at low volumes.

Focusing on the characteristics of the human ear where the low- and high-end sounds become harder to hear at lower volumes, as well as how things sound differently in different listening environments, this feature corrects the sound balance for the optimal sound to match the volume. By rendering a natural sound that's easy to listen to, this feature reduces the load on your ears caused by excessive levels.

LISTENING OPTIMIZER feature

This analyzes the audio in real time and adjusts the sound quality to best match how this product fits on your ears and your ear shape.

Smartphone feature support

You can use this product to talk on the phone and start up the voice assistant while connected to this product.

Dedicated smartphone app: Headphones Controller

Use the Headphones Controller app to configure more detailed settings.

Related links

- “About the app for earphones/headphones” (p.27)
- “Automatically adjust the sound quality according to the volume” (p.30)
- “Automatically adjust the sound quality according to the product’s fit” (p.31)
- “Playing back sound according to your surroundings” (p.32)

Accessories

Make sure that all of the accessories are included with this product.

Earphones (main units)

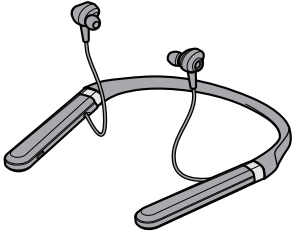

USB power cable (50 cm; type C to A)

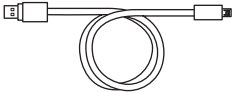

Eartips (XL, L, M, S, XS; one set each)

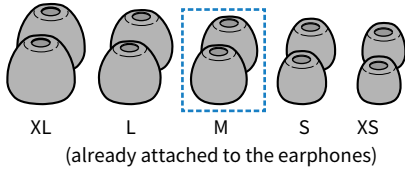

In-flight plug adaptor

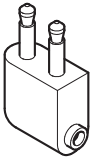

3.5 mm stereo mini-plug cable (type C to 3.5 mm)



Quick Start Guide



User Guide (Basic)



Safety Brochure



Part names

Below is an explanation of the parts of the earphones.

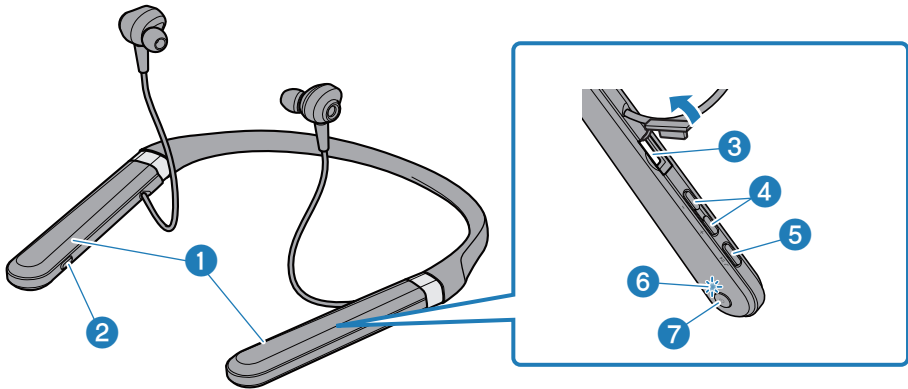

- 1 **Controller**
- 2 **ANC key**
- 3 **Jack for charging and external input**
- 4 **+ key, - key**
- 5 **Function key**
- 6 **Indicator**
- 7 **Power key**

NOTE

The right side controller features a built-in microphone that captures ambient sounds, your voice when making phone calls and so on.

Charging and Powering

Charging this product

Before using this product, charge the controller.

Make sure to use the USB power cable that was included with this product. Also, when using a USB power adaptor, be sure that the adaptor is compatible with 5 V DC (at least 0.5 A) commercially available power output.

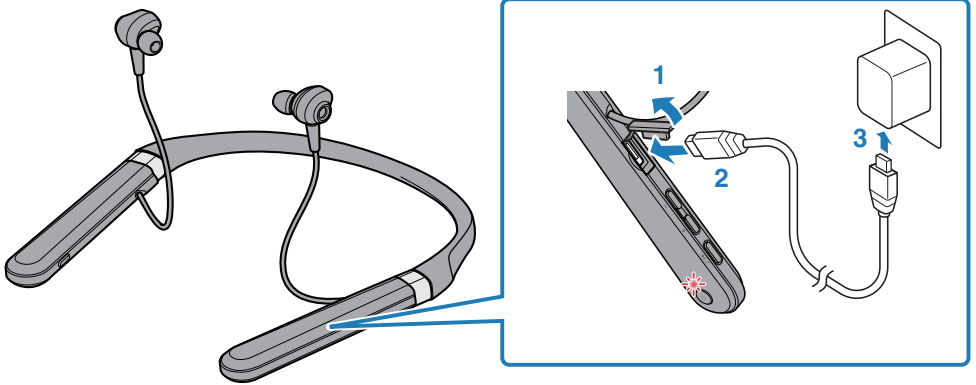

- 1 Remove the cover of the charging connector.**
- 2 Plug the USB power cable into the controller.**
- 3 Plug the USB power cable into the USB power adaptor.**

The indicator lights up during charging, and turns off when charging is completed.

After charging finishes, remove the USB power cable and firmly close the port cover.



CAUTION

- This product is not designed to be waterproof. Do not expose this product to liquids such as sweat, rainwater or seawater.
- Charging this product while a liquid such as sweat, or while foreign matter is on the port may cause a fire, rupture, fluid leakage, electric shock or malfunction.

NOTE

- You may not be able to charge if you use a USB power cable other than the one included with this product.
- You may charge from the USB port on your computer instead of using a USB power adaptor.
- This product's power will turn off during charging. You will not be able to operate or play music at this time.

NOTICE

- When charging this product inside of China, be sure to use a USB power adaptor that is approved by CCC.

Turning the power on

Turn the power on.

1 Hold down the power key on the controller for two seconds.

The indicator lights up as shown below, and the power turns on.

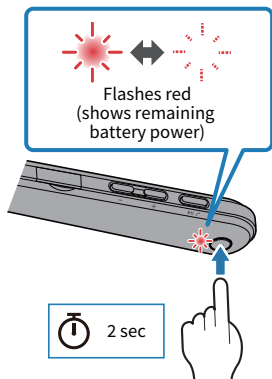

Related links

- “Checking the remaining battery power” (p.15)
- “Registering a Bluetooth device (pairing)” (p.16)
- “Connecting to a Bluetooth device” (p.18)

Turning the power off

Turn the power of this product off.

1 Hold down the power key on the controller for two seconds.

The indicator lights up as shown below, and the power turns off.

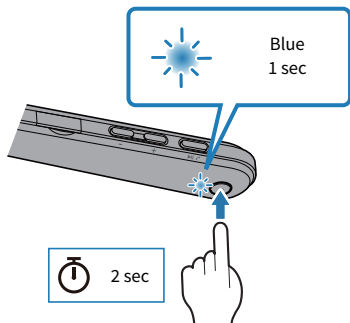

Checking the remaining battery power

After this product are turned on, you can check how much battery power is left from the flashing indicator and the audio message.

- Audio messages:
 - Battery High: plenty of charge remaining
 - Battery Medium: moderate charge remaining
 - Battery Low: small amount of charge remaining
- Indicator (on controller):
 - Flashes three times (red): plenty of charge remaining
 - Flashes two times (red): moderate charge remaining
 - Flashes one time (red): small amount of charge remaining

Connections

Registering a Bluetooth device (pairing)

When first connecting this product to a Bluetooth device, follow the steps below to register (pair) this product with that device.

1 Set this product to pairing mode.

With the controller turned off, hold down the Power key on the controller until the indicator flashes as shown in the illustration below. You will hear the “Pairing” audio message in the earphone, and the earphone will enter registration (pairing) standby mode.

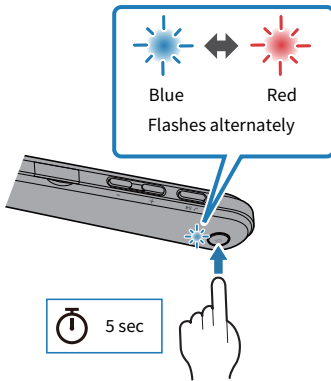

2 Activate the Bluetooth function on the Bluetooth device.

A list of Bluetooth devices that can be connected will be shown.

3 Select this product from this list on your Bluetooth device.



If successfully connected, you will hear the “Pairing Successful” audio message.

The indicator on this product lights up blue (for about 20 seconds).

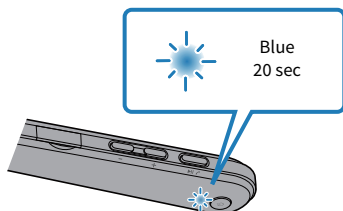

NOTE

- Pairing standby mode will automatically end after about two minutes. To register again, start from step 1.
- Up to 8 devices can be registered with this product. From the 9th device on, older registrations will be deleted (the oldest is deleted first).
- If a passkey is required when connecting, input “0000”.

Related links

- “Connecting to a Bluetooth device” (p.18)
- “Disconnecting from a Bluetooth device” (p.19)
- “About the app for earphones/headphones” (p.27)

Connecting to a Bluetooth device

This product connects to Bluetooth devices with which it has already been registered (paired).

When you turn the power on, they will search for the last Bluetooth device to which they were connected, and connect automatically.

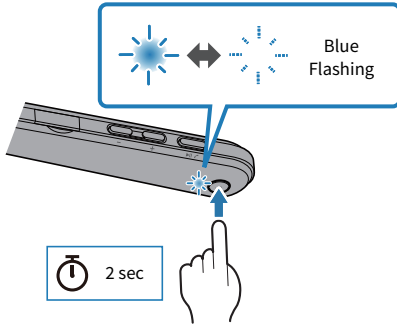

If this product do not automatically connect to a Bluetooth device, it is waiting for connection. Operate the Bluetooth device to connect with this product.

If successfully connected, you will hear the “Connected” audio message. The indicator will display as shown below.

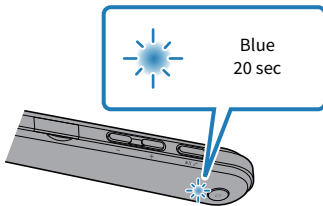

NOTE

This product connects to a single Bluetooth device, and cannot connect to multiple devices at the same time.

Related links

- “Registering a Bluetooth device (pairing)” (p.16)
- “Disconnecting from a Bluetooth device” (p.19)
- “About the app for earphones/headphones” (p.27)

Disconnecting from a Bluetooth device

Follow the steps below to disconnect a Bluetooth device.

- Disconnect the earphones by operating the Bluetooth device.
 - This product will enter the waiting mode for a connection from a Bluetooth device.
- Turn the Bluetooth device's power off.
 - This product will enter the waiting mode for a connection from a Bluetooth device.
- Turn the power of this product off.

Related links

- "Registering a Bluetooth device (pairing)" (p.16)
- "Connecting to a Bluetooth device" (p.18)
- "About the app for earphones/headphones" (p.27)

Connecting using the cable

You can connect this product to the headphone output jack of an external device by using the 3.5 mm stereo mini-plug cable (included).

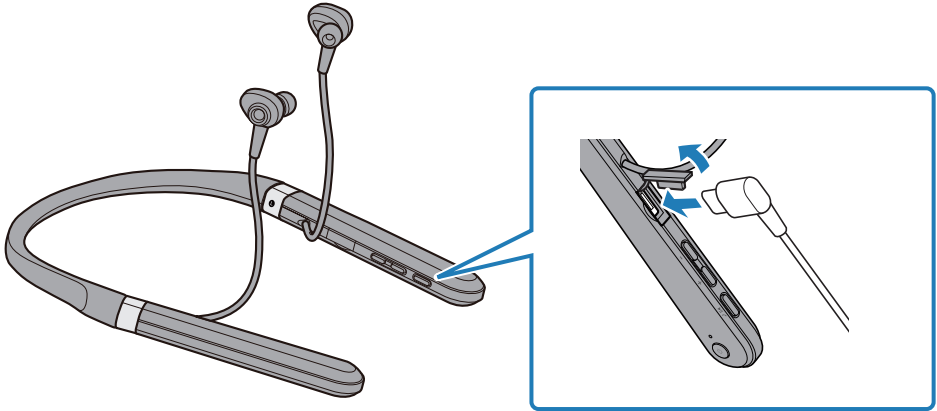

- The following functions will not be available when connecting via cable.
 - Connecting to a Bluetooth device
 - Phone calls
 - Operating this product using the Headphones Controller
 - Using the keys on this product (except for the power and ANC keys)
- When this product is on, you can switch between AMBIENT SOUND and NOISE CANCELLING by using the ANC key, even when the cable is connected.
- When using this product with the cable connected, you can use it as a regular pair of earphones even when the power is off.
- Unplugging the cable will turn off the power.

NOTICE

- Do not use any other cable besides the one supplied with this product. Using an aftermarket cable or adaptor may cause a malfunction.

NOTE

Use the included in-flight plug adaptor to connect this product to the headphones jack on an airplane seat.

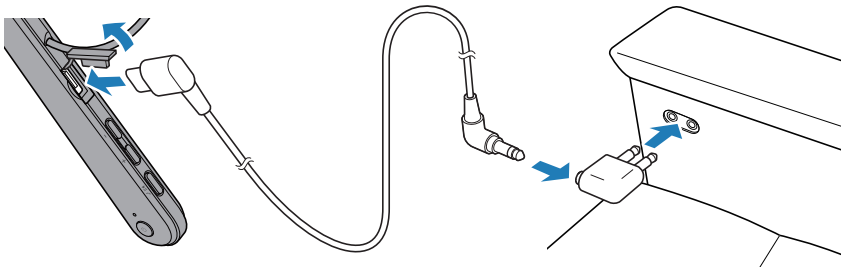

Wearing this product

Putting the earphones on

Check the markings on the earphones for the left and right sides to make sure they are worn in the correct ear, and insert them into your ear.

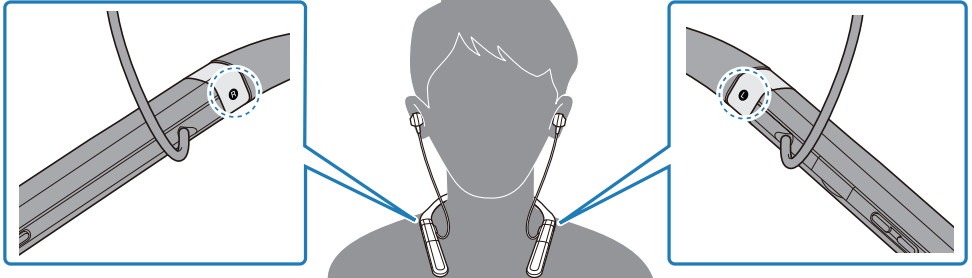

Related links

[“Replacing the eartips” \(p.22\)](#)

Replacing the eartips

You will be able to listen to your music with better sound by using eartips that match your ears. When putting the earphones on, use the eartips that keep out ambient sounds as much as possible while the music is stopped.

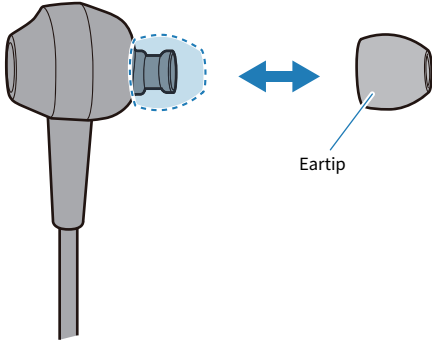

NOTE

5 sizes of eartips are included with this product. The earphones come pre-attached with M-size eartips.



CAUTION

- Do not use broken eartips and do not wear the earphones without eartips. Doing so may damage your ears.
- Firmly attach the eartips. Failure to do so may cause them to come loose inside your ears, which may damage your ears. If an eartip comes loose inside your ear, consult a physician.
- Once removed, keep the eartips out of reach of children, to avoid them being accidentally swallowed.

Operating this Product

Adjusting the volume

Follow the steps below to adjust the volume.

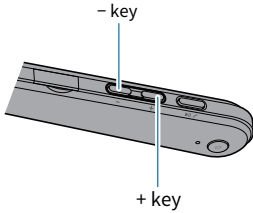

- Turn the volume up
Press the + key on the controller.
- Turn the volume down
Press the - key on the controller.

NOTE

- When connecting to a device (such as a smartphone) on which the volume can be adjusted, you can also adjust the volume using that device.
- You cannot use the +/- keys while the 3.5 mm stereo mini-plug cable is connected.

Listening to music

You can use the following functions during playback.

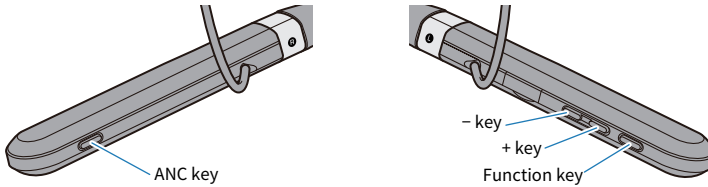

- Pause or restart playback
Press the function key on the controller.
- Skip to the next song
Hold down the + key on the controller until you hear a “beep” sound (about two seconds).
- Go back to the beginning of the song, or skip to the previous song
Hold down the – key on the controller until you hear a “beep” sound (about two seconds).
- Switching the NOISE CANCELLING/AMBIENT SOUND on and off
Press the ANC key on the right side controller. The status changes in the following order.
 - NOISE CANCELLING (default setting): the “Noise Cancel” audio message will be heard from this product.
 - AMBIENT SOUND: the “Ambient Sound” audio message will be heard from this product.
 - NOISE CANCELLING/AMBIENT SOUND disabled : the “Off” audio message will be heard from this product.

NOTE

- To select a song for playback, operate your Bluetooth device.
- You can also set the NOISE CANCELLING/AMBIENT SOUND feature with the Headphones Controller app.

Related links

- “Adjusting the volume” (p.23)
- “Playing back sound according to your surroundings” (p.32)

Receiving a phone call

When connecting to a Bluetooth device (such as a smartphone) that has phone call functionality, you can talk using this product. Operate this product as follows.

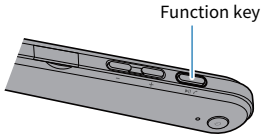

- Receive a phone call
Press the function key on the controller.
- End a phone call
Press the function key on the controller while the call is active.
- Ignore a call
Hold down the function key on the controller for about two seconds when a call is coming in.

NOTE

When a call is coming in, any music being played will be paused. Music playback will automatically resume when the call ends or you ignore the call.

Related links

[“Adjusting the volume” \(p.23\)](#)

Using the voice assistance feature on your smartphone

When connecting this product to a Bluetooth device that supports a voice assistance feature such as Siri or Google Assistant, you can control the voice assistant with this product.

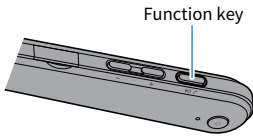

1 Press the function key on the controller twice.

The voice assistant will start, and you can operate it using your voice.

NOTE

- The operations for the voice assistant feature will vary depending on your Bluetooth device. See the user's manual of your Bluetooth device for details.
- To finish listening to the voice assistant, operate your Bluetooth device.

Settings

About the app for earphones/headphones

The Headphones Controller smartphone app is a dedicated app for getting the best sound quality from your Yamaha earphones or headphones.



This app will let you do the following.

- Show the status of your earphones/headphones (such as remaining battery power)
- Make detailed settings on your earphones/headphones

Install the app from the App Store (iOS devices) or from Google Play (Android devices).

See the information about the app on each store for details.

Related links

- “Automatically adjust the sound quality according to the volume” (p.30)
- “Automatically adjust the sound quality according to the product’s fit” (p.31)
- “Playing back sound according to your surroundings” (p.32)
- “Setting the auto-standby time” (p.33)

List of settings (main screen)

The settings that you can make on the main screen of the Headphones Controller app are shown below.

NOTE

The app screen may differ, depending on your product.

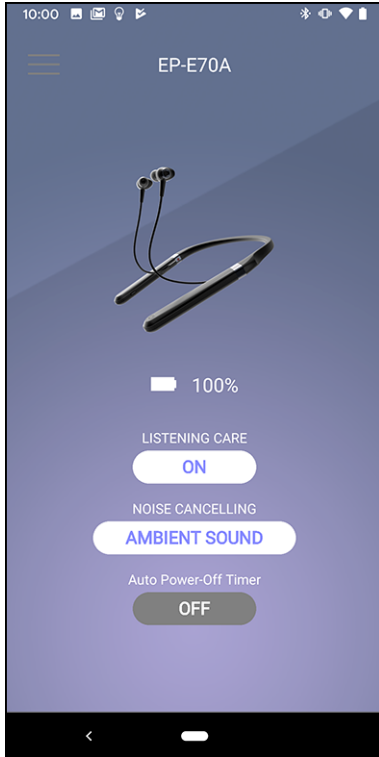

- LISTENING CARE
Turns LISTENING CARE (a feature that automatically adjusts the sound quality according to the volume) on/off.
- NOISE CANCELLING
This sets the balance between the playback and ambient sound.
- LISTENING OPTIMIZER
Turns LISTENING OPTIMIZER on/off (a feature that measures and analyzes the sound in real time and automatically adjusts the sound quality).
- Auto Power-Off Timer
Sets the time it takes for the power to turn off after Bluetooth has been disconnected.

Settings > List of settings (main screen)

Related links

- “About the app for earphones/headphones” (p.27)
- “Automatically adjust the sound quality according to the volume” (p.30)
- “Automatically adjust the sound quality according to the product’s fit” (p.31)
- “Playing back sound according to your surroundings” (p.32)
- “Setting the auto-standby time” (p.33)

Automatically adjust the sound quality according to the volume

When LISTENING CARE is enabled, this product will automatically adjust the sound quality according to the playback volume.

This feature adjusts the frequency balance, offering rich sound quality playback even at a low volume.

Use the Headphones Controller app to make these settings.

- LISTENING CARE
Settings
 - ON (default setting): enables LISTENING CARE
 - OFF : disables LISTENING CARE

Related links

- “About the app for earphones/headphones” (p.27)
- “List of settings (main screen)” (p.28)

Automatically adjust the sound quality according to the product's fit

When LISTENING OPTIMIZER is enabled, this product will automatically adjust the sound quality to best match how the earphones fit on your ears and your ear shape.

Use the Headphones Controller app to make these settings.

- LISTENING OPTIMIZER
 - Settings
 - ON (default setting): enables LISTENING OPTIMIZER
 - OFF : disables LISTENING OPTIMIZER

Related links

- "About the app for earphones/headphones" (p.27)
- "List of settings (main screen)" (p.28)

Playing back sound according to your surroundings

You can set how this product sounds according to the situation, such when you want to enjoy music in a noisy location, or when you want to be able to hear what is going on around you while you are listening.

When NOISE CANCELLING is enabled, the ADVANCED ANC feature built into this product reduces outside noise while maintaining the quality of sound playback.

When you enable the AMBIENT SOUND feature, the sounds around you will be mixed together with the playback sound. This feature is useful when you want to listen to music while being careful of your surroundings, such as when you are out walking, when you want to briefly talk with someone and so on.

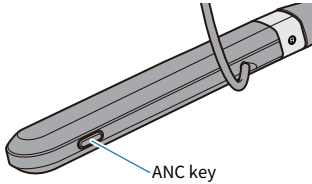

1 Press the ANC key.

The setting changes in the following order.

- NOISE CANCELLING (default setting): the “Noise Cancel” audio message will be heard from this product.
- AMBIENT SOUND : the “Ambient Sound” audio message will be heard from this product.
- NOISE CANCELLING, AMBIENT SOUND disabled : the “Off” audio message will be heard from this product.

NOTE

- You can also set this feature with the NOISE CANCELLING button in the Headphones Controller app. The settings are as follows.
 - NOISE CANCELLING(default setting): the active noise cancelling feature of this product will reduce the noise from outside when sound is played back.
 - AMBIENT SOUND : the sounds around you will be mixed together with the playback sound.
 - OFF : the sound will play back without noise cancellation processing.
- Depending on the type of sound you are playing back and what is going on around you, the ambient sound may not be so easy to hear. In this case, pause the playback.
- Do not cover the microphone of this product with your hand. If your hand is covering the mic, the NOISE CANCELLING and AMBIENT SOUND will not work properly, and you may hear noise.

Related links

- “Part names” (p.11)
- “About the app for earphones/headphones” (p.27)

Setting the auto-standby time

This product will automatically shut off when a certain amount of time has passed without a connection from a Bluetooth device. You can set the time it takes for the power to turn off after no connection has been received.

Use the Headphones Controller app to make these settings.

- Auto Power-Off Timer
 - Settings
 - 5min
 - 30min
 - 1h
 - 3h
 - OFF (default setting): continuous (power is not automatically turned off)

Related links

- “Turning the power on” (p.13)
- “About the app for earphones/headphones” (p.27)
- “List of settings (main screen)” (p.28)

Updating the firmware

The firmware on this product can be updated to add new functionality, rectify product issues and so on. Updates are performed using Headphones Controller.

For more details on the contents of updates, see the product information page on the Yamaha website.

NOTICE

For stable data communication between this product and your Bluetooth device, update the firmware in a place where the signal is good.

Do not do the following while the firmware is being updated.

- Connecting the controller to a power source for charging
- Turning the power of this product off
- Closing the Headphones Controller app, or using another app
- Turning your smartphone off
- Canceling the connection between your smartphone and this product

1 On the main screen of the Headphones Controller app, open the menu.

2 Tap “Confirm Firmware Update”.

If new firmware has been released, you will see instructions on how to perform the update. Install the firmware by following the instructions on the screen.

Related links

- “Charging this product” (p.12)
- “Turning the power off” (p.14)
- “About the app for earphones/headphones” (p.27)
- “List of settings (main screen)” (p.28)

Troubleshooting

Read this first

If this product does not operate normally while you are using it, first check the following.

- **Turn the power off and then on again.**
- **Make sure that this product have been sufficiently charged.**
 - “Charging this product” (p.12)
- **Update the firmware of this product to the latest version.**
 - “Updating the firmware” (p.34)
- **Also, check the following.**
 - “No sound can be heard” (p.36)
 - “Your voice is hard to hear with the person to whom you are talking.” (p.37)
 - “Power will not turn on” (p.38)
 - “The product cannot be charged” (p.39)
 - “Cannot connect to a Bluetooth device” (p.40)
 - “The product does not operate or play back” (p.41)
 - “The sound is distorted, noisy or choppy” (p.42)
 - “Problem Still Not Resolved (Customer Support)” (p.43)

No sound can be heard

● **This product are not connected to a Bluetooth device.**

Pair this product.

- “Connecting to a Bluetooth device” (p.18)

● **The volume is too low.**

Raise the volume.

- “Adjusting the volume” (p.23)

● **The music stopped playing back.**

Start playback.

- “Listening to music” (p.24)

● **The eartips don't fit my ears.**

Select eartips that match your ear shape, and make sure that they fit securely.

- “Replacing the eartips” (p.22)

● **The cable may not be correctly connected (when using the 3.5 mm stereo mini-plug cable).**

The 3.5 mm stereo mini-plug cable jack of this product may not be correctly connected to your external device.

- “Connecting using the cable” (p.20)

● **The volume of the external device is low when using a 3.5 mm stereo mini-plug cable.**

Raise the volume on your external device.

Troubleshooting > Your voice is hard to hear with the person to whom you are talking.

Your voice is hard to hear with the person to whom you are talking.

- **You may be speaking too far away from the microphone.**

Move your mouth closer to the controller.

Power will not turn on

● **There may not be enough battery power left.**

Charge this product.

- “Charging this product” (p.12)

The product cannot be charged

- **Your computer is not turned on (when charging from your computer).**
Turn the power of your computer on, and then charge this product.
- **You may have been using a USB power cable other than the one included with this product.**
Use the included USB power cable to make sure the product correctly charges.

Cannot connect to a Bluetooth device

● **This product and your Bluetooth device may be too far apart.**

Move this product closer to the Bluetooth device.

● **A device that emits electromagnetic waves (such as a microwave oven, access point and so on) might be nearby.**

Do not use this product near other devices that emit electromagnetic waves.

● **The connection information for the registered Bluetooth device may not be working properly.**

Delete the connection information of this product from the Bluetooth device, and then pair this product with the device.

- “Registering a Bluetooth device (pairing)” (p.16)

● **The registration information for the Bluetooth device that was registered on this product may have been deleted.**

Pair this product once more.

- “Registering a Bluetooth device (pairing)” (p.16)

● **This product may already be connected to another Bluetooth device.**

Disconnect that Bluetooth device, and then connect this product with the new device.

● **The 3.5 mm stereo mini-plug cable may be connected.**

Remove the 3.5 mm stereo mini-plug cable, and then connect your Bluetooth device.

The product does not operate or play back

- **This product may be charging.**

You cannot use this product while they are charging. Use the earphones after charging is finished.

- **There is no remaining battery power on this product.**

Charge this product.

- “Charging this product” (p.12)

- **The product is temporarily not functioning in a stable way.**

Turn the power off and then on again.

The sound is distorted, noisy or choppy

- **The signal may not be coming in clearly, making the connection unstable.**

Move away from wireless devices such as access points, or appliances that produce electromagnetic waves such as microwave ovens.

Try placing the connected Bluetooth device as close to this product as you can.

Devices with wireless network connectivity may transmit signals that obstruct Bluetooth communications. In this case, turn off the wireless network connectivity feature on your Bluetooth device.

Problem Still Not Resolved (Customer Support)

If the trouble still cannot be solved, please contact us for product support as shown below.

● **For customers within Japan**

Please contact the store where you purchased this product, or the Product Support Center as listed in the “User Guide (Basic).”

● **For customers outside of Japan**

Please contact your nearest authorized Yamaha dealer or service center.

Appendix

Specifications

The specifications of this product are as shown below.

- Driver type
 - Dynamic
- Driver unit
 - 9.2 mm
- Frequency range
 - 20–20,000 Hz
- Bluetooth version
 - 5.0
- Supported profiles
 - A2DP, AVRCP, HFP, HSP
- Supported codecs
 - SBC, AAC, Qualcomm® aptX™ Adaptive
- Supported content protection (Japan only)
 - SCMS-T
- RF output power
 - Class 1
- Maximum communication range
 - 10 m (without obstructions)
- Maximum number of pairable devices
 - 8

Rechargeable battery

- Internal rechargeable battery
 - Lithium-ion battery
- Charging time (to full capacity)
 - Earphones: approx. 2.5 hours
- Continuous playback time
 - With noise cancelling (ANC) on: approx. 18 hours
- Charging temperature
 - +5–+40 °C

General

- Weight
 - 62.0 g

List of operations

The main operations of this product are as shown below.

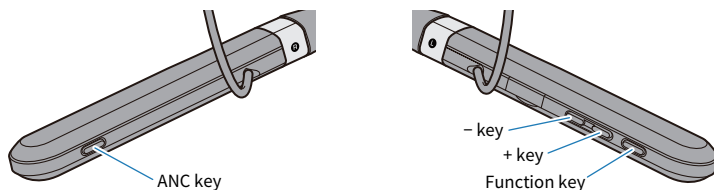

Power

- Power on
 - Power key (hold down for two seconds)
- Power off
 - Power key (hold down for two seconds)

Volume

- Volume up
 - + key
- Volume down
 - - key

Music playback

- Pause/play
 - Function key
- Skip to the next song
 - + key (hold down until you hear a “beep”)
- Go back to the beginning of the song (while in the middle of the song), or back to the previous song (when at the beginning of a song)
 - - key (hold down until you hear a “beep”)

Selecting the modes

- Turning the NOISE CANCELLING/AMBIENT SOUND on/off
 - ANC key

Phone calls

- Receive a phone call
 - Function key
- End a phone call
 - Function key
- Ignore a call
 - Function key (hold down for two seconds)

Other functions

- Start pairing
 - Hold down the Power key with the power off (five seconds)
- Start voice assistant
 - Function key (press quickly, two times in a row)

List of indicator displays and audio messages

The indicator displays and audio messages on this product are shown below.

Product indicator display

- Power on
 - Flashes according to the remaining battery power.
 - Flashes red three times: plenty of charge remaining
 - Flashes red two times: moderate charge remaining
 - Flashes red one time: small amount of charge remaining
- Standby mode for pairing with Bluetooth device
 - Flashes (between red and blue alternately)
- Searching for paired Bluetooth device
 - Flashes (blue)
- Finished connecting to Bluetooth device
 - Lights up for 20 second (blue) and turns off
- Power off
 - Lights up for 1 second (Blue) and turns off

Indicator display when charging

- Charging
 - Lights up (red)
- Charging completed
 - Not lit

Audio messages

- Battery High
 - Plenty of battery charge remaining
- Battery Medium
 - Moderate battery charge remaining
- Battery Low
 - Small amount of battery charge remaining
- Power Off
 - Power off
- Pairing
 - Start device registration (pairing)
- Pairing Successful
 - Pairing successful/finished connecting
- Pairing Failed
 - Pairing unsuccessful
- Connected
 - Finished connecting to Bluetooth device
- Disconnected
 - Disconnected from Bluetooth device
- Noise Cancel
 - NOISE CANCELLING enabled
- Ambient Sound
 - AMBIENT SOUND enabled
- Off
 - Disables NOISE CANCELLING, AMBIENT SOUND

Related links

- “Turning the power on” (p.13)
- “Turning the power off” (p.14)
- “Checking the remaining battery power” (p.15)
- “Registering a Bluetooth device (pairing)” (p.16)
- “Connecting to a Bluetooth device” (p.18)
- “Playing back sound according to your surroundings” (p.32)

Yamaha Global Site
<https://www.yamaha.com/>

Yamaha Downloads
<https://download.yamaha.com/>

Manual Development Group
© 2020 Yamaha Corporation

Published 10/2020 AM-B0

AV19-0262