

YAMAHA

R-V902

Natural Sound AV Receiver

Thank you for selecting this YAMAHA AV receiver.

OWNER'S MANUAL

CONTENTS

Supplied Accessories	2	Preset Tuning	24
Features	3	Using Digital Sound Field Processor (DSP)	27
Caution	4	Setting the SLEEP Timer	31
Profile of This Unit	5	Remote Control Transmitter	32
Speaker Setup	6	Notes about the Remote Control Transmitter	42
Connections	7	Troubleshooting	43
Controls and Their Functions	14	Specifications	44
Speaker Balance Adjustment	17		
Basic Operations	20		
Tuning Operations	23		

SUPPLIED ACCESSORIES

After unpacking, check that the following parts are included.

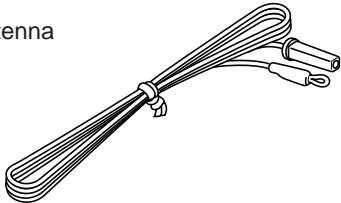
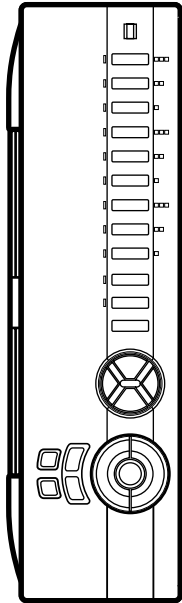
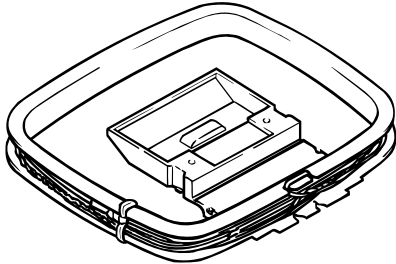
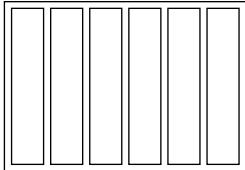
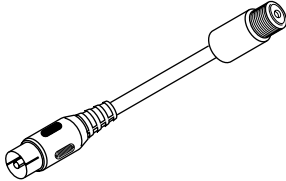
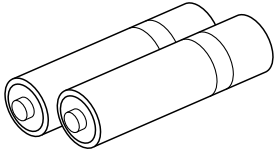
<p>Indoor FM Antenna</p> 	<p>Remote Control Transmitter</p> 
<p>AM Loop Antenna</p> 	<p>User function stickers</p> 
<p>Antenna adapter (U.S.A. and Canada models only)</p> 	
<p>Batteries (size AA, R6, UM-3)</p> 	

FEATURES

- **5 Speaker Configuration**
 - Main: 90W + 90W (8Ω) RMS Output Power, 0.07% THD, 1 kHz
 - Center: 90W (8Ω) RMS Output Power, 0.07% THD, 1 kHz
 - Rear: 35W + 35W (8Ω) RMS Output Power, 0.3% THD, 1 kHz
- **Digital Sound Field Processor**
- **Dolby Pro Logic Surround Decoder**
- **Theater-like Sound Experience by the Combination of Dolby Pro Logic and YAMAHA DSP Technology (CINEMA DSP)**
- **Automatic Input Balance Control for Dolby Pro Logic Surround**
- **Test Tone Generator for Easier Speaker Balance Adjustment**
- **3 Center Channel Modes (NORMAL/WIDE/PHANTOM)**
- **BASS EXTENSION Switch for Reinforcing Bass Response**
- **40-Station Random Access Preset Tuning**
- **Automatic Preset Tuning**
- **Preset Station Shifting Capability (Preset Editing)**
- **IF Count Direct PLL Synthesizer Tuning System**
- **Video Signal Input/Output Capability**
- **6-Channel Discrete Input Terminals for Connecting with a Dolby Digital (AC-3) Decoder**
- **SLEEP Timer**
- **“Learning” Remote Control Transmitter**

CAUTION: READ THIS BEFORE OPERATING YOUR UNIT.

1. To assure the finest performance, please read this manual carefully. Keep it in a safe place for future reference.
2. Install this unit in a cool, dry, clean place – away from windows, heat sources, sources of excessive vibration, dust, moisture and cold. Avoid sources of humming (transformers, motors). To prevent fire or electrical shock, do not expose the unit to rain or water.
3. Never open the cabinet. If something drops into the set, contact your dealer.
4. Do not use force on switches, controls or connection wires. When moving the unit, first disconnect the power plug and the wires connected to other equipment. Never pull the wires themselves.
5. The openings on the cabinet assure proper ventilation of the unit. If these openings are obstructed, the temperature inside the cabinet will rise rapidly. Therefore, avoid placing objects against these openings, and install the unit in well-ventilated condition. Make sure to allow a space of at least 10 cm behind, 20 cm on the both sides and 30 cm above the top panel of the unit. Otherwise it may not only damage the unit, but also cause fire.
6. Always set the VOLUME control to “- ∞” before starting the audio source play. Increase the volume gradually to an appropriate level after playback has been started.
7. Do not attempt to clean the unit with chemical solvents; this might damage the finish. Use a clean, dry cloth.
8. Be sure to read the “TROUBLESHOOTING” section regarding common operating errors before concluding that the unit is faulty.
9. When not planning to use this unit for long periods of time (ie., vacation, etc.), disconnect the AC power plug from the wall outlet.
10. To prevent lightning damage, disconnect the AC power plug and disconnect the antenna cable when there is an electrical storm.
11. Grounding or polarization – Precautions should be taken so that the grounding or polarization of an appliance is not defeated.
12. AC outlet
Do not connect audio equipment to the AC outlet on the rear panel if that equipment requires more power than the outlet is rated to provide.
13. **Voltage Selector (General Model only)**
The voltage selector on the rear panel of this unit must be set for your local main voltage BEFORE plugging into the AC main supply.
Voltages are 110/120/220/240 V AC, 50/60 Hz.

This unit is not disconnected from the AC power source as long as it is connected to the wall outlet, even if this unit itself is turned off.
In this state, this unit is designed to consume a very small quantity of power.

IMPORTANT

Please record the serial number of this unit in the space below.

Serial No.:

The serial number is located on the rear of the unit. Retain this Owner's Manual in a safe place for future reference.

WARNING

TO REDUCE THE RISK OF FIRE OR ELECTRIC SHOCK, DO NOT EXPOSE THIS UNIT TO RAIN OR MOISTURE.

FOR CANADIAN CUSTOMERS

TO PREVENT ELECTRIC SHOCK, MATCH WIDE BLADE OF PLUG TO WIDE SLOT AND FULLY INSERT.

THIS CLASS B DIGITAL APPARATUS MEETS ALL REQUIREMENTS OF THE CANADIAN INTERFERENCE-CAUSING EQUIPMENT REGULATIONS.

FREQUENCY STEP switch (General Model only)

Because the interstation frequency spacing differs in different areas, set the FREQUENCY STEP switch (located at the rear) according to the frequency spacing in your area. Before setting this switch, disconnect the AC power plug of this unit from the AC outlet.

WARNING

Do not change the IMPEDANCE SELECTOR switch setting while the power to this unit is on, otherwise this unit may be damaged.

IF THIS UNIT FAILS TO TURN ON WHEN THE POWER SWITCH IS PRESSED

The **IMPEDANCE SELECTOR** switch may not be set to either end closely. If so, set the switch to either end closely.

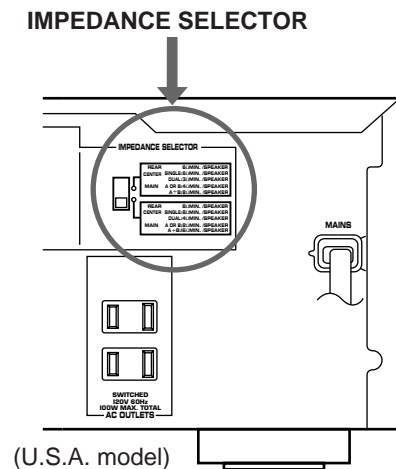

PROFILE OF THIS UNIT

You are the proud owner of a Yamaha stereo receiver –an extremely sophisticated audio component. The Digital Sound Field Processor (DSP) built into this unit takes advantage of Yamaha's undisputed leadership in the field of digital audio processing to bring you a whole new world of listening experiences. Follow the instructions in this manual carefully when setting up your system, and this unit will sonically transform your room into a wide range of listening environments –movie theater, concert hall, and so on. In addition, you get incredible realism from sources encoded with Dolby Surround using the built-in Dolby Pro Logic Surround Decoder.

Please read this operation manual carefully and store it in a safe place for later reference.

Digital Sound Field Processing

What is it that makes live music so good? Today's advanced sound reproduction technology lets you get extremely close to the sound of a live performance, but chances are you'll still notice something missing: the acoustic environment of the live concert hall. Extensive research into the exact nature of the sonic reflections that create the ambience of a large hall has made it possible for Yamaha engineers to bring you this same sound in your own listening room, so you'll feel all the sound of a live concert.

Furthermore, our technicians, armed with sophisticated measuring equipment, have even made it possible to capture the acoustics of a variety of venues such as an actual concert hall, theater, etc. to allow you to accurately recreate one of several actual live performance environments, all in your own home.

Dolby Pro Logic Surround

This unit employs a Dolby Pro Logic Surround decoder similar to professional Dolby Stereo decoders used in many movie theaters. By using the Dolby Pro Logic Surround decoder, you can experience the dramatic realism and impact of Dolby Surround movie theater sound in your own home. Dolby Pro Logic employs a four channel five speaker system. The Pro Logic Surround system divides the input signal into four levels: the left and right main channels, the center channel (used for dialog), and the rear surround sound channels (used for sound effects, background noise, and other ambient noises). The center channel allows listeners seated in even less-than-ideal positions to hear the dialog originating from the action on the screen while experiencing good stereo imaging. Dolby Surround is encoded on the sound track of pre-recorded video tapes, laser discs, and some TV/cable broadcasts. When you play a source encoded with Dolby Surround on this unit, the Dolby Pro Logic Surround decoder decodes the signal and distributes the surround-sound effects.

This Dolby Pro Logic Surround Decoder employs a digital signal processing system. This system improves the stability of sound at each channel and minimizes crosstalk between channels, so that positioning of sounds around the room is more accurate compared with conventional analog signal processing systems. In addition, this unit features a built-in automatic input balance control. This always assures you the best performance without manual adjustment.

Manufactured under license from Dolby Laboratories Licensing Corporation. "Dolby", "AC-3", "Pro Logic", and the double-D symbol are trademarks of Dolby Laboratories Licensing Corporation.

Dolby Pro Logic Surround + DSP

Dolby Surround sound system shows its full ability in a large movie theater, because movie sounds are originally designed to be reproduced in a large movie theater using many speakers. It is difficult to create a sound environment similar to that of a movie theater in your listening room, because the room size, materials of inside walls, the number of speakers, etc. of your listening room is much different from those of a movie theater.

Yamaha DSP technology made it possible to present you with nearly the same sound experience as that of a large movie theater in your listening room by compensating for lack of presence and dynamics in your listening room with its original digital sound fields combined with Dolby Surround sound field.

The combination of Dolby Pro Logic Surround and DSP is used on the sound field program "  PRO LOGIC ENHANCED".

CINEMA DSP

The YAMAHA "CINEMA DSP" logo indicates these programs are created by the combination of Dolby Pro Logic and YAMAHA DSP technology.

SPEAKER SETUP

SPEAKERS TO BE USED

This unit is designed to provide the best sound-field quality with a 5 speaker configuration. The most effective speakers to use with this unit are main speakers, rear speakers and a center speaker. You may omit the center speaker. (Refer to the “**4-Speaker Configuration**” shown below.)

The main speakers are used for the main source sound plus the effect sounds. They will probably be the speakers from your present stereo system. The rear speakers are used for the effect and surround sounds, and the center speaker is for the center sounds (dialog etc.) within programs encoded with Dolby Surround. The center speaker needs to be equal in power to the main speakers, although the rear speakers should not be equal. However, all the speakers should have high enough power handling to accept the maximum output of this unit.

SPEAKER CONFIGURATION

5-Speaker Configuration

This configuration is the most effective and recommended one. In this configuration, the center speaker is necessary as well as the rear speakers. If the program **DOLBY PRO LOGIC** or **DOLBY PRO LOGIC ENHANCED** is selected, conversations will be output from the center speaker and the ambience will be excellent.

- Set the center channel mode to the “**NORMAL**” or “**WIDE**” position. (For details, refer to page 18.)

4-Speaker Configuration

The center speaker is not used in this configuration. If the program **DOLBY PRO LOGIC** or **DOLBY PRO LOGIC ENHANCED** is selected, the center sound is output from the left and the right main speakers. However, the sound effect of other programs can be the same as that of the 5-speaker configuration.

- Be sure to set the center channel mode to the “**PHANTOM**” position. (For details, refer to page 18.)

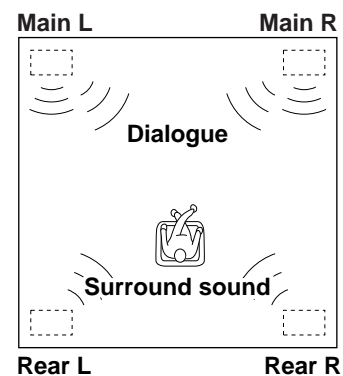
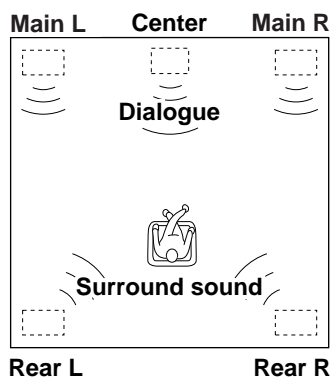

SPEAKER PLACEMENT

The recommended speaker configuration, the 5-speaker configuration, will require two speaker pairs: **main speakers** (your normal stereo speakers), and **rear speakers**, plus a **center speaker**. When you place these speakers, refer to the following.

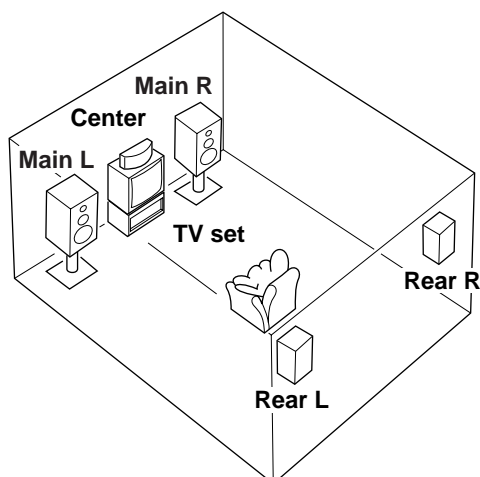

- Main:** In normal position. (The position of your present stereo speaker system.)
- Rear:** Behind your listening position, facing slightly inward. Nearly six feet (approx. 1.8 m) up from the floor.
- Center:** Precisely between the main speakers. (To avoid interference with TV sets, use a magnetically shielded speaker.)

CONNECTIONS

Never plug in this unit and other components until all connections are completed.

CONNECTIONS WITH OTHER COMPONENTS

When making connections between this unit and other components, be sure all connections are made correctly, that is to say L (left) to L, R (right) to R, “+” to “+” and “-” to “-”. Also, refer to the owner’s manual for each component to be connected to this unit.

* If you have YAMAHA components numbered as 1, 2, 3, etc. on the rear panel, connections can be made easily by making sure to connect the output (or input) terminals of each component to the same-numbered terminals of this unit.

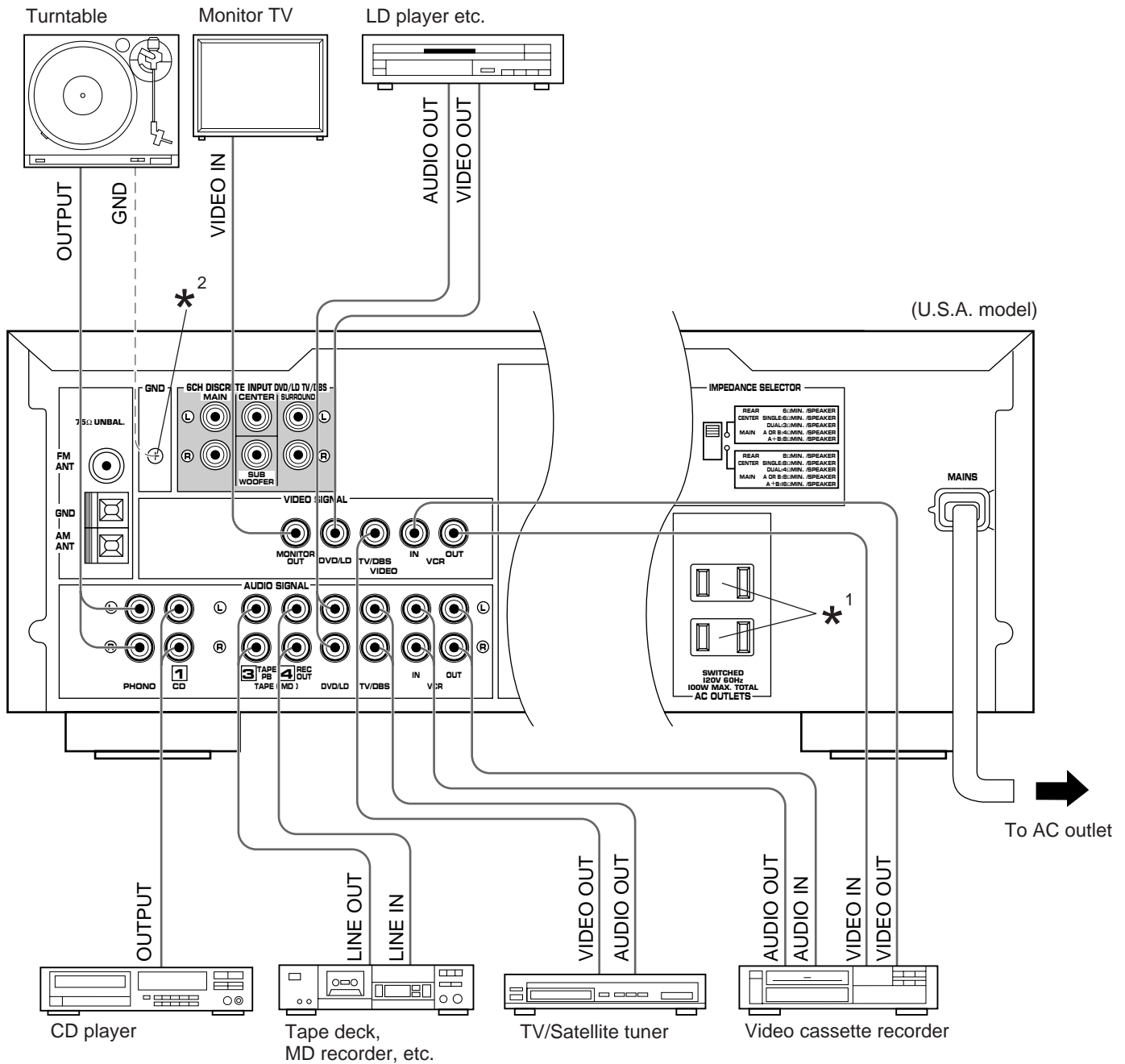

*¹, *² : See the next page.

*¹

AC OUTLET(S) (SWITCHED)

[U.S.A., Canada and General models]
..... 2 SWITCHED OUTLETS
[Australia model]..... 1 SWITCHED OUTLET

Use these to connect the power cords from your components to this unit.
The power to the **SWITCHED** outlets is controlled by this unit's **POWER** switch or the provided remote control transmitter's **POWER** key. These outlets will supply power to any component whenever this unit is turned on.
The maximum power (total power consumption of components) that can be connected to the **SWITCHED AC OUTLET(S)** is 100 watts.

*²

GND terminal (For turntable use)

Connecting the ground wire of the turntable to the **GND** terminal will normally minimize hum, but in some cases better results may be obtained with the ground wire disconnected.

CONNECTING TO VIDEO AUX TERMINALS (ON THE FRONT PANEL)

These terminals are used to connect any video input source such as a camcorder to this unit.

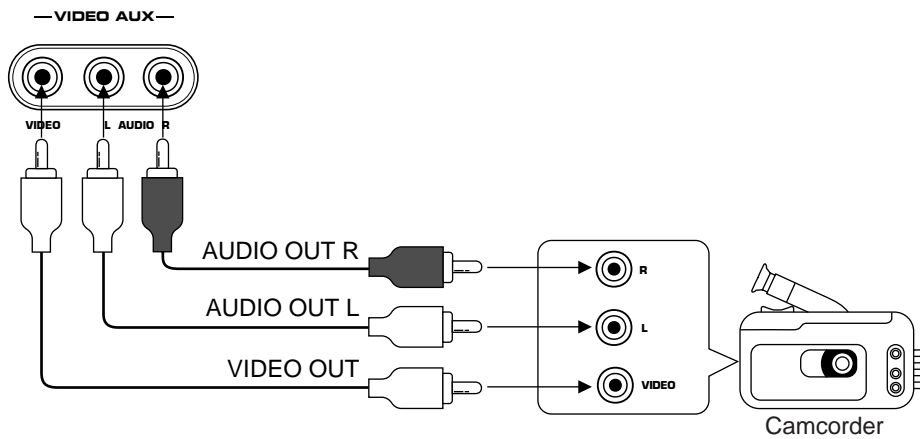

Connecting with a Dolby Digital (AC-3) Decoder

If you have a Dolby Digital (AC-3) Decoder unit or an LD player etc. which incorporates a Dolby Digital (AC-3) Decoder, its discrete outputs can be connected to this unit.

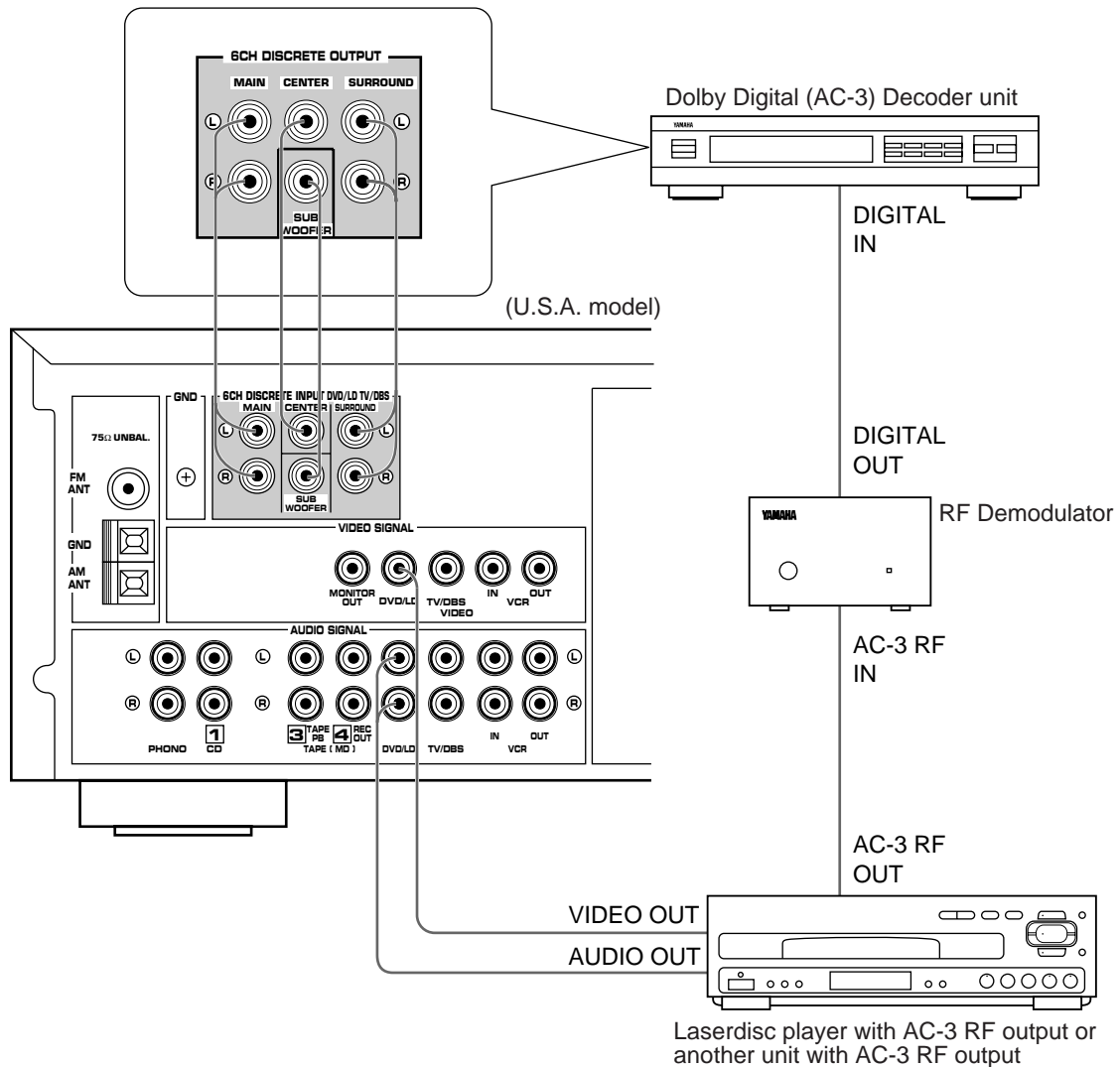

Notes

- The laserdisc player (or another unit) must be also connected to the DVD/LD (or TV/DBS) AUDIO SIGNAL input terminals of this unit for playing a source with the Dolby Pro Logic Surround decoded or in normal stereo (or monaural).
- The discrete signals input to this unit cannot be recorded by a tape deck, MD recorder or VCR. To record a source played on the laserdisc player (or another unit), it must be connected to the DVD/LD (or TV/DBS) AUDIO/VIDEO SIGNAL input terminals of this unit.
- If you made no connection to the SUBWOOFER input terminal of this unit or you will not use a subwoofer, you should make a setting for distributing signals at the LFE channel to the right and left MAIN output terminals on the Dolby Digital (AC-3) Decoder unit. For details, refer to the owner's manual for the Dolby Digital (AC-3) Decoder unit.

CONNECTING SPEAKERS

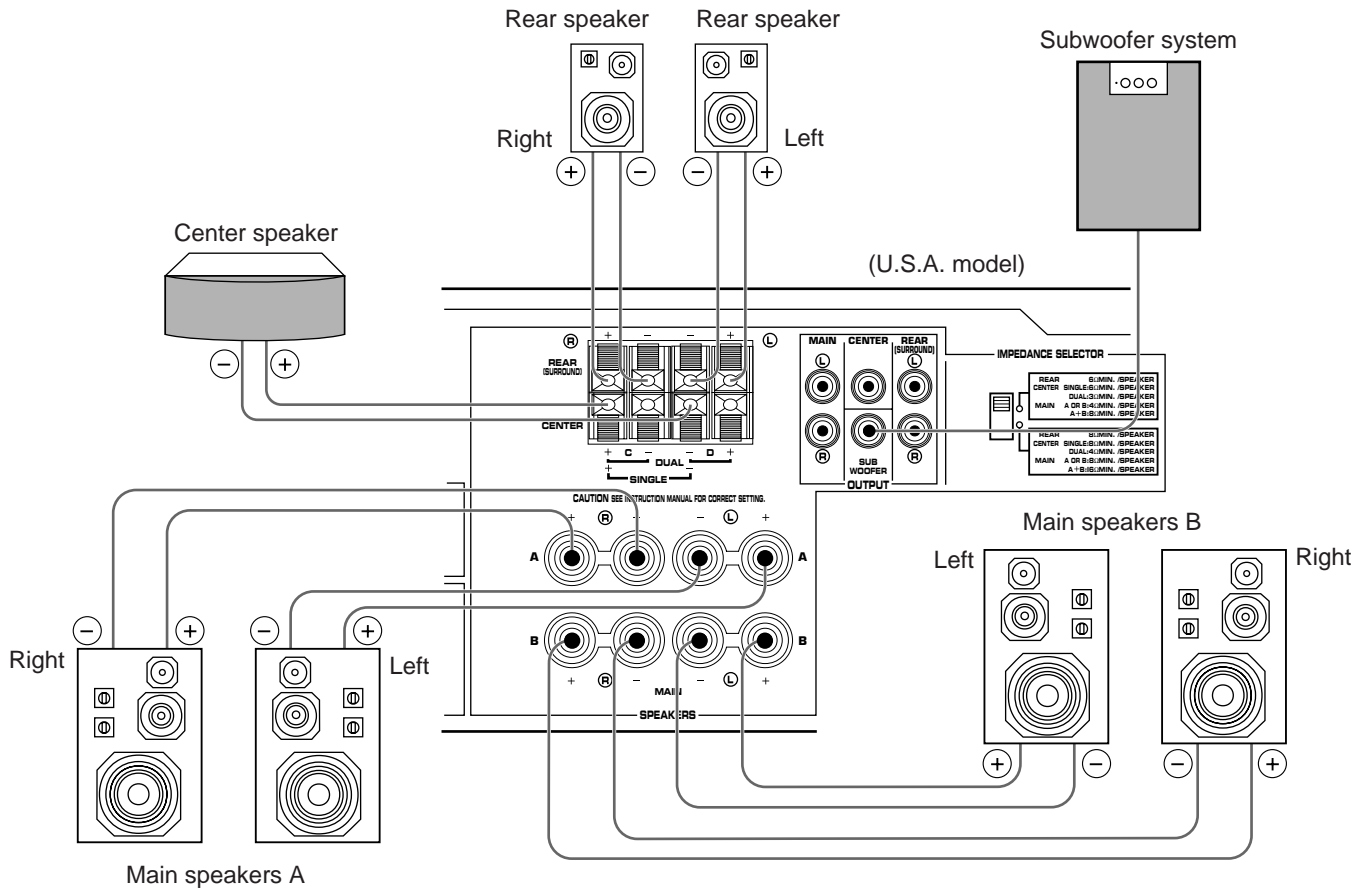

Note

Use speakers with the specified impedance shown on the rear of this unit.

Note on main speaker connections:

One or two speaker systems can be connected to this unit. If you use only one speaker system, connect it to either the **SPEAKERS A** or **B** terminals.

Note on a subwoofer connection:

You may wish to add a subwoofer to reinforce low frequencies or to output low bass sound from the subwoofer channel when reproducing discrete signals.

Connect the **SUBWOOFER OUTPUT** terminal of this unit to the INPUT terminal of the subwoofer amplifier, and connect the speaker terminals of the subwoofer amplifier to the subwoofer. With some subwoofers, including the Yamaha Active Servo Processing Subwoofer System, the amplifier and subwoofer are in the same unit.

Note on center speaker connection:

One or two center speakers can be connected to this unit. If you cannot place the center speaker on or under the TV, it is recommended to use two center speakers and place them on both sides of the TV to orient the center sound at the center position. For connecting two center speakers, follow the method shown below.

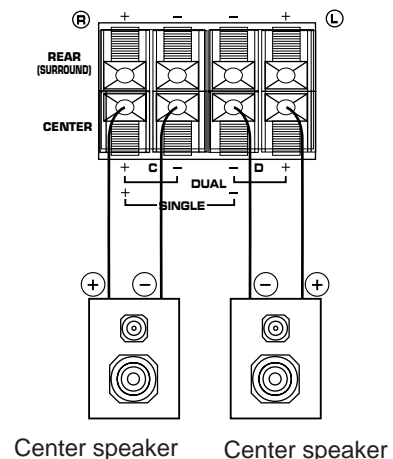

How to Connect:

Connect the **SPEAKERS** terminals to your speakers with wire of the proper gauge, cut as short as possible. If the connections are faulty, no sound will be heard from the speakers. Make sure that the polarity of the speaker wires is correct, that is the + and – markings are observed. If these wires are reversed, the sound will be unnatural and lack bass.

Caution

Do not let the bare speaker wires touch each other and do not let them touch any metal part of this unit. This could damage this unit and/or speakers.

For connecting to the MAIN SPEAKERS terminals

Red: positive (+)
Black: negative (-)

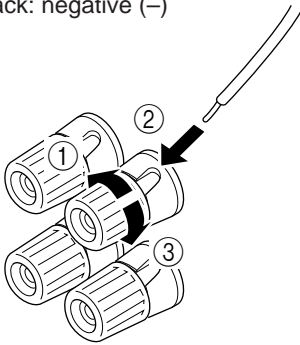

- ① Unscrew the knob.
- ② Insert the bare wire.
[Remove approx. 5mm (1/4") insulation from the speaker wires.]
- ③ Tighten the knob and secure the wire.

Banana Plug connections are also possible. Simply insert the Banana Plug connector into the corresponding terminal.

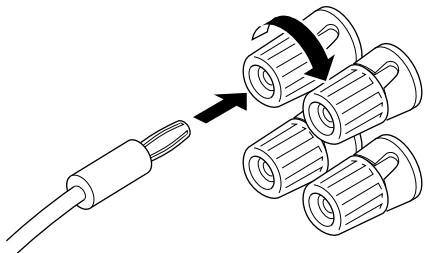

For connecting to the REAR and CENTER SPEAKERS terminals

Red: positive (+)
Black: negative (-)

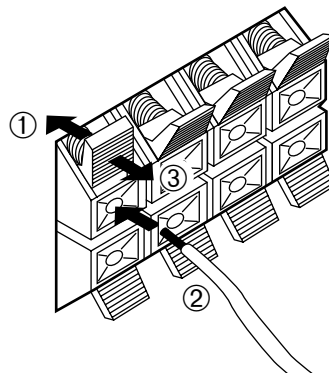

- ① Press the tab.
- ② Insert the bare wire.
[Remove approx. 5mm (1/4") insulation from the speaker wires.]
- ③ Release the tab and secure the wire.

OUTPUT terminals (for driving speakers with external amplifiers)

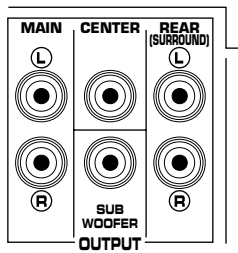

MAIN OUTPUT terminals

These terminals are for main channel line output. There is no connection to these terminals when you use the built-in amplifier.

However, if you drive main speakers with an external stereo power amplifier, connect the input terminals of the external amplifier (MAIN IN or AUX terminals of a power amplifier or an integrated amplifier) to these terminals.

* Output signals from the MAIN OUTPUT terminals only are affected by the use of **BASS**, **TREBLE**, **BALANCE** controls and **BASS EXTENSION** switch.

CENTER OUTPUT terminal

This terminal is for center channel line output. There is no connection to this terminal when you use the built-in amplifier. However, if you drive a center speaker with an external power amplifier, connect the input terminal of the external amplifier to this terminal.

REAR (SURROUND) OUTPUT terminals

These terminals are for rear channel line output. There is no connection to these terminals when you use the built-in amplifier.

However, if you drive rear speakers with an external stereo power amplifier, connect the input terminals of the external amplifier (MAIN IN or AUX terminals of a power amplifier or an integrated amplifier) to these terminals.

SUBWOOFER OUTPUT terminal

This terminal is for connecting with the input terminal of an amplifier for driving a subwoofer.

When the input signals to this unit are in normal 2-channel stereo, this terminal outputs only frequencies below 200 Hz from the main and center channels. When discrete signals are input to this unit and are selected as the input source, this terminal outputs signals from the subwoofer channel.

Note

Output level of signals from all of these terminals are adjusted by the use of **VOLUME** control on the front panel or **MASTER VOLUME** keys on the remote control transmitter.

IMPEDANCE SELECTOR switch

Be sure to switch this only when the power of this unit is turned off.

Select the position whose requirements your speaker system meets.

WARNING

Do not change the **IMPEDANCE SELECTOR** switch setting while the power to this unit is on, otherwise this unit may be damaged.

IF THIS UNIT FAILS TO TURN ON WHEN THE POWER SWITCH IS PRESSED

The **IMPEDANCE SELECTOR** switch may not be set to either end closely. If so, set the switch to either end closely.

 (Upper position)

Rear: The impedance of each speaker must be 6Ω or higher.

Center: If you use one center speaker, the impedance of the speaker must be 6Ω or higher.
If you use two center speakers, the impedance of each speaker must be 3Ω or higher.

Main: If you use one pair of main speakers, the impedance of each speaker must be 4Ω or higher.
If you use two pairs of main speakers, the impedance of each speaker must be 8Ω or higher.

 (Lower position)

Rear: The impedance of each speaker must be 8Ω or higher.

Center: If you use one center speaker, the impedance of the speaker must be 8Ω or higher.
If you use two center speakers, the impedance of each speaker must be 4Ω or higher.

Main: If you use one pair of main speakers, the impedance of each speaker must be 8Ω or higher.

<Except Canada model>

If you use two pairs of main speakers, the impedance of each speaker must be 16Ω or higher.

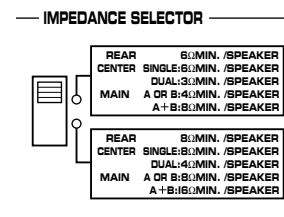

(U.S.A. model)

ANTENNA CONNECTIONS

- Each antenna should be connected to the designated terminals correctly, referring to the following diagram.
- Both AM and FM indoor antennas are included with this unit. In general, these antennas will probably provide sufficient signal strength. Nevertheless, a properly installed outdoor antenna will give clearer reception than an indoor one. If you experience poor reception quality, an outdoor antenna may result in improvement.

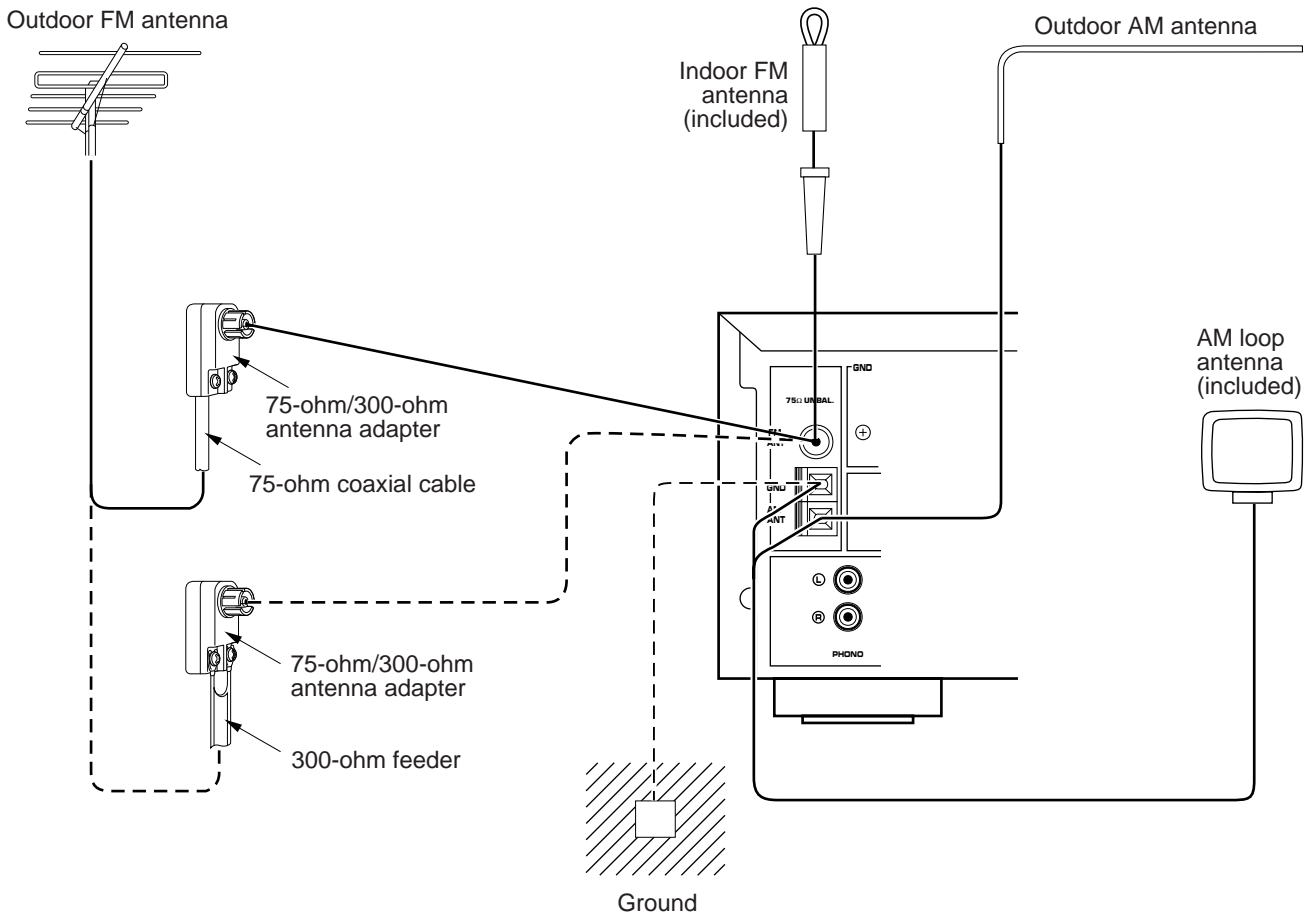

Connecting the AM loop antenna

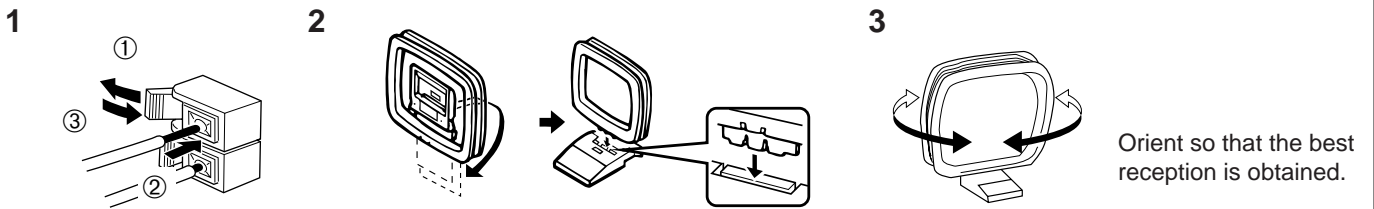

- * The AM loop antenna should be placed apart from the main unit. The antenna may be hung on a wall.
- * The AM loop antenna should be kept connected, even if an outdoor AM antenna is connected to this unit.

GND terminal

For maximum safety and minimum interference, connect the **GND** terminal to a good earth ground. A good earth ground is a metal stake driven into moist earth.

Notes

- When connecting the indoor FM antenna, insert its connector into the **FM ANT** terminal firmly.
- If you need an outdoor FM antenna to improve FM reception quality, either 300-ohm feeder or coaxial cable may be used. In locations troubled by electrical interference, coaxial cable is preferable.

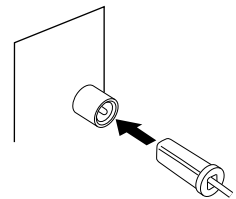

CONTROLS AND THEIR FUNCTIONS

FRONT PANEL

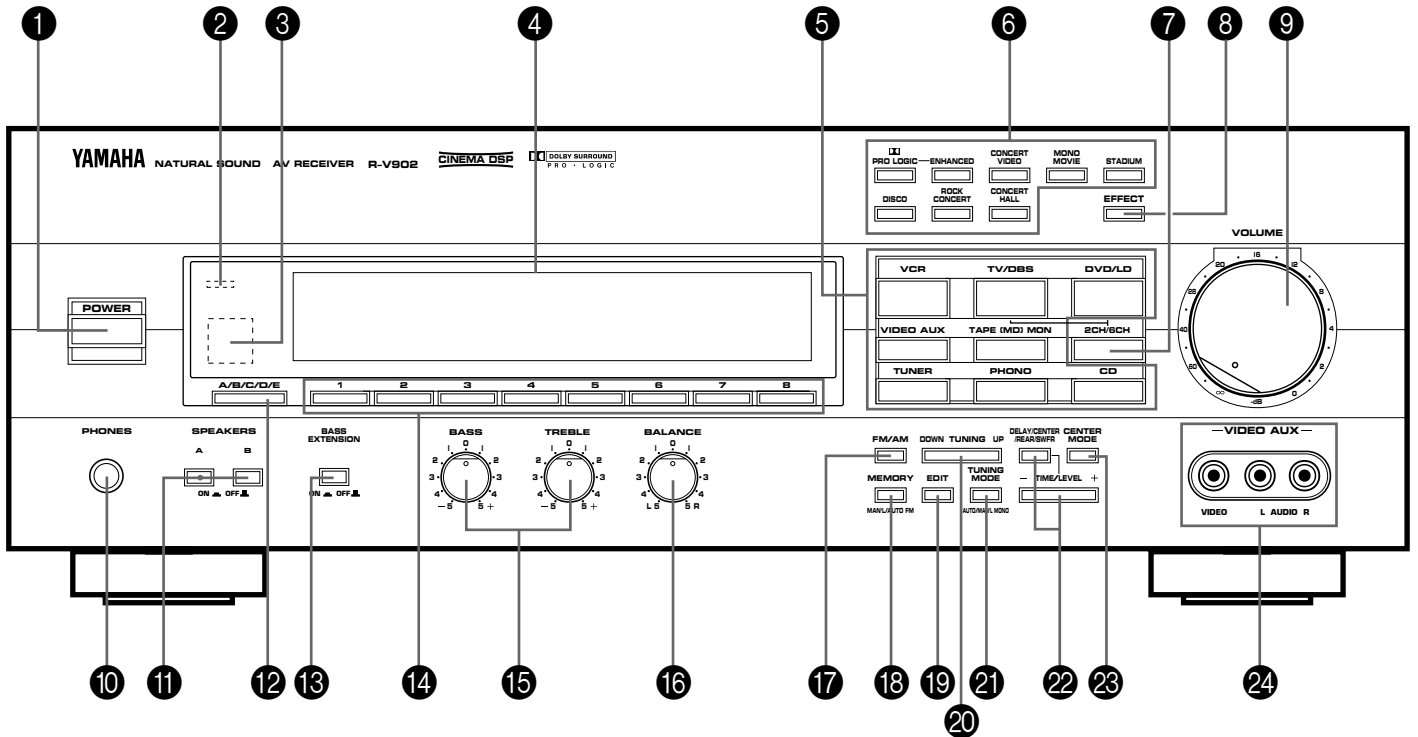

1 POWER switch

Press this switch to switch the power on. Press it again to switch the power off.

2 Standby mode indicator (Except U.S.A. and Canada models)

While the power is on, pressing the **SYSTEM POWER OFF** key on the remote control transmitter switches the unit to the standby mode. In this mode, this indicator is illuminated.

3 Remote control sensor

Receives signals from the remote control transmitter.

4 Display panel

Shows various information. (Refer to page 16 for details.)

5 Input selector buttons

Select a program source to listen to or watch. When a button is pressed, the name of selected source appears on the display.

6 DSP program selector buttons

Select a DSP program. When a button is pressed, the name of selected program lights up on the display.

7 2CH/6CH selector button

When the **TV/DBS** or **DVD/LD** input source is selected, pressing this button switches the input signals between 2 channel stereo signals and 6 channel discrete signals. When switched to "6CH", discrete signals from the unit connected to the 6CH DISCRETE INPUT DVD/LD TV/DBS terminals of this unit are selected as the input signals.

8 EFFECT button

Switches on/off the digital sound field processor (including the Dolby Pro Logic Surround decoder).

9 VOLUME control

Used to raise or lower the volume level.

10 PHONES jack

When you listen with headphones, connect the headphones to the **PHONES** jack. You can listen to the sound to be output from the main speakers through headphones.

When listening with headphones privately, set both the **SPEAKERS A** and **B** switches to the **OFF** position and switch off the digital sound field processor (so that no DSP program name is illuminated on the display) by pressing the **EFFECT** button.

PHONES

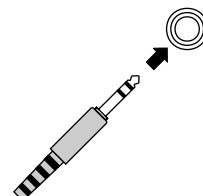

11 SPEAKERS switches

Set the switch **A** or **B** (or both **A** and **B**) for the main speaker system (connected to this unit) you will use to the **ON** position. Set the switch for the main speaker system you will not use to the **OFF** position.

12 A/B/C/D/E button

Press this button to select a desired group (A–E) of preset stations.

13 BASS EXTENSION switch

When this switch is pressed inward (ON), boosts bass frequency response at the main left and main right channels while maintaining overall tonal balance. If you do not have a subwoofer, the use of this switch will be effective to reinforce the bass frequencies.

14 Preset station number selector buttons

Select a preset station number (1 to 8).

15 Tone controls

These controls are effective only for the sound from the main speakers.

BASS

Used to increase or decrease the low frequency response.

The 0 position produces flat response.

TREBLE

Used to increase or decrease the high frequency response.

The 0 position produces flat response.

16 BALANCE control

Adjusts the balance of the output volume to the left and right speakers to compensate for sound imbalance caused by speaker location or listening room conditions.

17 FM/AM buttons

Press this button to switch the reception band to FM or AM.

18 MEMORY (MAN'L/AUTO FM) button

When this button is pressed, the MEMORY indicator flashes for about 5 seconds. During this period, select a desired preset station number by pressing the corresponding preset station number selector button to enter the displayed station into the memory.

When this button is pressed and held for about 3 seconds, the automatic preset tuning begins. (Refer to page 25 for details.)

19 EDIT button

This button is used to exchange the places of two preset stations with each other.

20 TUNING DOWN/UP button

Used for tuning. Press the "UP" side to tune in to higher frequencies, and press the "DOWN" side to tune in to lower frequencies.

21 TUNING MODE (AUTO/MAN'L MONO) button

Press this button to switch the tuning mode to automatic or manual. To select the automatic tuning mode, press this button so that "AUTO" lights up on the display. To select the manual tuning mode, press this button so that "AUTO" goes off.

22 DELAY/CENTER/REAR/SWFR and TIME/LEVEL +/- buttons

Adjust the delay time (DELAY), the rear channel output level (REAR), center channel output level (CENTER) and the output level to the SUBWOOFER OUTPUT terminal (SWFR).

Select the item which you want to adjust by pressing the **DELAY/CENTER/REAR/SWFR** button and adjust its time or level by pressing the **TIME/LEVEL +/-** button.

23 CENTER MODE button

Selects a center channel output mode (NORMAL, WIDE or PHANTOM). (For details, refer to page 18.)

24 VIDEO AUX terminals

Connect an auxiliary video or audio input source unit such as a camcorder to these terminals. The source connected to these terminals can be selected by the corresponding input selector button.

DISPLAY PANEL

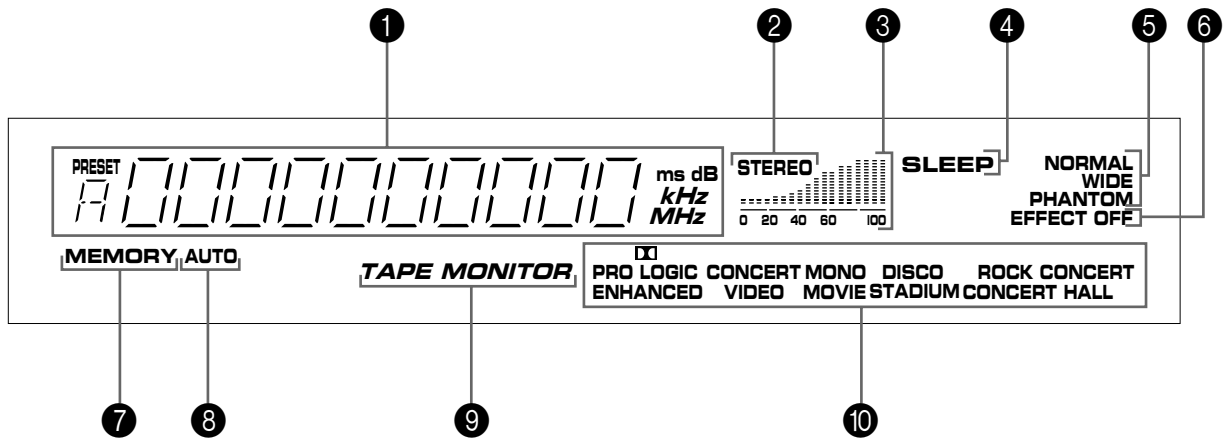

1 Multi-information display

Displays various information, for example station frequency, preset station number and name of selected input source.

2 STEREO indicator

Lights up when an FM stereo broadcast with sufficient signal strength is received.

3 Signal-level meter

Indicates the signal level of the received station. If multipath interference is detected, the indication decreases.

4 SLEEP indicator

Lights up while the built-in SLEEP timer is functioning.

5 Center channel mode indicators

The name of a selected center channel mode lights up only when a program which uses the Dolby Pro Logic Surround decoder is selected.

6 EFFECT OFF indicator

Lights up if neither the digital sound field processor nor the Dolby Pro Logic Surround decoder is on. In this state, sound output is 2-channel stereo.

7 MEMORY indicator

When the **MEMORY** button is pressed, this indicator flashes for about 5 seconds. During this period, the displayed station can be programmed to the memory by using the **A/B/C/D/E** button and the preset station number selector buttons.

8 AUTO indicator

Lights up when this unit is in the automatic tuning mode.

9 TAPE MONITOR indicator

Lights up when the tape deck (or MD recorder etc.) is selected as the input source by pressing the **TAPE (MD) MON** button.

10 DSP program indicators

The name of a selected DSP program lights up when the built-in digital sound field processor and/or the Dolby Pro Logic Surround decoder is on.

SPEAKER BALANCE ADJUSTMENT

This procedure lets you adjust the sound output level balance between the main, center, and rear speakers using the built-in test tone generator. When this adjustment is performed, the sound output level heard at the listening position will be the same from each speaker. This is important for the best performance of the digital sound field processor and the Dolby Pro Logic Surround decoder.

The adjustment of each speaker output level should be done at your listening position with the remote control transmitter. Otherwise, the result may not be satisfactory.

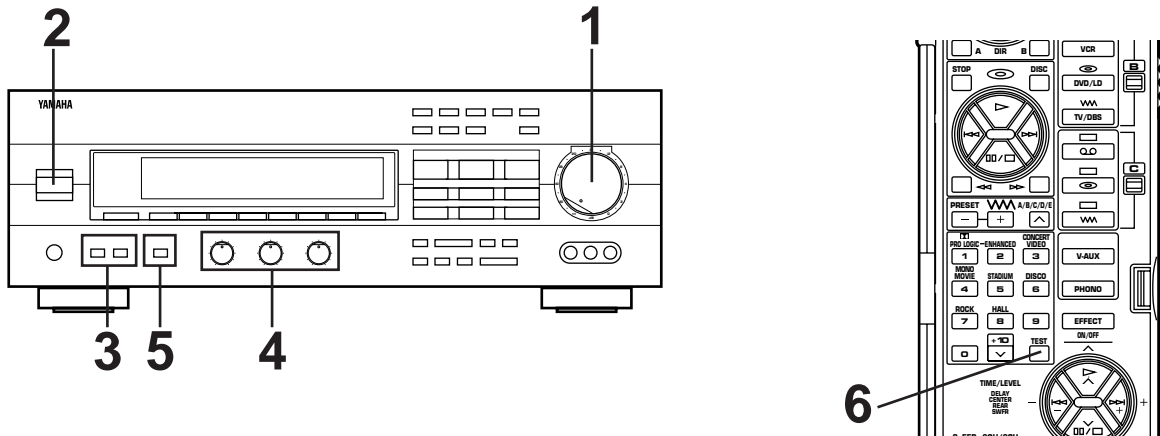

1

Set to the "∞" position.

2 Turn the power on.

3 Select the main speakers to be used.

* If you use two main speaker systems, press both the A and B switches.

4

Set to the "0" position.

5

Set to the "OFF (OFF)" position.

6

CONTINUED

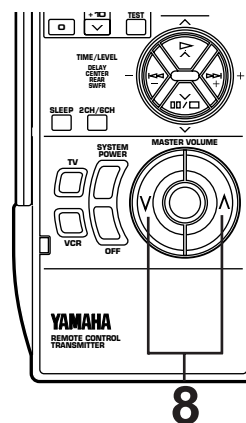
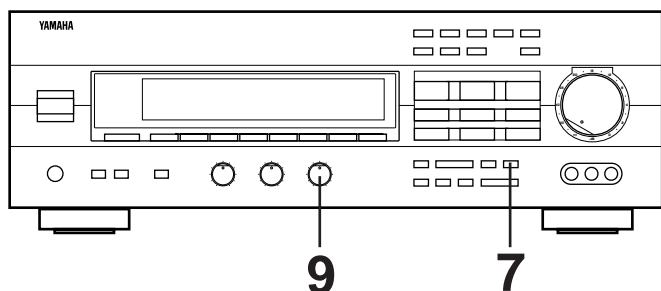

7 Select the center channel output mode suitable for your speaker configuration. (Refer to **"SPEAKER CONFIGURATION"** on page 6.)

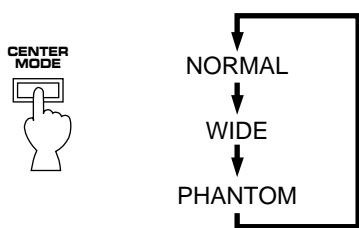

On the feature of each mode, refer to the **"Note"** shown below.

Note

In step 7, when you select a center channel output mode, note the following.

For 5 speaker configuration)

NORMAL: Select this mode when you use a center speaker that is smaller than the main speakers. In this mode, the bass tone will be output from the main speakers.

WIDE: Select this mode when you use the center speaker approximately same sized as the main speakers.

For 4 speaker configuration)

PHANTOM: Select this mode when you do not use the center speaker. The center sound will be output from the left and right main speakers.

8 Turn up the volume.

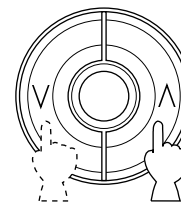

You will hear a test tone (like pink noise) from the left main speaker, then the center speaker, then the right main speaker, and then the rear speakers, for about two seconds each. The display changes as shown below.

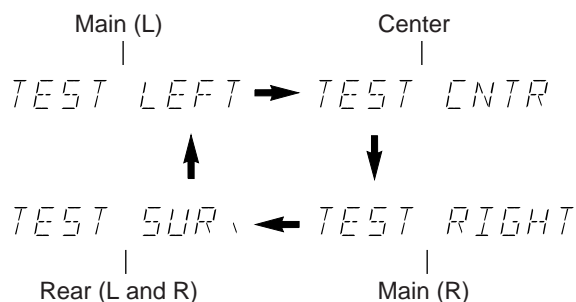

* The test tone from the left rear speaker and the right rear speaker will be heard at the same time.

9 Adjust the **BALANCE** control so that the effect sound output level of the left main speaker and the right main speaker are the same.



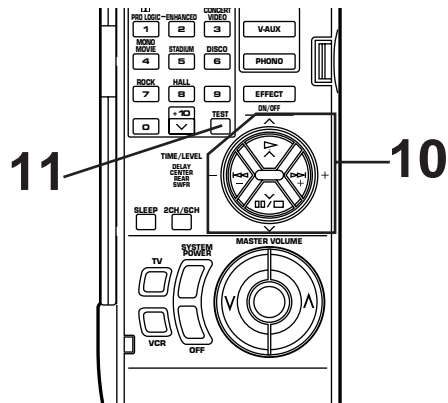

10 Adjust the sound output levels of the center speaker and the rear speakers so that they become almost as same as that of the main speakers.

- a) Press once or more so that "CENTER" or "REAR" appears on the display.
 * Select "CENTER" to adjust the output level of the center speaker, and select "REAR" to adjust the output level of the rear speakers.

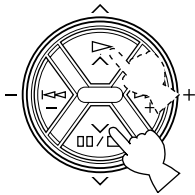

- b) Adjust its level.
 * Pressing the + side raises and the - side lowers the level.

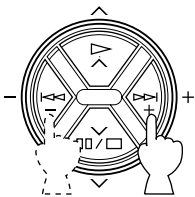

11 Cancel the test tone.



TEST LEFT
 |
 Disappears.

Notes

- Once you have completed these adjustments, you can adjust whole sound level on your audio system by using the **VOLUME** control (or the **MASTER VOLUME** keys on the remote control transmitter) only.
- If you use external power amplifiers, you may also use their volume controls to achieve proper balance.
- In step 10, if the center channel mode is in the "PHANTOM" position, the sound output level of the center speaker cannot be adjusted. This is because in this mode, the center sound is automatically output from the left and right main speakers.

BASIC OPERATIONS

TO PLAY A SOURCE

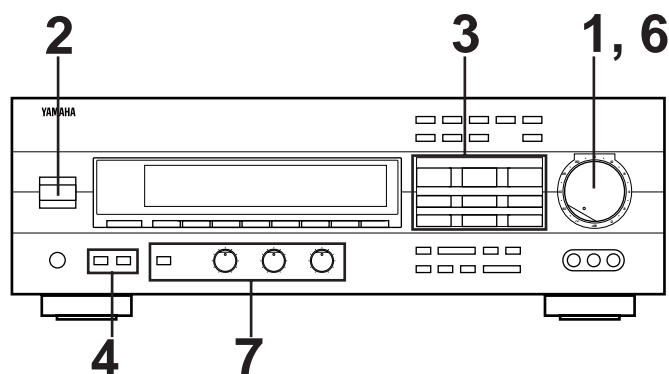

1

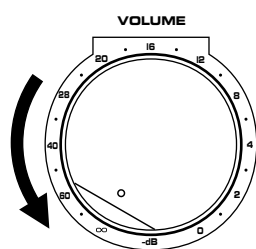

Set to the "∞" position.

2 Turn the power on.

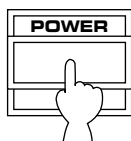

3 Select the desired input source by using the input selector buttons.
(For video sources, turn the TV/monitor ON.)

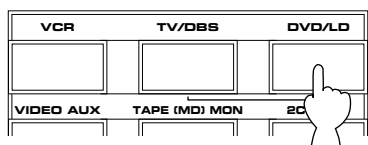

* The name of the selected input source will appear on the display.

4 Select the main speakers to be used.

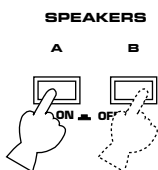

* If you use two main speaker systems, press both the A and B switches.

5 Play the source. (For detailed information on the tuning operation, refer to page 23.)

6

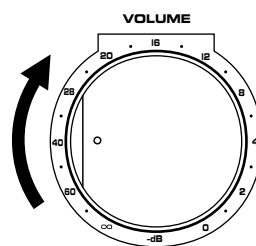

Adjust to the desired output level.

7 If desired, adjust the **BASS, TREBLE, BALANCE** controls, etc. (refer to page 22.) and use the digital sound field processor. (Refer to page 28.)

Notes on using the input selector buttons

- Note that pressing on each input selector button selects the source which is connected to the corresponding input terminals on the rear panel.
 - * To select the source connected to the **VIDEO AUX** terminals on the front panel, press **VIDEO AUX**.
- The selection of **TAPE (MD) MON** cannot be canceled by pressing another input selector button. To cancel it, press **TAPE (MD) MON** again so that "TAPE MONITOR" disappears from the display. When you select a button other than **TAPE (MD) MON**, make sure that "TAPE MONITOR" is not illuminated on the display.
- If you select the input selector button for a video source without canceling the selection of **TAPE (MD) MON**, the playback result will be the video image from the video source and the sound from the audio tape (or MD etc.).
- Once you play a video source, its video image will not be interrupted even if the input selector button for an audio source is selected.

To turn off the power

Press the **POWER** switch again.

To listen to a decoded source using Dolby Digital (AC-3) by reproducing the signals input to the 6CH DISCRETE INPUT DVD/LD TV/DBS terminals of this unit.

In step 3, select **TV/DBS** or **DVD/LD**, and then press the **2CH/6CH** button so that "6ch" appears on the display. Discrete signals from the unit connected to the 6CH DISCRETE INPUT DVD/LD TV/DBS terminals of this unit are selected as the input signals.

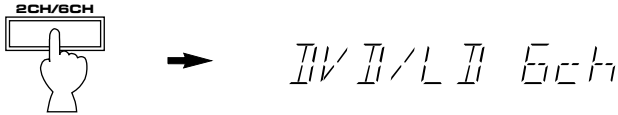

To cancel it, press the **2CH/6CH** button again or select another input source.

Note for reproducing discrete signals with Dolby Digital (AC-3) decoded:

1. Your speaker system must include a center speaker.
2. Your speaker system must include a subwoofer.
 - * Connect a subwoofer which has a built-in amplifier to the **SUBWOOFER OUTPUT** terminal of this unit.
 - * You can do without using a subwoofer. If you do so, you should make a setting for distributing signals at the LFE channel to the right and left MAIN output terminals on the Dolby Digital (AC-3) Decoder unit. For details, refer to the owner's manual for the Dolby Digital (AC-3) Decoder unit.

Notes

- When you switch to the "6CH" mode, the built-in Digital Sound Field processor will not work and adjustment of delay time cannot be made.
- Switching this unit to the "6CH" mode will input no signal to this unit if there is no connection to the 6CH DISCRETE INPUT DVD/LD TV/DBS terminals of this unit.

TO RECORD A SOURCE TO TAPE (OR MD)

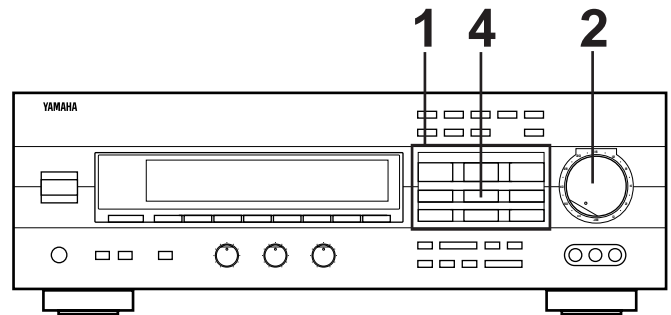

- 1** Select the source to be recorded.

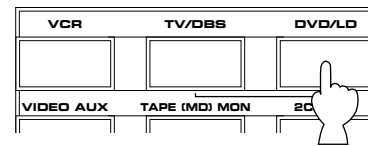

- 2** Play the source and then turn the **VOLUME** control up to confirm the input source. (For detailed information on the tuning operations, refer to the page 23.)

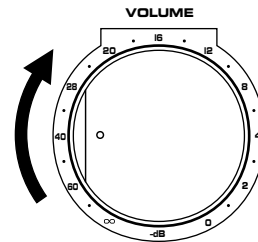

- 3** Begin recording on the tape deck (or MD recorder etc.) or VCR connected to this unit.

- 4** If the tape deck (or MD recorder etc.) is used for recording, you can monitor the sounds being recorded by pressing **TAPE (MD) MON** so that "TAPE MONITOR" lights up on the display.

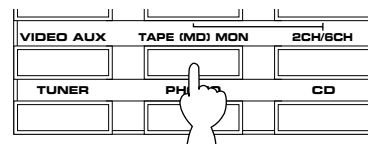

Notes

- The settings of DSP and the **VOLUME, BASS, TREBLE, BALANCE** controls and the **BASS EXTENSION** switch have no effect on the material being recorded.
- In step 1, do not make an input source selection so that "6ch" appears on the display. Signals input to this unit's 6CH DISCRETE INPUT DVD/LD TV/DBS terminals cannot be recorded by a tape deck, MD recorder or VCR.

Selecting the SPEAKER system

Because one or two speaker systems (as main speakers) can be connected to this unit, the **SPEAKERS** switches allow you to select speaker system **A** or **B**, or both at once.

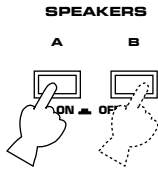

Adjusting the BALANCE control

Adjust the balance of the output volume to the left and right speakers to compensate for sound imbalance caused by speaker location or listening room conditions.



Note

This control is effective only for the sound from the main speakers.

Adjusting the BASS and TREBLE controls

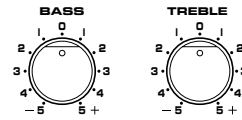

BASS : Turn this clockwise to increase (or counter-clockwise to decrease) the low frequency response.

TREBLE : Turn this clockwise to increase (or counter-clockwise to decrease) the high frequency response.

Note

These controls are effective only for the sound from the main speakers.

Using the BASS EXTENSION switch

You can boost bass frequency response by setting this switch to the "ON" position. This switch is effective only on the sound from the main speakers.

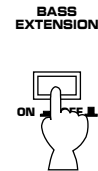

TUNING OPERATIONS

Normally, if station signals are strong and there is no interference, quick automatic-search tuning (AUTOMATIC TUNING) is possible. However, if signals of the station you want to select are weak, you must tune to it manually (MANUAL TUNING).

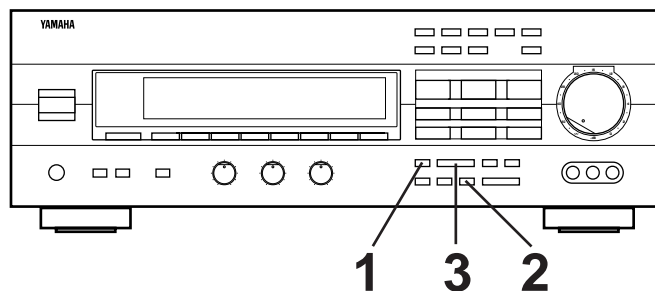

AUTOMATIC TUNING

- 1 Select the reception band (FM or AM) confirming it on the display.

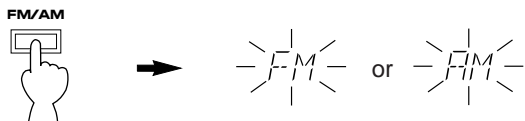

- 2

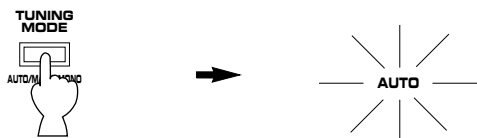

- 3

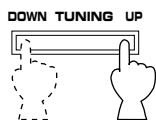

To tune to a higher frequency, press the right side once.
To tune to a lower frequency, press the left side once.

- * If the station where tuning search stops is not the desired one, press again.
- * If the tuning search does not stop at the desired station (because the signals of the station are weak), change to the MANUAL TUNING method.

MANUAL TUNING

- 1 Select the reception band (FM or AM) confirming it on the display.

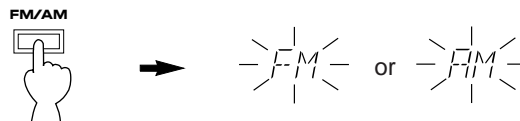

- 2



Turn "AUTO" off.

- 3 Tune to a desired station manually.

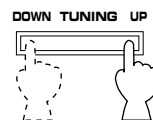

* To continue tuning search, press and hold the button.

Note

If you tune to an FM station manually, it is received in monaural mode automatically to increase the signal quality.

PRESET TUNING

MANUAL PRESET TUNING

This unit can store station frequencies selected by tuning operation. With this function, you can recall any desired station by only selecting the preset station number where it is stored. Up to 40 stations (8 stations x 5 groups) can be stored.

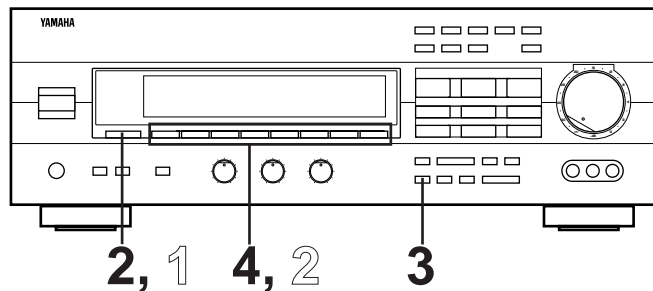

To store stations

- 1** Tune to a desired station.
(Refer to the previous page for tuning procedure.)
- 2** Select a desired group (A – E) of preset stations confirming it on the display.
- 3**

Flashes on and off for about 5 seconds.
- 4** Select a preset station number where you want to program the station before “MEMORY” goes off from the display.

Shows the displayed station has been programmed to A1.

* In the same way, program other stations to A2, A3 ... A8.
* You can program more stations to preset station numbers on other groups in the same way by selecting other groups in step 2.

To recall a preset station

- 1** Select the group of preset stations.
- 2** Select the preset station number.

Notes

- A new setting can be programmed in place of the former one.
- For presets, the setting of the reception mode (stereo or monaural) is stored along with the station frequency.

Memory back-up

The memory back-up circuit prevents the programmed data from being lost even if the **POWER** switch is set off or the power plug is disconnected from the AC outlet or the power is cut due to temporary power failure. If, however, the power is cut for more than one week, the memory may be erased. If so, it can be re-programmed by simply following the PRESET TUNING steps.

AUTOMATIC PRESET TUNING

You can also make use of an automatic preset tuning function for FM stations only. By this function, this unit performs automatic tuning and stores FM stations with strong signals sequentially. Up to 40 stations are stored automatically in the same way as in the manual preset tuning method on page 24.

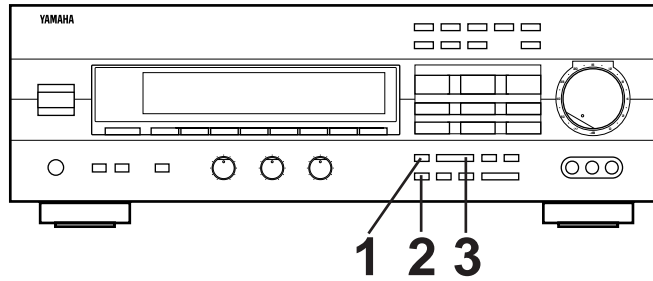

To store stations

1		→	
2		→	
<p>Press and hold for about 3 seconds.</p> <p style="text-align: center;">Flashes.</p>			
3			
<p>To tune to higher frequencies, press right side once. To tune to lower frequencies, press left side once. * If the TUNING button is not pressed, in a while, the automatic preset tuning begins automatically toward higher frequencies.</p> <p>The automatic preset tuning begins from the frequency currently displayed. Received stations are programmed to A1, A2 ... A8 sequentially. * If more than 8 stations are received, they are also programmed to the preset station numbers on other groups (B, C, D and E) in that order.</p>			

When the automatic preset tuning is finished

The display shows the frequency of the last preset station. Check the contents and the number of preset stations by following the procedure of the section "To recall a preset station" on page 24.

To recall a preset station

Simply follow the procedure of the section "To recall a preset station" on page 24.

Notes

- You can replace a preset station by another FM or AM station manually by simply following the procedure of the section "To store stations" on page 24.
- If the number of received stations is not enough to be stored up to E8, the search is finished automatically after searching all frequencies.
- With this function, only FM stations with sufficient signal strength are stored automatically. If the station you want to program is weak in signal strength, tune to it in monaural manually and program it by following the procedure of the section "To store stations" on page 24.

If you want to store the first station received by the automatic preset tuning to a desired preset station number.

If, for example, you want to store the first received station to C5, select "C5" by using the **A/B/C/D/E** button and the preset station number selector buttons after pressing the **MEMORY** button in step 2. Then press the **TUNING** button. The first received station is stored to C5, and next stations to C6, C7 ... sequentially.

If stations are stored up to E8, the automatic preset tuning is finished automatically.

EXCHANGING PRESET STATIONS

You can exchange the places of two preset stations with each other as shown below.

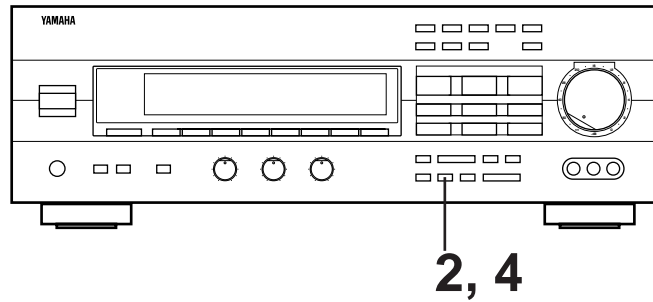

Example)

If you want to shift the preset station on E1 to A5, and vice versa.

<p>1 Recall the preset station on E1 (by following the method of "To recall a preset station" on page 24).</p>	<p>4</p> <p>Shows the exchange of stations is completed.</p>
<p>2</p> <p>Flashes.</p>	
<p>3 Next, recall the preset station on A5 by following the same method with step 1.</p> <p>Flashes.</p>	

USING DIGITAL SOUND FIELD PROCESSOR (DSP)

This unit incorporates a sophisticated, multi-program digital sound field processor. The processor allows you to electronically expand and change the shape of the audio sound field from both audio and video sources, creating a theater-like experience in your listening room. You can create an excellent audio sound field by selecting a suitable sound field program (this will, of course, depend on what you will be listening to), and adding desired adjustments.

In addition, this unit incorporates a Dolby Pro Logic Surround decoder for multi-channel sound reproduction of sources encoded with Dolby Surround. The operation of the Dolby Pro Logic Surround decoder can be controlled by selecting a corresponding DSP program including a combined operation of the Yamaha DSP and the Dolby Pro Logic Surround.

Brief Overview of Digital Sound Field Programs

The following list gives you a brief description of the sound fields produced by each of the DSP programs. Keep in mind that most of these are precise digital recreations of actual acoustic environments. The data for these sound fields was recorded at actual locations using sophisticated sound field measurement equipment.

Note
The channel level balance between the left and right rear effect speakers may vary depending on the sound field you are listening to. This is due to the fact that most of these sound field recreations are actual acoustic environments.

PROGRAM	FEATURE
<input checked="" type="checkbox"/> PRO LOGIC	This program is used for playback of sources encoded with Dolby Surround. The application of a sophisticated digital signal processing system reduces crosstalk and directs or steers the sound source more smoothly and precisely, as compared to conventional types.
<input checked="" type="checkbox"/> PRO LOGIC ENHANCED	This program is also used for playback of sources encoded with Dolby Surround. Enhancing the "Normal" Dolby Pro Logic, the DSP technology simulates the multi-surround speaker systems of a 35 mm movie theater. This effect creates a wide surround sound field, and expands the sound stage with an improved presence image. This program is used for musical based movies, as well as drama and comedy based movies.
CONCERT VIDEO	This program is effective for music videos and gives excellent depth and clarity for vocals. For opera, the orchestra and stage are ideally recreated, letting you feel as if you were in an actual concert hall.
MONO MOVIE	This program is designed specifically to enhance mono source programs. Compared to a strictly mono setting, the sound image created in this mode is wider and slightly forward of the speaker pair, lending an immediacy to the overall sound. It is particularly effective when used with old mono movies, news broadcasts and dialog.
STADIUM	This program gives you long delays between direct sounds and effect sounds, and extraordinarily spacious feel of a large stadium.
DISCO	This program recreates the acoustic environment of a lively disco in the heart of a very lively city. The sound is dense and highly concentrated. It is also characterized by a high-energy, "immediate" sound.
ROCK CONCERT	This program is ideally suited for rock music. You will experience a very dynamic or lively sound field.
CONCERT HALL	In this program, the center will appear to be deep behind the main speakers, creating an expansive large hall ambience. Orchestra and opera music are suited for this sound field.

To play a source with the digital sound field processor

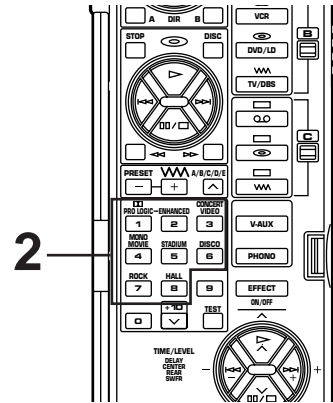
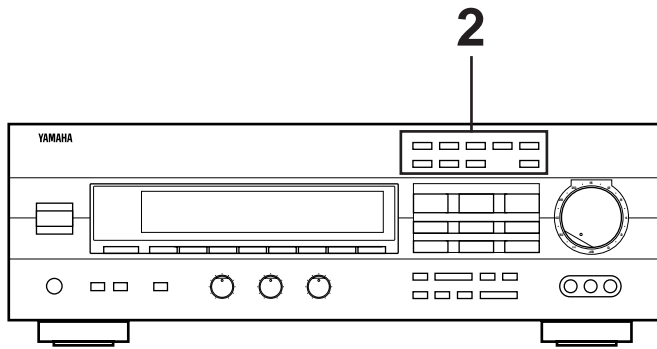

1 Follow steps 1 – 6 shown in “**BASIC OPERATIONS**” on page 20.

2 Select the desired program that is suitable for the source.

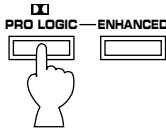

The selected program name is shown on the display.

3 If desired, adjust the delay time and the output level of each speaker. (For details, refer to the corresponding descriptions on page 29 and 30.)

Notes

- Program selection can be made to individual input sources. Once you select a program, it is linked with the input source selected at that time. So, when you select the input source next time, the same program is automatically called.
- If you prefer to cancel the DSP, press the **EFFECT** button. The sound will be the normal 2-channel stereo without surround sound effect.
- When **CONCERT VIDEO**, **MONO MOVIE**, **DISCO**, **STADIUM**, **ROCK CONCERT** or **CONCERT HALL** is selected, no sound is heard from the center speaker.
- When a monaural sound source is played with **DOLBY PRO LOGIC** or **DOLBY PRO LOGIC ENHANCED**, no sound is heard from the main speakers and the rear speakers. Sound is heard only from the center speaker. However, if the center channel mode is in **PHANTOM**, the main speakers output the sound of the center channel.
- When this unit's Dolby Pro Logic Surround decoder is used, if the main-source sound is considerably altered by overadjustment of the **BASS** or **TREBLE** control, the relationship between the center and rear channels may produce an unnatural effect.

Adjustment of the CENTER LEVEL

If desired, you can adjust the sound output level of the center speaker even if the output level is already set in “**SPEAKER BALANCE ADJUSTMENT**” on page 19.

- 1 Press once or more so that “CENTER” appears on the display.

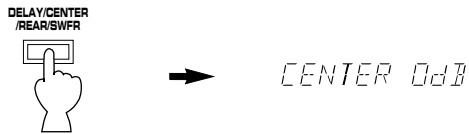

- 2 By continuously pressing the “+” or “-” side of the **TIME/LEVEL** button, the level value changes continuously. The value stops changing momentarily at the preset point (0 dB).

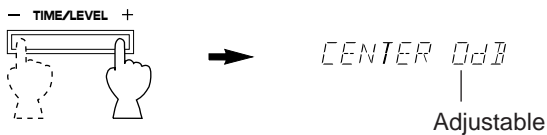

Control range: MIN, -20 to +10 dB

Notes

- This adjustment can be made only when the digital sound field program **DOLBY PRO LOGIC** or **DOLBY PRO LOGIC ENHANCED** is selected, or the “6CH” input source mode is selected.
- Once the output level is adjusted, the level value will be the same in all the digital sound field programs mentioned above.

Adjustment of the REAR LEVEL

If desired, you can adjust the sound output level of the rear speakers even if the output level is already set in “**SPEAKER BALANCE ADJUSTMENT**” on page 19.

- 1 Press once or more so that “REAR” appears on the display.

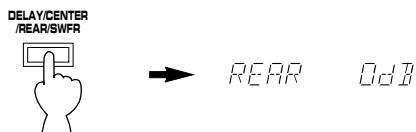

- 2 By continuously pressing the “+” or “-” side of the **TIME/LEVEL** button, the level value changes continuously. The value stops changing momentarily at the preset point (0 dB).

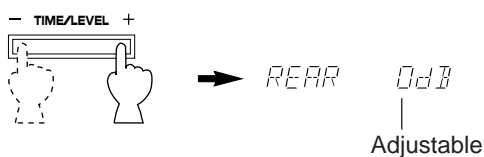

Control range: MIN, -20 to +10 dB

Notes

- This adjustment can be made only when the built-in digital sound field processor is on, or the “6CH” input source mode is selected.
- Once the output level is adjusted, the level value will be the same in all the digital sound field programs.

Adjustment of DELAY TIME

You can adjust the time difference between the beginning of the sound from the main speakers and the beginning of the effect sound from the rear speakers.
The larger the value, the later the effect sound is generated.
This adjustment can be made to all programs individually.

PRO LOGIC	: from 15 to 30 milliseconds (Preset value: 20 milliseconds)
PRO LOGIC ENHANCED	: from 15 to 30 milliseconds (Preset value: 20 milliseconds)
CONCERT VIDEO	: from 1 to 100 milliseconds (Preset value: 28 milliseconds)
MONO MOVIE	: from 1 to 100 milliseconds (Preset value: 20 milliseconds)
STADIUM	: from 1 to 50 milliseconds (Preset value: 45 milliseconds)
DISCO	: from 1 to 100 milliseconds (Preset value: 14 milliseconds)
ROCK CONCERT	: from 1 to 100 milliseconds (Preset value: 17 milliseconds)
CONCERT HALL	: from 1 to 100 milliseconds (Preset value: 30 milliseconds)

- 1 Press once or more so that "DELAY" appears on the display.



- 2 By continuously pressing the "+" or "-" side of the **TIME/LEVEL** button, the value changes continuously. The value stops changing momentarily at the preset point.

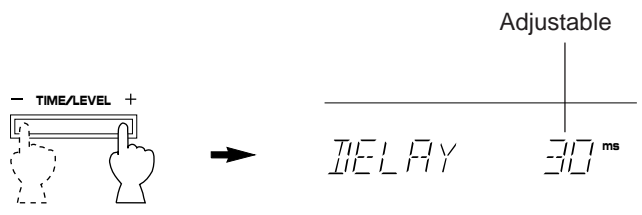

Notes

- Adding too much delay will cause an unnatural effect with some sources.
- When the **TIME/LEVEL** button is pressed, sound is momentarily interrupted.

Note

The values of the delay time, center level and rear level you set the last time will remain memorized even when the power of this unit is off.

However, if the power cord is kept disconnected for more than one week, these values will be automatically changed back to the original factory settings.

SETTING THE SLEEP TIMER

If you use the SLEEP timer of this unit, you can make this unit turn off automatically. When you are going to sleep while enjoying a broadcast or other desired input source, this timer function is helpful.

Notes

- The SLEEP timer can be controlled only with the remote control transmitter.
- The components on which the SLEEP timer is effective are the sources connected to the **SWITCHED AC OUTLET(S)** on the rear panel of this unit.

To set the SLEEP time

1

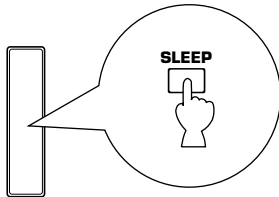

Press once or more to select the desired SLEEP time.



Indicates the SLEEP time.

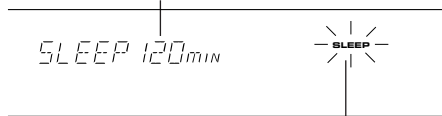

Lights up.

Whenever the **SLEEP** key is pressed, the SLEEP time will change as follows.

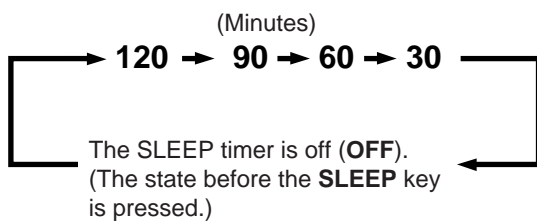

After a while, the display returns to the indication before the SLEEP timer is set.

2

The unit will be turned off automatically at the selected SLEEP time.

To cancel the selected SLEEP time

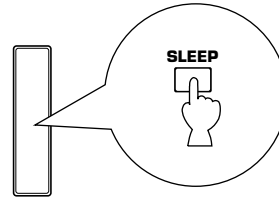

Press once or more so that "SLEEP OFF" appears on the display. (It will soon disappear and the "SLEEP" indicator will go off from the display.)

Note

The SLEEP timer setting can also be canceled by turning off the power with the **POWER** switch or disconnecting the power plug of this unit from the AC outlet.

REMOTE CONTROL TRANSMITTER

BASIC OPERATIONS (When the lid is open)

The remote control transmitter provided with this unit is designed to control all the most commonly used functions of this unit. If the CD player, tape deck, LD player etc. connected to this unit are YAMAHA components designed for remote control compatibility, then this remote control transmitter will also control various functions of each component.

* For basic operations, use the remote control transmitter with the lid open.

NAMES OF KEYS AND THEIR FUNCTIONS

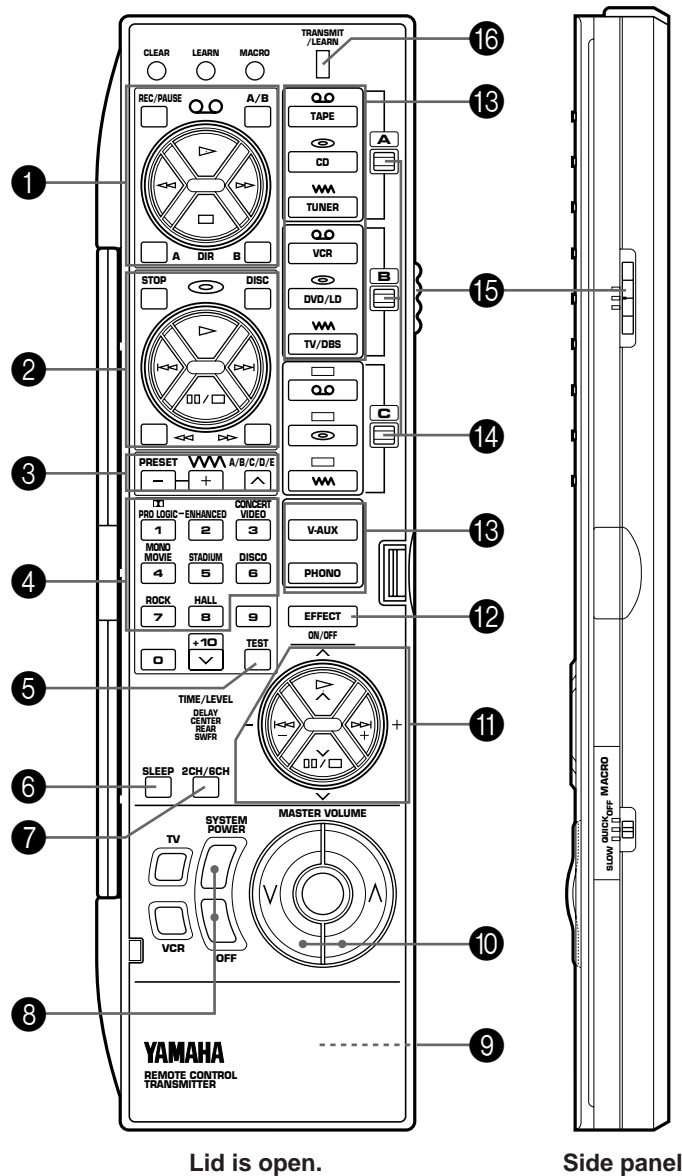

1 Tape deck keys

Controls tape deck.

(The A/B/C switch (15) should be set to the "A" position.)

- * **DIR A, B** and **A/B** are applicable only to double cassette tape deck.
- * For a single cassette deck with automatic reverse function, pressing **DIR A** will reverse the direction of tape running.

2 CD/LD player keys

Controls compact disc player or LD player.

(To control compact disc player, set the A/B/C switch (15) to the "A" position. To control LD player, set the A/B/C switch (15) to the "C" position.)

- * **DISC** is applicable only to compact disc changer.
- * **STOP** is applicable only to LD player.

3 Tuner keys

Controls tuner.

(The A/B/C switch (15) should be set to the "A" position.)

- +**: Selects higher preset station number.
- : Selects lower preset station number.
- A/B/C/D/E**: Selects the group (A – E) of preset station numbers.

4 DSP program selector keys

Selects a DSP program when the built-in digital sound field processor (including the Dolby Pro Logic Surround decoder) is on.

5 TEST key

Used for speaker balance adjustment. (For details, refer to page 17–19.)

6 SLEEP timer key

This key is used to turn the built-in SLEEP timer on and off, and to set the SLEEP time. (See page 31 for details.)

7 2CH/6CH selector key

When the **TV/DBS** or **DVD/LD** input source is selected, pressing this key switches the input signals between 2 channel stereo signals and 6 channel discrete signals. When switched to "6CH", discrete signals from the unit connected to the 6CH DISCRETE INPUT DVD/LD TV/DBS terminals of this unit are selected as the input signals.

8 SYSTEM POWER and OFF keys

Pressing the **SYSTEM POWER** key turns the power of this unit on and pressing the **OFF** key turns the power off.

* (Except U.S.A. and Canada models)

While the power is on, pressing these keys switches the unit from the power-on mode to the standby mode, and vice versa. (In the standby mode, the standby mode indicator on the front panel is illuminated.)

9 RESET button

This button is inside the battery compartment.

Press this button to "reset" the internal microcomputer which controls remote control operations. Microcomputer "reset" is necessary when the remote control freezes.

- * Pressing the **RESET** button will not erase learned functions.

RESET button

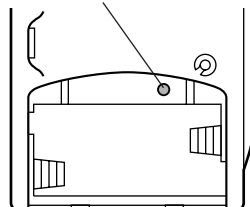

10 MASTER VOLUME ^ (up) and v (down) keys

Turns the volume level up and down.

11 DELAY/CENTER/REAR/SWFR selector (^ / v) and TIME/LEVEL +/- keys

Adjust the delay time (DELAY), the rear channel output level (REAR), center channel output level (CENTER) and the output level to the SUBWOOFER OUTPUT terminal (SWFR). Select the item which you want to adjust by pressing the ^ or v key and adjust its time or level by pressing the + or – key.

12 EFFECT ON/OFF key

Switches on/off the digital sound field processor (including the Dolby Pro Logic Surround decoder).

13 Input selector keys

Selects input source.

14 A/B/C indicators

The position (A, B or C) selected by the A/B/C switch is shown in red.

15 A/B/C switch

This switch must be used only when the lid of the remote control transmitter is open. (This switch will not function when the lid is closed.)

Normally, set this switch to the "A" position. When controlling a Yamaha LD player by using the CD/LD player keys (2), set this switch to the "C" position.

16 TRANSMIT/LEARN indicator

Lights up when the remote control transmitter is transmitting infrared signals (when a command key is pressed).

Note

When using the keys to control Yamaha components, identify them with your component's keys. If these keys are identical, their functions will be the same. For each key function, refer to the corresponding instruction in your component's manual.

LEARNING NEW CONTROL FUNCTIONS (When the lid is open)

This is a learning remote control transmitter. The shaded keys in the illustration shown below can be programmed to “learn” control functions from other remote control transmitters. By learning key-functions from other remote control transmitter, this unit can then be used in place of one or more other remote control transmitters, thus making operation of your various audio and video components more convenient.

Some of the “learning-capable” keys are originally empty and others have already been preset with functions to control this unit and other Yamaha components. You can store new functions to them (in place of preset functions) as desired.

* See page 39 for the learning method.

* See page 41 for clearing a learned function (or all learned functions).

Note

If the memory capacity of the remote control transmitter becomes full, no further learning is possible even if some learning-capable keys are not occupied with new functions. If, for example, you store Yamaha codes only into this remote control transmitter, up to about 20 functions can be stored. Store new functions to the learnable-capable keys which are useful for you.

Keys which can have three functions (①, ②, ③, ④)

In the “Learning-capable” keys, the keys numbered ①–④ in the illustration at left can have three functions. This is because they have three memory areas (A, B and C). (One function per area.) You can store new functions into the area B and C, and use three functions on a key by switching the memory areas with the **A/B/C switch**. (Area A cannot learn a new function.)

To use these keys:

1. Before using a key, select the area A, B or C of the key on which the function you want to use is stored by using the **A/B/C switch**.
2. Press the key.

The original factory settings of these keys are as follows.

	The position of A/B/C switch		
	A	B	C
①	Preset with functions for controlling a Yamaha tape deck.	Empty	Empty
②	Preset with functions for controlling a Yamaha CD player. (STOP is empty.)	Empty	Preset with functions for controlling a Yamaha LD player. (DISC is empty.)
③	Preset with functions for controlling the built-in tuner.	Empty	Empty
④	Preset as the DSP program selector keys and the TEST key. * ²	Preset as the DSP program selector keys and the TEST key. * ²	Preset as the DSP program selector keys and the TEST key. * ²

*²: “+10” is empty.
The functions on “9” and “0” are useless.

Note

The area A of all keys cannot learn new functions. To store new functions to these keys, store them onto the area B or C.

Empty keys (①, ②)

These are empty keys. Each key can learn a function from another remote control transmitter.

For example, the **TV** key is useful for storing the function of your TV’s power switch, and the **VCR** key can be used for your VCR’s power switch.

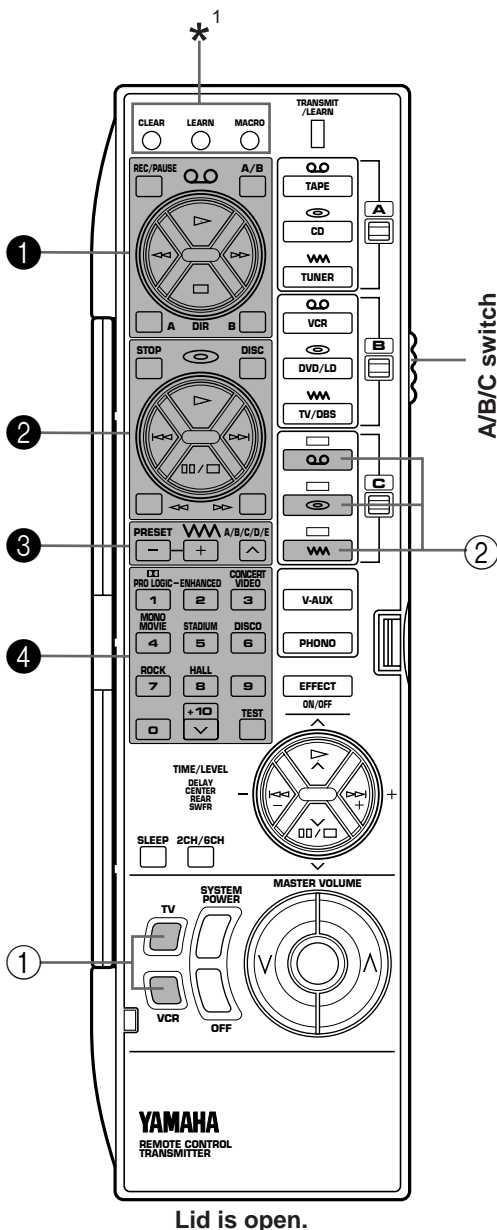

Lid is open.

*¹: These buttons are used for learning a new function or clearing a learned function (or all learned functions). See page 39–41 for details.

Note

If a key which has a preset function learns a new function, the preset function will not be deleted, but disabled. When the learned function is cleared, the preset function is restored. (For information on clearing a learned function, refer to page 41.)

About the marks shown on the remote control transmitter

The marks on the remote control transmitter signify functions of keys, input sources, etc.

Examples)

- ◻◻ (tape): Shows tape deck, VCR, etc.
- ◻ (disc): Shows CD player, LD player, etc.
- ⊞ (radio wave): Shows tuner, TV/BS tuner, etc.

These marks are helpful for storing new functions.

Examples)

- The area B of keys ❶ is suitable for storing functions to control your VCR.
- The area B of keys ❸ is suitable for storing functions to control your TV/BS tuner.

USING OPERATION CONTROL KEYS (When the lid is closed)

When the lid of the remote control transmitter is closed, you can easily operate Yamaha components including learned functions by using the **OPERATION CONTROL** keys.

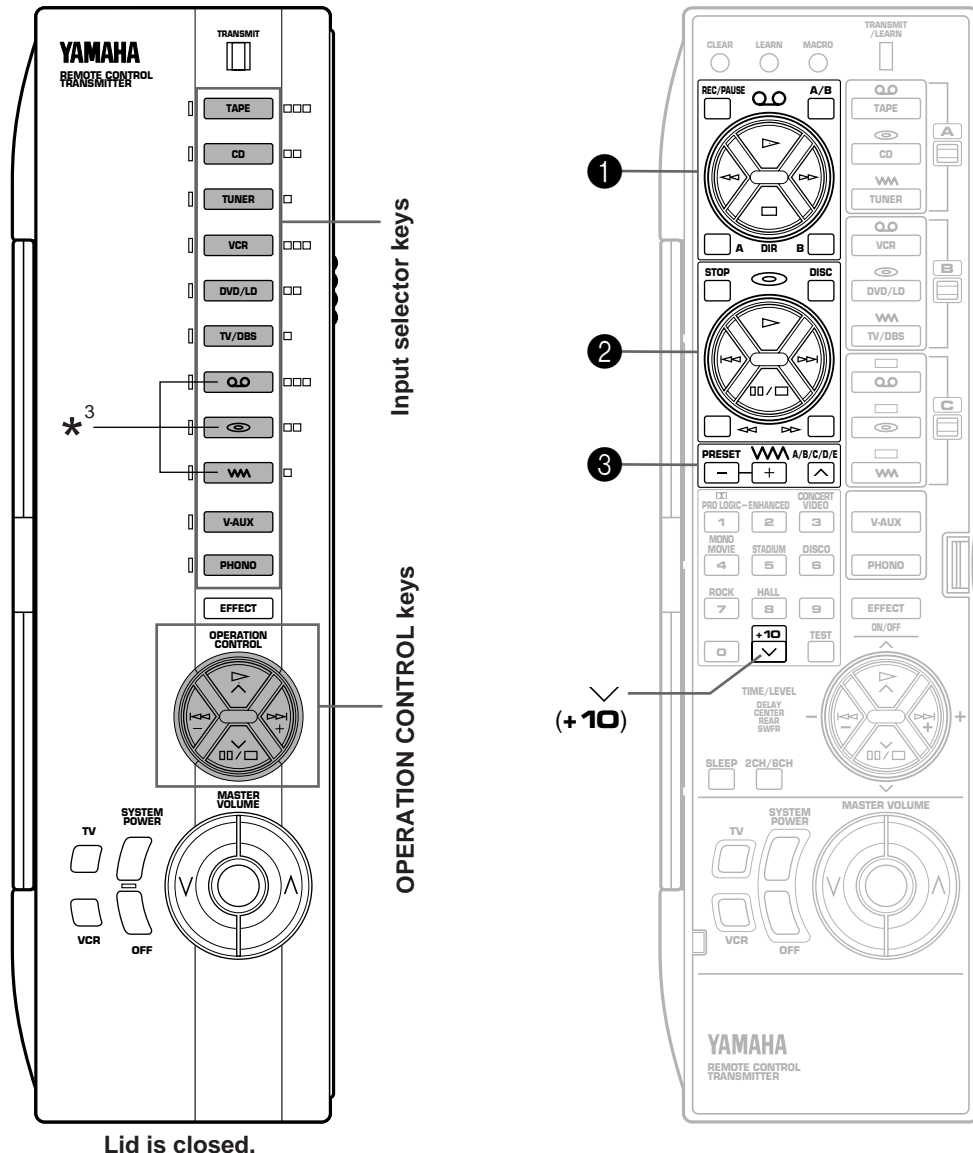

Lid is closed.

*³: These keys are originally empty. If these keys have learned functions, pressing them executes those learned functions.

When the lid is closed, the **OPERATION CONTROL** keys substitute for the keys numbered ①, ②, ③ and the √ (+10) key on the left illustration. To use these keys, you do not have to switch the A/B/C switch. The functions which the **OPERATION CONTROL** keys carry out are determined by which input selector key was pressed before you used the **OPERATION CONTROL** keys.

Note

When the lid is closed, the **EFFECT, MASTER VOLUME, TV** and **VCR** keys will function in the same way as when the lid is open.

* If the **MACRO** switch on the side of the remote control transmitter is set to “OFF”, when the lid is closed, the **SYSTEM POWER** and **OFF** keys also will function in the same way as when the lid is open.

Examples of operations controlled by using the OPERATION CONTROL keys

To operate a Yamaha CD player

1. Press the “CD” input selector key.
2. Use the **OPERATION CONTROL** keys. (They carry out the functions in area A of keys ②.)

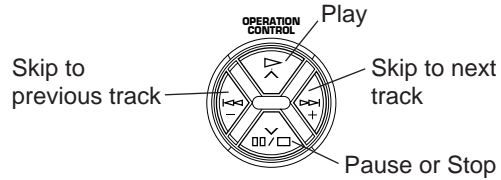

To operate your VCR

1. Press the “VCR” input selector key.
2. Use the **OPERATION CONTROL** keys. (They carry out the functions in area B of keys ①. This area is originally preset with no function. You must store the functions related to controlling the VCR in area B of keys ① beforehand.)

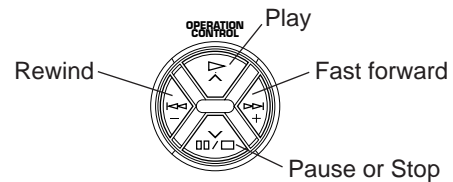

See the table below for a combination of an input selector key and key functions which the **OPERATION CONTROL** keys carry out. (Also, refer to the table on page 34.)

Selected input selector	Key functions which the OPERATION CONTROL keys carry out
TAPE	Functions in area A of keys ① (except REC/PAUSE, A/B, DIR A and B)
CD	Functions in area A of keys ② (except STOP, DISC, <<< and >>>)
TUNER	Functions in area A of keys ③ and √ (+10)
VCR	Functions in area B of keys ① (except REC/PAUSE, A/B, DIR A and B)
DVD/LD	Functions in area B of keys ② (except STOP, DISC, <<< and >>>)
TV/DBS	Functions in area B of keys ③ and √ (+10)
Q.D	Functions in area C of keys ① (except REC/PAUSE, A/B, DIR A and B)
⓪	Functions in area C of keys ② (except STOP, DISC, <<< and >>>)
WM	Functions in area C of keys ③ and √ (+10)

Pressing the “V-AUX” or “PHONO” input selector key has no effect on the **OPERATION CONTROL** keys.

Notes

- If the **OPERATION CONTROL** keys substitute for keys which has no function (empty), no command is carried out. According to your plan, store functions from other remote control transmitters into an empty area of those keys. (Refer to page 39 for the learning method.)
- While playing an audio/video unit, if you want to operate another unit by using the remote control transmitter (for example, if you want to rewind a tape on your VCR while listening to a CD), you should open the lid of the remote control transmitter and use the A/B/C switch and the corresponding keys. (If you press an input selector key with the lid closed to change the functions of the **OPERATION CONTROL** keys to the functions for controlling a VCR, the input of currently playing CD source is canceled.)

MACRO OPERATIONS (When the lid is closed)

“Macro” is a command which defines a sequence of several operations.

The keys shown in the illustrations below (as **preset macro keys**) are also preset with macros, in addition to individual functions.

Each macro key is preset so that simply pressing it alone will carry out several functions of other keys on this remote control transmitter sequentially. (To know what key functions are sequentially carried out by pressing each preset macro key, see the next page.)

Macros can be used only when the lid is closed and the **MACRO** switch is set to “SLOW” or “QUICK”. (If “OFF” is selected, no macro will function even if the lid is closed.)

Preset macro keys are originally preset with macros. If you prefer, however, you can change the contents of a macro key by storing a desired series of functions on it. You can store up to seven functions onto a macro key. (See page 40 for the learning method.)

Setting the MACRO switch

OFF: In this position, no macro will function even if the lid of remote control transmitter is closed.





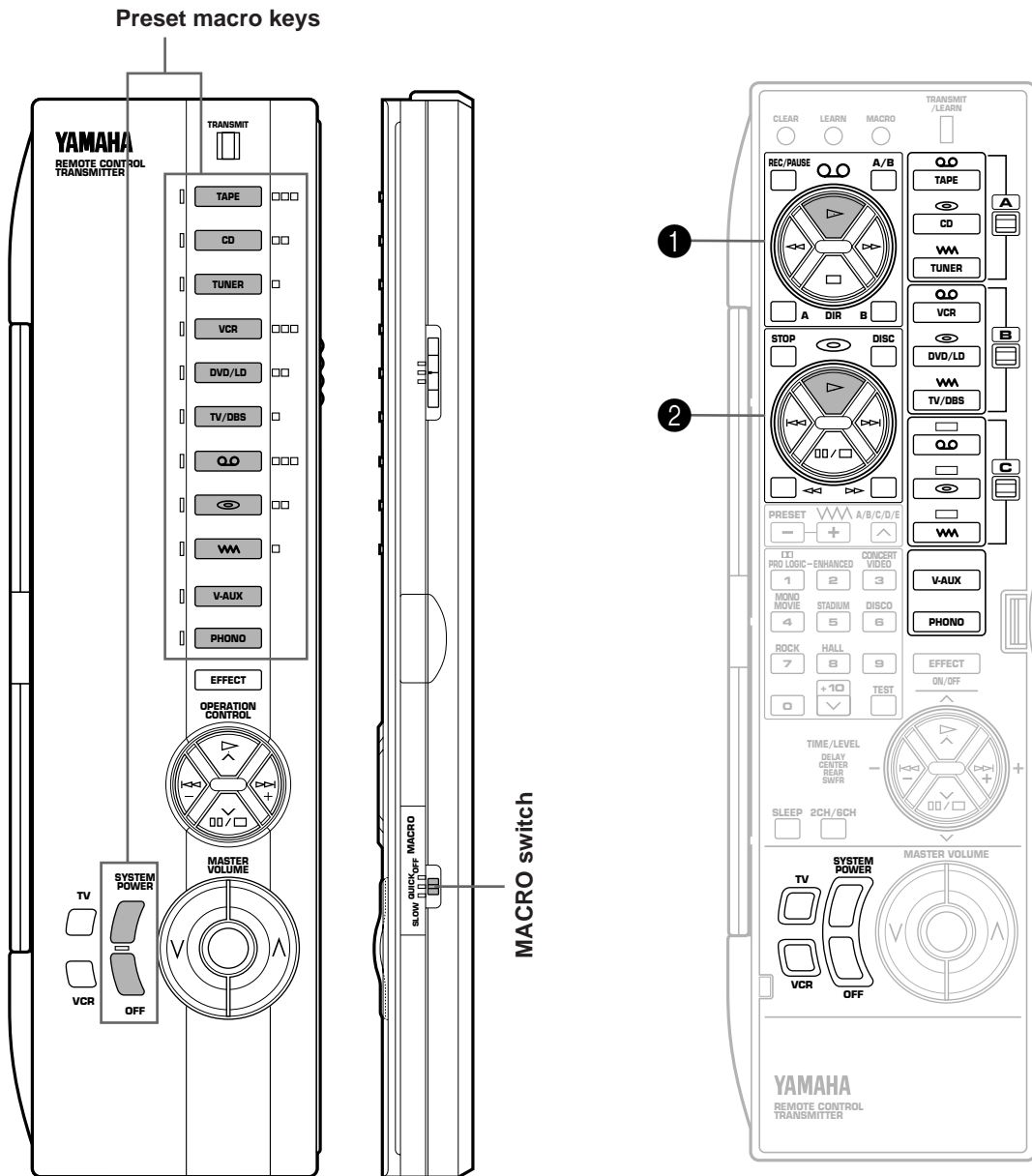



















QUICK: In this position, when a macro key is pressed, each command is transmitted at 0.5 second intervals.







SLOW: In this position, when a macro key is pressed, each command is transmitted at 3 second intervals.



Lid is closed.
(Set the MACRO switch to “QUICK” or “SLOW”).

Preset macro keys and the key functions which they carry out sequentially are as follows. (Also, refer to the table on page 34.)

Macro key	Function of the key (and area) which operates when a macro key is pressed		
	1st (Turning the power of this unit on)	2nd (Selecting an input source)	3rd (Playing a source)
 TAPE		 TAPE	“▷” on area A of keys ①
 CD		 CD	“▷” on area A of keys ②
 TUNER		 TUNER	—
 VCR		 VCR	“▷” on area B of keys ①
 DVD/LD		 DVD/LD	“▷” on area B of keys ②
 TV/DBS		 TV/DBS	—
 Q.D		 Q.D	“▷” on area C of keys ①
 		 	“▷” on area C of keys ②
 WMA		 WMA	—
 V-AUX		 V-AUX	—
 PHONO		 PHONO	—

Macro key	Function of the key which operates when a macro key is pressed		
	1st	2nd	3rd
 SYSTEM POWER	 SYSTEM POWER	 TV	 VCR
 OFF	 OFF	—	—

Notes

- A key in which no function is stored will carry out no command.
- If it occurs that this unit will not receive the second command because the internal operation of the first command takes a long time, set the **MACRO** switch to the “SLOW” position, or add no function or repeat the same command between the first command and the next command.
- If you will program the power on/off switching function of TV, VCR, etc. as part of a macro sequence, note that it switches the current mode to the other (“on” to “off”, or “off” to “on”). For example, when you press the macro key, if the power of TV, VCR, etc. is already on, the power will be turned off even though you may not want it to do so.
- Once you press a macro key, this unit will not receive the command of another key (even if it is pressed) until this unit finishes carrying out all commands of the macro key. Take notice of this especially when the **MACRO** switch is in the “SLOW” position.
- Once you press a macro key, you must keep the remote control transmitter directed at the main unit’s remote control sensor until the remote control transmitter finishes transmitting all command signals of the macro key.
- You can use the **OPERATION CONTROL** keys also while using the macro functions.

LEARNING A NEW FUNCTION

- 1** Place this remote control transmitter and the other remote control transmitter so that they face each other.

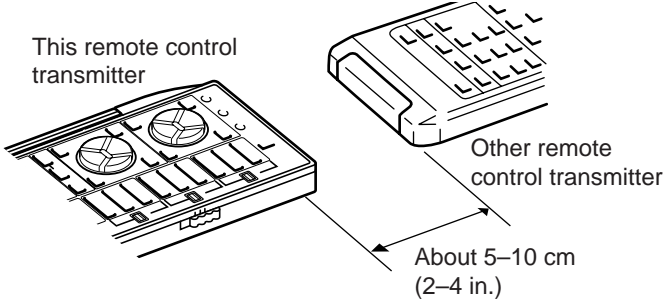

- 2** (Press by using the point of a mechanical pencil, etc.)

- * If there is no operation for about 30 seconds after the **LEARN** button is pressed, the **TRANSMIT/LEARN** indicator flashes rapidly and the current mode is canceled. If this occurs, repeat this step.

- 3** If necessary, select the memory area by using the A/B/C switch on the side panel of the remote control transmitter.

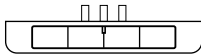

- 4** Press the key on this remote control transmitter in which you will store a new function.

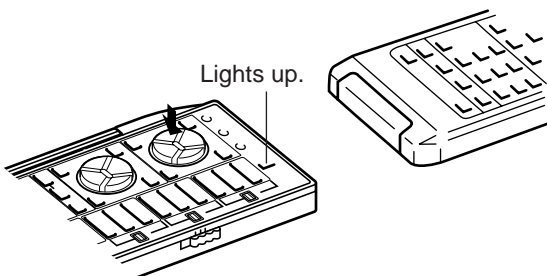

- * If a key which cannot learn another function is pressed, the **TRANSMIT/LEARN** indicator flashes rapidly and the current mode is canceled. If this occurs, repeat this step.
* If there is no operation for about 30 seconds after a key is pressed, the **TRANSMIT/LEARN** indicator flashes rapidly and the mode before you began learning operations is restored. If this occurs, restart from step 2.

- 5** Press and hold the key (on the other remote control transmitter) which has the function you want to store.

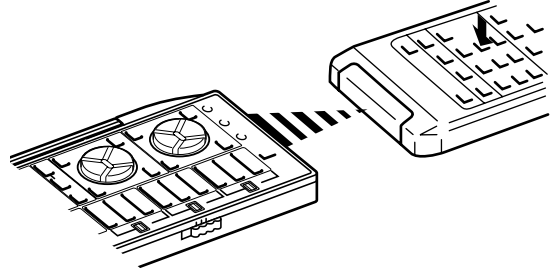

- * When learning is finished, the **TRANSMIT/LEARN** indicator stops lighting and then begins flashing slowly.
* If a signal is not successfully received, the **TRANSMIT/LEARN** indicator flashes rapidly and the mode prior to step 4 is restored. If this occurs, restart from step 4.
* If memory capacity is full, the **TRANSMIT/LEARN** indicator flashes rapidly to show you that learning is impossible, and then the mode before you began learning operations is restored.

- 6** Repeat step 3-5 to store more functions.

- 7** When you finish the learning operation, press the **LEARN** button.

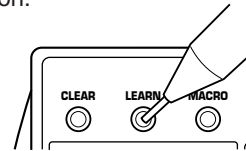

Notes

- Newly learned functions will replace previously learned functions.
- If there is no more room in the memory area for a function to be learned, the **TRANSMIT/LEARN** indicator will flash rapidly. In this case, even if some keys are not occupied with functions from other remote control transmitters, no further learning is possible.
- If the lid is closed while learning and about 5 seconds pass, the **TRANSMIT/LEARN** indicator flashes rapidly and the mode before you began learning operations is restored. If this occurs, restart from step 2. However, if the lid is opened within 5 seconds, the mode before the lid was closed is restored.
- There may occasionally be instances in which, due to the signal-coding and modulation employed by the other remote control transmitter, this remote control transmitter will not be able to "learn" its signals.

MAKING A NEW MACRO

A new macro can be programmed onto any preset macro key in place of preset functions. (See page 37 to know what keys are preset macro keys.) You can make as many as 13 new macro keys. A macro key can learn as many as seven functions of other keys.

Note

If you store a continuous command such as lowering of volume level, it will become a short command when it is carried out as a part of macro.

1

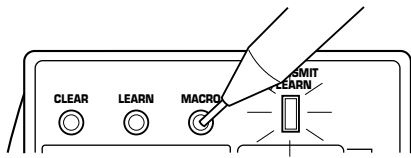

Flashes slowly.

- * If there is no operation for about 30 seconds after the **MACRO** button is pressed, the **TRANSMIT/LEARN** indicator flashes rapidly and the mode before you pressed the **MACRO** button is restored. If this occurs, press the **MACRO** button again.

2

Press a preset macro key on which you want to make a new macro.



Lights up.

- * If a key other than a preset macro key is pressed, the **TRANSMIT/LEARN** indicator flashes rapidly and the current mode is canceled. If this occurs, repeat this step.

3

Press a key whose function you want to store as the first function of the new macro.

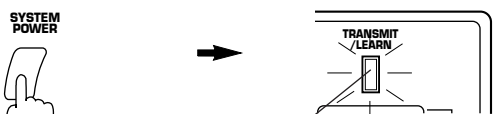

Goes off.
(When learning is finished, this indicator lights up again.)

- * If a key whose function cannot be stored as a command of macro is pressed, the **TRANSMIT/LEARN** indicator flashes rapidly and the current mode is canceled. If this occurs, repeat this step.
- * If about 30 seconds pass before a key is pressed, the **TRANSMIT/LEARN** indicator flashes rapidly and the mode before you began learning operations is restored. If this occurs, restart from step 1.

4

Repeat step 3 to store the second, the third and more functions. You can store up to seven key functions in series as a macro.

- * If the seventh key function has been learned, the **TRANSMIT/LEARN** indicator flashes rapidly and the mode before you began learning operations is restored. (This shows that the key has completed learning a series of functions as a macro.) If this occurs, you do not have to follow the next step.

5

When you finish learning, press the **MACRO** button.

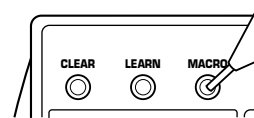

It is recommended to write down new key functions you stored on the provided user function stickers and paste them on the reverse side of the remote control transmitter or the reverse side of the remote control transmitter's lid.

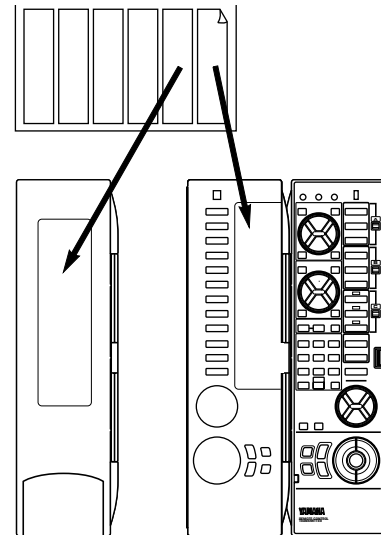

Memory back-up

All of the learned functions will be retained while you replace the batteries. However, if no batteries are installed for a few hours, the learned functions will be erased and will have to be learned again.

CLEARING LEARNED FUNCTIONS

To Clear a Learned Function

- 1 To clear a learned key function, press the **LEARN** button using the point of a mechanical pencil, etc.
To clear a macro you made, press the **MACRO** button.

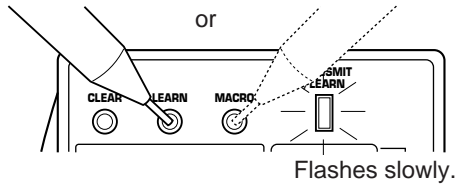

- 2 Press and hold the **CLEAR** button using the point of a mechanical pencil, etc.

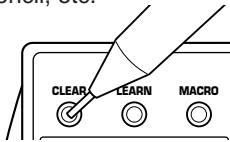

- 3 Holding the **CLEAR** button pressed, press and hold the key whose function you want to clear until the indicator flashes 3 times.

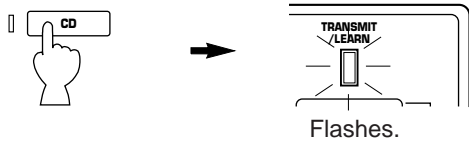

To clear two or more functions sequentially, do not release the **CLEAR** button pressed, and repeat this step.

Note

If you clear a learned function of a key, the originally preset function of the key is restored (except the keys which are originally preset with no function.)

To Clear All Learned Functions

- 1 Select the kind of key functions all of which you want to clear by using the **MACRO** switch on the side panel of the remote control transmitter.

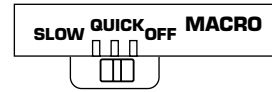

- OFF:** Select this position if you want to clear all of the learned functions except macros.
QUICK: Select this position if you want to clear all of the macros you made only.
SLOW: Select this position if you want to clear all of the learned functions including macros.

- 2 Press the **CLEAR** button using the point of a mechanical pencil, etc.

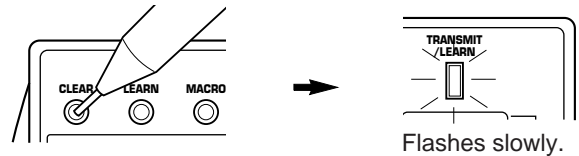

- * If one of the following operation is made after you press the **CLEAR** button, the TRANSMIT/LEARN indicator flashes rapidly and the current mode is canceled. If this occurs, press the **CLEAR** button again.
- **MACRO** switch is switched to another position.
 - Another key is pressed.
 - There is no operation for about 30 seconds.

- 3 Press and hold the **CLEAR** button again. While holding the **CLEAR** button pressed, press and hold the **MASTER VOLUME** \wedge and \vee keys simultaneously until the indicator flashes 7 times.

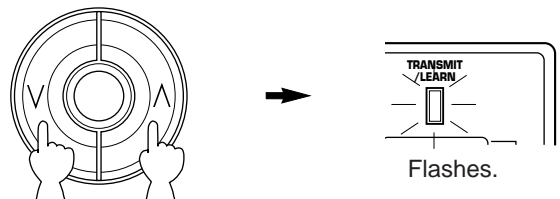

Trouble shooting guide

SYMPTOM	CAUSE	REMEDY
The remote control transmitter does not work.	The batteries of this remote control transmitter are weak. The internal microcomputer "freezes".	Replace the batteries with new ones and press the RESET button on the remote control transmitter.
Learning cannot be made successfully. (The TRANSMIT/LEARN indicator does not light up or flash.)	The batteries of this remote control transmitter and/or the other remote control transmitter are weak.	Replace the batteries (and press the RESET button for this remote control transmitter).
	The distance between the two remote control transmitters is too long or too short.	Place the remote control transmitters with the proper distance.
	The signal coding or modulation of the other remote control transmitter is not compatible with this remote control transmitter.	Learning is not possible.
	Memory capacity is full.	Further learning is not possible without deleting unnecessary commands.
	The internal microcomputer "freezes".	Press the RESET button on the remote control transmitter.

NOTES ABOUT THE REMOTE CONTROL TRANSMITTER

Battery installation

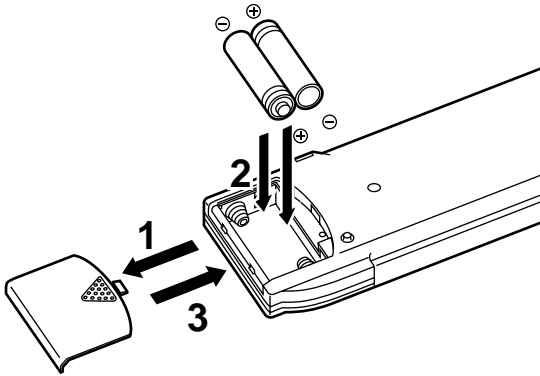

Battery replacement

If you find that the remote control transmitter must be used closer to the main unit, the batteries are weak. Replace both batteries with new ones.

Notes

- Use only AA, R6, UM-3 batteries for replacement.
- Be sure the polarities are correct. (See the illustration inside the battery compartment.)
- Remove the batteries if the remote control transmitter will not be used for an extended period of time.
- If batteries leak, dispose of them immediately. Avoid touching the leaked material or letting it come in contact with clothing, etc. Clean the battery compartment thoroughly before installing new batteries.
- After you change batteries, make sure to press the **RESET** button inside the battery compartment.

Remote control transmitter operation range

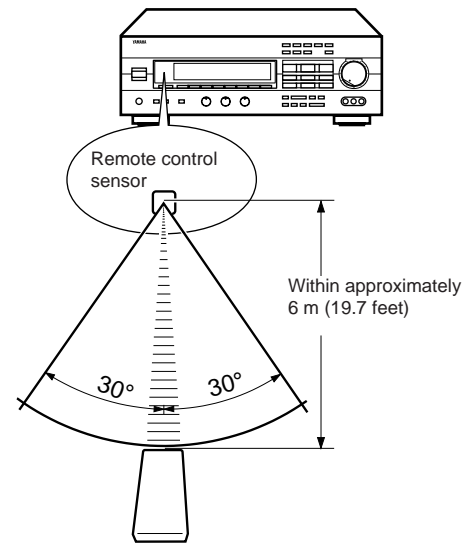

Notes

- There should be no large obstacles between the remote control transmitter and the main unit.
- If the remote control sensor is directly illuminated by strong lighting (especially an inverter type of fluorescent lamp etc.), it might cause the remote control transmitter not to work correctly. In this case, reposition the main unit to avoid direct lighting.

TROUBLESHOOTING

If the unit fails to operate normally, check the following points to determine whether the fault can be corrected by the simple measures suggested. If it cannot be corrected, or if the fault is not listed in the SYMPTOM column, disconnect the power cord and contact your authorized YAMAHA dealer or service center for help.

	SYMPTOM	CAUSE	REMEDY
General	The unit fails to turn on when the POWER switch is pressed, or turns off suddenly soon after the power is turned on.	Power cord is not plugged in or is not completely inserted.	Firmly plug in the power cord.
		The IMPEDANCE SELECTOR switch on the rear panel is not set to the upper or the lower end exactly.	Set the switch to the upper or the lower end exactly.
	It happens that this unit does not work normally.	There is an influence of strong external noise (lightning, excessive static electricity, etc.) or a misoperation on this unit while using this unit.	Turn off the power to this unit and disconnect the AC power cord from the AC outlet. After about 30 seconds have passed, connect the power and operate this unit again.
	No sound or no picture.	Incorrect output cord connections.	Connect the cords properly. If the problem persists, the cords may be defective.
		Appropriate input source is not selected.	Select an appropriate input source with the input selector buttons.
		The SPEAKERS switches are not set properly.	Set the SPEAKERS switch which corresponds to the speakers to be used to the ON position.
		Speaker connections are not secure.	Secure the connections.
	The sound suddenly goes off.	The protection circuit has been activated because of short circuit etc.	Turning the unit off and then on will reset the protection circuit.
		The SLEEP timer has functioned.	Cancel the SLEEP timer function.
	Only one side speaker outputs the sound.	Incorrect setting of the BALANCE control.	Adjust it to the appropriate position.
		Incorrect cord connections.	Connect the cords properly. If the problem persists, the cords may be defective.
	Sound "hums".	Incorrect cord connections.	Firmly connect the audio plugs. If the problem persists, the cords may be defective.
		No connection from the turntable to the GND terminal.	Make the GND connection between the turntable and this unit.
	The volume level is low while playing a record.	The record is being played on a turntable with an MC cartridge.	The player should be connected to the unit through the MC head amplifier.
	The volume level cannot be increased, or sound is distorted.	The power to the component connected to the REC OUT terminals of this unit is off.	Turn the power to the component on.
	No sound from the rear speakers.	The sound output level to the rear speakers is set to minimum.	Raise the sound output level to the rear speakers.
		The monaural sound source is played in DOLBY PRO LOGIC or DOLBY PRO LOGIC ENHANCED mode.	Select another program suitable for the monaural sound source.
	No sound from the center speaker.	The sound output level to the center speaker is set to minimum.	Raise the sound output level to the center speaker.
		The center channel mode is in PHANTOM mode.	Select NORMAL or WIDE.
		Incorrect sound field program selection.	Select the appropriate program.
The sound is degraded when listening with the headphones connected to the compact disc player or cassette deck that are connected with this unit.	The power to this unit is off.	Turn the power to this unit on.	
FM	FM stereo reception is noisy.	Because of the characteristics of FM stereo broadcasts, this is limited to cases where the transmitter is too far away or the antenna input is poor.	Check the antenna connections. Try using a high quality directional FM antenna. Set the TUNING MODE button to the manual tuning mode.
	There is distortion and clear reception cannot be obtained even with a good FM antenna.	There is multipath interference.	Adjust antenna placement to eliminate multipath interference.
	A desired station cannot be tuned in with the automatic tuning method.	The station is too weak.	Use the manual tuning method. Use a high quality directional FM antenna.
	Previously preset stations can no longer be tuned in.	This unit has been unplugged for a long period.	Repeat the presetting procedure.
AM	A desired station cannot be tuned in with the automatic tuning method.	Weak signal or loose antenna connections.	Tighten the AM loop antenna connections and rotate it for best reception. Use the manual tuning method.
	There are continuous crackling and hissing noises.	Noises will result from lightning, fluorescent lamps, motors, thermostats and other electrical equipment.	Use an outdoor antenna and a ground wire. This will help somewhat but it is difficult to eliminate all noise.
	There are buzzing and whining noises (especially in the evening).	A television set is being used nearby.	Relocate this unit away from the TV.
Remote control Transmitter	The remote control transmitter does not work.	Direct sunlight or lighting (of an inverter type of fluorescent lamp etc.) is striking the remote control sensor of the main unit.	Change the position of the main unit.
		The batteries of this remote control transmitter are too weak.	Replace the batteries with new ones.

SPECIFICATIONS

AUDIO SECTION

Minimum RMS Output Power per Channel	
Main L, R	8 ohms, 1 kHz, 0.07% THD.....90W + 90W
Center	8 ohms, 1 kHz, 0.07% THD90W
Rear	8 ohms, 1 kHz, 0.3% THD.....35W + 35W
Maximum Power [General model only]	(8 ohms, 1 kHz, 10% THD)
Main L, R110W + 110W
Center110W
Rear50W + 50W
Dynamic Power per Channel	(by IHF Dynamic Headroom measuring method)
[U.S.A. and Canada models]	8/6/4/2 ohms.....110/140/170/190W
[Australia and General models]	8/6/4/2 ohms.....95/120/150/170W
Dynamic Headroom (8 ohms)	[U.S.A. and Canada models only]
1.66 dB
Power Band Width	8 ohms, 30W, 0.09% THD
10 Hz to 50 kHz
Damping Factor (SPEAKERS A)	8 ohms, 20 Hz to 20 kHz80 or more
Input Sensitivity/Impedance	PHONO MM.....2.5 mV/47 k-ohms
CD/TAPE/DVD-LD/TV-DBS/VCR150 mV/47 k-ohms
6CH DISCRETE INPUT DVD/LD TV/DBS150 mV/50 k-ohms
Maximum Input Signal	PHONO MM
	1 kHz, 0.04% THD.....110 mV
CD/TAPE/DVD-LD/TV-DBS/VCR	(EFFECT ON)
	1 kHz, 0.5% THD.....2.2V
Output Level/Impedance	REC OUT150 mV/2.5 k-ohms
PRE OUT (MAIN L/R)2.2V/1.2 k-ohms
PRE OUT (REAR L/R)1.6V/1.2 k-ohms
SUBWOOFER (EFFECT OFF)6.0V/1.5 k-ohms
Headphone Jack Rated Output/Impedance	Output Level (8 ohms, 0.04% THD).....0.5V
	Impedance.....390 ohms
Frequency Response (20 Hz to 20 kHz)	CD/TAPE/DVD-LD/TV-DBS/VCR
0±0.5 dB
RIAA Equalization Deviation	PHONO MM.....0±0.5 dB
Total Harmonic Distortion (20 Hz to 20 kHz)	PHONO MM to REC OUT
	1V0.02%
CD/TAPE/DVD-LD/TV-DBS/VCR to SP OUT	30W/8 ohms0.025%
Signal-to-Noise Ratio (IHF-A Network)	PHONO MM to REC OUT
	(5 mV Input Shorted)
	[U.S.A., Canada and General models]
85 dB
	[Australia model].....82 dB
CD/TAPE/DVD-LD/TV-DBS/VCR to SP OUT	(Shorted).....98 dB

Residual Noise (IHF-A Network)	MAIN L/R140 µV
Channel Separation	(Vol. -30 dB, EFFECT OFF)
PHONO MM (Input Shorted, 1 kHz/10 kHz)60 dB/50 dB
CD/TAPE/DVD-LD/TV-DBS/VCR	(Input 5.1 k-ohms Terminated,
	1 kHz/10 kHz)60 dB/45 dB
Tone Control Characteristics	BASS: Boost/cut.....±10 dB (50 Hz)
	Turnover Frequency(350 Hz)
TREBLE: Boost/cut.....±10 dB (20 kHz)	Turnover Frequency.....(3.5 kHz)
Bass Extension.....+6 dB (50 Hz)	
Gain Tracking Error (0 to -60 dB)3 dB	

VIDEO SECTION

Video Signal Type	[U.S.A. and Canada models].....NTSC
	[Australia model].....PAL
	[General model].....NTSC/PAL
Video Signal Level.....1 Vp-p/75 ohms	
S-Video Signal Level	Y1 Vp-p/75 ohms
	C0.286 Vp-p/75 ohms
Maximum Input Level.....1.5 Vp-p or more	
Signal-to-Noise Ratio50 dB or more	
Monitor Out Frequency Response5 Hz to 10 MHz, -3 dB

FM SECTION

Tuning Range	[U.S.A. and Canada models]
87.5 to 107.9 MHz
	[Australia and General models]
87.5 to 108.0 MHz
50 dB Quieting Sensitivity (IHF, 75 ohms)	Mono1.55 µV (15.1 dBf)
	Stereo.....21 µV (37.7 dBf)
Image Response Ratio	[U.S.A., Canada and General models]
45 dB
	[Australia model]80 dB
IF Response Ratio	[U.S.A., Canada and General models]
70 dB
	[Australia model]80 dB
Spurious Response Ratio70 dB	
AM Suppression Ratio55 dB	
Capture Ratio.....1.5 dB	
Alternate Channel Selectivity	[U.S.A., Canada and General models]
85 dB
Selectivity (two signals, 40 kHz Dev., ±300 kHz)	[Australia model]70 dB
Signal-to-Noise Ratio	(IHF) Mono/Stereo
	[U.S.A., Canada and General models]
80 dB/75 dB
	(DIN-Weighted, 40 kHz Dev.) Mono/Stereo
	[Australia model]75 dB/70 dB
Harmonic Distortion	Mono/Stereo (1 kHz)0.1/0.2%

Stereo Separation (1 kHz).....50 dB
Frequency Response
20 Hz to 15 kHz0 ±1.5 dB

AM SECTION

Tuning Range	[U.S.A., Canada and General models]
530 to 1,710 kHz
	[Australia model].....531 to 1,611 kHz
Usable Sensitivity100 µV/m	
Selectivity32 dB	
Signal-to-Noise Ratio50 dB	
Image Response Ratio.....40 dB	
Spurious Response Ratio.....50 dB	
Harmonic Distortion (1 kHz)0.3%	

AUDIO SECTION

Output Level/Impedance	FM (100% mod., 1 kHz)
500 mV/2.2 k-ohms
	AM (30% mod., 1 kHz)
150 mV/2.2 k-ohms

GENERAL

Power Supply	[U.S.A. and Canada models]
AC 120V, 60 Hz
	[Australia model]AC 240V, 50 Hz
	[General model]
AC 110/120/220/240V, 50/60 Hz
Power Consumption	[U.S.A. model].....230W
	[Canada model]250W
	[Australia and General models]270W
Maximum Power Consumption	[General model only]
	(8 ohms, 1 kHz, 10% THD, When
	5 channels are driven:)630W
AC Outlet(s)	2 SWITCHED OUTLETS
	[U.S.A., Canada and General models]
100W max. total
	1 SWITCHED OUTLET
	[Australia model]100W max.
Dimensions (W x H x D)435 x 151 x 379.5 mm
	(17-1/8" x 5-15/16" x 14-15/16")
Weight11.0 kg (24 lbs. 3 oz.)	
AccessoriesAM loop antenna	Indoor FM antenna
	Remote control transmitter
	Batteries
	User function stickers
	Antenna adapter
	(U.S.A. and Canada models only)

Specifications are subject to change without notice.