

 **YAMAHA**

GB

TSX-10

TSX-15

TSX-20

**TABLETOP STEREO SYSTEM
SYSTEM HI-FI TABLETOP**

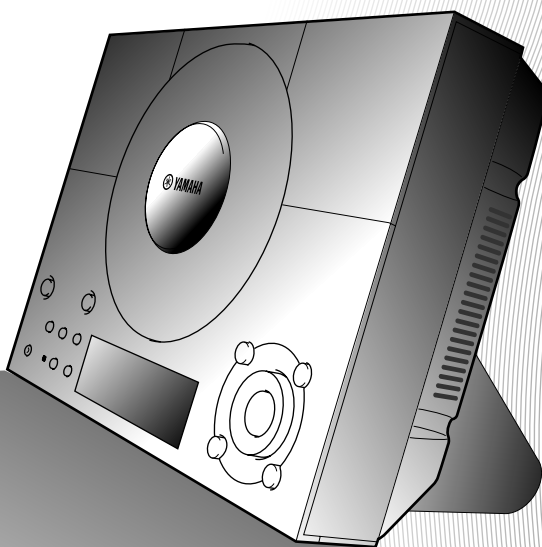

TABLETOP
Elegant Sound System



COMPACT
disc
DIGITAL AUDIO

**OWNER'S MANUAL
MODE D'EMPLOI
BEDIENUNGSANLEITUNG
BRUKSANVISNING
MANUALE DI ISTRUZIONI
MANUAL DE INSTRUCCIONES
GEBRUIKSAANWIJZING**

CAUTION

Use of controls or adjustments or performance of procedures other than those specified herein may result in hazardous radiation exposure.

ATTENTION

L'emploi de commandes, de réglages ou un choix de procédures différents des spécifications de cette brochure peut entraîner une exposition à d'éventuelles radiations pouvant être dangereuses.

ACHTUNG

Die Verwendung von Bedienungselementen oder Einstellungen oder die Durchführung von Bedienungsvorgängen, die nicht in dieser Anleitung aufgeführt sind, kann zu einem Kontakt mit gefährlichen Laserstrahlen führen.

OBSERVERA

Användning av kontroller och justeringar eller genomförande av andra procedurer än de som specificeras i denna bok kan resultera i att du utsätter dig för farlig strålning.

ATTENZIONE

Uso di controlli o regolazioni o procedure non specificamente descritte può causare l'esposizione a radiazioni di livello pericoloso.

PRECAUCIÓN

El uso de los controles o los procedimientos de ajuste o utilización diferentes de los especificados en este manual pueden causar una exposición peligrosa a la radiación.

VOORZICHTIG

Gebruik van bedieningsorganen of instellingen, of uitvoeren van handelingen anders dan staan beschreven in deze handleiding kunnen leiden tot blootstelling aan gevaarlijke stralen.

VARO!

AVATTAESSA JA SUOJALUKITUS OHITETTAESSA OLET ALTTIINA NÄKYMÄTTÖMÄLLE LASERSÄTEILYLLE. ÄLÄ KATSO SÄTEESEEN.

WARNING!

OSYNLIG LASERSTRÅLNING NÄR DENNA DEL ÄR ÖPPNAD OCH SPÄRREN ÄR URKOPPLAD. BETRakta EJ STRÅLEN.

**CLASS 1 LASER PRODUCT
LASER KLASSE 1 PRODUKT
LUOKKAN 1 LASERLAITE
KLASS 1 LASER APPARAT**

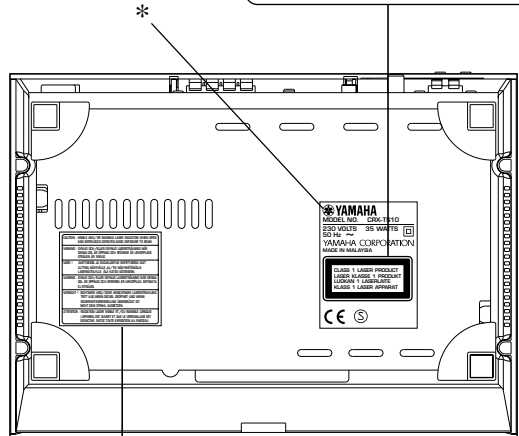

CAUTION - VISIBLE AND/OR INVISIBLE LASER RADIATION WHEN OPEN AND INTERLOCKS DEFEATED. AVOID EXPOSURE TO BEAM.

WARNING - SYNLIG OCH/ELLER OSYNLIG LASERSTRÅLNING NÄR DENNA DEL ÄR ÖPPNAD OCH SPÄRRAR ÄR URKOPPLADE. STRÅLEN ÄR FARLIG.

VARO ! AVATTAESSA JA SUOJALUKITUS OHITETTAESSA OLET ALTTIINA NÄKYMÄLLE JA /TAI NÄKYMÄTTÖMÄLLE LASERSÄTEILYLLE. ÄLÄ KATSO SÄTEESEEN.

WARNING - SYNLIG OCH/ELLER OSYNLIG LASERSTRÅLNING NÄR DENNA DEL ÄR ÖPPNAD OCH SPÄRREN ÄR URKOPPLAD. BETRakta EJ STRÅLEN.

VORSICHT ! SICHTBARE UND/ODER UNSICHTBARE LASERSTRÄHLUNG TRITT AUS, WENN DECKEL GEÖFFNET UND WENN SICHERHEITSVERREGELUNG ÜBERBRÜCKT IST. NICHT DEM STRAHL AUSSETZEN.

ATTENTION - RADIATION LASER VISIBLE ET /OU INVISIBLE LORSQUE L'APPAREIL EST OUVERT ET QUE LE VERROUILLAGE EST DESACTIVÉ. ÉVITEZ TOUTE EXPOSITION AU FAISCEAU.

*: This label also shows the model number, required voltage and power consumption of this unit, and other cautions, etc.

INTRODUCTION

Thank you for purchasing this YAMAHA product. We hope it will give you many years of trouble-free enjoyment. For the best performance, read this manual carefully. It will guide you in operating your YAMAHA product.

This owner's manual covers three packages TSX-10, TSX-15 and TSX-20.

Please check the package number of your product and its components by referring to the following table.

Package number	Components	
	CD receiver	Speaker system
TSX-10	CRX-TS10	NX-TS10
TSX-15	CRX-TS20	NX-TS10
TSX-20	CRX-TS20	NX-TS20

FEATURES

- Output Power per Channel
18 W + 18 W (4Ω, 1 kHz, 10% THD)
- Installation-free design
- Full Operation Remote Control
- Multi-Function Timer/Sleep Timer
- SUBWOOFER Output Terminal

Tuner

- 40-Station FM/AM Preset Tuning
- Multi-Function RDS Reception

CD Player

- 5-bit DAC and 8fs Digital Filter
- Optical Digital Output
- Random and Repeat Play

Speakers

- 2-Way Bass-Reflex Speaker System
Magnetic Shielding Type

SUPPLIED ACCESSORIES

After unpacking, check that the following parts are included.

- Remote control

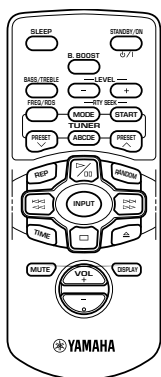

- AM loop antenna

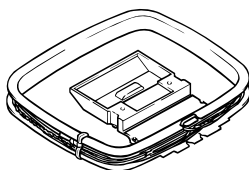

- Indoor FM antenna



- Speaker cable x 2

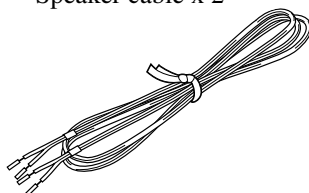

- Battery (CR2025)



- Stand x 3

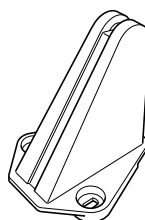

- Mounting bracket

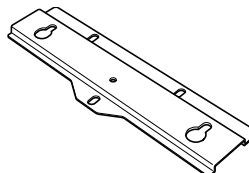

- Non-slip pad x 4

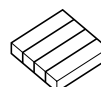

- Screw x 9



- Paper pattern

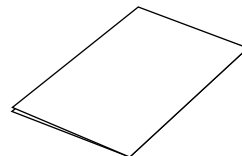

CONTENTS

INTRODUCTION	1
FEATURES	1
SUPPLIED ACCESSORIES	1
SETTING UP THIS SYSTEM	2
PRECAUTIONS	3
NAMES OF BUTTONS AND CONTROLS	
Front panel	4
Display	4
Remote control	5
GETTING STARTED	
Connections	6
Installation	8
CD preventive care	10
Remote control	11
Setting the clock	12
Adjusting the brightness of the display	12
LISTENING TO A SOURCE	13

COMPACT DISC PLAYER OPERATIONS

CD play	14
Selecting the time display	15
Random-sequence play	15
Repeat play	16

TUNER OPERATIONS

Listening to the radio	17
Presetting stations	18

RECEIVING RDS STATIONS

Receiving RDS data	19
PTY SEEK mode	20
Optional settings for RDS functions	21

USING THE BUILT-IN TIMER

Timer play	22
Sleep timer	23

ADDITIONAL INFORMATION

Troubleshooting	24
Specifications	26

SETTING UP THIS SYSTEM

When not using the stands

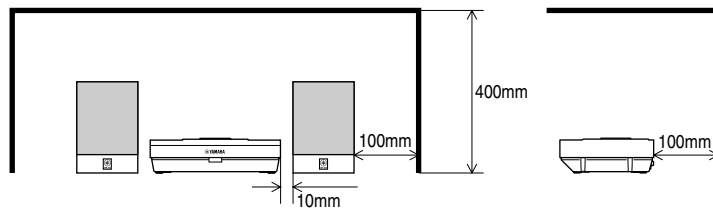

When using the stands

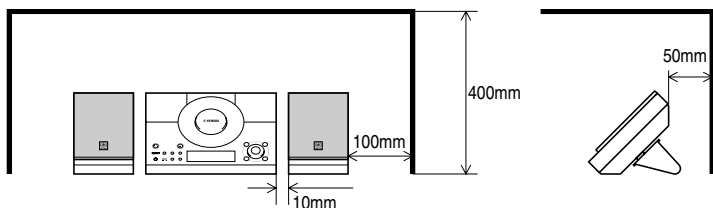

Set up this system by allowing spaces specified in the figure or more around and behind the main unit to assure good ventilation. To prevent the ventilation holes from being obstructed, be sure not to place another unit or any object on top of the main unit. Otherwise, it may cause fire or damage to the main unit.

Cautions

- If the main unit is put inside a rack, the front of it must be fully open.
- When mounting this system on the wall, allow spaces specified in the figure around the system as well, however, the space between the system and the wall is determined by the mounting bracket and screws used.
- When mounting this system on the wall, make sure that there is no metallic projection on the wall. If a metallic projection get into an opening of the main unit, it may cause fire or an electric shock to the user.

PRECAUTIONS: READ THIS BEFORE OPERATING THIS SYSTEM

- 1 To assure the best performance, please read this manual carefully. Keep it in a safe place for future reference.
- 2 To avoid humming sounds, position this system away from other electrical appliances, motors and transformers. To prevent fire or electrical shock, do not place this system where it may get exposed to rain or any kind of liquid.
- 3 Avoid extreme temperature fluctuations or excessive use of a humidifier in the room where this system is installed to prevent condensation inside this system, which may cause an electrical shock, fire damage to this unit, and/or personal injury.
- 4 In order not to obstruct heat radiation, do not cover the main unit with a newspaper, a tablecloth, a curtain, etc. If the temperature inside the main unit rises, it may cause fire, damage to the main unit and/or personal injury.
- 5 Avoid installing this system in a place where foreign objects and liquid might fall. It might cause a fire, damage to this system and/or personal injury. Do not place the following objects on this system:
 - Other components, as they may cause damage and/or discolor the surface of this system.
 - Burning objects (i.e., candles), as they may cause fire, damage to this system and/or personal injury.
 - Containers with liquid in them, as they may cause an electrical shock to the user and/or damage to this system.
- 6 Do not use force on switches, controls or connection cables. Never pull the cables when disconnecting them.
- 7 Only the voltage specified on the main unit must be used. Using this system with a higher voltage than specified is dangerous and may result in fire or other accidents. YAMAHA will not be held responsible for any damage resulting from the use of this system with a voltage other than that specified.
- 8 Placing the speakers on the same shelf or rack as the turntable can result in howling.
- 9 Secure placement or installation is the owner's responsibility. YAMAHA shall not be liable for any accident caused by improper placement or installation of this system.
- 10 Any time you note distortion, reduce the volume to a lower setting. Never allow the amplifier to be driven into "clipping". Otherwise the speakers may be damaged.
- 11 Do not attempt to clean this system with chemical solvents; this might damage the finish. Use a clean, dry cloth.
- 12 Disconnect the power cord from the wall outlet when not planning to use this system for a long period of time, or during an electrical storm, as it could be damaged by lightning.
- 13 Do not attempt to modify or fix this system yourself. Contact qualified YAMAHA service personnel when any service is needed. The cabinet should never be opened for any reason.
- 14 Be sure to read the "Troubleshooting" section regarding common operating errors before concluding that this system is faulty.

The main unit is not disconnected from the AC power source as long as it is connected to the wall outlet, even if the unit itself is turned off. This state is called the standby mode. In this state, the unit is designed to consume a very small quantity of power.

CAUTION FOR CARRYING THE MAIN UNIT

Before carrying the main unit, first remove the disc from the unit, press **STANDBY/ON** to turn the unit off, then disconnect the AC power plug from the wall outlet.

SPECIAL INSTRUCTIONS FOR U.K. MODEL

IMPORTANT:

The wires in the mains lead are coloured in accordance with the following code:

Blue: NEUTRAL
Brown: LIVE

As the colours of the wires in the mains lead of this apparatus may not correspond with the coloured markings identifying the terminals in your plug, proceed as follows: The wire which is coloured BLUE must be connected to the terminal which is marked with the letter N or coloured BLACK. The wire which is coloured BROWN must be connected to the terminal which is marked with the letter L or coloured RED. Making sure that neither core is connected to the earth terminal of the three pin plug.

For U.K. customers

If the socket outlets in the home are not suitable for the plug supplied with this appliance, it should be cut off and an appropriate 3 pin plug fitted. For details, refer to the instructions described above.

Note: The plug severed from the mains lead must be destroyed, as a plug with bared flexible cord is hazardous if engaged in a live socket outlet.

CAUTION

Use of controls or adjustments or performance of procedures other than those specified herein may result in hazardous radiation exposure.

CLASS 1 LASER PRODUCT
LASER KLASSE 1 PRODUKT
LUOKAN 1 LASERLAITE
KLASS 1 LASER APPARAT

This compact disc player is classified as a CLASS 1 LASER product. The CLASS 1 LASER PRODUCT label is located on the rear panel.

The laser component in this product is capable of emitting radiation exceeding the limit for Class 1.

Front panel

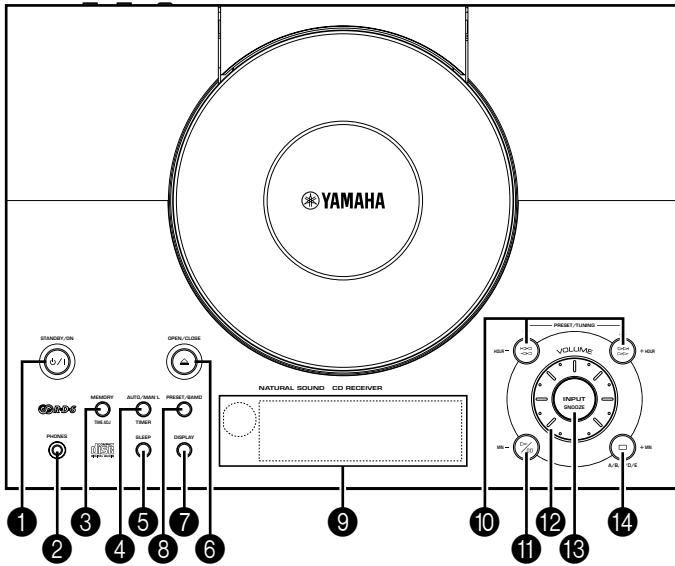

- ① **STANDBY/ON** (P.13)
- ② **PHONES** (P.13)
- ③ **MEMORY/TIME ADJ** (P.12, 18)
- ④ **AUTO/MAN'L/TIMER** (P.17, 22)
- ⑤ **SLEEP** (P.23)
- ⑥ **△ OPEN/CLOSE** (P.14)
- ⑦ **DISPLAY** (P.12, 22)
- ⑧ **PRESET/BAND** (P.17)
- ⑨ **Display** (P.4)
- ⑩ **PRESET/TUNING** ∨ / ∧ (P.17)
When TUNER is selected as an input source
- ◀◀ / ◀◀ / ▶▶ / ▶▶▶ (P.14)
When CD is selected as an input source
- ⑪ ▷ / ⏸ (Play/Pause) (P.14)
- ⑫ **VOLUME** (P.13)
- ⑬ **INPUT/SNOOZE** (P.8, 23)
- ⑭ **A/B/C/D/E** (P.18)
When TUNER is selected as an input source
- (Stop) (P.14)
When CD is selected as an input source

Display

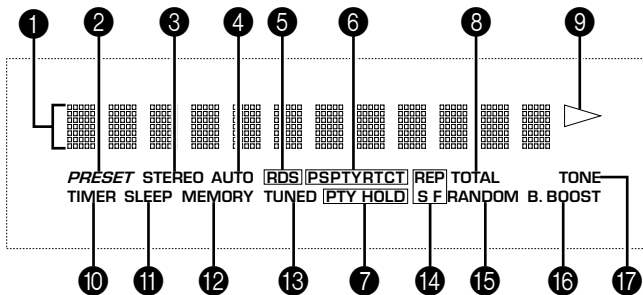

- ① Multi information display
- ② **PRESET** indicator (P.18)
- ③ **STEREO** indicator (P.17)
- ④ **AUTO** indicator (P.17)
- ⑤ **RDS** indicator (P.19)
- ⑥ RDS mode indicators (P.19)
- ⑦ **PTY HOLD** indicator (P.20)
- ⑧ **TOTAL** indicator (P.15)
- ⑨ ▷ (Play) indicator (P.14)
- ⑩ **TIMER** indicator (P.22)
- ⑪ **SLEEP** indicator (P.23)
- ⑫ **MEMORY** indicator (P.18)
- ⑬ **TUNED** indicator (P.17)
- ⑭ **REP S/F** (repeat single/full) indicator (P.16)
- ⑮ **RANDOM** indicator (P.15)
- ⑯ **B. BOOST** (Bass boost) indicator (P.13)
- ⑰ **TONE** indicator (P.13)

Remote control

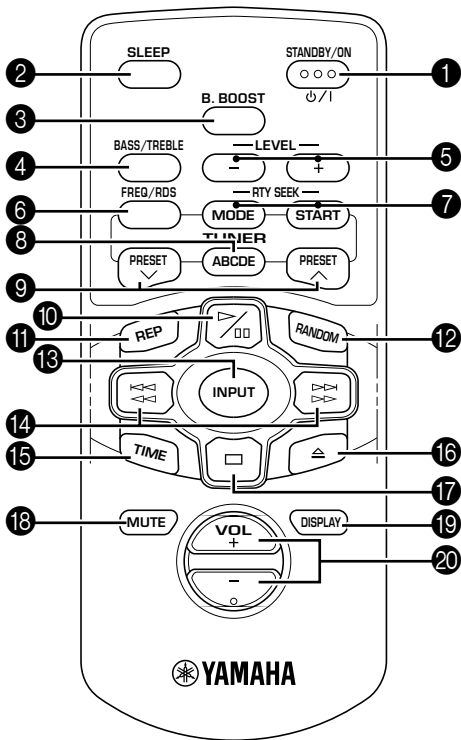

- ❶ STANDBY/ON (P.13)
- ❷ SLEEP (P.23)
- ❸ B. BOOST (Bass boost) (P.13)
- ❹ BASS/TREBLE (P.13)
- ❺ LEVEL +/- (P.13)
- ❻ FREQ/RDS (P.19)
- ❼ PTY SEEK MODE/START (P.20, 21)
- ❽ A/B/C/D/E (P.18)
- ❾ PRESET v/v^ (P.18)
- ❿ >/|| (Play/Pause) (P.14)
- ⓫ REP (Repeat) (P.16)
- ⓬ RANDOM (Random) (P.15)
- ⓭ INPUT (P.13)
- ⓮ <<</>>> (P.14)
- ⓯ TIME (P.15)
- ⓰ △ (Open/Close) (P.14)
- ⓱ □ (Stop) (P.14)
- ⓲ MUTE (P.13)
- ⓳ DISPLAY (P.12, 22)
- ⓴ VOL (Volume) +/- (P.13)

Connections

Never plug the AC power cord into the wall outlet until all connections are completed.

Follow the steps as shown below to connect the system using the supplied cables and accessories.

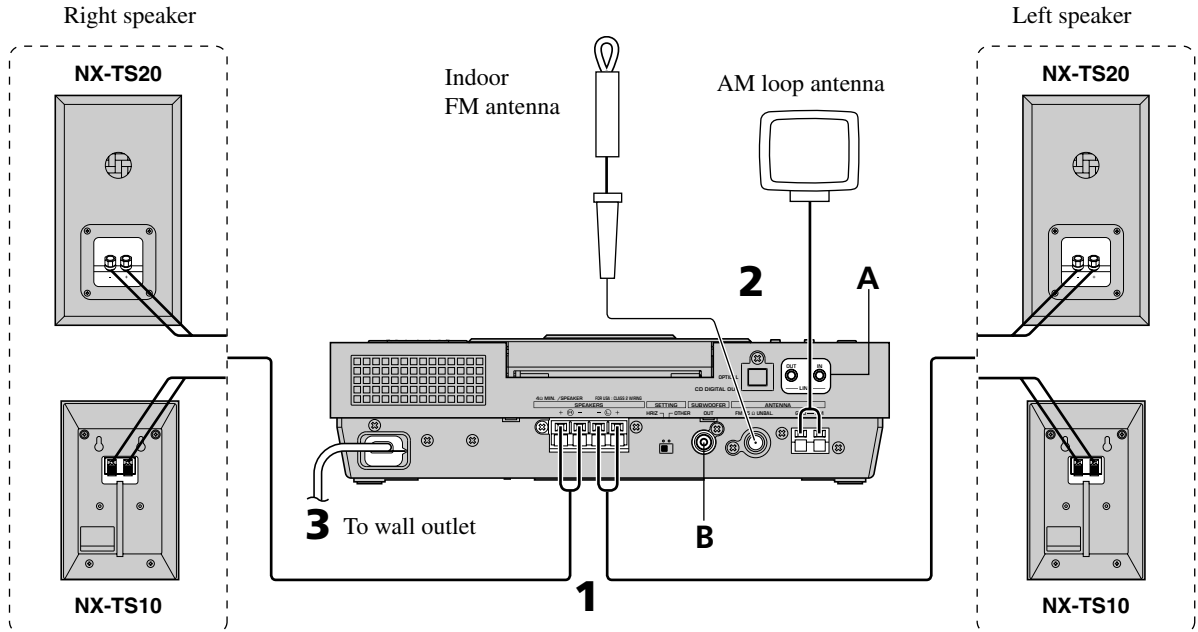

1 Connecting speakers

Connect the speakers to the **SPEAKERS** terminals of the main unit by using the speaker cables. Make sure that the polarity of the speaker cables is correct, i.e. the + and – markings are observed. If these cables are reversed, the sound will be unnatural and lack bass.

On the main unit

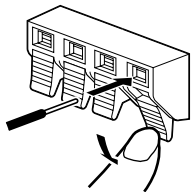

Red: positive (+)
Black: negative (-)

- ① Press the tab.
- ② Remove approx. 10 mm (3/8") of insulation from each of the speaker cables and insert the bare wire into the terminal.
- ③ Release the tab and secure the cable.

On the speakers (NX-TS10)

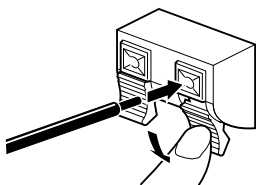

On the speakers (NX-TS20)

Red: positive (+)
Black: negative (-)

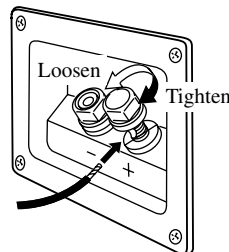

- ① Unscrew the knob.
- ② Remove approx. 10 mm (3/8") of insulation from each of the speaker cables and insert the bare wire into the terminal.
- ③ Tighten the knob to secure the cable.

Caution

Do not let the bare speaker wires touch each other as this could damage the main unit and/or speakers.

2 Connecting antennas

AM loop antenna

Set up the AM loop antenna, then connect it.

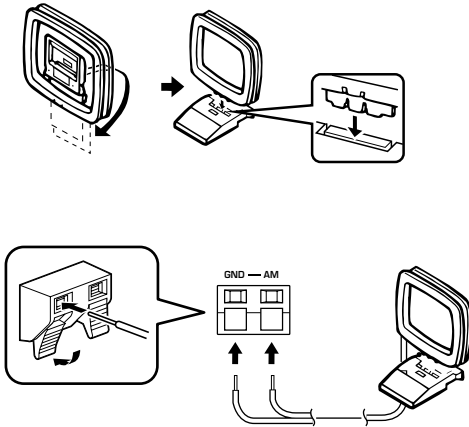

Indoor FM antenna

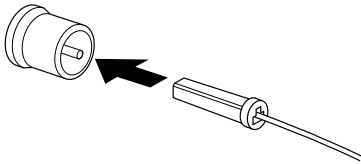

Notes

- Use external FM/AM antennas if you need better reception. Consult your dealer.
- The AM loop antenna should be placed apart from the main unit. The antenna may be hung on a wall.

To enhance your system

A. To connect a Subwoofer (optional)

You can reinforce the bass frequencies by adding a subwoofer (optional).

Connect the **SUBWOOFER OUT** terminal of the main unit to the **INPUT** terminal of the subwoofer.

B. To connect an external component

- An external audio/video component can be connected to the **LINE OUT** (output) and/or **IN** (input) mini-jack terminals of the main unit.
- Digital-to-digital recording is possible from a CD played on this system to an MD (or tape) on an external MD (or DAT) recorder by connecting the **CD DIGITAL OUT (OPTICAL)** terminal on the rear of the main unit to the MD (or DAT) recorder.

3 Connecting to the wall outlet

After all connections are finished, connect the AC power cord to a wall outlet.

Installation

You can install this system in various ways to fit neatly into your listening room (Except for the NX-TS20 speakers).

■ Mounting the system on the wall

* The supplied paper pattern helps you to align the main unit with the speakers properly.

1 Attach the bracket on the main unit with the screws.

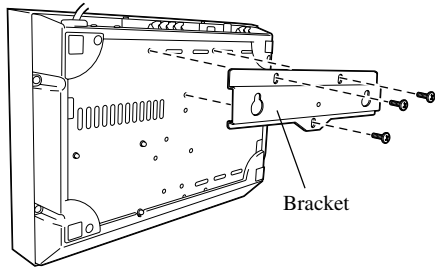

2 Mark where to fasten the screws on the wall using the paper pattern.

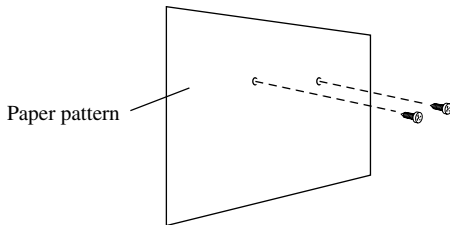

- Wall mounting screws are not supplied with this system. Use screws suitable for the wall material. Also, select the screws of appropriate size for the holes' size as illustrated below.

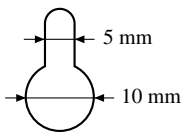

3 Drive the screws into the wall.

4 Hang the main unit and/or the speakers using the holes on the back on the protruding screws.

* Make sure that the screws securely connect with the narrow parts of the holes.

Main unit

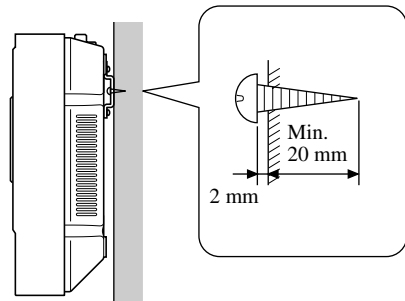

Speaker

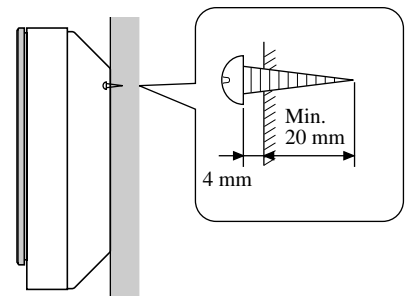

Important

- To avoid dropping and possible injury, be extremely careful when mounting the system on the wall.
- Check if the wall is strong enough to carry the weight of the unit (refer to the "Specifications" page). When in doubt, consult qualified service personnel.
- Confirm that all screws are fastened tightly and the wall mounting screws are properly fitted into the holes of the bracket and the speakers.
- To avoid accidents resulting from tripping over loose speaker cables, fix them to the wall.
- YAMAHA shall not be liable for any accident caused by improper installation.

■ Standing the main unit and/or speakers on a surface

You can stand the main unit and/or the speakers on a hard surface at an angle of 45 degrees or 70 degrees using the supplied stands.

- 1 Peel off the seals of the non-slip pads and apply them to the bottom of the main unit and the stands.

Main unit

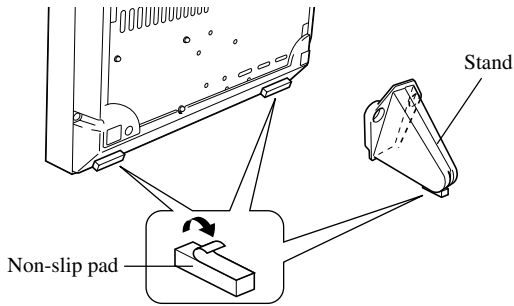

- *The standing angle can be selected as 45 or 70 degrees by attaching the stands upside-down.

70 degrees

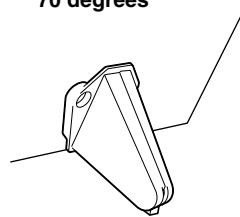

45 degrees

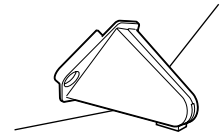

- 2 Attach the stand to the main unit and/or the speakers with the screws.

Main unit

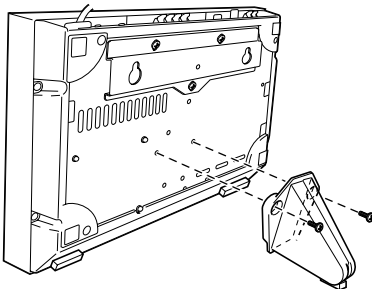

Speaker

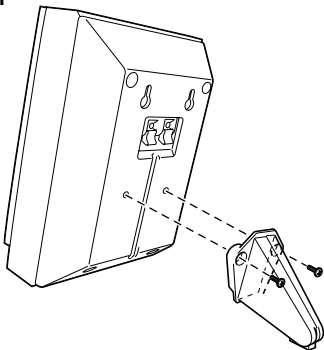

- 3 Fine adjustment can be made by sliding the position of a screw within a rectangular hole so that you can align the main unit and the speakers.

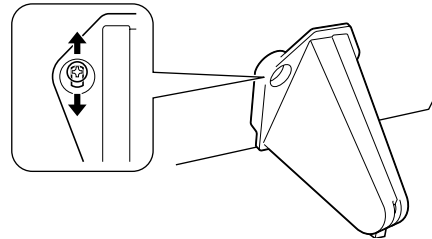

Note

Change the setting of the remote control sensor switch so that the main unit can receive the remote control signal properly;

- When the switch is set to the **HRIZ** position, the sensor **A** is active.
- When the switch is set to the **OTHER** position, the sensor **B** is active.

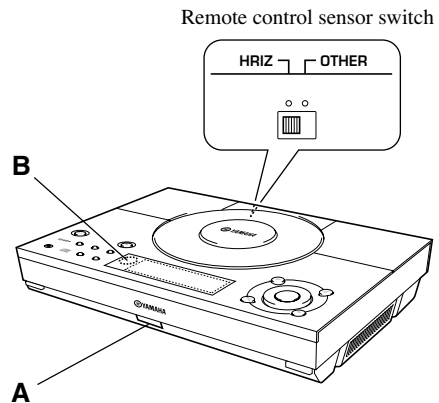

■ Removing the front cover of the speakers

The front cover is fastened to the enclosure at four points and can be removed if desired. To remove the cover, hold on to both sides and slowly pull straight away from the speaker. To reattach, line up the four holes on the inner surface of the cover with the four corresponding pegs on the speaker and push gently.

Note

When the cover is removed, be sure not to touch the speaker units with your hands or to exert excessive force on them.

NX-TS20

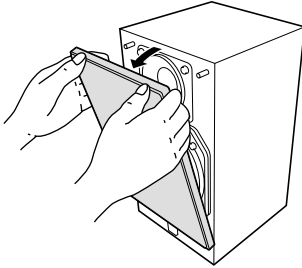

NX-TS10

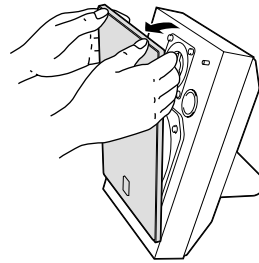

CD preventive care

- This compact disc player is designed for use with the following types of discs only. Never attempt to load any other type of disc into the unit. The unit can also play 8-cm (3-inch) compact discs.



- Be sure to use only CD-R and CD-RW discs made by reliable manufacturers.
- Compact discs are not subjected to wear during play, but damage to the disc surface when the disc is being handled can adversely affect disc play.
- Do not use cleaning discs or warped discs. All of these could damage the unit.

To prevent malfunction of this unit

- Do not use any non-standard shaped CD (heart, etc.) available on the market, because it may damage the unit.

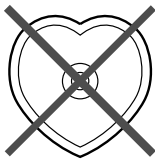

- Do not use a CD with tape, seals, or paste on it, because damage to the unit may result.

- Compact discs are not affected by small particles of dust or fingerprints on their playing surface, but even so they should be kept clean. Wipe by using a clean, dry cloth. Do not wipe with a circular motion; wipe straight outward from the center.

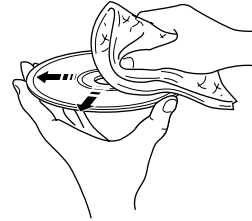

- Do not try to clean the disc's surface by using any type of disc cleaner, record spray, antistatic spray or liquid, or any other chemical-based liquid, because such substances might irreparably damage the disc's surface.
- Do not expose discs to direct sunlight, high temperature or high humidity for a long period of time, because these might warp or otherwise damage the disc.

No!



Remote control

■ Loading the battery for the remote control

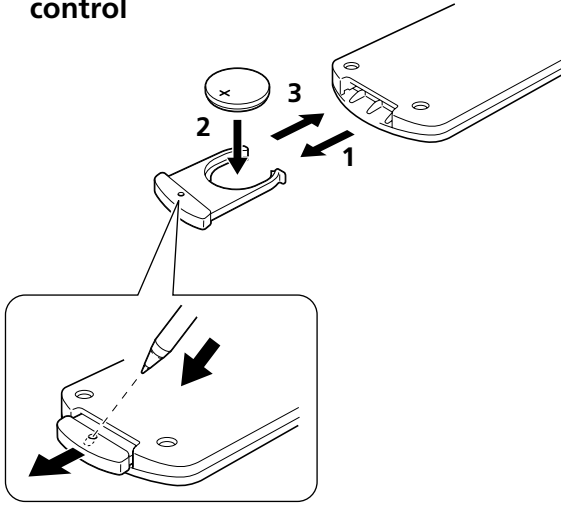

- 1 Slide out the battery holder from the remote control by pushing into the hole in the holder with a ball-point pen, etc.
- 2 Place the battery in the holder, positive side upward.
- 3 Slide the holder into the remote control.

■ Battery replacement

If you find that the remote control must be used closer to the main unit than usual, the battery is weak. Replace the battery with new one.

■ Notes on the lithium battery

Please take care when using the lithium battery as it may explode if mistreated.

- Never abuse or disassemble the battery.
- Be sure the battery polarity is correct. If it is not installed correctly, it may cause fire or explosion.
- Avoid placing the lithium battery and also the remote control with the battery installed, in high temperature such as direct sunlight.
- Do not recharge the battery.
- When replacing the battery, make sure to only use a CR2025 battery.
- Keep the battery out of reach of children. If swallowed, get immediate medical help.
- When disposing of the battery, insulate it with tape, etc. Never dispose of it in fire. Also, dispose of the battery according to local regulations.
- If the battery leaks, dispose of it immediately. Avoid touching the leaked material or letting it come in contact with clothing, etc. Skin contact may cause burn. If it occurs, wash with water promptly and get medical attention.

■ Remote control operation range

When the unit is hung on the wall, or installed with the stands, set the remote control sensor switch to the **OTHER** position. When using the unit installed horizontally, set the switch to the **HRIZ** position.

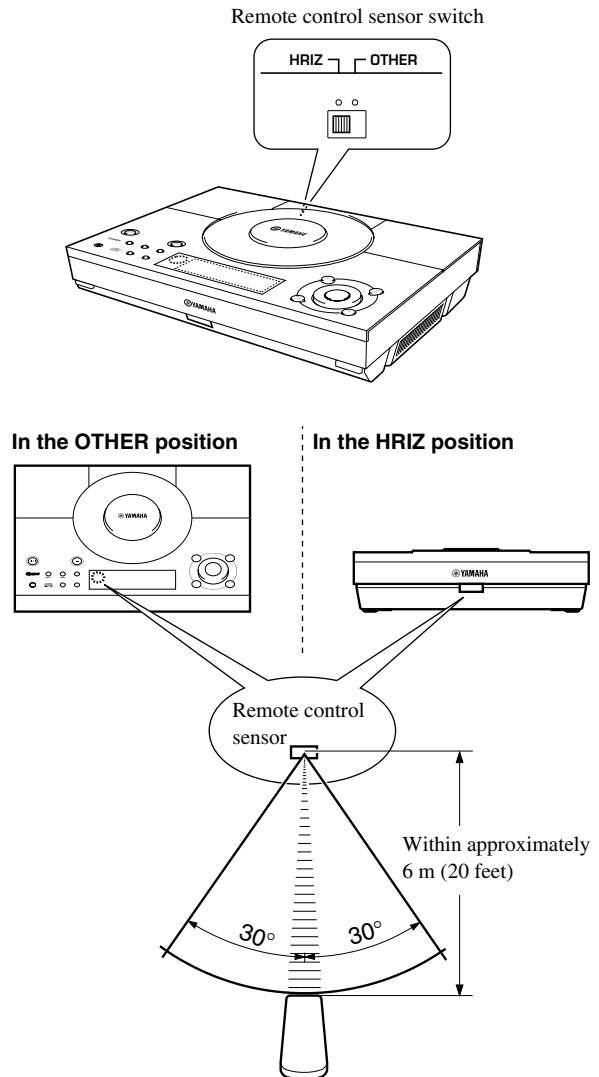

Notes

- There should be no large obstacles between the remote control and the main unit.
- If the remote control sensor is directly illuminated by strong lighting (especially an inverter type of fluorescent lamp, etc.), it might cause the remote control not to work correctly. In this case, reposition the main unit to avoid direct lighting.
- If you install the unit horizontally and operate with the remote control from a higher position than the unit, setting the remote control sensor switch to **OTHER** may improve the response.

Setting the clock

You must set the clock before you use the timer functions. The clock is based on the 12-hour system for U.S.A. and Canada models, and the 24-hour system for Europe, U.K., Australia and China models.

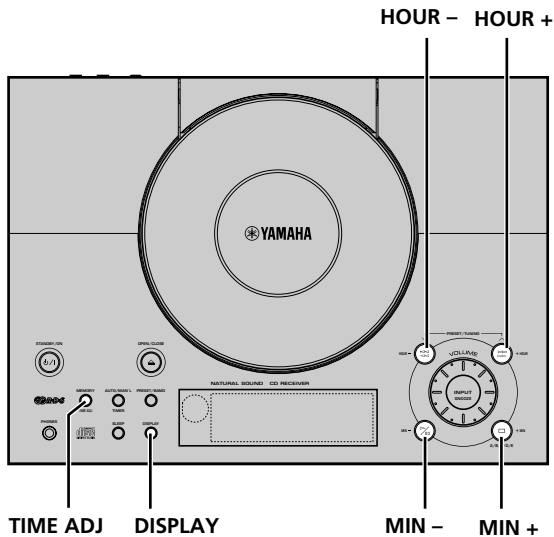

- 1** While the power is on, press **DISPLAY** to display the time.
- 2** While holding **TIME ADJ**, press **HOUR +** to set the hour.
 - If you want to move the time in the reverse direction, press **HOUR -** while holding **TIME ADJ**.
- 3** While holding **TIME ADJ**, press **MIN +** to set the minutes.
 - If you want to move the time in the reverse direction, press **MIN -** while holding **TIME ADJ**.

To display the clock

Press **DISPLAY**.

First “Clock Time” appears and then the current time is displayed for about 8 seconds. Then the normal display returns.

Note

- In the event of a power failure or when the AC power cord is disconnected for more than five minutes, “Set Clock” may appear on the display instead of the current time. In that case, you need to reset the clock.

Adjusting the brightness of the display

You can adjust the brightness of the display not only when the unit is turned on but also in the standby mode. The adjustment can be made individually.

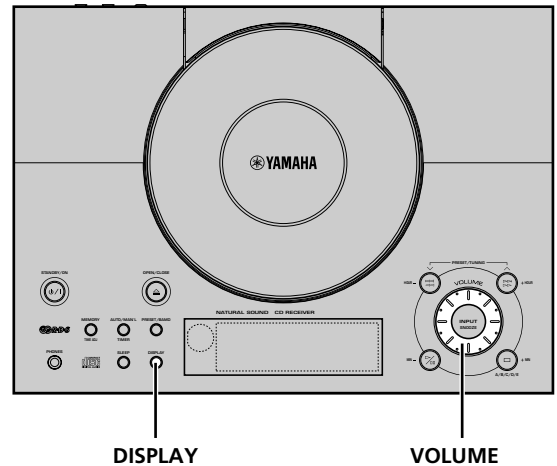

Press and hold **DISPLAY** for about two seconds so that “Dimmer ±0” appears on the display. While holding **DISPLAY**, turn **VOLUME** clockwise to increase or counterclockwise to decrease brightness.

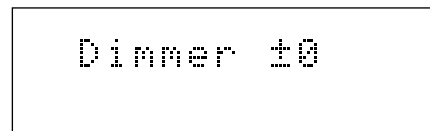

Control Range: ±0 to -6 (Preset value: ±0)

Note

- During the standby mode, the display is not as bright as the one when the unit is on. You can further decrease the brightness in the standby mode so that the light does not disturb in a dark ambience.

This chapter explains the basic operations common to tuning, playing CDs and other connected components.

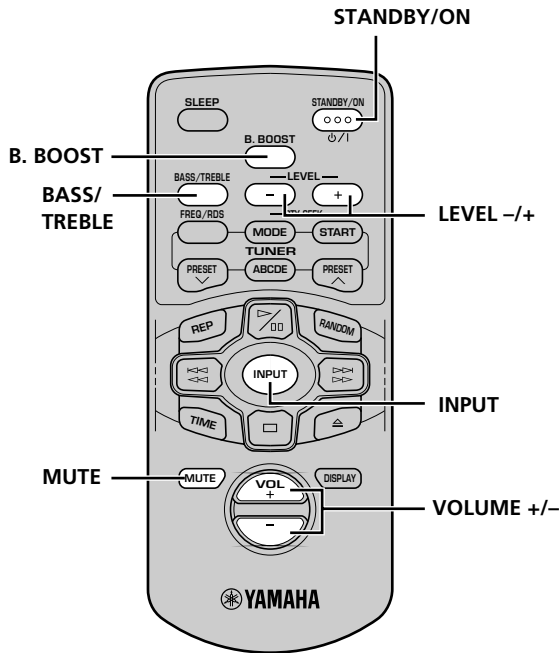
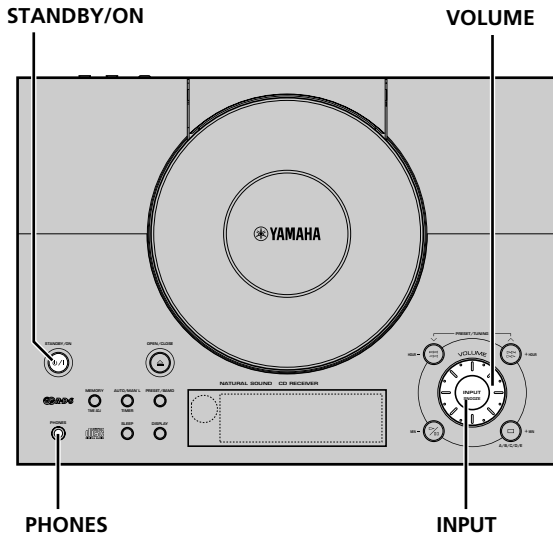

- 1** Turn on the power by pressing **STANDBY/ON**.
- 2** Select the desired input source by pressing **INPUT** repeatedly until the source appears on the display.
 - When you operate the component connected to the **LINE IN** terminal, select AUX.
- 3** Play the source. (Refer to the instructions of each selected component.)
- 4** Adjust the volume level by turning **VOLUME** on the main unit or pressing **VOLUME +/-** on the remote control.

■ Sound controls

You can perform various sound controls using the remote control. These controls and **VOLUME** adjustment have no effect on the material being recorded with the component connected to the **LINE OUT** terminal.

MUTE:

You can mute the sound.

Press **MUTE**.

- “Mute” appears on the display.

Pressing the button again cancels this feature.

BASS/TREBLE:

You can adjust the level of low frequency response (**BASS**) and high frequency response (**TREBLE**).

- 1** Press **BASS/TREBLE** repeatedly until “BASS $\pm 0\text{dB}$ ” or “TREBLE $\pm 0\text{dB}$ ” appears on the display.

- 2** Press **LEVEL +/-** to adjust the level.

The value increases or decreases in steps of 2 dB.

Control range: -10dB to $+10\text{dB}$ (Preset value: $\pm 0\text{dB}$)

B. BOOST (Bass boost):

You can reinforce the bass frequency response.

Press **B.BOOST**.

- The “B.BOOST” indicator lights up on the display.

Pressing the button again cancels this feature.

■ When you use headphones

Connect the headphones to the **PHONES** jack. You can listen to the sound to be output from the speakers through the headphones.

■ When you have finished using this unit

Press **STANDBY/ON** to set this unit to the standby mode.

- The brightness of the display decreases.

CD play

Never touch or look directly at the laser pickup lens when the cover is open.

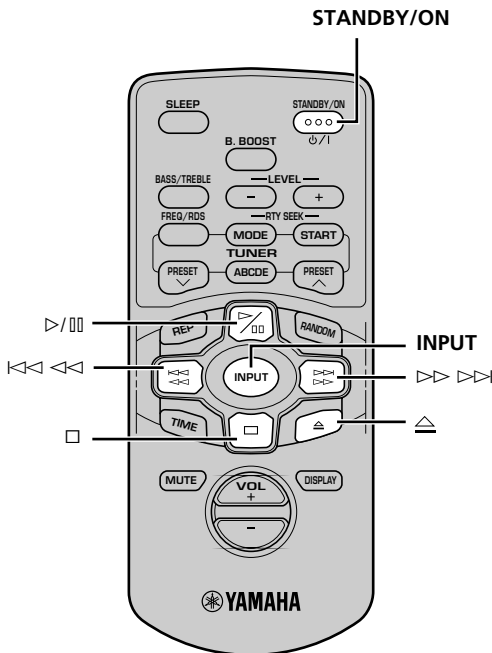
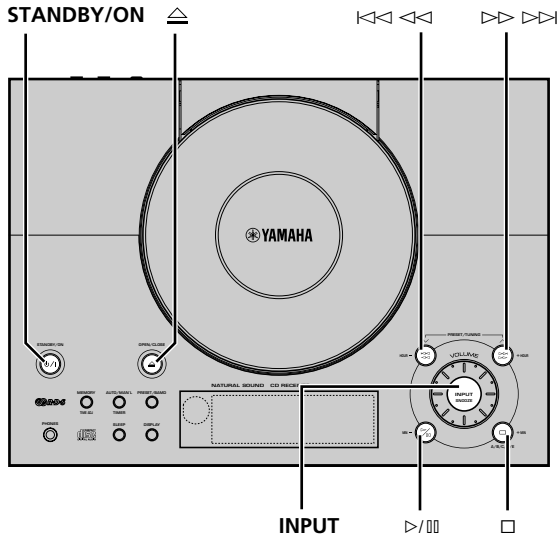

To play CDs

- 1 Press **STANDBY/ON** to turn on this unit.
- 2 Press **INPUT** repeatedly until "CD" appears on the display.

- 3 Press **△** to open the cover, and place a CD with the label side upward on the CD holder.

* Press down the CD until the holder clicks.

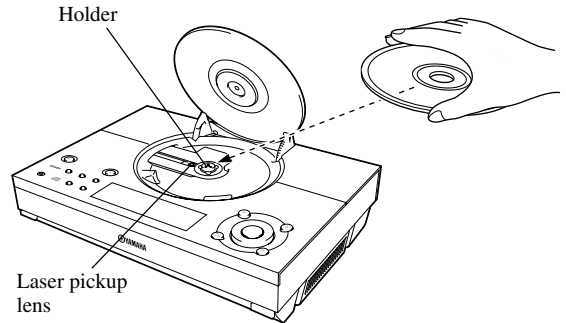

- 4 Press **△** to close the cover.

- 5 Press **>/||** to start play.
This unit starts play.

To pause play

Press **>/||**.

To resume play, press **>/||** again.

To stop play

Press **□**.

To remove the CD

Press **△** to open the cover, and remove the CD from the holder.

To play a specific track on the disc (Skip)

Press **>>>>** to skip forward or **<<<<** to skip backward. Press once for each track to be skipped.

Notes

- This operation can also be performed when the unit is in the pause or stop mode.
- During stop mode, if **>>>>** or **<<<<** is pressed, the track number successively changes to higher numbers (or lower numbers).

To advance or reverse playback rapidly (Search)

Press and hold **>>>>** to advance playback rapidly, and **<<<<** to reverse playback rapidly.

Note

- This unit cannot play a CD-R or CD-RW disc unless the disc has been finalized. Please make sure to finalize the disc on the CD recorder before playing it on this unit.

Selecting the time display

You can select any of four time displays by pressing **TIME**.

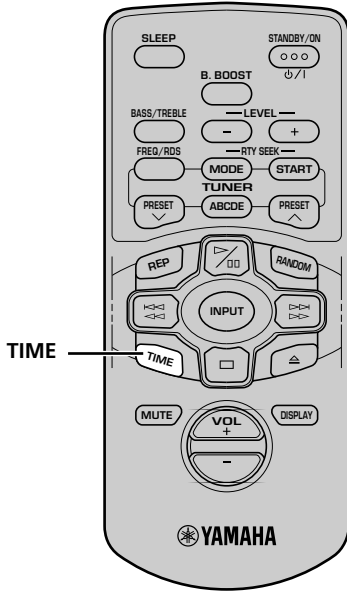

Random-sequence play

The unit can play all the tracks in a random sequence.

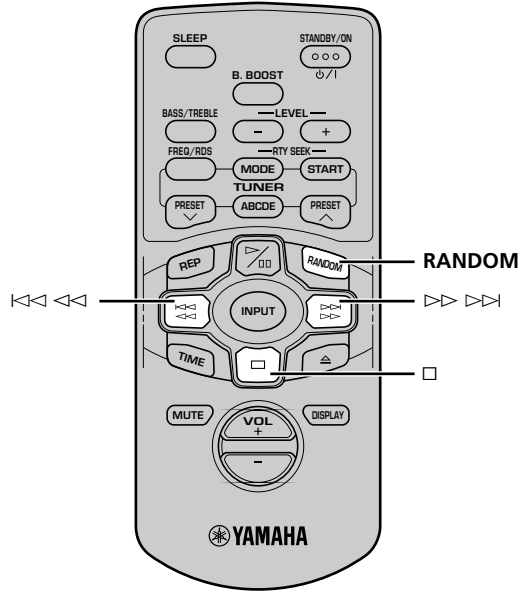

Each time you press **TIME**, the display changes as follows:

Current track number

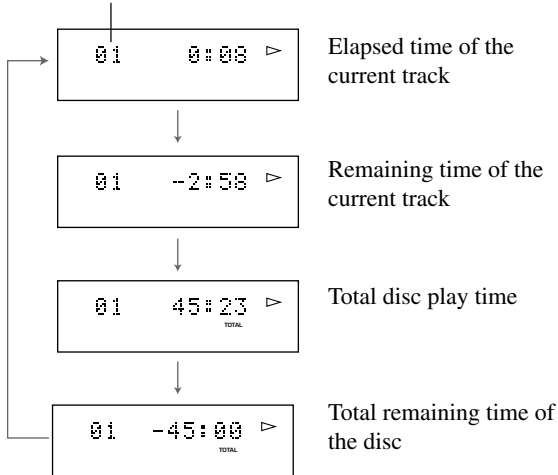

Press **RANDOM**.

- “RANDOM” indicator lights up on the display. The unit starts random sequence play.

To cancel the random-sequence play mode

Press **□** or **RANDOM**.

- “RANDOM” disappears from the display.

Notes

- If ▷▷ ▷▷ is pressed during random-sequence play, the next randomly programmed track will be played. If ◀◀ ◀◀ is pressed, play will return to the beginning of the current track.
- The total remaining time on the disc will not be displayed during random-sequence play.

Repeat play

You can play any desired track or disc repeatedly.
Press **REP** to select the repeat mode.

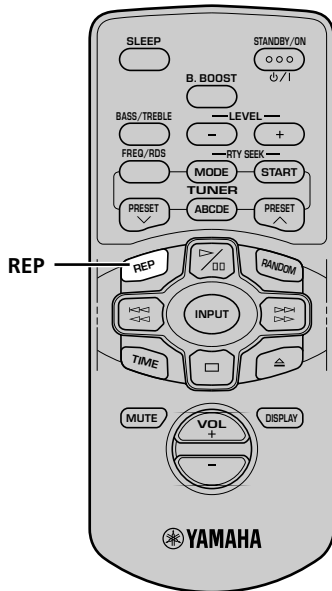

SINGLE REPEAT

The current track is played repeatedly.

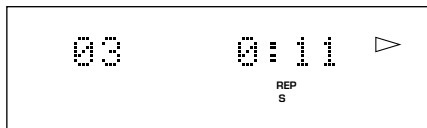

FULL REPEAT

The current disc is played repeatedly.

- In random-sequence play mode, all randomly sequenced tracks are played repeatedly, but each time in different order.

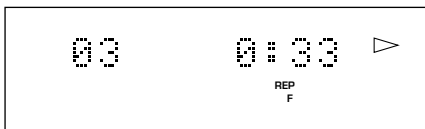

To cancel the repeat play mode

Press **REP** successively until “REP F” disappears from the display.

Listening to the radio

You can find radio stations automatically and manually.

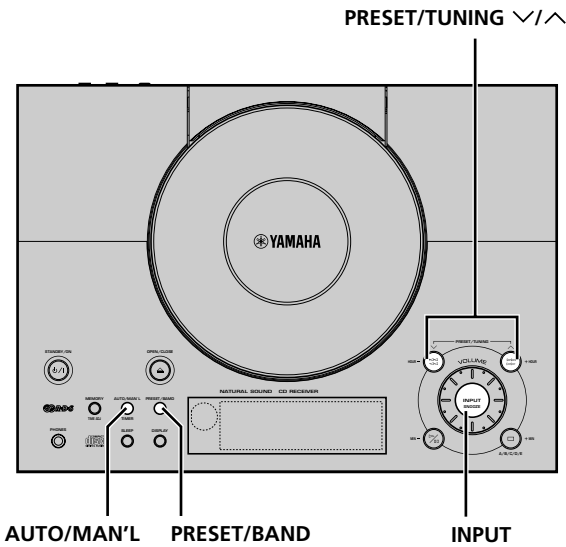

Manual tuning

- 1** Follow steps 1 and 2 described in “Automatic tuning.”
- 2** Press **AUTO/MAN'L** so that “AUTO” disappears from the display.
- 3** Press **PRESET/TUNING** \wedge (for a higher frequency) or \vee (for a lower frequency) to select the desired station.
 - Each time you press **PRESET/TUNING** \wedge or \vee , the frequency changes in small steps.

Automatic tuning

- 1** Select **TUNER** by pressing **INPUT** repeatedly until the frequency of a radio station appears in the display.
- 2** Press **PRESET/BAND** to select the AM or FM reception band. Do not select the preset tuning mode (in which “PRESET” appears on the display).
- 3** Press **AUTO/MAN'L** so that “AUTO” appears in the display.
- 4** Press **PRESET/TUNING** \wedge (for a higher frequency) or \vee (for a lower frequency).
- 5** The unit starts searching for a station.

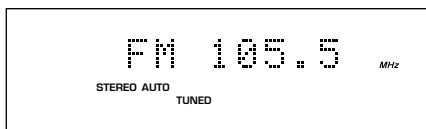

When the unit finds a station, the unit stops searching and “TUNED” appears on the display.

- 6** If the located station is not the one you want, repeat steps 4 and 5 until a station you want is tuned in.

Notes

- If automatic tuning search does not find the desired station, try manual tuning as described next.
- When an FM stereo broadcast with sufficient signal strength is received, “STEREO” appears on the display and you can listen to stereo sound.

Presetting stations

The unit can preset station frequencies selected by Automatic tuning or Manual tuning. Up to 40 stations can be stored. With this function, you can select any desired station by pressing the corresponding preset station number.

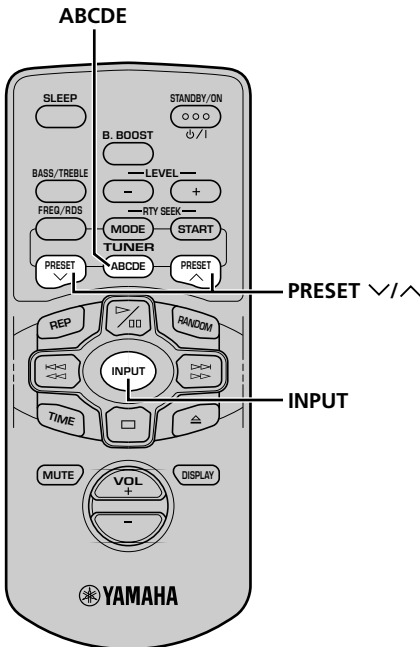
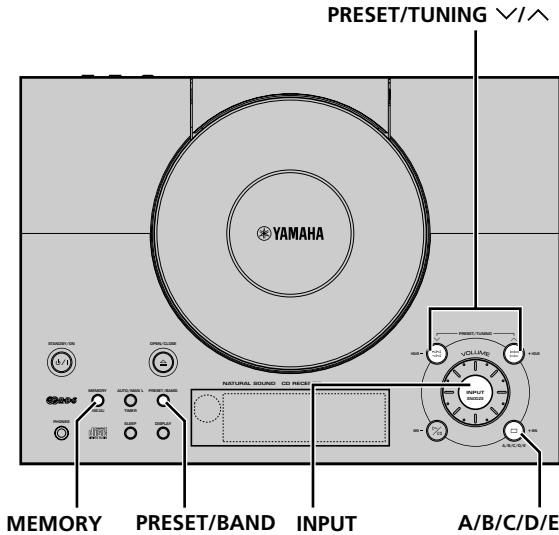

To preset stations manually

- 1** Tune in a desired station.
(Refer to the previous page for the tuning procedure.)
- 2** Press **MEMORY**.
 - “MEMORY” and “PRESET” flash on the display for about 5 seconds.

- 3** Before “MEMORY” goes out, press **A/B/C/D/E** repeatedly to select the desired group (A to E) of preset stations.

- 4** Before “MEMORY” goes out, use **PRESET/TUNING \vee/\wedge** to select a desired preset number (1 to 8).

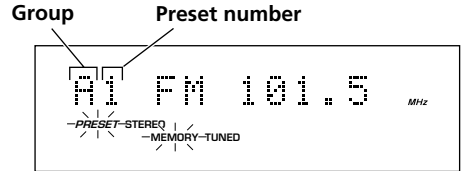

- 5** Press **MEMORY**.
 - “MEMORY”, “PRESET”, and the preset number appears on the display.

The arrow appears for one second when the displayed station is preset successfully.

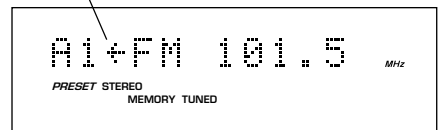

- 6** Repeat steps 1 to 5 until all desired stations are preset.

Notes

- A new station can be preset in place of a previous one.
- The preset stations are retained for a week after you disconnect the AC power cord or if a power failure occurs.

To preset stations automatically

- 1** Select TUNER as the input source by pressing **INPUT**.
- 2** Press **MEMORY** for about 2 seconds.
 - The unit starts presetting stations, “AUTO” and “MEMORY” flash on the display.

Received stations are stored to A1, A2...A8 sequentially. After 40 stations or all FM and AM stations are stored, the display will show the station preset on A1.

To recall a preset station

- 1** Select TUNER as the input source.
- 2** If “PRESET” is not lit on the display, press **PRESET/BAND** to light it.
- 3** Select the desired preset station number by using **A/B/C/D/E** and **PRESET/TUNING \vee/\wedge** on the main unit (or **ABCDE** and **PRESET \vee/\wedge** on the remote control).

Receiving RDS data

RDS (Radio Data System) is a data transmission system used by FM stations in many countries. Stations using this system transmit an inaudible stream of data in addition to the normal radio signal. RDS data contains various types of information, such as PS (Program Service), PTY (Program Type), RT (Radio Text), and CT (Clock Time).

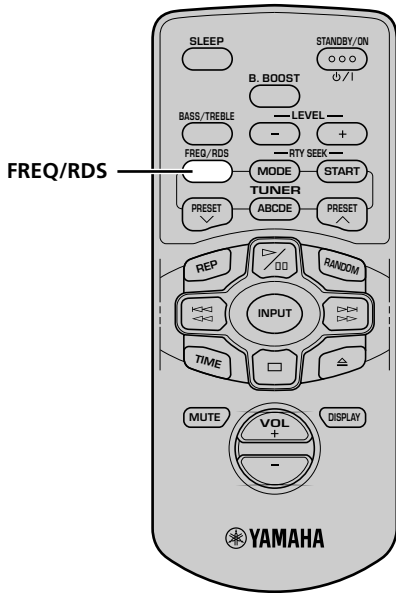

- 1** Tune in an FM station broadcasting RDS data. (Refer to page 17 and 18.)
- 2** Press **FREQ/RDS** to choose the mode. Each time you press **FREQ/RDS**, the type changes as follows:

PS

The name of the RDS station being received is displayed.

- If the unit cannot find a station with PS data, the unit stops searching and “NO PS” appears on the display.

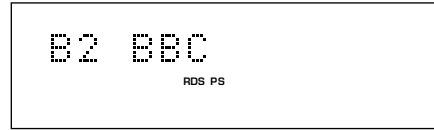

PTY

The program type of the RDS station now being received is displayed. You can make this unit search for a station which is broadcasting programs of a desired program type. (Refer to PTY program mode in the next section for details.)



RT

Information about the program (such as the title of the song, name of the singer, etc.) on the RDS station being received is displayed by a maximum of 64 alphanumeric characters, including the umlaut symbol. If other characters are used by the RT data, they are displayed with an underscore.

- If the unit cannot find a station with RT data, the unit stops searching and “NO RT” appears on the display.

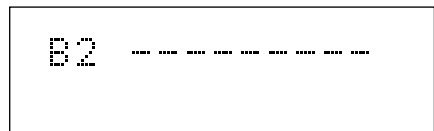

CT

Current time is displayed.

- If the unit cannot find a station with CT data, the unit stops searching and “NO CT” appears on the display.

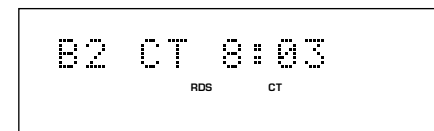

Notes

- RDS may not work properly if the station you have tuned in to is not transmitting the RDS signal properly or if the signal strength is weak.
- Some FM stations do not offer RDS services. Of those that do, not all provide the same types of services. The types provided by the received RDS station are dimmed on the display. Check with your local radio stations for details on available RDS services in your area.

PTY SEEK mode

You can locate a desired station by selecting a program type. The unit searches all preset stations for the type of programs currently being broadcast among the RDS stations.

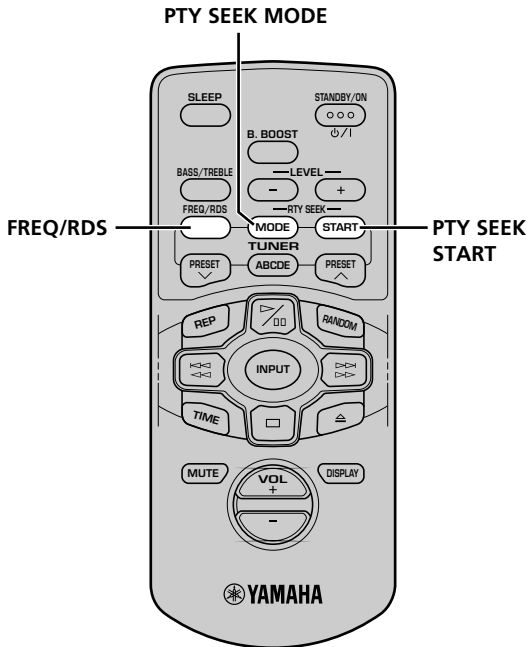

To locate a station

- 1 Tune in an FM station. (Refer to page 17 and 18.)
- 2 Press **PTY SEEK MODE** once so that “PTY” and a PTY program flash on the display.

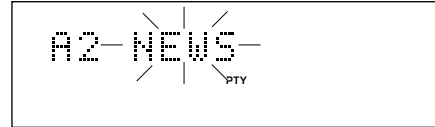

- 3 Within about 20 seconds, press **FREQ/RDS** repeatedly until the desired program type appears on the display.
- 4 Within about 20 seconds, press **PTY SEEK START**.
 - If a station broadcasting the selected program type is found, the unit stops searching and the Program Service name appears on the display. “PTY HOLD” appears on the display.

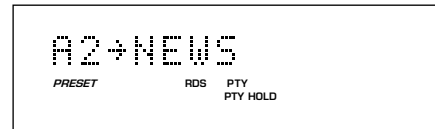

- 5 Repeat step 4 until the desired station is located.
If there is no station broadcasting the program type you select, “NO PTY” appears on the display, then the Program Service name or frequency appears on the display.

List of Program Types

NEWS	News
AFFAIRS	Current Affairs
INFO	General Information
SPORT	Sports
EDUCATE	Education
DRAMA	Drama
CULTURE	Culture
SCIENCE	Science
VARIED	Light Entertainment
POP M	Pops
ROCK M	Rock
M.O.R. M	Middle of the Road Music (Easy-listening)
LIGHT M	Light Classics
CLASSICS	Serious Classics
OTHER M	Other Music

Optional settings for RDS functions

The tuner has the following functions which make use of the RDS data service. These are originally in operation ON. However, you can turn these functions OFF, if so desired.

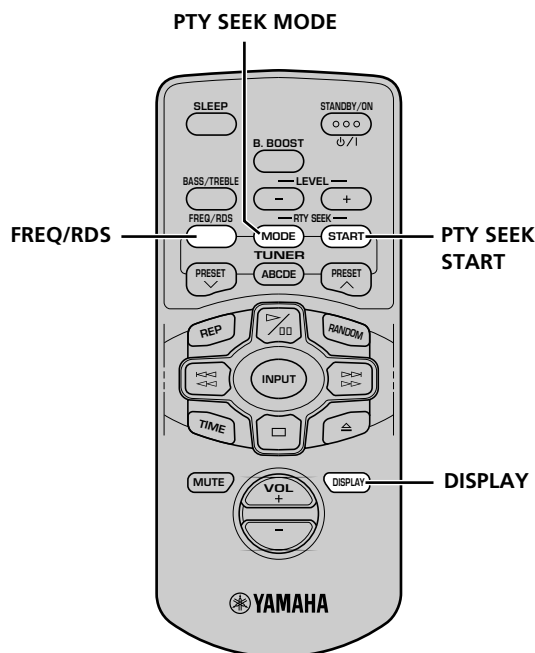

- 1** Select the FM band. (Refer to page 17.)
- 2** Press **DISPLAY** to display the current time.
- 3** Press **FREQ/RDS**.
- 4** Each time you press **PTY SEEK MODE** the display will change as follows:

1. CT → CLOCK (ON/OFF)

The tuner corrects the time of the built-in clock automatically by synchronizing it with the CT data from the RDS station being received.

CT→Clock# ON

- If you receive an RDS station of some other country, the built-in clock is synchronized with the time setting of that country.
- If the built-in clock is not yet set for the current time or was reset due to a power failure, etc., it will be set for the time of the CT data automatically, whether this setting is ON or OFF.

2. LOCAL → CT (ON/OFF)

If the RDS station being received employs the local time (daylight savings time, etc.) data service, its time is displayed in the CT mode.

Local→CT# ON

3. A.M. → RDS (ON/OFF)

RDS stations are searched instead of all FM stations by the automatic preset tuning operation when the setting is ON. (Refer to page 10.)

A.M.→RDS# ON

4. RT SPEED: ±0

Changes the scrolling speed of radio text. Increase the value to increase the speed, and decrease the value to reduce the speed.

RT Speed# ±0

Control Range: ±0 to ±3 (Preset value: ±0)

5 Choose the ON or OFF function by pressing **PTY SEEK START** and confirming it in the display.

Press **PTY SEEK START** repeatedly to change the value for RT SPEED.

- If there is no operation for about 20 seconds, this mode is cancelled and the frequency display returns. If the station is broadcasting PS data, it switches to the PS mode.

6 Press **FREQ/RDS** again to restore the frequency display mode.

Timer play

By using the built-in timer, you can have the unit turn on at a specified time and begin playing automatically. You can also specify the turn off time.

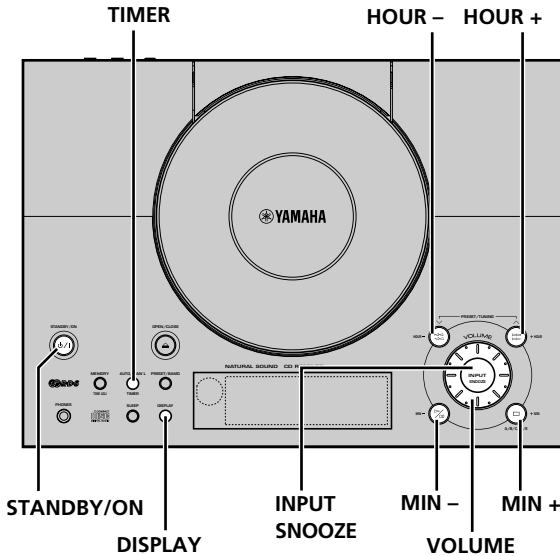

1 Press **DISPLAY**.

Whenever **DISPLAY** is pressed, the display mode changes as follows:

1. Clock Time (TIMER on/off mode)
If you have not set the clock yet, "Set Clock" appears. You need to set the current time as described on page 12.

2. Timer Input
Select the source to be played by pressing **INPUT**.

- When you select TUNER, you can select the desired preset station.
⇨ Use **PRESET/BAND, A/B/C/D/E** and **PRESET/TUNING** \vee/\wedge on the main unit or **PRESET** \vee/\wedge and **ABCDE** on the remote control to select the station.
- When you select CD, the following display appears. You can specify the desired track you want to start playing and set the repeat and/or random-sequence mode.

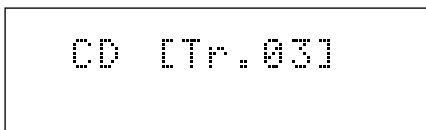

- ⇨ Use \lll, \lll, \ggg, \ggg to specify the track.
- ⇨ Press **REPEAT** on the remote control to set the repeat mode.
- ⇨ Press **RANDOM** on the remote control to set the random-sequence mode.

3. ON Time
"ON Time" appears on the display for a second, and then changes to the time setting mode.
⇨ Press **HOUR -/+** to set the hour.
⇨ Press **MIN -/+** to set the minute.

4. OFF Time
Set the time the same way as above.
If you set the ON time but not any OFF time, timer play will finish automatically after an hour.

5. Timer Volume
You can specify the desired volume level for the timer play by turning **VOLUME** or pressing **VOLUME +/-** on the remote control.
 - If you adjust this setting during play, the volume of the currently playing material changes so that you can confirm the volume level for the timer play. When the display mode changes, the volume reverts to the original level.

Note

- The display mode will change in about 8 seconds. If the mode is changed before the setting is completed, call up the mode again by pressing **DISPLAY** once or more.

2 Press **TIMER** to complete the timer setting.

- If you press **TIMER** during the "ON Time" or "OFF Time" mode, the system is put in the standby mode and "TIMER" lights up on the display. To continue using the system, press **STANDBY/ON** to turn on this unit.

When timer play starts, the backlight of the volume control starts flashing slowly.

- If TUNER is selected as the timer source, the current time and the frequency of the current station appears on the display.

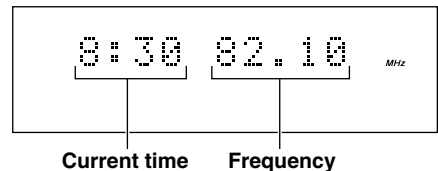

- If CD has been selected as the timer source, the current time and the current track number appears on the display.

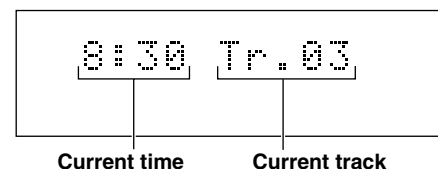

To cancel the timer play setting

Press **DISPLAY** to show the current time, then press **TIMER** so that “TIMER” goes off on the display. You can also cancel by pressing **TIMER** in the standby mode.

Note

- In the event of a power failure or when the AC power cord is disconnected for more than five minutes, “Set Clock” may appear on the display instead of the current time. In that case, you need to reset the clock.

■ Snooze function

With this feature, you can stop the timer play temporarily and resume play automatically in five minutes. When you set the timer play as the alarm, it helps you not to oversleep.

Press **SNOOZE** during timer play.

The current time and “Snooze” turns on and off slowly on the display. Also the backlight of the volume control turns off.

Notes

- Some controls such as ▷ (play), **INPUT**, etc. do not work in the snooze mode.
- If you have selected CD as the input source, the unit resumes from the beginning of the track that was playing when **SNOOZE** was pressed.

Sleep timer

The unit can be turned off automatically at a selected SLEEP time.

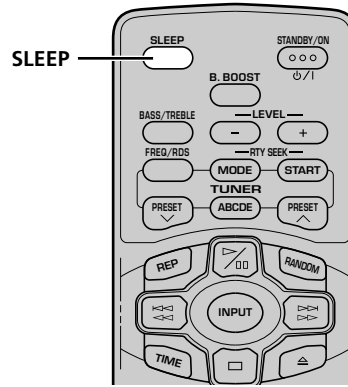

- 1 Play the desired sound source.
- 2 Press **SLEEP** repeatedly until the desired sleep time appears in the display. Each time you press **SLEEP**, the sleep time changes as follows:

SLEEP 2h00m



SLEEP 1h30m



SLEEP 1h00m



SLEEP 0h30m



SLEEP OFF

About 4 seconds after setting, the normal display will resume.

- “SLEEP” will appear in the display.

- 3 The unit will turn off automatically when the selected sleep time is reached.

Notes

- If you press **SLEEP** while the sleep timer is functioning, the remaining time is displayed. Then pressing the button successively changes the sleep time described as above.
- When you have set both the sleep timer and timer play, the unit turns off at the time which comes first (at the designated sleep time or the time set on “4. OFF TIME”).

Troubleshooting

If the unit fails to operate normally, check the following points to determine whether the fault can be corrected by the simple measures suggested. If it cannot be corrected, or if the fault is not listed in the SYMPTOM column, disconnect the power cord and contact your authorized YAMAHA dealer or service center for help.

	SYMPTOM	CAUSE	REMEDY
GENERAL	The main unit does not switch ON when STANDBY/ON is pressed.	The AC power cord is not connected or not completely connected.	Securely connect the power cord.
	No sound from one speaker.	Loose speaker connections.	Connect properly.
	The sound suddenly disappears.	The protection circuit has been activated because of a short circuit, etc.	Check the speaker wires are not touching each other and then turn the main unit back on.
	No sound from an external component connected with the main unit or play does not begin.	Incorrect cord connections.	Connect the cords properly. If the problem persists, the cords may be defective.
		Input source selection is not proper.	Select AUX by pressing the INPUT button.
	Sound distorted.	The external component connected to the LINE IN terminal of the main unit is not turned on.	Turn on the component.
	Cannot set timer.	Current time is not set.	Set current time.
The main unit does not work normally.	The internal microcomputer has been frozen by an external electric shock (lightning, excessive static electricity, etc.) or the power supply voltage is too low.	Unplug the AC power cord from the wall outlet, and then plug in again after about one minute.	
TUNER	Excessive static in FM broadcasts.	Interference from the starting motor of a nearby car.	Position the FM antenna as high and as far away from nearby roads as possible. Connect using a coaxial cable.
		Interference from the thermostat of a nearby electrical appliance.	
	Noise increases during stereo broadcast reception.	Antenna input is too weak due to obstructions or excessive distance from the broadcasting station.	Check the antenna connection. Install a multi-element type FM antenna if possible.
		Stereo broadcasts are noisy and the STEREO indicator blinks on and off.	Insufficient antenna input.
	Cannot select preset stations.	Preset memory has been erased.	Reprogram memory presets.
	Buzzing or static during AM broadcasts.	Interference from sources such as lightning, fluorescent lights, electric motors or the thermostat of nearby electrical appliance.	The problem is difficult to eliminate, but can be lessened by grounding the AM loop antenna.
		A TV or microprocessor is being used nearby.	Move away from the TV or microprocessor.
AM broadcast sensitivity is poor.	Radio signal is weak or the antenna is not properly connected.	Properly connect the AM loop antenna.	
		Change orientation of the AM loop antenna.	
		Install an external AM loop antenna.	

	SYMPTOM	CAUSE	REMEDY
CD PLAYER	Play does not begin.	The disc is damaged.	Check the disc carefully; replace it if necessary.
		There is moisture on the laser pick-up.	Wait 20 to 30 minutes after switching the unit ON before trying to play a disc.
		The disc has been loaded upside down.	Reload the disc with the label side facing up.
		The disc is dirty.	Clean the disc.
	Play is delayed, or begins at the wrong place.	The disc may be scratched or damaged.	Check the disc carefully; replace it if necessary.
	Sound "skips."	The unit is being subjected to vibrations or impacts.	Relocate the unit.
		The disc is dirty.	Clean the disc.
	Sound "hums."	Improper cable connections.	Securely connect the audio cables. If the problem persists, the cables may be defective.
Noise from inside of the unit.	The disc may be warped.	Replace the disc.	
REMOTE CONTROL	The remote control does not work.	The battery of the remote control is too weak.	Replace the battery with a new one.
		Remote control is too far away or is being used at an incorrect angle.	Use within 6 meters and 60 degree radius.
		The active remote control sensor cannot receive the remote control signal.	Change the active remote control sensor to the other one by using the remote control sensor switch.
		Direct sunlight or strong lighting (of an inverter type of fluorescent lamp, etc.) is striking the remote control sensor of the unit.	Change the position of the unit.
	TV functions strangely when the remote control is being used.	The remote control is being used near a TV set with a remote control sensor.	Relocate the main unit away from the TV or cover the TV's remote control sensor.

Specifications

Amplifier section

Minimum RMS output power per channel	18 W +18 W (4Ω 1kHz 10% THD)
DIN Standard output power per channel (Europe model)	-- W + -- W (--Ω 1kHz --% THD)
Input sensitivity/Impedance	
AUX	250 mV/47 kΩ
Frequency Response	-- Hz to -- kHz, ±-- dB
Total Harmonic Distortion (20 Hz to 20 kHz)	
12.5 W, 6 Ω	--%
Signal-to-Noise Ratio (IHF-A Network)	
(250 mV, Input Shorted)	-- dB
Output Level/Impedance	
SUBWOOFER	-- V/-- kΩ
PHONES	-- V/-- Ω

Tuner section

Tuning range	
FM	
[U.S.A. and Canada models]	87.5 – 107.9 MHz
[U.K., Europe, Australia and China models]	87.50 – 108.00 MHz
AM	
[U.S.A., Canada and China models]	530 – 1710 kHz
[U.K., Europe and Australia models]	531 – 1611 kHz
Sensitivity	
FM (IHF, MONO)	
[U.S.A., Canada and China models]	1.5 μV
[U.K., Europe and Australia models]	1.8 μV
AM	
	-- μV/m

CD player section

D/A converter	S-bit DAC
---------------	-----------

Laser Diode Properties

- Material: GaAlAs
- Wavelength: 780 nm
- Emission duration: continuous
- Laser output: max. 44.6 μW*

* This output is the value measured at a distance of about 200 mm from the objective lens surface on the Optical Pick-up Block.

Speaker section

Type	2-way bass-reflex speaker system
	Magnetic shielding type
Driver	
	10 cm cone woofer
	2 cm dome tweeter
Maximum input power	20 Ω
Impedance	4 W
Frequency response	-- -- Hz
Sensitivity	-- dB/2.83V/m

General

Power supply	
[U.S.A. and Canada models]	AC 120 V, 60 Hz
[Australia model]	AC 240 V, 50 Hz
[U.K. and Europe models]	AC 230 V, 50 Hz
[China model]	AC 120 V, 60 Hz
Power consumption	35 W
	In standby mode: 3.0 W
Dimensions (W x H x D)	
CRX-TS10/20	297 x 80 x 214 mm
NX-TS10/15	-- x -- x -- mm
NX-TS20	-- x -- x -- mm
Weight	
CRX-TS10/20	-- kg
NX-TS10/15	-- kg
NX-TS20	-- kg
Accessories	
	Remote control x 1
	Battery (CR2025) x 1
	Indoor FM antenna x 1
	AM loop antenna x 1
	Speaker cable x 2
	Stand x 3
	Mounting bracket x 1
	Non-slip pad x 4
	Screw x 9
	Paper pattern x 1

Specifications are subject to change without notice.