



RX-V461

AV Receiver

OWNER'S MANUAL

Important safety instructions

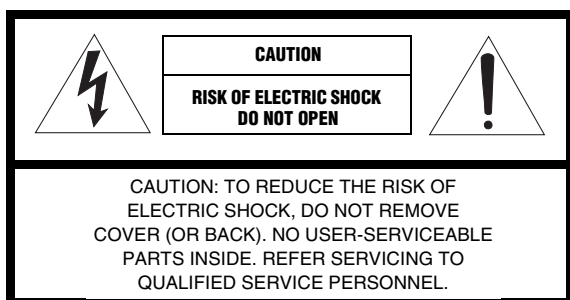

• Explanation of Graphical Symbols



The lightning flash with arrowhead symbol, within an equilateral triangle, is intended to alert you to the presence of uninsulated “dangerous voltage” within the product’s enclosure that may be of sufficient magnitude to constitute a risk of electric shock to persons.



The exclamation point within an equilateral triangle is intended to alert you to the presence of important operating and maintenance (servicing) instructions in the literature accompanying the appliance.

- 1 Read Instructions – All the safety and operating instructions should be read before the product is operated.
- 2 Retain Instructions – The safety and operating instructions should be retained for future reference.
- 3 Heed Warnings – All warnings on the product and in the operating instructions should be adhered to.
- 4 Follow Instructions – All operating and use instructions should be followed.
- 5 Cleaning – Unplug this product from the wall outlet before cleaning. Do not use liquid cleaners or aerosol cleaners.
- 6 Attachments – Do not use attachments not recommended by the product manufacturer as they may cause hazards.
- 7 Water and Moisture – Do not use this product near water – for example, near a bath tub, wash bowl, kitchen sink, or laundry tub; in a wet basement; or near a swimming pool; and the like.
- 8 Accessories – Do not place this product on an unstable cart, stand, tripod, bracket, or table. The product may fall, causing serious injury to a child or adult, and serious damage to the product. Use only with a cart, stand, tripod, bracket, or table recommended by the manufacturer, or sold with the product. Any mounting of the product should follow the manufacturer’s instructions, and should use a mounting accessory recommended by the manufacturer.
- 9 A product and cart combination should be moved with care. Quick stops, excessive force, and uneven surfaces may cause the product and cart combination to overturn.



- 10 Ventilation – Slots and openings in the cabinet are provided for ventilation and to ensure reliable operation of the product and to protect it from overheating, and these openings must not be blocked or covered. The openings should never be blocked by placing the product on a bed, sofa, rug, or other similar surface. This product should not be placed in a built-in installation such as a bookcase or rack unless proper ventilation is provided or the manufacturer’s instructions have been adhered to.
- 11 Power Sources – This product should be operated only from the type of power source indicated on the marking label. If you are not sure of the type of power supply to your home, consult your product dealer or local power company. For products intended to operate from battery power, or other sources, refer to the operating instructions.
- 12 Grounding or Polarization – This product may be equipped with a polarized alternating current line plug (a plug having one blade wider than the other). This plug will fit into the power outlet only one way. This is a safety feature. If you are unable to insert the plug fully into the outlet, try reversing the plug. If the plug should still fail to fit, contact your electrician to replace your obsolete outlet. Do not defeat the safety purpose of the polarized plug.
- 13 Power-Cord Protection – Power-supply cords should be routed so that they are not likely to be walked on or pinched by items placed upon or against them, paying particular attention to cords at plugs, convenience receptacles, and the point where they exit from the product.
- 14 Lightning – For added protection for this product during a lightning storm, or when it is left unattended and unused for long periods of time, unplug it from the wall outlet and disconnect the antenna or cable system. This will prevent damage to the product due to lightning and power-line surges.
- 15 Power Lines – An outside antenna system should not be located in the vicinity of overhead power lines or other electric light or power circuits, or where it can fall into such power lines or circuits. When installing an outside antenna system, extreme care should be taken to keep from touching such power lines or circuits as contact with them might be fatal.
- 16 Overloading – Do not overload wall outlets, extension cords, or integral convenience receptacles as this can result in a risk of fire or electric shock.
- 17 Object and Liquid Entry – Never push objects of any kind into this product through openings as they may touch dangerous voltage points or short-out parts that could result in a fire or electric shock. Never spill liquid of any kind on the product.
- 18 Servicing – Do not attempt to service this product yourself as opening or removing covers may expose you to dangerous voltage or other hazards. Refer all servicing to qualified service personnel.
- 19 Damage Requiring Service – Unplug this product from the wall outlet and refer servicing to qualified service personnel under the following conditions:
 - a) When the power-supply cord or plug is damaged,
 - b) If liquid has been spilled, or objects have fallen into the product,
 - c) If the product has been exposed to rain or water,

- d) If the product does not operate normally by following the operating instructions. Adjust only those controls that are covered by the operating instructions as an improper adjustment of other controls may result in damage and will often require extensive work by a qualified technician to restore the product to its normal operation,
 - e) If the product has been dropped or damaged in any way, and
 - f) When the product exhibits a distinct change in performance - this indicates a need for service.
- 20 Replacement Parts** – When replacement parts are required, be sure the service technician has used replacement parts specified by the manufacturer or have the same characteristics as the original part. Unauthorized substitutions may result in fire, electric shock, or other hazards.
- 21 Safety Check** – Upon completion of any service or repairs to this product, ask the service technician to perform safety checks to determine that the product is in proper operating condition.
- 22 Wall or Ceiling Mounting** – The unit should be mounted to a wall or ceiling only as recommended by the manufacturer.
- 23 Heat** – The product should be situated away from heat sources such as radiators, heat registers, stoves, or other products (including amplifiers) that produce heat.

- 24 Outdoor Antenna Grounding** – If an outside antenna or cable system is connected to the product, be sure the antenna or cable system is grounded so as to provide some protection against voltage surges and built-up static charges. Article 810 of the National Electrical Code, ANSI/NFPA 70, provides information with regard to proper grounding of the mast and supporting structure, grounding of the lead-in wire to an antenna discharge unit, size of grounding conductors, location of antenna discharge unit, connection to grounding electrodes, and requirements for the grounding electrode.

EXAMPLE OF ANTENNA GROUNDING

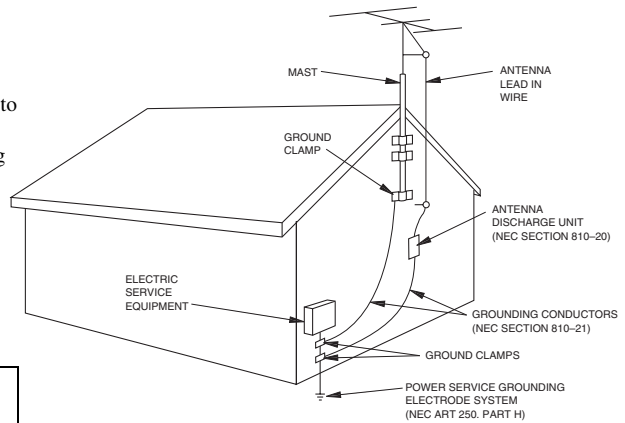

Note to CATV system installer:

This reminder is provided to call the CATV system installer's attention to Article 820-40 of the NEC that provides guidelines for proper grounding and, in particular, specifies that the cable ground shall be connected to the grounding system of the building, as close to the point of cable entry as practical.

FCC INFORMATION (for US customers)

1 IMPORTANT NOTICE: DO NOT MODIFY THIS UNIT!

This product, when installed as indicated in the instructions contained in this manual, meets FCC requirements. Modifications not expressly approved by Yamaha may void your authority, granted by the FCC, to use the product.

- 2 IMPORTANT:** When connecting this product to accessories and/or another product use only high quality shielded cables. Cable/s supplied with this product **MUST** be used. Follow all installation instructions. Failure to follow instructions could void your FCC authorization to use this product in the USA.

- 3 NOTE:** This product has been tested and found to comply with the requirements listed in FCC Regulations, Part 15 for Class "B" digital devices. Compliance with these requirements provides a reasonable level of assurance that your use of this product in a residential environment will not result in harmful interference with other electronic devices.

This equipment generates/uses radio frequencies and, if not installed and used according to the instructions found in the users manual, may cause interference harmful to the operation of other electronic devices.

Compliance with FCC regulations does not guarantee that interference will not occur in all installations. If this product is found to be the source of interference, which can be determined by turning the unit "OFF" and "ON", please try to eliminate the problem by using one of the following measures:

Relocate either this product or the device that is being affected by the interference.

Utilize power outlets that are on different branch (circuit breaker or fuse) circuits or install AC line filter/s.

In the case of radio or TV interference, relocate/reorient the antenna. If the antenna lead-in is 300 ohm ribbon lead, change the lead-in to coaxial type cable.

If these corrective measures do not produce satisfactory results, please contact the local retailer authorized to distribute this type of product. If you can not locate the appropriate retailer, please contact Yamaha Electronics Corp., U.S.A. 6660 Orangethorpe Ave., Buena Park, CA 90620.

The above statements apply **ONLY** to those products distributed by Yamaha Corporation of America or its subsidiaries.

Caution: Read this before operating your unit.

- 1 To assure the finest performance, please read this manual carefully. Keep it in a safe place for future reference.
- 2 Install this sound system in a well ventilated, cool, dry, clean place – away from direct sunlight, heat sources, vibration, dust, moisture, and/or cold. Allow ventilation space of at least 30 cm on the top, 20 cm on the left and right, and 20 cm on the back of this unit.
- 3 Locate this unit away from other electrical appliances, motors, or transformers to avoid humming sounds.
- 4 Do not expose this unit to sudden temperature changes from cold to hot, and do not locate this unit in an environment with high humidity (i.e. a room with a humidifier) to prevent condensation inside this unit, which may cause an electrical shock, fire, damage to this unit, and/or personal injury.
- 5 Avoid installing this unit where foreign object may fall onto this unit and/or this unit may be exposed to liquid dripping or splashing. On the top of this unit, do not place:
 - Other components, as they may cause damage and/or discoloration on the surface of this unit.
 - Burning objects (i.e. candles), as they may cause fire, damage to this unit, and/or personal injury.
 - Containers with liquid in them, as they may fall and liquid may cause electrical shock to the user and/or damage to this unit.
- 6 Do not cover this unit with a newspaper, tablecloth, curtain, etc. in order not to obstruct heat radiation. If the temperature inside this unit rises, it may cause fire, damage to this unit, and/or personal injury.
- 7 Do not plug in this unit to a wall outlet until all connections are complete.
- 8 Do not operate this unit upside-down. It may overheat, possibly causing damage.
- 9 Do not use force on switches, knobs and/or cords.
- 10 When disconnecting the power cable from the wall outlet, grasp the plug; do not pull the cord.
- 11 Do not clean this unit with chemical solvents; this might damage the finish. Use a clean, dry cloth.
- 12 Only voltage specified on this unit must be used. Using this unit with a higher voltage than specified is dangerous and may cause fire, damage to this unit, and/or personal injury. Yamaha will not be held responsible for any damage resulting from use of this unit with a voltage other than specified.
- 13 To prevent damage by lightning, keep the power cord and outdoor antennas disconnected from a wall outlet or the unit during a lightning storm.
- 14 Do not attempt to modify or fix this unit. Contact qualified Yamaha service personnel when any service is needed. The cabinet should never be opened for any reasons.
- 15 When not planning to use this unit for long periods of time (i.e. vacation), disconnect the AC power plug from the wall outlet.
- 16 Install this unit near the AC outlet and where the AC power plug can be reached easily.
- 17 Be sure to read the “Troubleshooting” section on common operating errors before concluding that this unit is faulty.
- 18 Before moving this unit, press STANDBY/ON to set this unit in the standby mode, and disconnect the AC power plug from the wall outlet.
- 19 **VOLTAGE SELECTOR** (Asia and General models only)
The VOLTAGE SELECTOR on the rear panel of this unit must be set for your local main voltage BEFORE plugging into the AC wall outlet.
Voltages are 110–120/220–240 V AC, 50/60 Hz.
- 20 The batteries shall not be exposed to excessive heat such as sunshine, fire or like.

WARNING

TO REDUCE THE RISK OF FIRE OR ELECTRIC SHOCK, DO NOT EXPOSE THIS UNIT TO RAIN OR MOISTURE.

This unit is not disconnected from the AC power source as long as it is connected to the wall outlet, even if this unit itself is turned off by STANDBY/ON. This state is called the standby mode. In this state, this unit is designed to consume a very small quantity of power.

FOR CANADIAN CUSTOMERS

To prevent electric shock, match wide blade of plug to wide slot and fully insert.
This Class B digital apparatus complies with Canadian ICES-003.

POUR LES CONSOMMATEURS CANADIENS

Pour éviter les chocs électriques, introduire la lame la plus large de la fiche dans la borne correspondante de la prise et pousser jusqu'au fond.
Cet appareil numérique de la classe B est conforme à la norme NMB-003 du Canada.

IMPORTANT

Please record the serial number of this unit in the space below.

MODEL:

Serial No.:

The serial number is located on the rear of the unit.

Retain this Owner's Manual in a safe place for future reference.

Contents

INTRODUCTION

Features	2
Getting started	3
Quick start guide	4
Preparation: Check the items	4
Step 1: Set up your speakers	5
Step 2: Connect your DVD player and other components.....	6
Step 3: Turn on the power and press SCENE 1 button	8
What do you want to do with this unit?	9

PREPARATION

Connections	10
Rear panel	10
Placing speakers.....	11
Connecting speakers.....	12
Setting the speaker impedance (U.S.A. and Canada models only).....	13
Information on jacks and cable plugs	14
Connecting video components.....	15
Connecting audio components.....	17
Connecting a Yamaha iPod universal dock	18
Using the VIDEO AUX jacks on the front panel	18
Connecting the FM and AM antennas	19
Connecting the power cable.....	19
Turning on and off the power	19
Front panel display	20
Optimizing the speaker setting for your listening room	22
Using AUTO SETUP	22

BASIC OPERATION

Selecting the SCENE templates	26
Selecting the desired SCENE template.....	26
Creating your original SCENE templates.....	29
Playback	30
Basic operations.....	30
Additional operations.....	31
Sound field programs	35
Sound field program descriptions	35
FM/AM tuning	38
Automatic tuning	38
Manual tuning	38
Automatic preset tuning.....	39
Manual preset tuning	39
Selecting preset stations.....	40
Exchanging preset station	40
XM Satellite Radio tuning	41
Connecting the XM Mini-Tuner Dock	41
Activating XM Satellite Radio	42
Basic XM Satellite Radio operations.....	42
Setting XM Satellite Radio preset channels	44
Displaying the XM Satellite Radio information.....	45
Using iPod™	46
Controlling iPod™.....	46
Recording	48

ADVANCED OPERATION

SET MENU	49
Using SET MENU	50
1 SOUND MENU.....	51
2 INPUT MENU.....	55
3 OPTION MENU	57
Remote control features	59
Using remote control on the SCENE feature.....	59
Controlling this unit, a TV, or other components....	60
Setting remote control codes	62
Resetting all remote control codes.....	63
Advanced setup	64

ADDITIONAL INFORMATION

Troubleshooting	65
Glossary	72
Specifications	74
Index	75

APPENDIX

(at the end of this manual)

Front panel	i
Remote control	ii
List of remote control codes	iii

About this manual

- ✎ indicates a tip for your operation.
- Some operations can be performed by using either the buttons on the front panel or the ones on the remote control. In case the button names differ between the front panel and the remote control, the button name on the remote control is given in parentheses.
- This manual is printed prior to production. Design and specifications are subject to change in part as a result of improvements, etc. In case of differences between the manual and product, the product has priority.
- “**Ⓢ** SPEAKERS” or “**Ⓐ** DVD” (example) indicates the name of the parts on the front panel or the remote control. Refer to the attached sheet or the top pages of this manual for the information about each position of the parts.
- The symbol “**☞**” with page number(s) indicates the corresponding reference page(s).

INTRODUCTION

PREPARATION

BASIC
OPERATION

ADVANCED
OPERATION

ADDITIONAL
INFORMATION

APPENDIX

English

Features

Built-in 5-channel power amplifier

- ◆ Minimum RMS output power

[U.S.A. and Canada models]
(1 kHz, 0.9% THD, 8 Ω)

Front: 100 W + 100 W

Center: 100 W

Surround: 100 W + 100 W

[Other models]

(1 kHz, 0.9% THD, 6 Ω)

Front: 100 W + 100 W

Center: 100 W

Surround: 100 W + 100 W

SCENE select function

- ◆ Preset SCENE templates for various situations
- ◆ SCENE template customizing capability

Decoders and DSP circuits

- ◆ Proprietary Yamaha technology for the creation of multi-channel surround sound
- ◆ Compressed Music Enhancer mode to improve the sound quality of compression artifacts (such as the MP3 format) to that of a high-quality stereo
- ◆ Dolby Digital decoder
- ◆ Dolby Pro Logic/Dolby Pro Logic II decoder
- ◆ DTS decoder
- ◆ Neural Surround decoder
(U.S.A. and Canada models only)
- ◆ Virtual CINEMA DSP
- ◆ SILENT CINEMA™

Sophisticated FM/AM tuner

- ◆ 40-station random and direct preset tuning
- ◆ Automatic preset tuning



Manufactured under license from Dolby Laboratories.

“Dolby”, “Pro Logic”, and the double-D symbol are trademarks of Dolby Laboratories.

SILENT™
CINEMA

“SILENT CINEMA” is a trademark of YAMAHA CORPORATION.

iPod™

“iPod” is a trademark of Apple Computer, Inc., registered in the U.S. and other countries.

XM Satellite Radio

(U.S.A. and Canada models only)

- ◆ XM Satellite Radio tuning capability (using the “XM Mini-Tuner Dock” sold separately)
- ◆ Neural Surround decoder to play back the XM HD content of XM Satellite Radio broadcasts in multi-channels, resulting in a full surround sound experience

iPod controlling capability

- ◆ DOCK terminal to connect a Yamaha iPod universal dock (YDS-10, sold separately), which supports iPod (Click and Wheel), iPod nano, and iPod mini
- ◆ Playback information displaying capability
- ◆ Battery charging capability

Other features

- ◆ YPAO (Yamaha Parametric Room Acoustic Optimizer) for automatic speaker setup
- ◆ 192-kHz/24-bit D/A converter
- ◆ Direct Stereo mode for pure hi-fi stereo sound for analog and PCM 2-channel sources
- ◆ 6 additional input jacks for discrete multi-channel input
- ◆ OSD (on-screen display) menus that allow you to optimize this unit to suit your individual audiovisual system
- ◆ Component video input/output capability (3 COMPONENT VIDEO INs and 1 MONITOR OUT)
- ◆ S-video signal input/output capability
- ◆ Optical and coaxial digital audio signal jacks
- ◆ Sleep timer
- ◆ Cinema and music night listening modes
- ◆ Remote control with preset remote control codes



“DTS” and “DTS Digital Surround” are registered trademarks of DTS, Inc.



The XM name and related logos are registered trademarks of XM Satellite Radio Inc.



Neural Surround™ name and related logos are trademarks owned by Neural Audio Corporation.

We Want You Listening For A Lifetime

YAMAHA and the Electronic Industries Association’s Consumer Electronics Group want you to get the most out of your equipment by playing it at a safe level. One that lets the sound come through loud and clear without annoying blaring or distortion – and, most importantly, without affecting your sensitive hearing.

Since hearing damage from loud sounds is often undetectable until it is too late, YAMAHA and the Electronic Industries Association’s Consumer Electronics Group recommend you to avoid prolonged exposure from excessive volume levels.



Getting started

■ Checking the supplied accessories

Check that you received all of the following parts.

Remote control

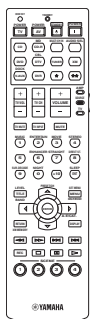

Batteries (2)
(AA, R06, UM-3)

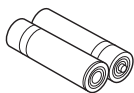

AM loop antenna

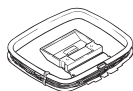

Optimizer
microphone



Indoor FM antenna

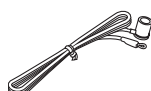

Note

The form of the supplied accessories varies depending on the models.

■ VOLTAGE SELECTOR (Asia and General models only)

Caution

The VOLTAGE SELECTOR on the rear panel of this unit must be set for your local voltage BEFORE plugging the power cable into the AC wall outlet. Improper setting of the VOLTAGE SELECTOR may cause damage to this unit and create a potential fire hazard.

Select the switch position (upper or lower) according to your local voltage using a straight slot screwdriver.

Voltages are 110-120/220-240 V AC, 50/60 Hz.

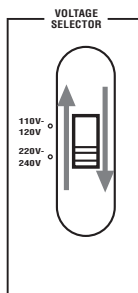

■ Installing batteries in the remote control

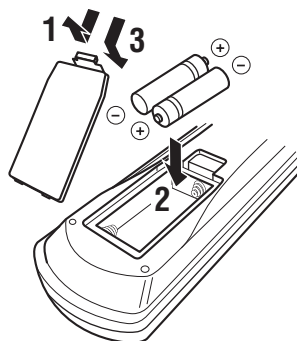

1 Take off the battery compartment cover.

2 Insert the two supplied batteries (AA, R6, UM-3) according to the polarity markings (+ and -) on the inside of the battery compartment.

3 Snap the battery compartment cover back into place.

Notes

- Change all of the batteries if you notice the following conditions:
 - the operation range of the remote control decreases.
 - the TRANSMIT indicator does not flash or its light becomes dim.
- Do not use an old battery and a new one together.
- Do not use different types of batteries (such as alkaline and manganese batteries) together. Read the packaging carefully as these different types of batteries may have the same shape and color.
- If the batteries have leaked, dispose of them immediately. Avoid touching the leaked material or letting it come into contact with clothing, etc. Clean the battery compartment thoroughly before installing new batteries.
- Do not throw away batteries with general house waste; dispose of them correctly in accordance with your local regulations.
- If the remote control is without batteries for more than 2 minutes, or if exhausted batteries remain in the remote control, the contents of the memory may be cleared. When the memory is cleared, insert new batteries and set up the remote control code.

Quick start guide

The following steps describe the easiest way to enjoy DVD movie playback in your home theater.

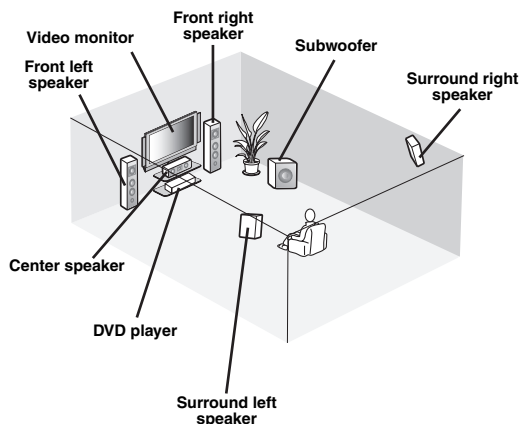

Step 1: Set up your speakers

P. 5

Step 2: Connect your DVD player and other components

P. 6

Step 3: Turn on the power and press SCENE 1 button

P. 8

Enjoy DVD playback!

Preparation: Check the items

In these steps, you need the following supplied accessories.

- Indoor FM antenna
- AM loop antenna

The following items are not included in the package of this unit.

- Speakers**
 - Front speakers 2
 - Center speaker 1
 - Surround speakers 2Select magnetically shielded speakers. The minimum required speakers are two front speakers.
- Active subwoofer** 1
Select an active subwoofer equipped with an RCA input jack.
- Speaker cables** 5
- Subwoofer cable** 1
Select a monaural RCA cable.
- DVD player** 1
Select DVD player equipped with coaxial digital audio output jack and composite video output jack.
- Video monitor** 1
Select a TV monitor, video monitor or projector equipped with a composite video input jack.
- Video cable** 1
Select an RCA composite video cable.
- Digital coaxial audio cable** 1

Step 1: Set up your speakers

Place your speakers in the room and connect them to this unit.

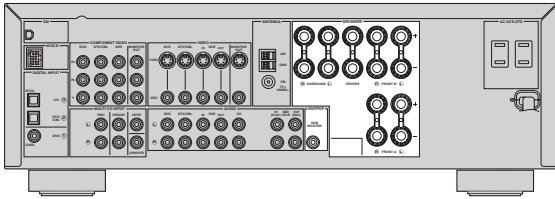

1 Place your speakers and subwoofer in the room.

2 Connect speaker cables to each speaker.

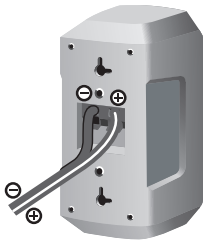

Cables are colored or shaped differently, perhaps with a stripe, groove or ridge. Connect the striped (grooved, etc.) cable to the “+” (red) terminals of your speaker. Connect the plain cable to the “-” (black) terminals.

3 Connect each speaker cable to the corresponding speaker terminal of this unit.

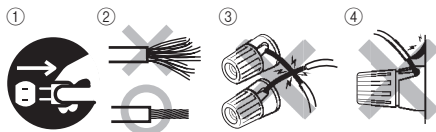

- ① Make sure that this unit and the subwoofer are unplugged from the AC wall outlets.
- ② Twist the exposed wires of the speaker cables together to prevent short circuits.
- ③ Do not let the bare speaker wires touch each other.
- ④ Do not let the bare speaker wires touch any metal part of this unit.

Be sure to connect the left channel (L), right channel (R), “+” (red) and “-” (black) properly.

Front speakers

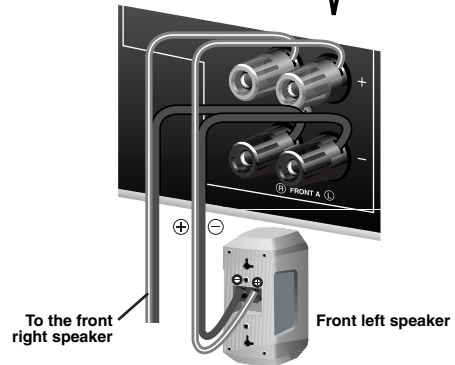
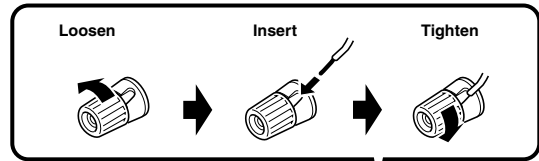

Center and surround speakers

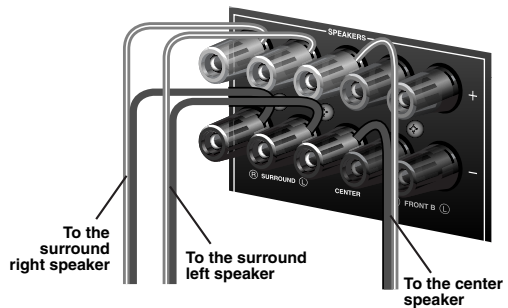

4 Connect the subwoofer cable to the input jack of the subwoofer and the SUBWOOFER OUTPUT jack of this unit.

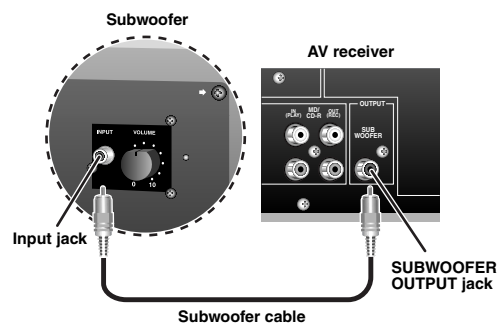

Step 2: Connect your DVD player and other components

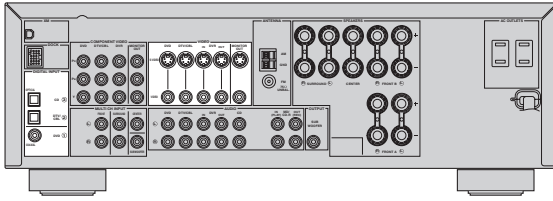

Make sure that this unit and the DVD player are unplugged from the AC wall outlets.

- 1 Connect the digital coaxial audio cable to the digital coaxial audio output jack of your DVD player and the DVD DIGITAL INPUT COAXIAL jack of this unit.

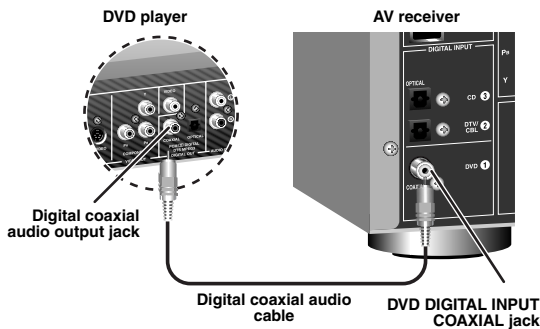

- 2 Connect the video cable to the composite video output jack of your DVD player and the DVD VIDEO jack of this unit.

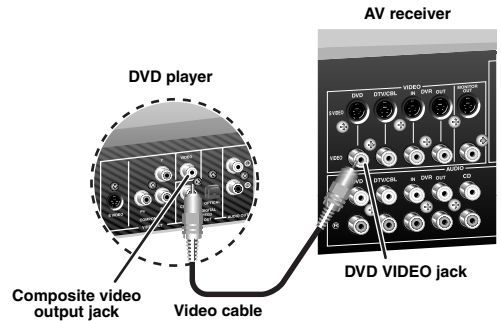

- 3 Connect the video cable to the video input jack of your video monitor and the VIDEO MONITOR OUT jack of this unit.

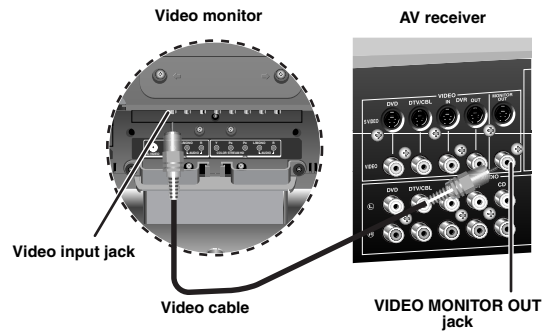

4 Connect the FM and AM antennas to this unit.

See page 19 for the details.

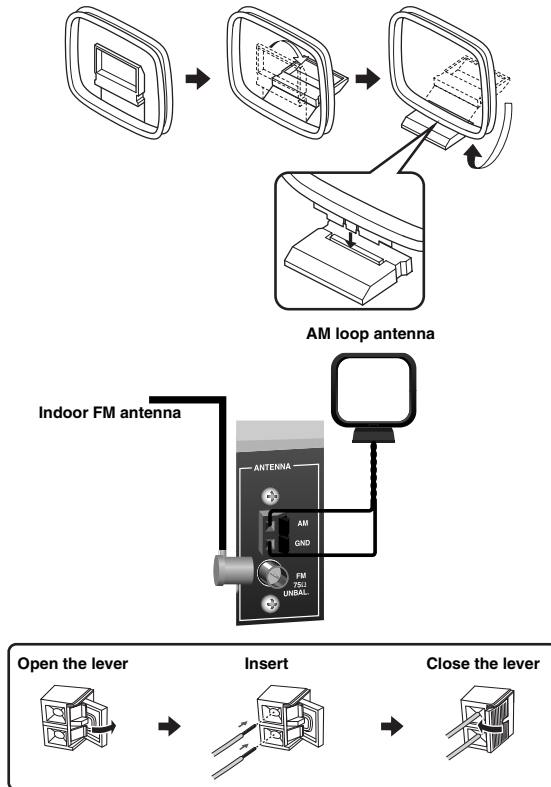

The wire of the AM loop antenna does not have any polarity and you can connect either end of the wire to AM and GND terminal.

5 Connect the power plug of this unit and other components into the AC wall outlet.



This unit is equipped with AC OUTLET(S) for the power supply of the other components (except Korea model). See page 19 for details

■ For further connections

- Using the other kind of speaker combinations P. 12
- Connecting a video monitor P. 15, 16
- Connecting a DVD player P. 15, 16
- Connecting a DVD recorder P. 15, 16
- Connecting a cable TV or a satellite tuner P. 15, 16
- Connecting a CD player and an MD recorder P. 17
- Connecting a DVD player via analog multi-channel audio connection P. 17
- Connecting a Yamaha iPod universal dock P. 18
- Using the VIDEO AUX jacks on the front panel P. 18
- Connecting an outdoor FM/AM antenna P. 19
- Connecting the XM Mini-Tuner Dock P. 41

Step 3: Turn on the power and press SCENE 1 button

Check the type of the connected speakers.
If the speakers are 6 ohm speakers, set “SP IMP.” to “6Ω MIN” before using this unit (see page 13).

- 1 Turn on the video monitor connected to this unit.
- 2 Press ① **STANDBY/ON** on the front panel.

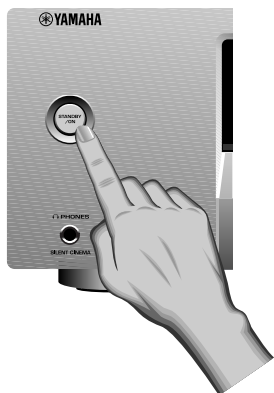

- 3 Press ⑯ **SCENE 1**.
“DVD Viewing” appears in the front panel display, and this unit automatically optimize own status for the DVD playback.



The indicator on the selected SCENE button lights up while this unit is in the SCENE mode.

- 4 Start playback of the desired DVD on your player.
- 5 Rotate ⑧ **VOLUME** to adjust the volume.



Note

When you change the input source or sound field program, the SCENE mode is deactivated, and the indicator on the selected SCENE button turns off.

Using the other SCENE buttons

In the following cases, try pressing the corresponding SCENE button to enjoy playback of the desired sources.

Case A: “I want to listen to a music disc from the connected DVD player as the background music for this room...”

➔ Press ⑯ **SCENE 2** (or ⑰ **SCENE 2**) to select “Disc Listening”.

Case B: “I want to watch a TV program...”

➔ Press ⑯ **SCENE 3** (or ⑱ **SCENE 3**) to select “TV Viewing”.

Note

To use the “TV Viewing” template (Case B), you must connect a cable TV or a satellite tuner to this unit in advance. See page 15 for details.

Case C: “I want to listen to a music program from the FM radio station...”

➔ Press **16 SCENE 4** (or **F SCENE 4**) to select “Radio Listening”.

Notes

- To use the “Radio Listening” template (Case C), you must tune into the desired radio station in advance. See pages 38 to 40 for tuning information.
- To achieve the best possible reception, orient the connected AM loop antenna, or adjust the position of the end of the indoor FM antenna.



If you cannot find the desired situation, you can select and change the assigned SCENE template for the SCENE buttons. See page 26 for details.

■ After using this unit...

Press **1 STANDBY/ON** on the front panel to set this unit to the standby mode.

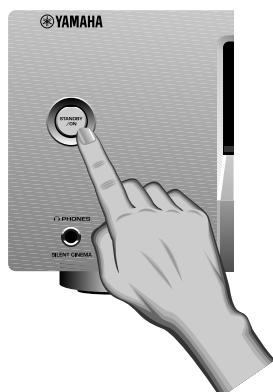

This unit is set to the standby mode. In the standby mode, this unit consumes a small amount of power in order to receive infrared signals from the remote control. To turn on this unit from the standby mode, press **1 STANDBY/ON** (or **@ STANDBY**). See page 19 for details.

Note

In the standby mode, this unit consumes a small amount of power in order to receive infrared signals from the remote control.

What do you want to do with this unit?

■ Customizing the SCENE templates

- Using various SCENE templates P. 26
- Creating your original SCENE templates P. 29

■ Using various input sources

- Basic controls of this unit P. 30
- Enjoying FM/AM radio programs P. 38
- Enjoying XM Satellite Radio programs P. 41
- Using your iPod with this unit. P. 46

■ Using various sound features

- Using various sound field programs P. 35
- Using the pure direct mode for the high fidelity sound P. 32
- Customizing the sound field programs P. 37

■ Adjusting the parameters of this unit

- Automatically optimizing the speaker parameters for your listening room (AUTO SETUP) P. 22
- Manually adjusting various parameters of this unit P. 49
- Setting the remote control P. 59
- Adjusting the advanced parameters P. 64

■ Additional features

- Automatically turning off this unit P. 34

Connections

Rear panel

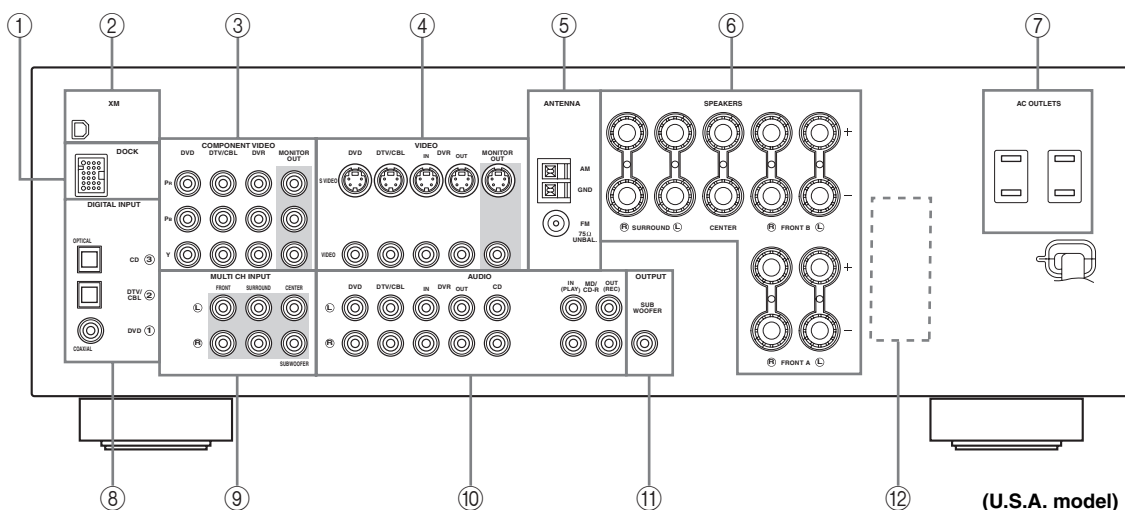

(U.S.A. model)

① DOCK terminal

See page 18 for connection information.

② XM jack (U.S.A. and Canada models only)

See page 41 for connection information.

③ COMPONENT VIDEO jacks

See page 16 for connection information.

④ VIDEO jacks

See pages 15 and 16 for connection information.

⑤ ANTENNA terminals

See page 19 for connection information.

⑥ SPEAKERS terminals

See page 12 for connection information.

⑦ AC OUTLET(S)

See page 19 for connection information.

⑧ DIGITAL INPUT jacks

See pages 15 and 17 for connection information.

⑨ MULTI CH INPUT jacks

See page 17 for connection information.

⑩ AUDIO jacks

See pages 15 and 17 for connection information.

⑪ SUBWOOFER OUTPUT jack

See page 12 for connection information.

⑫ VOLTAGE SELECTOR (Asia and General models only)

See page 3 for details.

Placing speakers

The speaker layout below shows the speaker setting we recommend. You can use it to enjoy CINEMA DSP and multi-channel audio sources.

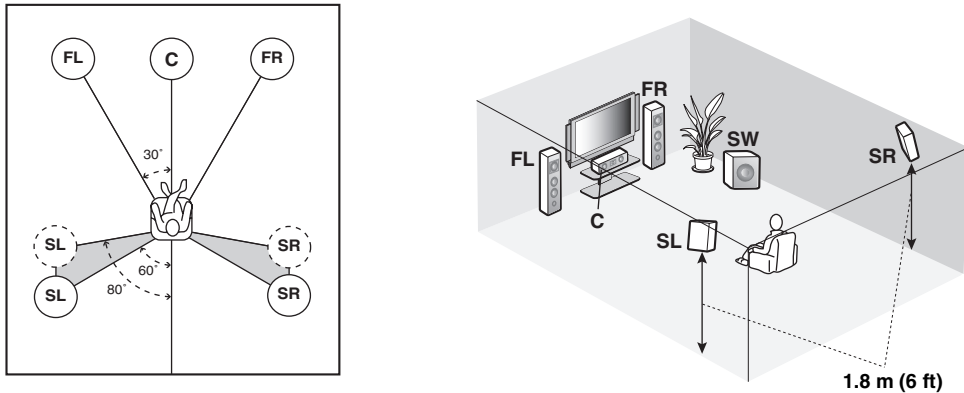

Front left and right speakers (FL and FR)

The front speakers are used for the main source sound plus effect sounds. Place these speakers at an equal distance from the ideal listening position. The distance of each speaker from each side of the video monitor should be the same.

Center speaker (C)

The center speaker is for the center channel sounds (dialog, vocals, etc.). If for some reason it is not practical to use a center speaker, you can do without it. Best results, however, are obtained with the full system.

Surround left and right speakers (SL and SR)

The surround speakers are used for effect and surround sounds.

Subwoofer (SW)

The use of a subwoofer with a built-in amplifier, such as the Yamaha Active Servo Processing Subwoofer System, is effective not only for reinforcing bass frequencies from any or all channels, but also for high fidelity sound reproduction of the LFE (low-frequency effect) channel included in Dolby Digital and DTS sources. The position of the subwoofer is not so critical, because low bass sounds are not highly directional. But it is better to place the subwoofer near the front speakers. Turn it slightly toward the center of the room to reduce wall reflections.

Connecting speakers

Be sure to connect the left channel (L), right channel (R), “+” (red) and “-” (black) properly. If the connections are faulty, this unit cannot reproduce the input sources accurately.

Caution

- Before connecting the speakers, make sure that this unit is turned off (see page 19).
- Do not let the bare speaker wires touch each other or let them touch any metal part of this unit. This could damage this unit and/or the speakers.
- Use the magnetically shielded speakers. If this type of speaker still creates interference with the monitor, place the speakers away from the monitor.
- If you are to use 6 ohm speakers, be sure to set “SP IMP.” to “6Ω MIN” before using this unit (see page 13).

Note

A speaker cord is actually a pair of insulated cables running side by side. Cables are colored or shaped differently, perhaps with a stripe, groove or ridge. Connect the striped (grooved, etc.) cable to the “+” (red) terminals of this unit and your speaker. Connect the plain cable to the “-” (black) terminals.

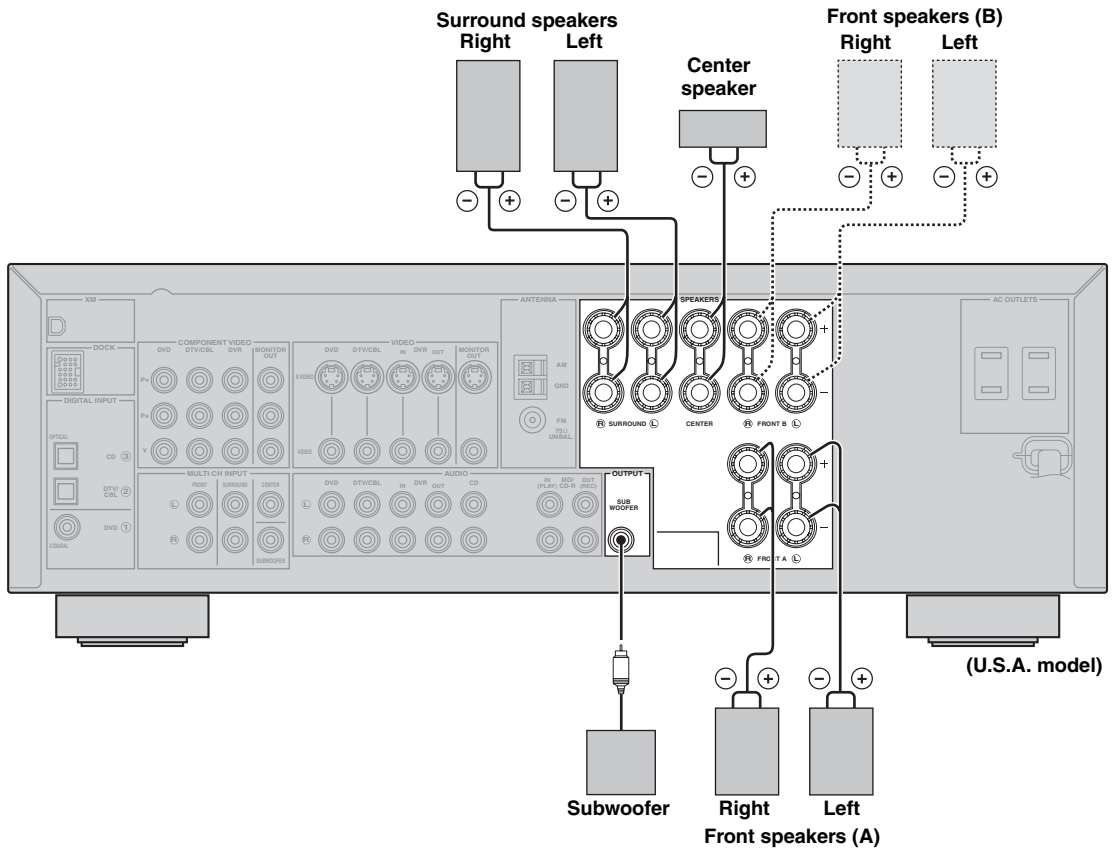

■ Before connecting to the SPEAKERS terminal

A speaker cord is actually a pair of insulated cables running side by side. Cables are colored or shaped differently, perhaps with a stripe, groove or ridges. Connect the striped (grooved, etc.) cable to the “+” (red) terminals of this unit and your speaker. Connect the plain cable to the “-” (black) terminals.

Remove approximately 10 mm (3/8”) of insulation from the end of each speaker cable and then twist the bare wires of the cable together to prevent short circuits.

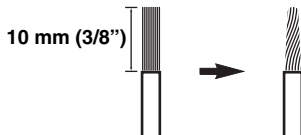

■ Connecting to the SPEAKERS terminals

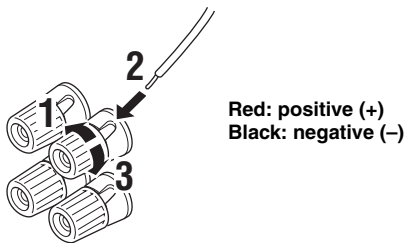

1 Loosen the knob.

2 Insert the bare end of the speaker wire into the hole on the terminal.

3 Tighten the knob to secure the wire.

Connecting the banana plug (except Korea and Asia models)

The banana plug is a single-pole electrical connector widely used to terminate speaker cables. First, tighten the knob and then insert the banana plug connector into the end of the corresponding terminal.

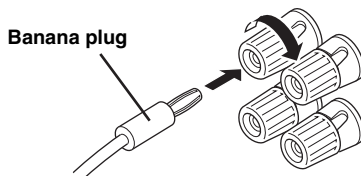

Setting the speaker impedance (U.S.A. and Canada models only)

Caution

If you are to use 6 ohm speakers, set “SP IMP.” to “6Ω MIN” as follows BEFORE using this unit.

1 Make sure this unit is turned off.

See page 19 for details about turning on or off this unit.

2 Press and hold **⓫ TONE CONTROL** and then press **Ⓛ STANDBY/ON** to turn on this unit.

This unit turns on, and the advanced setup menu appears in the front panel display.

3 Press **Ⓛ PROGRAM </>** repeatedly to select “SP IMP.”.

The following display appears in the front panel display.

SP IMP.- 8ΩMIN

4 Press **⓫ STRAIGHT** repeatedly to select “6Ω MIN”.

The following display appears in the front panel display.

SP IMP.- 6ΩMIN

5 Press **Ⓛ STANDBY/ON** to confirm your selection and set this unit to the standby mode.

Note

The setting you made is reflected next time you turn on this unit.

Information on jacks and cable plugs

Audio jacks and cable plugs

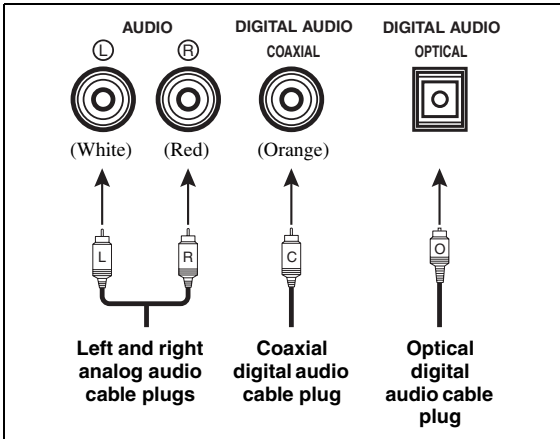

Video jacks and cable plugs

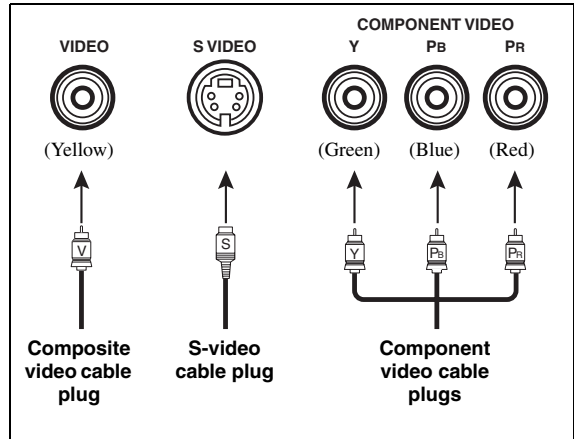

■ Audio jacks

This unit has three types of audio jacks. Connection depends on the availability of audio jacks on your other components.

AUDIO jacks

For conventional analog audio signals transmitted via left and right analog audio cables. Connect red plugs to the right jacks and white plugs to the left jacks.

DIGITAL AUDIO COAXIAL jacks

For digital audio signals transmitted via coaxial digital audio cables.

DIGITAL AUDIO OPTICAL jacks

For digital audio signals transmitted via optical digital audio cables.

Notes

- You can use the digital jacks to input PCM, Dolby Digital and DTS bitstreams. All digital input jacks are compatible with digital signals with up to 96 kHz of sampling frequency.
- This unit handles digital and analog signals independently. Thus audio signals input at the digital jacks are not output at the analog AUDIO OUT (REC) jacks.
- Pull out the cap from the optical jack before you connect the fiber optic cable. Do not discard the cap. When you are not using the optical jack, be sure to put the cap back in place. This cap protects the jack from dust.



■ Video jacks

This unit has three types of video jacks. Connection depends on the availability of input jacks on your video monitor.

VIDEO jacks

For conventional composite video signals transmitted via composite video cables.

S VIDEO jacks

For S-video signals, separated into the luminance (Y) and chrominance (C) video signals transmitted on separate wires of S-video cables.

COMPONENT VIDEO jacks

For component signals, separated into the luminance (Y) and chrominance (Pb, Pr) video signals transmitted on separate wires of component video cables.

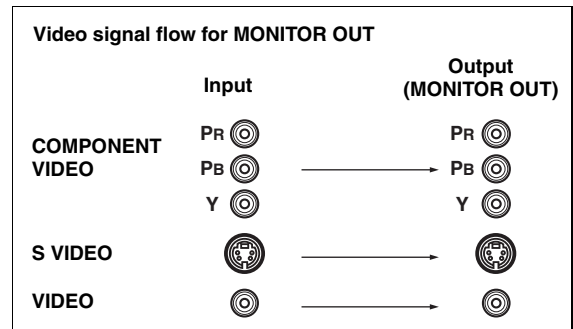

Note

The OSD signal is not output at the DVR OUT (REC) jacks.

Connecting video components

Connect the video components as follows.



You can also connect a video monitor, DVD player, digital TV, and cable TV to this unit using the S VIDEO or COMPONENT VIDEO connections (see page 16).

■ Connecting a video monitor and a DVD player

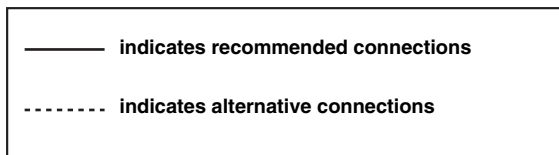
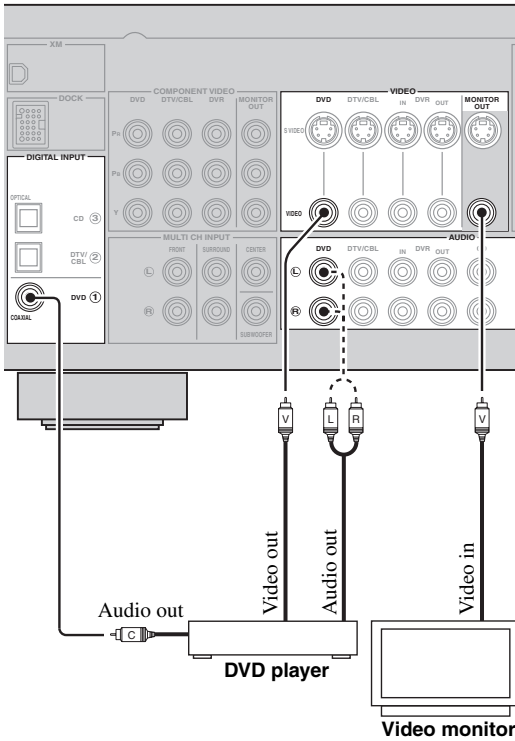

Make sure that this unit and other components are unplugged from the AC wall outlets.

■ Connecting a cable TV/satellite tuner and a DVD recorder

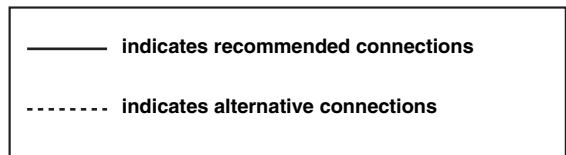
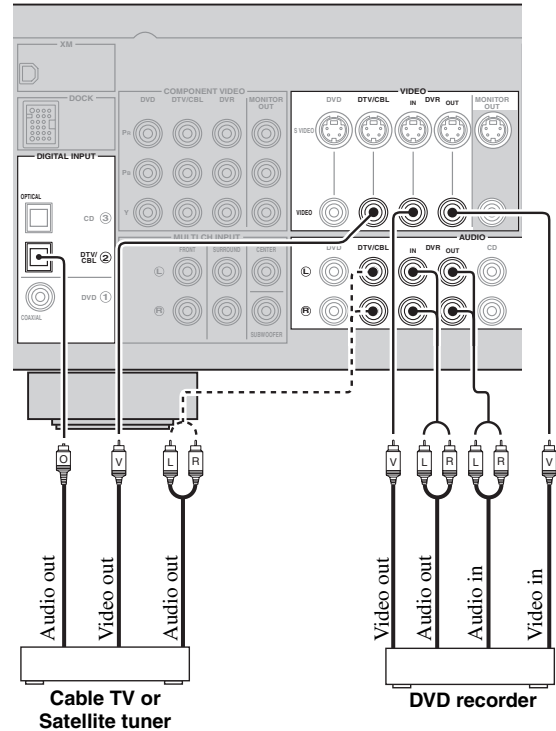

■ **Connecting to the COMPONENT VIDEO or S VIDEO jacks**

You can enjoy high-quality pictures by connecting your video monitor and video source components to this unit using COMPONENT VIDEO or S VIDEO connections.

Note

Be sure to connect your video components in the same way you connect your video monitor to this unit. For example, if you connect your video monitor to this unit using a COMPONENT VIDEO connection, connect your video components to this unit using the COMPONENT VIDEO connection.

COMPONENT VIDEO connection

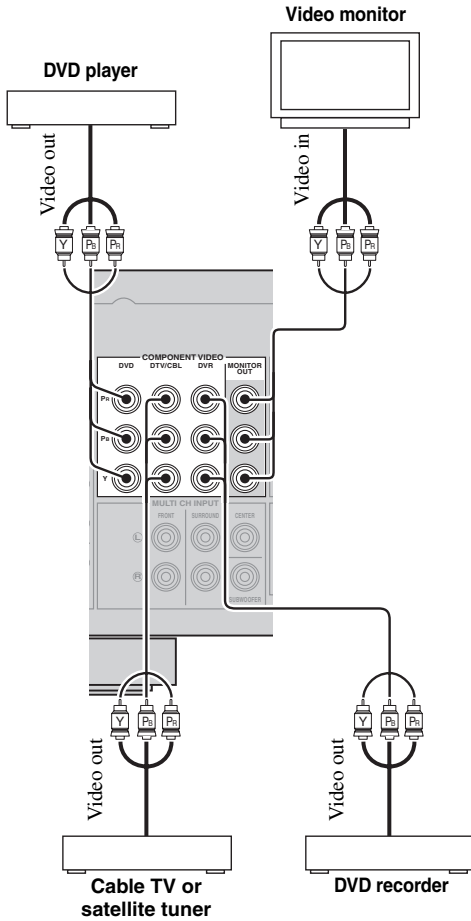

S VIDEO connection

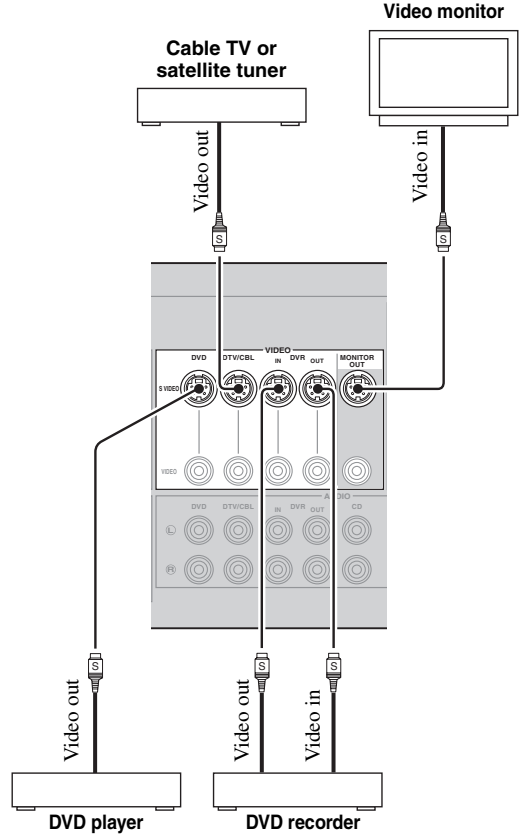

Connecting audio components

Connect the audio components as follows.

■ Connecting a CD player and a CD recorder/MD recorder

Note

When you connect your CD player via analog and digital connection, priority is given to the signal input at the DIGITAL INPUT jack.



Make sure that this unit and other components are unplugged from the AC wall outlets.

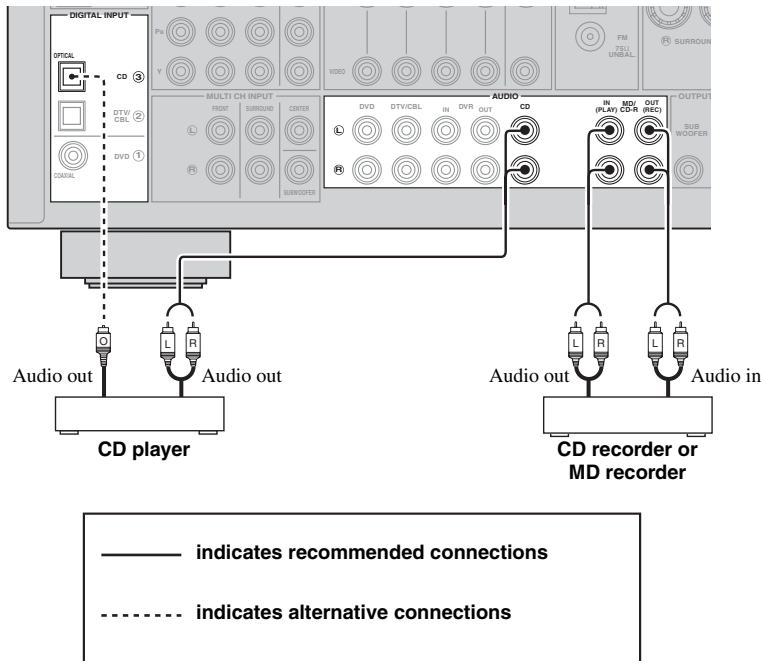

■ Connecting to the MULTI CH INPUT jacks

This unit is equipped with 6 additional input jacks (FRONT L/R, SURROUND L/R, CENTER and SUBWOOFER) for discrete multi-channel input from a multi-format player, external decoder or sound processor. Connect the output jacks on your multi-format player or external decoder to the MULTI CH INPUT jacks. Be sure to match the left and right output jacks to the left and right input jacks for the front and surround channels.

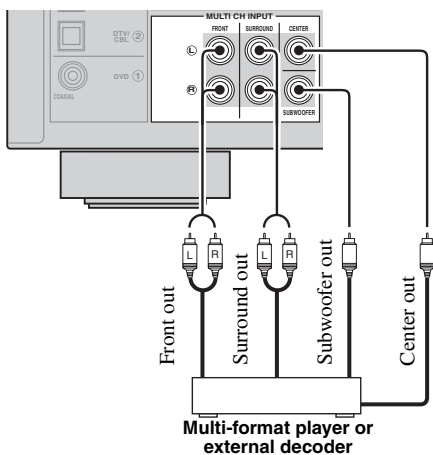

Notes

- When you select the component connected to the MULTI CH INPUT jacks as the input source (see page 31), this unit automatically turns off the digital sound field processor, and you cannot select sound field programs.
- This unit does not redirect signals input at the MULTI CH INPUT jacks to accommodate for missing speakers. We recommend that you connect a 5.1-channel speaker system before using this feature.

Connecting a Yamaha iPod universal dock



Make sure that this unit and other components are unplugged from the AC wall outlets.

This unit is equipped with the DOCK terminal on the rear panel that allows you to connect a Yamaha iPod universal dock (YDS-10, sold separately) where you can station your iPod and control playback of your iPod using the supplied remote control. Connect a Yamaha iPod universal dock (YDS-10, sold separately) to the DOCK terminal on the rear panel of this unit using its dedicated cable. Once the connection is complete, station your iPod in the Yamaha iPod universal dock.

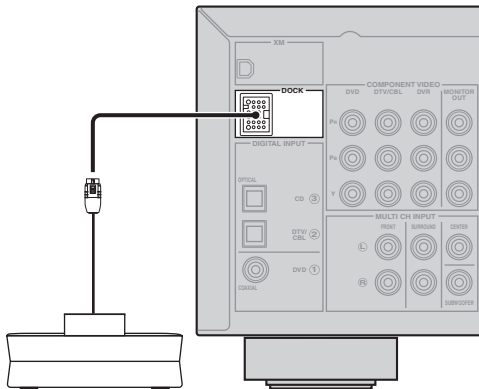

Yamaha iPod universal dock (YDS-10, sold separately)

(U.S.A. model)

Using the VIDEO AUX jacks on the front panel

Use the VIDEO AUX jacks on the front panel to connect a game console or a video camera to this unit.

Caution

Be sure to turn down the volume of this unit and other components before making connections.

Notes

- To reproduce the source signals input at these jacks, select “V-AUX” as the input source.
- When audio signals are input at the AUDIO jacks, PORTABLE jack and the DOCK terminal on the rear panel, the priority order of the input signal is as follows:
 - DOCK
 - PORTABLE
 - AUDIO

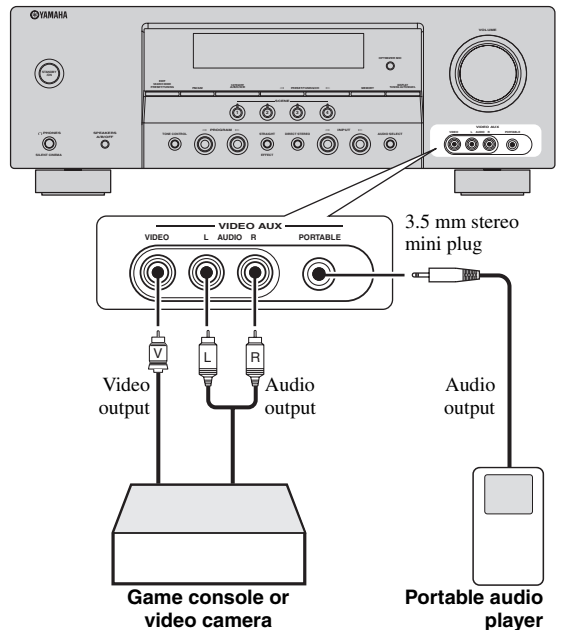

Connecting the FM and AM antennas

Both FM and AM indoor antennas are supplied with this unit. In general, these antennas should provide sufficient signal strength. Connect each antenna correctly to the designated terminals.

Notes

- The AM loop antenna should be placed away from this unit.
- A properly installed outdoor antenna provides clearer reception than an indoor one. If you experience poor reception quality, install an outdoor antenna. Consult the nearest authorized Yamaha dealer or service center about outdoor antennas.
- The AM loop antenna should always be connected, even if an outdoor AM antenna is connected to this unit.

Outdoor AM antenna

Use a 5 to 10 m (16 to 32 ft) of vinyl-covered wire extended outdoors from a window.

AM loop antenna (supplied)

Indoor FM antenna (supplied)

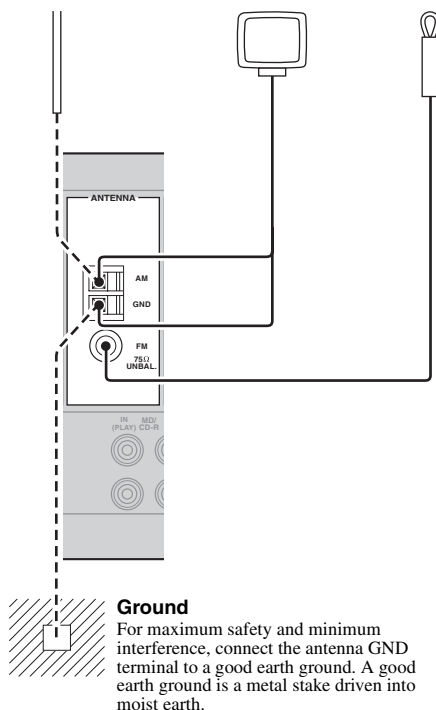

Connecting the power cable

Once all connections are complete, plug the power cable into the AC wall outlet.

(U.S.A. model)

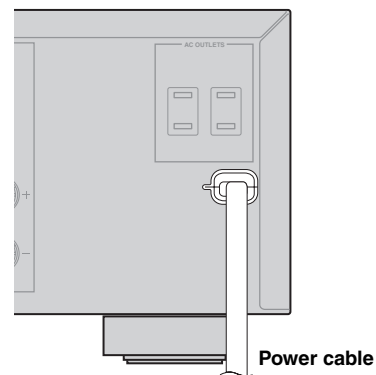

AC OUTLET(S) (SWITCHED)

Australia model	1 outlet
Korea model	None
Other models	2 outlets

Use these outlet(s) to supply power to any connected components. Connect the power cable of your other components to these outlet(s). Power to these outlet(s) is supplied when this unit is turned on. However, power to these outlet(s) is cut off when this unit is set to the standby mode. For information on the maximum power or the total power consumption of the components that can be connected to these outlet(s), see "Specifications" on page 74.

Turning on and off the power

Turning on this unit

Press **① STANDBY/ON** (or **Ⓜ POWER**) to turn on this unit.



When you turn on this unit, there will be a 4 to 5-second delay before this unit can reproduce sound.

Set this unit to the standby mode

Press **① STANDBY/ON** (or **Ⓞ STANDBY**) to set this unit to the standby mode.

In the standby mode, this unit consumes a small amount of power in order to receive infrared signals from the remote control.

Front panel display

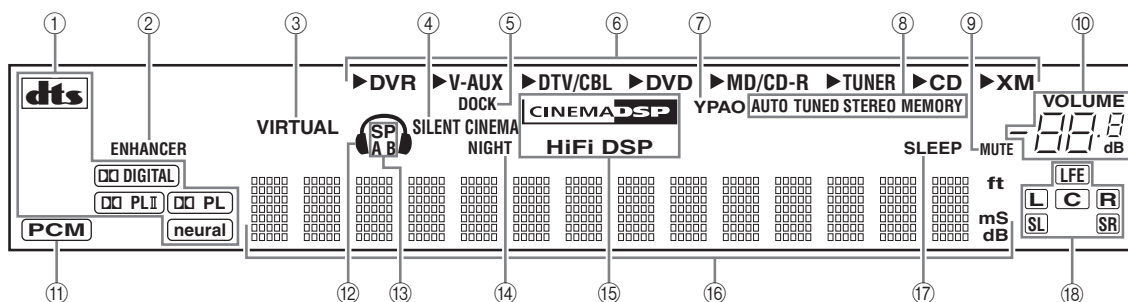

① Decoder indicator

The respective indicator lights up when any of the decoders of this unit functions.

② ENHANCER indicator

Lights up when the Compressed Music Enhancer mode is selected (see page 35).

③ VIRTUAL indicator

Lights up when Virtual CINEMA DSP is active (see page 36).

④ SILENT CINEMA indicator

Lights up when headphones are connected and a sound field program is selected (see page 36).

⑤ DOCK indicator

Lights up when you station your iPod in a Yamaha iPod universal dock (YDS-10, sold separately) connected to the DOCK terminal of this unit (see page 18) and you select V-AUX as the input source.

⑥ Input source indicators

The corresponding cursor lights up to show the currently selected input source.

⑦ YPAO indicator

Lights up when you run "AUTO SETUP" and when the speaker settings set in "AUTO SETUP" are used without any modifications (see page 22).

⑧ Tuner indicators

Lights up when this unit is in the FM, AM or XM Satellite Radio tuning mode (see pages 38 and 41).

⑨ MUTE indicator

Flashes while the MUTE function is on (see page 34).

⑩ VOLUME level indicator

Indicates the current volume level.

⑪ PCM indicator

Lights up when this unit is reproducing PCM (Pulse Code Modulation) digital audio signals.

⑫ Headphones indicator

Lights up when headphones are connected (see page 34).

⑬ SP A B indicators

Light up according to the set of front speakers selected (see page 30).

⑭ NIGHT indicator

Lights up when you select a night listening mode (see page 33).

⑮ CINEMA DSP indicator

Lights up when you select a CINEMA DSP sound field program (see page 35).

HiFi DSP indicator

Lights up when you select a HiFi DSP sound field program (see page 35).

⑯ Multi-information display

Shows the name of the current sound field program and other information when adjusting or changing settings.

⑰ SLEEP indicator

Lights up while the sleep timer is on (see page 34).

⑱ Input channel and speaker indicators

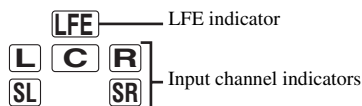

LFE indicator

Lights up when the input signal contains the LFE signal.

Input channel indicators

Indicate the channel components of the current digital input signal.

■ Using the remote control

The remote control transmits a directional infrared ray. Be sure to aim the remote control directly at the remote control sensor on this unit during operation.

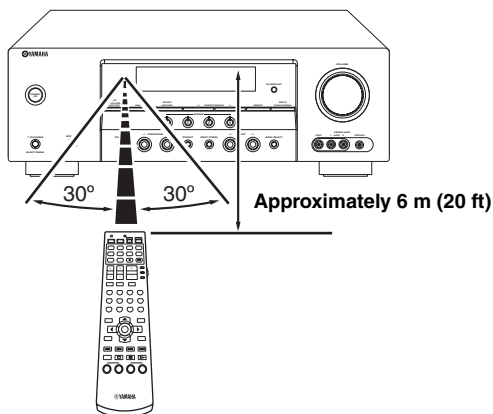

Ⓜ Infrared window

Outputs infrared control signals. Aim this window at the component you want to operate.

Ⓜ TRANSMIT indicator

Flashes while the remote control is sending infrared signals.

Ⓜ Operation mode selector

The function of some buttons depends on the operation mode selector position.

AMP

Operates the amplifier function of this unit.

SOURCE

Operates the component selected with an input selector button (see page 61).

TV

Operates the TV assigned to DTV/CBL (see page 60).



To set the remote control codes for other components, see page 62.

Notes

- Do not spill water or other liquids on the remote control.
- Do not drop the remote control.
- Do not leave or store the remote control in the following types of conditions:
 - places of high humidity, such as near a bath
 - places of high temperature, such as near a heater or stove
 - places of extremely low temperatures
 - dusty places

Optimizing the speaker setting for your listening room

This unit employs the YPAO (Yamaha Parametric Room Acoustic Optimizer) technology which lets you avoid troublesome listening-based speaker setup and achieves highly accurate sound adjustments automatically. The supplied optimizer microphone collects and this unit analyzes the sound your speakers produce in your actual listening environment.

Using AUTO SETUP

Notes

- Be advised that it is normal for loud test tones to be output during the “AUTO SETUP” procedure.
- To achieve the best results, make sure the room is as quiet as possible while the “AUTO SETUP” procedure is in progress. If there is too much ambient noise, the results may not be satisfactory.



You can run “AUTO SETUP” using the system menu that appears in the OSD or in the front panel display. This manual uses the OSD illustrations to explain the “AUTO SETUP” procedure.

1 Make sure of the following check points before starting the AUTO SETUP operations.

- Speakers are connected appropriately.
- Headphones are disconnected from this unit.
- This unit and the video monitor are turned on.
- The connected subwoofer is turned on and the volume level is set to about half way (or slightly less).
- The crossover frequency controls of the connected subwoofer is set to the maximum.
- FRONT A speakers are selected as the front speaker system (see page 30).
- The room is sufficiently quiet.

2 Connect the supplied optimizer microphone to the OPTIMIZER MIC jack on the front panel.

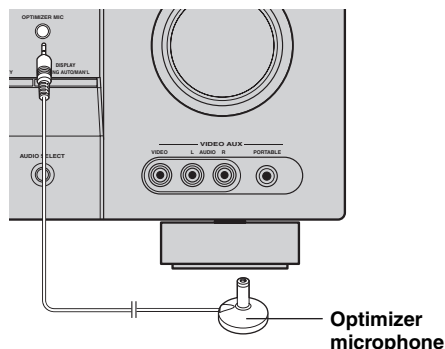

The following display appears in the OSD.

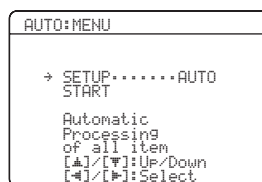

3 Place the optimizer microphone at your normal listening position on a flat level surface with the microphone heading upward.

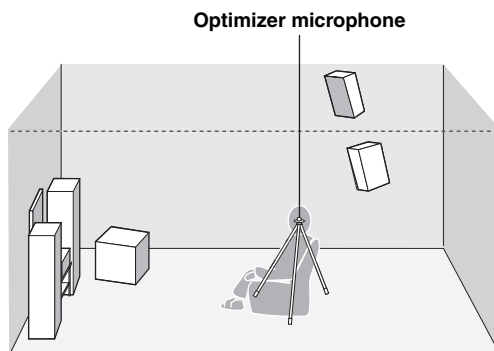

It is recommended that you use a tripod (etc.) to affix the optimizer microphone at the same height as your ears would be when you are seated in your listening position. You can use the attached screw of a tripod (etc.) to fix the optimizer microphone to the tripod (etc.).

4 Set the operation mode selector (Ⓚ) to AMP and then press Ⓧ◀/▶ to select “AUTO”.

Choices: **AUTO**, RELOAD, UNDO, DEFAULT

- Select “AUTO” to automatically run the entire “AUTO SETUP” procedure.
- Select “RELOAD” to reload the last “AUTO SETUP” settings and override the previous settings.
- Select “UNDO” to undo the last “AUTO SETUP” settings and restore the previous settings.
- Select “DEFAULT” to reset the “AUTO SETUP” parameters to the initial factory settings.

Note

“RELOAD” or “UNDO” is available only when you have previously run “AUTO SETUP” and confirmed the results.

5 Press Ⓧ▽ to select “START” and then press ⓍENTER to start the setup procedure.

This unit starts the auto setup procedure. Loud test tones are output from each speaker during the auto setup procedure. Once all items are set, the “AUTO:RESULT” display appears in the OSD.

Notes

- During the auto setup procedure, do not perform any operation on this unit.
- We recommend getting out of the room while this unit is in the auto setup procedure. It takes approximately 3 minutes for this unit to complete the auto setup procedure.

This unit performs the following checks:

Speaker wiring/volume level WIRING/LEVEL

Checks which speakers are connected and the polarity of each speaker. Also checks and adjusts the volume level of each speaker.

Speaker distance DISTANCE

Checks the distance of each speaker from the listening position and adjusts the timing of each channel.

Speaker size SIZE

Checks the frequency response of each speaker and sets the appropriate low-frequency crossover for each channel.

The display changes as follows.

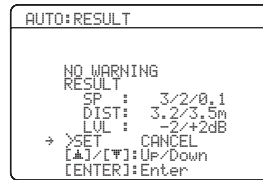
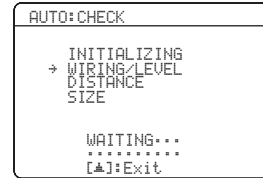
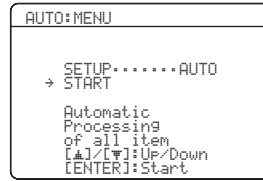

The results displayed under “RESULT” are as follows.

Number of speakers SP

Displays the number of speakers connected to this unit in the following order:
Front/Back/Subwoofer

Speaker distance DIST

Displays the speaker distance from the listening position in the following order:
Closest speaker distance/Farthest speaker distance

Speaker level LVL

Displays the speaker output level in the following order:
Lowest speaker output level/Highest speaker output level

Notes

- If “E-6:INTERNAL ERROR” appears during the testing procedure, restart from step 4.
- If you selected “RELOAD” in step 4, no test tones are output.
- If an error occurs during the “AUTO:CHECK” procedure, the setup procedure is canceled and an error screen appears. For details, see “If an error screen appears” on page 25.
- When this unit detects potential problems during the “AUTO SETUP” procedure, “WARNING” and the number of warning messages appears in the above of “RESULT” (see page 25).

6 Press **Ⓢ** **ENTER** to display the setup results in detail.

7 Press **Ⓢ** **◀/▶** repeatedly to toggle between the setup result displays.

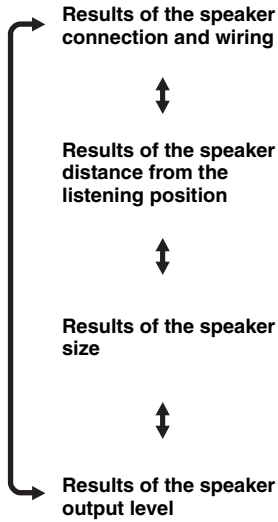

If you are not satisfied with the results or want to manually adjust each parameter, run “MANUAL SETUP” (see page 49).

Note

The distances displayed in the “DISTANCE” results may be longer than the actual distance depending on the characteristics of your speakers.

8 Press **Ⓢ** **ENTER** to return to the “AUTO:RESULT” display.

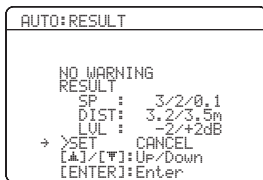

9 Make sure the pointer is pointing at “SET” and “CANCEL” and then press **Ⓢ** **◀/▶** to select “SET” or “CANCEL”.

Choices: **SET**, **CANCEL**

- Select “SET” to confirm the “AUTO SETUP” results.
- Select “CANCEL” to cancel the “AUTO SETUP” results.

10 Press **Ⓢ** **ENTER** to confirm your selection. The top “SET MENU” display appears in the OSD.

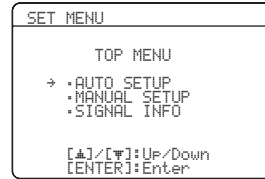

11 Press **Ⓢ** **SET MENU** to exit from “SET MENU”.

12 Disconnect the optimizer microphone from this unit.

The optimizer microphone is sensitive to heat. Keep it away from direct sunlight and do not place it on top of this unit.



If you change speakers, speaker positions, or the layout of your listening environment, run “AUTO SETUP” again to recalibrate your system.

■ If an error screen appears

Press **⏪/⏩/⏮/⏭** to select “RETRY” or “EXIT” and then press **⏵** **ENTER**.

The following display is an example where “E-5:USER CANCEL” appears in the OSD.

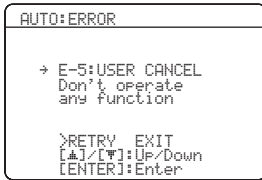

Choices: **RETRY**, **EXIT**

- Select “RETRY” to retry the “AUTO SETUP” procedure.
- Select “EXIT” to exit from the “AUTO SETUP” procedure.

■ If “WARNING” appears

When this unit detects potential problems during the “AUTO SETUP” procedure, “WARNING” appears in the “RESULT:EXIT” display. Check the warning messages to correct your speaker settings.

Note

Warnings differ from errors in that warnings do not cancel the “AUTO SETUP” procedure.

1 Make sure the pointer is pointing at “WARNING” and then press **⏵** **ENTER** to display the detailed information about the warning.

The number on the right of “WARNING” indicates the number of warning messages.

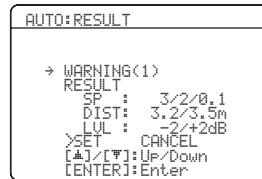

2 Press **⏪/⏩** repeatedly to toggle between the warning displays.

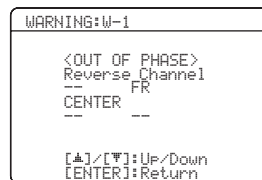

- For details about each warning message, see the “AUTO SETUP” section in “Troubleshooting” on page 65.
- When the corresponding warning message is not applicable to a speaker, “--” is displayed instead.

3 Press **⏵** **ENTER** to return to the top “RESULT:EXIT” display.

Selecting the SCENE templates

This unit is equipped with 16 preset SCENE templates for various situations of using this unit. As the initial factory setting, the following SCENE templates are assigned to each SCENE button:

SCENE 1: DVD Viewing

SCENE 2: Disc Listening

SCENE 3: TV Viewing

SCENE 4: Radio Listening

If you want to use other SCENE templates, you can select the desired SCENE templates from the SCENE template library and assign the templates to the selected SCENE buttons on the front panel and the remote control.

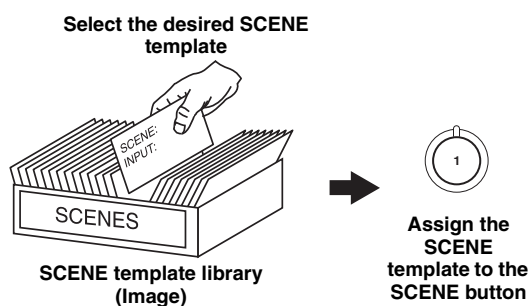

- Press **14** INPUT ◀/▶ (or set the operation mode selector (K) to AMP and then press **10** ◀/▶) to select the desired template.

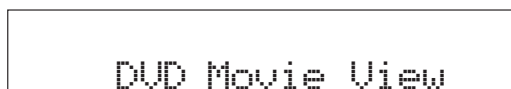
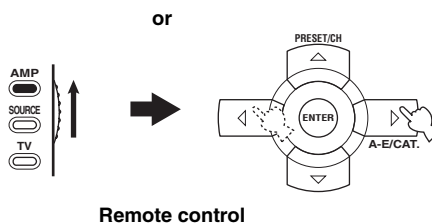
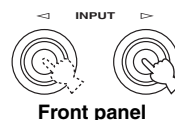

Selecting the desired SCENE template

- Press and hold the desired **16** SCENE (or **F** SCENE) button for 3 seconds.

The indicator on the selected SCENE button on the front panel starts to flash, and the name of the currently assigned SCENE template appears in the front panel display.

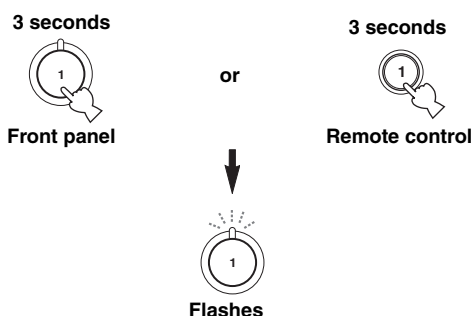

- Press the **16** SCENE (or **F** SCENE) button again to confirm the selection.

The selected SCENE template is assigned to the button.



or



Notes

- If you do not carry out any operation within 30 seconds from the last operation in these steps, this procedure is automatically canceled.
- Once the desired SCENE templates are assigned to the corresponding SCENE buttons, you may need to set the input source of the SCENE template on the remote control. See page 59 for details.

■ Which SCENE template would you like to select?

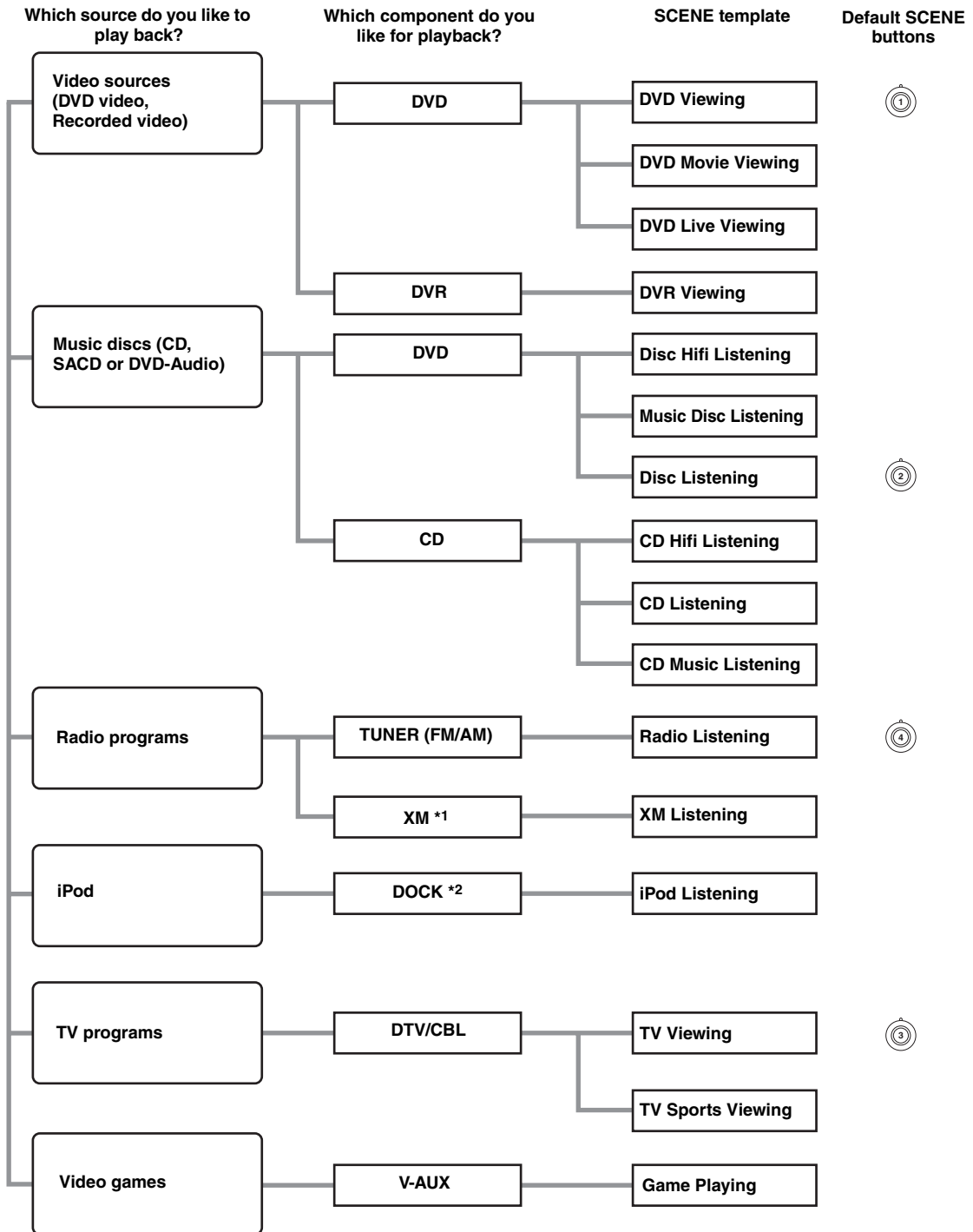

Notes

*1 To enjoy XM Satellite Radio programs, you need to connect the XM Mini-Tuner Dock (sold separately) and activate the service (see page 41).

*2 To enjoy listening to your iPod, you need to connect the Yamaha iPod universal dock (sold separately) to this unit (see page 18).



You can create your original SCENE templates by editing the preset SCENE templates. See page 29 for details.

■ Preset SCENE templates descriptions

SCENE template	
Features	
Input source	Playback mode

DVD Viewing (SCENE 1 as the default setting)	
Select this SCENE template when you play back general contents on your DVD player.	
DVD	STRAIGHT

DVD Movie Viewing	
Select this SCENE template when you play back movies on your DVD player.	
DVD	Movie Dramatic

DVD Live Viewing	
Select this SCENE template when you enjoy music live video on your DVD player.	
DVD	Pop/Rock

DVR Viewing	
Select this SCENE template when you play back movies on your digital video recorder.	
DVR	Movie Dramatic

Disc Hifi Listening	
Select this SCENE template when you enjoy the high fidelity sound of the music discs on your DVD player.	
DVD	DIRECT STEREO

Music Disc Listening	
Select this SCENE template when you play back music discs on your DVD player.	
DVD	2ch Stereo

Disc Listening (SCENE 2 as the default setting)	
Select this SCENE template when you play back music sources on your DVD player as the background music.	
DVD	5ch Stereo

CD Hifi Listening	
Select this SCENE template when you enjoy the high fidelity sound of the music discs on your CD player.	
CD	DIRECT STEREO

CD Listening	
Select this SCENE template when you play back music discs on your CD player.	
CD	2ch Stereo

CD Music Listening	
Select this SCENE template when you play back the music source on your CD player as the background music.	
CD	5ch Stereo

Radio Listening (SCENE 4 as the default setting)	
Select this SCENE template when you enjoy FM or AM radio programs.	
TUNER	MUSIC ENHANCER 5ch STEREO

XM Listening	
Select this SCENE template when you enjoy XM Satellite Radio programs.	
XM	MUSIC ENHANCER 5ch STEREO

iPod Listening	
Select this SCENE template when you play back music on your iPod stationed in a Yamaha iPod universal dock.	
DOCK (V-AUX)	MUSIC ENHANCER 5ch STEREO

TV Viewing (SCENE 3 as the default setting)	
Select this SCENE template when you enjoy TV programs.	
DTV/CBL	STRAIGHT

TV Sports Viewing	
Select this SCENE template when you enjoy sports programs on TV.	
DTV/CBL	TV Sports

Game Playing	
Select this SCENE template when you play video games.	
V-AUX*	Game

* You can select "V-AUX" as the input source even if iPod is stationed to the Yamaha Universal Dock connected to this unit.

Creating your original SCENE templates

You can create your original SCENE templates for each SCENE button. You can refer to the preset 16 SCENE templates to create the original SCENE templates.

■ Customizing the preset SCENE templates

Use this feature to customize the preset SCENE templates.

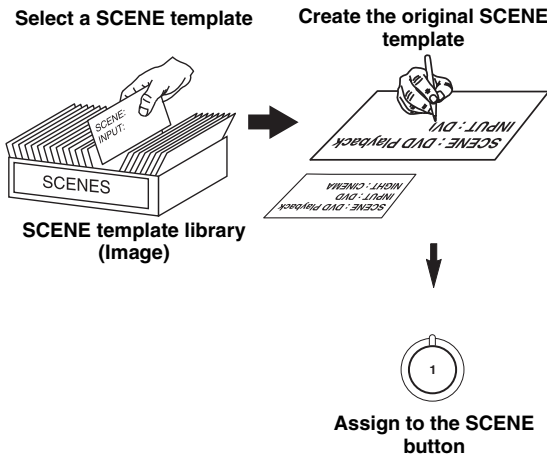

1 Turn on the video monitor connected to this unit.

2 Set the operation mode selector (Ⓚ) to **AMP** and then press and hold the desired **Ⓢ SCENE** button for 3 seconds.

The SCENE template customizing screen appears on the video monitor.



Note

When the SCENE template you want to customize is not assigned to any of the **Ⓢ SCENE** button, press **Ⓢ** repeatedly to recall the desired SCENE template on the menu screen.

3 Press **Ⓢ** / **Ⓢ** / **Ⓢ** to select the desired parameter of the SCENE template and then **Ⓢ** / **Ⓢ** / **Ⓢ** to select the desired value of the selected parameter.

You can adjust the following parameters for a SCENE template:

- **INPUT:** The input source component
- **MODE:** The active sound field programs, STRAIGHT or DIRECT STEREO mode (see pages 33 and 36)
- **NIGHT:** The night listening mode setting (see page 33)
 - **SYSTEM:** Keeps the current night listening mode.
 - **CINEMA:** Sets the night listening mode to the CINEMA mode.
 - **MUSIC:** Sets the night listening mode to the MUSIC mode.

4 Press the **Ⓢ SCENE** button again to confirm the edit.



An asterisk mark (*) appears by the name of the original SCENE template.

Notes

- Once the desired SCENE templates are assigned to the corresponding **Ⓢ SCENE** buttons, you may need to set the input source of the SCENE template on the remote control. See page 59 for details.
- You can create a customized SCENE template for each **Ⓢ SCENE** button, and if you create another customized SCENE template, this unit overwrites the old customized SCENE template with the new one.
- The newly created template is only available for the assigned **Ⓢ SCENE** button.

■ Renaming the SCENE templates

Select “SCENE” in step 3 of “Customizing the preset SCENE templates” and then press **Ⓢ ENTER**.

- Press **Ⓢ** / **Ⓢ** / **Ⓢ** to select the desired character.
- Press **Ⓢ** / **Ⓢ** / **Ⓢ** to place “_” (underscore) under the space or the desired character.
- Press **Ⓢ RETURN** to cancel the new name.
- Press **Ⓢ ENTER** to confirm the new name.

Playback

Caution

Extreme caution should be exercised when you play back CDs encoded in DTS. If you play back a CD encoded in DTS on a DTS-incompatible CD player, you will only hear some unwanted noise that may damage your speakers. Check whether your CD player supports CDs encoded in DTS. Also, check the sound output level of your CD player before you play back a CD encoded in DTS.



Before performing operations, set the operation mode selector (Ⓚ) to **AMP**.

Basic operations

1 Turn on the video monitor connected to this unit.

2 Press (14) INPUT </> repeatedly (or press one of the input selector buttons (A)) to select the desired input source.

The name of the currently selected input source appears in the front panel display for a few seconds.

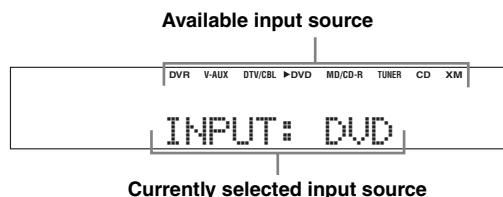

The corresponding input selector button on the remote control for the currently selected input source lights up for approximately 5 seconds after you press any buttons on the remote control, showing which source component is currently being operated.

3 Start playback on the selected component or select a broadcast station.

- Refer to the operating instructions for the source component.
- See page 38 for details about FM/AM tuning instructions.
- See page 41 for details about XM Satellite Radio tuning instructions.

4 Rotate (8) VOLUME (or press (J) VOLUME +/-) to adjust the volume to the desired output level.

5 Press (11) PROGRAM </> repeatedly (or press one of the sound field program selector buttons (P)) repeatedly to select the desired sound field program.

The name of the selected sound field program appears in the front panel display.

See page 35 for details about sound field programs.



Notes

- Choose a sound field program based on your listening preference, not merely on the name of the program.
- When you select an input source, this unit automatically selects the last sound field program used with the corresponding input source.
- Sound field programs cannot be selected when the component connected to the MULTI CH INPUT jacks is selected as the input source (see page 31).
- When PCM signals with a sampling frequency higher than 48 kHz are input, this unit is automatically set to the "STRAIGHT" mode (see page 36).
- To display information about the currently selected input source in the OSD, see page 33 for details.

■ A quick guide to contents

When you want to...	See page
Enjoy pure hi-fi stereo sound	32
Adjust the tonal quality of the front speakers	32
Adjust the parameters of sound field programs	37
Enjoy the sources with a wide dynamic range at night	33
Use headphones	34
Select a decoder to play back sources with	36
Automatically set this unit to the standby mode	34

Additional operations

■ Selecting the component connected to the MULTI CH INPUT jacks as the input source

Press **14** **INPUT** **</>** repeatedly (or press **A** **MULTI CH IN**) so that “MULTI CH” appears in the front panel display.



Use “MULTI CH SET” menu in “INPUT MENU” to set the parameter for MULTI CH INPUT (see page 57).

Notes

- Sound field programs cannot be selected when the component connected to the MULTI CH INPUT jacks is selected as the input source.
- When headphones are used, signals are output only from the front left and right channels.

■ Selecting the front speaker set

Press **9** **SPEAKERS** on the front panel repeatedly to turn on or off the set of front speakers connected to the FRONT A or FRONT B speaker terminals.

The active front speaker set changes as follows:

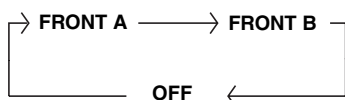

Note

Turn off the volume level of this unit when you switch the front speaker setting.

■ Using the Zone B feature

When you set “FRONT B” to “ZONE B” (see page 51), you can use the speakers connected to the FRONT B speaker terminals in another room (Zone B).

Press **9** **SPEAKERS** on the front panel repeatedly to turn on or off the Zone B speakers.

When you activate the Zone B speakers, all the speakers in the main room are muted.

Notes

- You cannot activate both the main room and Zone B speakers simultaneously.
- If you select CINEMA DSP sound field program and activate the Zone B speakers, Virtual CINEMA DSP activates automatically (see page 36).

■ Selecting audio input jacks (AUDIO SELECT)

This unit comes with a variety of input jacks. Use this feature (audio input jack select) to switch between input jacks when more than one input jack is assigned to the same input source.



- We recommend setting audio input jack select to “AUTO” in most cases.
- You can adjust the default audio input jack select of this unit by using “AUDIO SELECT” in “OPTION MENU” (see page 58).

Press **15** **AUDIO SELECT** (or **1** **AUDIO SEL**) repeatedly to select the desired audio input jack select setting.



Audio input jack select setting

- AUTO** Automatically selects input signals in the following order:
 (1) Digital signals
 (2) Analog signals
- ANALOG** Selects only analog signals. If no analog signals are input, no sound is output.

Note

This feature is not available when no digital input jacks are assigned to the currently selected input source.

■ Enjoying pure hi-fi stereo sound

The DIRECT STEREO mode allows sources to bypass the decoders and DSP processors of this unit so that you can enjoy pure hi-fi sound from 2-channel PCM and analog sources.

Press **13** **DIRECT STEREO** (or set the operation mode selector **(K)** to **AMP** and then press **1** **DIRECT ST.**) to select “DIRECT STEREO”.

Notes

- To avoid unexpected noise, do not play CDs encoded in DTS when the DIRECT STEREO mode is selected.
- When multi-channel signals (Dolby Digital and DTS) are input, this unit automatically switches to the corresponding analog input.
- No sound will be output from the subwoofer.
- “TONE CONTROL” (see page 30) and “SOUND MENU” (see page 51) settings (except for speaker level settings) are not effective.
- The front panel display automatically dims.

■ Adjusting the tonal quality

Press **10** **TONE CONTROL** repeatedly to select “BASS” or “TREBLE” and then press **11** **PROGRAM** **</>** to adjust the corresponding frequency response level.

- Select “BASS” to adjust the low-frequency response.
- Select “TREBLE” to adjust the high-frequency response.

Notes

- Speaker and headphone adjustments are stored independently.
- If you increase or decrease the high-frequency or low-frequency sound to an extreme level, the tonal quality of the surround speakers may not match that of the front left and right speakers.

■ Adjusting speaker levels during playback

You can adjust the output level of each speaker while listening to a music source.

Note

This operation will override the level adjustments made in “AUTO SETUP” (see page 22) and “SP LEVEL” (see page 53).

- 1 Set the operation mode selector **(K)** to **AMP** and then press **9** **LEVEL** repeatedly to select the speaker you want to adjust.

Display	Adjusted speaker
FRONT L	Front left speaker
FRONT R	Front right speaker
CENTER	Center speaker
SUR. L	Surround left speaker
SUR. R	Surround right speaker
SWFR	Subwoofer



Once you press **9** **LEVEL** on the remote control, you can also select the speaker by pressing **0** **Δ** / **∇**.

- 2 Press **0** **</>** on the remote control to adjust the speaker output level.

The control range is from +10 dB to -10 dB.



You can press **4** **A/B/C/D/E** to select a speaker and then **5** **PRESET/TUNING/CH** **</>** to adjust the speaker output level.

■ Selecting the night listening mode

The night listening modes are designed to improve listenability at lower volumes or at night.

1 Set the operation mode selector (K) to **AMP** and then press (R) **NIGHT** repeatedly to select “**NIGHT:CINEMA**” or “**NIGHT:MUSIC**”.

Choices: NIGHT:CINEMA, NIGHT:MUSIC, OFF

- Select “NIGHT:CINEMA” to reduce the dynamic range of film soundtracks and make dialog easier to hear at lower volumes.
- Select “NIGHT:MUSIC” to preserve ease-of-listening for all sounds.
- Select “OFF” if you do not want to use this feature.



When a night listening mode is selected, the NIGHT indicator lights up in the front panel display.

2 Press (D) </> to adjust the effect level while “**NIGHT:CINEMA**” or “**NIGHT:MUSIC**” is displayed in the front panel display.

Choices: MIN, **MID**, MAX

- Select “MIN” for minimum compression.
- Select “MID” for standard compression.
- Select “MAX” for maximum compression.



“NIGHT:CINEMA” and “NIGHT:MUSIC” adjustments are stored independently.

Notes

- You cannot use the night listening modes in the following cases:
 - when the DIRECT STEREO mode (see page 32) is selected.
 - when the component connected to the MULTI CH INPUT jacks is selected as the input source.
 - when headphones are connected to the PHONES jack.
- The night listening modes may vary in effectiveness depending on the input source and surround sound settings you use.

■ Displaying signal information

You can display the format, sampling frequency, channel, bit rate and flag data of the current input signal.

1 Set the operation mode selector (K) to **AMP** and then press (N) **SET MENU** on the remote control.

The top “SET MENU” display appears in the OSD.



2 Press (D) </> repeatedly to select “**SIGNAL INFO**” and then press (D) **ENTER**.

The following information about the input source appears in the OSD.

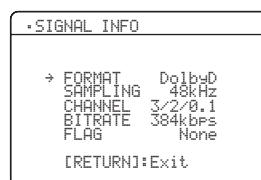

Display	Description
FORMAT	Signal format.
SAMPLING	The number of samples per second taken from a continuous signal to make a discrete signal.
CHANNEL	The number of source channels in the input signal (front/surround/LFE).
BITRATE	The number of bits passing a given point per second.
FLAG	Flag data encoded in DTS, Dolby Digital, or PCM signals that cue this unit to automatically switch decoders.



The information indicated by the cursor is also displayed in the front panel display.

3 Press (N) **SET MENU** again to exit from “**SET MENU**”.

■ Playing video sources in the background

You can combine a video image from a video source with sound from an audio source. For example, you can enjoy listening to classical music while viewing beautiful scenery from the video source on the video monitor.

Press the input selector buttons on the remote control to select a video source and then an audio source.

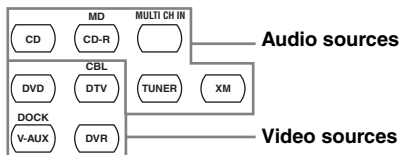

■ Using your headphones

Connect a pair of headphones with a stereo analog audio cable plug to the PHONES jack on the front panel.

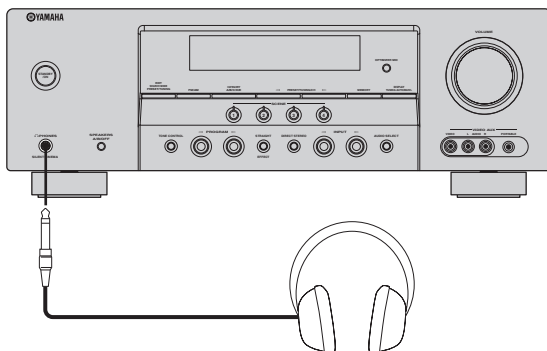

When you select a sound field program, SILENT CINEMA mode activates automatically (see page 36).

Notes

- When you connect headphones, no signals are output at the speaker terminals.
- All Dolby Digital and DTS audio signals are mixed down to the left and right headphone channels.

■ Muting the audio output

Press MUTE to mute the audio output.

Press MUTE again to resume the audio output.



- You can also rotate VOLUME (or press VOLUME +/-) to resume the audio output.
- You can adjust the muting level by using “MUTE TYPE” in “SOUND MENU” (see page 54).
- The MUTE indicator flashes in the front panel display when the audio output is muted and disappears from the front panel display when the audio output is resumed.

■ Using the sleep timer

Use this feature to automatically set this unit to the standby mode after a certain amount of time. The sleep timer also automatically turns off any external components connected to the AC OUTLET(S) (see page 19).

Set the operation mode selector (K) to AMP and then press SLEEP repeatedly to set the amount of time.

Each time you press SLEEP , the front panel display changes as shown below.

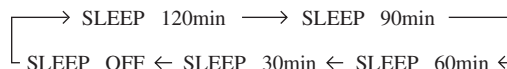

The SLEEP indicator flashes while you are switching the amount of time for the sleep timer. Once the sleep timer is set, the SLEEP indicator lights up in the front panel display, and the display returns to the selected sound field program.



- To cancel the sleep timer, press SLEEP on the remote control repeatedly until “SLEEP OFF” appears in the front panel display.
- You can also cancel the sleep timer setting by pressing STANDBY/ON (or STANDBY) to set this unit to the standby mode.

Sound field programs

This unit is equipped with a variety of precise digital decoders that allow you to enjoy multi-channel playback from almost any stereo or multi-channel sound source.

Press **⑪ PROGRAM** $\triangleleft/\triangleright$ (or set the operation mode selector (K) to AMP and then press one of the sound field program selector buttons (P) repeatedly).

The name of the selected sound field program appears in the front panel display.

Notes

- When you select an input source, this unit automatically selects the last sound field program used with the corresponding input source.
- Sound field programs cannot be selected when the component connected to the MULTI CH INPUT jacks is selected as the input source (see page 31).
- When PCM signals with a sampling frequency higher than 48 kHz are input, this unit is automatically set to the “STRAIGHT” mode (see page 36).



Choose a sound field program based on your listening preference, not merely on the name of the program itself.

Sound field program descriptions

Remote control button	Program	Features
MUSIC	Pop/Rock	CINEMA DSP processing. This program presents an image of pop, rock, or jazz live concert. The sound field reproduces the spaciousness of a massive pavilion with an emphasis on the vividness of vocals on the stage and solo instruments and the beats of rhythm instruments.
	Hall	HiFi DSP processing. This sound field is suitable for classic and orchestral music. The program uses data collected in a large concert hall in Munich. You can enjoy delicate and beautiful reverberation and a majestic atmosphere.
	Jazz	HiFi DSP processing. The sound field is suitable for jazz and fusion music. It uses data collected in a famous jazz club in New York. You can enjoy clear reverberation.
ENTERTAIN	Game	CINEMA DSP processing. You can enjoy dynamic and thrilling sound effects as you play games. The program lets you feel the depth and three-dimensional surrounding sounds of the field where you are playing, and offers cinema-like surrounding sound effects for the scenes of movies.
	TV Sports	CINEMA DSP processing. You can enjoy sports relays broadcast in stereo and variety shows with a live sound environment. For sports relays, the voices of commentators and announcers come clearly from the center; the cheers and atmosphere in the stadium spread around within a comfortable range, and you can feel like as if you are in the stadium.
MOVIE	Movie Spacious	CINEMA DSP processing. The sound field is suitable for movies with an emphasis on spectacular sound effects, and is a perfect fit with a wide screen. The program reproduces a wide dynamic range from minimum sound effects to powerful sounds.
	Movie Dramatic	CINEMA DSP processing. This sound field is also suitable for movies with an emphasis on three-dimensional sound effects. It restrains reverberation to an moderate extent, but reproduces sound effects and background music in a soft, three-dimensional manner with clarity and center orientation of voices as pivots.
STEREO	2ch Stereo	Downmixes multi-channel sources to 2 channel or plays back 2-channel sources as they are.
	5ch Stereo	HiFi DSP processing. Using this program increases the listening position range. This is a sound field suitable for background music at parties.
ENHANCER	Music Enh. 2ch	Select these programs to play back compression artifacts (such as the MP3 format) in 2-channel or 5-channel stereo. This program enhances your listening experience by regenerating the missing harmonics in a compression artifact.
	Music Enh. 5ch	

Note

The sound field programs of this unit are recreations of real-world acoustic environments made from precise measurements taken in the actual concert hall, music venue, movie theater, etc. Thus, you may notice variations in the strength of the reflections coming from each direction.

■ **Enjoying 2-channel sources using the standard decoders**

Signals input from 2-channel sources can also be played back on multi-channels.

Set the operation mode selector (K) to AMP and then press ©SUR. DECODE repeatedly to select a decoder.

You can select from the following decoders depending on the type of source you are playing and your personal preference.

STANDARD	Functions
PRO LOGIC	Dolby Pro Logic processing for any sources
PLII Movie	Dolby Pro Logic II processing for movie sources
PLII Music	Dolby Pro Logic II processing for music sources
PLII Game	Dolby Pro Logic II processing for game sources
Neural	Neural Surround processing for any sources

■ **Using sound field programs without surround speakers (Virtual CINEMA DSP)**

Virtual CINEMA DSP allows you to enjoy the CINEMA DSP programs without surround speakers by creating virtual speakers.

If you set “SUR. L/R SP” to “NONE” (see page 52), Virtual CINEMA DSP activates automatically whenever you select a CINEMA DSP or HiFi DSP program (see page 35).

Note

Virtual CINEMA DSP will not activate even when “SUR. L/R SP” is set to “NONE” (see page 52) in the following cases:

- When “5ch Stereo” (see page 35) is selected.
- When headphones are connected to the PHONES jack.

■ **Enjoying multi-channel sources and sound field programs with headphones (SILENT CINEMA)**

SILENT CINEMA allows you to enjoy multi-channel music or movie sound, including Dolby Digital and DTS sources, through ordinary headphones. SILENT CINEMA activates automatically whenever you connect headphones to the PHONES jack while listening to CINEMA DSP or HiFi DSP sound field programs (see page 35). When activated, the SILENT CINEMA indicator lights up in the front panel display.

Note

SILENT CINEMA does not activate when the component connected to the MULTI CH INPUT jacks is selected as the input source (see page 31).

■ **Enjoying unprocessed input sources (Straight decoding mode)**

When this unit is in the “STRAIGHT” mode, multi-channel sources are decoded straight into the appropriate channels without any additional effect processing. 2-channel stereo sources are output from only the front left and right speakers.

Press ⑫STRAIGHT (or set the operation mode selector (K) to AMP and then press ©STRAIGHT) to select “STRAIGHT”.

To deactivate the “STRAIGHT” mode, press ⑫STRAIGHT (or ©STRAIGHT) again so that “STRAIGHT” disappears from the front panel display.

■ Editing sound fields parameters

You can enjoy good quality sound with the factory preset parameters. Although you do not have to change the initial settings, you can change some of the parameters to better suit the input source or your listening room.

1 While listening to a source, set the operation mode selector (Ⓚ) to **AMP** and then press Ⓞ△ / ▽ to select the desired parameter.

2 Press Ⓞ◀ / ▶ to change the parameter value.

Note

You cannot change parameter values when “MEMORY GUARD” in “OPTION MENU” is set to “ON” (see page 58).



Initial settings are indicated in bold under each parameter.

For Pop/Rock, Hall, Jazz, Game, TV Sports, Movie Spacious and Movie Dramatic:

DSP level **DSP LEVEL**

Function: Adjusts the effect level.

Choices: MIN, **MID**, MAX

For PRO LOGIC II Music:

Panorama **PANORAMA**

Function: Sends stereo signals to the surround speakers as well as the front speakers for a wraparound effect.

Choices: **OFF**, ON

Dimension **DIMENSION**

Function: Gradually adjusts the sound field either towards the front or towards the rear.

Control range: -3 (towards the rear) to +3 (towards the front), initial setting is STD (standard).

Center width **CT WIDTH**

Function: Adjusts the center image from all three front speakers to varying degrees. A larger value adjusts the center image towards the front left and right speakers.

Control range: 0 (center channel sound is output only from center speaker) to 7 (center channel sound is output only from front left and right speakers), initial setting is 3.

For Music Enh. 2ch and Music Enh. 5ch

Effect level

Function: Adjusts the effect level.

Choices: LOW, **HIGH**

FM/AM tuning

There are 2 tuning methods: automatic and manual. Automatic tuning is effective when station signals are strong and there is no interference. If the signal from the station you want to select is weak, tune into it manually. You can also use the automatic and manual preset tuning features to store up to 40 stations.

Automatic tuning

Automatic tuning is effective when station signals are strong and there is no interference.

- 1 Press **14 INPUT** $\triangleleft/\triangleright$ repeatedly so that “**TUNER**” is displayed in the front panel display.
- 2 Press **3 FM/AM** to select the reception band (FM or AM).
- 3 Press **7 TUNING AUTO/MAN'L** so that the **AUTO** indicator lights up in the front panel display.



No colon (:)

If a colon (:) appears in the front panel display, automatic tuning is not possible. Press **2 PRESET/TUNING** to turn the colon (:) off.

- 4 Press **5 PRESET/TUNING/CH** $\triangleleft/\triangleright$ once to begin automatic tuning.

When this unit is tuned into a station, the **TUNED** indicator lights up and the frequency of the received station is shown in the front panel display.



Manual tuning

If the signal received from the station you want to select is weak, tune into it manually.

Note

Manually tuning into an FM station automatically switches the tuner to monaural reception to increase the signal quality.

- 1 Press **14 INPUT** $\triangleleft/\triangleright$ repeatedly so that “**TUNER**” is displayed in the front panel display.
- 2 Press **3 FM/AM** to select the reception band (FM or AM).
- 3 Press **7 TUNING AUTO/MAN'L** so that the **AUTO** indicator disappears from the front panel display.

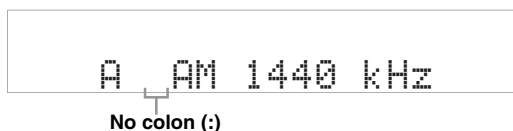

If a colon (:) appears in the front panel display, manual tuning is not possible. Press **2 PRESET/TUNING** to turn the colon (:) off.

- 4 Press **5 PRESET/TUNING/CH** $\triangleleft/\triangleright$ to tune into the desired station manually.



Hold down the button to continue searching.

Automatic preset tuning

You can use the automatic preset tuning feature to store FM stations with strong signals up to 40 (A1 to E8: 8 preset station numbers in each of the 5 preset station groups) of those stations in order. You can then recall any preset station easily by selecting the preset station number.

- 1 Press **14 INPUT** $\triangleleft/\triangleright$ repeatedly so that “TUNER” is displayed in the front panel display.
- 2 Press **3 FM/AM** to select “FM” as the reception band.
- 3 Press and hold **6 MEMORY** for more than 3 seconds.

The preset station number as well as the MEMORY and AUTO indicators flashes. After approximately 5 seconds, automatic presetting starts from the current frequency and proceeds toward the higher frequencies.

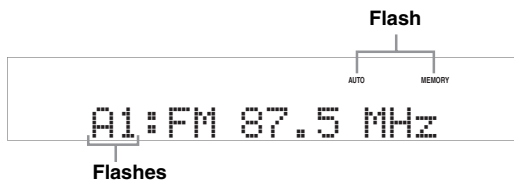

When automatic preset tuning is completed, the front panel display shows the frequency of the last preset station.



You can select the preset station group and the preset station number where the first received station will be stored by pressing **4 A/B/C/D/E** and then **5 PRESET/TUNING/CH** $\triangleleft/\triangleright$.

Notes

- Any stored station data existing under a preset station number is cleared when you store a new station under the same preset station number.
- Only FM stations with sufficient signal strength are stored automatically by automatic preset tuning. If the station you want to store is weak in signal strength, tune into it manually and store it as described in “Manual preset tuning” on this page.

Manual preset tuning

You can also store up to 40 stations (A1 to E8: 8 preset station numbers in each of the 5 preset station groups) manually.

- 1 Tune into a station automatically or manually. See page 38 for tuning instructions.
- 2 Press **6 MEMORY**. The MEMORY indicator flashes in the front panel display for approximately 10 seconds.
- 3 Press **4 A/B/C/D/E** and **5 PRESET/TUNING/CH** $\triangleleft/\triangleright$ repeatedly to select a preset station group (A1 to E8) while the MEMORY indicator is flashing. Check that the colon (:) appears in the front panel display.

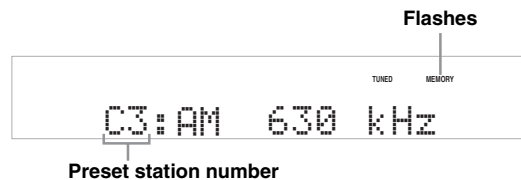

- 4 Press **6 MEMORY** while the MEMORY indicator is flashing.

The station band and frequency appear in the front panel display with the preset station group and number you have selected.



The displayed station has been stored as C3.

Notes

- Any stored station data existing under a preset station number is cleared when you store a new station under the same preset station number.
- The reception mode (stereo or monaural) is stored along with the station frequency.

Selecting preset stations

You can tune into any desired station simply by selecting the preset station group and number under which it was stored.



When performing this operation with the remote control, set the operation mode selector (K) to **SOURCE** and then press (A) **TUNER** to select "TUNER" as the input source.

- 1 Press (4) **A/B/C/D/E** (or (D) **A-E/CAT.** </>) repeatedly to select the desired preset station group (A to E).

The preset station group letter appears in the front panel display and changes each time you press the button.

- 2 Press (5) **PRESET/TUNING/CH** </> (or (D) **PRESET/CH** Δ / ▽) to select the desired preset station number (1 to 8).

The preset station group and number appear in the front panel display along with the station band and frequency.



You can select the desired preset station number (1 to 8) directly by pressing the numeric buttons on the remote control.

Exchanging preset station

You can exchange the assignments of two preset stations with each other. The example below describes the procedure to exchange preset station "E1" with "A5".

- 1 Select preset station "E1" using (4) **A/B/C/D/E** and (5) **PRESET/TUNING/CH** </>. See "Selecting preset stations" on this page.

- 2 Press and hold (2) **PRESET/TUNING** for more than 3 seconds.

"E1" and the MEMORY indicator flash in the front panel display.



- 3 Select preset station "A5" using (4) **A/B/C/D/E** and (5) **PRESET/TUNING/CH** </>.

"A5" and the MEMORY indicator flash in the front panel display.

See "Selecting preset stations" on this page.



- 4 Press (2) **PRESET/TUNING** again.

"EDIT E1-A5" appears in the front panel display and the assignments of the two preset stations are exchanged.

XM Satellite Radio tuning

XM Satellite Radio offers an extraordinary variety of commercial-free music, plus the best in sports, news, talk and entertainment. XM is broadcast in superior digital audio from coast to coast. From rock to reggae, from classical to hip hop, XM has something for every music fan. XM's dedication to playing the richest selection of music is matched by its passion for live sporting events, talk radio, up-to-the-minute news, stand-up comedy, children's programming, and much more.

For U.S. customers, information about XM Satellite Radio is available online at www.xmradio.com.

For Canadian customers, information about XM Canada is online at www.xmradio.ca.

This unit is equipped with the Neural Surround decoder that plays back the XM HD surround sound content of the XM Satellite Radio broadcasts in multi-channels, resulting in a full surround sound experience.

Note

The XM Satellite Radio service is only available in the 48 contiguous United States (not available in Alaska and Hawaii) and Canada.

■ Information from XM Satellite Radio Inc.

Hardware and required monthly subscription sold separately. Other fees and taxes, including a one-time activation fee may apply. Subscription fee is consumer only. All fees and programming subject to change. Subscriptions subject to Customer Agreement available at xmradio.com (US residents) and xmradio.ca (Canadian residents). Only available in the 48 contiguous United States and Canada. ©2006 XM Satellite Radio Inc. All rights reserved. All other trademarks are the property of their respective owners.

Connecting the XM Mini-Tuner Dock

Connect XM Mini-Tuner and XM Dock (sold separately) to the XM jack on the rear panel of this unit.

For details, see the operating instructions provided with XM Mini-Tuner Dock.

**XM Mini-Tuner and XM Dock
(sold separately)**

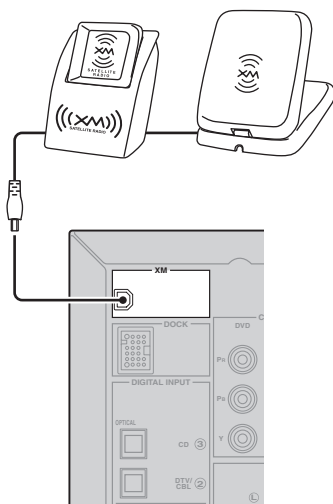

- To ensure optimal reception of the XM Satellite Radio signals, the XM Mini-Tuner Dock must be placed at or near a southerly facing window with no obstacles in the path to the sky. You can mount it indoors or outdoors.
- You can display the XM Satellite Radio reception level by using the "XM ANTENNA" parameter in "OPTION MENU" (see page 58).

Note

If "CHECK ANTENNA" appears in the front panel display, XM Mini-Tuner Dock may not be connected to the XM jack on the rear panel of this unit properly.

Activating XM Satellite Radio

Once you have installed the XM Mini-Tuner Dock, inserted the XM Mini-Tuner, connected the XM Dock to your XM Ready® home audio system, and installed the antenna, you are ready to subscribe and begin receiving XM programming. There are three places to find your eight character XM Radio ID: on the XM Mini-Tuner, on the XM Mini-Tuner package, and on XM Channel 0. Record the Radio ID in the following eight squares for reference.

□	□	□	□	□	□	□	□
---	---	---	---	---	---	---	---

Note

The XM Radio ID does not use the letters “I”, “O”, “S” or “F”. Activate your XM Satellite Radio service in the U.S. online at <http://www.xmradio.com/> or call 1-800-XM-RADIO (1-800-967-2346). You will need a major credit card. XM will send a signal from the satellites to activate the full channel lineup. Activation normally takes 10 to 15 minutes, but during peak busy periods you may need to keep your XM Ready home audio system on for up to an hour. When you can access the full channel lineup on your XM Ready home audio system you are done. For more information or to subscribe in Canada, visit XM on the Web at www.xmradio.ca or call XM’s Listener Care at 1-877-GET-XMSR (1-877-438-9677).

Basic XM Satellite Radio operations

- 1 Press **INPUT** $\triangleleft/\triangleright$ repeatedly (or press **XM**) to select “XM” as the input source.

The cursor on the left of the XM indicator lights up in the front panel display and the XM Satellite Radio information (such as channel number, channel name, category, artist name, or song title) for the currently selected channel appears in the front panel display.

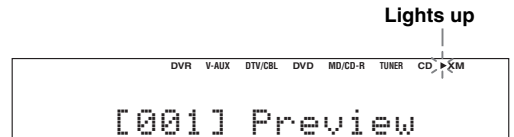

When you select “XM” as the input source, this unit automatically recalls the previously selected channel.

- 2 Search for a channel by using one of the XM Satellite Radio search modes.

- To select a channel from the all channel list, see “All Channel Search mode” on page 43.
- To select a channel by category, see “Category Search mode” on page 43.
- To select a channel from the preset channels, see “Preset Search mode” on page 43.
- To select the desired channel directly by entering the channel number, see “Direct Number Access mode” on page 43.



- You can use the Neural Surround decoder to enjoy the XM HD surround sound content of the XM Satellite Radio broadcasts in multi-channels (see page 36).
- You can set the XM Satellite Radio preset channels (see page 44).
- You can display the XM Satellite Radio information in the front panel display or in the OSD (see page 45).



Before performing operations, set the operation mode selector (K) to **SOURCE** and then press (A) **XM** to select "XM" as the input source.

■ All Channel Search mode

1 Press (2) **SEARCH MODE** (or (N) **SRCH MODE**) repeatedly to select "ALL CH SEARCH".

2 Press (5) **PRESET/TUNING/CH** </> (or (D) **PRESET/CH** Δ / ∇) repeatedly to search for a channel within all channels.



- You can search for a channel quickly by pressing and holding (5) **PRESET/TUNING/CH** </> (or (D) **PRESET/CH** Δ / ∇).
- To display the XM Radio ID number displayed in the front panel display, select channel "0".

■ Category Search mode

1 Press (2) **SEARCH MODE** (or (N) **SRCH MODE**) repeatedly to select "CAT SEARCH".

2 Press (4) **CATEGORY** (or (D) **A-E/CAT.** </>) repeatedly to change the channel category.

3 Press (5) **PRESET/TUNING/CH** </> (or (D) **PRESET/CH** Δ / ∇) repeatedly to search for a channel within the selected channel category.



You can search for a channel quickly by pressing and holding (5) **PRESET/TUNING/CH** </> (or (D) **PRESET/CH** Δ / ∇).

■ Preset Search mode

Prior to selecting a preset channel in the Preset Search mode, you must preset XM Satellite Radio channels. For details, see "Setting XM Satellite Radio preset channels" on page 44.



All preset channels (A1 to E8) recalls "001 Preview" by the initial factory setting.

1 Press (2) **SEARCH MODE** (or (N) **SRCH MODE**) repeatedly to select "PRESET SEARCH".

2 Press (4) **CATEGORY** (or (D) **A-E/CAT.** </>) repeatedly to change the preset channel group (A to E).

3 Press (5) **PRESET/TUNING/CH** </> (or (D) **PRESET/CH** Δ / ∇) repeatedly to change the preset channel number (1 to 8).



You can also select the preset channel number directly by pressing the numeric buttons (1 to 8) on the remote control.

■ Direct Number Access mode

1 Press (N) **SRCH MODE** repeatedly to select "ALL CH SEARCH" or "CAT SEARCH".

2 Press the numeric buttons (B) to enter the desired three-digit channel number.

For example, to enter the number 123, press the numeric buttons as shown below.



The display changes as follows.

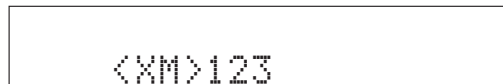
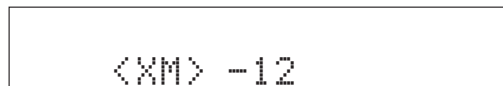
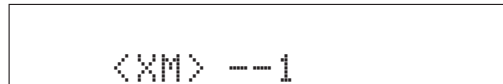

- To enter a one-digit or two-digit channel number, press the numeric buttons (B) and then press (M) **ENT** to confirm the input number. Instead of pressing (M) **ENT** to tune into the channel immediately, you can wait a few seconds until this unit confirms the entered channel number.
- If no button is pressed within a few seconds after you enter a one-digit or two-digit number, this unit automatically confirms the entered channel number.
- Pressing a button other than the numeric buttons (B) or (M) **ENT** cancels the Direct Number Access mode procedure.

Setting XM Satellite Radio preset channels

You can use this feature to store up to 40 XM Satellite Radio channels (A1 to E8: 8 preset channel numbers in each of the 5 preset channel groups). You can then recall any preset channel easily by selecting the preset channel group and number as described in “Preset Search mode” on page 43.

1 Search for a channel you want to set as a preset channel by using one of the XM Satellite Radio search modes.

See “Basic XM Satellite Radio operations” on page 42 for details.

2 Press **MEMORY** (or **XM MEMORY**).

The MEMORY indicator flashes in the front panel display for approximately 10 seconds.

Note

You must proceed to and carry out steps 3 through 5 while the MEMORY indicator is flashing in the front panel display.

3 Press **CATEGORY** (or **A-E/CAT.** $\triangleleft/\triangleright$) repeatedly to select a preset channel group (A to E) while the MEMORY indicator is flashing.

The preset channel group letter appears in the front panel display.

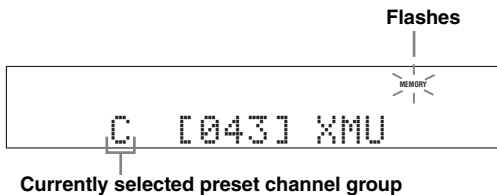

4 Press **PRESET/TUNING/CH** $\triangleleft/\triangleright$ (or **PRESET/CH** \triangle/∇) repeatedly to select a preset channel number (1 to 8) while the MEMORY indicator is flashing.

The preset channel number appears in the front panel display.

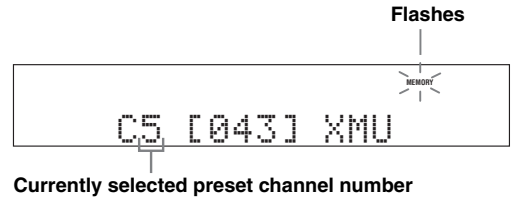

5 Press **MEMORY** (or **XM MEMORY**) to set the selected XM Satellite Radio channel as a preset channel while the MEMORY indicator is flashing.

A colon (:) appears next to the preset channel number for confirmation, and the MEMORY indicator turns off in the front panel display.

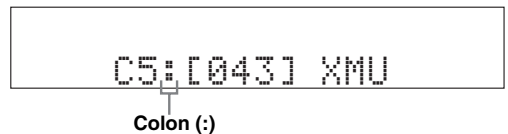

Note

Once you set a new preset channel, the one previously stored in the same preset channel group and number is cleared.

Displaying the XM Satellite Radio information

You can display the XM Satellite Radio information (such as channel number, channel name, category, artist name, or song title) for the currently selected channel in the front panel display or in the OSD.

Note

If a status message or an error message appears in the front panel display or in the OSD, see the “XM Satellite Radio (U.S.A. and Canada models only)” section in “Troubleshooting” on page 68 for appropriate remedies.

■ Displaying the XM Satellite Radio information in the front panel display

Press **7 DISPLAY** (or **Ⓢ DISPLAY**) repeatedly to toggle between the following XM Satellite Radio information display modes.

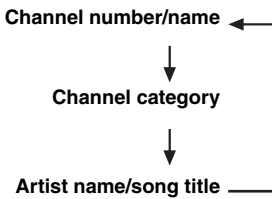

When the channel number / name is displayed:

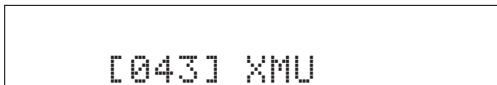

When the channel category is displayed:



When the artist name / song title is displayed:



- The front panel display can indicate up to 14 alphanumeric characters at once. You can set whether to display the XM Satellite Radio information in the front panel display in a continuous manner or by 14 alphanumeric characters at once by using the “FL SCROLL” parameter in “OPTION MENU” (see page 57).
- If the XM Satellite Radio information contains a character that cannot be recognized by this unit, the character will be displayed with a space.

Note

If you press **7 DISPLAY** (or **Ⓢ DISPLAY**) while the XM Satellite Radio information display is scrolling from right to left in the front panel display, the XM Satellite Radio information display mode toggles as described above.

■ Displaying the XM Satellite Radio information in the OSD

Press **7 DISPLAY** (or **Ⓢ DISPLAY**). The following screen is displayed in the OSD.

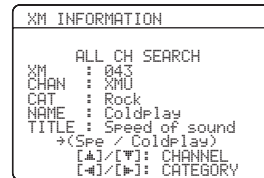

- To turn off the OSD, press **7 DISPLAY** (or **Ⓢ DISPLAY**) again.
- You can select the amount of time the XM Satellite Radio information is displayed in the OSD by using the “OSD-SOURCE” parameter in “OPTION MENU” (see page 57).
- To hold the XM Satellite Radio information screen, press **Ⓢ ENTER** while it is being displayed in the OSD. The XM Satellite Radio information screen on hold is released if you press **Ⓢ ENTER** on the remote control again or if you change the XM Satellite Radio channel.
- The XM Satellite Radio information screen on hold is released if you press **Ⓢ ENTER** on the remote control again or if you change the XM Satellite Radio channel.
- This unit can save up to two XM Satellite Radio information screens for future reference. To view the previous two XM Satellite Radio information screens, press **Ⓢ TITLE** repeatedly while the current XM Satellite Radio information screen is being hold.

Using iPod™

Once you have stationed your iPod in a Yamaha iPod universal dock (YDS-10, sold separately) connected to the DOCK terminal of this unit (see page 18), you can enjoy playback of your iPod using the supplied remote control. You can also use the Compressed Music Enhancer mode of this unit to improve the sound quality of the compression artifacts (such as the MP3 format) stored on your iPod (see page 18).

Notes

- Only iPod (Click and Wheel), iPod nano, and iPod mini are supported.
- Some features may not be compatible depending on the model or the software version of your iPod.



- For a complete list of the remote control functions used to control your iPod, see the “iPod” column in “Controlling other components” on page 61.
- For a complete list of status messages that appear in the front panel display and in the OSD, see the “iPod” section in “Troubleshooting” on page 70.
- Once your iPod is stationed in a Yamaha iPod universal dock, this unit begins signal transmission with your iPod.
- Once the connection between your iPod and this unit is complete, “iPod connected” appears in the front panel display and the DOCK indicator lights up in the front panel display.
- Only the analog audio and video signals of your iPod are input at the DOCK terminal, and the analog audio signals can be output at the analog AUDIO OUT (REC) jacks for recording.
- Your iPod battery is automatically charged when your iPod is stationed in a Yamaha iPod universal dock connected to the DOCK terminal of this unit as long as this unit is turned on.

Controlling iPod™

You can control your iPod when “V-AUX” is selected as the input source. The operations of your iPod can be done with the aid of the OSD of this unit (menu browse mode) or without it (simple remote mode).

■ Controlling iPod in the simple remote mode

You can perform the basic operations of your iPod (play, stop, skip, etc.) using the supplied remote control without the aid of the OSD of this unit.



- You can view the photos or video clips stored on your iPod.
- Operations can be also done with the controls on your iPod.

■ Controlling iPod in the menu browse mode

You can perform the advanced operations of your iPod using the supplied remote control when you connect this unit and a monitor using the S VIDEO or VIDEO connection. You can browse the songs stored on your iPod in the OSD. Further, you can change or adjust settings for your iPod to suit your personal preferences.



- The name of the song being played also appears in the front panel display according to the “FL SCROLL” parameter in “OPTION MENU” (see page 57).
- You can select the amount of time the iPod menu and play information is displayed in the OSD by using the “OSD-SOURCE” in “OPTION MENU” (see page 57)

Notes

- Operations cannot be done with the controls on your iPod.
- The Yamaha logo appears in the display window of your iPod.
- There are some characters that cannot be displayed in the front panel display or in the OSD of this unit. Those characters are replaced with underscores “_”.
- The “Settings” parameters can be changed or adjusted only in the OSD. Press **ⓈENTER** to toggle between the “Settings” parameter settings.
- You cannot browse the photos or video clips stored on your iPod in the OSD. Use the simple remote mode to enjoy watching the photos or video clips stored on your iPod.

- 1 Set the operation mode selector (K) to SOURCE and then press DISPLAY on the remote control.**

The following display appears in the OSD.

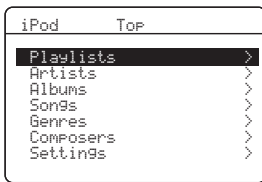

- 2 Press Δ / ∇ / \leftarrow / \rightarrow to navigate the iPod menu and then press ENTER to begin playback of the selected song.**

Choices: Playlists (playlists), Artists (artists), Albums (albums), Songs (songs), Genres (genres), Composers (composers), Settings (settings)

- Playlists > Songs
- Artists > Albums > Songs
- Albums > Songs
- Songs
- Genres > Artists > Albums > Songs
- Composers > Albums > Songs
- Settings > Shuffle, Repeat

Shuffle Shuffle

Use this feature to set this unit to play songs or albums in random order.

Choices: Off, Songs, Albums

- Select "Off" to deactivate this feature.
- Select "Songs" to set this unit to play songs in random order.
- Select "Albums" to set this unit to play albums in random order.



When "Shuffle" is set to a setting other than "Off", "☰" appears in the top right corner while songs or albums are being shuffled.

Repeat Repeat

Use this feature to set this unit to repeat one song or a sequence of songs.

Choices: Off, One, All

- Select "Off" to deactivate this feature.
- Select "One" to set this unit to repeat one song.
- Select "All" to set this unit to repeat a sequence of songs.



When "Repeat" is set to a setting other than "Off", "☰" or "☰_{All}" appears in the top right corner while one song or a sequence of songs are being repeated.

- **The function of the play information display**

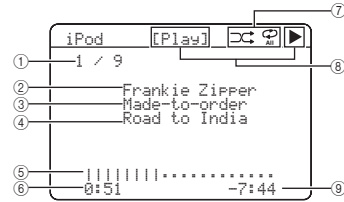

- ① Track number/total tracks
- ② Name of the artist
- ③ Name of the album
- ④ Name of the song
- ⑤ Progress bar
- ⑥ Elapsed time
- ⑦ Shuffle and repeat icons
- ⑧ \triangleright (playback), \square (pausing), \triangleright (search forward) and \triangleleft (search backward)
- ⑨ Remaining time

Recording

Recording adjustments and other operations are performed from the recording components. Refer to the operating instructions for those components.

Notes



- When this unit is set to the standby mode, you cannot record between other components connected to this unit.
- TONE CONTROL (see page 32) and VOLUME settings, speaker levels (see page 32) and the sound field programs (see page 35) do not affect recorded material.
- The source connected to the MULTI CH INPUT jacks of this unit cannot be recorded.
- The XM Satellite Radio signals cannot be output at the AUDIO OUT (REC) jacks.
- Digital signals input at the DIGITAL INPUT jacks are not output at the analog AUDIO OUT (REC) jacks for recording. Therefore, if your source component is connected to provide only digital signals, you cannot record the source.
- S-video and composite video signals pass independently through the video circuits of this unit. Therefore, when recording or dubbing video signals input from a video source component that provides only an S-video or a composite video signal, you can record only an S-video or a composite video signal on your DVD recorder.
- A given input source is not output on the same OUT (REC) channel.
- The analog audio signals input at the DOCK terminal can be output at the analog AUDIO OUT (REC) jacks for recording.
- Once you have connected a recording component to this unit, keep the component turned on while using this unit. If the component is turned off, this unit may distort the sound from other components.
- Check the copyright laws in your country to record from CDs, radio, etc. Recording of copyrighted material may infringe copyright laws.



Do a test recording before you start an actual recording.

If you play back a video source that uses scrambled or encoded signals to prevent it from being dubbed, the picture itself may be disturbed due to those signals.

1 Turn on all the connected components.

2 Press  INPUT </> repeatedly (or press one of the input selector buttons ()) to select the source component you want to record from.

3 Start playback on the selected source component or select a broadcast station.

4 Start recording on the recording component.

SET MENU

You can use the following parameters in “SET MENU” to adjust a variety of system settings and customize the way this unit operates. Change the initial settings (indicated in bold under each parameter) to reflect the needs of your listening environment.

■ Auto setup **AUTO SETUP**

Use this feature to automatically adjust speaker and system parameters (see page 22).

■ Manual setup **MANUAL SETUP**

Use this feature to manually adjust speaker and system parameters.

Sound menu 1 **SOUND MENU**

Use this menu to manually adjust any speaker settings, alter the quality and tone of the sound output by the system or compensate for video signal processing delays when using LCD monitors or projectors.

Parameter	Features	Page
A)SPEAKER SET	Selects the size of each speaker, the speakers for low-frequency signal output, and the crossover frequency, and the location of the front speakers connected to the FRONT B terminals.	51
B)SP LEVEL	Adjusts the output level of each speaker.	53
C)SP DISTANCE	Adjusts the delay time of each speaker.	53
D)CENTER GEQ	Adjusts the tonal quality of the center speaker.	54
E)LFE LEVEL	Adjusts the output level of the LFE channel for Dolby Digital or DTS signals.	54
F)D. RANGE	Adjusts the dynamic range of Dolby Digital or DTS signals.	54
G)AUDIO SET	Adjusts the muting level, audio delay, maximum volume level and initial volume level.	54

Input menu 2 **INPUT MENU**

Use this menu to manually reassign the input jacks, select the input mode or rename the input source.

Parameter	Features	Page
A)INPUT ASSIGN	Assigns the input jacks of this unit according to the component to be used.	55
B)INPUT RENAME	Changes the name of the input source.	56
C)VOLUME TRIM	Adjusts the output volume of each input source.	56
D)DECODER MODE	Selects the decoder mode for the sources connected to the DIGITAL INPUT jacks on the rear panel of this unit.	56
E)MULTI CH SET	Selects the video source played in the background of the sources input from the MULTI CH INPUT jacks.	57

Option menu 3 OPTION MENU

Use this menu to manually adjust the optional system parameters.

Parameter	Features	Page
A)DISPLAY SET	Adjusts the brightness of the front panel display and the way in which the XM and iPod information is displayed.	57
B)MEMORY GUARD	Locks sound field program parameters and other “SET MENU” settings.	58
C)AUDIO SELECT	Designates the default audio input jack select setting for the input sources connected to the DIGITAL INPUT jacks when you turn on the power of this unit.	58
D)PARAM. INI	Initializes the parameters of a group of sound field programs.	58
E)XM RADIO SET	Displays the current reception level of the XM Satellite Radio signals.	58

Note

The “XM RADIO SET” parameter is only applicable to the U.S.A. and Canada models.

■ Signal information SIGNAL INFO

Use this feature to check audio signal information (see page 33).

Using SET MENU

Use the remote control to access and adjust each parameter.



You can change the “SET MENU” parameters while this unit is reproducing sound.

- 1 Set the operation mode selector to AMP and then press **Ⓝ**SET MENU to enter “SET MENU”.**

The top “SET MENU” display appears in the OSD.

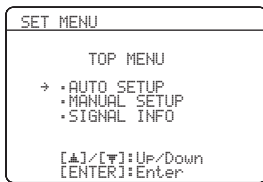

- 2 Press **Ⓢ**△/▽ to select “MANUAL SETUP”.**

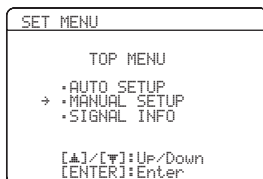

- 3 Press **Ⓢ**ENTER to enter “MANUAL SETUP”.**

The “MANUAL SETUP” display appears in the OSD.

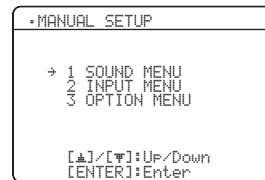

- 4 Press **Ⓢ**△/▽/◀/▶ and **Ⓢ**ENTER to select and change the parameter.**

- Press **Ⓢ**△/▽ to select the desired menu or parameter.
- Press **Ⓢ**◀/▶ to change the parameter value.
- Press **Ⓢ**ENTER to enter the selected menu or to confirm the parameter.
- Press **Ⓢ**RETURN to return to the previous menu level.

- 5 Press **Ⓝ**SET MENU to exit from “SET MENU”.**

1 SOUND MENU

Use this menu to manually adjust any speaker settings or compensate for video signal processing delays when using LCD monitors or projectors.

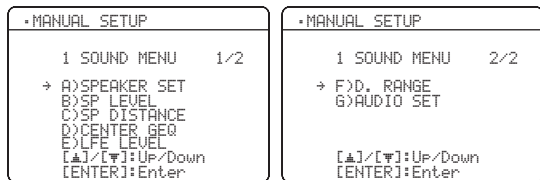

■ Speaker settings A) SPEAKER SET

Use this feature to manually adjust any speaker settings.

FRONT B speaker setting FRONT B

Use this feature to select the location of the front speakers connected to the FRONT B terminals.

Choices: **FRONT**, ZONE B



- Select "FRONT" to turn on or off SPEAKERS A and B when the speakers connected to the FRONT B terminals are set in the main zone.
- Select "ZONE B" if the speakers connected to the FRONT B terminals are set in another zone. If SPEAKERS A is turned off and SPEAKERS B is turned on, all the speakers including the subwoofer in the main zone are muted and this unit outputs sound at the FRONT B terminals only.

Notes

- If you connect headphones to the PHONES jack of this unit, the sound is output from both headphones and the FRONT B terminals when "FRONT B" is set to "ZONE B".
- If a DSP program is selected when "FRONT B" is set to "ZONE B", this unit automatically enters the Virtual CINEMA DSP mode (see page 36).

Woofer section of a speaker is 16 cm (6.5 in) or larger: large
Woofer section of a speaker is smaller than 16 cm (6.5 in): small

Front speakers FRONT SP

Choices: SMALL, **LARGE**

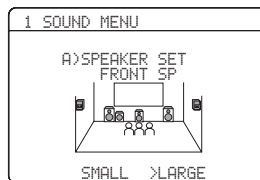

When the front speakers are large

Select "LARGE" (large).

When the front speakers are small

Select "SMALL" (small).

Note

When "LFE/BASS OUT" is set to "FRNT" (see page 52), you can select only "LARGE" in "FRONT SP". If the value of "FRONT SP" is set to a setting other than "LARGE" in advance, this unit automatically changes the value to "LARGE".

Center speaker CENTER SP

Choices: NONE, **SML**, LRG



When the center speaker is large

Select "LRG" (large).

When the center speaker is small

Select "SML" (small).

When you do not use the center speaker

Select "NONE" (none). The center channel signals are directed to the front left and right speakers.

Surround left/right speakers SUR. L/R SP

Choices: NONE, **SML**, LRG

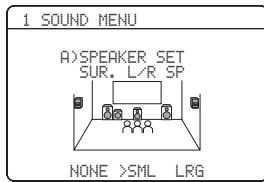

When the surround speakers are large

Select "LRG" (large).

When the surround speakers are small

Select "SML" (small).

When you do not use the surround speakers

Select "NONE" (none). This unit is set to the Virtual CINEMA DSP mode (see page 36).

LFE Bass out LFE/BASS OUT

Use this feature to select the speakers that output the LFE (low-frequency effect) and the low-frequency signals.

Choices: SWFR, FRNT, **BOTH**

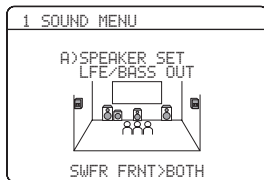

When a subwoofer is connected to this unit and you want to get natural bass sound

Select "SWFR" (subwoofer). The LFE signals as well as the low-frequency signals of other speakers set to "SML" (or "SMALL") are directed to the subwoofer.

When a subwoofer is connected to this unit and you want to get rich bass sound

Select "BOTH" (both). The low-frequency signals of any source are output from the subwoofer. The LFE signals as well as the low-frequency signals of other speakers set to "SML" (or "SMALL") are directed to the subwoofer. The low-frequency signals of the front left and right channels are directed to the front left and right speakers and the subwoofer regardless of the "FRONT SP" setting (see page 51).

When you do not use a subwoofer

Select "FRNT" (front). The LFE signals, the low-frequency signals of the front left and right channels, and the low-frequency signals of other speakers set to "SML" (or "SMALL") are all directed to the front left and right speakers regardless of the "FRONT SP" setting (see page 51).

Crossover CROSSOVER

Use this feature to select a crossover frequency of all the speakers set to "SML" (or "SMALL") or to "NONE" in "SPEAKER SET" (see pages 50 and 51). All frequencies below the selected frequency will be sent to the subwoofer or to the speakers set to "LRG" (or "LARGE") in "SPEAKER SET" (see pages 50 and 51).

Choices: 40Hz, 60Hz, **80Hz**, 90Hz, 100Hz, 110Hz, 120Hz, 160Hz, 200Hz



Subwoofer phase SUBWOOFER PHASE

Use this feature to switch the phase of your subwoofer if bass sounds are lacking or unclear.

Choices: **NORMAL**, REVERSE

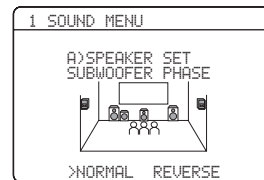

- Select "NORMAL" if you do not want to reverse the phase of your subwoofer.
- Select "REVERSE" to reverse the phase of your subwoofer.

■ Speaker level B)SP LEVEL

Use this feature to manually adjust the output level of each speaker.

Control range: -10 to +10 dB

Control step: 1 dB

Initial setting: 0 dB

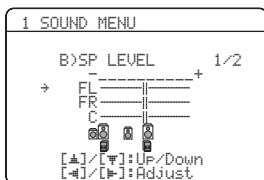

SP LEVEL	Adjusted speaker
FL	Front left speaker
FR	Front right speaker
C	Center speaker
SL	Surround left speaker
SR	Surround right speaker
SWFR	Subwoofer

Note

The available speaker channels differ depending on the setting of the speakers.

■ Speaker distance C)SP DISTANCE

Use this feature to manually adjust the distance of each speaker and the delay applied to the respective channel.

Ideally, each speaker should be the same distance from the main listening position. However, this is not possible in most home situations. Thus, a certain amount of delay must be applied to the sound from each speaker so that all sounds will arrive at the listening position at the same time.

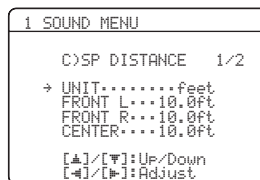

Unit UNIT

Choices: meters (m), feet (ft)

Initial setting:

[U.S.A. and Canada models]: feet (ft)

[Other models]: meters (m)

- Select “meters” to adjust speaker distances in meters.
- Select “feet” to adjust speaker distances in feet.

Speaker distances

Control range: 0.30 to 24.00 m (1.0 to 80.0 ft)

Control step: 0.10 m (0.5 ft)

Initial setting: 3.00 m (10.0 ft)

SP DISTANCE	Adjusted speaker
FRONT L	Front left speaker
FRONT R	Front right speaker
CENTER	Center speaker
SUR. L	Surround left speaker
SUR. R	Surround right speaker
SWFR	Subwoofer

Note

The available speaker channels differ depending on the setting of the speakers.

Center speaker equalizer D>CENTER GEQ

Use this feature to adjust the built-in 5-frequency band (100Hz, 300Hz, 1kHz, 3kHz and 10kHz) graphic equalizer for the center channel so that the tonal quality of the center speaker matches that of the front speakers. You can make adjustments while listening to the currently selected source component or a test tone.

Control range: -6.0 to +6.0 dB

Control step: 0.5 dB

Initial setting: 0 dB

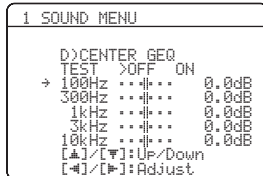

Test tone TEST

Use this feature to make adjustments for “CENTER GEQ” while listening to a test tone.

Choices: **OFF**, **ON**

- Select “OFF” to stop test tones and output the currently selected source component.
- Select “ON” to output test tones from the center and front left speakers.

Low-frequency effect level E>LFE LEVEL

Use this feature to adjust the output level of the LFE (low-frequency effect) channel according to the capacity of your subwoofer or headphones. The LFE channel carries low-frequency special effects which are only added to certain scenes. This setting is effective only when this unit decodes Dolby Digital or DTS signals.

Control range: -20 to **0** dB

Control step: 1 dB



Speaker SPEAKER

Adjusts the speaker LFE level.

Headphone HEADPHONE

Adjusts the headphone LFE level.

Note

Depending on the settings of “LFE/BASS OUT” (see page 52), some signals may not be output at the SUBWOOFER OUTPUT jack.

Dynamic range F>D. RANGE

Use this feature to select the amount of dynamic range compression to be applied to your speakers or headphones. This setting is effective only when this unit is decoding Dolby Digital and DTS signals.

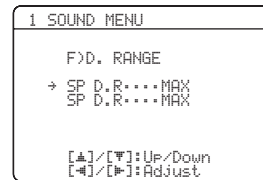

Speaker SP

Adjusts the speaker compression.

Headphone HF

Adjusts the headphone compression.

Choices: MIN, STD, **MAX**

- Select “MIN” (minimum) if you regularly listen at low volume levels.
- Select “STD” (standard) for general use.
- Select “MAX” (maximum) to preserve the greatest amount of dynamic range.

Audio settings G>AUDIO SET

Use this feature to adjust the overall audio settings of this unit.

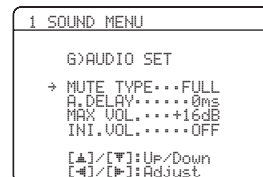

Mute type MUTE TYPE

Use this feature to adjust how much the mute function reduces the output volume (see page 34).

Choices: **FULL**, -20dB

- Select “FULL” to completely mute all the audio output.
- Select “-20dB” to reduce the current volume by 20 dB.

Audio delay A.DELAY

Use this feature to delay the sound output and synchronize it with the video image. This may be necessary when using certain LCD monitors or projectors.

Control range: **0** to 160 ms

Control step: 1 ms

Maximum volume MAX VOL.

Use this feature to set the maximum volume level. This feature is useful to avoid the unexpected loud sound by mistake. For example, the original volume range is 16 dB to -80 dB. However, when "MAX VOL." is set to -5 dB, the volume range becomes -5 dB to -80 dB.

Control range: **16 dB**, 10 dB to -30 dB

Control step: 5 dB

Note

The "MAX VOL." setting takes priority over the "Initial Volume" setting. For example, if "INI VOL." is set to -20 dB and "MAX VOL." is set to -30 dB, the volume level is automatically set to -30 dB when you turn on the power of this unit next time.

Initial volume INI VOL.

Use this feature to set the volume level when the power of this unit is turned on.

Choices: **Off**, -80 dB to +16 dB

Control step: 1 dB

Note

The "MAX VOL." setting takes priority over the "INI VOL." setting.

2 INPUT MENU

Use this menu to reassign the input jacks, select the decoder mode or rename the input source.

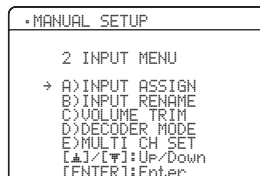
**Input assignment****A) INPUT ASSIGN**

Use this feature to assign the input jacks according to the component to be used if the initial settings of this unit do not correspond to your needs. Change the following parameters to reassign the respective jacks and effectively connect more components.

Once the input jacks are reassigned, you can select the corresponding component by using **INPUT** \leftarrow/\rightarrow (or the input selector buttons (A)).

For COAXIAL INPUT jack 1

COAXIAL IN (1)

Choices: (1) CD, MD/CD-R, **DVD**, DTV/CBL, V-AUX, DVR

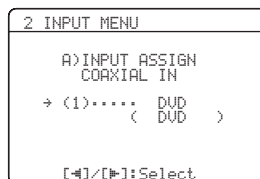
**For OPTICAL INPUT jacks 2 and 3**

OPTICAL IN (2)

OPTICAL IN (3)

Choices: (2) CD, MD/CD-R, DVD, **DTV/CBL**, V-AUX, DVR

(3) **CD**, MD/CD-R, DVD, DTV/CBL, V-AUX, DVR

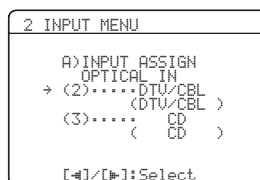
**Note**

You cannot select a specific item more than once.

■ **Input rename** B)INPUT RENAME

Use this feature to change the name of the input source that appears in the OSD and in the front panel display.

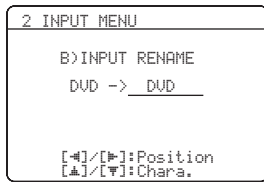

- 1 Press one of the input selector buttons (A) to select the input source you want to change the name of.

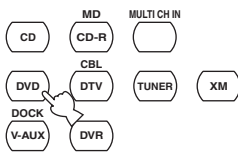

- 2 Set the operation mode selector (K) to AMP and then press D◀/▶ on the remote control to place the “_” (underscore) under the space or the character you want to edit.

- 3 Press D▲/▼ to select the character you want to use and then press D◀/▶ to move to the next space.

Notes

- You can use up to 8 characters for each input.
- Press D▼ to change the character in the following order, or press D▲ to go in the reverse order:
A to Z, a space, 0 to 9, a space, a to z, a space, symbols (#, *, -, +, etc.)

- 4 Repeat steps 1 through 3 to rename each input source.

- 5 Press DENTER to exit from “INPUT RENAME”.

■ **Volume trim** C)VOLUME TRIM

Use this feature to adjust the output volume of each source. This is useful if you want to balance the level of each input source to avoid sudden changes in volume when switching between input sources.

Choices: CD, **MD/CD-R**, TUNER, DVD, DTV/CBL, V-AUX, DVR, DOCK, MULTI CH IN, XM

Control range: -6.0 to +6.0 dB

Control step: 1.0 dB

Initial setting: 0.0 dB

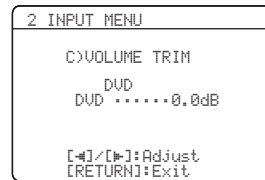

Note

You can only adjust the value for DOCK when your iPod is stationed in the Yamaha Universal Dock connected to this unit.

■ **Decoder mode** D)DECODER MODE

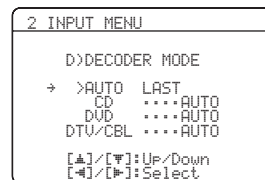

Decoder select mode

Use this feature to designate the default decoder mode for the input sources connected to the DIGITAL INPUT jacks when you turn on the power of this unit.

Choices: **AUTO**, LAST

- Select “AUTO” if you want this unit to automatically detect the type of input signals and select the appropriate decoder mode.
- Select “LAST” if you want this unit to automatically select the last decoder mode used the connected input source.

DTS decoder prioritize setting

Choices: **AUTO**, DTS

- Select “AUTO” if you want this unit to automatically detect input signal types and select the appropriate input mode.
- Select “DTS” when you play back a DTS-CD.

Multi channel input setup

E>MULTI CH SET

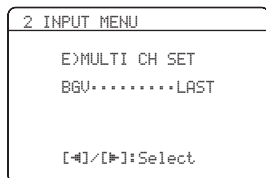

Background Video BGV

Use this feature to select the video source played in the background of the sources input at the MULTI CH INPUT jacks.

Choices: DVD, DTV/CBL, V-AUX, DVR, **LAST**



Select "LAST" to set this unit to automatically select the last selected video source as the background video source.

3 OPTION MENU

Use this menu to adjust the optional system parameters.

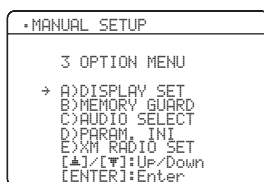

Display settings A>DISPLAY SET



Dimmer DIMMER

Use this feature to adjust the brightness of the front panel display.

Control range: -4 to 0

Control step: 1

- Press $\odot \triangleleft$ to make the front panel display dimmer.
- Press $\odot \triangleright$ to make the front panel display brighter.

Front panel display scroll FL SCROLL

Use this feature to set whether to display the information (such as a song title or a channel name) in the front panel display in a continuous manner or by the first 14 alphanumeric characters after scrolling all characters once when "XM" or "DOCK" is selected as the input source.

Choices: **CONT**, ONCE

- Select "CONT" to display the operation status in the front panel display in a continuous manner.
- Select "ONCE" to display the operation status in the front panel display by the first 14 alphanumeric characters after scrolling all characters once.

OSD shift OSD SHIFT

Use this feature to adjust the vertical position of the OSD.

Control range: -5 (upward) to +5 (downward)

Control step: 1

Initial setting: 0

- Press $\odot \triangleleft$ to raise the position of the OSD.
- Press $\odot \triangleright$ to lower the position of the OSD.

Source feature OSD display time

OSD-SOURCE

Use this feature to set the amount of time to display the XM Satellite Radio information or iPod menu in the OSD after you perform a certain operation.

Choices: ON, 10s, **30s**

- Select "ON" to display the OSD unceasingly during an operation.
- Select "10s" to turn off the OSD 10 seconds after you perform a certain operation.
- Select "30s" to turn off the OSD 30 seconds after you perform a certain operation.

Amplifier function OSD display time

OSD-AMP

Use this feature to set the amount of time to display the status and sound field parameters information screen after you perform a certain operation.

Choices: ON, 10s, **30s**

- Select "ON" to display the OSD constantly during an operation.
- Select "10s" to turn off the OSD 10 seconds after you perform a certain operation.
- Select "30s" to turn off the OSD 30 seconds after you perform a certain operation.

■ **Memory guard** B)MEMORY GUARD

Use this feature to prevent accidental changes to DSP program parameter values and other system settings.

Choices: **OFF**, **ON**

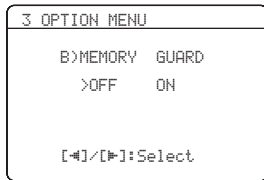

- Select “OFF” to turn off the “MEMORY GUARD” feature.
- Select “ON” to protect:
 - sound field program parameters
 - all “SET MENU” items
 - all speaker levels
 - SCENE template parameters

Note

When “MEMORY GUARD” is set to “ON”, you cannot select and adjust any other “SET MENU” items.

■ **Audio select** C)AUDIO SELECT

Use this feature to designate the default audio input jack select setting for the input sources when you turn on the power of this unit.

Choices: **AUTO**, **LAST**

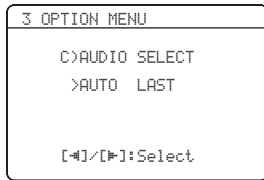

- Select “AUTO” if you want this unit to automatically detect the type of input signals and select the appropriate input mode.
- Select “LAST” if you want this unit to automatically select the last input mode used for the connected input source (see page 31).

■ **Parameter initialization** D)PARAM. INI

Use this feature to set all the parameters of the sound field programs to the initial factory settings.

Choices: **NO**, **YES**

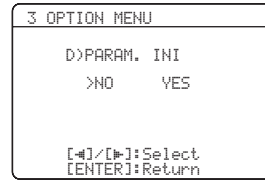

- Select “NO” to cancel the parameter initialization and return to the previous menu screen.
- Select “YES” to set all the sound field parameters to the initial factory settings.

Notes

- You cannot automatically revert to the previous parameter settings once you initialize the sound field program parameters.
- You cannot separately initialize individual sound field programs.
- You cannot initialize any sound field program groups when “MEMORY GUARD” is set to “ON”.

■ **XM Radio setting** E)XM RADIO SET (U.S.A. and Canada models only)

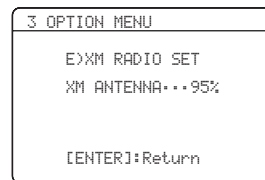

XM Radio antenna XM ANTENNA

Use this feature to check the current reception level of the XM Satellite Radio signals. For the best reception, orient XM Mini-Tuner so that a value of 60% or more is displayed here.

Display status: **NONE**, 0 to 100%

Note

“NONE” is displayed if XM Mini-Tuner Dock is not connected to this unit. In this case, check the antenna connections (see page 41).

Remote control features

In addition to controlling this unit, the remote control can also operate other audiovisual components made by Yamaha and other manufacturers. To control your TV or other components, you must set up the appropriate remote control code for each input source (see page 62).

Using remote control on the SCENE feature

■ Controlling the input source components in the SCENE mode

You can operate both this unit and the input source component by using the remote control. You must set the appropriate remote control code for each input source in advance (see page 62).

- 1 Press the desired **F SCENE** button on the remote control.
- 2 Press the desired buttons in the * area below to control the input source component of the selected SCENE template.

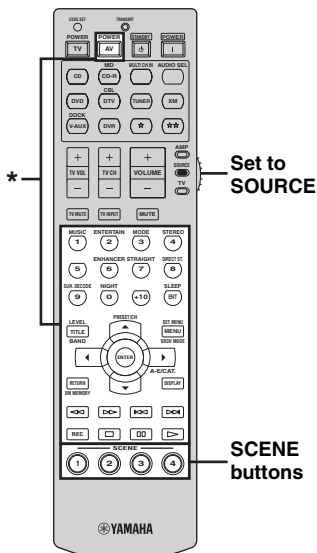

Note

* These buttons control the input source component. See page 61 for details of the function of each button.

■ Setting input source of the customized SCENE template on the remote control

If you customize the input source of the selected SCENE template, you must set the input source of the SCENE template on the remote control to operate the input source component correctly.

- 1 Press the desired **F SCENE** button on the remote control.
- 2 Press and hold the **F SCENE** button and the desired input selector button (**A**) for 3 seconds.
When the setting of the input source is successful, the **V TRANSMIT** indicator flashes twice.
- 3 Keep holding down the buttons pressed in step 2 until the **V TRANSMIT** indicator flashes twice again.

Note

If the setting of the input source is not successful, the **V TRANSMIT** indicator flashes repeatedly. In this case, carry out the step 1 and 2 again.

Controlling this unit, a TV, or other components

■ Controlling this unit

Set the operation mode selector ((K)) to **AMP** to control this unit.

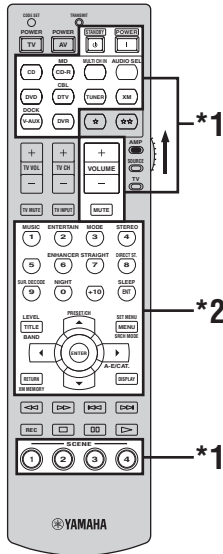

■ Controlling a TV

Set the operation mode selector to TV to control your TV. To control your TV, you must set the appropriate remote control code for DTV/CBL (see page 62).

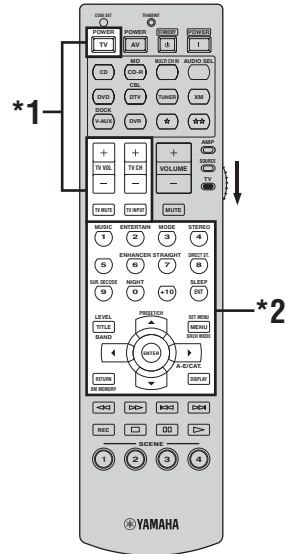

Notes

- *1 These buttons always control this unit regardless of the operation mode selector position.
- *2 These buttons control this unit only when the operation mode selector ((K)) is set to **AMP**.

Notes

- *1 These buttons always control your TV regardless of the operation mode selector position.

Remote control	Digital TV/Cable TV
TV POWER	Turns on or off the power.
TV VOL +/-	Increases or decreases the volume level.
TV CH +/-	Changes the channel number.
TV MUTE	Mutes the audio output.
TV INPUT	Changes the input source.

- *2 These buttons control your TV only when the operation mode selector is set to TV. For details, see the “Digital TV/Cable TV” column on page 61.

■ Controlling other components

Set the operation mode selector (Ⓢ) to **SOURCE** to control other components selected with the input selector buttons. You must set the appropriate remote control code for each input source in advance (see page 62). The following table shows the function of each control button used to control other components assigned to each input selector button. Be advised that some buttons may not correctly operate the selected component.



The remote control has 10 modes (input areas) to control components so that the remote control can operate up to 10 different components.

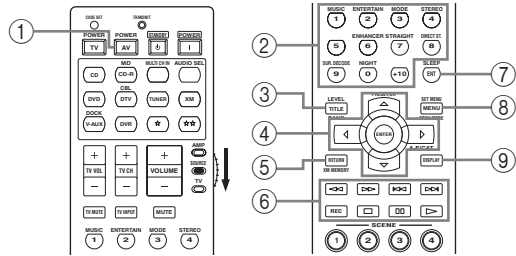

Remote control	DVD player/recorder	VCR	Digital TV/Cable TV	LD player	CD player	MD/CD recorder	Tuner	iPod
① AV POWER	Power *1	Power *1	Power *2	Power *1	Power *1	Power *1		
② 1-9, 0, +10	Numeric buttons	Numeric buttons	Numeric buttons	Numeric buttons	Numeric buttons	Numeric buttons	Preset stations (1-8)	
③ TITLE	Title						Band	
④ PRESET/CH Δ	Up	VCR channel up	Up				Preset up (1-8)	Up
PRESET/CH ∇	Down	VCR channel down	Down				Preset down (1-8)	Down
A-E/CAT. \triangleleft	Left		Left				Preset down (A-E)	Previous menu
A-E/CAT. \triangleright	Right		Right				Preset up (A-E)	Subsequent menu
ENTER	Enter		Enter					Subsequent menu
⑤ RETURN	Return		Return					
⑥ REC/DISC SKIP	Disc skip (player) Rec (recorder)	Rec	Rec *2		Disc skip	Rec		
\triangleright	Play	Play	Play *2	Play	Play	Play		Play (Play/pause)*4
$\triangleleft\triangleleft$	Search backward	Search backward	Search backward *2	Search backward	Search backward	Search backward		Search backward *3
$\triangleright\triangleright$	Search forward	Search forward	Search forward *2	Search forward	Search forward	Search forward		Search forward *3
\square	Pause	Pause	Pause *2	Pause	Pause	Pause		Pause (Play/pause)*4
$\triangleleft\triangleleft$	Skip backward	Skip backward	Skip backward *2	Skip backward	Skip backward	Skip backward		Skip backward
$\triangleright\triangleright$	Skip forward	Skip forward	Skip forward *2	Skip forward	Skip forward	Skip forward		Skip forward
\square	Stop	Stop	Stop *2	Stop	Stop	Stop		Stop
⑦ ENT	Title/Index	Enter	Enter	Chapter/Time	Index	Index		
⑧ MENU	Menu		Menu					Previous menu
⑨ DISPLAY	Display	Display	Display	Display	Display	Display		Display

Notes

*1 This button is operational only when the original remote control supplied with the component has a POWER button.

*2 These buttons operate your DVD recorder only when you set the appropriate remote control code for DVR (see page 62).

*3 Press and hold to search backward or forward.

*4 Simple remote mode (see page 46).

Setting remote control codes

You can control other components by setting the appropriate remote control codes. For a complete list of available remote control codes, refer to “List of remote control codes” at the end of this manual.

Remote control code default settings

Input source	Component category	Manufacturer	Default code
CD	CD	YAMAHA	62000
MD/CD-R	CD-R	YAMAHA	71292
DVD	DVD	YAMAHA	42000
DTV/CBL	–	–	–
TUNER	TUNER	YAMAHA	82005
XM	TUNER	YAMAHA	82006
V-AUX	OTHER AUDIO ACCESSORIES (iPod)	YAMAHA	82000
DVR	DVR	YAMAHA	52001
☆	–	–	–
☆☆	–	–	–

Note

You may not be able to operate your Yamaha component even if a Yamaha remote control code is preset as listed above. In this case, try setting another Yamaha remote control code.

- 1 Press one of the input selector buttons (A) on the remote control to select the input area you want to set up.

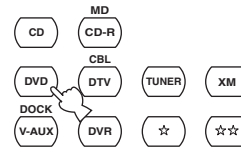

- 2 Press **CODE SET** using a ballpoint pen or a similar object.

The TRANSMIT indicator on the remote control flashes twice, and selected input selector button lights up.

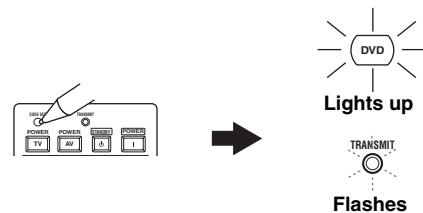

- 3 Press the numeric buttons (0 to 9) (B) to enter the five-digit remote control code for the component to be used.

The TRANSMIT indicator on the remote control flashes twice, and the remote control code for the selected component is set.



Refer to “List of remote control codes” at the end of this manual.

Notes

- If the manufacturer of your component has more than one code, try each of them until you find the correct one.
- If you do not press any buttons within 30 seconds in step 3, the setup process is canceled. If this happens, repeat the setup procedure.
- If you enter the code number “9980”, the remote control code previously set for the selected input area is cleared.

Resetting all remote control codes

Use this feature to clear all the remote control codes previously set and reset all of them to the initial factory settings.

1 Press **CODE SET** using a ballpoint pen or a similar object.

The TRANSMIT indicator on the remote control flashes twice.



2 Press the numeric buttons to enter the code number "9981".

The TRANSMIT indicator on the remote control flashes twice, and all the remote control codes previously set are cleared and reset to the initial factory settings.

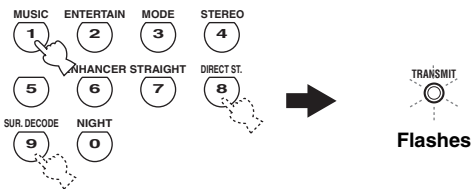

If you do not press any buttons within 30 seconds after step 2, the clearing process is canceled. In this case, repeat the clearing procedure.

Advanced setup

This unit has additional menus that are displayed in the front panel display. The advanced setup menu offers additional operations to adjust and customize the way this unit operates. Change the initial settings (indicated in bold under each parameter) to reflect the needs of your listening environment.

Notes

- Only **① STANDBY/ON**, **⑫ STRAIGHT** and **⑪ PROGRAM** </> are effective while you are using the advanced setup menu.
- No other operations can be made while you are using the advanced setup menu.
- The advanced setup menu is only available in the front panel display.

1 Press ① STANDBY/ON on the front panel to set this unit to the standby mode.

2 Press and hold ⑩ TONE CONTROL and then press ① STANDBY/ON to turn on this unit.

This unit turns on, and the advanced setup menu appears in the front panel display.

3 Press ⑪ PROGRAM </> to select the parameter you want to adjust.

The name of the selected parameter appears in the front panel display.

4 Press ⑫ STRAIGHT repeatedly to change the selected parameter setting.

5 Press ① STANDBY/ON to confirm your selection and set this unit to the standby mode.



The settings you made are reflected next time you turn on this unit.

■ Speaker impedance SP IMP. (U.S.A. and Canada models only)

Use this feature to set the speaker impedance of this unit so that it matches that of your speakers.

Choices: **8Ω MIN**, 6Ω MIN

- Select “8Ω MIN” to set the speaker impedance to 8 Ω .
- Select “6Ω MIN” to set the speaker impedance to 6 Ω .

SP IMP.	Speaker	Impedance level
8Ω MIN	Front (A or B)	The impedance of each speaker must be 8 Ω or higher.
	Center	
	Surround	
6Ω MIN	Front (A or B)	The impedance of each speaker must be 6 Ω or higher.
	Center	
	Surround	

■ Factory presets PRESET

Use this feature to reset all the parameters of this unit to the initial factory settings (see page 71).

Choices: **CANCEL**, RESET

- Select “CANCEL” not to reset any parameters of this unit.
- Select “RESET” to reset the parameters of this unit.

Notes

- This setting completely resets all the parameters of this unit including the “SET MENU” parameters. However, the advanced setup menu parameters will not be initialized.
- The initial factory settings are activated next time you turn on this unit.

■ Tuner frequency step TU (Asia and General models only)

Use this feature to set the tuner frequency step according to the frequency spacing in your area.

Choices: **AM10/FM100**, AM9/FM50

- Select “AM10/FM100” for North, Central and South America.
- Select “AM9/FM50” for all other areas.

Troubleshooting

Refer to the table below when this unit does not function properly. If the problem you are experiencing is not listed below or if the instruction below does not help, turn off this unit, disconnect the power cable, and contact the nearest authorized Yamaha dealer or service center.

■ General

Problem	Cause	Remedy	See page
This unit fails to turn on or enters the standby mode soon after the power is turned on.	The power cable is not connected or the plug is not completely inserted.	Connect the power cable firmly.	—
	The speaker impedance setting is incorrect.	Set the speaker impedance to match your speakers.	13
	The protection circuitry has been activated.	Make sure that all speaker wire connections on this unit and on all speakers are secure and that the wire for each connection does not touch anything other than its respective connection.	12
	This unit has been exposed to a strong external electric shock (such as lightning or strong static electricity).	Set this unit to the standby mode, disconnect the power cable, plug it back in after 30 seconds and then use it normally.	—
No sound	Incorrect input or output cable connections.	Connect the cables properly. If the problem persists, the cables may be defective.	14-17
	No appropriate Audio input jack select has been set.	Set an appropriate Audio input jack select.	31
	No appropriate input source has been selected.	Select an appropriate input source with Ⓔ INPUT $\triangleleft/\triangleright$ on the front panel (or the input selector buttons on the remote control).	30, 31
	Speaker connections are not secure.	Secure the connections.	12
	The front speakers to be used have not been selected properly.	Select the front speakers with Ⓗ SPEAKERS on the front panel.	31
	The volume is turned down.	Turn up the volume.	—
	The sound is muted.	Press Ⓕ MUTE or Ⓖ VOLUME +/- on the remote control to resume audio output and then adjust the volume.	34
	Signals this unit cannot reproduce are being input from a source component, such as a CD-ROM.	Play a source whose signals can be reproduced by this unit.	—

Problem	Cause	Remedy	See page
The sound suddenly goes off.	The protection circuitry has been activated because of a short circuit, etc.	Check that the impedance setting is correct. Check that the speaker wires are not touching each other and then turn this unit back on.	13 —
	The sleep timer has turned off this unit.	Turn on this unit, and play the source again.	—
	The sound is muted.	Press MUTE or VOLUME +/- on the remote control to resume audio output.	34
Sound is heard from the speaker on one side only.	Incorrect cable connections.	Connect the cables properly. If the problem persists, the cables may be defective.	14-17
	Incorrect settings in "SP LEVEL".	Adjust the "SP LEVEL" settings.	32
Only the center speaker outputs substantial sound.	When playing a monaural source with a CINEMA DSP program, the source signal is directed to the center channel, and the front and surround speakers output effect sounds.	This is not malfunction.	—
No sound is heard from the center speaker.	"CENTER" in "SET MENU" is set to "NONE".	Set "CENTER" to "SML" or "LRG".	51
	One of the HiFi DSP programs (except for 5ch Stereo) has been selected.	Try another sound field program.	35
No sound is heard from the surround speakers.	"SUR. L/R SP" in "SPEAKER SET" is set to "NONE".	Set "SUR. L/R SP" to "SML" or "LRG".	52
	This unit is in the "STRAIGHT" mode and a monaural source is being played back.	Press STRAIGHT on the front panel so that "STRAIGHT" disappears from the front panel display.	36
No sound is heard from the subwoofer.	"BASS" in "SPEAKER SET" is set to "FRNT" when a Dolby Digital or DTS signal is being played.	Set "BASS" to "SWFR" or "BOTH".	52
	"BASS" in "SPEAKER SET" is set to "SWFR" or "FRNT" when a 2-channel source is being played.	Set "BASS" to "SWFR" or "BOTH".	52
	The source does not contain low-frequency bass signals.	This is not malfunction.	—

Problem	Cause	Remedy	See page
Dolby Digital or DTS sources cannot be played. (Dolby Digital or DTS indicator in the front panel display does not light up.)	The connected component is not set to output Dolby Digital or DTS digital signals.	Make an appropriate setting following the operating instructions for your component.	—
	Audio input jack select is set to “ANALOG”.	Set Audio input jack select to “AUTO”.	31
A humming sound is heard.	Incorrect cable connections.	Connect the audio cables firmly. If the problem persists, the cables may be defective.	—
The volume level cannot be increased, or the sound is distorted.	You are attempting to set the volume level higher than the maximum volume level.	Adjust “MAX VOL.” setting.	55
	The component connected to the AUDIO OUT (REC) jacks of this unit is turned off.	Turn on the power of the component.	—
The sound effect cannot be recorded.	It is not possible to record the sound effect with a recording component.	This is not malfunction.	—
A source cannot be recorded by an analog component connected to the AUDIO OUT (REC) jacks.	The source component is not connected to the analog AUDIO IN jacks of this unit.	Connect the source component to the analog AUDIO IN jacks.	15, 17
The sound field parameters and some other settings of this unit cannot be changed.	“MEMORY GUARD” in “OPTION MENU” is set to “ON”.	Set “MEMORY GUARD” to “OFF”.	58
This unit does not operate properly.	The internal microcomputer has been frozen by an external electric shock (such as lightning or excessive static electricity) or by a power supply with low voltage.	Disconnect the power cable from the AC wall outlet and then plug it in again after about 30 seconds.	—
“CHECK SP WIRES” appears in the front panel display.	Speaker cables are short-circuited.	Make sure all speaker cables are connected correctly.	12
There is noise interference from digital or radio frequency equipment.	This unit is too close to the digital or high-frequency equipment.	Move this unit further away from such equipment.	—
The picture is disturbed.	The video source uses scrambled or encoded signals to prevent dubbing.	This is not malfunction.	—
This unit suddenly enters the standby mode.	The internal temperature is too high and the overheat protection circuitry has been activated.	Wait about 1 hour for this unit to cool down and then turn it back on.	—

■ Tuner

	Problem	Cause	Remedy	See page
FM	FM stereo reception is noisy.	The characteristics of FM stereo broadcasts may cause this problem when the transmitter is too far away or the antenna input is poor.	Check the antenna connections.	19
			Try using a high-quality directional FM antenna.	—
			Use the manual tuning method.	38
	There is distortion, and clear reception cannot be obtained even with a good FM antenna.	There is multi-path interference.	Adjust the antenna position to eliminate multi-path interference.	—
	The desired station cannot be tuned into with the automatic tuning method.	The signal is too weak.	Use a high-quality directional FM antenna.	—
			Use the manual tuning method.	38
	Previously preset stations can no longer be tuned into.	This unit has been disconnected for a long period.	Set preset stations.	39
AM	The desired station cannot be tuned into with the automatic tuning method.	The signal is weak or the antenna connections are loose.	Tighten the AM loop antenna connections and orient it for the best reception.	—
			Use the manual tuning method.	38
	There are continuous crackling and hissing noises.	Noise can result from lightning, fluorescent lamps, motors, thermostats and other electrical equipment.	Use an outdoor antenna and a ground wire. This will help somewhat, but it is difficult to eliminate all noise.	—
	There are buzzing and whining noises.	A TV set is being used nearby.	Move this unit away from the TV set.	—

■ XM Satellite Radio (U.S.A. and Canada models only)

If an operation takes longer than usual or an error occurs, one of the following messages may appear in the front panel display. In this case, read the cause and follow the corresponding remedies.

Status message	Cause	Remedy	See page
CHECK ANTENNA	The XM Mini-Tuner and XM Dock are not connected to the XM jack of this unit or do not work properly.	Check XM Mini-Tuner and XM Dock connections and orient for the best reception level.	41
UPDATING	The XM user encryption code is being updated.	Wait until the encryption code is updated.	—
NO SIGNAL	The signal is too weak.	Adjust the orientation of the XM Mini-Tuner for the best reception level.	41
LOADING	It takes longer than four seconds for audio or text data to be decoded.	Wait until the decoding process has finished.	—
OFF AIR	The XM Satellite Radio channel you selected is not currently broadcasting any signals.	Check the channel number again or select another XM Satellite Radio channel.	—
<XM> - - -	The Channel Station ID (SID) is no longer available.	This is not malfunction.	—
- - - / - - -	No artist name or song title is available.	This is not malfunction.	—
<CAT> - - -	No channels are available for the selected category.	Select another channel category by pressing 4 CATEGORY (or A-E/CAT . <1 / >1) repeatedly.	43

■ AUTO SETUP

Before AUTO SETUP

Error message	Cause	Remedy	See page
Connect MIC!	Optimizer microphone is not connected.	Connect the supplied optimizer microphone to the OPTIMIZER MIC jack on the front panel.	22
Unplug HP!	Headphones are connected.	Unplug the headphones.	—

During AUTO SETUP

Error message	Cause	Remedy	See page
E-1:NO FRONT SP	Front L/R channel signals are not detected.	Check the front L/R speaker connections.	12
E-2:NO SUR.SP	A surround channel signal is not detected.	Check the surround speaker connections.	12
E-3:NOISY	Background noise is too loud.	Try running "AUTO SETUP" in a quiet environment.	—
		Turn off noisy electric equipment like air conditioners or move them away from the optimizer microphone.	—
E-4:NO MIC	The optimizer microphone was unplugged during the "AUTO SETUP" procedure.	Connect the supplied optimizer microphone to OPTIMIZER MIC jack on the front panel.	22
E-5:USER CANCEL	The "AUTO SETUP" procedure was cancelled due to user activity.	Run "AUTO SETUP" again.	22
E-6:INTERNAL ERROR	An internal error occurred.	Run "AUTO SETUP" again.	22

After AUTO SETUP

Warning message	Cause	Remedy	See page
W-1: OUT OF PHASE	Speaker polarity is not correct. This message may appear depending on the speakers even when the speakers are connected correctly.	Check the speaker connections for proper polarity (+ or -).	12
W-2: OVER 24m (80ft)	The distance between the nearest speaker and the furthest speaker is out of adjustable range.	Bring the speaker closer to the listening position.	—
W-3: LEVEL ERROR	The difference of volume level among speakers is excessive. (No level correction is made.)	If “SWFR:TOO LOUD” or “SWFR:TOO LOW” appears, adjust the output volume of the subwoofer.	22
		Readjust the speaker installation so that all speakers are set in locations with similar conditions.	—
		Check the speaker connections.	12
		Use speakers of similar quality.	—

Notes

- If the “ERROR” or “WARNING” screens appears, check the cause of the problem, then run “AUTO SETUP” again.
- If a warning message “W-1” appears, corrections are made, but they may not be optimal.
- If a warning message “W-2” or “W-3” appears, no corrections are made.
- If an error message “E-6” occurs repeatedly, please contact a qualified Yamaha service center.

■ iPod

Note

In case of a transmission error without a status message appearing in the front panel and in the OSD, check the connection to your iPod (see page 18).

Status message	Cause	Remedy	See page
Loading...	This unit is in the middle of recognizing the connection with your iPod.		
	This unit is in the middle of acquiring song lists from your iPod.		
Connect error	There is a problem with the signal path from your iPod to this unit.	Turn off this unit and reconnect the Yamaha iPod universal dock to the DOCK terminal of this unit.	18
		Try resetting your iPod.	—
Unknown iPod	The iPod being used is not supported by this unit.	Only iPod (Click and Wheel), iPod nano, and iPod mini are supported.	—
iPod connected	Your iPod is properly stationed in a Yamaha iPod universal dock (YDS-10, sold separately) connected to the DOCK terminal of this unit, and the connection between your iPod and this unit is complete.		
Disconnected	Your iPod was removed from a Yamaha iPod universal dock (YDS-10, sold separately) connected to the DOCK terminal of this unit.	Station your iPod back in a Yamaha iPod universal dock (YDS-10, sold separately) connected to the DOCK terminal of this unit.	18
Unable to Play	This unit cannot play back the songs currently stored on your iPod.	Check that the songs currently stored on your iPod are playable.	—
		Store some other playable music files on your iPod.	—

■ Remote control

Problem	Cause	Remedy	See page
The remote control does not work nor function properly.	Wrong distance or angle.	The remote control functions within a maximum range of 6 m (20 ft) and no more than 30 degrees off-axis from the front panel.	21
	Direct sunlight or lighting (from an inverter type of fluorescent lamp, etc.) is striking the remote control sensor of this unit.	Reposition this unit.	—
	The batteries are weak.	Replace all batteries.	3
	The operation mode selector (Ⓚ) is set incorrectly.	Set the operation mode selector correctly. When operating this unit, set it to the Ⓚ AMP position. When operating the component selected by the input selector button, set it to the Ⓚ SOURCE position. When operating the TV set in the DTV area, set it to the Ⓚ TV position.	—
	The remote control code is not correctly set.	Set the remote control code correctly using “List of remote control codes” at the end of this manual. Try setting another code for the same manufacturer using “List of remote control codes” at the end of this manual.	62 62
Even if the remote control code is correctly set, there are some models that do not respond to the remote control.			

■ Resetting the system

Use this feature to reset all the parameters of this unit to the initial factory settings.

1 Press ① **STANDBY/ON on the front panel to set this unit to the standby mode.**

2 Press and hold ⑩ **TONE CONTROL and then press ① **STANDBY/ON** to turn on this unit.**

The advanced setup menu appears in the front panel display.

3 Press ⑪ **PROGRAM </> to select “PRESET”.**

4 Press ⑫ **STRAIGHT repeatedly to select “RESET”.**

Select “CANCEL” to cancel the initialization procedure without making any changes.

5 Press ① **STANDBY/ON to confirm your selection and set this unit to the standby mode.**

Notes

- This procedure completely resets all the parameters of this unit including the “SET MENU” parameters. However, the advanced setup menu parameters will not be initialized.
- The initial factory settings are activated next time you turn on this unit.



To cancel the initialization procedure at any time without making any changes, press ⑫ **STRAIGHT** repeatedly to select “CANCEL” and then press ① **STANDBY/ON**.

Glossary

■ Audio information

Dolby Digital

Dolby Digital is a digital surround sound system that gives you completely independent multi-channel audio. With 3 front channels (front L/R and center), and 2 surround stereo channels, Dolby Digital provides 5 full-range audio channels. With an additional channel especially for bass effects, called LFE (Low Frequency Effect), the system has a total of 5.1-channels (LFE is counted as 0.1 channel). By using 2-channel stereo for the surround speakers, more accurate moving sound effects and surround sound environment are possible than with Dolby Surround. The wide dynamic range from maximum to minimum volume reproduced by the 5 full-range channels and the precise sound orientation generated using digital sound processing provide listeners with unprecedented excitement and realism. With this unit, any sound environment from monaural up to a 5.1-channel configuration can be freely selected for your enjoyment.

Dolby Pro Logic II

Dolby Pro Logic II is an improved technique used to decode vast numbers of existing Dolby Surround sources. This new technology enables a discrete 5-channel playback with 2 front left and right channels, 1 center channel, and 2 surround left and right channels instead of only 1 surround channel for conventional Pro Logic technology. There are three modes available: "Music mode" for music sources, "Movie mode" for movie sources and "Game mode" for game sources.

Dolby Surround

Dolby Surround uses a 4-channel analog recording system to reproduce realistic and dynamic sound effects: 2 front left and right channels (stereo), a center channel for dialog (monaural), and a surround channel for special sound effects (monaural). The surround channel reproduces sound within a narrow frequency range. Dolby Surround is widely used with nearly all video tapes and laser discs, and in many TV and cable broadcasts as well. The Dolby Pro Logic decoder built into this unit employs a digital signal processing system that automatically stabilizes the volume on each channel to enhance moving sound effects and directionality.

DTS (Digital Theater Systems)

Digital Surround

DTS digital surround was developed to replace the analog soundtracks of movies with a 5.1-channel digital sound track, and is now rapidly gaining popularity in movie theaters around the world. Digital Theater Systems Inc. has developed a home theater system so that you can enjoy the depth of sound and natural spatial representation of DTS digital surround in your home. This system produces practically distortion-free 5.1-channel sound (technically, left, right and center channels, 2 surround channels, plus an LFE 0.1 channel as a subwoofer, for a total of 5.1-channels).

LFE 0.1 channel

This channel reproduces low-frequency bass signals. The frequency range of this channel is from 20 Hz to 120 Hz. This channel is counted as 0.1 because it only enforces a low-frequency range compared to the full-range reproduced by the other 5 channels in Dolby Digital or DTS 5.1-channel systems.

Neural Surround

Neural Surround™ represents the latest advancement in surround technology and has been adopted by XM Satellite Radio for digital radio broadcast of surround recordings and live events in surround sound. Neural Surround™ employs psychoacoustic frequency domain processing which allows delivery of a more detailed sound stage with superior channel separation and localization of audio elements.

PCM (Linear PCM)

Linear PCM is a signal format under which an analog audio signal is digitized, recorded and transmitted without using any compression. This is used as a method of recording CDs and DVD audio. The PCM system uses a technique for sampling the size of the analog signal per very small unit of time. Standing for "Pulse Code Modulation", the analog signal is encoded as pulses and then modulated for recording.

Sampling frequency and number of quantized bits

When digitizing an analog audio signal, the number of times the signal is sampled per second is called the sampling frequency, while the degree of fineness when converting the sound level into a numeric value is called the number of quantized bits. The range of rates that can be played back is determined based on the sampling rate, while the dynamic range representing the sound level difference is determined by the number of quantized bits. In principle, the higher the sampling frequency, the wider the range of frequencies that can be played back, and the higher the number of quantized bits, the more finely the sound level can be reproduced.

■ **Sound field program information**

CINEMA DSP

Since the Dolby Surround and DTS systems were originally designed for use in movie theaters, their effect is best felt in a theater having many speakers designed for acoustic effects. Since home conditions, such as room size, wall material, number of speakers, and so on, can differ so widely, it is inevitable that there are differences in the sound heard. Based on a wealth of actually measured data, Yamaha CINEMA DSP uses Yamaha original DSP technology to combine Dolby Pro Logic, Dolby Digital and DTS systems to provide the audiovisual experience of movie theater in the listening room of your own home.

SILENT CINEMA

Yamaha has developed a natural, realistic sound effect DSP algorithm for headphones. Parameters for headphones have been set for each sound field program so that accurate representations of all the sound field programs can be enjoyed on headphones.

Virtual CINEMA DSP

Yamaha has developed a Virtual CINEMA DSP algorithm that allows you to enjoy DSP surround effects even without any surround speakers by using virtual surround speakers. It is even possible to enjoy Virtual CINEMA DSP using a minimal two-speaker system that does not include a center speaker.

■ **Video information**

Component video signal

With the component video signal system, the video signal is separated into the Y signal for the luminance and the P_B and P_R signals for the chrominance. Color can be reproduced more faithfully with this system because each of these signals is independent. The component signal is also called the “color difference signal” because the luminance signal is subtracted from the color signal. A monitor with component input jacks is required in order to output component signals.

Composite video signal

With the composite video signal system, the video signal is composed of three basic elements of a video picture: color, brightness and synchronization data. A composite video jack on a video component transmits these three elements combined.

S-video signal

With the S-video signal system, the video signal normally transmitted using a pin cable is separated and transmitted as the Y signal for the luminance and the C signal for the chrominance through the S-video cable. Using the S VIDEO jack eliminates video signal transmission loss and allows recording and playback of even more beautiful images.

Specifications

AUDIO SECTION

- Minimum RMS Output Power for Front, Center, Surround
[U.S.A. and Canada models]
1 kHz, 0.9% THD, 8 Ω 100 W
[Other models]
1 kHz, 0.9% THD, 6 Ω 100 W
- Maximum Power for Front, Center, Surround (JEITA)
[U.S.A. and Canada models]
1 kHz, 10% THD, 8 Ω 135 W
[Other models]
1 kHz, 10% THD, 6 Ω 135 W
- Dynamic Power
[U.S.A. and Canada models]
(IHF, 8/6/4/2 Ω) 110/130/175/185 W
[Other models]
(IHF, 6/4/2 Ω) 105/135/165 W
- Dynamic Headroom [U.S.A. and Canada models]
8 Ω 0.41 dB
- Maximum Input Signal
CD, etc. Effect On, 1 kHz, 0.5% THD 2.0 V or more
- Frequency Response
CD, etc. to Front L/R 10 Hz to 100 kHz, -3 dB
- Total Harmonic Distortion
[U.S.A. and Canada models]
(1 kHz, 50 W, Front L/R, 8 Ω) 0.06% or less
[Other models]
(1 kHz, 50 W, Front L/R, 6 Ω) 0.06% or less
- Signal to Noise Ratio (IHF-A Network)
CD (200 mV) to Front L/R, Effect Off 98 dB or more
CD (250 mV) to Front L/R, Effect Off 100 dB or more
- Residual Noise (IHF-A Network)
Front L/R 150 μV or less
- Channel Separation (1 kHz/10 kHz)
CD, etc. (5.1 kΩ terminated) to Front L/R
..... 60 dB/45 dB or more
- Tone Control (Front L/R)
BASS Boost/Cut ±10 dB/100 Hz
TREBLE Boost/Cut ±10 dB/20 kHz
- Phones Output 400 mV/470 Ω
- Input Sensitivity/Input Impedance
CD, etc. 200 mV/47 kΩ
MULTI CH INPUT 200 mV/47 kΩ
- Output Level/Output Impedance
AUDIO OUT (REC) 200 mV/1.2 kΩ
SUBWOOFER OUTPUT 4 V/1.2 kΩ
- Filter Characteristics (fc=40/60/80/90/100/110/120/160/200 Hz)
H.P.F.
(FRONT SP, CENTER SP, SUR. L/R SP: SMALL/SML)
..... 12 dB/oct.
L.P.F. (Subwoofer) 24 dB/oct.

VIDEO SECTION

- Video Signal Type (Gray back)
[U.S.A., Canada, Korea and General models] NTSC
[Other models] PAL

- Signal Level
Composite 1 Vp-p/75 Ω
S-video 1 Vp-p/75 Ω (Y), 0.286 Vp-p/75 Ω (C)
Component 1 Vp-p/75 Ω (Y), 0.7 Vp-p/75 Ω (Pb/Pk)
- Signal to Noise Ratio 50 dB or more
- Maximum Input Level 1.5 Vp-p or more
- Frequency Response (MONITOR OUT)
Component Signal 5 Hz to 60 MHz, -3 dB

FM SECTION

- Tuning Range
[U.S.A. and Canada models] 87.5 to 107.9 MHz
[Asia and General models] 87.5/87.50 to 108.0/108.00 MHz
[Other models] 87.50 to 108.00 MHz
- 50 dB Quietening Sensitivity (IHF, 100% mod.)
Mono 2.8 μV (20.2 dBf)
- Signal to Noise Ratio (IHF)
Mono/Stereo 73 dB/70 dB
- Harmonic Distortion (1 kHz)
Mono/Stereo 0.5%/0.5%
- Antenna Input (unbalanced) 75 Ω

AM SECTION

- Tuning Range
[U.S.A. and Canada models] 530 to 1710 kHz
[Asia and General models] 530/531 to 1710/1611 kHz
[Other models] 531 to 1611 kHz

GENERAL

- Power Supply
[U.S.A. and Canada models] 120 V AC, 60 Hz
[Australia model] 240 V AC, 50 Hz
[Korea model] 220 V AC, 60 Hz
[China model] 220 V AC, 50 Hz
[Asia and General models]
..... 110-120/220-240 V AC, 50/60 Hz
- Power Consumption
[U.S.A. and Canada models] 240 W/320 VA
[Other models] 240 W
- Standby Power Consumption 0.8 W or less
- Maximum Power Consumption [Asia and General models only]
5ch, 10% THD 530 W
- AC Outlets
[Australia model] 1 (Total 100 W maximum)
[U.S.A., Canada and China models]... 2 (Total 100 W maximum)
[Asia and General models] 1 (Total 50 W maximum)
- Dimensions (W x H x D) 435 x 151 x 318 mm
(17-1/8" x 5-15/16" x 12-1/2")
- Weight 8.1 kg (17 lbs 14 oz)

* Specifications are subject to change without notice.

Index

■ Symbols

- <XM> ---, XM tuning status message 68

■ Numerics

- 1 SOUND MENU, Manual setup 49
- 2 INPUT MENU, Manual setup 49
- 2ch Stereo, Sound field program 35
- 3 OPTION MENU 57
- 3 OPTION MENU, Manual setup 50
- 5ch Stereo, Sound field program 35

■ A

- A)DISPLAY SET, Option menu 57
- A)INPUT ASSIGNMENT, Input menu 55
- A)SPEAKER SET, Sound menu 51
- A.DELAY, Audio settings 54
- AC OUTLET(S) (SWITCHED) 19
- AC OUTLET(S), Rear panel 10
- Activating XM Satellite Radio 42
- All Channel Search mode, XM tuning 43
- All remote control codes resetting 63
- AM antenna, Connection 19
- AM tuning 38
- AMP, Operation mode selector 21
- Amplifier function OSD display time, Display settings 57
- Audio components, Connection 17
- Audio delay, Audio settings 54
- AUDIO jacks 14
- Audio jacks 14
- AUDIO jacks, Rear panel 10
- AUDIO SELECT 31
- Audio select, Option menu 58
- Audio settings, Sound menu 54
- AUTO SETUP 22
- AUTO SETUP, Error message 69
- AUTO: RESULT display, Auto setup 24
- Automatic preset tuning, FM/AM tuning 39
- Automatic tuning, FM/AM tuning 38

■ B

- B)INPUT RENAME, Input menu 56
- B)MEMORY GUARD, Option menu 58
- B)SPEAKER LEVEL, Sound menu 53
- Background Video, Multi channel input setup 57
- BGV, Multi channel input setup 57
- BITRATE, Input source information ... 33

■ C

- C)AUDIO SELECT, Option menu 58
- C)SP DISTANCE, Sound menu 53
- C)VOLUME TRIM, Input menu 56
- Cable TV, Connection 15

- Category Search mode, XM tuning 43
- CD player, Connection 17
- CD recorder, Connection 17
- CENTER SP, Speaker settings 51
- Center speaker equalizer, Sound menu 54
- Center speaker, Speaker settings 51
- Center width, Sound field parameter ... 37
- CHANNEL, Input source information 33
- CHECK ANTENNA 41
- CHECK ANTENNA, XM tuning status message 68
- CINEMA DSP indicator, Front panel display 20
- COAXIAL IN (1), Input assignment ... 55
- COAXIAL INPUT assignment, Input assignment 55
- COAXIAL INPUT jacks 55
- COMPONENT VIDEO jacks 14
- COMPONENT VIDEO jacks, Connection 16
- COMPONENT VIDEO jacks, Rear panel 10
- Connect error, iPod controlling status message 70
- Connect MIC!, Auto setup error message 69
- Connection, AM antenna 19
- Connection, Audio components 17
- Connection, Cable TV 15
- Connection, CD player 17
- Connection, CD recorder 17
- Connection, COMPONENT VIDEO jacks 16
- Connection, DVD player 15
- Connection, DVD recorder 15
- Connection, FM antenna 19
- Connection, MD recorder 17
- Connection, MULTI CH INPUT jacks 17
- Connection, Power cable 19
- Connection, S VIDEO jacks 16
- Connection, Satellite tuner 15
- Connection, Speaker 12
- Connection, Video components 15
- Connection, Video monitor 15
- Connection, Yamaha iPod universal dock 18
- Controlling a TV, Remote control 60
- Controlling other components, Remote control 61
- Controlling this unit, Remote control ... 60
- Creating original SCENE templates 29
- CROSSOVER, Speaker settings 52
- Crossover, Speaker settings 52
- CT WIDTH, Sound field parameter 37

■ D

- D)CENTER GEQ, Sound menu 54

- D)DECODER MODE, Input menu 56
- D)PARAM. INI, Option menu 58
- Decoder mode, Input menu 56
- Decoder select mode, Decoder mode .. 56
- Default setting, Remote control code .. 62
- DIGITAL AUDIO COAXIAL jacks ... 14
- DIGITAL AUDIO OPTICAL jacks 14
- DIGITAL INPUT jacks, Rear panel 10
- DIMENSION, Sound field parameter 37
- Dimension, Sound field parameter 37
- DIMMER, Display settings 57
- Dimmer, Display settings 57
- Direct Number Access mode, XM tuning 43
- DIRECT STEREO 32
- Direct Stereo 32
- Disconnected, iPod controlling status message 70
- Display settings, Option menu 57
- Display, Input source information 33
- Displaying the XM Satellite Radio information 45
- DIST 23
- DIST, Auto setup result 23
- DISTANCE 23
- DISTANCE, Auto setup 23
- DOCK indicator, Front panel display 20
- DOCK terminal, Rear panel 10
- DSP LEVEL, Sound field parameter ... 37
- DSP level, Sound field parameter 37
- DTS decoder prioritize setting, Decoder mode 56
- DVD player, Connection 15
- DVD recorder, Connection 15
- Dynamic range, Sound menu 54

■ E

- E)LFE LEVEL, Sound menu 54
- E)MULTI CH SET, Input menu 57
- E)XM RADIO SET, Option menu 58
- E-1:NO FRONT SP, Auto setup error message 69
- E-2:NO SURR.SP, Auto setup error message 69
- E-3:NOISY, Auto setup error message 69
- E-4:NO MIC, Auto setup error message 69
- E-5:USER CANCEL, Auto setup error message 69
- E-6:INTERNAL ERROR, Auto setup error message 69
- Effect level, Sound field parameter 37
- ENHANCER indicator, Front panel display 20
- Exchange, Preset station, FM/AM tuning 40

■ F

- F/D. RANGE, Sound menu 54
- Factory presets, Advanced setup 64
- FL SCROLL, Display settings 57
- FLAG, Input source information 33
- FM antenna, Connection 19
- FM tuning 38
- FORMAT, Input source information ... 33
- FRONT B speaker setting,
 - Speaker settings 51
- FRONT B, Speaker settings 51
- Front panel display 20
- Front panel display scroll,
 - Display settings 57
- FRONT SP, Speaker settings 51
- Front speakers, Speaker settings 51

■ G

- G)AUDIO SET, Sound menu 54
- Games, Sound field program 35

■ H

- Hall, Sound field program 35
- Headphone, Dynamic range 54
- HEADPHONE,
 - Low-frequency effect level 54
- Headphone,
 - Low-frequency effect level 54
- Headphones indicator,
 - Front panel display 20
- Headphones, use 34
- HiFi DSP indicator,
 - Front panel display 20
- HP, Dynamic range 54

■ I

- Infrared window, Remote control 21
- INI VOL., Audio settings 55
- Initial volume, Audio settings 55
- Input assignment, Input menu 55
- Input channel and speaker indicators,
 - Front panel display 20
- Input channel indicators,
 - Front panel display 20
- Input menu, Manual setup 49
- Input rename, Input menu 56
- Input source indicators,
 - Front panel display 20
- Input source information display 33
- iPod connected,
 - iPod controlling status message 70
- iPod control, Status message 70
- iPod using 46

■ J

- Jazz, Sound field program 35

■ L

- LFE indicator, Front panel display 20
- LFE/BASS OUT, Speaker settings 52
- LFE/Bass out, Speaker settings 52
- LOADING,
 - XM tuning status message 68

- Loading...,
 - iPod controlling status message 70
- Low-frequency effect level,
 - Sound menu 54
- LVL 23
- LVL, Auto setup result 23

■ M

- Manual preset tuning,
 - FM/AM tuning 39
- MANUAL SETUP, SET MENU 49
- Manual setup, SET MENU 49
- Manual tuning, FM/AM tuning 38
- MAX VOL., Audio settings 55
- Maximum volume, Audio settings 55
- MD recorder, Connection 17
- Memory guard, Option menu 58
- Menu browse mode,
 - iPod controlling 46
- Movie Dramatic,
 - Sound field program 35
- Movie Spacious,
 - Sound field program 35
- MULTI CH INPUT jacks,
 - Connection 17
- MULTI CH INPUT jacks,
 - Rear panel 10
- Multi channel input setup,
 - Input menu 57
- Multi-channel source
 - with headphones 36
- Multi-information display,
 - Front panel display 20
- Music Enh. 2ch,
 - Sound field program 35
- Music Enh. 5ch,
 - Sound field program 35
- MUTE indicator,
 - Front panel display 20
- MUTE TYPE, Audio settings 54
- Muting 34

■ N

- Neural Surround 36
- NIGHT indicator,
 - Front panel display 20
- Night listening mode 33
- NO SIGNAL,
 - XM tuning status message 68
- Number of speakers 23
- Number of speakers, Auto setup result 23

■ O

- OFF AIR,
 - XM tuning status message 68
- Operation mode selector,
 - Remote control 21
- OPTICAL IN (2) 55
- OPTICAL IN (2), Input assignment 55
- OPTICAL IN (3), Input assignment 55
- OPTICAL INPUT assignment,
 - Input assignment 55
- OPTIMIZER MIC jack, Auto setup 22
- Optimizer microphone 22

- Optimizer microphone, Auto setup 22
- Optimizing speaker setting 22
- Option menu, Manual setup 50
- OSD SHIFT, Display settings 57
- OSD shift, Display settings 57
- OSD-AMP, Display settings 57
- OSD-SOURCE, Display settings 57
- Other components controlling
 - by remote control 61
- Other components controlling,
 - Remote control 61

■ P

- PANORAMA,
 - Sound field parameter 37
- Panorama, Sound field parameter 37
- Parameter initialization,
 - Option menu 58
- PCM indicator, Front panel display 20
- PHONES jack 34
- Play information display,
 - iPod controlling 47
- Playing video sources
 - in the background 34
- PLII Game 36
- PLII Movie 36
- PLII Music 36
- Pop/Rock, Sound field program 35
- Power cable, Connection 19
- Preset channel setting, XM tuning 44
- Preset Search mode, XM tuning 43
- Preset station exchange,
 - FM/AM tuning 40
- Preset station selection,
 - FM/AM tuning 40
- PRESET, Advanced setup 64
- Pro Logic 36
- Pure hi-fi stereo sound 32

■ R

- Remote control code default setting 62
- Remote control code setting 62
- Remote control codes i
- Remote control codes setting 62
- Remote control, Troubleshooting 71
- Rename, SCENE template 29
- Repeat 47
- Repeat, iPod controlling 47
- Resetting all remote control codes 63
- Resetting the system 71

■ S

- S VIDEO jacks 14
- S VIDEO jacks, Connection 16
- SAMPLING,
 - Input source information 33
- Satellite tuner, Connection 15
- SCENE 1 8
- SCENE 2 8
- SCENE 3 8
- SCENE 4 9
- SCENE template selection 26
- Selection, Audio input jack 31

- Selection, Preset station,
 - FM/AM tuning 40
- Selection, SCENE template 26
- SET MENU 49
- Setting remote control code 62
- Setting SCENE template input source,
 - Remote control 59
- Setting the speaker impedance 13
- Shuffle, iPod controlling 47
- SIGNAL INFO, SET MENU 33
- SILENT CINEMA 36
- SILENT CINEMA indicator,
 - Front panel display 20
- Simple remote mode,
 - iPod controlling 46
- SIZE 23
- SIZE, Auto setup 23
- SLEEP indicator,
 - Front panel display 20
- Sleep timer 34
- Sound field programs
 - with headphones 36
- Sound menu, Manual setup 49
- Source feature OSD display time,
 - Display settings 57
- SOURCE, Operation mode selector 21
- SP 23
- SP A B indicators,
 - Front panel display 20
- SP IMP., Advanced setup 64
- SP, Auto setup result 23
- SP, Dynamic range 54
- Speaker distance 23
- Speaker distance, Auto setup 23
- Speaker distance, Auto setup result 23
- Speaker distance, Sound menu 53
- Speaker distances, Speaker distance 53
- Speaker impedance, Advanced setup 64
- Speaker level 23
- Speaker level adjustment 32
- Speaker level, Auto setup result 23
- Speaker level, Sound menu 53
- Speaker settings, Sound menu 51
- Speaker size 23
- Speaker size, Auto setup 23
- Speaker wiring 23
- Speaker wiring, Auto setup 23
- Speaker wiring/volume level,
 - Auto setup 23
- Speaker, Connection 12
- Speaker, Dynamic range 54
- SPEAKER,
 - Low-frequency effect level 54
 - Speaker, Low-frequency effect level 54
- SPEAKERS terminals, Rear panel 10
- Specifications 74
- STRAIGHT 36
- Straight 36
- SUBWOOFER OUTPUT jack,
 - Rear panel 10
- SUBWOOFER PHASE,
 - Speaker settings 52
- Subwoofer phase, Speaker settings 52
- Supplied accessories 3
- SUR. L/R SP, Speaker settings 52
- Surround left/right speakers,
 - Speaker settings 52
- T**
 - Test tone, Center speaker equalizer 54
 - TEST, Center speaker equalizer 54
 - Tonal quality adjustment 32
 - TRANSMIT indicator,
 - Remote control 21
 - Troubleshooting 65
 - TU, Advanced setup 64
 - Tuner (FM/AM), Troubleshooting 68
 - Tuner frequency step,
 - Advanced setup 64
 - Tuner indicators,
 - Front panel display 20
 - Turning off the power 19
 - Turning on the power 19
 - TV controlling by remote control 60
 - TV controlling, Remote control 60
 - TV Sports, Sound field program 35
 - TV, Operation mode selector 21
- U**
 - Unable to play,
 - iPod controlling status message 70
 - UNIT, Speaker distance 53
 - Unit, Speaker distance 53
 - Unknown iPod,
 - iPod controlling status message 70
 - Unplug HP!,
 - Auto setup error message 69
 - UPDATING,
 - XM tuning status message 68
- V**
 - VIDEO AUX jacks, Front panel 18
 - Video components, Connection 15
 - VIDEO jacks 14
 - Video jacks 14
 - VIDEO jacks, Rear panel 10
 - Video monitor, Connection 15
 - Virtual CINEMA DSP 36
 - VIRTUAL indicator,
 - Front panel display 20
 - VOLTAGE SELECTOR 3
 - VOLUME level indicator,
 - Front panel display 20
 - Volume Trim, Input menu 56
- W**
 - W-1:OUT OF PHASE,
 - Auto setup error message 70
 - W-2:DISTANCE ERROR,
 - Auto setup error message 70
 - W-3:LEVEL ERROR,
 - Auto setup error message 70
 - WIRING/LEVEL 23
 - WIRING/LEVEL, Auto setup 23
- X**
 - XM ANTENNA, XM Radio setting 58
 - XM jack, Rear panel 10
 - XM Mini-Tuner Dock 41
 - XM Radio antenna,
 - XM Radio setting 58
 - XM Radio setting, Option menu 58
 - XM Satellite Radio tuning 41
 - XM Satellite Radio, Status message 68
- Y**
 - Yamaha iPod universal dock,
 - Connection 18
 - Yamaha Parametric Room Acoustic
 - Optimizer 22
 - YPAO 22
 - YPAO (Yamaha Parametric Room
 - Acoustic Optimizer) 22
 - YPAO indicator,
 - Front panel display 20

■ Front panel

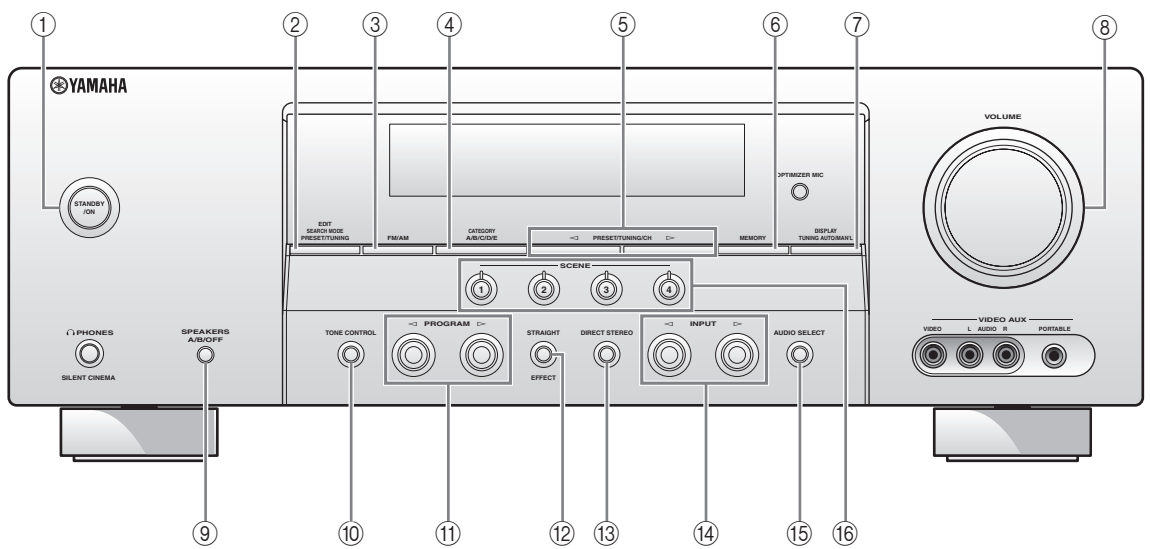

■ Remote control

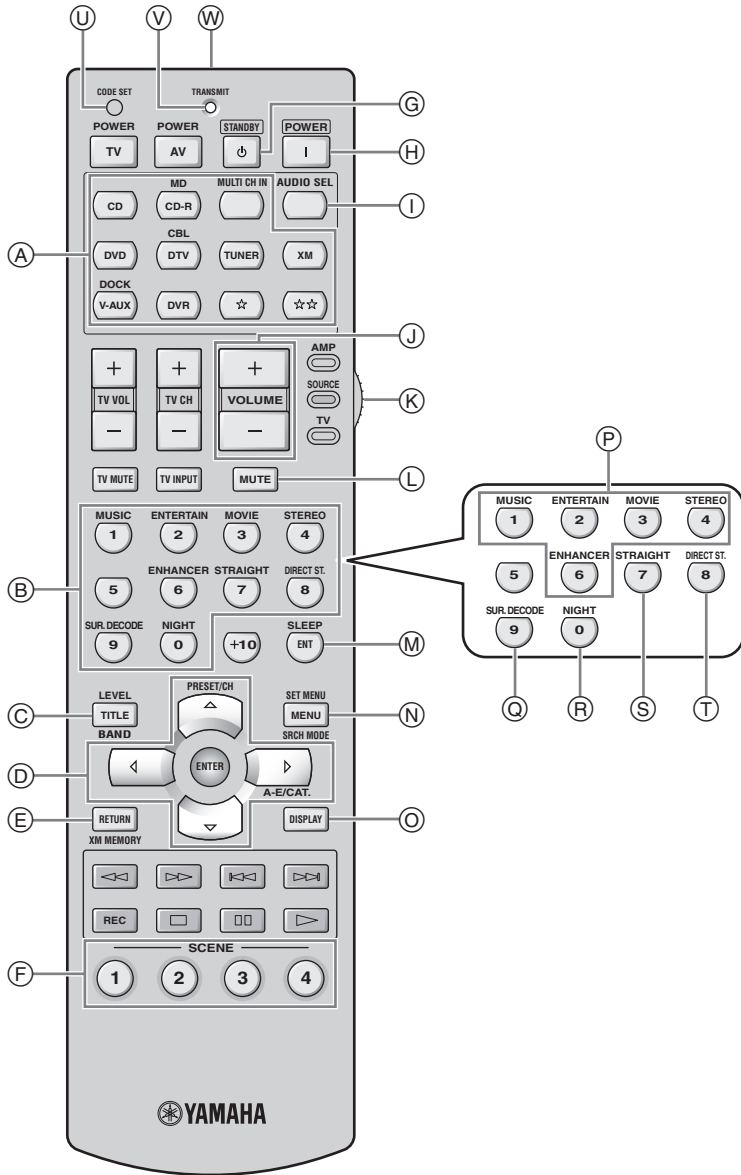

List of remote control codes

CABLE TV RECEIVER

3M	10033
A-MARK	10008, 10144
ABC	10237, 10003, 10008, 10033
ACCUPHASE	10003
ACORN	10237
ACTION	10237
ACTIVE	10237
AMERICAST	10899
ARCHER	10237
BCC	10276
BELL SOUTH	10899
BRITISH TELECOM	10003
CENTURY	10008
DIRECTOR	10476
DX ANTENNA	11500
FOSGATE	10276
FUJITSU	11497
GE	10144
GENERAL INSTRUMENT	10476, 10810, 10276, 10003
GIBRALTER	10003
GOLDSTAR	10144
HITACHI	10003, 10008, 10033
INSIGHT	10476, 10810
JERROLD	10476, 10810, 10276, 10003
MACOM	10033
MEMOREX	10000
MITSUBISHI	10003
MOTOROLA	11376, 10476, 10810, 10276
NEC	11496
NOVA VISION	10008
NOVAPLEX	10008
PACE	11877, 10877, 10237, 10008
PANASONIC	10000, 10008, 10144, 10107, 10375, 11488
PARAGON	10000, 10008, 10525
PENNEY	10000
PHILIPS	11305, 10317
PIONEER	11877, 10877, 10144, 10533, 11021, 11500, 11782
PULSAR	10000
QUASAR	10000
REGAL	10276
RUNCO	10000
SAMSUNG	10003, 10144
SCIENTIFIC ATLANTA	11877, 10877, 10477, 10237, 10003, 10000, 10008
SONY	11006, 11460
SPRUCER	10144
STARCOM	10003
SUMITOMO	11500, 11503
SUPERCABLE	10276
TORX	10003
TOSHIBA	10000, 11509

UNITED CABLE	10276, 10003
US ELECTRONICS	10276, 10003, 10008
VIDEOWAY	10000
ZENITH	10000, 10525, 10899

CABLE/PVR COMBINATION

AMERICAST	10899
GENERAL INSTRUMENT	10810
JERROLD	10810
MOTOROLA	11376, 10810
PACE	11877, 10237
PIONEER	11877, 10877
SCIENTIFIC ATLANTA	11877, 10877
SONY	11006
SUPERCABLE	10276
ZENITH	10899

DBS/PVR COMBINATION

DIRECTV	11377, 10392, 10639, 11142, 11392, 11442, 11640
DISH NETWORK SYSTEM	11505, 10775
DISHPRO	11505, 10775
ECHOSTAR	11505, 10775
EXPRESSVU	10775
HUGHES NETWORK SYSTEMS	11142, 11442
PHILIPS	11142, 11442
PROSCAN	10392
RCA	11392
SAMSUNG	11442
SHARP	11489
SONY	10639, 11640

SATELLITE RECEIVER

AIWA	11514, 11515
ALPHASTAR	10772
AUSTAR	10879
BELL EXPRESSVU	10775
CHAPARRAL	10216
DIRECTV	11377, 10392, 10566, 10639, 11639, 11142, 10247, 10749, 11749, 10724, 10819, 11856, 11392, 11442, 11640
DISH NETWORK SYSTEM	11505, 11005, 10775, 11775
DISHPRO	11505, 11005, 10775, 11775
DX ANTENNA	11530
ECHOSTAR	11505, 11005, 10775, 11775

ESAT	10879
EXPRESSVU	10775, 11775
FOXTEL	10879, 11356
FUNAI	11377
GE	10392, 10566
GOI	10775, 11775
HITACHI	10749, 10819, 10214, 11250, 11518, 11523, 11525
HOUSTON	10775
HTS	10775, 11775
HUGHES NETWORK SYSTEMS	11142, 10749, 11749, 11442
JVC	10775, 10492, 11507, 11531, 11532, 11775
LG	11226
MAGNAVOX	10724, 10722
MASPRO	11520, 11530
MATSUSHITA	10214
MEMOREX	10724
MITSUBISHI	10749
MOTOROLA	10856
NEC	10496, 11270, 11519
OPTIMUS	10724
PACE	11356
PANASAT	10879
PANASONIC	10247, 10701, 10214, 11508, 11526, 11527, 11528
PAYSAT	10724
PHILIPS	11142, 10749, 11749, 10775, 10724, 10819, 10722, 11442
PIONEER	11142, 11442
PROSCAN	10392, 10566
RADIOSHACK	10566, 10775
RCA	10392, 10566, 11142, 10775, 10855, 10143, 11392, 11442
SAMSUNG	11377, 11142, 11276, 11442
SANYO	11219
SHARP	10494, 11489, 11513, 11517
SKY	10856
SONY	10639, 11639, 10163, 10275, 10294, 11524, 11640
STAR TRAK	10772
THOMSON	10392, 10566
TIVO	11142, 11442
TOSHIBA	10749, 11749, 10790, 10819, 10486, 11285, 11501, 11516, 11530
UEC	11356
ULTIMATETV	11392, 11640
UNIDEN	10724, 10722
ZENITH	10856, 11856

TV

A-MARK	20047, 20054, 20160
ACCUSCAN	20047
ACTION	20030
ADMIRAL	20017, 20047, 20051, 20054, 20093, 20179, 20180, 20264, 20463
ADVENT	20761, 20783, 20815, 20817, 20842
ADVENTURI	20000
AGNA	20150
AIKO	20092
AIWA	21180
AKAI	20030, 20060, 20145, 20672, 20702, 20812
ALARON	20170, 20179
ALBA	20037
ALBATRON	20700, 20843
ALFIDE	20672
ALLERON	20030, 20170
AMBASSADOR	20150
AMERICA ACTION	20180
AMERICAN HIGH	20000, 20060
AMSTRAD	20171
AMTRON	20000, 20180
ANAM	20180
ANAM NATIONAL	20161
AOC	20030, 20180
APEX DIGITAL	20156, 20748, 20765, 20767, 20879
AUDINAC	20180
AUDIOVOX	20092, 20179, 20180, 20451, 20623, 20802, 20875
AVENTURA	20171
BAYCREST	20186
BAYSONIC	20180
BEAUMARK	20017, 20030, 20178, 20179
BELCOR	20030
BELL & HOWELL	20054, 20093, 20154, 20179
BENQ	21032
BRADFORD	20180
BROCKWOOD	20030, 20178
BROKSONIC	20180, 20236, 20463
BROTHER	20264
BYD:SIGN	21309, 21311, 21485, 21486
CANDLE	20030, 20186
CAPEHART	20017, 20030, 20036, 20092, 20178
CARNIVALE	20030
CARVER	20054, 20170
CCE	20037
CELEBRITY	20000

CELERA	20765	FISHER	20000, 20054,	JVC	20030, 20036,	MINATO	20037
CHANGHONG	20156, 20765,		20154		20053, 20054,	MITSUBISHI	20030, 20036,
	20767, 20783	FORTRESS	20093		20160, 20653,		20093, 20150,
CINERAL	20092, 20451	FUJITSU	20179, 20186,		20731, 21172,		20154, 20160,
CITEK	20047		20683, 20809,		21253, 21428		20178, 20250,
CITIZEN	20000, 20030,		20853, 21181,	KAMP	20017, 20180		20836, 21150,
	20054, 20060,		21607	KAWASHO	20030		21171, 21182,
	20092, 20171,	FUJITSU GENERAL		KEC	20060, 20180		21250, 21522
	20180, 20186,		20186	KENWOOD	20030, 20180	MONIVISION	20700, 20843
	20451, 20463	FUNAI	20000, 20171,	KLH	20156, 20180,	MOTOROLA	20051, 20054,
CLARION	20180		20179, 20180,		20765, 20767		20093, 20150
CLASSIC	20030, 20092		20264, 20342	KLOSS	20030	MTC	20030, 20060,
COLORTYME	20017, 20030,	FUTURETECH	20180	KONKA	20180		20092, 20180
	20047, 20054,	GATEWAY	21755, 21756	KTV	20030, 20180,	MULTITECH	20179, 20180
	20060, 20178	GE	20000, 20030,		20463	NAD	20156, 20166,
COMMERCIAL SOLUTIONS			20047, 20051,	LARK	20154		20178, 20866
	20047, 21447		20060, 20178,	LG	20030, 20054,	NEC	20030, 20036,
CONIC	20178		20451, 21147,		20060, 20178,		20047, 20156,
CONTEC	20180		21347, 21447		20442, 20700,		20170, 20178,
CRAIG	20161, 20171,	GEMINI	20047		20856, 21178,		20474, 20704,
	20179, 20180	GENERAL	20186		21265, 21378		21182, 21456,
CROSLEY	20000, 20030,	GIBRALTER	20000, 20017,	LLOYD'S	20030, 20179,		21704
	20054, 20171,		20030		20180, 20236	NETTV	21755
	20180	GOLDSTAR	20030, 20036,	LOGIK	20179, 20180,	NIKKO	20030, 20092,
CROWN	20093, 20180,		20037, 20047,		20236		20178
	20672		20054, 20178,	LUMATRON	20037, 20264	NIKKODO	20030, 20092,
CROWN MUSTANG			21378	LXI	20179, 20178,		20178
	20672	GOODMANS	20037		20171, 20166,	NISHI	20030
CURTIS MATHES		GPX	20179		20156, 20154,	NORCENT	20748, 20824
	21347, 21147,	GRADIENSTE	20053, 20170		20093, 20060,	NTC	20092
	20702, 20451,	GRAN PRIX	20179		20054, 20053,	NYON	20000
	20180, 20179,	GRANADA	20037		20051, 20047,	ONWA	20180
	20178, 20166,	GRUNDIG	20037, 20672,		20037, 20036,	OPTIMUS	20030, 20093,
	20154, 20145,		20683, 20706		20030, 20017,		20150, 20154,
	20093, 20060,	GRUNDY	20179, 20180		20000		20166, 20178,
	20054, 20051,	GRUNPY	20179, 20180	MACY	20186		20180, 20250,
	20047, 20037,	HAIER	21034	MAGNASONIC	20000, 20030,		20650
	20030, 20000	HALLMARK	20178, 20179,		20054, 20092,	OPTONICA	20093
CXC	20180		20180, 20236		20093, 20156,	ORION	20017, 20178,
DAEWOO	20036, 20092,	HARLEY DAVIDSON			20179		20179, 20180,
	20178, 20264,		20000, 20030,	MAGNAVOX	21755, 21454,		20236, 20463,
	20451, 20623,		20060, 20178,		21254, 20802,		21463
	20661, 20672,		20179, 20180		20706, 20250,	PACE	20092
	21661, 21755,	HARMAN/KARDON			20186, 20180,	PACIFIC	20037
	21756		20054		20179, 20171,	PALSONIC	20264
DAYTON	20092	HARVARD	20180		20154, 20092,	PANASONIC	20000, 20030,
DAYTRON	20030, 20036,	HAVERMY	20093		20060, 20054,		20051, 20054,
	20092, 20178	HEATHKIT	20017		20051, 20047,		20156, 20161,
DELL	21178	HELIOS	20865		20037, 20036,		20236, 20250,
DENON	20145, 20511	HELLO KITTY	20451		20030, 20000		20650, 21168,
DUMONT	20017, 20178,	HISENSE	20748	MAJESTIC	20017		21175, 21177
	20180	HITACHI	20000, 20017,	MARANTZ	20030, 20037,	PANDA	20706
DURABRAND	20171, 20178,		20036, 20047,		20054, 20704,	PAUSA	20179
	20180, 20463,		20051, 20054,		21454	PAXONIC	20030, 20060
	21034		20145, 20178,	MARK	20037	PCE	20060, 20156,
DWIN	20093		20179, 21145,	MATSUI	20036, 20037		20179
EATON	20060		21150, 21245,	MATSUSHITA	20051, 20161,	PENNEY	20000, 20030,
ELECTROBAND			21378		20250, 20650		20036, 20037,
	20000	HYUNDAI	20849, 20865	MAXENT	21755, 21756		20047, 20051,
ELECTROGRAPH		ICE	20264	MEGAPOWER	20700		20060, 20156,
	21755	IMA	20178, 20179,	MEGATRON	20047, 20145,		20161, 20178,
ELECTROHOME			20180, 20236		20178		20250, 21347,
	20000, 20030,	INFINITY	20054	MEMOREX	20030, 20037,		21378
	20150, 20154,	INNOVA	20037		20150, 20154,	PHILCO	20030, 20054,
	20178	INSIGNIA	20171		20178, 20179,		20145, 20179,
EMERALD	20178	INTEQ	20017, 20145		20180, 20463		20186, 20463
EMERSON	20036, 20047,	JBL	20054	MERMAID	20037	PHILIPS	20030, 20037,
	20150, 20154,	JCB	20000	MGA	20030, 20150,		20054, 20171,
	20170, 20171,	JENSEN	20761, 20815,		20178		20186, 20690,
	20178, 20179,		20817	MGN TECHNOLOGY			21254, 21454,
	20180, 20236,	JIL	20030		20178		21455
	20451, 20463,	JINXING	20037	MICRO GENIUS		PILOT	20030, 20051,
	20623	JUTAN	20030		20150		20060, 20178
ENVISION	20030			MIDLAND	20017, 20047,	PIONEER	20166, 20679,
ESA	20171, 20812				20051		20866, 21260

ASTRA	30035, 30240	GOLDSTAR	30035, 30037, 30039, 30000, 30038, 31237	MEMOREX	30035, 30162, 30037, 30048, 30039, 30047, 30240, 30000, 30104, 30209, 30307, 30348, 31237		31803
AUDIOVOX	30037, 30038					POLK AUDIO	30081
AVIS	30000					PROFITRONIC	30240
BEAUMARK	30240	GOODMANS	30037, 30081, 30000			PROSCAN	30060, 31060
BELL & HOWELL						PROTEC	30000
	30035, 30048, 30039, 30000, 30104	GRADIENTE	30000			PULSAR	30039, 30240
BROKSONIC	30184, 30121, 30209, 30348, 31479	GRANADA	30081, 30042	METZ	30037	PULSER	30240
		GRUNDIG	30081, 30034, 30226	MGA	30060, 30240, 30043	QUARTZ	30035, 30047
CALIX	30037	HARLEY DAVIDSON	30000			QUASAR	30035, 30162, 30226, 31035
CANDLE	30037, 30038	HARMAN/KARDON	30081, 30038	MGN TECHNOLOGY	30240	RADIOSHACK	30035, 30162, 30037, 30048, 30047, 30240, 30000, 30104
CANON	30035, 30034	HEWLETT PACKARD	31972	MICROSOFT	31972		
CARRERA	30240			MIDLAND	30240	RADIX	30037
CARVER	30035, 30081	HI-Q	30035, 30047, 30000	MIND	31972	RANDEX	30037
CITIZEN	30035, 30037, 30240, 30000, 30209, 31278	HITACHI	30035, 30037, 30045, 30000, 30042, 30067, 30043, 30041, 30807, 31343, 31714	MINOLTA	30042	RCA	30060, 30035, 30048, 30240, 30045, 30000, 30042, 30166, 30807, 30880, 31035, 31060
CLASSIC	30037	HOWARD COMPUTERS	31972	MOTOROLA	30035, 30048	REALISTIC	30035, 30162, 30037, 30048, 30047, 30240, 30000, 30104, 30121
COLORTYME	30060, 30035, 30045	HP	31972	MTC	30240, 30000		
COLT	30000	HUGHES NETWORK SYSTEMS	30042, 30739	MTX	30000	REPLAYTV	30614, 30616
CRAIG	30037, 30047, 30240			MULTITECH	30039, 30000	RICAVISION	31972
CRITERION	30000	HUMAX	30739	NAD	30240, 30104	RICOH	30034
CROSLEY	30035, 30081, 30000	HUSH	31972	NEC	30104, 30067, 30041, 30038	RUNCO	30039
CURTIS MATHES		HYTEK	30047, 30000	NIKKO	30037	SAMSUNG	30060, 30240, 30045, 30000, 30038, 30739, 31014
	30060, 30035, 30162, 30240, 30000, 30041, 31035	IBUYPOWER	31972	NIKKODO	30037		
CYBERNEX	30240	ITT NOKIA	30240, 30041	NIKON	30034		
CYBERPOWER	31972	JANEIL	30240	NISHI	30240		
DAEWOO	30037, 30045, 31278	JENSEN	30067, 30041	NIVEUS MEDIA	31972		
DAYTRON	30037	JVC	30067, 30041, 31279, 31299, 31329	NOBLEX	30240	SAMTRON	30240
DELL	31972	KEC	30037	NORTHGATE	31972	SANKY	30048, 30039
DENON	30081, 30042	KENWOOD	30067, 30041, 30038	OLYMPUS	30035, 30162, 30104, 30226	SANSUI	30240, 30000, 30067, 30209, 30041, 31479
DENWENT	30041			OPTIMUS	31062, 30035, 30162, 30037, 30048, 30047, 30240, 30000, 30104	SANYO	30047, 30240, 30000, 30104, 31330, 31331
DIRECTV	30739	KODAK	30035, 30037				
DUAL	30000	KTV	30000	ORION	30184, 30240, 30000, 30104, 30121, 30209, 31479	SCOTT	30184, 30045, 30121, 30043
DURABRAND	30039, 30038	LG	30037, 30240, 30038			SEARS	30060, 30035, 30162, 30037, 30048, 30039, 30047, 30033, 30045, 30000, 30042, 30104, 30067, 30043, 30209, 30041, 30034, 31237
DYNATECH	30240, 30000	LIFETEC	30348	PANAMA	30035	SHARP	30048, 30047, 30032, 30000, 30807, 31285, 31742, 31810
ELECTROHOME		LINKSYS	31972	PANASONIC	31062, 30035, 30162, 30000, 30225, 30226, 30614, 30616, 31035, 31244, 31292, 31308, 31732, 31807, 31808, 31809		
	30060, 30037, 30240, 30000, 30043, 30209	LLOYD'S	30240, 30000, 30038			SHINTOM	30039, 30240, 30000
ELECTROPHONIC		LOEWE	30081	PENNEY	30035, 30162, 30037, 30047, 30081, 30240, 30000, 30042, 30067, 30038, 31035, 31237	SHOGUN	30240
	30037	LOGIK	30240, 30000			SIEMENS	30037, 30104
EMERALD	30184, 30121	LXI	30037, 30000, 30042, 30067	PHILCO	30035, 30081, 30000, 30209	SIGNATURE	30060, 30035, 30037, 30048, 30000
EMEREX	30032	M ELECTRONIC	30240	PHILIPS	30035, 300162, 30048, 30081, 30045, 30000, 30209, 30034, 30616, 30616	SINGER	30037, 30240
EMERSON	30037, 30184, 30240, 30000, 30121, 30043, 30209, 30348, 31278, 31479	MAGNASONIC	30037, 30240, 30000, 31278			SONIC BLUE	30614, 30616
		MAGNAVOX	30035, 30037, 30048, 30039, 30081, 30240, 30000, 30226, 30618, 31781			SONY	30035, 30047, 30032, 30033, 30000, 30067, 30034, 30226, 30636, 31232, 31295, 31296, 31447, 31448, 31636, 31972
FISHER	30039, 30047, 30000, 30104						
FUJI	30035, 30033	MAGNIN	30240				
FUJITSU	30045, 30000	MARANTZ	30035, 30081, 30038, 31381	PENTAX	30042		
FUNAI	30037, 30000, 31333	MARTA	30037	PHILCO	30035, 30081, 30000, 30209		
GARRARD	30000	MATSUI	30037, 30209, 30348				
GATEWAY	31972						
GE	30060, 30035, 30048, 30240, 30000, 30807, 31035, 31060	MATSUSHITA	30035, 30162, 30081, 30226	PHILIPS	30035, 300162, 30048, 30081, 30045, 30000, 30209, 30034, 30616, 30618, 30739, 31381		
		MEDIA CENTER PC	31972				
GEMINI	30060			PILOT	30037		
GENERAL	30045	MEDION	30348	PIONEER	30162, 30081, 30042, 30067,		
GENEXXA	30037, 30000	MEI	30035				
GO VIDEO	30240, 30614						

SOUNDMASTER

30000
 STACK 9 31972
 STS 30042
 SV2000 30000
 SVA 30000
 SYLVANIA 30035, 30081,
 30000, 30043,
 31781
 SYMPHONIC 30240, 30000
 SYSTEMAX 31972
 TAGAR SYSTEMS
 31972
 TANDY 30000, 30104
 TATUNG 30048, 30081,
 30000, 30067,
 30041
 TEAC 30000, 30067,
 30041
 TECHNICS 30035, 30162,
 30037, 30000
 TEKNIKA 30035, 30037,
 30000
 TELERECORDER 30240
 TELEFUNKEN 30041
 THOMAS 30000
 THOMSON 30060, 30041
 TIVO 30618, 30636,
 30739, 31996
 TMK 30240, 30000
 TNX 30037
 TOCOM 30240
 TOSHIBA 30240, 30045,
 30000, 30042,
 30043, 30209,
 30041, 30828,
 30845, 31008,
 31145, 31323,
 31739, 31972,
 31996
 TOTEVISION 30037, 30240
 TOUCH 31972
 TRIX 30037
 ULTRA 30045
 UNITECH 30240
 VECTOR 30045
 VECTOR RESEARCH
 30184, 30038
 VICTOR 30067, 30041,
 31299, 31706
 VIDEO CONCEPTS
 30045
 VIDEOMAGIC 30037
 VIDEOSONIC 30240, 30000
 VIEWSONIC 31972
 VILLAIN 30000
 VOODOO 31972
 WARDS 30060, 30035,
 30037, 30048,
 30047, 30081,
 30033, 30240,
 30045, 30000,
 30042, 30043,
 30041, 30038
 WHITE WESTINGHOUSE
 30000, 30209
 WORLD 30209
 XR-1000 30035, 30240,
 30000
 YAMAHA 30041, 30038
 ZENITH 30037, 30039,
 30033, 30000,
 30209, 30041,
 30034, 31479
 ZT GROUP 31972

DVD PLAYER

3D LAB 40503, 40539
 ACCURIAN 41416
 ADVENT 41016
 AIWA 40641
 AKAI 40695, 40705,
 40770, 40899
 ALBA 40672, 40717
 ALCO 40790
 ALLEGRO 40869
 AMPHION MEDIA WORKS
 40872
 AMW 40872
 APEX DIGITAL 40533, 40672,
 40717, 40755,
 40794, 40796,
 40797, 40830,
 41004, 41020,
 41056, 41061,
 41100
 ARAGO 41023
 ASPIRE DIGITAL
 41168
 AUDIOVOX 40717, 40790
 BEL CANTO DESIGN
 41571
 BLAUPUNKT 40717
 BLUE PARADE
 40571
 BLUE SKY 40695
 BRANDT 40651
 BROKSONIC 40695
 BYD:SIGN 40872
 CALIFORNIA AUDIO LABS
 40490
 CELESTIAL 41020
 CENTREX 40672, 41004
 CINEA 40831
 CINEVISION 40876, 40869
 CITIZEN 41003, 41277
 CLAIRTONE 40571
 COBY 40778, 41086,
 41107
 CRAIG 40831
 CREATIVE 40503, 40539
 CURTIS MATHES
 41087
 CYBERHOME 40816, 40874,
 41023, 41024,
 41117, 41129
 CYTRON 40705
 DAEWOO 40784, 40705,
 40770, 40869,
 41169, 41172
 DANSAI 40770
 DAYTEK 40872
 DECCA 40770
 DENON 40490, 40634,
 41282, 41634
 DENVER 40778
 DIGITREX 40672
 DISNEY 40675, 41270
 DIVIDO 40705
 DUAL 40675
 DURABRAND 41127
 DVD2000 40521
 ELECTROHOME
 41003
 EMERSON 40591, 40675,
 40821, 41268
 ENTERPRISE 40591
 ENTIVO 40503, 40539
 ENZER 40770
 ESA 40821, 41268

FIRSTLINE 40651
 FISHER 40670
 FUNAI 40675, 41268
 GATEWAY 41158
 GE 40522, 40815,
 40717
 GO VIDEO 40573, 40744,
 40717, 40741,
 40783, 40869,
 41044, 41075,
 41099, 41158,
 41304, 41730
 GOLDSTAR 40741, 40801,
 40869
 GOODMAN 40790
 GRADIENTE 40490, 40651
 GREENHILL 40717
 GRUNDIG 40539, 40705
 HARMAN/KARDON
 40582, 40702
 HITACHI 40573, 40664,
 41247, 41664,
 41764
 HITEKER 40672
 I-O DATA 41405
 ILO 41348
 INITIAL 40717
 INSIGNIA 41268
 INTEGRA 40571, 40627,
 41634
 IRT 40783
 JBL 40702
 JENSEN 41016
 JMB 40695
 JVC 40558, 40623,
 40867, 41164,
 41241, 41275,
 41590, 41592,
 41594
 KAWASAKI 40790
 KENWOOD 40490, 40534
 KLH 40717, 40790,
 41020, 41149
 KLOSS 40533
 KOSS 40651, 41061
 LASONIC 40627, 40798
 LECSON 41533
 LENOXX 41127
 LG 40591, 40741,
 40801, 40869,
 41600
 LITEON 41058, 41158,
 41416, 41440
 LOEWE 40741
 LOGIX 40783
 MAGNASONIC 40651, 40675
 MAGNAVOX 40503, 40539,
 40646, 40675,
 40821, 41268
 MARANTZ 40503, 40539,
 40675, 41627
 MCINTOSH 41533
 MEDION 40651
 MEMOREX 40695, 40831,
 41270
 MICROSOFT 40522, 41708
 MINATO 40752
 MINTEK 40839, 40717
 MITSUBISHI 41521, 40521,
 41403, 41629
 NAD 40591, 40741
 NAIKO 40770
 NEC 40785, 40869,
 41404
 NESA 40717
 NEXXTECH 41402
 NORCENT 41003, 40872,
 41107
 ONKYO 40503, 40627,
 40792, 41612,
 41627
 OPTIMUS 40571
 ORION 41695
 ORITRON 40651
 PALSONIC 40672
 PANASONIC 40503, 40490,
 40571, 40703,
 41010, 41011,
 41282, 41362,
 41462, 41490,
 41632, 41641,
 41762
 PHILIPS 40503, 40539,
 40646, 40675,
 40854, 41260,
 41267, 41354
 PIANODISC 41024
 PIONEER 40525, 40571,
 40631, 40638,
 41475, 41476,
 41571
 POLAROID 41020, 41061,
 41086
 POLK AUDIO 40539
 PORTLAND 40770
 PRESIDIAN 40675
 PRIMA 41016
 PROCEED 40672
 PROSCAN 40522
 PROVISION 40778
 QWESTAR 40651
 RADIONETTE 40741
 RADIOSHACK 40571
 RCA 40522, 40571,
 40717, 40790,
 40822, 41022,
 41132
 REALISTIC 40571
 REOC 40752
 RIO 40869
 ROTEL 40623
 ROWA 41004
 SABA 40651
 SAMPO 40752
 SAMSUNG 40490, 40573,
 40744, 40820,
 40899, 41044,
 41075, 41599
 SANSUI 40695, 41695
 SANYO 40670, 40675,
 40695, 41583
 SCHNEIDER 40783
 SCHWAIGER 40752
 SENSORY SCIENCE
 41158
 SHARP 40630, 40675,
 40752, 41256,
 41556, 41642,
 42002
 SHARPER IMAGE
 41117
 SHERWOOD 40770
 SHINSONIC 40533, 40839
 SLIM ART 40784
 SONIC BLUE 40573, 40783,
 40869, 41099

SONY 40533, 41533,
40864, 40772,
41033, 41069,
41070, 41431,
41633
SUPERSCAN 40821
SVA 40717
SYLVANIA 40675, 40821,
41268
SYMPHONIC 40675, 40821,
41268
TATUNG 40770
TEAC 40571, 40717,
40790
TECHNICS 40490, 40703
TECHNIKA 40770
TEVION 40651
THETA DIGITAL
40571
THOMSON 40522
TOSHIBA 40503, 40573,
40539, 40695,
41045, 41154,
41510, 41595,
41639
UNIMAX 40770
UNIVERSUM 40591
URBAN CONCEPTS
40503, 40539
US LOGIC 40839
VENTURER 40790
VICTOR 41241, 41597
WYSE 41652
XBOX 40522, 41708
YAMAHA 40490, 40539,
40545, 41282,
42000, 42001
YAMAKAWA 40872
ZENITH 40503, 40591,
40741, 40869
ZEUS 40784

LD PLAYER

AIWA 40203
CARVER 40064
DENON 40059, 40172,
40241
DISCO VISION 40023
FUNAI 40203
HITACHI 40023
KENWOOD 40236, 40258
MAGNAVOX 40064, 40217,
40241
MARANTZ 40064
MITSUBISHI 40059, 40241
NAD 40059
OPTIMUS 40059
PANASONIC 40204
PHILIPS 40064
PIONEER 40059, 40023,
40241
QUASAR 40204
REALISTIC 40203
SEGA 40023
SHARP 40001
SONY 40193, 40201
TECHNICS 40204
TOSHIBA 40059
VICTOR 40245
WARDS 40059
YAMAHA 40217

DVD RECORDER

ACCURIAN 51416
APEX DIGITAL
51056
ASPIRE DIGITAL
51168
COBY 51086
CYBERHOME 51129
DENON 50490
EMERSON 50675
FUNAI 50675
GATEWAY 51158
GO VIDEO 50741, 51158,
51304, 51730
HITACHI 51664, 51764
JVC 51164, 51275
LG 50741
LITEON 51158, 51416,
51440
MAGNAVOX 50646, 50675
MITSUBISHI 51629
PANASONIC 50490, 51010,
51011
PHILIPS 50646
PIONEER 50631, 51475,
51476
POLAROID 51086
RCA 50522
SAMSUNG 50490
SENSORY SCIENCE
51158
SHARP 50630, 50675,
51556, 51642,
52002
SONY 51033, 51069,
51070, 51431
SYLVANIA 50675
TOSHIBA 51510, 51639
VICTOR 51275
YAMAHA 52001
ZENITH 50741
PANASONIC 50490, 51010,
51011
PHILIPS 50646
PIONEER 50631, 51475,
51476
POLAROID 51086
RCA 50522
SAMSUNG 50490
SENSORY SCIENCE
51158
SHARP 50675, 51550,
51556, 50630
SONY 51033, 51069,
51070, 51431
SYLVANIA 50675
TOSHIBA 51510
VICTOR 51275
YAMAHA 52001
ZENITH 50741

CD PLAYER

ADC 60018
ADCOM 60234
AIWA 60157
AKAI 60083, 60643,
61688
ALBA 60625
ANAM NATIONAL
60362
ARCAM 60157
AUDIO RESEARCH
60157

CAIRN 60157
CALIFORNIA AUDIO LABS
60029, 60303
CAMBRIDGE SOUNDWORKS
60157
CARVER 60157
CCE 60643
CLASSIC 61297
CURTIS MATHES
60032
DENON 60873, 60626,
60003, 60034,
60766
DKK 60000
DMX ELECTRONICS
60157
FISHER 60000, 61325
GEMINI 60625
GENEXXA 60032
GOLDSTAR 61208
GPX 61296
GRUNDIG 60157
HARMAN/KARDON
60100, 60157,
60083, 61202
HITACHI 60032
INKEL 60157, 60180
INTEGRA 60101
JERROLD 60003
JVC 60032, 60072,
61294
KENWOOD 60681, 60826,
60626, 60000,
60029, 60028,
60190, 61683
KOSS 61317
KRELL 60157
KYOCERA 60018
LG 61208
LINN 60157
LUXMAN 60328, 60489
MAGNAVOX 60157, 60038,
60274
MARANTZ 60626, 60029,
60157, 60038,
60180, 60373,
60435
MATSUI 60157
MCS 60029, 60043
MEMOREX 60000, 60032,
60468
MGA 60083
MICROMEGA 60157
MIRO 60000
MISSION 60157
MITSUBISHI 60083, 60808
MODULAIRE 60000, 60032,
60087, 60180,
60468
MTC 60625
NAKAMICHI 60147, 60373
NEC 60043, 60234
NIKKO 60362, 60625
NSM 60157
ONKYO 60868, 61327,
60101, 61685
OPTIMUS 61063, 60000,
60032, 60087,
60468
PANASONIC 60029, 60303,
60388, 60752,
61682
PENNEY 60029
PHILIPS 60626, 60157,
60274

PIONEER 61063, 61062,
60032, 61087,
60468
POLK AUDIO 60157
PROTON 60157
QED 60157
QUAD 60157
QUASAR 60029
RADIOSHACK 60000, 60032,
60180, 60468
RCA 61062, 60032,
60053, 60468
REALISTIC 60000, 60032,
60087, 60180,
60468
REVOX 60157
ROKSAN 60435
ROTEL 60157
SAE 60157
SAMSUNG 60524
SANSUI 60000, 60157
SANYO 60000, 60087
SHARP 60861, 60034,
60180, 61684
SHERWOOD 61067, 60180
SHURE 60043
SONIC FRONTIERS
60157
SONY 60490, 60000,
60100, 61364,
60185, 61790
STS 60018
SUGDEN 60157
SYLVANIA 60157
SYMPHONIC 60180
TAG MCLAREN
60157
TANDY 60032
TDK 61208
TEAC 60490, 60180,
60362
TECHNICS 60029, 60303
TECHWOOD 60303, 60362
THULE AUDIO
60157
TOSHIBA 61693, 61694
VICTOR 60072
WARDS 60032, 60157,
60053, 60087
YAMAHA 60490, 60868,
60888, 60036,
61292, 62000,
62001
YBA 60625
YORX 60000

CD RECORDER

CLASSIC 71297
DENON 70626
FISHER 71325
GPX 71296
HARMAN/KARDON
71202
JVC 71294
KENWOOD 70626
LG 71208
MARANTZ 70626
PHILIPS 70626
PIONEER 71062, 71087
RCA 70053
SONY 70000, 70100,
71364
TDK 71208
YAMAHA 70888, 71292

MD RECORDER

DENON 70873
KENWOOD 70681, 70826,
71683
ONKYO 70868, 71685
OPTIMUS 71063
PANASONIC 71682
PIONEER 71063
SHARP 70861, 71684
SHERWOOD 71067
SONY 70490, 71790
YAMAHA 70490, 70888,
72001

TAPE DECK

AIWA 70197
DENON 70076, 70371,
70412
GARRARD 70308, 70309
JVC 70244, 70273
KENWOOD 70070, 70205,
70365
NIKKO 70365
ONKYO 70135, 70282
OPTIMUS 70027
PANASONIC 70229
PIONEER 70027, 70099
RCA 70027
SHARP 70205, 70371,
70412
SONY 70243, 70170,
70291
TEAC 70308, 70309,
70365
TECHNICS 70229
TECHNOVOX 70229
TECHWOOD 70365
VICTOR 70273
WARDS 70027
YAMAHA 70097, 70205,
70524

TUNER

ADC 80531
AIWA 81405, 80158,
80121, 81388,
81641
ALCO 81390
ANAM 81609, 81074
ARCAM 81189
AUDIO PRO 80148
AUDIOTRONIC
81189
AUDIOVOX 81390
BOSE 81229, 81933
CAPETRONIC 80531
CARVER 81189, 80121
CURTIS MATHES
80014, 80080
DELPHI 81414, 81846
DENON 81360, 80121,
80386, 81142
EMERSON 80531
FISHER 80219
GARRARD 80281
GOLDSTAR 80281
GRUNDIG 80281
HARMAN/KARDON
80110
HITACHI 80386
INTEGRA 80135, 80842,
81298, 81320

JBL 80110
JVC 81058, 80074,
80262, 80464,
81374, 81495,
81665
KAWASAKI 81390
KENWOOD 80027, 80186,
80262
KLH 81390
LG 80281
MAGNAVOX 81189, 81269,
80531, 81266
MARANTZ 81189, 81269,
80039, 81671
MCS 80039
MICROMEGA 81189
MYRYAD 81189
ONKYO 80135, 80380,
80842, 81298,
81320, 81677
OPTIMUS 81023, 80158,
80074, 80014,
80080, 80121,
80186, 80219,
80531, 81074
PANASONIC 81308, 81518,
80039, 80367,
81275, 81288,
81316, 81548,
81633, 81675,
81763, 81764
PENNEY 80039
PHILIPS 81189, 81269,
81266
PIONEER 81023, 80014,
80080, 80150,
80281, 80531,
80630, 81284,
81384, 81678
POLK AUDIO 81414
PROSCAN 81254
QUASAR 80039
RADIOSHACK 81609
RCA 81023, 81609,
81254, 80080,
80531, 81074,
81390, 81511
REALISTIC 81609, 80158,
80121, 80186
SANSUI 81189, 80148,
81764
SANYO 80219
SHARP 80186, 80262
SONIC 80281
SONY 81058, 81441,
81258, 81759,
81622, 80158,
81406, 81558,
81658, 81758,
81858
STEREOPHONICS
81023
TEAC 81074, 81390
TECHNICS 81308, 81518,
80039, 81384,
81633, 81675
TECHWOOD 80281
THORENS 81189
TOSHIBA 80080, 80135,
80842
VENTURER 81390
VICTOR 80074
WARDS 80158, 80014,
80080

XM 81406, 81414,
81846
YAMAHA 81023, 80176,
80186, 80376,
81176, 81276,
81331, 81375,
81949, 82004,
82005, 82006,
82007
ZENITH 80281

OTHER AUDIO ACCESSORIES

YAMAHA 82001, 82002
(iPod) 82000



© 2007 YAMAHA CORPORATION All rights reserved.

YAMAHA ELECTRONICS CORPORATION, USA 6660 ORANGETHORPE AVE., BUENA PARK, CALIF. 90620, U.S.A.
YAMAHA CANADA MUSIC LTD. 135 MILNER AVE., SCARBOROUGH, ONTARIO M1S 3R1, CANADA
YAMAHA ELECTRONIK EUROPA G.m.b.H. SIEMENSSTR. 22-34, 25462 RELINGEN BEI HAMBURG, GERMANY
YAMAHA ELECTRONIQUE FRANCE S.A. RUE AMBROISE CROIZAT BP70 CROISSY-BEAUBOURG 77312 MARNE-LA-VALLEE CEDEX02, FRANCE
YAMAHA ELECTRONICS (UK) LTD. YAMAHA HOUSE, 200 RICKMANSWORTH ROAD WATFORD, HERTS WD18 7GQ, ENGLAND
YAMAHA SCANDINAVIA A.B. J A WETTERGRENS GATA 1, BOX 30053, 400 43 VÄSTRA FRÖLUNDA, SWEDEN
YAMAHA MUSIC AUSTRALIA PTY, LTD. 17-33 MARKET ST., SOUTH MELBOURNE, 3205 VIC., AUSTRALIA

YAMAHA CORPORATION
Printed in China  WJ63930

The circled numbers and alphabets correspond to those in the Owner's Manual.

■ Front panel

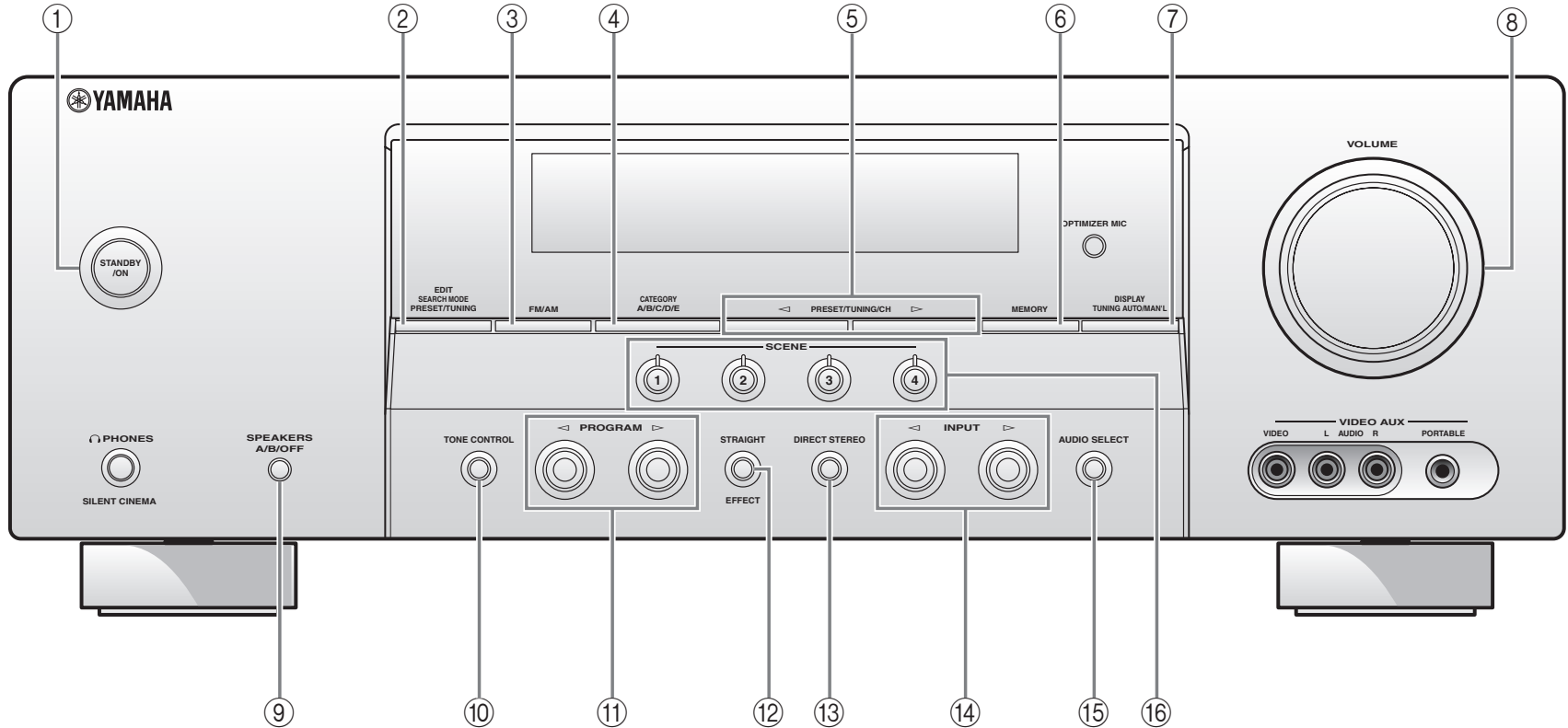

Remote control

