

MCR-040/140

(CRX-040/140 + NS-BP80)

MICRO COMPONENT SYSTEM

MICRO-CHAÎNE



OWNER'S MANUAL
MODE D'EMPLOI

IMPORTANT SAFETY INSTRUCTIONS

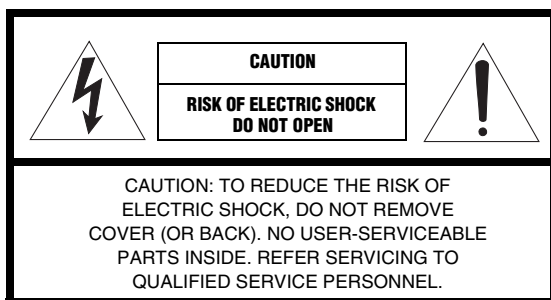

• Explanation of Graphical Symbols



The lightning flash with arrowhead symbol, within an equilateral triangle, is intended to alert you to the presence of uninsulated “dangerous voltage” within the product’s enclosure that may be of sufficient magnitude to constitute a risk of electric shock to persons.



The exclamation point within an equilateral triangle is intended to alert you to the presence of important operating and maintenance (servicing) instructions in the literature accompanying the appliance.

IMPORTANT

Please record the serial number of this unit in the space below.

MODEL:

Serial No.:

The serial number is located on the rear of the unit. Retain this Owner’s Manual in a safe place for future reference.

- 1 Read these instructions.
- 2 Keep these instructions.
- 3 Heed all warnings.
- 4 Follow all instructions.
- 5 Do not use this apparatus near water.
- 6 Clean only with dry cloth.
- 7 Do not block any ventilation openings. Install in accordance with the manufacturer’s instructions.
- 8 Do not install near any heat sources such as radiators, heat registers, stoves, or other apparatus (including amplifiers) that produce heat.
- 9 Do not defeat the safety purpose of the polarized or grounding-type plug. A polarized plug has two blades with one wider than the other. A grounding type plug has two blades and a third grounding prong. The wide blade or the third prong are provided for your safety. If the provided plug does not fit into your outlet, consult an electrician for replacement of the obsolete outlet.
- 10 Protect the power cord from being walked on or pinched particularly at plugs, convenience receptacles, and the point where they exit from the apparatus.
- 11 Only use attachments/accessories specified by the manufacturer.
- 12 Use only with the cart, stand, tripod, bracket, or table specified by the manufacturer, or sold with the apparatus. When a cart is used, use caution when moving the cart/apparatus combination to avoid injury from tip-over.
- 13 Unplug this apparatus during lightning storms or when unused for long periods of time.
- 14 Refer all servicing to qualified service personnel. Servicing is required when the apparatus has been damaged in any way, such as power-supply cord or plug is damaged, liquid has been spilled or objects have fallen into the apparatus, the apparatus has been exposed to rain or moisture, does not operate normally, or has been dropped.



We Want You Listening For A Lifetime

Yamaha and the Electronic Industries Association’s Consumer Electronics Group want you to get the most out of your equipment by playing it at a safe level. One that lets the sound come through loud and clear without annoying blaring or distortion – and, most importantly, without affecting your sensitive hearing. Since hearing damage from loud sounds is often undetectable until it is too late, Yamaha and the Electronic Industries Association’s Consumer Electronics Group recommend you to avoid prolonged exposure from excessive volume levels.



FCC INFORMATION (for US customers)

1 **IMPORTANT NOTICE: DO NOT MODIFY THIS UNIT!**

This product, when installed as indicated in the instructions contained in this manual, meets FCC requirements. Modifications not expressly approved by Yamaha may void your authority, granted by the FCC, to use the product.

2 **IMPORTANT:** When connecting this product to accessories and/or another product use only high quality shielded cables. Cable/s supplied with this product **MUST** be used. Follow all installation instructions. Failure to follow instructions could void your FCC authorization to use this product in the USA.

3 **NOTE:** This product has been tested and found to comply with the requirements listed in FCC Regulations, Part 15 for Class "B" digital devices. Compliance with these requirements provides a reasonable level of assurance that your use of this product in a residential environment will not result in harmful interference with other electronic devices.

This equipment generates/uses radio frequencies and, if not installed and used according to the instructions found in the users manual, may cause interference harmful to the operation of other electronic devices.

Compliance with FCC regulations does not guarantee that interference will not occur in all installations. If this product is found to be the source of interference, which can be determined by turning the unit "OFF" and "ON", please try to eliminate the problem by using one of the following measures:

Relocate either this product or the device that is being affected by the interference.

Utilize power outlets that are on different branch (circuit breaker or fuse) circuits or install AC line filter/s.

In the case of radio or TV interference, relocate/reorient the antenna. If the antenna lead-in is 300 ohm ribbon lead, change the lead-in to coaxial type cable.

If these corrective measures do not produce satisfactory results, please contact the local retailer authorized to distribute this type of product. If you can not locate the appropriate retailer, please contact Yamaha Electronics Corp., U.S.A. 6660 Orangethorpe Ave, Buena Park, CA 90620.

The above statements apply **ONLY** to those products distributed by Yamaha Corporation of America or its subsidiaries.

The following information applies for MCR-140 only.

- This equipment complies with FCC/IC radiation exposure limits set forth for uncontrolled equipment and meets the FCC radio frequency (RF) Exposure Guidelines in Supplement C to OET65 and RSS-102 of the IC radio frequency (RF) Exposure rules. This equipment has very low levels of RF energy that it deemed to comply without maximum permissive exposure evaluation (MPE). But it is desirable that it should be installed and operated with at least 20 cm and more between the radiator and person's body (excluding extremities: hands, wrists, feet and ankles).
- This transmitter must not be co-located or operated in conjunction with any other antenna or transmitter.

NOTICE

This equipment has been tested and found to comply with the limits for a Class B digital device, pursuant to part 15 of the FCC Rules. These limits are designed to provide reasonable protection against harmful interference in a residential installation.

This equipment generates, uses and can radiate radio frequency energy and, if not installed and used in accordance with the instructions, may cause harmful interference to radio communications. However, there is no guarantee that interference will not occur in a particular installation. If this equipment does cause harmful interference to radio or television reception, which can be determined by turning the equipment off and on, the user is encouraged to try to correct the interference by one or more of the following measures:

- Reorient or relocate the receiving antenna
- Increase the separation between the equipment and receiver.
- Connect the equipment into an outlet on a circuit different from that to which the receiver is connected.
- Consult the dealer or an experienced radio/TV technician for help.

FCC WARNING

Change or modifications not expressly approved by the party responsible for compliance could void the user's authority to operate the equipment.

Caution: Read this before operating your unit.

- To assure the finest performance, please read this manual carefully. Keep it in a safe place for future reference.
- Install this sound system in a well ventilated, cool, dry, clean place - away from direct sunlight, heat sources, vibration, dust, moisture, and/or cold. For proper ventilation, allow the following minimum clearances around CRX-040/140.
Top: 10 cm (4 in)
Rear: 10 cm (4 in)
Sides: 10 cm (4 in)
- Locate this unit away from other electrical appliances, motors, or transformers to avoid humming sounds.
- Do not expose this unit to sudden temperature changes from cold to hot, and do not locate this unit in an environment with high humidity (i.e. a room with a humidifier) to prevent condensation inside this unit, which may cause an electrical shock, fire, damage to this unit, and/or personal injury.
- Avoid installing this unit where foreign object may fall onto this unit and/or this unit may be exposed to liquid dripping or splashing. On the top of this unit, do not place:
 - Other components, as they may cause damage and/or discoloration on the surface of this unit.
 - Burning objects (i.e. candles), as they may cause fire, damage to this unit, and/or personal injury.
 - Containers with liquid in them, as they may fall and liquid may cause electrical shock to the user and/or damage to this unit.
- Do not cover this unit with a newspaper, tablecloth, curtain, etc. in order not to obstruct heat radiation. If the temperature inside this unit rises, it may cause fire, damage to this unit, and/or personal injury.
- Do not plug in this unit to a wall outlet until all connections are complete.
- Do not operate this unit upside-down. It may overheat, possibly causing damage.
- Do not use force on switches, knobs and/or cords.
- When disconnecting the power cable from the wall outlet, grasp the plug; do not pull the cable.
- Do not clean this unit with chemical solvents; this might damage the finish. Use a clean, dry cloth.
- Only voltage specified on this unit must be used. Using this unit with a higher voltage than specified is dangerous and may cause fire, damage to this unit, and/or personal injury. Yamaha will not be held responsible for any damage resulting from use of this unit with a voltage other than specified.
- To prevent damage by lightning, keep the power cable and outdoor antennas disconnected from a wall outlet or this unit during a lightning storm.
- Do not attempt to modify or fix this unit. Contact qualified Yamaha service personnel when any service is needed. The cabinet should never be opened for any reasons.
- When not planning to use this unit for long periods of time (i.e. vacation), disconnect the AC power plug from the wall outlet.
- Be sure to read the "TROUBLESHOOTING" section on common operating errors before concluding that this unit is faulty.
- Before moving this unit, press \odot to set this unit to the standby mode, and disconnect the AC power plug from the wall outlet.
- Condensation will form when the surrounding temperature changes suddenly. Disconnect the power cable from the outlet, then leave this unit alone.
- When using this unit for a long time, this unit may become warm. Turn the power off, then leave this unit alone for cooling.
- Install this unit near the AC outlet and where the AC power plug can be reached easily.
- The batteries shall not be exposed to excessive heat such as sunshine, fire or the like. When you dispose of batteries, follow your regional regulations.
- Excessive sound pressure from earphones and headphones can cause hearing loss.

This unit is not disconnected from the AC power source as long as it is connected to the wall outlet, even if this unit itself is turned off by \odot . This state is called the standby mode. In this state, this unit is designed to consume a very small quantity of power.

WARNING

TO REDUCE THE RISK OF FIRE OR ELECTRIC SHOCK, DO NOT EXPOSE THIS UNIT TO RAIN OR MOISTURE.

LASER SAFETY

This unit employs a laser. Due to possible eye injury, only a qualified service person should remove the cover or attempt to service this device.

DANGER

This unit emits visible laser radiation when open. Avoid direct eye exposure to beam. When this unit is plugged into the wall outlet, do not place your eyes close to the opening of the disc tray and other openings to look into inside.

The laser component in this product is capable of emitting radiation exceeding the limit for Class 1.

CAUTION

Danger of explosion if battery is incorrectly replaced. Replace only with the same or equivalent type.

Do not use MCR-140 within 22 cm (9 in) of persons with a heart pacemaker implant or defibrillator implant.

FOR CANADIAN CUSTOMERS

To prevent electric shock, match wide blade of plug to wide slot and fully insert.
This Class B digital apparatus complies with Canadian ICES-003.

CONTENTS

PREPARATION

PARTS	2
PLAYABLE DISCS AND FILE FORMAT	3
CONNECTION.....	4
Basic connection.....	4
Wireless connection MCR-140	5
Other connection.....	5
REMOTE CONTROL	6
FRONT PANEL DISPLAY	6

OPERATION

FRONT PANEL AND BASIC OPERATION	7
LISTENING TO MUSIC.....	8
Playback operation.....	8
Other operation	9
LISTENING TO FM RADIO STATIONS	10
Tuning to radio stations	10
Presetting radio stations.....	10
Selecting preset radio stations (Preset tuning).....	10
USING USEFUL FUNCTIONS	11
Using setup menu	11
Using timer and sleep timer.....	13

ADDITIONAL INFORMATION



TROUBLESHOOTING	14
General.....	14
Radio reception.....	15
iPod™.....	15
USB	18
Disc playback	19
Remote control	19
HANDLING COMPACT DISCS	20
SPECIFICATIONS.....	20

PREPARATION

OPERATION

ADDITIONAL
INFORMATION

■ About this manual

- This manual describes how to operate this unit using a remote control except when it is not available. Some of these operations are also available using the front panel buttons.
- The symbol “” with page number(s) indicates the corresponding reference page(s).
- Notes contain important information about safety and operating instructions.  indicates a tip for your operation.
- This manual is printed prior to production. Design and specifications are subject to change in part as a result of improvements, etc. In case of differences between the manual and the product, the product has priority.

■ Copyright and logo marks

Advanced YST

In 1988, Yamaha brought to the marketplace speaker systems utilizing YST (Yamaha Active Servo Technology) to give powerful, high quality bass reproduction. This technique uses a direct connection between the amplifier and speaker, allowing accurate signal transmission and precise speaker control.

As this technology uses speaker units controlled by the negative impedance drive of the amplifier and resonance generated between the speaker cabinet volume and port, it creates more resonant energy (the “air woofer” concept) than the standard bass reflex method. This allows for bass reproduction from much smaller cabinets than was previously possible.

yAired **MCR-140**

Real-time uncompressed music transfer without sound degradation is realized by Yamaha original digital wireless transfer technology, yAired. You can also control turning on/standby and volume with the iPod by yAired.

yAired

English

PARTS

Make sure you have all of the following items.

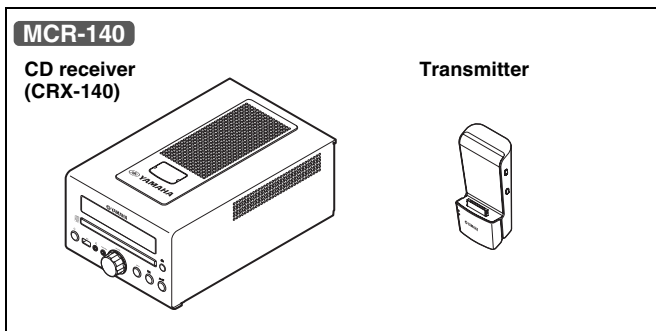
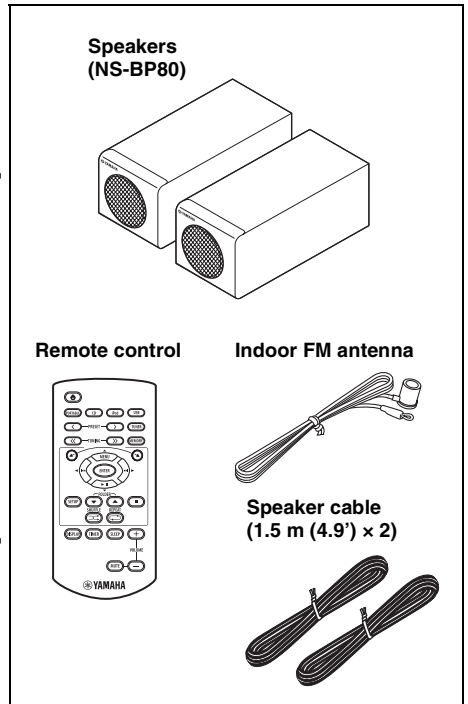
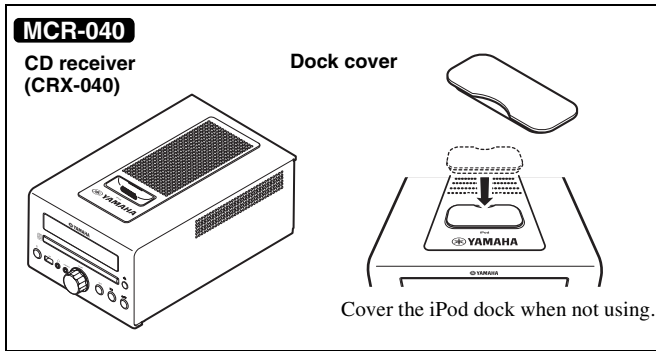

■ Using the remote control

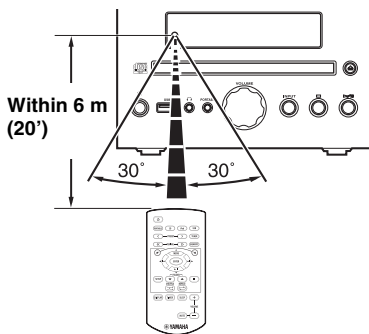

Use the remote control within 6 m (20') of this unit and point it toward the remote control sensor.

Notes

- Do not spill liquid on the remote control.
- Do not drop the remote control.
- Do not leave the remote control in the following places:
 - hot or humid places such as a bathroom or near a heater
 - extremely cold places
 - dusty places

■ Replacing the battery in the remote control

Change the battery when the operation range of the remote control decreases.

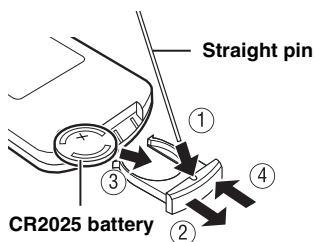

PLAYABLE DISCS AND FILE FORMAT

■ Playable discs

Use compact discs bearing the marks below.



.... **Compact discs (digital audio)**



.... **CD-R, CD-RW digital audio discs**

- CD-R or CD-RW discs bearing one of the following phrases.
FOR CONSUMER
FOR CONSUMER USE
FOR MUSIC USE ONLY



- Finalized CD-R or CD-RW discs

Note

This compact disc player may not be able to play some CD-R/CD-RW discs or discs on which recording was not made correctly.



.... **CD-TEXT discs**



To play back an 8-cm (3 in) CD

Place it in the inner recessed area of the disc tray. Do not put a normal (12-cm) CD on top of an 8-cm (3 in) CD.

To prevent a malfunction of this unit:

- Do not use any nonstandard shaped disc (heart, etc.) available on the market because it might damage the unit.
- Do not use a disc with tape, stickers, or paste on it. If you use such a disc, the disc may get stuck in the unit, or damage to the unit may result.

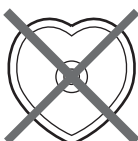

Note: Do not use any lens cleaners as they may be a cause of malfunction.

■ Playable MP3 and WMA files

MP3

Format	Bitrate (kbps)	Sampling frequency (kHz)
MPEG 1 Audio Layer-3	32-320*1	32/44.1/48
MPEG 2 Audio Layer-3, 2	8-160*1	16/22.05/24

*1 Variable bitrate is supported.

WMA

- Version 8
- Version 9 (Standard and variable bitrates are supported. Professional and Lossless are not supported.)

Profile	Bitrate (kbps)	Sampling frequency (kHz)
High Profile	32-320*2	32/44.1/48
Mid Profile	16-32	22.05

*2 Both constant and variable bitrates are supported.

Notes

- Playback for Data Disc starts in alphanumeric order of files.
- Playback for USB starts in order by date and time of creation.
- Copyright-protected WMA (DRM) files cannot be played back by this unit.
- The disc must be ISO 9660 compatible.
- The maximum file and folder numbers are as follows.

	Data Disc	USB
Maximum total number of file and folder*3	512	9,999
Maximum folder number*3	255	255
Maximum file number per folder	511	255

*3 The root is counted as one of the folders.

CONNECTION

Basic connection

Follow the procedure below to connect the speakers and indoor FM antenna to this unit.

CAUTION

Do not connect the power cable of this unit until all cable connections are completed.

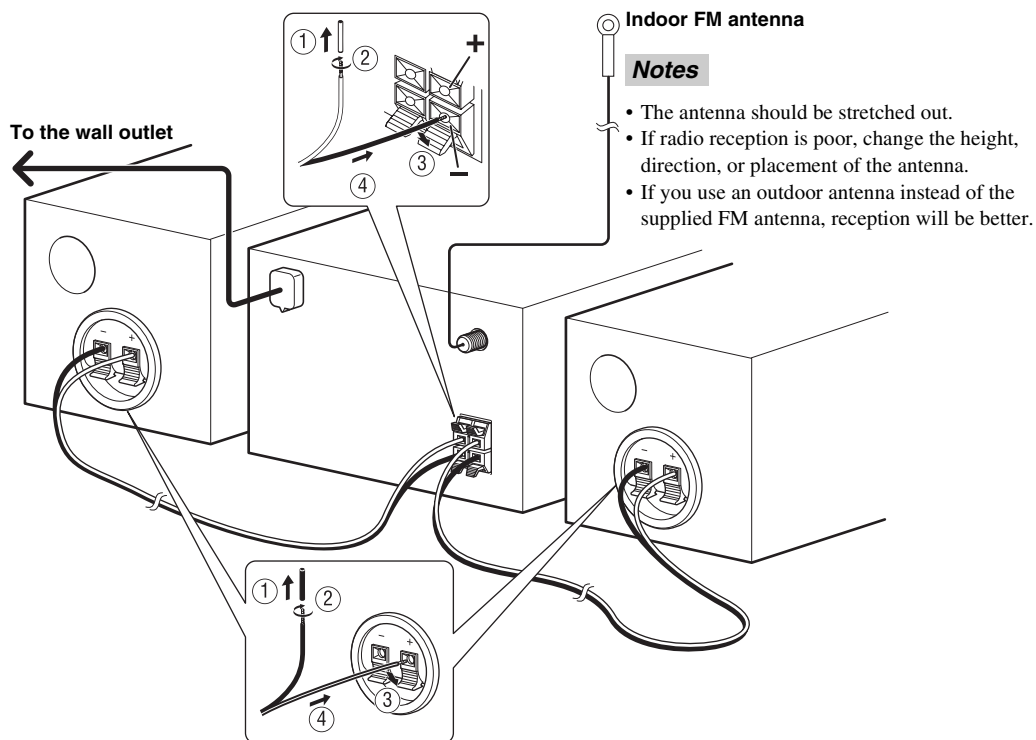

Notes

- Be sure to connect the left channel (L), right channel (R), "+" (red) "-" (black) properly. If the connections are faulty, no sound will be heard from the speakers, and if the polarity of the speaker connections is incorrect, the sound will be unnatural and lacks bass.
- Do not let the bare speaker wires touch each other or do not let them touch any metal part of this unit. This could damage this unit and/or the speakers.
- Use the supplied speakers only. Using different speakers may cause the sound to differ from the intended design.
- There is a chance that placing speakers too close to a CRT-based (Braun tube) TV set might impair picture color. Should this happen, move the speakers away from the TV set.

Wireless connection **MCR-140**

Playback operation with your iPod connected to the transmitter turns the unit on automatically, and you can enjoy the music in your iPod.



To turn on the unit by the playback operation of your iPod, set POWER SAVING to NORMAL (P. 11).

Note

The volume of the unit is adjusted simultaneously with the iPod. Be careful when controlling the volume with your iPod.

Group setting

To operate your iPod using transmitter, you need to match the wireless group between the transmitter and the CD receiver (CRX-140). The default setting for both the transmitter and the CD receiver is A2.

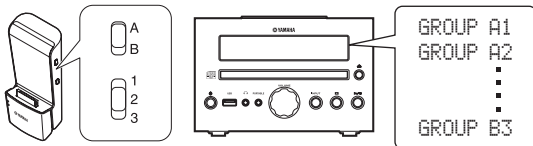

To select wireless group of the CD receiver (CRX-140)

<p>1</p> <p>Press SETUP.</p>	<p>2</p> <p>Select WIRELESS SET menu.</p>
<p>3</p> <p>Confirm with ENTER.</p>	<p>4</p> <p>Select the group.</p>
<p>5</p> <p>Complete the setting.</p>	<p>6</p> <p>Exit setup menu.</p>

Wireless connection to Subwoofer

You can use a subwoofer wirelessly with the wireless subwoofer kit (SWK-W10, etc., sold separately). To establish the wireless connection, set WIRELESS SW to YES (P. 11). For details, refer to the owner's manual of SWK-W10.

Other connection

Stationing iPod

Station or remove your iPod whenever you want.



Your iPod is automatically charged when your iPod is set in the iPod dock/charging cradle, even if the unit is in standby mode.

Note

The unit is compatible with iPod (5th generation), iPod classic, iPod nano, and iPod touch.

MCR-040

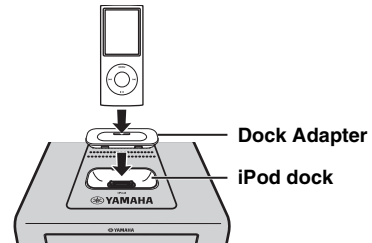

Note

To secure the connection, attach a compatible Dock Adapter supplied with the iPod or an iPod Universal Dock Adapter (sold separately), and remove the protective case covering your iPod.

MCR-140

Station your iPod in the charging cradle when you want to charge your iPod. You can also control your iPod with the remote control when your iPod is in the charging cradle.

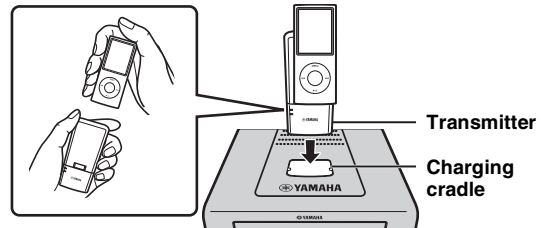

Connecting USB

Connect or remove your USB device whenever you want.

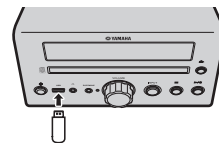

USB device is automatically charged when it is connected to the unit, even if the unit is in standby mode.

Notes

- This unit supports USB mass storage class devices (e.g., flash memories or portable audio players) using FAT16 or FAT32 format.
- Do not connect devices other than USB mass storage class devices (such as USB chargers or USB hubs), PCs, card readers, an external HDD, etc.

REMOTE CONTROL

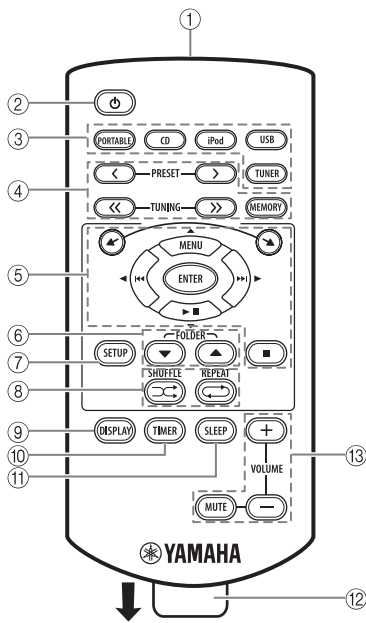

- ① Infrared signal transmitter (☞ P. 2)
- ② ⏻: standby/on
- ③ Source buttons: PORTABLE, CD, iPod, USB (☞ P. 8, 10)
- ④ FM control buttons (☞ P. 10)
- ⑤ ▲/▼: iPod scroll buttons (☞ P. 8)
 MENU/ENTER/▶▶/▶▶◀◀/▶▶◀◀▶▶▶▶: multi function buttons (☞ P. 8, 9, 10, 11)
 ■: Stop button (☞ P. 8, 9)
- ⑥ FOLDER ▼/▲ (☞ P. 8)
- ⑦ SETUP (☞ P. 5, 11)
- ⑧ SHUFFLE/REPEAT (☞ P. 9)
- ⑨ DISPLAY (☞ P. 9, 12)
- ⑩ TIMER (☞ P. 12, 13)
- ⑪ SLEEP (☞ P. 13)
- ⑫ Battery insulation sheet: Remove before using.
- ⑬ Volume control buttons: Press to control the volume.
 Press MUTE to turn off the sound. Press again to resume the volume.

FRONT PANEL DISPLAY

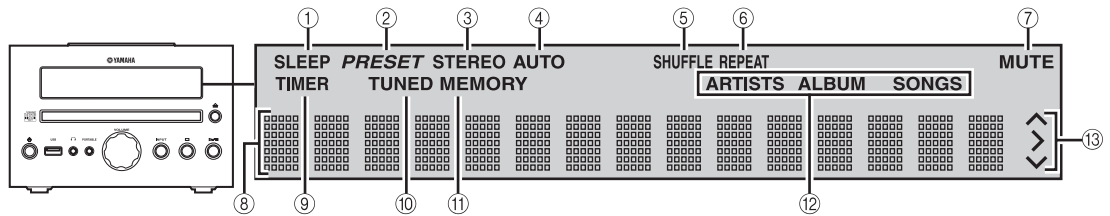

- ① SLEEP indicator: Lights up when the sleep timer is on (☞ P. 13).
- ② PRESET indicator: Lights up when you preset radio stations (☞ P. 10).
- ③ STEREO indicator: Lights up when this unit is receiving a strong signal from an FM stereo broadcast.
- ④ AUTO indicator: Lights up when this unit is in the Automatic Tuning mode (☞ P. 10).
- ⑤ SHUFFLE indicator: Lights up when you set your iPod (MCR-040)/CD/USB to shuffle play (☞ P. 9).
- ⑥ REPEAT indicator: Lights up when you set your iPod (MCR-040)/CD/USB to repeat play (☞ P. 9).
- ⑦ MUTE indicator: Lights up when the sound is muted.
- ⑧ Multi information display: Shows the various information such as the tuning frequency.
- ⑨ TIMER indicator: Flashes during timer setting. Lights up when the timer is on (☞ P. 13).
- ⑩ TUNED indicator: Lights up when this unit is tuned into a station (☞ P. 10).
- ⑪ MEMORY indicator: Flashes when searching for a radio station by automatic preset tuning. Lights up when you preset radio stations automatically or manually (☞ P. 10).
- ⑫ Multi information indicator: Indicates the music information currently displayed on Multi information display (☞ P. 9).
- ⑬ Operation indicators: Shows operable multi function buttons for a currently selected SETUP item.

FRONT PANEL AND BASIC OPERATION



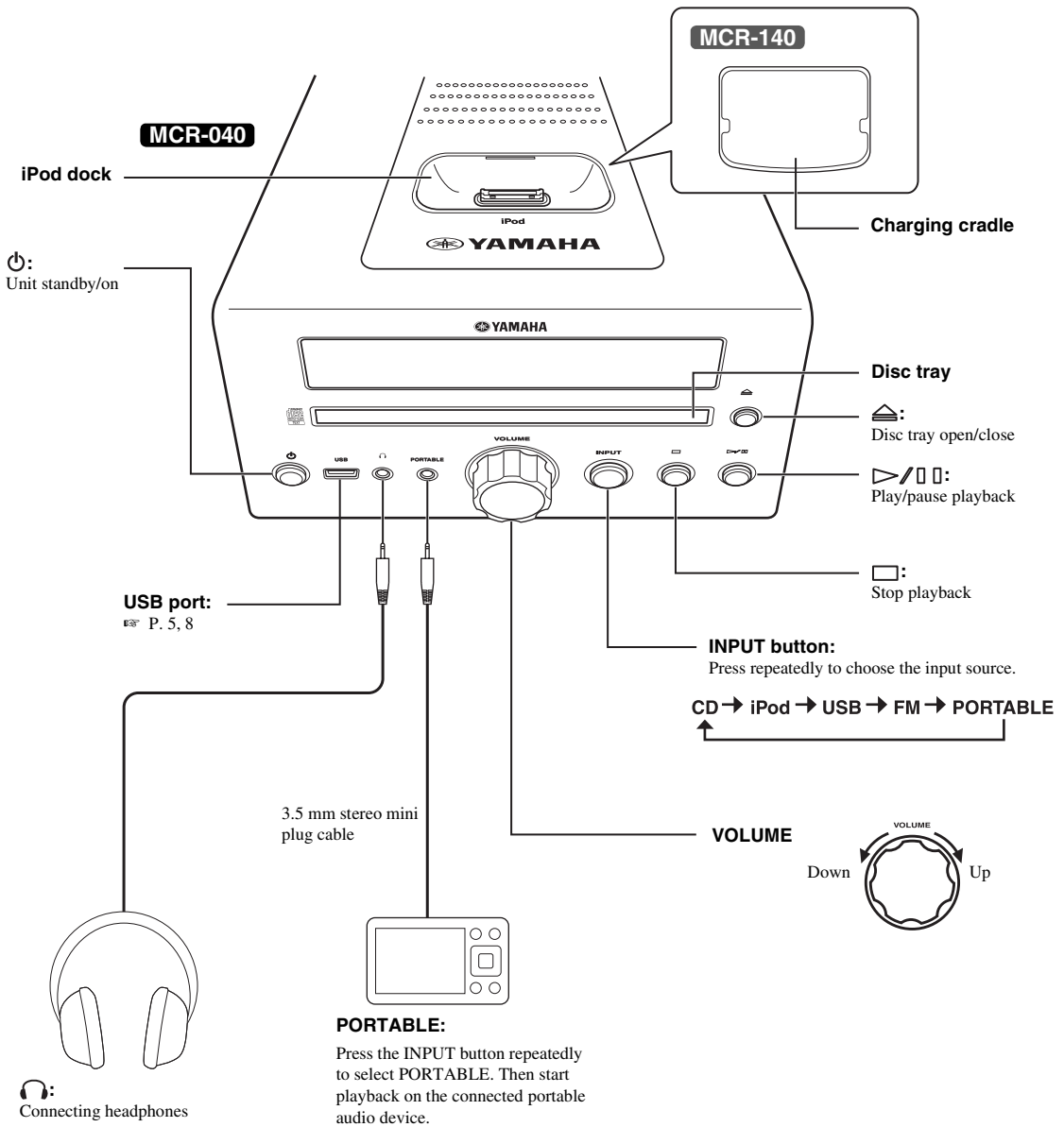



- This unit has an automatic standby function, which will automatically switch the unit to standby mode if the unit is left turned on for 1 hour without playback or any other operation being performed. This function is not available when the source is set to PORTABLE/FM.
- Press to set the unit to standby mode. All the information on the front panel display is not displayed in standby mode. This can reduce power consumption. To turn on the unit, press / , or start playback with your iPod connected to the transmitter (MCR-140 only).
- If the iPod selected as the input source is disconnected from the transmitter, or does not output sound for a certain period, the unit will automatically switch to standby mode (MCR-140 only).

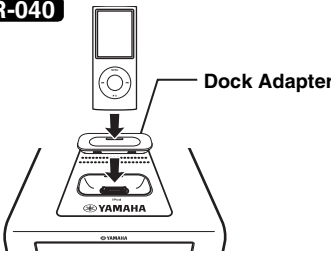

LISTENING TO MUSIC

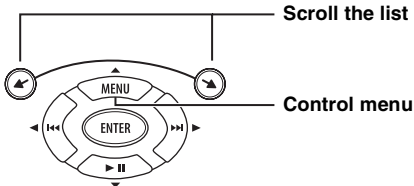
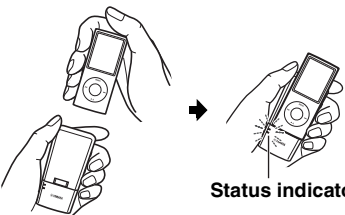
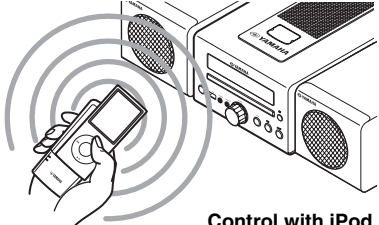
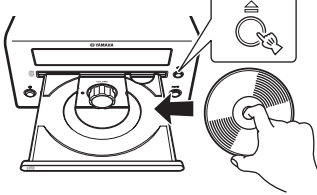
Playback operation

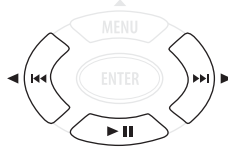
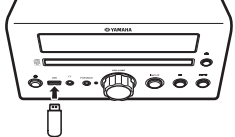
Follow the procedures below to play back music.

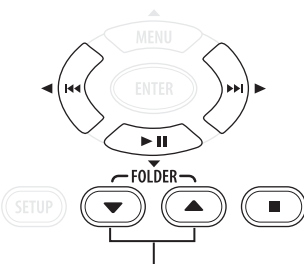
	1 Set the source	2 Switch the input	3 Select music and start playback
iPod*1	<p>MCR-040</p>  <p>Dock Adapter</p> <p>P. 5</p>		<p>Scroll the list</p>  <p>Control menu</p> <p>For the MCR-140, the operation on the remote control or front panel is available only when your iPod is stationed in the charging cradle (P. 5).</p>
	<p>MCR-140</p>  <p>Status indicator</p> <p>P. 5, 16</p>		<p>MCR-140</p>  <p>Control with iPod</p> <p>Be careful when controlling the volume (P. 5).</p>
CD			
USB*2	 <p>P. 5</p>		 <p>Skip to the first file in the previous/next folder for MP3 or WMA*3</p>

*1 Some features may not be available depending on the model or the software version of your iPod.

*2 • Some devices may not work properly even if they meet the requirements.

• Playability of and power supply to all kind of USB devices are not guaranteed.

• The reading time may exceed 30 seconds depending on the number of files/folders.

• Yamaha and suppliers accept no liability for the loss of data saved on the USB devices connected to this unit.

As a precaution, it is recommended that the files are made backup copies.

*3 If you press these buttons during playback, the folder name is displayed on the front panel display for a certain period.

Other operation

Control playback

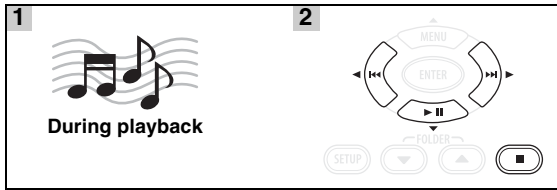

- ▶▶: Skip forward/Press and hold to Fast forward
- ◀◀: Skip backward/Press and hold to Rewind
- ▶||: Play/Pause
- : Stop

Notes

- Playback for Data Disc starts in alphanumeric order of files.
- Playback for USB starts in order by date and time of creation.

Shuffle play

You can play back in random sequence.



For iPod

OFF → SONGS → (ALBUMS)*1

*1 You cannot set ALBUMS when you use an iPod touch.

For CD/USB

OFF → (FOLDER)*2 → ALL

*2 If the audio format of the selected music source is MP3/WMA, you can also select FOLDER.

Repeat play

You can play back repeatedly.



OFF → ONE → (FOLDER)*3 → ALL

*3 If the audio format of the selected music source is MP3/WMA, you can also select FOLDER.

Switching the display

You can switch the playback information shown on the front panel display. Some special characters may not be shown properly.

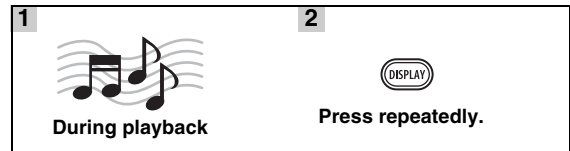

For iPod (MCR-040)

Song number and elapsed time (default setting)

↓

Song number and remaining time

↓

Song name

↓

Artist name

↓

Album name

↓

Back to the default setting

Note

This function is available for iPod (5th generation), iPod classic, iPod nano, and iPod touch. However, even with these models, this function may not be available depending on the software version of your iPod.

For CD/USB

Track/file number and elapsed time of the current song (default setting)

↓

Track number and remaining time of the current song*4

↓

Total time of the disc*4

↓

Remaining time of the disc*4

↓

File name*5

↓

Track name*6

↓

Artist name*6

↓

Album name*6

↓

Back to the default setting

*4 Only for Audio CDs

*5 Only for MP3/WMA files

*6 Only when the selected track has information

LISTENING TO FM RADIO STATIONS

Tuning to radio stations

1  Press TUNER .	2  Press and hold. Automatic tuning starts.
---	--



If the signal received from the station you want to select is weak, you can also tune into radio stations manually by pressing **TUNING** repeatedly.



Note

If you tune to a station manually, the sound is monaural.

Presetting radio stations

You can store your favorite FM stations with the preset function.





Automatic preset tuning

1  Press and hold MEMORY for more than 2 seconds in FM mode.	2  Start the automatic preset.
---	--

Note

When you perform the automatic preset, all stored stations are cleared and the new stations are stored.

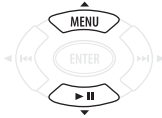
Manual preset tuning

1  Tune into a favorite radio station.	2  Press MEMORY .
3  Select the preset number you want to store to.	4  Complete the manual preset.



- You can preset up to 30 FM stations.
- To cancel the manual preset while choosing a preset number, press **MEMORY** again.
- You can delete a preset station by pressing **SETUP** → **MENU** → **▲/▼** → **ENTER** to select PRESET DELETE.

Selecting preset radio stations (Preset tuning)

	Select the preset radio station in FM mode.
---	---

USING USEFUL FUNCTIONS

Using setup menu

The setup menu appears on the front panel display by pressing **SETUP**. You can set various useful functions with setup menu.

Setup menu	Parameter or control range	Reference page
PRESET DELETE	(Displays only when the input source is set to FM.)	10
DIMMER	DIMMER ON (25%)/OFF (100%)	below
TREBLE	-6 dB to +6 dB	below
BASS	-6 dB to +6 dB	below
BALANCE	L+5 - CENTER - R+5	below
CLOCK SET	Hour, minute	12
TIMER SET	Time (hour, minute), running time, sound (source, track or preset number), timer on/off	12
WIRELESS SET MCR-140	GROUP A1/A2/A3/B1/B2/B3	5
POWER SAVING MCR-140	NORMAL/ECO	below
WIRELESS SW MCR-140	NO/YES	below

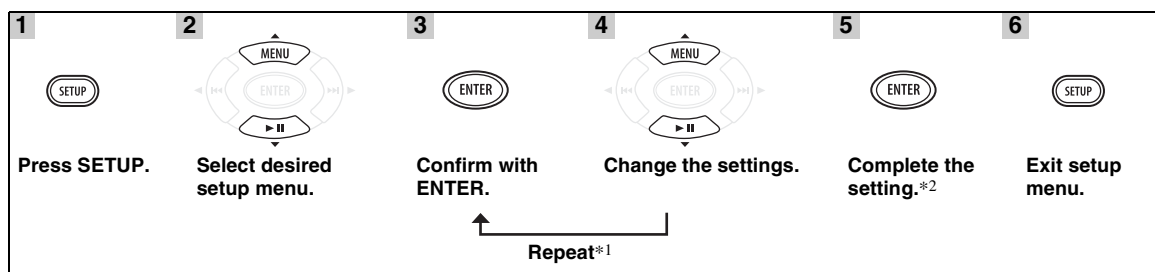

*1 When there are some parameters to set, repeat steps 3 and 4. You can go back to a previous parameter by pressing **◀◀**.

*2 To set additional items, repeat steps 2 to 5.



To cancel the setting during the operation, press **SETUP**.

■ Setting dimmer, tone/balance and power saving mode

DIMMER: Changes the brightness of the front panel display.

TREBLE*3: Adjusts the high frequency response.

BASS*3: Adjusts the low frequency response.

BALANCE: Adjusts the volume level of each left and right speaker channel.

POWER SAVING: If you set to ECO, you can reduce standby power consumption. However, you cannot turn on the unit by playback operation on your iPod during standby mode. The default setting is NORMAL. This function is available only for MCR-140.

WIRELESS SW: Set to YES when you use a subwoofer via the wireless subwoofer kit (SWK-W10, etc., sold separately). The default setting is NO. This function is available only for MCR-140.

*3 Also effective when you are using headphones.

■ **Adjusting the clock**

CLOCK SET: To set hour and minute, repeat steps 3 and 4 on page 11.



The current time appears on the front panel display for a certain period by pressing and holding **DISPLAY** if the time setting has completed.

Note

The time setting is lost once the power cable is disconnected from the wall outlet.

■ **Setting the timer**

TIMER SET: To select the following setting items, repeat steps 3 and 4 on page 11.



You can enter TIMER SET directly by pressing and holding **TIMER**.

Time (hour and minute)



Running time



You can choose the running time from 10 minutes to 90 minutes in 10 minute increments.
 “--” means the unit will not be set to standby mode automatically.

Input source and track/file number or preset number

Notes

- If the source is not set properly, the timer sound will not be heard. Make sure that the source is set securely.
- MCR-140: When you select an iPod as the input source, you need to set the iPod in the charging cradle on the unit.

iPod:

When you select the iPod as a source, this unit resumes the music that you were listening to last time.

CD:

Set a track/file number.

If you set the track/file number which is not exist, the first track/file is played back automatically.

USB:

Set a file number.

If you set a file number that does not exist, the first file is played back automatically.

FM:

Set preset number.

By selecting “--”, the FM station you set last time is set.

Timer ON/OFF

Switch the timer on/off. When the timer is on, the **TIMER** indicator lights up on the front panel display (P. 6).



This setting is also available with **TIMER** (P. 6, 13).

Using timer and sleep timer

■ Using the timer

The timer sets the unit to play back music at the time you set. The unit is set to standby mode after the specified running time elapses.

To use the timer, set the appropriate input source securely and set the timer in the setup menu in advance (☞ P. 12).

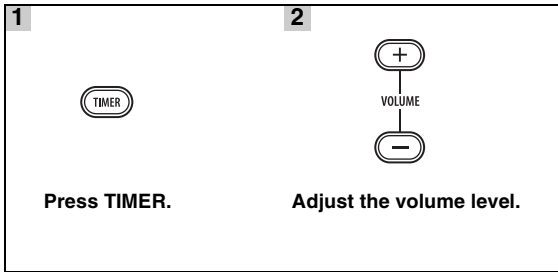

Each time you press **TIMER** while the power is on, it switches on/off. When you switch on the timer, the **TIMER** indicator lights up on the front panel display (☞ P. 6). To turn on the unit via the timer, set this unit to standby mode when the timer is switched on.

Notes

- The clock has to be set in advance.
- When the unit is in standby mode, the **TIMER** indicator does not light up on the front panel display even if the timer is on.
- After the unit is operated via the timer, the timer function switches off.



- To activate the timer function again, press **TIMER** while the power is on.
- The timer setting is saved for convenient use next time.

■ Using sleep timer

The sleep timer sets the unit to the standby mode after the specified time elapses.



The **SLEEP** indicator lights up on the front panel display (☞ P. 6).

TROUBLESHOOTING

Refer to the table below when this unit does not function properly. If the problem you are experiencing is not listed below or if the instruction below does not help, turn off this unit, disconnect the power cable, and contact the nearest authorized Yamaha dealer or service center.

General

Problem	Cause	Remedy	page
This unit fails to turn on or enters the standby mode soon after the power is turned on.	The power cable is not connected or the plug is not completely inserted.	Connect the power cable firmly.	4
	This unit has been exposed to a strong external electric shock (such as lightning or strong static electricity).	Set this unit to the standby mode, disconnect the power cable, plug it back in after 30 seconds and then use it normally.	—
The unit does not operate properly.			
No sound.	No appropriate input source has been selected.	Select an appropriate input source with INPUT on the front panel (or the source buttons on the remote control).	—
	Speaker connections are not secure.	Secure the connections.	4
	The mute function may be on.	Cancel the mute function.	6
	The volume is turned down.	Turn up the volume.	—
	Signals this unit cannot reproduce are being input from a source component, such as a CD-ROM.	Play a source whose signals can be reproduced by this unit.	3
The power is suddenly turned off.	The sleep timer may be set.	This is not malfunction. Turn on the unit and play the source again.	—
	The unit is left turned on for 1 hour without playback or any other operation being performed.		
	The power was turned on by the timer and elapsed specified running time.		
	MCR-140: The iPod selected as the input source is disconnected from the transmitter, or does not output sound for a certain period.		
The clock setting has been cleared.	The power cable has been disconnected.	Connect the power cable, and set the clock again.	—
Sound is heard from the speaker on one side only.	Incorrect cable connections.	Connect the cables properly. If the problem persists, the cables may be defective.	4
There is noise interference from digital or radio frequency equipment.	This unit is too close to the digital or high-frequency equipment.	Move this unit farther away from such equipment.	—

The following status messages appear only if you are using MCR-140.

Status message	Cause	Remedy	page
Subwoofer Link	Wireless connection between the subwoofer and the unit is established.		
SubwooferUnlink	Wireless connection between the subwoofer and the unit is disconnected.		
Wireless Error	There is a problem with the internal circuit of this unit.	Disconnect the power cable and contact the nearest authorized Yamaha dealer or service center.	—

Radio reception

Problem	Cause	Remedy	page
FM stereo reception is noisy.	The antenna is connected improperly.	Check the antenna connections.	4
	The characteristics of FM stereo broadcasts may cause this problem when the transmitter is too far away or the antenna input is poor.	Try using a high-quality directional FM antenna.	—
		Use the manual tuning method.	10
The desired station cannot be tuned into with the automatic tuning method.	The signal is too weak.	Use a high-quality directional FM antenna.	—
		Use the manual tuning method.	10
The preset selecting function does not work.	The preset (memory) may have been erased.	Preset radio stations again.	10
There is distortion, and clear reception cannot be obtained even with a good FM antenna or an outdoor antenna.	Multipath reflection or other radio interference may have occurred.	Change the height, direction, or placement of the antenna.	—

iPod™

Note

In case of a transmission error without a status message appearing in the front panel of this unit, check the connection to your iPod (see page 5).

The following status messages appear only if you are using MCR-040.

Status message	Cause	Remedy	page
iPod Connecting iPod Charging	This unit is in the middle of recognizing the connection with your iPod.	If the message continues to appear in the front panel display and playback does not start, connect the iPod again.	—
Unknown iPod	There is a problem with the signal path from your iPod to this unit.	Connect the iPod again.	5
	The iPod being used is not supported by this unit.	Only iPod (5th generation), iPod classic, iPod nano, and iPod touch are supported.	—
iPod	This unit has recognized your iPod; however, it cannot obtain information such as elapsed time.		
iPod Unplugged	Your iPod was removed from the iPod dock.	Station your iPod back in the iPod dock.	5

The following status messages appear only if you are using MCR-140.

Status message	Cause	Remedy	page
iPod Linked iPod	Wireless connection was successful.		
iPod Unlinked	Wireless connection has disconnected.	Connect the iPod to the transmitter and start playback.	5
iPod Low Batt.	The battery of the iPod is getting flat.	Set it in the charging cradle.	5

The following LED statuses of the status indicator refer to the transmitter.

LED status	Transmitter status	Remedy	page
Off	The transmitter is in standby mode. An iPod is not connected or wireless communication has not been established.		
Flashes green	Connection in progress.	Please wait.	—
Flashes green once	Adjusting the volume level or operating with the remote control.		
Lights up green	Wireless communication between the unit and transmitter is established.		
Lights up green and flashes red for 2 seconds	An unsupported iPod is connected.	Only iPod (5th generation), iPod classic, iPod nano, and iPod touch are supported.	5
Lights up green and keeps flashing red	Connection failed.	Connect again.	8
Flashes red	Error occurs.	Remove the iPod from the transmitter, and connect again.	8
Flashes red once	The volume of the unit is set to maximum or minimum.		
Flashes red 2 times continuously (regardless of green status)	The battery of the iPod is low.	Set the iPod in the charging cradle.	5

Problem	Cause	Remedy	page
No sound.	The power of the unit is off.	Connect the power cable correctly.	—
	The iPod software version has not been updated.	Download the latest iTunes software to update the iPod software version to the latest.	—
	The iPod is in the process of connecting with the unit.	Please wait for a while.	—
	MCR-140: The battery of the iPod is low.	Charge the iPod.	—
	MCR-140: The iPod is not connected to the transmitter firmly.	Connect the iPod firmly.	—
	MCR-140: Earphones are connected to the iPod.	Remove the earphones.	—
	MCR-140: The signal from the transmitter is blocked by your body or metallic objects, etc.	Change the way of holding, the orientation, or the position of the transmitter to avoid your body or metallic objects blocking the signal.	—
	MCR-140: There is a device (microwave oven, wireless LAN, cordless telephone, etc.) outputting signals in the 2.4 GHz frequency band nearby.	Place the unit away from these devices, or turn them off. If the device is IEEE802.11n-compliant, change the channel setting of the device so as not to affect the unit.	—
	MCR-140: Distance is too far.	Move the transmitter closer to the unit. Transmission range is approximately 10 m (32.8 ft). Also, placing the unit in a lower position makes it easier to receive wireless signals.	—
	MCR-140: The unit and transmitter are not connected since they are set to different groups.	Set both the unit and transmitter to the same group.	5
MCR-140: The unit is connected to another unit.	Select a different group by changing the group setting of the unit and transmitter.	5	
No sound.	MCR-040: The iPod is set in the iPod dock improperly.	Remove the iPod from the unit, then set it in the iPod dock again.	5
The iPod sounds, but you cannot operate it with the unit or the remote control.	MCR-140: The iPod is not connected to the transmitter properly.	Remove the iPod from the transmitter, then set it to the transmitter again.	5
Cannot change the volume by changing the volume of the iPod.	The iPod is not supported by this unit.	Only iPod (5th generation), iPod classic, iPod nano, and iPod touch are supported.	5
	The iPod is not connected correctly.	Connect the iPod firmly.	—
The iPod display does not change by pressing the remote control volume keys.	The iPod software version is out of date.	Update the iPod software version to the latest. If the problem cannot be solved, even with the latest software, reset the iPod.	—
The unit cannot be operated by the remote control.			
You cannot operate from the iPod.	MCR-040: The iPod is set in the iPod dock improperly.	Remove the iPod from the unit, then set it in the iPod dock again.	5
	MCR-140: The iPod is connected to the transmitter improperly.	Remove the iPod from the transmitter, and connect to the transmitter again, then start playback.	8
The playback information is not displayed on the front panel display.	The iPod you set is not compatible with the playback information display.	Only iPod (5th generation), iPod classic, iPod nano, and iPod touch are supported.	5
	You are using MCR-140.	Only MCR-040 is available for playback information display.	—
The iPod does not charge up.	MCR-040: The iPod is set in the iPod dock improperly.	Remove the iPod from the unit, then set it in the iPod dock again.	5
	MCR-140: The iPod is set in the charging cradle improperly.	Remove the iPod from the unit, then set it in the charging cradle again.	5

Problem	Cause	Remedy	page
Suddenly the speaker produces sound even though an iPod is not connected.	MCR-140: The unit is connected to another transmitter.	Change the group setting.	5
Transmitted sound is cut.	MCR-140: If noise occurs at the same frequency the transmitter is using, the unit will search and move to another (unused) frequency, which may cause sound to be cut.	This is not malfunction. If cut occurs frequently, relocate the unit.	—

USB



Note

In case of a transmission error without a status message appearing in the front panel of this unit, check the connection to the USB device (see page 5).

Status message	Cause	Remedy	page
USB Unplugged	The USB device is not connected firmly.	Connect the USB device again.	5
Unknown USB	The connected USB device is not playable on this unit.	Connect playable USB device.	5
USB OverCurrent	The connected USB device is not playable on this unit. The USB device is connected at an angle.	Disconnect the USB device. Change input source other than USB and select USB as input source again. Then connect playable USB device again.	5

Problem	Cause	Remedy	page
MP3/WMA file in the USB device does not play.	The USB device is not recognized.	Connect the USB device again.	5
		Connect an AC adapter if supplied with the device.	—
	Improper USB device connections.	Connect the USB device again.	5
	The MP3 or WMA formats are not compatible with this unit.	Replace the file with a correctly recorded file playable with this unit.	3
	If the solutions above do not resolve the problem, the USB device is not playable on the unit.	Try another USB device.	—

Disc playback

Problem	Cause	Remedy	page
No sound or distorted sound	The sampling rate of an MP3 or WMA file may not be compatible with this unit.	Check the sampling rate and bit rate of an MP3 or WMA file are compatible with this unit.	3
Disc playback does not start.	You may be using a CD-R/RW that is not finalized.	Finalize the CD-R/RW.	—
	The disc label may be upside down.	Check that the disc label is facing up.	—
	The disc may be defective.	Try playing back another disc. If this cures the problem, the disc you want to play back is defective.	—
	MP3/WMA disc may not contain sufficient music files to be played back.	Check that your MP3/WMA disc contains at least 5 MP3/WMA music files. If the number of files is small, the disc may not be recognized.	—
	The sampling rate of an MP3 or WMA file may not be compatible with this unit.	Check the sampling rate and bit rate of an MP3 or WMA file are compatible with this unit.	3
Some button operations do not work.	The disc loaded into the unit may not be compatible.	Remove the disc and then check whether the unit supports the disc or not.	3
Playback does not start immediately after pressing  on the unit or  on the remote control.	The disc may be dirty.	Wipe the disc clean.	—
	The disc loaded into the unit may not be compatible.	Use a disc supported by the unit.	3
	If the unit was moved from a cold to warm place, condensation may have formed on the disc reading lens.	Wait for an hour or two until the unit adjusts to the room temperature, and try again.	—
“No Disc” appears in the display even though a disc is in the disc tray.	The disc loaded into the unit may not be compatible.	Use a disc supported by the unit.	3
	The disc may be dirty.	Remove the disc and then wipe the disc clean.	—
	Disc is loaded upside-down.	Remove the disc and then load the disc with the labeled side facing up.	—

Remote control

Problem	Cause	Remedy	page
The remote control does not work nor function properly.	The remote control may be operated outside its operation range.	For information on the remote control operation range, refer to “Using the remote control”.	2
	The remote control sensor on this unit may be exposed to direct sunlight or lighting.	Change the lighting or orientation of this unit.	—
	The battery may be worn out.	Replace the battery with new one.	2
	There are obstacles between the sensor of this unit and the remote control.	Remove the obstacles.	—

HANDLING COMPACT DISCS

- Always handle with care so that the playing surface is not scratched. Do not bend discs.

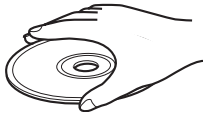

- To keep the playing surface clean, wipe with a clean, dry cloth. Do not use any type of disc cleaner, spray, or any other chemical-based liquid.
- Do not expose discs to direct sunlight, high temperature or high humidity for a long time.

- Do not wipe with a circular motion; wipe straight outward from the center.

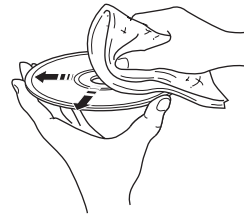

- Use a soft-tipped pen when writing on the label side of a disc.

SPECIFICATIONS

■ CD RECEIVER (CRX-040, CRX-140)

PLAYER SECTION

iPod

- Supported iPod iPod (5th generation), iPod classic, iPod nano, iPod touch

CD

- Media CD, CD-R/RW
- Audio format Audio CD, MP3, WMA

LASER

- Type Semiconductor laser GaAs/GaAlAs
- Wave length 780 nm
- Output power 10 mW

USB

- Audio format MP3, WMA

PORTABLE

- Input connector STEREO L/R: 3.5 mm STEREO mini Jack

AMPLIFIER SECTION

- Maximum output power 15 W + 15 W
(6 Ω 1 kHz, 10% THD)
- Input sensitivity
PORTABLE 450 mV/22 kΩ
- Total harmonic distortion
CD etc. 1 kHz/1W 0.05 %

TUNER SECTION

- Tuning range
[U.S.A. and Canada models] 87.5 to 107.9 MHz
[Other models] 87.50 to 108.00 MHz

GENERAL

- Power supply
[Europe model] AC 230 V, 50 Hz
[U.S.A. and Canada models] AC 120 V, 60 Hz
[Asia model] AC 220/230-240 V, 50/60 Hz
[Taiwan model] AC 110/120 V, 60 Hz
[Australia model] AC 240 V, 50 Hz
[U.K. model] AC 230 V, 50 Hz
[China model] AC 220 V, 50 Hz
[Korea model] AC 220 V, 60 Hz
- Power consumption 25 W

- Standby power consumption

MCR-040 0.5 W or less
MCR-140

POWER SAVING: ECO 1.0 W or less
POWER SAVING: NORMAL (default setting)

..... 2.0 W or less

- Dimensions (W × H × D) 180 × 120 × 309 mm
(7 1/8 × 4 3/4 × 12 1/8 in)
- Weight 3.6 kg (7.9 lbs.)

■ SPEAKER (NS-BP80)

- Driver unit 10 cm (4 in) full-range Cone type
/Non Magnetic Shielding Type
- Dimensions (W × H × D) 122 × 118 × 287 mm
(4 3/4 × 4 5/8 × 11 1/4 in)
- Weight 1.4 kg (3.1 lbs.)

■ TRANSMITTER (YIT-W11TX)

- Frequency 2.4 GHz
- Transmission range Approx. 10 m (32.8 ft)
(without interference)
- Number of units which can be simultaneously transmitted to
..... Up to 7 units (depending on the circumstances)

Specifications are subject to change without notice.

iPod™

iPod is a trademark of Apple Inc., registered in the U.S. and other countries.

“Made for iPod” means that an electronic accessory has been designed to connect specifically to iPod and has been certified by the developer to meet Apple performance standards.

Apple is not responsible for the operation of this device or its compliance with safety and regulatory standards.

CAUTION

Use of controls or adjustments or performance of procedures other than those specified herein may result in hazardous radiation exposure.

AVERTISSEMENT

L'utilisation de commandes et l'emploi de réglages ou de méthodes autres que ceux décrits ci-dessous, peuvent entraîner une exposition à un rayonnement dangereux.

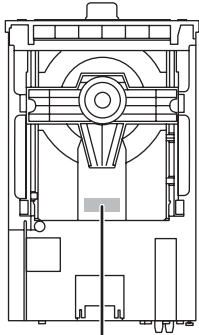

DANGER: AVOID DIRECT EXPOSURE TO THE BEAM
INVISIBLE LASER RADIATION WHEN OPEN

CAUTION: DO NOT STARE INTO BEAM
INVISIBLE LASER RADIATION WHEN OPEN

(Traduction française)

DANGER : ÉVITER UNE EXPOSITION DIRECTE AU
RAYON
RADIATION LASER INVISIBLE QUAND
L'APPAREIL EST OUVERT

ATTENTION : NE PAS REGARDER FIXEMENT LE
FAISCEAU
RADIATION LASER INVISIBLE QUAND
L'APPAREIL EST OUVERT

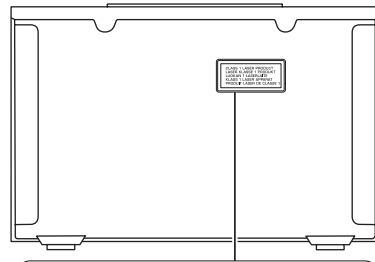

- The label is located on the bottom of the unit. (U.S.A and Canada models only)
- L'étiquette est situé sur la base de l'unité (États-Unis et le Canada modèles seulement).

